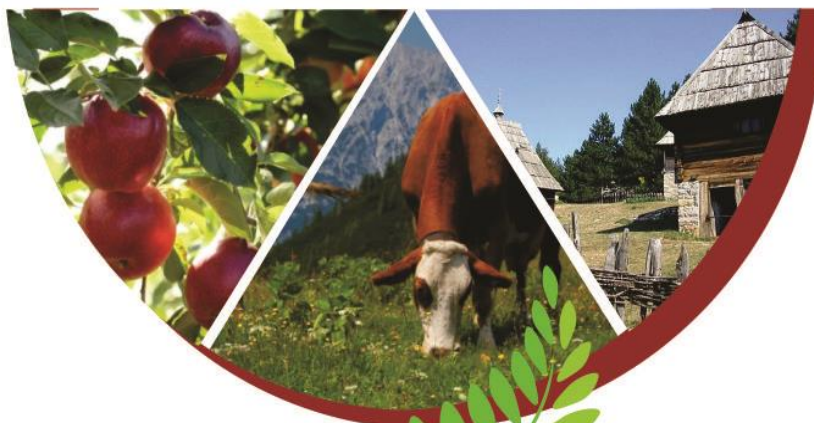


# BOOK OF PROCEEDINGS

AgroSym

*VIII International Scientific Agriculture Symposium  
Jahorina, October 05-08, 2017*



AGRO 2017  
sym

# **BOOK OF PROCEEDINGS**

**VIII International Scientific Agriculture Symposium  
“AGROSYM 2017”**

**AGROSYM 2017**



**Jahorina, October 05 - 08, 2017**

## Impressum

VIII International Scientific Agriculture Symposium „AGROSYM 2017“

### Book of Proceedings Published by

University of East Sarajevo, Faculty of Agriculture, Republic of Srpska, Bosnia  
University of Belgrade, Faculty of Agriculture, Serbia  
Mediterranean Agronomic Institute of Bari (CIHEAM - IAMB) Italy  
International Society of Environment and Rural Development, Japan  
Regional Rural Development Standing Working Group (SWG) in Southeastern Europe, Macedonia  
Balkan Environmental Association (B.EN.A), Greece  
University of Applied Sciences Osnabrück, Germany  
Perm State Agricultural Academy, Russia  
Voronezh State Agricultural University named after Peter The Great, Russia  
Centre for Development Research, University of Natural Resources and Life Sciences (BOKU), Austria  
Selçuk University, Turkey  
University of Agronomic Sciences and Veterinary Medicine of Bucharest, Romania  
University of Valencia, Spain  
Faculty of Agriculture, Cairo University, Egypt  
Tarbiat Modares University, Iran  
Higher Institute of Agronomy, Chott Mariem-Sousse, Tunisia  
Faculty of Economics Brcko, University of East Sarajevo, Bosnia and Herzegovina  
Biotechnical Faculty, University of Montenegro, Montenegro  
Institute of Field and Vegetable Crops, Serbia  
Institute of Lowland Forestry and Environment, Serbia  
Institute for Science Application in Agriculture, Serbia  
Agricultural Institute of Republic of Srpska - Banja Luka, Bosnia and Herzegovina  
Maize Research Institute “Zemun Polje”, Serbia  
Faculty of Agriculture, University of Novi Sad, Serbia  
Institute for Animal Science, Ss. Cyril and Methodius University in Skopje, Macedonia  
Academy of Engineering Sciences of Serbia, Serbia  
Balkan Scientific Association of Agricultural Economics, Serbia  
Institute of Agricultural Economics, Serbia

### Editor in Chief

Dusan Kovacevic

### Technical editors

Sinisa Berjan

Milan Jugovic

Noureddin Driouech

Rosanna Quagliariello

### Website:

<http://www.agrosym.rs.ba>

CIP - Каталогизacija у публикацији  
Народна и универзитетска библиотека  
Републике Српске, Бања Лука

631(082)

INTERNATIONAL Scientific Agricultural Symposium "Agrosym  
2017" (8 ; Jahorina)

Book of Proceedings [Elektronski izvor] / VIII International  
Scientific Agriculture Symposium "Agrosym 2017", Jahorina,  
October 05 - 08, 2017 ; [editor in chief Dušan Kovačević]. - East  
Sarajevo =Istočno Sarajevo : Faculty of Agriculture =Poljoprivredni  
fakultet, 2017

Način pristupa (URL):

[http://www.agrosym.rs.ba/index.php/en/agrosym/agrosym\\_2017/  
BOOK\\_OF\\_PROCEEDINGS\\_2017\\_FINAL.pdf](http://www.agrosym.rs.ba/index.php/en/agrosym/agrosym_2017/BOOK_OF_PROCEEDINGS_2017_FINAL.pdf). - Bibliografija uz  
radove. - Registar.

ISBN 978-99976-718-1-3

COBISS.RS-ID 6954776

**VIII International Scientific Agricultural Symposium “Agrosym 2017”  
Jahorina, October 05-08, 2017, Bosnia and Herzegovina**

**HONORARY COMMITTEE**

STEVO MIRJANIC, Minister of Agriculture, Water Management and Forestry of Republic of Srpska, Bosnia, JASMIN KOMIC, Minister of Science and Technology of Republic of Srpska, Bosnia, DANE MALESEVIC, Minister of Education and Culture of Republic of Srpska, Bosnia, RADOSLAV GRUJIC, Rector of the University of East Sarajevo, Bosnia, MILICA PETROVIC, Dean of the Faculty of Agriculture, University of Belgrade, Serbia, MAURIZIO RAELLI, Director of the Mediterranean Agronomic Institute of Bari, Italy, MARIO T. TABUCANON, President of the International Society of Environment and Rural Development, Japan, FOKIAON K. VOSNIAKOS, President of the Balkan Environmental Association (B.EN.A), Greece, BERND LEHMANN, Vice-President of the University of Applied Sciences Osnabruck, Germany, MUSTAFA ŞAHIN, Rector of the Selcuk University, Turkey , IURII ZUBAREV, Rector of the Perm State Agricultural Academy, Russia, NIKOLAY I. BUKHTOYAROV, Rector of the Voronezh State Agricultural University named after Peter The Great, Russia, HANY EL-SHEMY, Dean of the Faculty of Agriculture, Cairo University, Egypt , SORIN MIHAI CIMPEANU, Rector of the University of Agronomic Sciences and Veterinary Medicine of Bucharest, Romania , MIOMIR JOVANOVIĆ, Dean of the Biotechnical Faculty, University of Podgorica, Montenegro, SNEZANA JANKOVIC, Director of the Institute for Science Application in Agriculture, Serbia, SASA ORLOVIC, Director of the Institute of Lowland Forestry and Environment, Serbia, BRANKO KOVACEVIC, President of the Academy of Engineering Sciences of Serbia, Serbia, VOJISLAV TRKULJA, Director of Agricultural Institute of Republic of Srpska - Banja Luka, Bosnia and Herzegovina, BRANKA KRESOVIC, Director of the Maize Research Institute “Zemun Polje”, Serbia, JAN TURAN, Director of the Institute of Field and Vegetable Crops, Serbia, NEDELJKO TICA, Dean of the Faculty of Agriculture, University of Novi Sad, Serbia, RODNE NASTOVA, Director of the Institute for Animal Science, Skoplje, Macedonia, MOHSEN BOUBAKER, General Director of High Institute of Agronomy of Chott Meriem, Sousse, Tunisia, RADOVAN PEJANOVIĆ, President of Balkan Scientific Association of Agricultural Economics, Serbia, JONEL SUBIC, Director of the Institute of Agricultural Economics, Serbia

**SCIENTIFIC COMMITTEE**

DUSAN DUSAN KOVACEVIC, Faculty of Agriculture, University of Belgrade, Serbia, WILLIAM MEYERS, Howard Cowden Professor of Agricultural and Applied Economics, University of Missouri, USA, JOHN BRAYDEN, Norwegian Agricultural Economics Research Institute (NILF), Norway, STEVE QUARIE, Visiting Professor, School of Biology, Newcastle University, United Kingdom, ANDREAS MELCHER, CDR, University of Natural Resources and Life Sciences (BOKU), Vienna, Austria, ATEF HAMDY, Emeritus Professor, Land and Water Resources Department; IAMB, Italy, DANI SHTIENBERG, full professor, Department of Plant pathology and Weed Research, ARO, the Volcani Center, Bet Dagan, Israel, THOMAS G. JOHNSON, University of Missouri – Columbia, USA, DIETER TRAUTZ, University of Applied Science, Germany, MACHITO MIHARA, Tokyo University of Agriculture, Japan, MARKUS SCHERMER, Department of Sociology, University of Innsbruck, Austria, JORGE BATLLE-SALES, Department of Biology, University of Valencia, Spain , SERGEI ELISEEV, Vice-Rector for Research and Innovations, Perm State Agricultural Academy, Russia, RICHARD BARICHELLO, Faculty of Land and Food Systems, University of British Columbia, Canada, NOVO PRZULJ, Faculty of Agriculture, University of Banjaluka, Bosnia and Herzegovina, TATIANA SIVKOVA, Faculty for Veterinarian Medicine and Zootechny, Perm State Agricultural Academy, Russia, ADRIANO CIANI, Department of Agricultural, Foods and Environmental Sciences, Perugia University, Italy, ALEKSEJ LUKIN, Voronezh State Agricultural University named after Peter The Great, Russia, MATTEO VITTUARI, Faculty of Agriculture, University of Bologna, Italy, SEYED MOHSEN HOSSEINI, Faculty of Natural Resources, Tarbiat Modares University, Iran, ARDIAN MACI, Faculty of Agriculture and Environment, Agricultural University of Tirana, Albania, REGUCIVILLA A. POBAR, Bohol Island State University, Philippines, SUDHEER KUNDUKULANGARA PULISSERY, Kerala Agricultural University, India, EPN UDAYAKUMARA, Faculty of Applied Sciences, Sabaragamuwa University, Sri Lanka, VLADIMIR SMUTNÝ, full professor, Mendel University, Faculty of agronomy, Czech Republic, FRANC BAVEC, full professor, Faculty of Agriculture and Life Sciences, Maribor, Slovenia, JAN MOUDRÝ, full professor, Faculty of Agriculture, South Bohemia University, Czech Republic, STEFAN TYR, full professor, Faculty of Agro-biology and Food Resources, Slovakia, NATALIJA BOGDANOV, Faculty of Agriculture, University of Belgrade, Serbia, SABAHUDIN BAJRAMOVIC, Faculty of Agriculture and Food Sciences, University of Sarajevo, Bosnia, FRANCESCO PORCELLI, University of Bari Aldo Moro, Italy , VASILIJE ISAJEV, Faculty of Forestry, University of Belgrade, Serbia, ELAZAR FALLIK, Agricultural Research Organization (ARO), Volcani, Israel, JUNAID ALAM MEMON, Pakistan Institute of Development Economics, Pakistan, HIROMU OKAZAWA, Faculty of Regional Environment Science, Tokyo University of Agriculture, Japan, PANDI ZDRULI, Land and Water Resources Department; IAMB, Italy, MLADEN TODOROVIC, Land and Water Resources Department; IAMB, Italy, HAMID EL BILALI, CDR, University of Natural Resources and Life Sciences (BOKU), Vienna, Austria , LORENZ PROBST, CDR, University of Natural Resources and Life Sciences (BOKU), Vienna, Austria, MOHSEN BOUBAKER, High Institute of Agronomy of Chott Meriem, Sousse, Tunisia, NOUREDDIN DRIOUECH, Coordinator of MAIB Alumni Network (FTN),

Mediterranean Agronomic Institute of Bari, Italy, ION VIOREL, University of Agronomic Sciences and Veterinary Medicine of Bucharest, Romania, HAMADA ABDELRAHMAN, Soil Science Dept., Faculty of Agriculture, Cairo University, Egypt, LALITA SIRIWATTANANON, Faculty of Agricultural Technology, Rajamangala University of Technology Thanyaburi (RMUTT), Thailand, ABID HUSSAIN, International Centre for Integrated Mountain Development (ICIMOD), Nepal, AMRITA GHATAK, Gujarat Institute of Development Research (GIDR), India, NASER SABAGHNI, University of Maragheh, Iran, MONICA PAULA MARIN, Department for Animal Husbandry, University of Agronomic Sciences and Veterinary Medicine of Bucharest, Romania, MOSTAFA K. NASSAR, Animal husbandry Dept., Faculty of Agriculture, Cairo University, Egypt, MÁRTA BIRKÁS, full professor, St. Istvan University, Godollo - Hungary, UDAI PRATAP SINGH, Department of Mycology and Plant Pathology, Banaras Hindu University, India, ANDRZEJ KOWALSKI, Director of the Institute for Agricultural and Food Economy, Warszawa-Poland, YALCIN KAYA, The Director of the Plant Breeding Research Center, University of Trakya, Turkey, SANJA RADONJIC, Biotechnical Faculty, University of Montenegro, Montenegro, IONELA DOBRIN, Department for Plant Protection, University of Agronomic Sciences and Veterinary Medicine of Bucharest, Romania, INOCENCIO BUOT JR., Institute of Biological Sciences, College of Arts and Sciences, University of the Philippines Los Banos, Philippines, MOHAMMAD AL-MAMUN, Department of Animal Nutrition, Bangladesh Agricultural University, Bangladesh, ANUCHA WITTAYAKORN-PURIPUNPINYOO, School of Agriculture and Cooperatives, Sukhothai Thammathirat Open University, Nonthaburi, Thailand, NEDELJKA NIKOLOVA, Institute for Animal Science, Ss. Cyril and Methodius University in Skopje, Republic of Macedonia, IGNACIO J. DÍAZ-MAROTO, High School Polytechnic, University of Santiago de Compostela, Spain, MOHAMMADREZA ALIZADEH, Rice Research Institute of Iran, Agricultural Research, Education and Extension Organization (AREEO), Rasht, Iran, CAFER TOPALOGLU, Faculty of Tourism, Mugla Sitki Kocman University, Turkey, SEYED HAMIDREZA SADEGH, Faculty of Natural Resources, Tarbiat Modares University, Iran, NOUREDDINE DJEBLI, Department of Biology, Faculty of Natural Sciences and Life, Mostaganem University, Algeria, TUGAY AYASAN, East Mediterranean Agricultural Research Institute, Adana, Turkey, SHEREIN SAEIDE ABDELGAYED, Faculty of Veterinary Medicine, Cairo University, Cairo, Egypt, ZELJKO VASKO, Faculty of Agriculture, University of Banja Luka, Bosnia and Herzegovina, KUBILAY BAŞTAŞ, Department of Plant Protection, Faculty of Agriculture, Selçuk University, Turkey, VJEKOSLAV TANASKOVIC, Ss. Cyril and Methodius University in Skopje, Faculty of Agricultural Sciences and Food, Republic of Macedonia, EMNA ABDELLATIF EP. MEDDEB, National Agricultural Institute, Tunisia, BRANKA KRESOVIC, Director of the Maize Research Institute “Zemun Polje”, Serbia, KOSANA KONSTATINOV, Academy of Engineering Sciences of Serbia, Serbia, SNEZANA MLADENOVIC-DRINIC, Maize Research Institute “Zemun Polje”, Serbia, NEBOJSA MOMIROVIC, Faculty of Agriculture, University of Belgrade, Serbia, ZORAN JOVOVIC, Biotechnical Faculty, University of Montenegro, Montenegro, VLADIMIR VUKADINOVIĆ, full professor, Faculty of Agriculture, University of Osijek, Croatia, DANIJEL JUG, associate professor, Faculty of Agriculture, University of Osijek, Croatia, VLADO KOVACEVIC, full professor, Faculty of Agriculture, University of Osijek, Croatia, MILAN MARKOVIC, Biotechnical Faculty, University of Montenegro, Montenegro, ZELJKO DOLIJANOVIC, Faculty of Agriculture, University of Belgrade, Serbia, DOBRIVOJ POŠTIĆ, Institute for plant protection and environment, Belgrade, Serbia

#### **ORGANIZATION COMMITTEE**

VESNA MILIC, Dean of the Faculty of Agriculture, University of East Sarajevo, Bosnia, DEJAN BOKONJIC, Vice rector of the University of East Sarajevo, Bosnia, SLAVISA MOLJEVIC, Vice rector of the University of East Sarajevo, Bosnia, ROBERTO CAPONE, Mediterranean Agronomic Institute of Bari, Italy, ROSANNA QUAGLIARIELLO, Mediterranean Agronomic Institute of Bari, Italy, NOUREDDIN DRIOUECH, Coordinator of MAIB Alumni Network (FTN), Mediterranean Agronomic Institute of Bari, Italy, ALEKSANDRA DESPOTOVIC, Biotechnical Faculty Podgorica, University of Montenegro, Montenegro, MILIC CUROVIC, The journal “Agriculture and Forestry”, Biotechnical Faculty Podgorica, University of Montenegro, Montenegro, SANJA VASILJEVIC, Institute of Field and Vegetable Crops, Serbia, OKSANA FOTINA, International Relations Center, Perm State Agricultural Academy, Russia, TATIANA LYSAK, International Relations Office, Voronezh State Agricultural University named after Peter The Great, Russia, MEHMET MUSA OZCAN, Faculty of Agriculture, Selçuk University, Turkey, NIKOLA PACINOVSKI, Institute for Animal Science, Ss. Cyril and Methodius University in Skopje, Republic of Macedonia, ABDULVAHED KHALEDI DARVISHAN, Faculty of Natural Resources, Tarbiat Modares University, Iran, HAMADA ABDELRAHMAN, Soil Science Dept., Faculty of Agriculture, Cairo University, Egypt, ECATERINA STEFAN, University of Agronomic Sciences and Veterinary Medicine of Bucharest, Romania, JEERANUCH SAKKHAMDUANG, The International Society of Environmental and Rural Development, Japan, RAOUDHA KHANFIR BEN JENANA, High Institute of Agronomy of Chott Meriem, Sousse, Tunisia, VEDRAN TOMIC, Institute for Science Application in Agriculture, Serbia, MILAN STEVANOVIC, Maize Research Institute “Zemun Polje”, Serbia, ANDREJ PILIPOVIC, Institute of Lowland Forestry and Environment, Serbia, MORTEZA BEHZADFAR, Tarbiat Modares University, Tehran, Iran, ULRIKE SCHLIEPHAKE, Dipl. agr.oec., University of Applied Science, Germany, BRANISLAVKA JANJIC, Agricultural Institute of Republic of Srpska - Banja Luka, Bosnia, BILJANA GRUJIC, Institute of Agriculture Economics, Serbia, MERSIDA JANDRIC, Faculty of

Agriculture, University of Belgrade, Serbia, GORAN PERKOVIC, Faculty of Agriculture, University of East Sarajevo, Bosnia, DEJANA TESANOVIC, Faculty of Agriculture, University of East Sarajevo, Bosnia, MARKO GUTALJ, Faculty of Agriculture, University of East Sarajevo, Bosnia, MILAN JUGOVIC, Faculty of Agriculture, University of East Sarajevo, Bosnia, IGOR DJURDJIC, Faculty of Agriculture, University of East Sarajevo, Bosnia, MILENA STANKOVIC NEDJIC, Faculty of Agriculture, University of East Sarajevo, Bosnia, STEFAN STJEPANOVIC, Faculty of Agriculture, University of East Sarajevo, Bosnia, STEFAN BOJIC, Faculty of Agriculture, University of East Sarajevo, Bosnia, TANJA JAKSIC, Faculty of Agriculture, University of East Sarajevo, Bosnia, TIJANA BANJANIN, Faculty of Agriculture, University of East Sarajevo, Bosnia, SINISA BERJAN, Faculty of Agriculture, University of East Sarajevo, Bosnia, General secretary

## FOREWORD

### A Word from the Editor

The successful implementation of the 2030 Agenda for Sustainable Development and the achievement of the Sustainable Development Goals depend on progress in agriculture. Agriculture has far-reaching implications in terms of poverty eradication, food security, health and wellbeing, biodiversity, climate change and economic development.

The most important goal of the 8<sup>th</sup> International Agriculture Symposium “AGROSYM 2017” – held in Jahorina on 05-08 October, 2017 – was to promote sustainability principles in agriculture. Sustainable agriculture is an important element of the overall effort to make human activities compatible with the demands of the earth's eco-system. Thus, an understanding of the different approaches to ecological agriculture is necessary if we want to utilize wisely the planet's resources. One of the goals of the sustainable agriculture movement is to create farming systems that eliminate, or at least mitigate, environmental harms associated with industrial agriculture. That aim can be realized only with context-specific agro-ecological practices; these depend on regional characteristics, climate conditions, soil types as well as socio-cultural, institutional and political settings.

AGROSYM 2017 made an important contribution to agriculture science and practice. Symposium themes cover all branches of agriculture and are divided into seven sessions: 1) Plant production, 2) Plant protection and food safety, 3) Organic agriculture, 4) Environment protection and natural resources management, 5) Animal husbandry, 6) Rural development and agro-economy, and 7) Forestry and agro-forestry.

During the four-day Symposium approximately 250 papers were presented orally and 1030 as posters. The contributions, representing the current research in different countries, were presented to more than 1300 participants from more than 85 countries. We are encouraged by the great success of this year's edition of AGROSYM 2017.

This publication is comprised of an edited selection of over 400 papers submitted to AGROSYM 2017. Each paper included in the present Proceedings was positively reviewed by two referees. Full texts of the submitted communications are also available online (<http://www.agrosym.rs.ba>). Some selected papers will be published in AGROFOR International Journal (<http://www.agrofor.rs.ba/>), International Journal "Agriculture and Forestry" ([www.agricultforest.ac.me](http://www.agricultforest.ac.me)) and EcoPersia ([www.ecopersia.modares.ac.ir](http://www.ecopersia.modares.ac.ir)). Many thanks to all the authors, reviewers, session moderators and colleagues for their help in editing the Proceedings. The results reported here will contribute to the dissemination of knowledge to the wider audience about the importance of agri-food science; one of the most important areas of research strategies in Europe and beyond.

AGROSYM 2017 was made possible through the commitment and contributions of a wide range of partners and sponsors. I take this opportunity to thank all of them and I look forward to a successful joint organization of AGROSYM 2018.

East Sarajevo, 23<sup>rd</sup> October 2017



Prof. Dušan Kovačević, PhD  
Editor in Chief

CONTENT

<b>1. PLANT PRODUCTION .....</b>	<b>44</b>
THE EFFECT OF CUTTING ON GRAIN AND FORAGE YIELD OF TWO OATS SPECIES IN LOWLAND OF ALBANIA Isuf KAZIU, Foto KASHTA, Asllan CELAMI, Alban IBRALIU, Ilir MEHMETI .....	45
<b>CLIMATIC CONDITIONS, YIELDS AND PLANT PRODUCTION IN ALGERIA</b> Amel BOUZID .....	51
<b>ECONOMIC ANALYSIS OF THE MULCH USAGE IN THE PRODUCTION OF WINTER LETTUCE</b> Aleksandra GOVEDARICA-LUČIĆ, Alma RAHIMIĆ, Goran PERKOVIĆ, Grujica VICO .....	57
<b>TWIN ROW TECHNOLOGY MAIZE SOWING</b> Dragan JURKOVIĆ, Nikolina KAJIĆ, Anamarija BANAJ, Vjekoslav TADIĆ, Đuro BANAJ, Jurica JOVIĆ .....	62
<b>MAIZE RESPONSE TO LIMING AND PHOSPHORUS FERTILIZATION IN LIJEVCE POLJE REGION OF BOSNIA AND HERZEGOVINA</b> Ilija KOMLJENOVIC, Vlado KOVACEVIC, Mihajlo MARKOVIC, Goran DJURASINOVIC, Vojo RADIC .....	67
<b>GERMINATION CHARACTERS AND EARLY SEEDLING GROWTH OF WHEAT (<i>Triticum aestivum</i> L.) VARIETIES UNDER SALT STRESS CONDITIONS</b> Mirjana JOVOVIĆ, Vesna TUNGUZ, Milan MIROSAVLJEVIĆ, Novo PRŽULJ .....	73
<b>MAINSTEM LEAF DEVELOPMENT IN SPRING BARLEY</b> Novo PRŽULJ, Vojislava MOMČILOVIĆ, Milan MIROSAVLJEVIĆ, Zoran JOVOVIĆ, Dragan MANDIĆ, Miloš NOŽINIĆ .....	79
<b>PHENOLOGICAL AND POMOLOGICAL ANALYSIS OF FRUIT AUTOCHTHONOUS VARIETY OF SWEET CHERRY (<i>Prunus avium</i> L.) CV. “ALICA” IN MOSTAR AREA (BOSNIA AND HERZEGOVINA)</b> Semina HADŽIABULIĆ, Jasna HASANBEGOVIĆ, Jasmina ALIMAN, Edin RAMIĆ, Ahmed DŽUBUR, Armin MUSTAFIĆ .....	86
<b>IMPACT OF HERBICIDE ADENGO ON MICROBIAL DIVERSITY OF SOIL UNDER CORN</b> Saud HAMIDOVIĆ, Blažo LALEVIĆ, Vedrana KOMLEN, Milan PEŠIĆ, Vera RAIČEVIĆ, Hadi WAISI, Amer SUNULAHPAŠIĆ .....	92
<b>MICROBIOLOGICAL PROPERTIES OF SOIL UNDER CORN AFTER APPLICATION OF HERBICIDE LUMAX</b> Saud HAMIDOVIĆ, Amer SUNULAHPAŠIĆ, Blažo LALEVIĆ, Vera RAIČEVIĆ, Milan PEŠIĆ, Hadi WAISI, Vedrana KOMLEN .....	99
<b>THE EFFECT OF MINERAL TOP – DRRESING ON THE YIELD AND PROTEINS CONTENT IN SOME FODDER PEA VARIETIES</b> Igor ĐURĐIĆ, Tanja JAKIŠIĆ, Vesna MILIĆ, Branka GOVEDARICA, Milan JUGOVIĆ, Marija SPASIC .....	105



**EFFECTS OF WEATHER CONDITIONS IN BOSNIA AND HERZEGOVINA FROM 2011 TO 2015 GROWING SEASONS REGARDING MAIZE GROWTH AND CLIMATIC CHANGE**

Vojo RADIC, Vlado KOVACEVIC, Ilija KOMLJENOVIC, Meho MAJDANCIC, Aleksandra FIGUREK ..... 111

**INHERITANCE OF productivity IN F1 COTTON DIALLEL CROSSES (*Gossypium HIRSUTUM* L.)**

Valentina DIMITROVA, Ana STOILOVA, Minka KOLEVA ..... 118

**STUDY ON RESISTANCE TO ABIOTIC AND BIOTIC STRESS FACTORS IN INTRODUCED SWEET CHERRY CULTIVARS FROM KYUSTENDIL REGION OF BULGARIA**

Simeon KRUMOV, Aneliya BORISOVA, Nicolay CHRISTOV, Zhao LINGLING, Tang MEILING ..... 124

**EVALUATION OF SPRING FROST TOLERANCE AND VIRUS STATUS OF SOME APPLE CULTIVARS AND HYBRIDS IN BULGARIA**

Stanislava DIMITROVA, Aneliya BORISOVA ..... 130

**INFLUENCE OF GRASS ESTABLISHMENT WITH SOME LEGUME SPECIES ON THE BIOCHEMICAL COMPOSITION OF 'BLACK SATIN' BLACKBERRY FRUITS**

Diyana GEORGIEV, Teodora MIHOVA, Maria GEORGIEVA, Petya IVANOVA, Georgi POPSKI, Galya NAYDENOVA, Dimitar MITEV ..... 136

**COMPARATIVE INVESTIGATION OF THREE CHERRY CULTIVARS WITH DIFFERENT STEM HEIGHTS**

Denica D. SERBEZOVA, Iliyana S. KRISHKOVA ..... 141

**EFFECTIVENESS OF TWO TYPES OF CROWN PRUNING OF SOUR CHERRY CULTIVAR ERDI BÖTERMÖ**

Iliyana KRISHKOVA , Denica SERBEZOVA ..... 148

**CORRELATION AND PATH-COEFFICIENT INTERACTION BETWEEN YIELD PARAMETERS AND CROP MANAGEMENT OF PEAS**

Nidal SHABAN, Kadhu EMAN, Todorka MOKREVA, Zeina EL SEBAALY ..... 155

**BRIEF POMOLOGICAL DESCRIPTION OF PERSPECTIVE SWEET CHERRY ELITES (*PRUNUS AVIUM* L.)**

Nicolai CHRISTOV, Simeon KRUMOV ..... 164

**ALLELOPATHIC EFFECT OF SOME WEED SPECIES ON GERMINATION AND INITIAL DEVELOPMENT OF *LACTUCA SATIVA***

Ekaterina VALCHEVA, Vladislav POPOV, Plamen MARINOV-SERAFIMOV, Irena GOLUBINOVA, Bogdan NIKOLOV, Iliana VELCHEVA, Slaveya PETROVA ..... 170

**INFLUENCE OF FOLIAR ANTIBROADLEAVED HERBICIDES ON LENGTH OF THE PRIMARY ROOT OF COTTON SEEDS (*GOSSYPIUM HIRSUTUM* L.)**

Teodora BARAKOVA, Grozi DELCHEV, Neli VALKOVA ..... 176

<b>INFLUENCE OF SOME HERBICIDES AND THEIR MIXTURES WITH GROWTH REGULATOR AND FOLIAR FERTILIZER ON COTTON SEED GERMINATION (<i>GOSSYPIUM HIRSUTUM</i> L.)</b>	
Teodora BARAKOVA, Grozi DELCHEV, Neli VALKOVA .....	182
<b>INFLUENCE OF ENVIRONMENT ON YIELD STRUCTURE CHARACTERISTICS AND GRAIN YIELD OF PEAS GROWN IN SOUTH-CENTRAL BULGARIA</b>	
Tsenka ZHELIAZKOVA, Dimitar PAVLOV, Mariya GERDZHIKOVA .....	188
<b>STUDY ON VARIATION AND ASSOCIATION OF GRAIN QUALITY TRAITS IN DURUM WHEAT GENOTYPES</b>	
Krasimira TANEVA, Violeta BOZHANOVA, Ivanka PETROVA .....	196
<b>BEAN (<i>PHASEOLUS VULGARIS</i> L.) GERMINATION AND SEEDLING GROWTH AS AFFECTED BY SILVER NANOPARTICLES</b>	
Amal Z. HEGAZI, Fatma A. GHARIB, Safia M. GHAZI, Asmaa G. ABD EL HAFZ Ahmed I. EL-BATAL .....	205
<b>RESPONSE OF WHEAT GROWTH ANALYSIS AND NITROGEN USE EFFICIENCY TO NITROGEN LEVELS AND SEEDING RATES</b>	
El-Sayed GHEITH, El-Metwally EL-METWALLY, Ramadan SHEMI .....	214
<b>EFFECT OF DODDER WEED (<i>Cuscuta epilinum</i> L.) CONTROL ON STRAW, SEED AND FIBER YIELDS OF THREE VARIETIES OF FLAX "<i>Linum usitatissimum</i> L."</b>	
Ramadan EL-REFAEY; Emadeldeen RASHWAN, Ehab RAMADAN .....	221
<b>EFFECT OF SOME MICROELEMENTS AND GROWTH SUBSTANCES ON YIELD, YIELD COMPONENTS AND CHEMICAL COMPOSITION TRAITS IN SOME FABA BEAN CULTIVARS</b>	
EL-Refaey, Ramadan Aly; Usama Abd El Hameid Abdel-Razek, Adel Mohamed EL-Garhy, Mohamed Karam Sayed Ahmed .....	232
<b>EFFECT OF CLIMATE ON SOIL ORGANIC MATTER IN FARMING SYSTEMS IN FOUR REGIONS OF GERMANY</b>	
Lucie CHMELÍKOVÁ, Harald SCHMID, Kurt-Jürgen HÜLSBERGEN.....	240
<b>ROOT DISTRIBUTION OF SUGAR BEET AND WINTER CEREALS ON DIFFERENT SOILS</b>	
Lucie CHMELÍKOVÁ, Harald SCHMID, Sebastian WOLFRUM, Kurt-Jürgen HÜLSBERGEN .....	246
<b>STUDY OF THE PERFORMANCE OF BREAD WHEAT CULTIVARS CARRYING THE 1BL.1RS WHEAT-RYE CHROMOSOMAL TRANSLOCATION WITH PHYSIOLOGICAL CRITERIA</b>	
Chryssanthi I. PANKOU, Fokion PAPATHANASIOU, Theano B. LAZARIDOU, Ioannis N. XYNIAS .....	251
<b>HOW COULD BE AFFECTED SEED GERMINATION RATES OF WINTER CEREALS</b>	
Kyriakos D. GIANNOULIS, Elpiniki SKOUFOGIANNI, Dimitrios BARTZIALIS, Konstantina ADRASKELA, Nicholas G. DANALATOS .....	256

<b>THE EFFECT OF DIFERENT FERTILIZATION SCENARIOS ON PRODUCTIVITY OF WHEAT AND BARLEY</b>	
Dimitrios BARTZIALIS, Kyriakos D. GIANNOULIS, Elpiniki SKOUFOGIANNI, Sophia DAMPLIA, Konstantinos TSAKIRIDIS, Efsthios PAVLAKOS, Nicholas G. DANALATOS .....	263
<b>THE EFFECT OF NUTRIENT SOLUTION COMPOSITION ON DEVELOPMENT OF <i>Cichorium spinosum</i> PLANTS</b>	
Panagiota KOLOVOU, Vasilios ANTONIADIS, Anestis KARKANIS, Isabel C.F.R. FERREIRA, Spyridon PETROPOULOS .....	270
<b>IN-VITRO SCREENING OF DURUM AND BREAD WHEAT GENOTYPES FOR DROUGHT RESISTANCE USING POLYETHYLENE GLYCOL</b>	
Theano B. LAZARIDOU, Ioannis N. XYNIAS .....	276
<b>COMPARING THE YIELD OF PULSES USING DIFFERENT INTEGRATED CROP MANAGEMENT STRATEGIES: A CASE STUDY IN INDIA</b>	
Suresh K. MUDDA, Chitti B. GIDDI .....	282
<b>ACCURATION TEST OF “PINANGGAL DWASA AYU” METHOD TO DETERMINE CROP ROTATION IN BALI PROVINCE (INDONESIA)</b>	
Raden Mas BHISMO SRENGGORO KUNTONUGROHO, Putu Giana EKA SUARDI, Abdurrahman Muhammad FIKRI RASDI .....	289
<b>EFFECTS OF SEED PRIMING WITH GIBBERELIC AND SALICYLIC ACIDS AND MYCORRHIZAL INOCULATION ON YIELD AND YIELD COMPONENTS OF LENTIL (<i>Lens culinaris</i> L.)</b>	
Abbas BIABANI, Mohsen AZARNIA, Hamid Reza EISVAND, Ebrahim Gholamalipour ALAMDARI, Latif GHOLIZADEH .....	294
<b>DIRECT REGENERATION POTENTIAL OF GUS TRANSFORMED ROSE (<i>ROSA HYBRIDA</i> L.)</b>	
Fataneh YARI .....	301
<b>EFFECT OF PLANT GROWTH REGULATORS AND PLANTS DENSITY ON YIELD AND YIELD COMPONENTS OF TWO POTATO CULTIVARS</b>	
Hashem ASGHARI, Mohammadali ABOUTALEBIAN .....	306
<b>ESTIMATION OF COMBINING ABILITY AND GENE ACTION FOR GRAIN AND OIL YIELD IN RAPESEED (<i>BRASSICA NAPUS</i> L.) USING THE LINE BY TESTER METHOD</b>	
Mahdieh ARSHADI, Mohammad Hossein FOTOKIAN, Hassan AMIRI OGHAN, Bahram ALIZADEH .....	312
<b>EFFECT NANO-TiO<sub>2</sub> AND NANO-SILICA ON SOME TRAITS OF SUNFLOWER</b>	
Naser SABAGHNIA, Mohsen JANMOHAMMADI .....	319
<b>BIPLOT ANALYSIS OF PRE-SOWING TREATMENTS OF DRAGONHEAD (<i>DRACOCEPHALUM MOLDAVICA</i> L.) WITH SOME NANO- PARTICLES</b>	
Reyhaneh Hamedi ESFAHLAN, Naser SABAGHNIA .....	326
<b>PROTEOMIC AND MOLECULAR ANALYSIS OF TOMATO PLANTS GROWN IN SOIL WITH BIOCHAR</b>	
Maria TARTAGLIA, Mauro MARRA, Mariapina ROCCO .....	332

**IMPACT OF SLAVOL MICROBIOLOGICAL FERTILIZER ON SOIL MICROORGANISMS DURING CAULIFLOWER (*BRASSICA OLERACEA* L.VAR. *BOTRYTIS*) GROWTH**

Daniela DIMOVSKA, Zvezda BOGEVSKA, Igor ILJOVSKI, Maria ZDRAVKOVSKA, Dzoko KUNGULOVSKI, Natalia ATANASOVA- PANCHEVSKA ..... 340

**THE IMPACT OF THE VEGETATION STAGES OF WHEAT AND BARLEY ON THE DYNAMICS OF THE RHIZOSPHERE MICROFLORA**

Olga NAJDENOVSKA, Jovana NAJDENOVSKA, Monika STOJANOVA, Dejan TANESKI..... 346

**THE IMPACT OF DIFFERENT TECHNOLOGIES ON THE PRODUCTION AND QUALITY OF TOBACCO SEEDLINGS**

Romina KABRANOVA, Karolina KOCHOSKA, V. TANASKOVICH, Robin MAVROSKI..... 350

**MORPHOLOGICAL CHARACTERISTICS OF FRUITS OF SOME BIFEROUS FIG (*FICUS CARICA* L.) VARIETIES GROWN IN MONTENEGRO**

Miroslav ČIZMOVIĆ, Tatjana PEROVIĆ..... 356

**ALLELIC DIVERSITY OF GLUTENINS SUBUNITS IN MOROCCAN DURUM AND BREAD WHEAT AND THEIR RELATIONSHIPS WITH GLUTEN STRENGTH**

Mona TAGHOUTI, Fatima GABOUN, Aicha CHICAR, Mustapha KANDIL, Athmane ROCHDI..... 362

**ASSESSMENT OF GENETIC VARIABILITY AMONG HOT PEPPER LANDRACE OF MALEH VALLEY ACCESSIONS IN MOROCCO**

Nadia BENBRAHIM, Mona TAGHOUTI, Youssef ELGHZAOUI, Safae EL OUASSY, Zine Abidine TRIQUI, Rachida HASSIKOU, Rachid MENTAG, Fatima GABOUN . 368

**PERFORMANCES OF NEW INDUSTRIAL TOMATO CULTIVARS (*LYCOPERSICON ESCULENTUM*) IN THE GHARB REGION OF MOROCCO**

Abdelkrim KRIRA, Nouredine ES-SAFI, Fatima GABONNE, Mohammed IBRIZ, Abdellatif OUBERRI ..... 375

**EFFECT OF MAGNETICALLY TREATED WATER ON STRAWBERRY PLANTS (*FRAGARIA* × *ANANASSA* DUCH.) IN THE NORTHWEST OF MOROCCO**

Houda TAIMOURYA, Mohamed OUSSIBLE, Lahoussaine BAAMAL, El Hassane BOURARACH, Najem HASSANAIN, Lhoussaine MASMOUDI, Abderrahmane EL HARIF..... 382

**MEASURING THE IMPACT OF SLCAL PROJECT INTERVENTION ON TARGET FIELD CROPS IN GAZA STRIP, PALESTINE**

Mohammed HUSSEIN, Mohamed ALRAEE, Fadi DWAIK..... 388

**RELATIVE FEED VALUE (RFV) OF ALFALFA-GRASS MIXTURES AFFECTED BY SPENT MUSHROOM SUBSTRATE AND SLURRY APPLICATION**

Kazimierz JANKOWSKI, Elżbieta MALINOWSKA, Milena TRUBA, Jacek SOSNOWSKI, Beata WIŚNIEWSKA-KADŻAJAN, Janina SKRZYCZYŃSKA..... 396

**THE EFFECTIVENESS OF DIFFERENT OVERDRILLING TECHNOLOGIES OF THE DRY MEADOWS IN CENTRAL POLAND**

Maria JANICKA .....	402
<b>CONTRIBUTIONS FOR ENRICHMENT OF BELL PEPPER ASSORTMENT IN ROMANIA</b>	
Elena BARCANU-TUDOR, Costel VÎNĂTORU, Bianca ZAMFIR, Camelia BRATU, Elena Maria DRĂGHICI.....	410
<b>EFFECT OF A SIMPLE VERTICAL TILLAGE TOOL OVER DRAG RESISTANCE AND SOIL MOBILIZATION</b>	
Lucian Viorel FECHETE TUTUNARU, Marius GHERES, Ioana RAD, Ferenc GASPARGASPAR, Zoltan GYORGY.....	414
<b>EFFECT OF PROPAGATION METHOD ON SWEET CORN QUALITATIVE PROPERTIES</b>	
Ferenc OROSZ.....	421
<b>CONTENT OF VITAMIN C, BETA-CAROTENE, POTASSIUM AND PHOSPHORUS IN THE LOCAL PEPPER POPULATIONS</b>	
Pandia OLIMPIA, Saracin ION, Paraschiv GIGEL, Tanasie STEFANIA ELIZA .....	426
<b>CHANGING THE CLIMATE IN THE CONTEXT OF SUSTAINABLE AGRICULTURE</b>	
Radulescu DIANA LOREDANA, Găgeanu IULIANA, Rosu MIHAELA, Pruteanu AUGUSTINA.....	432
<b>MECHANICAL SOWING OF SMALL AND VERY SMALL SEEDS (IN ALVEOLI)</b>	
Sărăcin ION, Pandia OLIMPIA , Sărăcin IOAN ALEXANDRU .....	439
<b>TARRAGON CULTIVARS (<i>ARTEMISIA DRACUNCULUS</i> L.) OF THE NIKITA BOTANICAL GARDENS BREEDING</b>	
Nadezhda BAKOVA, Lidiya LOGVINENKO, Oksana SHEVCHUK .....	445
<b>BIOTECHNOLOGICAL APPROACHES FOR BREEDING PROGRAMS IN VEGETABLE CROPS</b>	
Elena DOMBLIDES, Nataliya SHMYKOVA, Daria SHUMILINA, Tatiayana ZAYACHKOVSKAYA, Tatiayana VJURTTTS, Elena V. KOZAR, Ljudmila KAN, Valeriy ROMANOV, Arthur DOMBLIDES, Victor PIVOVAROV, Alexey SOLDATENKO .....	452
<b>FALENSKAYA 4 WINTER RYE RESPONSE TO LONG TERM FERTILIZER APPLICATIONS</b>	
Antonina KOSOLAPOVA, Konstantin KORLYAKOV, Valery VOZZHAEV .....	461
<b>SEED LIFE CYCLE MANAGEMENT</b>	
Sergej V. GONCHAROV .....	466
<b>EFFECTS OF METALLURGICAL SLAG AND ORGANIC FERTILIZER AMENDMENTS ON CHEMICAL COMPOSITION OF CHARD (<i>BETA VULGARIS</i> VAR. <i>CICLA</i>)</b>	
Aleksandra STANOJKOVIĆ-SEBIĆ, Zoran DINIĆ, Stevan ČANAK, Dragana JOŠIĆ, Radmila PIVIĆ .....	470

<b>INFLUENCE OF 24-EPIBRASSINOLIDE AND MANIPULATION OF ROOT STATUS ON PHOTOSYNTHESIS AND GROWTH OF THE MAIZE PLANTS</b>	
Hadi WAISI, Bogdan NIKOLIĆ, Vladan JOVANOVIĆ, Sanja ĐUROVIĆ .....	477
<b>WATER PRODUCTIVITY INDICES OF THE SOYBEAN GROWN ON SILTY CLAY SOIL UNDER SPRINKLER IRRIGATION</b>	
Branka KRESOVIĆ, Boško GAJIĆ, Angelina TAPANAROVA, Ljubomir ŽIVOTIĆ	481
<b>PRODUCTIVITY OF BIRDSFOOT TREFOIL ON ACID SOILS</b>	
Dalibor TOMIĆ, Vladeta STEVOVIĆ, Đorđe LAZAREVIĆ, Dragan ĐUROVIĆ, Pavle MAŠKOVIĆ.....	489
<b>NS PEPPER VARIETIES IN A MULTIVARIATE FRUIT ANALYSIS</b>	
Dario DANOJEVIĆ, Slađana MEDIĆ-PAP, Janko ČERVENSKI .....	495
<b>HUMUS CONTENTS IN SOILS OF ALEKSINAC MUNICIPALITY IN SERBIA</b>	
Dragan GRČAK, Miodrag JELIĆ, Milosav GRČAK, Marko AKSIĆ, Dragana GRČAK .....	501
<b>EVALUATION OF MEDIUM EARLY PLUM CULTIVARS IN THE REGION OF BELGRADE (SERBIA)</b>	
Dragan MILATOVIĆ, Dejan ĐUROVIĆ, Gordan ZEC, Đorđe BOŠKOV, Mirjana RADOVIĆ.....	507
<b>THE IMPACT OF THE NATURAL SEED PURITY ON THE FINAL QUANTITY OF SEEDS OF RED CLOVER (<i>Trifolium pratense</i> L.) AFTER PROCESSING</b>	
Dragoslav ĐOKIĆ, Rade STANISAVLJEVIĆ, Dragan TERZIĆ, Jasmina MILENKOVIĆ, Zoran LUGIĆ, Ranko KOPRIVICA, Saša BARAĆ .....	513
<b>THE EFFECT OF MULTI-YEAR CROP ROTATION ON THE WEEDINESS OF MAIZE</b>	
Dušan KOVAČEVIĆ, Željko DOLIJANOVIĆ, Vesna MILIĆ, Nemanja GRŠIĆ, Aleksandar KOVAČEVIĆ .....	519
<b>TESTING OF MAIZE INBREED LINES SEED GERMINATION IN THE SOIL</b>	
Jasna KOJIĆ, Marija MILIVOJEVIĆ, Tanja PETROVIĆ, Marijenka TABAKOVIĆ, Nikola STEVANOVIĆ .....	525
<b>CHANGES IN FRUIT QUALITY OF STRAWBERRY CULTIVAR ‘JOLY’ DURING HARVEST</b>	
Jelena TOMIĆ, Marijana PEŠAKOVIĆ, Žaklina KARAKLAJIĆ-STAJIĆ, Rade MILETIĆ, Svetlana M. PAUNOVIĆ, Mira MILINKOVIĆ.....	530
<b>EFFECT OF GROWING SEASON AND GENOTYPE ON WINTER WHEAT QUALITY</b>	
Kristina LUKOVIĆ, Veselinka ZEČEVIĆ, Slaven PRODANOVIĆ, Jelena MILIVOJEVIĆ, Vera ĐEKIĆ.....	536
<b>THE EFFECTS OF HYDROGEL AND ZEOLITE TREATMENT ON ORNAMENTAL FLOWERS TRANSPLANTS</b>	
Lazar PAVLOVIĆ, Emina MLADENOVIĆ, Martina ZORIĆ, Jelena ČUKANOVIĆ, Ksenija HIEL.....	543
<b>EFFECT OF NITROGEN ON YIELD AND NITRATE CONTENT IN POTATO TUBERS</b>	

Ljiljana BOŠKOVIĆ-RAKOČEVIĆ, Goran DUGALIĆ, Nikola BOKAN, Marijana DUGALIĆ.....	549
<b>THE NUMBER OF AZOTOBACTER SP. DEPENDING ON SOIL TYPE AND AZOTE QUANTITY UNDER "UGAR" AND SOWN CORN</b>	
Ljubica ŠARČEVIĆ - TODOSIJEVIĆ , Ljubiša ŽIVANOVIĆ, Jelena GOLIJAN .....	555
<b>INFLUENCE OF PSEUDOMONAS SPP. AND METALLURGICAL SLAG AMENDMENT ON MACROELEMENTS CONTENT IN RADICCHIO GROWN ON ACID SOIL</b>	
Radmila PIVIĆ, Aleksandra STANOJKOVIĆ-SEBIĆ, Zoran DINIĆ, Magdalena KNEŽEVIĆ, Renata ILIČIĆ, Dragana LATKOVIĆ, Dragana JOŠIĆ.....	561
<b>EFFECT OF DIFFERENT SEED TREATMENTS ON THE DORMANCY BREAKING AND GERMINATION OF DARWIN'S BARBERRY (BERBERIS DARWINII HOOK)</b>	
Marija MARKOVIĆ, Mihailo GRBIĆ, Dragana SKOČAJIĆ, Matilda ĐUKIĆ, Danijela ĐUNISIJEVIĆ-BOJOVIĆ .....	567
<b>EFFECT OF GIBBERELIC ACID AND POTASSIUM NITRATE ON THE SEED GERMINATION OF BLUE-EYED GRASS (SISYRINCHIUM ANGUSTIFOLIUM MILL.)</b>	
Marija MARKOVIĆ, Mihailo GRBIĆ, Dragana SKOČAJIĆ, Matilda ĐUKIĆ, Danijela ĐUNISIJEVIĆ-BOJOVIĆ .....	572
<b>IMPACTS OF LIMING AND FERTILIZATION ON YIELD OF TWO TRITICALE VARIETIES</b>	
Milan BIBERDŽIĆ, Saša BARAĆ, Danijela PRODANOVIĆ, Aleksandar ĐIKIĆ, Vera ĐEKIĆ, Dragana LALEVIĆ .....	577
<b>PLANT HEIGHT AND GRAIN YIELD OF MAIZE IN DIFFERENT CROPPING SYSTEMS</b>	
Milena SIMIĆ, Igor SPASOJEVIĆ, Vesna DRAGIČEVIĆ, Dušan KOVAČEVIĆ, Željko DOLIJANOVIĆ, Milan BRANKOV .....	583
<b>AN ANALYSIS OF PLUM PRODUCTION IN SERBIA FROM 2005 TO 2016</b>	
Milosav GRČAK, Dragan GRČAK, Marko AKSIĆ .....	590
<b>IMPACT OF CLIMATE CHANGE ON POTATO YIELD GROWN IN DIFFERENT CLIMATIC ZONE IN BOSNIA AND HERZEGOVINA</b>	
Ružica STRIČEVIĆ, Goran TRBIĆ, Mirjam VUJADINOVIĆ, Raduška CUPAĆ, Nevenka ĐUROVIĆ, Marija ČOSIĆ .....	596
<b>THE ROLE OF AGRICULTURAL SERVICE IN PRODUCTION OF HEALTH PLANTING MATERIAL IN RASINA DISTRICT, SERBIA</b>	
Sandra MILETAKOVIC, Radomir JOVANOVIĆ, Dragoljub MILOSAVLJEVIĆ, Branka ANTIC .....	602
<b>EFFECT OF DIRECT SELECTION ON PRODUCTIVE TRAITS OF VALERIAN (Valeriana officinalis L.)</b>	
Slobodan B. DRAŽIĆ .....	608
<b>DIVERSITY OF TALL FESCUE (Festuca arundinacea Scherb.) AUTOCHTHONOUS POPULATIONS AND CULTIVARS</b>	

Snezana BABIC, Dejan SOKOLOVIC, Jasmina RADOVIC, Zoran LUGIC, Goran JEVTIC, Snezana ANDJELKOVIC, Tanja VASIC.....	612
<b>VARIABILITY OF TOCHOPHEROLS CONTENT IN MAIZE INBRED LINES</b>	
Snežana MLADENOVIC DRINIĆ, Jelena MESAREVIĆ, Milan STEVANOVIĆ, Jelena SRDIĆ, Natalija KRAVIĆ, Milomir FILIPOVIĆ, Violeta ANĐELKOVIĆ .....	618
<b>IDENTIFICATION OF POTENTIAL DUPLICATES IN MAIZE GENE BANKS USING MOLECULAR DATA</b>	
Violeta ANĐELKOVIĆ, Dragan KOVAČEVIĆ, Ana NIKOLIĆ, Mirjana JANKULOVSKA, Sonja IVANOVSKA, Dane BOSEV, Snežana MLADENOVIC DRINIĆ .....	623
<b>FLORISTIC COMPOSITION AND ABUNDANCE OF WEED COMMUNITY IN MAIZE UNDER DIFFERENT FERTILIZATION TREATMENT</b>	
Snežana OLJAČA, Milena SIMIĆ, Željko DOLIJANOVIĆ, Vesna DRAGIČEVIĆ, Mićo OLJAČA .....	630
<b>THE WHEAT PLANT HEIGHT AND SPIKE TRAITS PHENOTYPIC VARIATION AS A RESPONSE TO ABIOTIC STRESS CONDITION OF HALOMORPHIC SOIL</b>	
Sofija PETROVIĆ, Miodrag DIMITRIJEVIĆ, Borislav BANJAC, Mirela MATKOVIĆ STOJŠIN, Velimir MLADENOV .....	637
<b>YIELD COMPONENTS AND GENETIC POTENTIAL OF WINTER BARLEY</b>	
Vera ĐEKIĆ, Jelena MILIVOJEVIĆ, Vera POPOVIĆ, Snežana BRANKOVIĆ, Miodrag JELIĆ, Kristina LUKOVIĆ, Dragan TERZIĆ .....	643
<b>WINTER WHEAT YIELD AND YIELD COMPONENTS DEPENDING ON THE LEVEL OF NITROGEN, PHOSPHORUS AND POTASSIUM FERTILIZATION</b>	
Vera ĐEKIĆ, Miodrag JELIĆ, Jelena MILIVOJEVIĆ, Vera POPOVIĆ, Snežana BRANKOVIĆ, Mirjana STALETIĆ, Dragan TERZIĆ.....	650
<b>ANALYSIS OF VEGETABLE PRODUCTION IN SERBIA</b>	
Vera RAŠKOVIĆ, Vojislav TOMIĆ, Vera MILOŠEVIĆ, Milan GLIŠIĆ .....	658
<b>EARLY PHYTOTOXIC EFFECTS OF SULFONYLUREA HERBICIDES IN MAIZE LINES</b>	
Vesna DRAGIČEVIĆ, Milan BRANKOV, Milena SIMIĆ .....	667
<b>RESULTS OF INVESTIGATION WITH DIFFERENT VARIETIES OF SWEET POTATO IN SOMBOR AREA (SERBIA)</b>	
Vladimir SABADOŠ, Jelena IVAN, Olivera SEKULIĆ, Danijela DOROTIĆ.....	672
<b>THE EFFECT OF COVER CROPS ON THE CONTENT OF VITAMIN C IN GRAIN OF SWEET MAIZE</b>	
Željko DOLIJANOVIĆ, Snežana OLJAČA, Dušan KOVAČEVIĆ, Milena SIMIĆ, Jelena SRDIĆ, Nebojša MOMIROVIĆ, Đorđe MORAVČEVIĆ .....	676
<b>EVALUATION OF ANTIOXIDANT PROPERTIES OF SALVIA OFFICINALIS L., ROSMARINUS OFFICINALIS L. FROM EASTERN SLOVAKIA AND FLORSALMIN</b>	
Janka PORÁČOVÁ, Juliana BARANOVÁ, Vincent SEDLÁK, Zuzana GOGALOVÁ, Marta MYDLÁROVÁ BLAŠČÁKOVÁ, Daniela GRUĽOVÁ, Mária KONEČNÁ, Ruslan MARIYCHUK, Adriana ELIÁŠOVÁ, Jozef FEJÉR, Janka KOTOSOVÁ .....	683



<b>GRAIN AND PROTEIN YIELD OF SELECTED GRAIN LEGUMES IN SUB-ALPINE AND PANNONIAN GROWING CONDITIONS</b>	
Aleš KOLMANIČ .....	690
<b>EFFECT OF OPTIMIZED REGULATED DEFICIT IRRIGATION ON THE PROFITABILITY OF PURPLE GARLIC IN A SEMIARID REGION OF SPAIN</b>	
Alfonso DOMÍNGUEZ, Bruno C. LÉLLIS, José J. PARDO, José M. TARJUELO, Ángel MARTÍNEZ-ROMERO .....	696
<b>MINERAL PROFILE OF TWO PHENOTYPES OF GALEGA KALE (<i>Brassica oleracea</i> L. var. <i>acephala</i> cv. Galega)</b>	
Lucía GÓMEZ-LIMIA, Jorge ARMESTO, Noemí COBAS, Inmaculada FRANCO, Sidonia MARTÍNEZ .....	702
<b>EVALUATION OF THREE INTRODUCED WINE GRAPE VARIETIES UNDER A RAIN-FED SYSTEM OF AGRICULTURE IN SYRIA</b>	
Ola T. ALHALABI, Bayan M. MUZHER, Alaa ALZGAIR .....	707
<b>EVALUATION OF THE BEHAVIOR OF SOME <i>PISTACIA VERA</i> FEMALE GENOTYPES IN THE SOUTH OF SYRIA</b>	
Najwa Motaeb ALHAJJAR, Bayan Mohammad MUZHER .....	713
<b>OPTIMAL HARVEST DATE OF THE APPLE ROYAL RED CULTIVAR FOR LONG STORAGE IN THE SOUTH OF SYRIA</b>	
Bayan M. MUZHER, Ola T. ALHALABI .....	720
<b>EFFECT OF A MAGNETIC TREATMENT OF SALT WATER ON SEED GERMINATION</b>	
Hsan Youssef MEHDAOUI, Manuela Roldão OLIVEIRA, Monem KALLEL .....	727
<b>SEED PROPERTIES OF HAWTHORN (<i>Crateagus</i> sp.) SPECIES AND EFFECTS OF SULFURIC ACID PRETREATMENTS ON SEED COAT THICKNESS</b>	
Askin GOKTURK, Sinan GUNER, Ferhat YILDIRIM .....	733
<b>THE EFFECTS OF SOME SUMMER PRUNING AND HUMIC SUBSTANCE APPLICATIONS ON THE NUTRITIONAL VALUE OF ALPHONSE LAVALLÉE GRAPE CULTIVAR</b>	
Aydın AKIN .....	739
<b>DETERMINATION THE EFFECTS OF NITROGEN DOSES ON HAY YIELD AND QUALITY CHARACTERISTICS OF SOME OAT CULTIVARS/LINES</b>	
Celal BAYRAM, İlknur AYAN .....	744
<b>INVESTIGATION OF RELATION BETWEEN SOME PHYSIOLOGICAL PARAMETERS AND YIELD IN MAIZE (<i>ZEA MAYS</i> L.)</b>	
Sevda KILINC, Cetin KARADEMIR, Zehra EKIN .....	750
<b>PEST SPECIES IN CHESTNUT GROWING AREAS OF IZMIR AND MANISA PROVINCES AND THEIR ECONOMIC IMPORTANCE</b>	
Cevdet KAPLAN, Tevfik TURANLI, N. Mükerrrem ÇELİKER .....	756
<b>ECONOMIC ANALYSIS OF FERTILIZATION IN THE RANGELANDS BY NUTRITIONAL VALUE: A NEW OPINION</b>	
Duygu ALGAN, Ibrahim AYDIN, Nuh OCAK .....	763

<b>DETERMINATION OF YIELD AND TECHNOLOGICAL PROPERTIES OF EARLY MATURING COTTON GENOTYPES</b>	
Emine KARADEMİR, Cetin KARADEMİR, Remzi EKINCI, Ugur SEVILMIS.....	769
<b>EFFECT OF CROP ROTATION ON HAY YIELD AND PROFITABILITY</b>	
Erdem GULUMSER, Zeki ACAR.....	776
<b>DETERMINATION OF APPROPRIATE SOWING DENSITY FOR THE FORAGE PEA IN SAMSUN (TURKEY) CONDITIONS</b>	
Ertan ÖZ, Zeki ACAR .....	782
<b>EFFICIENCY OF DIFFERENT CHEMOMETRIC METHODS FOR DETERMINATION OF OIL CONTENT IN MAIZE BY NIR SPECTROSCOPY</b>	
Fatih KAHRIMAN, Fatih ÖNER, Figen MERT TÜRK, Ayşe Nur GÖKÇE, Ebru DÜZEN, İskender ONAÇ, Cem Ömer EGESSEL.....	788
<b>EFFECT OF IODINE ON GERMINATION AND YIELD IN ROCKET (<i>Eruca vesicaria</i>) PLANT</b>	
Gizem AKSU, Berat Sencer AKARSLAN, Hamit ALTAY .....	794
<b>EFFECTS OF HUMIC ACID APPLICATIONS ON LETTUCE GROWTH AND ON SOME PROPERTIES OF SOIL CONTAMINATED BY CADMIUM</b>	
Gizem AKSU .....	800
<b>COMPOSITONS AND FEEDING VALUES OF SILAGE CORN (<i>Zea mays</i> L.) VARIETIES GROWN AS THE SECOND CROP</b>	
Hakkı AKDENİZ, Süleyman TEMEL, Bilal KESKİN, İbrahim HOSAFLIOĞLU.....	805
<b>THE YIELD AND SOME NUTRITIONAL COMPONENTS OF FOUR HAIRY VETCH (<i>VICIA VILLOSA</i> ROTH L.) VARIETIES</b>	
Ali KOÇ, Hakkı AKDENİZ.....	812
<b>AGRONOMIC PERFORMANCES AND NUTRITIONAL VALUES OF FOUR HAIRY VETCH (<i>VICIA VILLOSA</i> ROTH L.) VARIETIES GROWN IN DIFFERENT LOCATIONS</b>	
Hakkı AKDENİZ, Ali KOÇ.....	823
<b>HAY YIELD AND SOME QUALITY TRAITS OF ALFALFA CULTIVARS IN THREE YEARS OLD STAND</b>	
Hanife MUT, Erdem GULUMSER, Ugur BASARAN, Medine COPUR DOGRUSOZ, Ilknur AYAN.....	833
<b>EFFECT OF VARIETY AND SOWING DENSITY ON SOME MICROELEMENTS CONTENT AND GRAIN YIELD OF CHICKPEA (<i>Cicer arietinum</i> L.)</b>	
Hasan KILIÇ, Mohammed Hussein AZIZ.....	840
<b>PRODUCTION POTENTIAL AND DEVELOPMENT OPPORTUNITIES OF HAZELNUT (<i>Corylus avellana</i> L.) IN TURKEY</b>	
Mikdat ŞİMŞEK, Abdurrahman KARA .....	847
<b>YIELD AND BIOCHEMICAL DIFFERENCES OF CAULIFLOWER (<i>Brassica oleracea</i> L. cv. <i>Botrytis</i>) UNDER DIFFERENT IRRIGATION LEVELS</b>	
Okan ERKEN, Murat YILDIRIM.....	853

**EFFECTS OF THE PICKING PEDICLE AT DIFFERENT STAGES ON TULIP GROWTH**

Özgür KAHRAMAN ..... 861

**THE EFFECT OF DIFFERENT NATURAL FERTILIZATION TECHNIQUES ON SOIL CHARACTERISTICS IN DRIED FIG (*Ficus Carica* L.Cv. Sarilop) PRODUCTION**

Saime SEFEROĞLU, M. Ali KAPTAN, Seçil KÜÇÜK KAYA, Nilgün TAN, Ferit ÇOBANOĞLU, Hilmi KOCATAŞ..... 867

**THE QUALITY CHARACTERISTICS OF INDUSTRIAL TOMATO AND THE NUTRITIONAL STATUS OF THE LEAVES IN INDUSTRIAL TOMATO GROWN IN THE MEANDER BASIN**

Saime SEFEROĞLU Nur OZDOĞAN..... 875

**EFFECT OF PHOSPHORUS FERTILIZER AND SOIL BORON STATUS ON YIELD AND QUALITY OF SOYBEAN**

Mehmet AYDIN, Seçil KÜÇÜK KAYA, Mustafa Ali KAPTAN ..... 883

**NUTRIENT CONTENT OF SOME SILAGE SORGHUM VARIETIES GROWN AS SECOND CROP UNDER IĞDIR ECOLOGICAL CONDITION**

Suleyman TEMEL, Bilal KESKİN, Hakki AKDENİZ, Baris EREN..... 891

**EFFECTS OF VARIETIES AND HARVESTING DATES ON YIELD, YIELD COMPONENTS AND TECHNOLOGICAL CHARACTERISTICS OF SUGAR BEET IN KAHRAMANMARAŞ CONDITIONS**

Süreyya Gülfem ALTUNBAY..... 899

**WALNUT PRODUCTION IN TURKEY FROM PAST TO PRESENT**

Yaşar AKÇA, Sebahattin YILMAZ..... 904

**DETERMINATION OF ADAPTATION AND QUALITY TRAITS OF SOME COOL SEASON TURF GRASSES IN SAMSUN CONDITIONS**

Zeki ACAR, Sedat ARSLAN, Zeynep MALKOÇ, Ertan ÖZ, İlknur AYAN..... 911

**PERFORMANCE OF LOCAL OAT GENOTYPES AT DIFFERENT LOCATIONS**

Zeki MUT, Hasan AKAY, Özge Doğanay ERBAŞ KÖSE..... 917

**THE EFFECT OF DIFFERENT SOWING DATES AND SOWING DENSITIES ON GRAIN YIELD AND SOME YIELD COMPONENTS OF DIYAR-95 CHICKPEA VARIETY UNDER DRY CONDITIONS IN DIYARBAKIR (TURKEY)**

Zubeyir TURK ..... 923

**ESTIMATE OF QUANTITATIVE HERITABILITY IN SOME CHICKPEA GENOTYPES (*Cicer arietinum*L.)**

Zubeyir TURK ..... 930

**EFFECT OF HEXACONAZOLE ON THREE PURPLE SWEET POTATO VARIETIES IN THE MEKONG DELTA**

PHAM Thi Phuong Thao, LE Van Hoa, PHAM Phuoc Nhan, LE Thi Hoang Yen, PHAN Huu Nghia ,TRAN Nguyen..... 936

<b>IMPACT OF SHEETING AND SHELF LIFE OF IBA 4000PPM ON PLANTING OF VEGETATIVE FRAGMENTS OF NATIVE AUTOCHTHONOUS OLIVE POPULATIONS</b>	
Rakip ILJAZI, Adem SALILLARI, Nikoll BARDHI, Hekuran VRAPI.....	943
<b>STUDY OF FOLIAR FERTILIZERS IMPACT ON THE BIOMETRIC INDICATORS OF TWO COMMON WHEAT VARIETIES</b>	
Antoniya STOYANOVA, Velika KUNOVA.....	948
<b>WATER USE EFFICIENCY AND LAND EQUIVALENT RATIO OF SOYBEAN AND CORN IN SOLID AND INTERCROPPING SYSTEMS IN EGYPT</b>	
Abd El-Alim Abdel-Rhman METWALLY , Sayed Ahmed SAFINA, Rushdy EL-KILLANY, Neama Abd El-Salheen SALEH .....	955
<b>THE SUM OF TEMPERATURE UNITS IN DIFFERENT PHENO-PHASES OF DEVELOPMENT OF SEED MAIZE REGARDING THE PRODUCTION YEAR</b>	
Marijenka TABAKOVIĆ, Jasna VUJINOVIĆ; Rade STANISAVLJEVIĆ, Ratibor ŠTRBANOVIĆ, Vera POPOVIĆ .....	963
<b>INFLUENCES OF FOLIAR FERTILIZERS AND GENOTYPE ON POLYPHENOL AND ANTIOXIDANT STATUS OF YELLOW SOYBEAN SEEDS</b>	
Sanja ĐUROVIĆ, Bogdan NIKOLIĆ, Vesna DRAGIČEVIĆ, Hadi WAISI, Zorica KNEŽEVIĆ-JUGOVIĆ .....	968
<b>SEED QUALITY OF THE FACELIA-VARIETY NS PRIORA GROWN IN SERBIA</b>	
Vera POPOVIĆ, Vojislav MIHAILOVIĆ, Sanja VASILJEVIĆ, Biljana KIPROVSKI, Vera RAJIČIĆ, Marijenka TABAKOVIĆ, Ljiljana ŠAŠIĆ ZORIĆ, Mladen TATIĆ ..	974
<b>EFFECTS OF DIFFERENT PLANTING TIME AND PLANT DENSITIES ON SOME PARAMETERS OF SECOND CROP SESAME</b>	
Ahmet YILMAZ, Servet ABRAK .....	982
<b>THE EFFECTS OF DIFFERENT DWARFING APPLICATIONS ON BURSA BLACK FIG (<i>FICUS CARICA</i> L.) TREES IN TERMS OF YIELD AND QUALITY</b>	
Halil Güner SEFEROĞLU, Mehmet TOMAŞ .....	986
<b>DETERMINATION OF DEVELOPMENT STATES IN AYDIN REGION OF SOME APRICOT SPECIES</b>	
H Güner SEFEROĞLU, Ayşe Merve ARDIÇ .....	992
<b>CORRELATION BETWEEN SESAME YIELD AND YIELD PARAMETERS</b>	
Servet ABRAK Ahmet YILMAZ .....	998
<b>CORRELATION OF PRECIPITATION WITH YIELD GRAIN AND VARIABILITY OF MAIZE PRODUCTION OF REPUBLIC OF SRPSKA (BOSNIA AND HERZEGOVINA)</b>	
Goran OSTIĆ, Novo PRŽULJ, Slavko RADANOVIĆ, Dejan SIMIĆ, Dejan SUPIĆ, Miroslav ŠTRBAC .....	1003
<b>YIELD AND YIELD STRUCTURE OF DOMESTIC WHEAT VARIETIES DEPENDING ON SOWING RATES</b>	
Iskra ARAPOVIĆ, Dragan MANDIĆ, Goran ĐURAŠINOVIĆ, Novo PRŽULJ, Zoran JOVOVIĆ.....	1010

<b>INFLUENCE OF LOCALITY AND FERTILIZATION ON YIELD OF BUCKWHEAT</b>	
Branka GOVEDARICA, Igor DJURDJIC, Tanja JAKISIC, Milan JUGOVIC, Ljubisa CVIJIC, Goran KARADZIC, Vesna MILIC .....	1015
<b>THERMAL INACTIVATION KINETICS OF PEROXIDASE IN GALEGA KALE (Brassica oleracea L. var. acephala CV. Galega)</b>	
Lucía GÓMEZ-LIMIA, Iria DACOSTA, Manuel ARIAS, Inmaculada FRANCO, Lorena PIÑEIRO, Sidonia MARTÍNEZ .....	1023
<b>THE YIELD AND YIELD COMPONENTS OF SOME SILAGE MAIZE (ZEA MAYS L.) VARIETIES AS THE SECOND CROP</b>	
Bilal KESKİN, Hakkı AKDENİZ , Süleyman TEMEL, Barış EREN .....	1029
<b>THE EFFECT OF FERTILIZATION ON LAVANDULA ANGUSTIFOLIA L. YIELD IN NORTH GREECE</b>	
Elpiniki SKOUFOGIANNI, Kyriakos D. GIANNOULIS, Dimitrios BARTZIALIS, Dimitra TZOUVARA, Nicholaos G. DANALATOS .....	1037
<b>EFFECTS OF N AND P FERTILIZATION OF TRITICALE AND COMMON VETCH PLANTS IN PLANT HEIGHT WITH PLANTS DRY-FORAGE YIELD</b>	
Ayşe GÜNEŞ, Mustafa KIZILŞİMŞEK, Meryem KUZUCU .....	1044
<b>INFLUENCE OF TILLAGE PRACTICES ON THE OIL YIELD OF SOYBEANS</b>	
Tunahan ERDEM, Murat TURGUT .....	1053
<b>2. PLANT PROTECTION AND FOOD SAFETY .....</b>	<b>1057</b>
<b>THE DAMAGE OF THRIPS (FRANKLINIELLA OCCIDENTALIS) IN GREENHOUSE PEPPER IN THE BEJAIA REGION (ALGERIA)</b>	
Aldjia OUDJIANE, Atika BNRIMA, Farid BOUNACEUR , Fariza BOUSSAD, Aldjia HMICHE, Christian RALAHIMANA .....	1058
<b>CURRENT STATUS OF CITRUS TRISTEZA VIRUS (CTV) AND ITS POTENTIAL APHID'S VECTORS IN CHLEF VALLEY (ALGERIA)</b>	
Samir ALI AROUS, Yamina GUENAOUI, Khaled DJELOUAH .....	1064
<b>HOW CAN THE STAFF HYGIENE PRACTICES INFLUENCE THE MILK HEALTHY QUALITY? CASE OF STUDY FROM M'ZAB DAIRY IN ALGERIA</b>	
Hocine BENSABA, Lahcen BENSABA .....	1071
<b>BIOCONTROL OF ACTINOBACTERIA AGAINST STREPTOMYCES SCABIES</b>	
Lamia AOUAR, Abderrahmane BOULAHROUF .....	1078
<b>IMPACT OF THREE DIET REGIMES ON BIOLOGICAL PARAMETERS OF Ectomyelois ceratoniae</b>	
Mohamed Seghir MEHAOUA, Ayoub HADJEB, Hanane BEDJAOUI, Mohamed Laïd OUAÏD .....	1087
<b>EFFECTIVENESS OF WATER EXTRACTS OF PEGANUM HARMALA AND ESSENTIAL OILS OF MENTHA PULEGIUM ON CALLIPTAMUS BARBARUS (ORTHOPTERA: ACRIDIDAE)</b>	
Moad ROUIBAH , Rabah BOUREDJOUL, Salaheddine KOUAHI .....	1094

**POPULATIONS OF APHIDS ON TWO MANDARIN VARIETIES AND THEIR CORRELATION WITH SOME LEAF CHARACTERISTICS**

Salim LEBBAL' ..... 1102

**FAUNAL BIODIVERSITY ASSOCIATED TO THE TOMATO CULTURE (*LYCOPERSICON ESCULENTUM* MILL, TAVERA VARIETY) IN METIJDA**

Nadia YAHIA, Faiza MARNICHE , Manel BELLACHE , Wassila BENSLIMANE , Samia MOUHEB ..... 1108

**THE MAIN CITRUS APHID SPECIES AND THEIR PARASITOIDS IN NORTHWESTERN ALGERIA. WHY IS APHID CONTROL NOT ALWAYS SUCCESSFUL?**

Zine Eddine LABDAOUI, Yamina GUENAOU..... 1114

**THE EFFECT OF VEGETABLE FATS ON THE QUALITY AND SENSORY PROPERTIES OF TEA COOKIES**

Amela SEMIC, Selma CORBO, Seval MUMINOVIC ..... 1120

**TECHNOLOGICAL PROPERTIES OF POMEGRANATE JUICE FROM MOSTAR CITY AREA (BOSNIA AND HERZEGOVINA)**

Amna BIJEDIĆ, Hanadija OMANOVIĆ, Asima AKAGIĆ ..... 1126

**EFFICACY OF NEW HERBICIDES AND HERBICIDE COMBINATIONS ON CORIANDER (*CORIANDRUM SATIVUM* L.)**

Grozi DELCHEV, Teodora BARAKOVA ..... 1130

**INSECTICIDES FOR THE CONTROL TOBACCO THRIPS (*THRIPS TABACI* LIND.) OF THE COTTON**

Stefan RASHEV, Yanko DIMITROV, Nedyalka PALAGACHEVA..... 1136

**THE EFFECT OF ORGANIC AMENDMENTS ON UPTAKE OF HEAVY METALS IN MAIZE (*ZEA MAYS* L.)**

Violina ANGELOVA, Krasimir IVANOV ..... 1141

**KEEPING THE QUALITY AND EXTENDING SHELF-LIFE OF STRAWBERRY FRUITS BY USING ARBIC GUM AS EDIBLE COATING**

Mohamad ABD ELHAMED GOMMAA, Elsayed AWAD ABDELRASOUL, Maha MAHFOZ GOMMAA ..... 1147

**EXPERIMENTAL CONTROL TRIALS ON THE PREVALENCE OF *ESCHERICHIA COLI* IN RETAIL RAW BEEF**

Mohamed HAMADA' Abo-Bakr EDRIS, Abdel-Rahman EL-BAGORY, Mahmoud NADA ..... 1158

**A DATE PALM DISEASE CAUSED BY *ACREMONIUM STRICTUM* (*CEPHALOSPORIUM*) IN SAUDI ARABIA**

Mohammad Fawzy RASHED ..... 1165

**MASS PRODUCTION OF THE FACULTATIVE PARASITIC MITE, *AEGYPTUS RHYNCHOPHORUS*, AS A NATURAL ENEMY AGAINST THE RED PALM WEEVIL IN EGYPT**

Sally Farouk ALLAM, Ahmed Rabie EL-BADAWY ..... 1172

**CORRELATION BETWEEN STORAGE PERIOD AND SOME BIOLOGICAL AND CHEMICAL PROPERTIES IN THREE QUINOA LINES SEED**

Tawfik H. ABD EL-MOITY, Sahar T. IBRAHIM, Ayat M. ALI..... 1178

**VIRULENCE OF THE WHEAT LEAF RUST POPULATION IN GEORGIA**

Zoia SIKHARULIDZE, Ketino SIKHARULIDZE, Ketino NATSARISHVILII, Tsisana TSETSKHLADZE, Lali MGELADZE..... 1186

**ALLELOPATHIC EFFECTS OF THREE IMPORTANT WEEDS ON GERMINATION AND EARLY GROWTH OF WINTER WHEAT**

Erzsébet NÁDASY, György PÁSZTOR, Astrit MUCOLLI ..... 1192

**MODEL STUDY TO INVESTIGATE THE TOXIC INTERACTION BETWEEN TEBUCONAZOLE FUNGICIDE AND LEAD ACETATE ON CHICKEN EMBRYOS**

Géza SZEMERÉDY, Rita SZABÓ, Éva KORMOS, Csenge SZALAI, József LEHEL, Péter BUDAI..... 1198

**VIROLOGICAL EXAMINATION OF PUBLIC ORNAMENTAL PLANTS**

György PÁSZTOR, Erzsébet NÁDASY IHÁROSI, András TAKÁCS..... 1203

**ISOLATION OF INSECTICIDAL MOLECULES FROM CASSAVA AND FORMULATION OF BIO-PESTICIDES AGAINST SOME IMPORTANT PESTS OF HORTICULTURAL CROPS**

Unni Krishnan JITHU, Cheruvandasseri Arumughan JAYAPRAKAS, George AJESH, Narendranath Rajambika LEKSHMI, Lekshmikutty Shivashankaran RAJESWARI, Srinivas LEENA, Jayakumar Rajeswari JITHINE ..... 1208

**WHITE CHEESE MICROBIAL PROPERTIES MADE OF INFRA RED PASTEURIZED MILK RIPENED IN POTASSIUM CHLORIDE (KCl) SOLUTION**

Simin HAGH NAZARI, Mohammad Reza AZIMI, Sajjad VALINEZHAD..... 1215

**ACCUMULATION OF HEAVY METALS IN THE WILD FOREST MOUNTAINS OF EASTERN KAZAKHSTAN**

Gulnar S. AIDARKHANOVA, Andrey A. KALACHEV, Ayaulym N. TILEUBERDI ..... 1224

**EVALUATION OF DOSES OF RADIATION DUE TO NATURAL RADIOACTIVITY IN CORN AS ANIMAL FEED IN THE VICINITY OF THE CITY OF SKOPJE (MACEDONIA)**

Aleksandra ANGELESKA, Elizabeta DIMITRIESKA STOJKOVIK, Zehra HAJRULAI-MUSLIU, Radmila CRCEVA NIKOLOVSKA, Biljana DIMZOVSKA, Riste UZUNOV, Dean JANKULOSKI ..... 1230

**THE INFLUENCE OF THE DRYING TECHNOLOGY ON THE CHEMICAL COMPOSITION OF *STENLEJ* AND *CACANSKA RODNA* PLUM CULTIVARS**

Monika STOJANOVA, Olga NAJDENOVSKA, Igor IVANOVSKI, Jovana NAJDENOVSKA..... 1236

**INFLUENCE OF BIOFERTILIZERS ON SOIL MICROFLORA IN PRODUCTION OF SAFETY FOOD**

Olga NAJDENOVSKA, Monika STOJANOVA, Jovana NAJDENOVSKA, Dejan TANESKI, Marina STOJANOVA..... 1242

**GENETICALLY-MODIFIED FOOD AND ITS IMPACT ON OVERCOMING MALNUTRITION**

Muhammad suhail IBRAHIM, Asif AHMAD, Maria KHAN, Zaheer AHMAD, Asma SOHAIL ..... 1248

**REDUCTION IN ENERGY DEMAND FOR GRAIN DRYING THROUGH HEAT RECOVERY FROM HUMID AIR EXTRACTED FROM CROSSFLOW DRYERS**

Edward PRZYDRÓŻNY, Aleksandra PRZYDRÓŻNA ..... 1255

**PRESENCE OF THE GRAPEVINE LEAFHOPPER *SCAPHOIDEUS TITANUS* IN VINEYARDS IN NORTH-EASTERN ROMANIA**

Constantina CHIRECEANU, Andrei TEODORU, Ghica MIHU, Marioara BOSOI, Ileana STOIAN ..... 1261

**PHYSIOLOGICAL AND BIOCHEMICAL CHANGES IN GRAPEVINE LEAVES AFFECTED BY YELLOWING AND REDDENING SYMPTOMS**

Cristina PETRISOR, Constantina CHIRECEANU, Teodor PODRUMAR ..... 1267

**EXTRACT VISCOSITY OF FEED INGREDIENTS USED FOR EVALUATION OF ANTINUTRITIONAL PROPERTIES**

Rodica CAPRITA, Adrian CAPRITA ..... 1273

**EFFECT OF DRY HEAT TREATMENT ON THE DIETARY FIBER IN BARLEY**

Rodica CAPRITA, Adrian CAPRITA ..... 1278

**OBSERVATIONS ON FLIGHT DYNAMICS OF THE LEAF MINING MOTH - *CAMERARIA OHRIDELLA DESCHKA & DIMIC* IN 2014-2015**

Mihai TĂLMACIU , Nela TĂLMACIU , Carmen MIROIU , Monica HEREA ..... 1283

**YIELDS AND PATOGENS OF NEW VARIETIES OF BARLEY AND WHEAT DURING 2016 IN DOBROGEA REGION OF ROMANIA**

Vasile JINGA, Carmen LUPU, Anamaria GIUMBA, Dumitru MANOLE ..... 1290

**EFFECT OF EPIN EXTRA REGULATOR ON DEVELOPMENT OF BARLEY GROWING ON Cd-CONTAMINATED SOIL**

Nadezhda LOI, Natalya SANZHAROVA ..... 1295

**METHOD VALIDATION FOR THE SIMULTANEOUS DETERMINATION OF ACTIVE INGREDIENTS OF ACARICIDE ABAMECTIN AND ETOXAZOLE IN PESTICIDE FORMULATIONS**

Sanja LAZIC, Dragana SUNJKA, Slavica VUKOVIC ..... 1301

**CHEMICAL CONTROL OF DOWNY MILDEW (*Bremia lactucae* Regel) ON LETTUCE**

Slavica VUKOVIĆ, Nemanja BRZAKOVIĆ, Sanja LAZIĆ, Dragana ŠUNJKA, Antonije ŽUNIĆ..... 1306

**COMPARATIVE ANALYSIS OF GROWTH INHIBITION OF *FUSARIUM OXYSPORUM* CAUSED BY *PSEUDOMONAS* SPP. AND *BACILLUS SUBTILIS***

Goran ALEKSIĆ, Slobodan KUZMANOVIĆ, Mira STAROVIĆ, Magdalena KNEŽEVIĆ, Dragana JOŠIĆ..... 1313

**PHYSICAL AND CHEMICAL QUALITY PARAMETERS OF HONEY FROM CENTRAL SERBIA**



- Goran JEVTIĆ, Bojan ANĐELKOVIĆ, Snežana BABIĆ, Dragoslav ĐOKIĆ, Nebojša NEDIĆ, Kazimir MATOVIĆ, Nada PLAVŠA ..... 1318
- EFFECT OF DRYING MODE ON THE CHANGES OF VIRGINIA TOBACCO TYPE CHEMICAL COMPOSITION**
- Gordana KULIĆ, Vesna RADOJIČIĆ, Nemanja MANDIĆ, Maja MALNAR..... 1327
- EFFECTIVENESS OF *PSEUDOMONAS CHLORORAPHIS* K24 AGAINST *RHIZOCTONIA ZEA* ISOLATED FROM CORIANDER SEEDS**
- Dragana JOŠIĆ, Snežana PAVLOVIĆ, Mira STAROVIĆ, Magdalena KNEŽEVIĆ, Aleksandra STANOJKOVIĆ-SEBIĆ, Radmila PIVIĆ ..... 1333
- EFFECT OF CASING AND TOASTING REGIME ON BURLEY TOBACCO TYPE COMPOSITION**
- Maja MALNAR, Vesna RADOJIČIĆ, Nemanja MANDIĆ, Gordana KULIĆ, Marija SRBINOSKA ..... 1339
- EFFECTS OF SULFONYLUREA HERBICIDES ON INORGANIC PHOSPHORUS IN MAIZE LINES**
- Milan BRANKOV , Vesna DRAGIČEVIĆ, Milena SIMIĆ, Miodrag TOLIMIR, Jelena MESAROVIĆ ..... 1345
- FIRST REPORT OF THE NATURAL OCCURRENCE OF THE TELEOMORPH OF LEPTOSPHERIA MACULANS ON OILSEED RAPE IN SERBIA**
- Petar MITROVIĆ, Ana MARJANOVIĆ–JEROMELA ..... 1350
- THE EFFECTS OF IRRIGATION ON THE STRUCTURAL STABILITY OF MICROAGGREGATES AND THE RISK OF SOIL CRUSTING IN THE MORAVICA ADMINISTRATIVE DISTRICT IN THE REPUBLIC OF SERBIA**
- Radmila PIVIĆ, Zoran DINIĆ, Jelena MAKSIMOVIĆ, Dragana JOŠIĆ, Aleksandra STANOJKOVIĆ-SEBIĆ..... 1358
- PRELIMINARY IDENTIFICATION OF EUROPEAN CORN BORER PHEROMONE RACES AND FLIGHT DYNAMICS IN BEČEJ, NORTHERN SERBIA**
- Snežana TANASKOVIĆ, Branka POPOVIĆ, Sonja GVOZDENAC, Zsolt KARPÁTI, Csengele BÓGNAR, Matthias ERB..... 1366
- PLANT PATHOGENIC FUNGI CAUSERS: FUNGAL DISEASES OF THE HAIRY VETCH IN SERBIA**
- Tanja VASIĆ, Vesna KRNJAJA, Snežana BABIĆ, Jordan MARKOVIĆ, Jasmina MILENKOVIĆ, Dragan TERZIĆ, Sanja ŽIVKOVIĆ..... 1372
- ESSENTIAL OILS AS AN ALTERNATIVE BACTERICIDES AGAINST SOFT-ROT BACTERIA, *PECTOBACTERIUM CAROTOVORUM* SUBSP. *CAROTOVORUM***
- Tatjana POPOVIĆ, Igor KOSTIĆ, Zoran MILIĆEVIĆ, Katarina GAŠIĆ, Miroslav KOSTIĆ, Marina DERVIŠEVIĆ, Slobodan KRNJAJIĆ..... 1377
- POSSIBILITY OF DRYING BURLEY TOBACCO TYPE IN A SOLAR DRYER**
- Vesna RADOJIČIĆ, Gordana KULIĆ, Nemanja MANDIĆ, Maja MALNAR, Nermina ĐULANČIĆ ..... 1384
- ALOE VERA PLANT: CHEMICAL ANALYSIS**

Francisco Javier TOLEDO MARANTE, Ruggero ZENI, Julio Alberto TOLEDO MEDIAVILLA .....	1391
<b>EXPERIMENTAL MANUFACTURING OF KOURDASS, A TRADITIONAL SALTED DRIED MEAT PRODUCT</b>	
Sanâa CHERROUD, Abdelhay ARAKRAK, Maryam BENBACHIR, Mohammed BAKKALI, Amin LAGLAOUI, Sidonia MARTÍNEZ, Lucía GÓMEZ-LIMIA, Inmaculada FRANCO, Noemi COBAS .....	1398
<b>CHEMICAL COMPOSITION OF ESSENTIAL OIL OF ANISE, CUMIN, FENNEL AND PARSLEY SEEDS</b>	
Guilles FIGUEREDO, Fahad AL JUHAIMI, Pierre CHALARD, Mehmet Musa ÖZCAN, Jean Claude CHALCHAT .....	1404
<b>ANTIFUNGAL EFFECT OF SALVIA SCLAREA L. ESSENTIAL OIL ON GROWTH OF FUSARIUM OXYSPOURUM F. SP.RADICIS-LYCOPERSICI JARVIS &amp; SHOEMAKER AND VERTICILLIUM DAHLIAE (KLEB.)</b>	
Melih YILAR, Yusuf BAYAN .....	1409
<b>MORPHOLOGICAL AND MOLECULAR IDENTIFICATION OF <i>FUSARIUM</i> spp. CAUSING DISEASES IN STRAWBERRY</b>	
Müge DOĞANER, Mahmood AYYAZ, Sibel DERVIŞ, Çiğdem ULUBAŞ SERÇE	1414
<b>A SURVEY STUDY: PEST PROBLEMS AND PEST MANAGEMENT STRATEGIES OF FARMERS IN BURSA PROVINCE (TURKEY)</b>	
Nabi Alper KUMRAL, Gözde KILINC, Aykut SELVI, Beyza Nur OZDEMIR, Bilge Ece UNVEREN, Halil İbrahim BOZOGULLARI, Harun DEMIREL, Mert DEMIREL, Pinar BALTA, Sertac PAT, Ugur Deniz KOCAK .....	1421
<b>FIELD RESPONSE OF BUPRESTID BEETLE, <i>ANTHAXIA (ANTHAXIA) ANATOLICA ANATOLICA</i> CHEVROLAT, TO SYNTHETIC SEMIOCHEMICALS</b>	
Nimet Sema GENÇER, İrem ALTIN, Nabi Alper KUMRAL, Bilgi PEHLEVAN ....	1427
<b>POSTHARVEST QUALITY OF NON-ASTRINGENT ‘FUYU’ PERSIMMON FRUITS AS AFFECTED BY DIFFERENT DOSES OF 1- METHYLCYCLOPROPENE (1-MCP)</b>	
Adem DOGAN, Qasid ALI, Mehmet Seckin KURUBAS, Mustafa ERKAN .....	1433
<b>IMPACT OF DIFFERENT DOSES OF 1-METHYLCYCLOPROPENE (1-MCP) ON POSTHARVEST QUALITY OF ASTRINGENT ‘HACHIYA’ PERSIMMONS</b>	
Qasid ALI, Adem DOGAN, Mehmet Seckin KURUBAS, Mustafa ERKAN .....	1442
<b>IDENTIFICATION OF WEED SEEDS CONTAMINATING WHEAT GRAIN</b>	
Sibel UYGUR .....	1451
<b>PRETREATMENT INFLUENCE ON THE DRYING RATE AND BIOACTIVE COMPOUNDS OF DRIED FIGS</b>	
Luziana HOXHA, Renata KONGOLI .....	1455
<b>WHY <i>APHIS SPIRAECOLA</i> (HEMIPTERA: APHIDIDAE) IS BECOMING THE MOST DOMINANT PEST ON CITRUS IN ALGERIA?</b>	
Zine Eddine LABDAOUI, Yamina GUENAOUI.....	1461

**TEXTURAL PROPERTIES OF WHITE CHEESE MADE OF INFRA RED PASTEURIZED MILK AND AGED IN POTASSIUM CHLORIDE (KCL) SUBSTITUTED BRINE**

Simin HAGH NAZARI, Mohammad Reza AZIMI, Sajjad VALINEZHAD..... 1469

**CORRELATION BETWEEN INDIGENOUS AND COMMERCIAL STRAINS OF YEAST IN THE PRODUCTION OF WINE FROM THE GRAPE VARIETY VRANEC**

Kire PETROV, Fidanka ILIEVA, Violeta DIMOVSKA, Nataša GUNOVA ..... 1477

**PATHOGENICITY OF CONIELLA MUSAIENSIS VAR. HIBISCI, A CAUSAL AGENT OF ROSELLE LEAF SPOT DISEASE IN MAKURDI, CENTRAL NIGERIA**

Kparev-wua David APEYUAN; Okechukwu Alphonso NWANKITI; Apeh Ocheigwu Hyacinth OLUMA, Ebenizer Jonathan EKEFAN ..... 1484

**OVERVIEW OF LEAF MINER FAUNA IN SERBIA**

Jovan DOBROSAVLJEVIC, Cedomir MARKOVIC, Stefan BOJIC ..... 1490

**TOTAL BETA ACTIVITY, POTASSIUM-40 ACTIVITY AND RESIDUAL BETA ACTIVITY IN DIFFERENT CORN-BASED FOOD SAMPLES**

Željko MIHALJEV, Sandra JAKŠIĆ, Brankica KARTALOVIĆ, Milica ŽIVKOV-BALOŠ..... 1499

**DETERMINATION OF FOOD PURCHASING PREFERENCES OF CONSUMERS USING ROBUST FACTOR ANALYSIS**

Koksal KARADAS, Yakup Erdal ERTURK, Ayca Nur SAHIN ..... 1504

**WHITE CHEESE PHYSICOCHEMICAL PROPERTIES MADE OF IR PASTEURIZED MILK RIPENED IN KCL SOLUTION**

Simin HAGH NAZARI, Mohammad Reza AZIMI, Sajjad VALINEZHAD..... 1509

**BIONOMY OF PEAR PSYLLA (CACOPSYLLA PYRI L.) IN EAST SARAJEVO AREA (BOSNIA AND HERZEGOVINA)**

Dejana TEŠANOVIĆ, Radoslava SPASIĆ..... 1517

**DISTRIBUTION MAPPING OF SELECTED INVASIVE WEED SPECIES IN NORTH WESTERN AREA OF REPUBLIC OF SRPSKA (BOSNIA AND HERZEGOVINA)**

Gordana BABIĆ, Vojislav TRKULJA..... 1524

**HERBICIDE EFFICIENCY TESTING IN SOYBEAN DURING 2014–2016**

Gordana BABIĆ, Bojana ĆURKOVIĆ, Vojislav TRKULJA, Miloš NOŽINIĆ, Vesna BOJIĆ, Drago SPREMO..... 1531

**WHITE CHEESE PHYSICOCHEMICAL PROPERTIES MADE OF INFRA RED PASTEURIZED MILK AND AGED IN POTASSIUM CHLORIDE (KCL) SUBSTITUTED BRINE**

Simin HAGH NAZARI, Mohammad Reza AZIMI, Sajjad VALINEZHAD..... 1538

**SEASONAL DYNAMICS OF AERO-ALERGENIC RAGWEED POLLEN IN BANJA LUKA (BOSNIA AND HERZEGOVINA) DURING 2012-2016**

Gordana BABIĆ, Bojana ĆURKOVIĆ, Vojislav TRKULJA ..... 1546

<b>CONTRIBUTION TO KNOWLEDGE OF THE MORPHOLOGY AND BIOLOGY OF PEAR SHOOT SAWFLY (<i>Janus compressus</i> Fabricius)</b>	
Dragana KOVAČIĆ JOŠIĆ, Radmila ALMAŠI, Vojislav TRKULJA .....	1551
<b>OCCURRENCE OF FUSARIUM HEAD BLIGHT IN CONDITIONS OF NATURAL INFECTION IN WINTER WHEAT AND EFFICIENCY OF APPLIED FUNGICIDE</b>	
Vojislav TRKULJA, Gordana BABIĆ, Bojana ĆURKOVIĆ, Dragan MANDIĆ, Goran ĐURAŠINOVIĆ .....	1557
<b>EFFICACY OF NEW HERBICIDES AND HERBICIDE COMBINATIONS ON MILK THISTLE (<i>SILYBUM MARIANUM</i> GAERTN.)</b>	
Grozi DELCHEV, Teodora BARAKOVA .....	1564
<b>THE SPECIES OF SUPERFAMILY ICHNEUMONOIDEA – PARASITES OF APHIDOPHAGOUS HOVERFLIES</b>	
Vesna KRSTESKA, Stanislava LAZAREVSKA .....	1570
<b>ALLELOPATHIC EFFECTS OF ALIEN INVASIVE PLANTS</b>	
Snežana TANASKOVIĆ, Branka POPOVIĆ, Vesna DJUROVIC, Milos MARJANOVIC, Goran DRASKOVIC .....	1576
<b>A BIOCHEMICAL AND THERMO-RHEOLOGICAL ANALYSIS OF SPANISH ARTISAN CHEESE</b>	
Lorena PIÑEIRO, Clara A. TOVAR, Inmaculada FRANCO.....	1581
<b>PROTEIN CONTENT AND TOTAL AMINO ACID PROFILE OF THE MUSCLE AND SKIN OF THE EUROPEAN EEL (<i>Anguilla anguilla</i>)</b>	
Lucía GÓMEZ-LIMIA, Noemi COBAS, Raúl BORRAJO, Sidonia MARTÍNEZ, Inmaculada FRANCO .....	1587
<b>SAFFRON AS A FUNCTIONAL FOOD FOR TREATING DISEASE BY HOMEOPATHIC WAY</b>	
Simin Hagh NAZARI, Mohammad HASSAN-SADEGHI, Sarina Rezaei SHOJAEI, Sara Rezaei SHOJAEI.....	1593
<b>3. ORGANIC AGRICULTURE.....</b>	<b>1599</b>
<b>IMPACT OF THE DIFFERENT FERTILIZER-SYSTEMS OF FERTILIZERS ON THE AGGREGATE COMPOSITION IN THE ALLUVIAL-MEADOW FOREST AND MEADOW-BROWN SOILS FROM AZERBAIJAN DRY SUBTROPICS</b>	
Goshgar Maharram MAMMADOV.....	1600
<b>IMPACT OF SPECIAL HERBAL PREPARATION ON YIELD OF CABBAGE AND LETTUCE ON SANDY SOILS</b>	
Srdjan LJUBOJEVIC .....	1606
<b>THE EFFECT OF APPLYING A TARGETED POLICY FOR DEVELOPMENT OF ORGANIC FARMING IN BULGARIA</b>	
Monika SABEVA .....	1612
<b>EVALUATION OF GENETIC POTENTIAL FOR ENVIRONMENTAL PLASTICITY OF MALTING BARLEY BREEDING LINES</b>	
Marina MARCHEVA, Silviya VASILEVA, Nevena GANUSHEVA .....	1618

**THE CAUSAL ANALYSIS OF FARMERS' ATTITUDES TOWARDS ADOPTION OF ORGANIC FARMING PRACTICES: EVIDENCE FROM TURKEY**

Nuray ÇAKIRLI, Ludwig THEUVSEN ..... 1624

**YIELD PRODUCTIVITY OF SAGE (*SALVIA OFFICINALIS* L.) ORGANIC CULTIVATION UNDER DIFFERENT WATER AND NITROGEN INPUTS AND PLANT POPULATIONS IN CENTRAL GREECE: FIRST YEAR RESULTS**

Faik KAMPERLLARI, Elpiniki SKOUFOGIANNI, Kyriakos D. GIANNOULIS, Dimitrios BARTZIALIS, Nicholaos G. DANALATOS ..... 1631

**FERTILITY PARAMETERS REFORMATION OF SOD-PODZOLIC SOILS IN THE URAL REGION AS INFLUENCED BY FERTILIZERS APPLICATION AND LANDSCAPER TYPES.**

Antonina KOSOLAPOVA, Denis FOMIN, Konstantin KORLYAKOV, Valery VOZZHAEV ..... 1637

**SPELT AS ORGANIC RAW MATERIAL FOR PRODUCTION OF EXTRUDED PRODUCTS**

Jelena FILIPOVIĆ, Vladimir FILIPOVIĆ, Milenko KOŠUTIĆ ..... 1642

**WINTER GREENHOUSE VEGETABLE PRODUCTION ENHANCED BY THE BROWN SEAWEED EXTRACTS**

Milan UGRINOVIĆ, Zdenka GIREK, Suzana PAVLOVIĆ, Đorđe MORAVČEVIĆ, Gordana DOZET, Marija SPASIĆ, Bogoljub ZEČEVIĆ ..... 1647

**INFLUENCE OF ORGANIC FERTILIZATION ON THE BIOCHEMICAL COMPOSITION OF FRESH AND DRIED FRUITS OF JAPANESE QUINCE (*CHAENOMELES* SP.)**

Teodora MIHOVA, Diyan GEORGIEV, Boryana BRASHLYANOVA, Petya IVANOVA ..... 1654

**DETERMINATION OF VERMICOMPOST AND AMMONIUM NITRATE APPLICATIONS EFFECTIVENESS ON BROCCOLI WITH SOIL AND LEAF ANALYSES**

Ali ZAHMACIOĞLU, Yeşim AHİ, Korkmaz BELLİTÜRK ..... 1660

**4. ENVIRONMENT PROTECTION AND NATURAL RESOURCES MANAGEMENT ..... 1666**

**GEOMORPHOLOGY AND WATER QUALITY OF THE COASTAL LAGOONS OF ALBANIA**

Elvin ÇOMO, Albana HASIMI, Jakup HOXHAI, Bashkim LUSHAJ ..... 1667

**SOIL CHARACTERISTICS AND VEGETATION DIVERSITY IN RESPONSE TO HEAVY GRAZING ON MEDITERRANEAN PASTURES ALONG THE SHORES OF LAKE OUBEÏRA (ALGERIA)**

Ali SLIMANI, Kahina HOUD, Amar MEBARKIA ..... 1674

**CHARACTERIZATION OF THE PHYSICO-CHEMICAL AND BACTERIOLOGICAL QUALITY OF DAIRY CATTLE WATERING IN EL TARF, ALGERIA**

Samira KADRI, Kahina HOUD, Ali SLIMANI, Abdesatar LAADJAL, Hicheme NASRI ..... 1684

**MONITORING AND ASSESSMENT OF PHYSICOCHEMICAL PARAMETERS OF SOILS AND COALS USED IN BRICK KILNS AND THEIR IMPACT ON HEALTH AND ENVIRONMENT**

Md. Azharul ISLAM<sup>1</sup>, Mst. Rokaiya HASINA, Premangshu MAJUMDER<sup>2</sup>, Md. Tanvir HOSSAIN, Rehana KHATUN..... 1689

**SOURCES OF HEAVY METALS AND THEIR INFLUENCE ON THE SOIL**

Neda TEŠAN TOMIĆ, Slavko SMILJANIĆ, Vesna TUNGUZ ..... 1697

**ENVIRONMENTAL ASPECTS IN CULTIVATION OF PAULOWNIA IN BULGARIA**

Avgusta STEPCHICH..... 1704

**ECO-BIOLOGICAL CHARACTERISTICS OF MEDICINAL PLANTS IN PROTECTION ZONE "YAZOVIR KONUSH" VILLAGE KONUSH (BULGARIA)**

Stoyan GEORGIEV, Koycho KOEV, Alexander TASHEV ..... 1710

**COMPARISON OF MULTIVARIATE CALIBRATION METHODS FOR PREDICTING SOIL ORGANIC CARBON WITH VIS-NIR SPECTROSCOPY**

Boško MILOŠ, Aleksandra BENSA ..... 1716

**STATUS OF UNDERGROUND DRAINAGE IN EASTERN CROATIA AND DRAINED SOIL IMPROVEMENT BY AGROAMELIORATION**

Dragutin PETOSIC, Vlado KOVACEVIC, Jasna SOSTARIC, Ivan MUSTAC ..... 1722

**IMPACT OF AGRICULTURAL PRACTICES AND URBANIZATION ON GROUND INVERTEBRATE FAUNA IN SUEZ CANAL REGION, EGYPT**

Esraa S. HAMDY ..... 1728

**EFFECT OF HIVE BUILDING MATERIAL ON BEE COLONIES**

Mohamed Ali Ibrahim AL-RAJHI ..... 1736

**RECOLONIZATION OF CULTURAL LANDSCAPES BY LARGE PREDATORS: CHALLENGES AND RECOMMENDATIONS USING GREY WOLF (*CANIS LUPUS*) AS AN EXAMPLE**

Sven HERZOG..... 1744

**EVALUATION OF AN INDICATOR FOR THE RISK OF DIFFUSE PHOSPHORUS LOSSES IN NORTHEAST GERMANY**

Uwe BUCZKO ..... 1751

**EFFECTS OF TILLAGE METHODS AND NITROGEN FERTILIZATION ON THE PRODUCTION OF SIX ENERGY CROPS**

Maria KOKKORA, Dimitrios KALFOUNTZOS, Theofanis GEMTOS ..... 1757

**UNLIMITED USE OF IRRIGATION WATER RESOURCES IN ARID AND SEMI-ARID REGIONS OF IRAN: NO-WIN COMPETITION**

Marzieh KESHAVARZ ..... 1763

**PROMISING AMMONIA MITIGATION OPTIONS IN LATVIA'S AGRICULTURE**

Ligita MELECE ..... 1769

**A QUALITATIVE METHOD FOR DETERMINATION OF NICOTINE IN LITTERED CIGARETTE BUTTS**

Marija SRBINOSKA, Vesna RADOJIČIĆ, Nermina ĐULANČIĆ, Stefka KIRKOVA ..... 1776

**CONSEQUENCES OF FUTURE EXPANSION AT THE ARCTIC TREELINE IN NORTHERNMOST NORWAY**

Oddvar SKRE, Stein Rune KARLSEN, Jan Åge RISETH, Frans E. WIELGOLASKI ..... 1782

**SHEAR STRENGTH OF THE SELECTED COAL MINING WASTES**

Andrzej GRUCHOT, Eugeniusz ZAWISZA, Gabriela CISEK, Tymoteusz ZYDRON ..... 1790

**NATURAL EVALUATION OF RURAL NASIELSK COMMUNE AREA FOR LANDSCAPE MANAGEMENT IN TOURISTIC ASPECT (POLAND)**

Beata FORNAL-PIENIAK ..... 1796

**SPECIES RESTITUTION – A WAY TO IMPROVE FLORISTIC DIVERSITY OF MEADOW COMMUNITIES IN „SKARPA URSYNOWSKA” NATURE RESERVE (POLAND)**

Maria JANICKA, Bogumiła PAWLUŚKIEWICZ ..... 1800

**TESTING THE RAPID IDENTIFICATION SYSTEM AS AN INNOVATIVE TOOL FOR ENVIRONMENTAL ASSESSMENT OF FARMS**

Jerzy Mirosław KUPIEC ..... 1808

**PLANT BENEFICIAL BACTERIAL STRAIN WITH PHC DECONTAMINATING POTENTIAL**

Daria-Gabriela POPA, Oana-Alina BOIU-SICUIA, Roxana DUDOIU ..... 1816

**CONTRIBUTION TO THE KNOWLEDGE OF THE BIOLOGICAL CYCLE OF THE LEAF MINING MOTH CAMERARIA OHRIDELLA DESCHKA DIMIC SPECIES**

Miha TĂLMACIU , Nela TĂLMACIU , Carmen MIROIU , Ionela MOCANU ..... 1822

**EFFECT OF SOME HERBICIDES ON CELLULOSE DECOMPOSITION IN THE SOIL**

Dragutin ĐUKIĆ, Aleksandra STANOJKOVIĆ-SEBIĆ, Leka MANDIĆ, Marijana PEŠAKOVIĆ, Vesna ĐUROVIĆ, Milica ZELENKA, Ivana BOŠKOVIĆ ..... 1828

**THE ORIGIN AND CONTENT OF Ni IN VERTISOL FROM SERBIA AND PLANTS AVENA SATIVA L.**

Jelena MILIVOJEVIĆ, Vera ĐEKIĆ, Ljiljana BOŠKOVIĆ RAKOČEVIĆ, Zoran SIMIĆ, Kristina LUKOVIĆ ..... 1833

**INFLUENCE OF FERTILIZATION AND LIMING ON CHANGES OF AGROCHEMICAL CHARACTERISTICS OF SOIL TYPE PSEUDOGLEY**

Miodrag JELIĆ, Vera ĐEKIĆ, Ivica ĐALOVIĆ, Goran DUGALIĆ, Desimir KNEŽEVIĆ, Nebojša GUDŽIĆ ..... 1839

**AGRO-ECOLOGICAL CONDITIONS OF FRUIT GROWING IN THE PEŠTER (PLATEAU) REGION**

Mira MILINKOVIĆ, Olga MITROVIĆ, Žaklina KARAKLAJIĆ STAJIĆ, Jelena TOMIĆ, Svetlana M. PAUNOVIĆ, Miodrag KANDIĆ, Rade MILETIĆ ..... 1846

**PROSPECTS FOR USING SUDAN GRASS AS A SOURCE OF RENEWABLE ENERGY**

Snežana JANKOVIĆ, Jela IKANOVIĆ, Ljubiša KOLARIĆ, Ljubiša ŽIVANOVIĆ, Vera POPOVIĆ, Gordana DRAŽIĆ, Sveto RAKIĆ, Vojislav TRKULJA ..... 1853

**THE ROLE OF FOREST ECOSYSTEMS IN THE RISK MANAGEMENT OF TORRENTIAL FLOODS (THE GRDELICA GORGE IN SERBIA)**

Sonja BRAUNOVIĆ, Mihailo RATKNIĆ, Ljubinko RAKONJAC..... 1860

**EFFECT OF THE LOCALITY OF GROWING ON SWEET MAIZE PRODUCTION IN REPUBLIKA SRPSKA**

Jela IKANOVIĆ, Sveto RAKIĆ, Snežana JANKOVIĆ, Vojislav TRKULJA, Gordana DRAŽIĆ ..... 1866

**ECONOMIC ASPECTS OF FLOOD CONTROL IN AUTONOMOUS PROVINCE OF VOJVODINA (SERBIA): CASE STUDY FOR THE RIVER SAVA**

Svetlana POTKONJAK, Tihomir ZORANOVIĆ, Ksenija MAČKIĆ, Zoran GREGOROVIĆ, Srđan NIKOLETIĆ ..... 1874

**EFFECT OF INVASIVE SPECIES *IMPATIENS PARVIFLORA* ON SOIL MICROBIAL INDICES IN THE PROTECTED AREAS IN SLOVAKIA**

Lenka BOBUŠKÁ, Lenka DEMKOVÁ ..... 1880

**THERMOPHILIC BIOMETHANIZATION OF AGRICULTURAL WASTE IN CODIGESTION: EFFECT OF PESTICIDES**

Juana FERNÁNDEZ-RODRÍGUEZ, Beatriz DE DIEGO-DÍAZ, Francisco Javier PEÑAS ..... 1886

**EFFECT OF NUTRIENTS ON BIOMETHANIZATION OF AGRICULTURAL WASTE: STUDY OF TEMPERATURES**

Beatriz DE DIEGO-DÍAZ, José Manuel Alejandro CERDÁN, Francisco Javier PEÑAS, Juana FERNÁNDEZ-RODRÍGUEZ..... 1892

**EVOLUTION OF SOME EDAPHIC PROPERTIES IN AN AGRICULTURAL SOIL AFTER ITS CHANGE OF USE - RAINFED TO IRRIGATED**

Antonio SÁNCHEZ NAVARRO, Juan SÁNCHEZ MARTÍNEZ, María José DELGADO INIESTA ..... 1897

**EXPLORING THE USE OF SWAT TO MODEL A SMALL MARLY AGRICULTURAL CATCHMENT IN TUNISIA**

Insaf MEKKI, Rim ZITOUNA CHEBBI, Najet SOUISSI, Frédéric JACOB', Damien RACLOT' ..... 1904

**THE DETERMINATION AND LIMITATION OF AMMONIA LOSSES FROM UREA FERTILIZERS WITHIN SOILS BY USING DIFFERENT ORGANIC MATERIALS**

Ali Rıza DEMIRKIRAN ..... 1911

**THE USE OF SOME WASTES IN *PRIMULA VULGARIS* CULTIVATION**

Ebru YÖN, Özgür KAHRAMAN ..... 1917

**COMPREHENSIVE EVALUATION OF IRRIGATION SCHEMES: A CASE STUDY IN SEYHAN AND CEYHAN RIVER BASINS IN TURKEY**

Fatih BARUTÇU, Yunus BÜLBÜL ..... 1923



<b>SATURATED HYDRAULIC CONDUCTIVITY OF ANATOLIAN SOILS</b>	
Gülay KARAHAN, Sabit ERŞAHİN Ahmet Sami EROL .....	1932
<b>THE EFFECT OF SALINITY ON SEED GERMINATION PERFORMANCE OF TEDERA</b>	
Gülcan KAYMAK, Zeki ACAR .....	1939
<b>THE EFFECTS OF CUTTING FREQUENCY ON BOTANICAL AND QUALITY TRAITS OF A LOWLAND PASTURE</b>	
Çaglayan CANDAN, İlknur AYAN, Mehmet CAN, Zeki ACAR .....	1944
<b>EVALUATION OF DIFFERENT AGRICULTURAL PRODUCTION SYSTEMS AND ENVIRONMENT RELATIONSHIP APPROACHES</b>	
Makbule Nisa MENCET YELBOGA, Cengiz SAYIN .....	1950
<b>DETERMINATION OF RELATIONSHIPS AMONGST THE ALTITUDE, GROWING CHARACTERISTICS AND YIELD FOR TEDERA</b>	
Zeki ACAR, Mehmet CAN, Celal BAYRAM, Elif ÖZTÜRK, İlknur AYAN .....	1954
<b>IMPACTS OF ROW SPACING AND SOWING DATE ON FORAGE COWPEA (<i>Vigna unguiculata</i> L. Walp.) HAY YIELD AND QUALITY</b>	
İlknur AYAN, Mehmet CAN, Hanife MUT, Zeki ACAR .....	1959
<b>A RESEARCH ON POMEGRANATE (<i>Punica granatum</i> L.) GROWING AND THE STATE OF SELECTION STUDIES IN TURKEY</b>	
Mikdat ŞİMŞEK, Ersin GÜLSOY .....	1965
<b>EVALUATION OF AGRICULTURAL ENVIRONMENT INDICATORS WITHIN THE SCOPE OF AGRICULTURAL SUSTAINABILITY</b>	
Tuba BEŞEN, Emine OLHAN .....	1971
<b>ACETAMEPRID TOXICITY ON LIVER STRUCTURE IN MALE ALBINO MICE</b>	
Leila SAADI, Sarra LAMRANI, Rafika MATALLAH .....	1980
<b>SCIENCE AND TECHNOLOGY INNOVATION FOR SUSTAINABLE DEVELOPMENT</b>	
Atef HAMDY, Nouredin DRIOUECH, Adel ALY .....	1986
<b>ROLE OF TREES IN AGRICULTURAL LANDSCAPE</b>	
Ewa ZARAŚ-JANUSZKIEWICZ, Barbara ŻARSKA, Tatiana SWOCZYNA .....	1996
<b>MERCURY BELONGS TO HEAVY METALS WITH A NEGATIVE IMPACT ON THE ENVIRONMENT</b>	
Hanna JAWORSKA, Joanna NOWAK, Katarzyna MATUSZCZAK .....	2007
<b>COMPARISON OF MEASURED AND SIMULATED EC OF SOIL WATER IN RELATION WITH IRRIGATION WATER SALINITY AND LEACHING RATIO</b>	
Engin YURTSEVEN, M. Sevba ÇOLAK, Sertan AVCI, Hasan S. ÖZTÜRK, Ahmet ÖZTÜRK, Jiri ŠIMŮNEK .....	2013
<b>THE EFFECTS OF IRRIGATION WATER SALINITY AND LEACHING FRACTIONS ON SAR COMPONENTS OF SOIL SOLUTION IN LYZIMETER CONDITIONS</b>	
Engin YURTSEVEN, Sertan AVCI, M. Sevba ÇOLAK, Hasan S. ÖZTÜRK, Ahmet ÖZTÜRK, Jiri ŠIMŮNEK .....	2023

<b>THE ECONOMIC IMPACT OF CLIMATE CHANGE ON AGRICULTURAL WATER DEMAND IN FRANCE</b>	
Pierre-Alain JAYET, Delphine BARBERIS, Pierre HUMBLLOT .....	2032
<b>FARMERS' ATTITUDES AND BEHAVIORAL INTENTIONS TOWARDS BIODIVERSITY CONSERVATION: THE CASE OF FARAS PROVINCE, IRAN</b>	
Hamideh MALEKSAEIDI, Marzieh KESHAVARZ .....	2039
<b>GREEN AREA PERFORMANCE OF SOME COOL SEASON TURFGRASSES PLANTED WITH DIFFERENT SEEDING RATIOS</b>	
Ilknur AYAN, Asunan SAYGIN, Mehmet CAN, Hanife MUT, Zeki ACAR .....	2044
<b>IMPORTANCE OF IRRIGATION AND SOIL PROCESSING FOR GRAPEWINE CULTIVATION YIELD</b>	
Funda DÖKMEN, Okan KARAMAN .....	2049
<b>WATER HARVESTING TECHNIQUES FOR CONSERVATION OF SOIL AND WATER EROSION</b>	
Meryem KUZUCU, Funda DÖKMEN, Ayşe GÜNEŞ .....	2054
<b>5. ANIMAL HUSBANDRY .....</b>	<b>2061</b>
<b>ECONOMIC ANALYSIS OF THE IMPACT OF FEEDING FACTORS IN MILK PRODUCED FROM HOLSTEIN DAIRY COWS IN KOSOVO</b>	
Fatos KRASNIQI, Muhamet KAMBERI, Enkelejda EMIRI-SALLAKU, Ragip KASTRATI, Myqerem TAJAJ .....	2062
<b>EFFECTS OF THE INCORPORATION OF BARLEY BREWERS AND LOCAL DEHYDRATED ORANGE PULP INTO THE RATION ON THE GROWTH OF BROILER CHICKENS (ALGERIA)</b>	
Rafik ARBOUCHE, Yasmine ARBOUCHE, Achour MENNANI .....	2069
<b>NUTRITIVE VALUE OF THE ATRIPLEX (<i>ATRIPLEX HALIMUS L.</i>), FOLLOWING THE PHENOLOGICAL MARKERS, IN STEPPE AREA (ALGERIA)</b>	
Yasmine ARBOUCHE, Rafik ARBOUCHE, Achour MENNANI .....	2076
<b>WEIGHT PRODUCTIVITY AND NUTRITIVE VALUE OF GRASSLANDS: CASE OF MARSHY AREAS IN NORTH-EASTERN ALGERIA</b>	
Fodil ARBOUCHE, Yasmine ARBOUCHE, Achour MENNANI .....	2082
<b>PRODUCTIVITY AND NUTRITIVE VALUE OF FOREST PASTURES IN NORTH-EASTERN ALGERIA</b>	
Halima Saâdia ARBOUCHE, Yasmine ARBOUCHE, Achour MENNANI .....	2088
<b>EFFECT OF CORTISOL LEVEL AND HAIR CHARACTERISTICS ON FERTILITY OF DAIRY COWS IN ALGERIA</b>	
Sara LAMARI, Toufik MADANI, Lynda ALLOUCHE .....	2093
<b>INFLUENCE OF DATE REBUS AND APRICOT KERNEL MEAL ON FATTENING PERFORMANCE OF LOCAL STRAIN RABBITS (ALGERIA)</b>	
Achour MENNANI, Rafik ARBOUCHE, Yasmine ARBOUCHE .....	2099

**EFFECT OF HERBAL SUPPLEMENTATION TO TMR DIET ON LIPID PROFILE OF BLOOD AND MEAT IN SHEEP**

Abdullah Al Sufian SHUVO, Md. Rahat Ahmad REDOY, Mohammad AL-MAMUN ..... 2106

**HISTOLOGY STUDES OF THE OVARIES OF DUBSKA PRAMENKA DURING GRAVIDITY**

Amela KATICA, Nadžida MLAĆO, Kenan PODŽO, Jasmin KATICA, Naida ČUSTO, Selma PILIĆ ..... 2112

**RESULTS OF INCUBATION AND QUALITY OF DAY-OLD CHICKS HATCHED FROM EGGS OF DIFFERENT WEIGHT**

Marinko VEKIĆ, Stoja JOTANOVIĆ, Đorđe SAVIĆ, Mirjana MITRAKOVIĆ ..... 2121

**INCUBATION RESULTS OF BROILER HATCHING EGGS STORED IN DIFFERENT POSITIONS**

Marinko VEKIĆ, Stoja JOTANOVIĆ, Đorđe SAVIĆ, Dragan RAKOVIĆ ..... 2127

**CARCASS QUALITY AND MEAT CHEMICAL COMPOSITION IN TWO LINES OF SLOW GROWING CHICKENS AND THEIR CROSSES**

Teodora POPOVA, Maya IGNATOVA, Evgeni PETKOV ..... 2133

**TWO SIDES OF THE GOLDEN JACKAL: ITS CONTROVERSIAL ROLE IN SOUTHWESTERN HUNGARY**

Agnes CSIVINCSIK, Zsuzsanna RÓNAI, Szilárd SZABÓ, Tamás BALOG, Gábor NAGY ..... 2140

**SIMULATION OF SUSPENDED SEDIMENT LOAD USING ARTIFICIAL NEURAL NETWORK MODEL, CASE STUDY: HARAZ RIVER, IRAN**

Mehdi VAFAKHAH, Shirko EBRAHIMI MOHAMMADI ..... 2145

**EFFECT OF NSP DEGRADING ENZYMES AND PREBIOTICS ON QUALITY AND TEXTURE PROFILE OF LAYING HEN'S EGGS**

Saulius ALJOSIUS, Romas GRUZAUSKAS, Vilma SASYTE, Asta RACEVICIUTE-STUPELIENE, Vilma VILIENE, Agila DAUKSIENE, Aldona MIEZELIENE, Gitana ALENCIKIENE, Guoda STANYTE ..... 2150

**CHEMICAL CHANGES IN LIPID AFTER HEAT TREATMENT FROM DIFFERENT MEAT TYPES**

Mitre STOJANOVSKI, Anita ČAKAROVA, Dzulijana TOMOVSKA, Elena JOSHEVSKA, Gordana DIMITROVSKA ..... 2156

**THE APPLICABILITY OF SELECTED DIAGNOSTIC DEVICES FOR ENHANCING THE WELFARE OF FARMED FALLOW DEER DOES DURING THE REPRODUCTIVE PERIOD**

Pawel JANISZEWSKI, Justyna CILULKO-DOŁĘGA, Katarzyna TAJCHMAN, Marek BOGDASZEWSKI ..... 2162

**THE EFFECT OF ESTRUS SYNCHRONIZATION ON SHEEP FERTILITY AND FATTENING**

Biljana ANĐELIĆ, Dejan GAVRILOVIĆ, Marijana GAVRILOVIĆ, Aleksandra JEVTIĆ, Aleksandar JEVTIĆ ..... 2172

**HOUSING FACILITIES FOR DAIRY COWS ON THE TERRITORY OF THE MUNICIPALITY OF VRNJAČKA BANJA**

Dejan GAVRILOVIĆ, Biljana ANĐELIĆ, Aleksandar JEVTIĆ, Aleksandra JEVTIĆ, Slobodan JEVTIĆ, Marijana GAVRILOVIĆ, Boban KOSTIĆ ..... 2180

**CARBOHYDRATE FRACTIONS OF ENSILED PEA : OAT MIXTURES**

Jordan MARKOVIĆ, Tanja VASIĆ, Mirjana PETROVIĆ, Snežana ANĐELKOVIĆ, Ivica KOSTIĆ, Dragan TERZIĆ, Vladimir ZORNIĆ ..... 2185

**INFLUENCE OF THE SEASON AND STAGE OF LACTATION ON THE MILK PARAMETERS AND UREA CONCENTRATION IN COW MILK**

Ksenija ČOBANOVIĆ; Denis KUČEVIĆ, Miroslav PLAVŠIĆ, Vladan BOGDANOVIĆ ..... 2191

**EFFECT OF AGE OF YOUNG SIMMENTAL BULLS ON THE CLASS CARCASS AND DEGREE OF FAT TISSUE CARCASS COVERING**

Miloš Ž. PETROVIĆ, Radojica D. ĐOKOVIĆ, Milun D. PETROVIĆ, Marko R. CINCOVIĆ, Zoran Ž. ILIĆ, Simeon Ž. RAKONJAC, Neđeljko R. KARABASIL.... 2197

**EFFECT OF USING TRITICALE IN FEED ON PERFORMANCE OF BROILER CHICKS**

Aleksandar JEVTIĆ, Vera ĐEKIĆ, Sreten MITROVIĆ, Dragan TERZIĆ, Aleksandra JEVTIĆ, Boban KOSTIĆ..... 2203

**GENETIC PARAMETERS OF CLAW CONFORMATION IN SLOVAK HOLSTEIN COWS**

Michal VLČEK, Radovan KASARDA..... 2208

**GENETIC IMPROVEMENT OF CATTLE THROUGH LOW DENSITY SNP PANELS**

Nina MORAVČIKOVÁ, Radovan KASARDA, Ondrej KADLEČÍK..... 2212

**THE INFLUENCE OF SPRAYING LAYING HENS WITH TASTE DETERRENTS ON THE PLUMAGE CONDITION AND PRODUCTION TRAITS**

Mojca PANČUR, Dušan TERČIČ, Uroš ŠRAJ, Manja ZUPAN ..... 2220

**USING HERBAL MIXTURES IN DAIRY MILK PRODUCTION AND THEIR EFFECTIVENESS DURING APPLICATION ON GROUP FED DAIRY CATTLE**

Hulusi AKÇAY, Orçun ELBIRLIK..... 2227

**INVESTIGATION OF RELATIONSHIPS BETWEEN SOME CHARACTERISTICS OF HAIR GOATS**

Funda E. ATAÇ, Çiğdem TAKMA, Yakut GEVREKÇİ, Muzaffer ÇEVİK ..... 2233

**EFFECTS OF DIFFERENT GROWING PARAMETERS ON THE GROWTH PARAMETERS OF THE YOUNG GILTHEAD SEA BREAM (*SPARUS AURATA*)**

Sema ÖZTÜRK, Deniz ÇOBAN, Birsen KIRIM, Mehmet GÜLER, Ebru YILMAZ, Cengiz ÖNDER, Serkan İLGAZ..... 2239

**BIOCHEMICAL PROFILE OF OULED DJELLAL EWES WITH SUBCLINICAL PREGNANCY TOXEMIA**

Kahramen DEGHNOUCHE, Maroua AISSAOUI, Majid TLIDJANE, MEZIANE... 2246

**PREVALENCE OF DANGEROUS ZOOSES AMONG WILD CARNIVORES AND FUR ANIMALS OF CAGE MANAGEMENT IN SOME REGIONS OF THE RUSSIAN FEDERATION**

Amina THAKAHOVA, Vera BEREZHKO, Anatoli BITTIROV, Liudmila NAPISANOVA, Olga ZHDANOVA, Iraida OKULOVA ..... 2251

**EFFECT OF SOME EXOGENOUS ENZYMES ON ANIMAL PERFORMANCE OF BROILER IN ALGERIA**

Naima SAHRAOUI, Mohamed HIDER, Mohammed DOUDAH, Jean LUC HORNICK ..... 2256

**INFLUENCE OF ORGANIC AND INORGANIC IRON ON LAYING HENS PRODUCTIVITY AND BLOODS MORPHOLOGICAL COMPOSITION AND PARAMETERS IN BLOOD**

Vilija BUCKIUNIENE, Romas GRUZAUSKAS, Guoda STANYTE..... 2261

**IMPACT OF A PLANT EXTRACT "ORIGANUM MAJORANA" ON THE ZOOTECNICAL PARAMETERS AND THE STATE OF HEALTH OF BROILER IN ALGERIA**

Naima SAHRAOUI, R. LARBI, M. LAKHDARI, M. BRAHIM ERRAHMAN, D. GUETARNI, Jean Luc HORNICK ..... 2267

**DETERMINATION OF COLLAGEN CONTENT IN ALGERIAN CAMEL MEAT**

Naima SAHRAOUI, Guy DEGAND, Mohamed Brahim ERRAHMANI, Babelhadj BAAISSA, Djamel GUETARNI, Antoine CLINQUART, Jean Luc HORNICK..... 2270

**EFFECT OF A MIXTURE OF VEGETABLE EXTRACT ON THE YIELD OF BROILER CHICKENS IN ALGERIA**

Naima SAHRAOUI, Djahida ACHOUR, Houria SAIFI, Karima MEKADEMI, Jean Luc HORNICK ..... 2276

**6. RURAL DEVELOPMENT AND AGRO-ECONOMY..... 2281**

**THE CONTRIBUTION OF GEOGRAPHICAL INDICATIONS IN SUSTAINABLE RURAL DEVELOPMENT (EVIDENCE FROM NORTHERN ALBANIA)**

Roland BARDHI, Ilir KAPAJ..... 2282

**GREEN INTERNET OF THINGS AND GREEN NANOTECHNOLOGY ROLE IN REALIZING SMART AND SUSTAINABLE AGRICULTURE**

Mirjana MAKSIMOVIĆ, Enisa OMANOVIĆ-MIKLIČANIN..... 2290

**CURRENT FUNDING SOURCES FOR AGRICULTURE IN THE ENTITY OF REPUBLIC OF SRPSKA (BOSNIA AND HERZEGOVINA)**

Radomir BODIROGA, Grujica VICO, Goran PERKOVIC ..... 2296

**POTENTIAL AND INSUFFICIENTLY REPRESENTED MODALITIES FOR FINANCING OF AGRICULTURE IN THE ENTITY OF THE REPUBLIC OF SRPSKA (BOSNIA AND HERZEGOVINA)**

Radomir BODIROGA, Grujica VICO, Goran PERKOVIC, Vladimir Vu. YUSHKOV, Andrija TOMIC..... 2302

**TRANSFORMATIONS IN THE GOVERNANCE STRUCTURE OF BULGARIAN AGRICULTURAL COOPERATIVES**

Angel SAROV, Diana KOPEVA.....	2308
<b>PRODUCTION OF BIOACTIVE CONJUGATED LINOLEIC ACID BY LACTIC ACID BACTERIA FROM TRADITIONAL BULGARIAN FERMENTED PRODUCTS</b>	
Galya BLAGOEVA, Angel ANGELOV, Velitchka GOTCHEVA.....	2314
<b>ROLE OF WOMEN IN DECISION MAKING IN THE FIELD OF AGRICULTURE A STUDY AT BIHAR (INDIA)</b>	
Arunima KUMARI, Pooja KUMARI, Richa KUMARI, Kritika .....	2320
<b>INTERNATIONAL NETWORKING FOR RURAL AREAS SUSTAINABLE DEVELOPMENT: THE CASE STUDY OF A.M.A.R.-W.F.A.R.A.</b>	
Adriano CIANI.....	2326
<b>SUSTAINABLE TOURISM AND RURAL AREAS DEVELOPMENT: THE CASE STUDY OF MUNICIPALITY OF SACHKHERE IN GEORGIA</b>	
Adriano CIANI, Meri KHVEDELIDZE, Kumar Prasad BHATTA, Annalisa GAMBARDELLA .....	2333
<b>FOOD WASTE AND LOSSES: INITIATIVES FOR SUSTAINABLE DEVELOPMENT</b>	
Rosalina GRUMO, Simona GIORDANO .....	2340
<b>RURAL POVERTY AND RURAL DEVELOPMENT: A CASE FOR FAMILY FARMING AND SUSTAINABLE TOURISM IN THE NATIONAL PARK of gargano (ITALY)</b>	
Simona GIORDANO .....	2350
<b>ROLE AND IMPORTANCE OF SMALL AGRICULTURAL HOLDINGS IN LATVIA</b>	
Aina DOBELE, Andra ZVIRBULE.....	2359
<b>PERSPECTIVES FOR BEEF CATTLE PRODUCTION AND SALES IN LATVIA</b>	
Andra ZVIRBULE, Aina DOBELE.....	2365
<b>EVALUATION OF LAND USE AND AGRICULTURAL PRODUCTION IN THE DEVELOPMENT AREA OF THE MAJOR CITIES OF LITHUANIA</b>	
Jolanta VALČIUKIENĖ, Daiva JUKNELIENĖ, Virginija ATKOCEVIČIENĖ .....	2372
<b>MODEL OF REGIONAL DEVELOPMENT THROUGH RURAL AREAS AS RURAL ECONOMIC DEVELOPMENT POLES: CASE OF THE REPUBLIC OF MACEDONIA</b>	
Blagoj GORGIEVSKI, Marija GJOSHEVA KOVACHEVIKJ,.....	2379
<b>MANAGERIAL CHALLENGES AND LEADERSHIP IN FUNCTION OF DEVELOPMENT OF MODERN AGRIBUSINESS COMPANIES</b>	
Katerina BOJKOVSKA, Trajan DOJCHINOVSKI, Nikolche JANKULOVSKI, Goran MIHAJLOVSKI, Sasho BOJKOVSKI, Elena JOSHEVSKA .....	2384
<b>INFLUENCE OF GENDER EQUALITY ON SUSTAINABLE DEVELOPMENT OF VILLAGES IN THE REPUBLIC OF MACEDONIA</b>	
Marija GJOSHEVA KOVACHEVIKJ, Blagoj GORGIEVSKI .....	2390

**KALAKALAN SA ANA KALANG: MARKETING STRUGGLES OF FARMERS AND TRADERS IN BRGY. BUKAL, NAGCARLAN, LAGUNA, PHILIPPINES**

Justin Paolo D. INTERNO , Sherry B. MARASIGAN, Kim Lynet E. BERMUDEZ,  
Kevin Throy S. WAGWAG ..... 2396

**SOCIO-CULTURAL ROLE OF GREEN AREAS IN THE RURAL DEVELOPMENT**

Agnieszka JASZCZAK ..... 2403

**THE ROLE OF COOPERATIVE MOVEMENT IN DEVELOPMENT OF RURAL AREAS: A CASE STUDY OF POLAND**

Maria ZUBA-CISZEWSKA ..... 2410

**THE ANALYSIS OF THE PROJECTS IMPLEMENTED BY MEASURE 313, IN TIMIS COUNTY (WEST ROMANIA)**

Adrian BĂNEȘ, Manuela-Dora ORBOI, Tiberiu IANCU, Vasile GOȘA ..... 2417

**IDENTIFICATION OF THE IMPORTANCE OF EUROPEAN PROJECTS IN THE DEVELOPMENT OF RURAL COMMUNITIES IN TIMIS COUNTY, IN ROMANIA**

Manuela-Dora ORBOI, Adrian BĂNEȘ, Ioan PETROMAN, Ioan BRAD..... 2423

**AGRICULTURE - A BASE FOR ECONOMY IMPROVEMENT**

Anja ROSANDIC, Danica MICANOVIC, Vladimir Yu. YUSHKOV, Adriana RADOSAVAC, Snježana GLUMAC, Srdjan ATANASIJEVIC, Desimir KNEZEVIC  
..... 2429

**ANALYSIS OF THE ECONOMIC EFFECTS OF DRIED PLUM PRODUCTION ON FAMILY FARMS**

Mirjana LUKAČ BULATOVIĆ , Dušan MILIĆ, Branka KALANOVIĆ BULATOVIĆ  
..... 2438

**GENERAL MATHEMATICAL MODEL FOR THE LINEAR OPTIMIZATION OF A MULTIFUNCTIONAL FARM**

Nebojša NOVKOVIĆ, Christoph HUSEMANN, Nataša VUKELIĆ..... 2443

**INTAGIBLE ASSETS IN THE RETAIL FOOD**

Radojko LUKIC, Srdjan LALIC, Nedeljko TICA..... 2450

**IMPORTANCE OF THE NON-AGRICULTURAL SECTOR FOR RURAL DEVELOPMENT OF THE AREA OF FRUŠKA GORA (VOJVODINA PROVINCE, SERBIA)**

Sanja ĐUKIĆ, Mirela TOMAŠ-SIMIN, Dunja DEMIROVIĆ..... 2459

**SOCIOECONOMIC CHARACTERISTICS AS A DEVELOPMENT FACTORS OF RURAL AREAS OF AUTONOMOUS PROVINCE OF VOJVODINA (SERBIA)**

Zoran NJEGOVAN, Sanja ĐUKIĆ, Mirela TOMAŠ-SIMIN ..... 2466

**THE POTENTIALS FOR ORGANIC PRODUCTION OF SERBIA AND OTHER EUROPEAN UNION (EU) CANDIDATE COUNTRIES**

Sanja ĐUKIĆ, Mirela TOMAŠ-SIMIN, Janko VESELINOVIĆ ..... 2473

**LAND CONSOLIDATION – A NECESSARY CONDITION AND IMPERATIVE FOR AGRICULTURE PRODUCTION DEVELOPMENT**

Rajko BOŽIĆ, Milan TRIFKOVIĆ, Žarko NESTOROVIĆ, Jelena LAZIĆ .....	2479
<b>AN EVALUATION OF MARKET PARTICIPATION OF SMALLHOLDER FARMERS IN EHLANZENI DISTRICT, MPUMALANGA PROVINCE, SOUTH AFRICA</b>	
Phokele MAPONYA <sup>1</sup> , Sonja Louise VENTER, Christian Philippus DU PLOOY, Erika VAN DEN HEEVER .....	2485
<b>DEVELOPMENT OF THE PROTOTYPE APPLICATION OF A WIRELESS SENSOR NETWORK AND INTERNET OF THINGS FOR GREENHOUSES</b>	
Mehmet Ali DAYIOGLU, Furkan UGUR, Ufuk TURKER .....	2493
<b>MANAGEMENT OF GREENHOUSE CROP GROWTH SYSTEM</b>	
Mehmet Ali DAYIOGLU, Ayten ONURBAS AVCIOGLU.....	2499
<b>DETERMINATION OF NITROGEN STATUS OF SUGAR BEET USING MOBILE OPTICAL SENSOR</b>	
Ufuk TURKER, Uğur YEGÜL, Babak TALEBPOUR .....	2505
<b>CLASSIFICATION OF AGRICULTURAL TRACTORS BASED ON ENERGY EFFICIENCY IN TURKEY</b>	
Ufuk TURKER, Mehmet Ali DAYIOĞLU .....	2513
<b>OPPORTUNITIES AND CHALLENGES FOR THE FRESH STRAW MUSHROOM VALUE CHAIN DEVELOPMENT IN VIETNAM</b>	
HO Thi Minh Hop <sup>1</sup> , Philippe BURNY <sup>2</sup> , Jan HELDER, NGUYEN Huu Hy, NGUYEN Thi My .....	2519
<b>THE NEED FOR INNOVATION POLICY SUPPORT IN AGRI-FOOD SECTOR</b>	
Marcin GOSPODAROWICZ, Adam WASILEWSKI, Marek WIGIER.....	2525
<b>ASSESSING THE EXTERNAL ENVIRONMENT OF PUBLIC EXTENSION SYSTEM IN THE KINGDOM OF SAUDI ARABIA</b>	
Bander M. ALSAGHAN, Ahmed M. DIAB.....	2532
<b>STATE AND PROSPECTS OF RURAL TOURISM DEVELOPMENT IN KOLUBARA DISTRICT (SERBIA)</b>	
Dragan STEVANOVIC.....	2539
<b>FOOD LOSSES AND WASTE IN FRUITS AND VEGETABLE AGRI-FOOD CHAIN IN TURKEY</b>	
Fatma Fusun ERDEN, İlkay DELLAL, Zeki BAYRAMOĞLU .....	2547
<b>GOVERNMENT’S INTERVENTIONAL TRAINING IMPACT ON FARMERS COMPETITIVENESS</b>	
Vlada VITUNSKIENĖ, Edvardas MAKŠECKAS .....	2553
<b>RISK ASSESSMENT IN AGRICULTURE: PROBLEMS AND PERSPECTIVES</b>	
Laura GIRDŽIŪTĖ .....	2560
<b>DAIRY PRODUCTION IN POMORAVLJE REGION, SERBIA</b>	
Jasmina FILIPOVIC, Sladjan STANKOVIC, Radmila BESKOROVAJNI, Natasa TOLIMIR, Nikola POPOVIC, Bratislav PESIC, Vladimir JOVANOVIĆ.....	2567
<b>ECONOMIC PARAMETERS OF SOUR CHERRY PRODUCTION IN POMORAVLJE REGION, SERBIA</b>	



Jasmina FILIPOVIC, Sladjan STANKOVIC, Dragan RAHOVIC, Ivana BAKIC, Robert RADISIC, Vedran TOMIC .....	2571
<b>GROSS MARGIN AND ECONOMIC PARAMETERS OF GRAPE PRODUCTION IN POMORAVLJE REGION, SERBIA</b>	
Jasmina FILIPOVIC, Sladjan STANKOVIC, Dragan RAHOVIC, Vedran TOMIC, Nikola LJILJANIC, Robert RADISIC, Marijana MASLOVARIC .....	2575
<b>IMPORTANCE OF RURAL TOURISM AND INVESTIGATION OF ABROAD EXAMPLES</b>	
Mükerrem ARSLAN, Erdi EKREN.....	2579
<b>7. FORESTRY AND AGRO-FORESTRY .....</b>	<b>2585</b>
<b>THE INFLUENCE OF LIGHT FACTORS AND COMPETITION AMONG THE CROWN OF THE ALLEY TREES OF <i>TILIA TOMENTOSA</i> (MOENCH) IN THE URBAN AREA OF SARAJEVO (BOSNIA AND HERZEGOVINA)</b>	
Selma HARAČIĆ-BERBIĆ, Ćemal VIŠNJIĆ, Besim BALIĆ.....	2586
<b>CANOPY GAP CHARACTERISTICS IN A RESERVED ORIENTAL BEECH FOREST, NORTHERN IRAN</b>	
Masoud TABARI, Saied KIAN, Omid ESMAILZADEH, Seyed JALIL ALAVI.....	2592
<b>EFFECTS OF RETENTION IN FOREST THE DRAINAGE WATER FROM AGRICULTURAL AREA</b>	
Magdalena JANEK, Kamil MAŃK, Edward PIERZGALSKI .....	2599
<b>THE VULNERABILITY TO CLIMATE CHANGES OF PINE FOREST CULTURES FROM OUTSIDE THEIR NATURAL RANGE</b>	
Cristinel CONSTANDACHE, Lucian DINCĂ, Nicu Constantin TUDOSE.....	2605
<b><i>PAULOWNIA</i> SPP. AND TRUFFLES (<i>TUBER</i> SPP.) PLANTATIONS IN ROMANIA</b>	
Lucian DINCĂ, Diana VASILE, Vlad CRIȘAN.....	2611
<b>UTILIZATION ASPECTS OF PRIVATE FORESTS IN SELECTED DISTRICTS IN WESTERN AND EASTERN SERBIA RELEVANT TO THE LEGAL FRAMEWORK, SOCIOECONOMIC INFLUENCES AND PROPERTY RIGHTS</b>	
Igor GOLIC, Vladimir NIKOLIC, Nenad PETROVIC .....	2618
<b>STAKEHOLDERS' ATTITUDES TOWARDS THE HUNTING SECTOR IN SERBIA: REGULATORY FRAMEWORK AND WILDLIFE PROTECTION SYSTEM</b>	
Slavko MLADENOVIĆ, Dragan GAČIĆ, Jelena NEDELJKOVIĆ, Nenad RANKOVIĆ, Dragan NONIĆ .....	2624
<b>INSTITUTIONAL FRAMEWORK, COOPERATION AND MEASURES FOR THE SERBIAN HUNTING SECTOR IMPROVEMENT</b>	
Jelena NEDELJKOVIĆ, Dragan NONIĆ, Dragan GAČIĆ, Slavko MLADENOVIĆ, Mersudin AVDIBEGOVIĆ.....	2632
<b>IMPACT OF THE FUNGAL PATHOGEN <i>ENTOMOPHAGA AULICAE</i> ON BROWNTAIL MOTH PARASITIDS</b>	
Mara TABAKOVIĆ-TOŠIĆ, Marija MILOSAVLJEVIĆ.....	2640

**VEGETATIVE PROPAGATION OF ELITE TREES OF CORNUS MAS L. IN THE BELGRADE AREA BY SOFTWOOD CUTTINGS**

Marija MARKOVIĆ, Dragana SKOČAJIĆ, Mihailo GRBIĆ, Matilda ĐUKIĆ..... 2646

**SOIL POTENTIAL FOR POPLAR PLANTATIONS ESTABLISHMENT IN THE AREA OF PE „ŠUME REPUBLIKE SRPSKE“ (BOSNIA AND HERZEGOVINA)**

Saša PEKEČ, Andrej PILIPOVIĆ, Marina KATANIĆ, Milan DREKIĆ ..... 2653

**EFFECT OF SALINITY ON GROWTH AND DEVELOPMENT OF WHITE POPLAR SHOOTS *IN VITRO***

Vanja VUKSANOVIĆ, Branislav KOVAČEVIĆ, Saša ORLOVIĆ, Marina KATANIĆ, Marko KEBERT, Dragana MILADINOVIĆ ..... 2658

**MORPHOLOGICAL CHARACTERISTICS AND VARIABILITY OF THE SEEDLINGS OF THE SYCAMORE MAPLE (*Acer pseudoplatanus* L.)**

Vladan POPOVIĆ, Tatjana ĆIRKOVIĆ-MITROVIĆ, Ljiljana BRAŠANAC-BOSANAC, Ljubinko RAKONJAC, Aleksandar LUČIĆ..... 2664

**FOREST STAND MANAGEMENT OF *QUERCUS ROBUR* AND *Q. PYRENAICA* IN GALICIA (NW SPAIN) REGARDING ENVIRONMENTAL FACTORS**

Ignacio J. DIAZ-MAROTO, Pablo VILA-LAMEIRO, Maykel RAMON-PUMAR .. 2671

**EVALUATION OF SOME RUNOFF AND PHYSICOCHEMICAL PARAMETERS IN AN ALCALINE STREAM OF SCOTS PINE FOREST**

Ibrahim YURTSEVEN ..... 2680

**SELECTION OF ALMOND (*Prunus amygdalus* L.) GENOTYPES GROWING IN THE FOREST AREA OF HILVAN (SANLIURFA) DISTRICT, TURKEY**

Mikdat ŞİMŞEK..... 2685

**EVALUATION IN BIO-COMPOSITE FILM PRODUCTION OF SOME AGRICULTURAL PLANTS GROWING IN TURKEY**

Saim ATEŞ, Ekrem DURMAZ..... 2691

**SHORT-TERM DIAMETER AND HEIGHT INCREMENTS OF ORIENTAL BEECH AND BLACK ALDER SEEDLINGS IN PURE AND MIXED SITES**

Sinan GUNER, Askin GOKTURK, Mehmet KUCUK ..... 2700

**CONTRIBUTIONS OF MULTI-SITE PROVENANCE TRIALS TO INVESTIGATE GENETIC DIVERSITY OF FOREST TREES POPULATIONS ASSOCIATED WITH GEOGRAPHY**

Vasilije ISAJEV, Milena STANKOVIC-NEDJIC, Vera LAVADINOVIC, Stefan BOJIC ..... 2707

**THE SELENIUM CONTENT OF AMANITA SPECIES FROM SAMANLI MOUNTAIN OF MARMARA REGION (TURKEY)**

Murad Aydın ŞANDA, Hasan Hüseyin DOGAN..... 2714

**RELATIONS BETWEEN LEAVE'S BIOMETRICAL CHARACTERISTICS AND VITALITY OF NORWAY SPRUCE (*PICEA ABIES* KARST.) UNDERGROWTH**

Marko GUTALJ, A.V. GRYAZKIN, N.V. BELYAEVA, I.A. KAZI ..... 2720

**ECOLOGICAL FACTORS AND CONDITION OF FORESTS ACROSS THE AREA OF MOUNTAIN TREBEVIC IN REPUBLIC OF SRPSKA (BOSNIA AND HERZEGOVINA)**

Sinisa CINCAR, Aleksandar TEPAVAC, Nevena KUSMUK..... 2725

**MULTIPURPOSE PROPERTIES OF SOME PLANTS SUITABLE FOR FOREST GARDENS – DAMASK ROSE, MAULE’S QUINCE, STEVIA**

Srdjan LJUBOJEVIĆ, Ladislav VASILISIN, Goran VUČIĆ, Aleksandar SAVIĆ .... 2729

**PHENOTYPING TREES FOR TRAITS RELATED TO DROUGHT STRESS TOLERANCE – IMPORTANCE AND CHALLENGE**

Doris KRABEL, Matthias MEYER, Bayartaa NYAMJAV, Birgit REICHE, Alexander SOLGER ..... 2738

**AUTHOR INDEX..... 2744**

# **1. PLANT PRODUCTION**

## THE EFFECT OF CUTTING ON GRAIN AND FORAGE YIELD OF TWO OATS SPECIES IN LOWLAND OF ALBANIA

Isuf KAZIU<sup>1\*</sup>, Foto KASHTA<sup>2</sup>, Asllan CELAMI<sup>1</sup>, Alban IBRALIU<sup>2</sup>, Ilir MEHMETI<sup>1</sup>

<sup>1\*</sup>Agricultural Technology Transfer Centre (ATTC), Fushë Krujë, Albania

<sup>2</sup>Agricultural University of Tirana, Albania

\*Corresponding author: [isufkaziu@yahoo.com](mailto:isufkaziu@yahoo.com)

### Abstract

The aims of this study were: a) to find the appropriate time of cutting for better grain and forage yield, and b) to determinate the most suitable species for dual use. The experiment was conducted during 2015 and 2016 at ATTC Fushë Krujë, according to the randomized completed block with four replications. In the study, there were species: *A. sativa* (cv. "Këmishtaj") and *A. byzantina* (cv. "Flavia"). Variants were: without cutting; a cutting when the plants were 30 cm height; two cuttings, the first when the plants were 30 cm and after renewal at the same height; a cutting when the plants were in the stem elongation stage. The following traits were determined: the number of plants before and after cutting, the height of plant, number of grains/panicle, grain weight/panicle, grain and forage yield. Cutting reduced the values of the studied traits. The most decrease of traits value was found in the variants with two cuttings and one cutting at intensive stem elongation. The number of plants decreased respectively by 5% and 10%, and the weight of grains/panicle at 34% in two variants for the specie *A. sativa*, 45% and 49,7% for the specie *A. byzantina*. Grain yield was higher in variant without cutting and species *Avena sativa* (58.6 kv/ha). The data showed that the better indices for dual use were taken in the variant with a cutting at 30 cm height, in both studied species.

**Keywords:** *Avena sativa*, *Avena byzantina* species, forage, cutting, grain yield.

### Introduction

In Albania, livestock farming is the main activity in agriculture which provides 56% of the agricultural income (Statistical yearbook 2013). Increasing livestock has increased the need for nutrition in quantity and quality. For this reason, the area planted with forage has been significantly increased.

In the structure of arable plants, the forage occupies 52% of the area or 200,000 ha. From this alfalfa (*Medicago sativa*) occupies the largest area with about 120 thousand ha, while the rest is planted with annual forage crops such as berseem clover (*Trifolium alexandrinum*), ryegrass (*Lolium multiflorum*) and oats (*Avena* sp.). Among them the largest area is sown with oats about 50 - 60 thousand ha (25-30% of the area planted with forage crops) (Statistical yearbook, 2013). The forage production and forage quality of oats are determined by numerous interacting factors, namely, environment, management practices, and genetics (Brundage et al., 1979; Elizalde et al., 1999; Firdous and Gilani 2001). Environmental factors such as temperature, precipitation, location, etc. strongly influence forage production and quality (Kim et al., 2005). In the conditions of Albania, where farm size is small and irrigation opportunities are scarce, farmers are not able to grow spring crops, which have high demand for water. Therefore, autumn crops are one of the best and most economical opportunities to cope the livestock needs for the food not only in critical periods but throughout the year. Oat is an important winter food, mainly as a green food, but the surplus becomes silage or hay for

use during periods of food deficit (Suttie and Reynolds, 2004). Also, as a forage crop, it has its advantages compared to other forage crops, because it has faster growth, and provide high quality fodder for all animal categories. In Albania, oats are cultivated both in the continental climate zone and in the mild Mediterranean climate. In mountainous areas, with continental climate, it is cultivated mainly for grain production, while in the lowland area it is cultivated for green fodder, hay and grain production. Also in the lowland area, there is a cultivation practice for dual use, where it is first used for green fodder (grazing or cutting) and then left for grain production. In some cases, the food deficit during the critical winter period and the beginning of spring, leads to misused of oats crop. So, in many cases happened intensive grazing of oats, very low cutting or cutting very late when the plants are at the stem elongation stage. Such practices make that grain production is significantly reduced. There are many reports of work done regarding the oat management practices for fodder production in mild climate areas. Management practices such as harvest time (Kim et al, 1999), fertilization (Johnston et al., 2004; Pradhan, L. and S.N. Mishra 1994) and etc. found that they affect the quantity and quality of oat fodder production. However, in Albania there are no such studies and much more, studies related to its utilization practices for dual use. The aims of this study were: a) to find the appropriate time of cutting for better grain and forage yield, and b) to determinate the most suitable species for dual use.

### Materials and methods

The study was conducted during 2015 and 2016, in the experimental field of ATTC Fushë Krujë, Albania, located between 34°28'20 "N and 19°40'38" E in Mediterranean climate conditions. Two species were found in the test: *A. sativa* (cultivar "Këmishtaj" oat landraces) and *A. byzantina* (cultivar "Flavia"). Variants were: (a) no cutting; (b) a cutting when the plants reach a height of 30 cm (tillering stage); (c), two cuttings, the first when the plants have reached the height of 30 cm and the other after renewal at the same height; (d) a cutting when the plants were in the stem elongation stage (at 2-nodes stage). The experiment was conducted according to the completed randomized block design with four replications. Each variant had a size of 10 m<sup>2</sup> (5m x 2 m) and in each variant 10 rows were planted. The spacing between the rows was 20 cm. Planting was done on 07/11/2014 and on 03/11/2015. Planting was carried out by hand the seed rate was 130 kg/ha. In basic fertilization, before planting, granulated superphosphate was used at 80 kg/ha P<sub>2</sub>O<sub>5</sub>, while nitrogen fertilization at 90 kg/ha N was applied during vegetation. The number of production tillers/m<sup>2</sup> (PT) was done before harvest. Counting was done directly on the field by counting them in two middle rows at 3 m long, and on this basis calculating the number of production tillers/m<sup>2</sup> using the formula: Number of productive tillers/m<sup>2</sup> (PT/m<sup>2</sup>) = (total number of productive tillers in two rows in length 3 m)/3x2x spacing between rows. The height of the plants (HP) was measured at the time of harvest in ten random plants for each variant. For the number of grains and the weight of grains/panicle (GP, WGP), at the time of harvest, 10 random plants were taken and analysed in the laboratory. The fodder production was evaluated at the time of cutting by weighing each variant separately. One kg green fodder sample at cutting from each variant was collected at random for dry matter estimation. The samples were weighed, dried in an oven at 60°C for 48 hours and again weighed to calculate the dry matter yield (DMY) for each cutting. Grain yield (GY) was evaluated at harvest time by weighing each variant separately. Variance analysis (ANOVA) and student test was used to identify the significant differences between species and treatments.

## Results and discussion

### Plant height

The highest plant height, for both species, is observed in variant (d) when plants are harvested only once in the stem elongation stage (at 2-nodes stage), (Table 1). In the variant (b) with a cutting and variant (c) with two cuttings the height of the plant has been the same, inasmuch as the cutting criterion was set when the plants reached the height of 30 cm. But the cutting time was not the same for two species. The first cutting of species *A. sativa* was made about six days faster than the species *A. byzantina*. This is explained by the fact that their growth habit is different. Cultivars of *A. sativa* species are characterized by the erect growth habit, while *A. byzantina* species are characterized by the prostrate growth habit. Since growth and development are directly influenced by climatic conditions, mainly temperature and humidity, cultivars with prostrate growth habit are likely to require more temperature for growth, hence characterized by later development, while cultivars with the erect growth habit, *A. sativa* species, have fastest initial growth (Kipps, 1970; Poehlman, 1987; Stuart et al., 2002).

### Dry matter yield

The data showed that the two species tested had statistically significant difference in forage production (Table 1, Figure 1). Forage and dry matter production increased with advancing stages of plant development. In both species *A. sativa* and *A. byzantina*, the highest fodder production, was reached in the variant (d) with a cutting when the plants were in the stem elongation stage, respectively 45.46 kv/ha and 42.08 kv/ha. The lowest fodder production green mass and dry matter was carried out in the variant (b) with a cutting in tillering stage. Also in the variant (c) with two cutting the forage production was lower than in the variant (d) with a cutting at the stem elongation stage. The lowest production in these two variants (b) and (c) can be explained by the fact that the plants at the time of the cutting were in the early vegetative growth stage (tillering stage).

Table 1. Average plant height and dry fodder yield (average of two years in cutting variants)

Species	Plant height (cm)			Dry matter yield (kv/ha)			LSD	
	b	c	d	b	c	d	0.05	0.01
<i>A. sativa</i>	31	30.5	74.9	19.9	34.42*	60.6**	6.34	14.55
<i>A. byzantina</i>	30	31	81.3	11.85	34.92**	53.17**	6.34	14.55

b- a cutting when the plants reach a height of 30 cm (tillering stage); c- two cuttings; d- a cutting when the plants were at the stem elongation stage.

### Number of productive tillers

The largest number of productive tillers/m<sup>2</sup> was recorded in the variant without cutting and, respectively, for the *A. sativa* species 409 tillers and *A. byzantina* 448 tillers per m<sup>2</sup> (Table 2). In variants with cutting, for both species in the study, it was recorded decrease in the number of tillers/m<sup>2</sup>. The smallest number of productive tillers/m<sup>2</sup> was recorded in the variant with a cutting in the stem elongation stage, while the decrease in the number of productive tillers with a cutting at the tillering stage was slight. Specifically, in both species, the decrease in tillers numbers compared to the variant without cutting was 5% for the variant with two cutting and 10% for the variant with a cutting in stem elongation stage. This decrease in the number of productive tillers is explained by the fact that, after cutting, some tillers did not renewal.

### Number of grains and weight of grains/panicle

The study showed that there were differences in the numbers of grains and the weight of grains/panicle as between species and variants. The largest number of grains/panicle (107 grains) and their weight/panicle (2.8g) were recorded in variant without cutting in species *A. sativa* (Table 2). Also, the results showed that the number of grains and the weight of the grains/panicle decreased in the variants with cutting, but the greater this decrease was in the variant (d) with a cutting at the stem elongation stage, and in the *A. byzantina* species. Thus, in the *A. sativa* species, in the variant (b) with a cutting at tillering stage, the number of grains decreased by 8.6% and their weight by 9%, in the variant (c) with two cuttings the number of grains decreased by 18.2% and weight 34% while in the variant (d) with a cutting at stem elongation stage the number of grains decreased by 18.4% and their weight by 34%, compared to the variant without cutting. In the *A. byzantina* species, in the variant (b) with a cutting at tillering stage, the number of grains decreased by 11% and their weight by 12%, in the variant (c) with two cuttings the number of grains decreased by 23% and weight 45% while in the variant (d) with a cutting at stem elongation stage the number of grains decreased by 24% and their weight by 49.7%, compared to the variant without cutting. This is explained by the fact that oats are very sensitive to high temperatures and drought. High temperatures above 30°C, as well as warmer winds during the flowering stage, increase the percentage of aborted flowers, leading to a reduction in production (Kashta et al. 2010). For the variants of cutting, critical stages, such as flowering and maturity, passed through high temperature and lack of optimal humidity due to the fact that the development stages in these variants were delayed by approximately 6 to 7 day for the variants of two cuttings and 9 to 10 days for the variant with a cutting at the stem elongation. This was reflected in the low grain production in these variants.

Table 2. Number of producer tillers/m<sup>2</sup> (PT), number of grains/panicle (GP), weight of grain/panicle (WGP) and grain yield (GY)

Factor	<i>A. sativa</i>				<i>A. byzantina</i>			
	PT	GP	WGP (gr)	GY (kv/ha)	PT	GP	WGP (gr)	GY (kv/ha)
<b>a</b>	409	107	2.6	58.6**	448	68	2.2	47.5**
<b>b</b>	400	98	2.4	44.1**	443	62	1.9	35.05**
<b>c</b>	388*	87.5	1.7	18.7**	426*	52.4	1.21	14.9**
<b>d</b>	368**	86.6	1.7	18.4**	403**	51.7	1.1	14.55**
LSD 0.05	13.992			4.0704	26.235			4.0704
LSD 0.01	25.696			7.4752	48.18			7.4752

a-no cutting, b- a cutting when the plants reach a height of 30 cm (tillering stage); c- two cuttings; d- a cutting when the plants were at the stem elongation stage.

### Grain yield

Statistical analysis showed that in grain yield there were significant differences between species and variants in the study for both levels of probability. The highest yield of the grain was recorded in varieties without cutting and in the *A. sativa* species (58.6 kv/ha) (Table 2, Figure 2), whereas the lowest yield (14.55 kv/ha) for variant (d) with a cutting at the stem elongation stage, in the *A. byzantina* species. Whereas, from the comparison of data for grain yield between cutting variants, the highest yield was made in the variant with a cutting at tillering stage for both species in the study. Decrease of yield in variants with cutting is explained by the fact that the production elements such as the number of productive tillers, the number of grains and the weight of grains/panicle were reduced. The same thing is reported by other researchers. Morris and Gardner (1958) found that clipping, oats, rye, and wheat as



late as February 15 decreased grain yields only slightly, but grain yield were reduced by 75 % or more when clipping was extended another month.

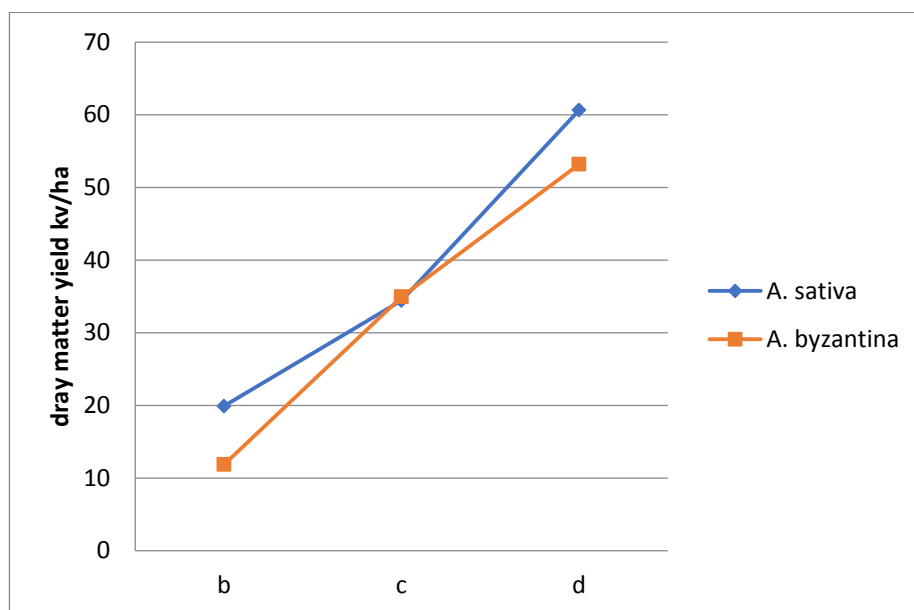


Figure 1. The impact of the species and method of utilization in forage yield

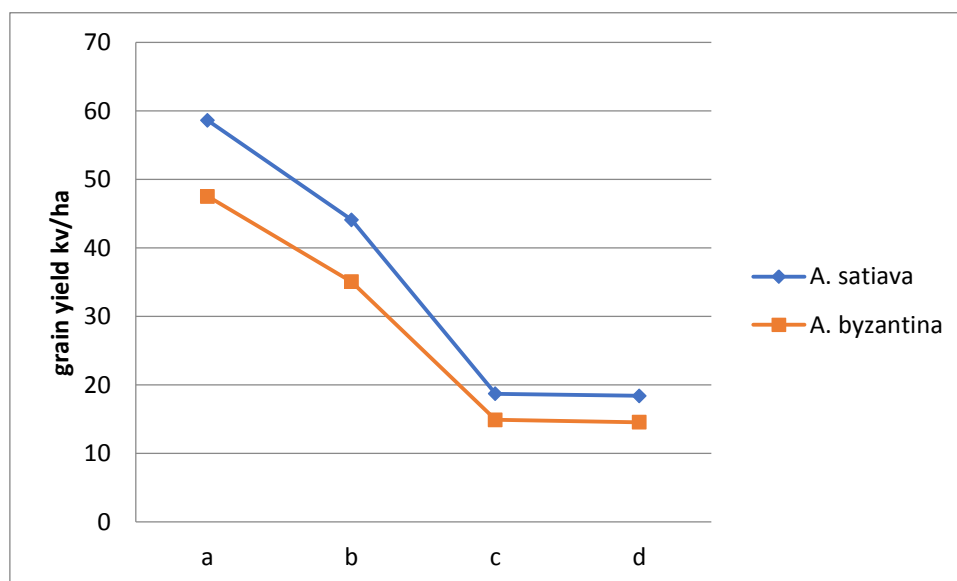


Figure 2. The impact of the species and method of use in grain yield

## Conclusion

The results of this study showed that between species there were significant differences for the grain yield, and in forage production. Based on the obtained results, the *A. sativa* species is superior to *A. byzantina* species both in grain and fodder yield. For dual use the best variant for both species resulted the variant (b) with one cutting when the plants are at the tillering stage.

## References

- Brundage A. L., Taylor R. L., Burton V. L. (1979). Relative yields and nutritive value of barely, oat, and peas harvested at four successive dates for forage. *J. Dairy Sci.* 62: pp. 740-745.
- Elizalde J. C., Merchen N. R., Faulkner D. B. (1999). Fractionation of fiber and crude protein in fresh forage during the spring growth. *J. Anim. Sci.* 77: pp.476-484.
- Firdous R., Gilani A. H. (2001). Changes in chemical composition of sorghum as influenced by growth stages and cultivar. *Asian-Aust. J. Anim. Sci.* 14:935-940.
- Johnston A.M., Lafond G.P., Stevenson F.C., May W.E., Mohr R.M. (2004). Effect of nitrogen, seeding date and cultivar on oat quality and yield in the eastern Canadian prairies. *Canadian J. Plant Sci.* 84: pp. 1025-1036.
- Kashta F., Bardhi N., Roço E. Tiranë, Albania (2010). *Bimët e arave*, University Textbook. pp. 133
- Kim J. D., Kwon C. H. Kwon, Shin C. N., Kim C. H. and Kim D. A. (2005). Effect of location, year and variety on forage yield and quality of winter rye. *Asian-Aust. J. Anim. Sci.* 18: pp. 997-1002.
- Kim W. H., Seo S., Jeong K. H., Kim J. G., Shin D. E., Shin J. S.. (1999). Effects of harvest date and cultivar on the growth, forage yield and quality of spring sown oats at the middle mountain area. *J. Kor. Grassl. Sci.* 19: pp. 89-94.
- Kipps M. S. (1970). *Production of field crops* (6th Ed.). McGrawHill, Inc. USA.
- Morris H. D., Gardner F. P. (1958). The effect of nitrogen fertilization and duration of clipping period on forage and grain yield of oats, wheat, and rye. *Agron. J.* 50: pp.454 – 457.
- Poehlman J. M. (1987). *Breeding field crops* (3rd Ed.). Van Nostrand Reinhold Company Inc. New York, NY.
- Pradhan L., Mishra S.N. (1994). Effect of cutting management, row spacing and levels of nitrogen on fodder yield and quality of oat. *Ind. J. Agron.* 39(2): 233-236.
- Statistical yearbook (2013), Albania.
- Stuart P., Slatter J., Elliott B., Busby G. (2002). *The Forage book; a comprehensive guide to forage management* (2nd Ed.). Pacific Seeds Pty Ltd., Toowoomba, Australia.
- Suttie J.M., Reynolds S.G. (2004). *Fodder oats. A world over view*. FAO, ISBN: 92-5-105243-3. [http://www.fao.org/008/y5765\\_e/y\\_5765\\_e00.htm](http://www.fao.org/008/y5765_e/y_5765_e00.htm)

## **CLIMATIC CONDITIONS, YIELDS AND PLANT PRODUCTION IN ALGERIA**

Amel BOUZID\*

Centre for Research in Applied Economics for Development, Division of Agriculture, Territory and Environment, Algiers, Algeria.

\*Corresponding author: [ambzdz@yahoo.fr](mailto:ambzdz@yahoo.fr)

### **Abstract**

The Algerian population is growing. We increasing passed from 23 million in 1987 to 40 million in 2016. This population growth induced a significant increase of the in food demand. Despite the fact that Algeria has abundant areas and favorable climatic conditions, the cultivable area is still representing only 3.5% of the total area of the country. Thus, the Algerian agricultural production is still far from covering meeting the local food demand of the population. That makes the country dependent of the international market, especially for sugar, oil and wheat. In the present work, the author intends to contribute to the understanding of the slow growth of the plant production in Algeria and its strong dependence on the climatic conditions and yields. Our analysis will be aimed to give a general review, and also to show the specificity of the three aggregates of the vegetation production: cereals (wheat, oat and barley), pulses (chickpea) and industrial crops and market gardening (industrial tomato, potato). In final, we will conclude by giving some recommendations to improve the efficiency of the public policies aiming to promote agriculture.

**Key words:** *Algeria, climate, yields and production, cereals, potato, chickpea, industrial tomato*

### **Introduction**

The role of agriculture is crucial in these aspects. First, to offer food to people without constraints and also to provide individuals with an income allowing them to live and buy various products in society. (Bouazouni, 2008). FAO reports indicate that the vulnerability of developing countries will be increased. This is driven by a number of factors, including climate change, international finance and the globalization of certain staple foods. In the present work, we intend to contribute to the understanding of the slow growth of the plant production in Algeria and its strong dependence on the climatic conditions and yields. Our analysis will be aimed to give a general review, and also to show the specificity of the three aggregates of the vegetation production: cereals (wheat, oat and barley), pulses (chickpea) and industrial crops and market gardening (industrial tomato, potato).

### **Material and Methods**

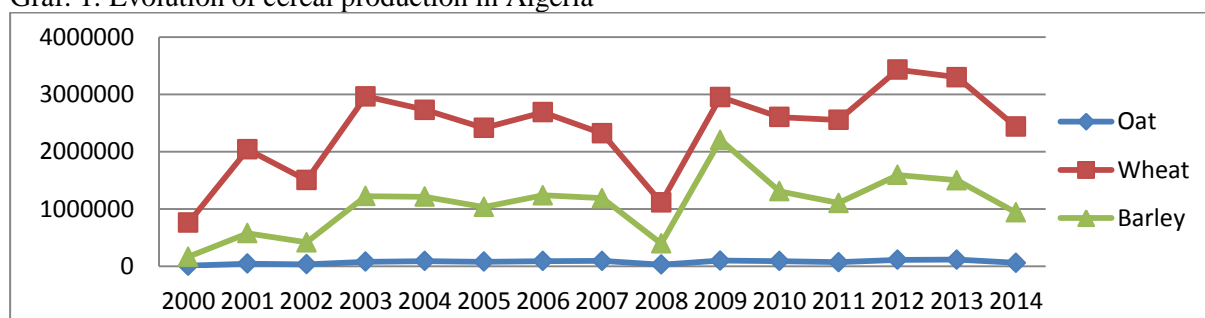
To answer our working hypothesis, data on production, production areas and yields were collected from the Ministry of Agriculture and Fisheries and from the FAO site. A bibliographical search was also carried out to enrich our work with the research that has already been done to explain the variation of productions. On the other hand, it was difficult to collect data precipitation at the National Center for Climatology in order to measure the impact of rainfall on yield increases.

## Results and Discussion

### 1-Cereal production:

Cereals and their derivatives constitute the staple food in many developing countries, particularly in the Maghreb countries. Consumption of cereal products is at a level of about 205 kg / capita / year (Chehat, 2007). The production of cereals, including fallow, occupies about 80% of the utilized agricultural area (UAA) of the country, the area planted in cereals annually between 3 and 3, 5 million hectares. The area harvested annually represents 63% of the area planted. It therefore appears as a dominant speculation. (Djemoum, 2009). According to the RGA, 2001, this crop is practiced by the majority of the farms (60% of the total population associated with the fallow) and it is present on all the bioclimatic stages, including in the Saharan zones.

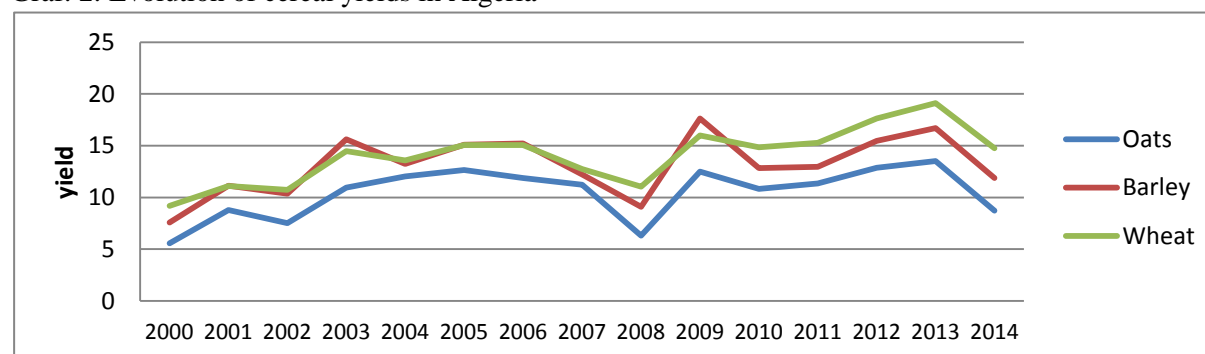
Graf. 1: Evolution of cereal production in Algeria



Source: FAO

Cereal production in Algeria is marked by a strong irregularity, which is conditioned by climatic hazards. Thus, over the last 40 years, recording a gap of 1 to 5 from a calamitous year (9.7 million q in 1994) and a year of abundance (52.5q million in 2009). However, technological and economic progress, if they fail to stabilize production in the sector, has allowed it to increase significantly: the decadal average almost doubled between 1981-90 (18.2 million q) and 2001 -2010 (34.9 million q), With a steady progression which allowed to accompany the demographic progression (from 19 to 38 million inhabitants between 1980 and 2012).(Chehat,2007). The average production of cereals last 5 years (2008-2012), who was just over 32 million quintals according to FAO, consists of 19 million quintals of wheat (60%) and 13 million quintals of barley (40%). Wheat production is divided between durum wheat (70% in 2012) and soft wheat (30%).

Graf. 2: Evolution of cereal yields in Algeria



Source: FAO

Generally well adapted to local conditions, its production is progressing at the same rate as that of soft wheat (+ 47% between the five-year averages 2000-2004 and 2008-

2012). Compared with + 84% for barley, which remains higher than soft wheat, at more than 13 million quintals in 2008-2012, compared with 8 for soft wheat and 19 for durum wheat. Despite undeniable progress, cereal yields remain low and very irregular: 1.35 t per ha for wheat on average for 2001-2010 (durum wheat, better suited to local agro-climatic conditions, enjoys significantly higher yields). And 1.32(t ha<sup>-1</sup>) for barley, which is far behind the productivity of the Mediterranean countries of Europe and can be explained both by natural causes (soil and climate), techniques (seeds, cultural practices) and human (Organization and training of producers). Algeria also has a strong "regionalization" of production conditions and thus contrasting harvest levels from East to West. (Chehat, 2007)

## 2. Production of potato:

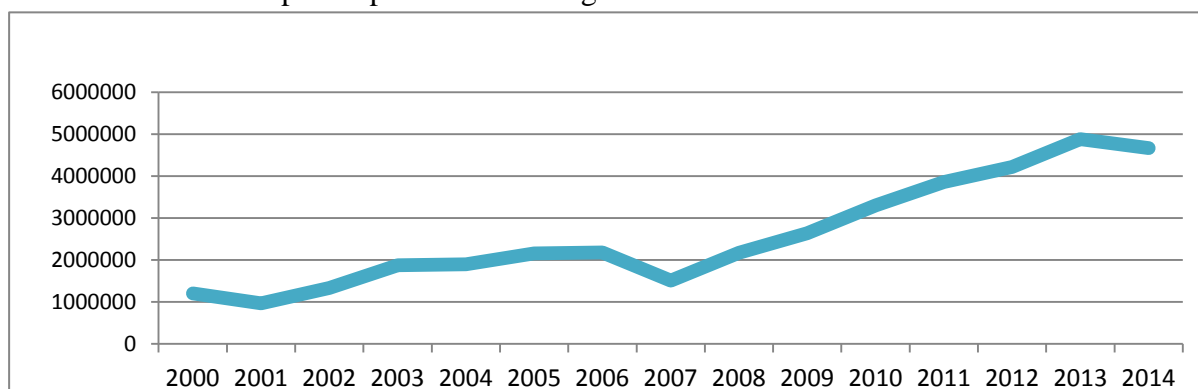
Unlike cereals, potato is cultivated throughout the country, including in the oasis of the south, but if we retain only fifteen department where it occupies more than a thousand hectares, it will be possible to distinguish in the zones of the littoral and the sublittoral three production basins having for wilaya pivot Mascara in the West, Aïn-Defla in the Center and El Oued in the South East (Tria and Chehat, 2013). Tria and Chehat (2013) added that over the past five decades, the potato has gained a place in the food consumption model alongside wheat and milk.

-The seasonal crops (plantation from January to March) dominating both by the area occupied (70 000 ha on average during the last quinquennium or 51% of the areas) and their participation of total production.

- Those of the back season (plantation July - August) which occupies the second place with 47 500 ha, ie 45% of the areas.

-Early vegetables crops (planted from October to November). They occupy only a minor place (less than 5000 hectares) in all the areas and production. Difficulties in setting up and the higher risks incurred by farmers explain the decline in the area used for early potatoes.

Graf. 3: Evolution of potato production in Algeria



Source: FAO

The climate will be the determining factor for the farmer's choice. Thus, the option for the early potato will depend on the rainfall and the severity of the temperatures at the time of the establishment of the crop. The option for backyard potatoes will depend on irrigation possibilities since planting takes place in summer, a dry period in all regions of the country. Only seasonal potatoes are less dependent on climatic hazards, although in most cases irrigation will be required to ensure a good development of the plant.

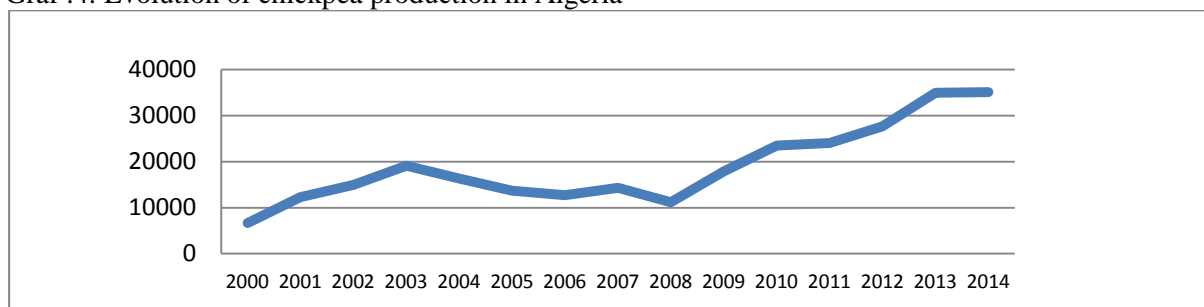
Over the last half-century, yields have initially experienced a long period of almost constant regression, with crops being largely produced on farms in the public sector (D.A.S). If this regression had not been offset by an extension of the area (80 000 ha compared to 18 000 ha), this could have led to serious supply problems on the national market.

The rate of improvement in yields slowed somewhat since 2001 but still high compared to most other vegetable crops. The highest performance (over 25 t / ha) were obtained in the western basin wilaya ( Chlef), two departments of the central basin (Ain-Defla and Algiers) and one department of the Eastern basin (Mila). The highest yield is obtained in 2012 or the yield exceeded 30T / ha. (Tria and Chehat, 2013)

### 3. Production of chickpeas:

For a long time, the chickpea is present in our farming systems associated with cereals which it leaves significant amounts of nitrogen in the soil. However, the local agro-economic constraints mean that the production of this crop remains very low with the area constantly decreasing, while the needs are constantly increasing. This situation results in almost total dependence on imports (Labdi and al., 2007).

Graf .4: Evolution of chickpea production in Algeria



Source: FAO

Over the last ten years, production of chickpea has declined significantly with a very good production in 2010 (23 473 t). This decline can be explained in part by the reluctance of farmers to plant this species, due to the poor performance recorded in previous years.

### 4. Production of industrial tomatoes:

Industrial tomatoes are mainly grown in the north-east of the country: the departments of El Tarf, Annaba, Guelma and Skikda account for 90% of the total area devoted to this crop in Algeria.

Table 1. Average yields and harvested area of industrial tomato in Algeria

Average annual yield (t ha <sup>-1</sup> ) and harvested area (ha) of industrial tomato in Algeria						
Period	1971-1980	1981-1990	1991-2000	2000-2009	2005-2009	2009-2015
t ha <sup>-1</sup>	8	9	16	22	26	36
ha	8 110	14 498	28 024	19 471	14 618	25 000

Source: Calculated from statistics MARD

A marked improvement in yields was observed during the period 1971-2015, yields increased from 8 tons / ha in 1990 to 32 tons / ha in 2009 and 40 t / ha at the currently. Despite this evolution, Algerian yields are still low compared to those obtained in many other countries.

The low production can be explained by many factors, other than cultivated and the yields obtained, the changes can be explained by other parameters can be identified. Low yields can be attributed to several causes, including:

- Failure to respect the technical itinerary recommended by cultural specialists (Baci, 1993).
- The lack of rigor of the farmers in respect of the technical itinerary is probably due to the lack of effort in the popularization of production techniques.
- The lack of rigor of the farmers in respect of the technical itinerary is probably due to the lack of effort in the popularization of production techniques. The low level of mechanization of transplanting and maintenance operations increases the load per hectare. (Guedmani, 1993)
- Late and inadequate use of high-performing varieties, particularly certain hybrid varieties whose yield is much higher than that of local varieties. The reason is that hybrids have a high price (150 000-230 000 DA kilogram in 2011, according to market supply state) unlike the price of traditional seed whose price does not exceed 3000 DA / Kg. It should be noted that the cost of purchasing hybrid seed accounts for 22 to 27% of the total cost of production of one kilogram of tomato. (Bouزيد et Bedrani,2013)

The lack of irrigation until the end of the 1980s, the irrigation was begun with the commissioning of the Hammam Debagh dam (in the Guelma wilaya). But it was not until 2000 that the policy of supporting water-saving irrigation (by sprinkling and localized) allowed the generalization of irrigation. Before the end of the 1980s, culture was practiced "dry" and undergoing the main cause of the weakness and irregularity of yields.

### **Conclusions**

Algerian agriculture, although placed in relatively difficult climatic conditions, has still untapped potentialities whose development would significantly reduce its food dependence. Since 1961 there has been an increase in crop yields but at what price and at what rate of integration?

Recommendations:

Establish an effective system for collecting and disseminating statistics on all aspects of agriculture and rural development (production, financing, foreign trade, employment, land structures, etc.);

Establish independent institutions for the evaluation of agricultural and rural development  
Agricultural research is the key to future food.

Algeria devotes to research only relatively weak means, dispersed between too many different themes policies,

### **References**

- Baci, L. (1993). Les contraintes au développement du secteur des fruits et légumes en Algérie: faiblesse des rendements et opacité des marchés in *Les agricultures maghrébines à l'aube de l'an 2000. Options Méditerranéennes : Série B. Etudes et Recherches*; n. 14. (Constraints on the development of the fruit and vegetable sector in Algeria: low yields and opaque markets In *Maghreb agriculture at the dawn of the year 2000. Options Méditerranéennes: Series B. Studies and Research*)
- Bedrani S., Bouزيد A., (2012).Algérie: bilan de politique de développement agricole et rurale. *Iktissad el djadid*. 2012, vol. 7, no 1, p. 92-70. (Algeria: agricultural and rural development policy review. *Iktissad el djadid*. 2012, vol. 7, No. 1, p. 92-70.)

- Bouazouni O. (2008). Etude d'impact des prix des produits agroalimentaires de bases sur les ménages. Présenté au programme alimentaire Mondial. (Study of the impact of agri-food prices on households. Presented to the World Food Program)
- Bouzid, A., Bedrani, S. (2013). La performance économique de la filière tomate industrielle en Algérie. Les cahiers du cread, 103, 85-105. (The economic performance of the industrial tomato industry in Algeria. Les cahiers du cread, 103, 85-105)
- Chehat F. (2007). Analyse macroéconomique des filières, la filière blés en Algérie. Projet PAMLIM « Perspectives agricoles et agroalimentaires Maghrébines Libéralisation et Mondialisation » Alger : 7-9 avril 2007. Revue Nature et Technologie. n° 01/Juin 2009. Pages 45 à 53. (Macroeconomic analysis of sectors, the wheat sector in Algeria. PAMLIM Project "Agricultural and Agroalimentary Outlook Maghreb Liberalization and Globalization" Algiers: 7-9 April 2007. Nature and Technology Review. N ° 01 / June 2009. Pages 45 to 53)
- Djermoum A. (2009). la production céréalière en Algérie : les principales caractéristiques. Revue Nature et Technologie. N° 01/Juin 2009. Pages 45 à 53. (Cereal production in Algeria: the main characteristics. Revue Nature et Technologie. N ° 01 / June 2009. Pages 45 to 53)
- FAO: <http://faostat.fao.org>
- Tria, M., Chehat, F. (2013). Typologie des producteurs de pomme de terre dans la région d'Ain defla. Les cahiers du cread, 103, 107-136. (Typology of potato producers in the region of Ain defla. Les cahiers cread, 103, 107-136.)
- Zine-zakaria F, bouzid L., yekkour A. (2015). Le pois chiche en Algérie : situation, potentialités et perspectives. Recherche agronomique. N°27. (The chickpea in Algeria: situation, potentialities and perspectives. Agricultural research. No. 27)



## **ECONOMIC ANALYSIS OF THE MULCH USAGE IN THE PRODUCTION OF WINTER LETTUCE**

Aleksandra GOVEDARICA-LUČIĆ\*<sup>1</sup>, Alma RAHIMIĆ<sup>2</sup>, Goran PERKOVIĆ<sup>1</sup>, Grujica VICO<sup>1</sup>

<sup>1</sup>Agricultural Faculty, University of Eastern Sarajevo, Republic of Srpska, Bosnia and Herzegovina

<sup>2</sup>Agro Mediterranean Faculty, University of “Džemal Bijedić” Mostar, Bosnia and Herzegovina

\*Corresponding author:sandrakleplic@yahoo.com

### **Abstract**

The economic analysis of winter lettuce production comprised three breeding technologies based on localized drip irrigation and using plants with protected root. These types differed in the applied mulch: a) uncovered area; b) mulching with black PVC film; c) covering with agro textile weight 17 g; d) a combination of black PVC foil mulch and agro textile. The research was done during winter (2009, 2010, and 2011) in a greenhouse with no extra heating. The greenhouse is located on the sample field in the area of the Agricultural Faculty in Eastern Sarajevo. The research comprised Santoro RZ variety. The results showed some variation, depending on the observed parameters, but the combination of mulch and agro textile was proved to be the best material. The most efficient production is with usage of combination of black PVC film and agro textile. Production of lettuce with technology that includes a combination of black PVC film and agro textile is economically viable. This combination has achieved the rate of profitability of 58.22%

**Key words:** *winter production of lettuce, mulching, efficiency, effectiveness, protected space.*

### **Introduction**

Modern science pays a lot of attention on winter lettuce, not just because of its high nutritional value, but also because this vegetable has a short period of vegetation and modest demands towards its surrounding, which means that it can be produced during winter when there is the lowest offer supply of fresh vegetables.

On the other side, the earliest supply of fresh vegetables is, at the same time, most expensive. The most economical production of vegetables is one that offers harvest during the period of the lowest supply on the market (Coelho et al., 2005). The lack of this production them is the reason why most people use just seasonal vegetables, while they buy other vegetables just for special occasions or do not buy it at all. It is important to find a balance between demands for quality work, achievement of high quality of vegetables and rational usage of energy, in order to warrant your solutions (Barać, 2004). Nowadays when we produce early vegetables we cover our plants immediately after putting them in the ground or immediately after sowing. According to the research of Đurovka et al. (1996), planting of vegetables by covering plants provides better microclimate conditions, which means faster and more equal growing, development and yielding with better quality of fruit and better crop as well. Manufacturing techniques affect growth rate, total yield, earlier yield and yield quality components (El – Shinaway and Gawish, 2006; El-Behairy et al., 2001). The appropriate covering material can affect energy consumption and energy efficiency of production. Dimitrijević (2007) pointed out that the most important factors one should take into consideration when choose covering material are the variety of the plant, period of the year for the production and climate

conditions of the region. In view of the above facts, the objective of the research is to determine which variation of the mulch is economically viable.

### Material and method

We researched the variety Santoro RZ during winter (2009, 2010 and 2011) in a greenhouse without extra heating in a randomized block design. The greenhouse is located on the sample field in the area of the Agricultural Faculty in Eastern Sarajevo. Seedlings with protected root were replanted in the first decade of October. The distance between them was 20 cm in a row and 30 cm between the rows, resulting in about 150.000 plants/ha. We used a drip irrigation system, put at the same time with mulching. We included the following mulch material in our research: black PVC foil, agro textile (17 g), a combination of black PVC mulch and agro textile. For the analysis of climate conditions in the greenhouse we used standard methods and meteorological equipment. The micro climate measurements included monitoring of daily temperature. We calculated the economic efficiency of the production, including the coefficient (Ek) that was established by the following formula:

$Ek = \text{Value of production} / \text{Total costs}$

The profitability of the production was established from the relation of the financial results and the value of production:

$R_n = \text{profit} / \text{value of production} * 100$

In the daily temperature chart (chart 1) one can see that the first and second year of the research (2009 and 2010) had similar and favorable climate conditions comparing with 2011, which was considered to be colder. The temperatures in greenhouse space were directly dependent on the outside temperature. The reason for that was that we did not use heating inside the greenhouse. During the warm days, the difference in temperature was 7.64 °C, while during the cold days it was from 2.98 to 3.82 °C. On the other side, using different cover materials resulted in the variation in the temperatures between the treatments in the project. Ponjičan (2004) states that in his research the temperature difference under different covering material varied from 6.22 °C to 12.71 °C.

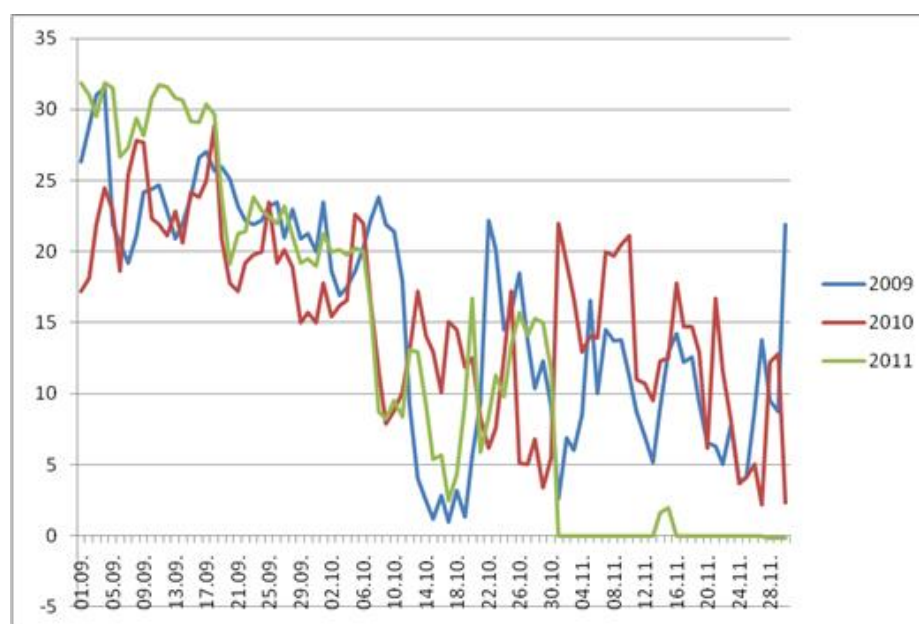


Chart 1. Average daily temperatures (in the green house) during the experiment with production of lettuce

## Results and Discussion

### Efficiency and profitability of production

The efficiency of production is economical usage of production factors. If the spend of production factors in the process of production for a certain product is lower, then the benefit of this spending is higher and vice versa. It is impossible to express the consumption of different production factors and the volume of the obtained products and services in the same natural units. The efficiency of certain production lines is established on the basis of the ratio of the production value and the value of all consumption factors (Gogić, 2009). Production is more efficient when  $E_k > 1$ , while it is on the efficiency margin when  $E_k = 1$ , and it is not efficient when  $E_k < 1$ . The results are presented in Table 1, showing that the production of lettuce is economically efficient, and if different mulching variants are used, the coefficients are always higher than 1. The most efficient production is with usage of a combination of a black PVC film and agro textile. Using these materials resulted in the highest coefficient of efficiency 2.39.

Table 1. Profitability of production

Mulching material	Production value (BAM/100m <sup>2</sup> )	Total costs (BAM/100m <sup>2</sup> )	Coefficient of efficiency ( $E_k$ )
Land without mulch	854.04	525.32	1.63
Black PVC film	901.14	488.82	1.84
Agrotextile	912.09	478.15	1.91
Combination of film and agro textile	1216.17	508.15	2.39

Table 2. shows the profitability of the production in different methods of lettuce production. The highest rate of profitability was achieved when lettuce was produced with combination of a black PVC film and agro textile, and the lowest rate was achieved on the land without mulch. These results are confirmed by Tošić et al., (2014) who said that the plant growing on the uncovered soil proved to be a bad solution for the total yield achievement. The production of lettuce with a combination of a black PVC film and agro textile achieved the rate of profitability of 58.22%, which means that on every 100 BAM of production the value profit was 58.22 BAM.

Table 2. Profitability of production

Mulching material	Production value (BAM/100m <sup>2</sup> )	Profit (BAM/100m <sup>2</sup> )	Profitability of production
Land without mulch	854.04	328.72	38.49
Black PVC film	901.14	412.32	45.76
Agrotextile	912.09	433.94	47.58
Combination of film and agro textile	1216.17	708.02	58.22

### Economic success with different mulching variants

Chart 2 shows that production of lettuce with technology that includes a combination of black PVC film and agro textile is economically viable. This mulching variant gave the highest

profit and income, and when we compare it with other variants it was 40.40% higher than the control, 34.75% than the black PVC film and 33.40% than the agro textile.

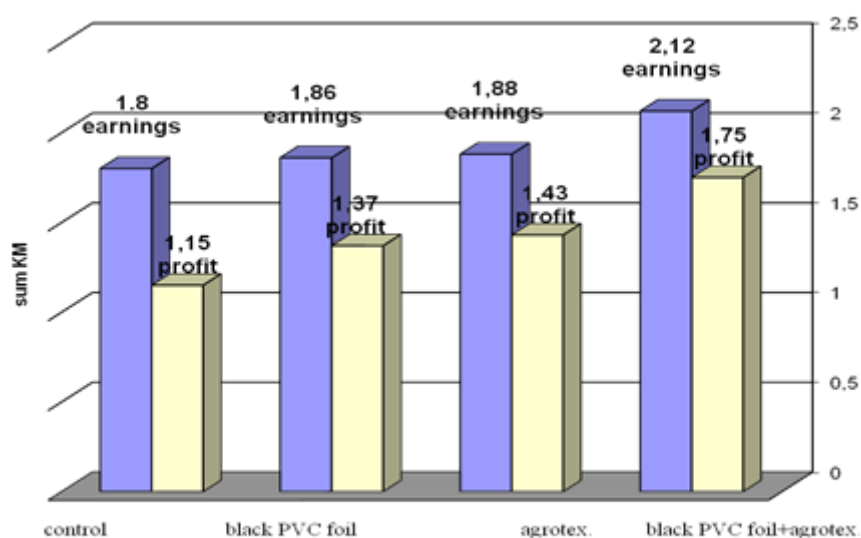


Chart 2. Profit and income per 1kg of the produced lettuce

### Conclusion

Based on the three year research (2009-2011), we can recommend the following:

- The production of lettuce is economically efficient, and if different mulching variants are used, the coefficients are always higher than 1.
- A combination of a black PVC film and agro textile is most economical. This variant achieved the highest percentage of profitability and production income.
- The production of lettuce with a combination of a black PVC film and agro textile achieved the rate of profitability of 58.22%.

### References

- Barać S. (2004). The impact of planting and energy consumption. Tractors and propulsion machines. Novi Sad . Vol. 9, No. 4. (116-120).
- Coelho A.F.S., Gomes E.P., Sousa A.P., Gloria M.B.A. ( 2005): Effect of irrigation level on yield and bioactive amine content of American lettuce. Journal of the Science of Food and Agriculture, 85: (1026-1032).
- Dimitrijević Aleksandra (2007): Consumption of energy in greenhouse. Modern agricultural technology. Novi Sad. Vol. 33, No. 3-4, (135-289),
- Đurovka M., Bajkin A., Lazić Branka, Ilin Ž. (1996): Effects of malch and immediate coverage for early and vegetable yields. Institute of Field and Vegetable Crops, Proceedings, Novi Sad, (467-474).
- El-Behairy U.A., El-Shinawyel M.Z., Medani M.A., Abou-Hadid A.F. (2001): Utilization of "A-shape" system of nutrient film technique (NFT) as a method for producing some vegetable crops intensively. Acta Horticulturae, 559 (581-586).

- El-Shinawy M.Z., Gawish S.M. (2006): Effect of commercial organic nutrient solutions on growth and chemical composition of lettuce under agricultural soilless system. *Egyptian journal of Horticulture*, 33: (19-28).
- Gogić P. (2009): Cost theory with calculations in the production and processing of agricultural products. Faculty of Agriculture, Beograd-Zemun.
- Ponjičan O., Bajkin A.(2008): Influence of mulch and covering plants on T air in the production of salads. *Modern agricultural technology*. Novi Sad.Vol. 34, No. 3-4, (117-270).
- Tošić I., Ilin Ž., Maksimović I., Pavlović S.(2014): The effect of plant mulching and covering on the lettuce yield and nitrate content (*Lactuca sativa* L.). *African Journal of Agricultural Research*. Vol.9(23),(1774-1777).

## TWIN ROW TECHNOLOGY MAIZE SOWING

Dragan JURKOVIĆ<sup>1</sup>, Nikolina KAJIĆ<sup>1</sup>, Anamarija BANAJ<sup>2</sup>, Vjekoslav TADIĆ<sup>2</sup>, Đuro BANAJ<sup>2</sup>, Jurica JOVIĆ<sup>2</sup>

<sup>1</sup>Faculty of Agriculture and Food Technology, University of Mostar,

<sup>2</sup>Faculty of Agriculture Osijek, University of Osijek,

\*Corresponding author: dragan.jurkovic@apfmo.org

### Abstract

This paper presents the results of the sowing of maize in twin row technology on Family Farm Jovic, Prud, municipality Odzak, Bosnia and Herzegovina, using the MaterMacc Twin row - 2 planter. Two hybrids were used: hybrid P0412 and hybrid BC 525 sown in standard sowing with a row spacing of 70 cm and twin row sowing with a spacing of double rows of 22 cm. Standard sowing was done with the pneumatic sowing machine Gaspardo SP-4, on the April 18<sup>th</sup>. The standard sowing of hybrid P0412 was performed on a predetermined set of 66355 plants per hectare. The estimated size of the plant was 60705 plants per hectare. The yield of this hybrid, harvested on September 26<sup>th</sup>, 2016, was 15798 kg with a standard deviation of 303,250 and a coefficient of variation of 1.92%. The yield of corn hybrids P0412 in sowing twin rows made by a set of roasted plants of 60528 plants was 16671 kg / ha or 5.53% more than standard sowing. The standard sowing of the hybrid BC525 was performed on a predetermined set of 66355 plants / ha. The estimate of drowned plants was 62658 plants per hectare. Yield of this hybrid in the berry was 14579 kg with a standard deviation of 1162,311 and a variation coefficient of 7, 97%. The yield of maize hybrids BC525 in sow Twin-row technology with a set of rotten plants of 68515 plants was 16613 kg / ha or 13.95% more than standard sowing.

**Keywords:** *corn, sowing, twin wheat, yield*

### Introduction

Maize (*Zea mays* L.) is one of the three leading agricultural crops along with wheat and rice, both in the world and in our country. Of all cereals, maize has the greatest fertility potential, that needs to be used in this and future period as well. Maize continues to be traditionally grown on major agricultural areas with different levels of soil fertility, and the reason for that is relatively simple maize cultivation without significant mechanization. Corn sowing in our area is performed at the row spacing of 70 and 75 cm. Recently, scientific research has been conducted for corn sowing in two rows, worldwide known as twin-row technology. Depending on the sowing machine producers, the twin rows are sown on a spacing of 20, 22 or 25 cm, and the central spacing of the adjoining dotted rows is 70 or 75 cm, so that corn harvest can be done with standard maize harvesters. This sowing technology allows better soil and sunlight utilization, and contributes to achieving equal or greater yield per hectare in most experiments. The difference in crop yields in dotted rows is significantly higher because this technology sow 284 rows per ha. Production of maize and other cultures using twin-row technology still represents a great unknown in BiH and the region. According to available current literature of this scientific area, Twin-row technology has been applied at the beginning of the nineteenth century in SAD as an attempt to enlarge yield by increasing the sowing of a larger number of plants (crops) per production area (ha). In the areas of the former Yugoslavia, Lazar Tadić started experiments with corn sowing in double rows in 1976,

according to Čuljat (1989), with the basic aim of enlarging the yield by increasing the plant density.

According to the same author, sowing in strips reduced the shading of plants, and the number of cracked and broken plants did not increase. In that same year, the Agricultural Institute of Osijek and Ph.D Mile Čuljat, along with the Metal industry Osijek and OLT, are developing the sowing machine for the cultural plant in two rows. Their joint work resulted in the first sowing machine in 1986 named PSK-T. According to this author, there was a significant enlarge in yield in all sowings from 6 to 18%. There is a large number of sowing machine manufacturers on the agricultural technology market today, some of which are predominant such as Great Plains, John Deere, Monosem, MaterMacc Crust Buster Speed King Inc., Kinze Manufacturing, Gaspardo and many others. The differences between the offered models of these companies are certainly in the sowing system as well as the spacing between double rows that is 20, 22 or 25 cm. Banaj, A. et al. (2017) presents the results of the application of twin-row technology in the Republic of Croatia using the MaterMacc Twin row -2 planter. Studies were conducted in the eastern part of Croatia where optimal precipitation rates were recorded throughout the whole vegetation (2016) of maize growing. According to Blandino M. et al (2013) a study of the row technology was conducted in Italy in 12 locations on different soils and climatic conditions in the provinces of Alessandria, Cuneo, Ferrara, Milan, Mantovi, Padua, Turin, Udine and Verona. The hybrid DKC 6815, of the FAO Group 600, is sown on various circuits, from 7.5 to 9.5 and even 10 plants / m<sup>2</sup>. The results indicate an increase in yields at 8 locations by 5.5% in average. The enlarge in yield was 0.6 t / ha (+ 3.6%) and 0.9 t / ha, which is the increase of 6.2%. According to Mackey G.L. et al. (2016), there is an increased interest in narrow rows (<30 inches) corn production in order to increase yields. Experiments were conducted around the cities of Lexington and Hodgenville in the state of Kentucky during 2011 and 2012 with three hybrids sown at a 15-inch spacing, two rows at 8 inches (20.32 cm) and standard sown at 30 inches (76.2 cm) with circuits of 30,000; 35,000; 40,000; and 45,000 plants per acre. In Hodgenville area in 2011, twin-row sowing has 6.7% higher yield compare to the standard which was not the case in the next year. However, a part of the author presented results with no significant differences in the yield between sowing on the standard row spacing and sowing with twin-row planters. Authors Ogrizović B. (2015) and Robles, M. (2012) quotes that twin-row technology sowing has advantages over the classic corn sowing because it increases the plant's complexity and improves the physical appearance of the plants which increases yield.

### Materials and methods

MaterMacc company was founded in the 1980's and became a member of the *Foton Lovol International Heavy Industry Group* in January 2015. The field experiment was conducted for 2016 growing season on Family Farm Jovic (Prud, municipality Odzak, Posavski Canton, Bosnia and Herzegovina). Maize was sown in term April 18 and harvested in October 1, 2016. Yields were calculated on 14% grain moisture basis. Developing the investor system and the sowing sections of the pneumatic sowing machines, lead to the production of double rows also-called Twin row planters. Some technical features of newly developed twin row planter are given in Table 1. The sowing was done on the April 18<sup>th</sup> 2016, on the surface where the pre-culture was wheat fertilized with 130 kg / ha N, 90 kg / ha P<sub>2</sub>O<sub>5</sub> and 110 kg / ha K<sub>2</sub>O. Treatment was conventional using Adengo herbicide for weed control.

The average air temperature in the sowing month was 12.9 ° C with the total measured precipitation of 60.7 mm. At harvest time, in mid-September, average air temperature was 17.2 ° C with 67.1 mm precipitation. The average air temperature in June was 21.3 ° C with maximum of 23.1 ° C in July. Significant soil characteristics at the trial site are the humus content of 3,07 %, pH in H<sub>2</sub>O 8,43 and in KCl 7,11.

**Table 1.** Basic technical characteristics of the MS 8100 Twin Row planter

Number of rows	Row spacing (cm)	Working width (cm)	Mass (kg)		Tractor power required (kW)	Tank capacity (l)		
			Basic performance	Fertilizer		Seed	Insecticide	Compost
2x2	70/75	140/150	630	720	29/37	140	12x2	215
4x2	70/75	280/300	1270	1450	74/81	280	12x4	215x2
6x2	70/75	420/450	1480	1760	81/89	420	12x6	215x2
8x2	70/75	560/600	1870	2250	89/96	560	12x8	650x2
12x2	70/75	840/900	2310	2750	110/118	840	12x12	650x2

### Results and discussion

The results of the exploitation performance indicators of the sowing process quality during corn sowing. Achieved seeded hybrid circuit after emergence. The working speeds and depths during sowing are shown in Table 2.



Picture 1: Twin row corn sowing with double rows spacing of 22 cm

**Table 2.** Some statistical values of exploitation performance indicators of sowing machines

Sowing machine	Working speed(km/h)			Working depth (cm)		
	$\bar{x}$	s.d.	KV (%)	$\bar{x}$	s.d.	KV (%)
<i>Gaspardo SP-4</i>	6.4	0.574	8.97	3.99	0.693	17.36
<i>MaterMacc Twin Row - 2</i>	7.5	0.699	9.23	4.66	0.514	11.04

**Table 3.** Determined plant configuration of experiment with hybrid P0412

Hibrid	Sowing - rowspacing 70 and 22 * 48 cm	Assembly plant per ha during emergence			Plant spacing within in line after emergence ( cm )		
		x	s.d.	KV (%)	x	s.d.	KV (%)
P0412	Standard I – 66355	60705	4785.45	7.88	24.27	5.948	24.51
	Twin Row I – 68393	60528	9142.20	15.10	40.60	2.313	5.70



**Table 4.** Corn grain yields hybrid P0412 (sowing at 70 cm interspace)

Hibrid	Assembly plant per ha during harvesting	Yield kg/ha		Statistical yield values		
		x	s.d.	KV (%)	Minimum value	Maximum value
P0412	Standard I – 60705	15798	303.25	1.92	15554.84	16196.04
	Twin Row I – 60528	16671	917.84	5.51	15854.48	17972.38

**Table 5.** Grain moisture at harvest for hybrid P0412

Hibrid	Assembly plant per ha during harvesting	Grain moisture (%)		Statistical values of grain moisture		
		x	s.d.	KV (%)	Minimum value	Maximum value
P0412	Standard I – 60705	19.00	0.997	5.25	18.00	20.30
	Twin Row I – 60528	20.04	1.146	5.72	18.60	21.50

**Table 6.** Determined plant configuration at experiment with hybrid BC 525

Hibrid	Sowing -row spacing 75 and 22 * 53 cm	Assembly plant per ha during emergence			Plant spacing within in line after emergence ( cm )		
		x	s.d.	KV (%)	x	s.d.	KV (%)
BC 525	Standard I – 66355	62658	2982.2	4.76	22.90	4.063	17.74
	Twin Row I – 68393	68515	4738.1	6.92	40.67	3.623	8.91

**Table 7.** Corn grain yields of hybrid BC 525 ( sowing at 75 cm interspace)

Hibrid	Assembly plant per ha during harvesting	Yield kg/ha		Statistical values of grain moisture		
		x	s.d.	KV (%)	Minimum value	Maximum value
BC 525	Standard I – 62658	14579	1162.311	7.97	13682.83	16275.00
	Twin Row I – 68515	16613	566.931	3.41	16031.01	17175.76

**Table 8.** Moisture values during harvesting on September 28<sup>th</sup> 2016 for hybrid BC 525

Hibrid	Assembly plant per ha during harvesting	Grain moisture (%)		Statistical values of grain moisture		
		x	s.d.	KV (%)	Minimum value	Maximum value
BC 525	Standard I – 62658	18.42	0.438	2.38	17.70	18.90
	Twin Row I – 68515	22.50	0.332	1.47	22.10	23.00

## **Conclusion**

Based on the meteorological data, primarily by observing the average monthly air temperature and monthly rainfall, it can be concluded that the vegetation year 2016 was suitable for maize production at the site of OPG Jović. In the standard sowing with the pneumatic sowing machine Gaspardo SP-4, hybrid P0412 with a set of 60705 plants / ha after emergence, obtained the yield of 15798 kg / ha of dry grain with an average humidity of 19.0%. Twin row sowing of the same hybrid with a set of 60528 plants / ha obtained a yield of 16671kg / ha of dry grain with an average moisture of 20.04%, which makes an increase of 5.53%, compared to the standard sowing. The standard sowing of the hybrid BC 525 with a set of 62 658 plants / ha after emergence, obtained the yield of 14579 kg / ha of dry grain with an average moisture of 18.42%. Twin row sowing of the same hybrid with MaterMacc Twin Row-2 planter with a set of 68 515 plants / ha and obtained yield of 16613 kg / ha of dry grain with an average moisture of 22.50%, represents an increase of 13.95% compared to standard sowing. After one year of research, an increase with the Twin Row-2 planter sowing was established.

## **References**

- Banaj Anamarija, Šumanovac L., Heffer G., Tadić V., Banaj Đ. (2017): Yield of corn grain by sowing in twin rows with MATERMACC - 2 planter, 45th Symposium Current tasks of agricultural mechanization, Opatija.
- Blandino, M. Reyneri A., Head G. (2013): Increasing productivity of maize with high investment and tied files, 76 Land and Life, No. 7/2013, 76-78.
- Čuljat M. (1989): Theoretical and technical aspects of the improvement and expansion of soybean production in Slavonia and Baranja, 154 - 158, Osijek, 1989.
- Mackey, G.L., J.M. Orłowski, J. Baniszewski, C.D. Lee. (2016). Corn Response to Row Spacing and Seeding Rate Varies by Hybrid and Environment in Kentucky. Crop, Forage & Turfgrass Management 2. doi: 10.2134 / cftm2016.0002
- Robles, M., Ciampitti Ignacio A., and Vyn, Tony J. (2012): Responses of Maize Hybrids to Twin-Row Spatial Arrangement Multiple Plant Densities, Agronomy Journal Volume104, Issue6.
- Ogrizović B. (2015): Results of the Corn Set with Twin-Row Seed in Sombor Region, 43rd Symposium "Current Activities of Agricultural Mechanics, Opatija, 319-329.
- Tadić, L., (1988): Set of corn in strips and the effects of the application of the seeder OLT-PSKT-4, Proceedings of the Current Activities of Agricultural Mechanics, 383-392, Opatija.

## MAIZE RESPONSE TO LIMING AND PHOSPHORUS FERTILIZATION IN LIJEVCE POLJE REGION OF BOSNIA AND HERZEGOVINA

Ilija KOMLJENOVIC<sup>1\*</sup>, Vlado KOVACEVIC<sup>3</sup>, Mihajlo MARKOVIC<sup>1</sup>, Goran DJURASINOVIC<sup>2</sup>, Vojo RADIC<sup>1</sup>

<sup>1</sup>Faculty of Agriculture, University of Banja Luka, Sq. Vojvoda Bojovic bb, 78000 Banja Luka, Republic of Srpska (RS), Bosnia and Herzegovina

<sup>2</sup>Agricultural Institute of Republic of RS, Knjaza Milosa 18, 78000 Banja Luka, RS, Bosnia and Herzegovina

<sup>3</sup>Faculty of Agriculture of University J. J. Strossmayer in Osijek, V. Preloga 1, 31000 Osijek, Croatia

\*Corresponding author: ilijakom@teol.net

### Abstract

The field experiment of liming (0 and 10 t ha<sup>-1</sup> of powdered hydrated lime) and phosphorus (P) fertilization (monoammonium phosphate or MAP: 12% N + 52% P<sub>2</sub>O<sub>5</sub>) started in autumn 2008 on acid soil (pH in 1n KCl: 4.28) of Lijevice polje region (Laktasi municipality, Bosnia and Herzegovina). Three doses of P (0, 500, 1000 and 1500 kg P<sub>2</sub>O<sub>5</sub> ha<sup>-1</sup>) on the conventional fertilization (160 N + 75 P<sub>2</sub>O<sub>5</sub> + 75 K<sub>2</sub>O kg ha<sup>-1</sup>) were applied in four replicates (basic plots of liming and P fertilization 640 m<sup>2</sup> and 40 m<sup>2</sup>, respectively). The conventional fertilization was applied in the next years of the experiment. Soil of the experiment was low supplied with plant available P and adequate supplied with potassium (AL-method: 2.9 mg P<sub>2</sub>O<sub>5</sub> and 23.4 mg K<sub>2</sub>O in 100 g of soil). Maize was grown in monoculture from 2009 to 2013. Average grain yield of maize was considerable different among the years, ranging from 2.06 to 9.38 t ha<sup>-1</sup>. Under less favorable weather conditions (drought and high temperature stress) in the 2011, 2012 and 2013, yields were considerably lower (mean 4.28 t ha<sup>-1</sup>) than in the remaining two years (mean 9.20 t ha<sup>-1</sup>). In general, liming effects on maize yields were stronger than P effects with considerable impacts of weather conditions. Affected by liming, yields were increased for 39%, 18%, 47%, 25% and 158%, for 2009, 2010, 2011, 2012 and 2013, respectively. However, P effects ranged, depending on the year, from non-significant differences (2012) to 32% (2013).

**Keywords:** *maize, liming, fertilization, phosphorus, grain yield*

### Introduction

Acidic soil with low a level of humus, reduced accessibility of exchangeable forms of the most important plant nutrients such as phosphorus and calcium, as well as rather poor physical soil properties (poor water-air regime) are limiting factors for achieving higher and stable yields of cultivated plants. Low yields on this soil in recent years, despite the regular application of mineral fertilizers, indicate the blocking of individual nutrients in the soil under conditions of acid reaction. If such a bad agrochemical trait is added to drought, then the production of crop, fodder, vegetable plants and fruits stagnates year after year.

Neutralization of the acidic soil reaction by introducing lime materials is a measure that is regularly recommended for the purpose of repairing physical, chemical and biological properties and increasing the level of fertility of the soil. Numerous studies in our region and in the world indicate that the adequate application of lime materials in combination with organic and mineral fertilizers is the most effective way of removing unfavorable production characteristics of acidic soils (Jelić et al. 2015).

In addition to monitoring the influence of liming and phosphate treatment on maize yield, in this paper is accompanied by an extension effect of these agromelioration rates, ie, the time frame will be liming and phosphate has an effect on the amount of maize yield.

Marković and Supić (2013) are estimating that 25 % arable lands in Bosnia and Herzegovina belong to pseudogley. Acid soils and low levels exchangeable phosphorus (P) as well as unfavourable physical properties are limiting factor of pseudogley fertility (Okiljevic et al., 1997, Resulovic and Custovic, 2002; Markovic et al., 2006). Aim of this paper was testing response of maize to liming and ameliorative phosphorus fertilization under conditions of Lijeve Polje (Lijeve Field) in the northern Bosnia.

## **Materials and methods**

### *General description of the Lijeve Polje area*

Lijeve polje is an area in the northern part of B&H, encompassing the Gradiska, Laktasi and Srbac municipalities. It is lowland area in the lower flow of the Vrbas river, extending from the Sava river to the north and the mountains Prosara to the west, Motajica to the east and Kozara to the southwest. Climate of this area is moderate continental. In general, soil is more fertile compared to the majority of agricultural areas in the country, although serious problems of aluminum toxicity were sporadically found (Okiljevic, 1982; Kovacevic et al., 1988). Climate of wide region area was elaborated by Komljenovic et al., 2014).

### *The field experiment*

This research was carried out on the Djurasinovic Family Farm in Lijeve Polje (Mahovljani willage, Laktasi municipality, Entity of Republic of Srpska, B&H) during four consecutive growing seasons, from 2009 to 2013, on pseudogley soil ( $\text{pH}_{1\text{N KCl}} = 4.28$ ) low supplied with plant available P and rich in potassium (K). The treatments included liming and P fertilization. P distribution as monoammonium phosphate (MAP: 12% N + 52%  $\text{P}_2\text{O}_5$ ) was conducted on November 10<sup>th</sup>, 2008 before ploughing. The rates of P on basic fertilization ( $160 \text{ N} + 75 \text{ P}_2\text{O}_5 + 75 \text{ K}_2\text{O} \text{ kg ha}^{-1}$ ) were as follows: 0, 500, 1000 and 1500  $\text{kg P}_2\text{O}_5 \text{ ha}^{-1}$ . Immediately after P fertilization the experiment plot was ploughed up to 30 cm in depth. Liming of the experiment by  $10 \text{ t ha}^{-1}$  of powdered hydratized lime (73% CaO + 2-3% MgO + 21% of bound water) was made on November 16<sup>th</sup>, 2008 (four replicates and basic plots  $40 \text{ m}^2$  and  $640 \text{ m}^2$  for P and liming treatments, respectively). Maize (the hybrid NS444) was grown in monoculture. Detailed information regarding crop management practice, soil properties, weather characteristics, statistical analysis, grain yield, grain moisture, protein-, starch- and oil- determinations until 2012, were shown in the previous studies (Komljenovic et al., 2013, 2015a, 2015b). Maize was sown in April 30 and harvested in November 2, 2013.

Weather conditions for maize growth in the 2013 growing season

Table 1. Precipitation and air-temperatures in Banja Luka (SY, 2014)

Year	The weather data (Banja Luka* Weather Bureau: LTM = long-term averages 1961-1990)									
	Jan.-April	May	June	July	Aug.	Sept.	Oct.	May-Oct.		
Precipitation (mm)										
2013	362	120	54	27	36	70	68	375		
LTM**	298	98	111	95	93	82	72	551		
Mean air-temperatures (°C)										
2013	6.2	16.6	20.4	23.0	23.5	16.7	13.1	18.9		
LTM	4.9	15.6	18.9	20.6	19.7	15.9	10.8	16.9		
Absolute and average maximum air-temperatures (°C), PET, AET, WD and WS (mm) in Banja Luka**										
Year	Absolute maximal temp.			Average maximal temp.			PET	AET	WD	WS
	June	July	August	June	July	August	June –August (sum)			
2013	36.0	41.6	41.1	26.4	30.7	31.3	101.54	67.52	34.01	0

\* air-distance from the experiment site: Banja Luka = about 20 km in S direction  
 \*\* PET = potential (PET) and actual (AET) evapotranspiration, water deficit (WD) and water surplus (WS)

The 2013 growing season was less favorable for maize growing, mainly due to precipitation deficit in July and August (Fig 1). According data for Banja Luka Weather Bureau precipitation in amount 63 mm was only about third part in comparison with the average 1961-1990. At the same period air temperature was for 3.0 °C higher and absolute maximal temperatures were above 41 °C (Table 1).

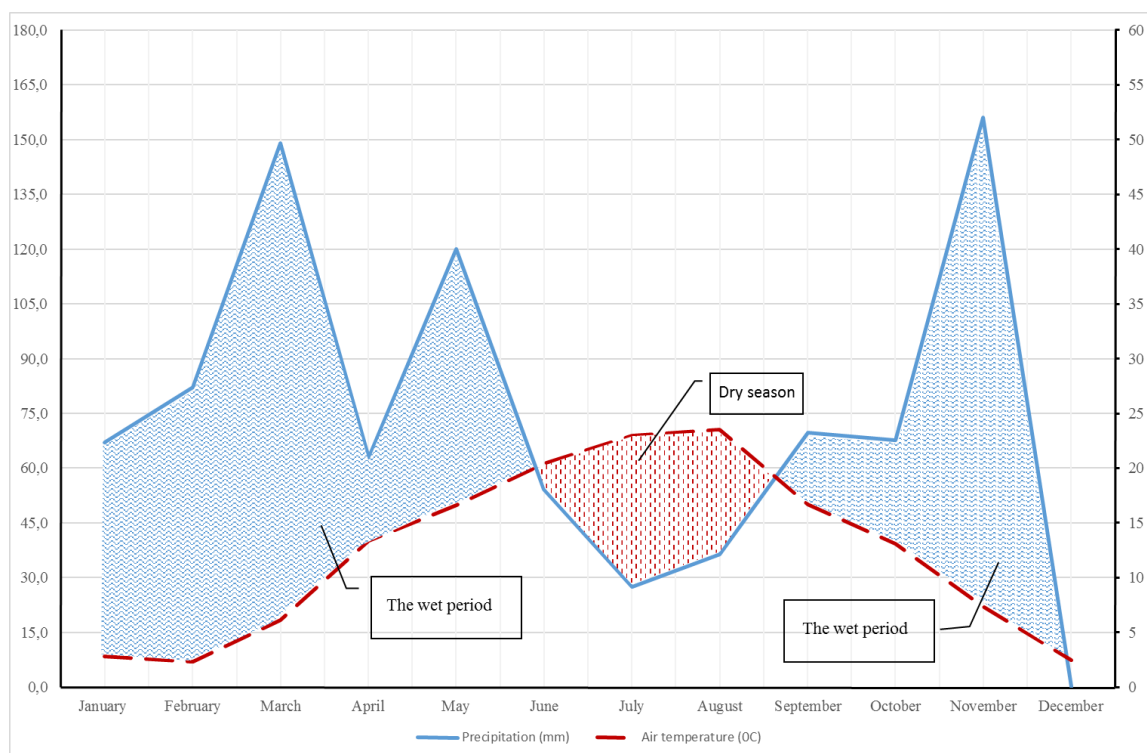


Fig. 1. Climate diagram by H. Walther for 2013 growing season for Banja Luka area

There is a noticeable lack of moisture in the period from the beginning of June to the first half of September in 2013 growing season, therefore in the critical period from the beginning of flowering, fertilization, and filling of grains. This was reflected in the yield of corn grain in the 2013 growing season (Table 1, Fig 1 and Table 3).

## Results and discussion

Average grain yield of maize in the experiment for the 2013 growing season was 5.12 t ha<sup>-1</sup> with considerably liming effects (2.86 and 7.38 t ha<sup>-1</sup>, for control and limed treatment, respectively). Main reasons of low yield of maize under control treatment compared to lime application were considerable lower realized plant density (averages 70.8% and 94.5%) and the higher rate of barren plants (averages 37.6% and 7.6%) under acid stress conditions. Grain moisture at harvest was independent on liming (Table 2).

However, P effect was considerably lower compared to liming effect. With that regard, significant yield increases for 32% was realized by application the highest rate of P fertilizer. Realized plant density was independent on P fertilization, while barren plants contribution was significantly decreased (25.0% and 19.8%, respectively) by application of the highest P rate (Table 2).

Impacts of liming on grain quality parameters (protein, oil and starch contents) in 2013 were non-significant, while P use resulted by significant increases only oil contents (Table 3).

Josipovic et.al. (2013) are reported that liming had considerably effects on increase of protein contents in maize grain from 9.9% (the control) to 10.6% (lime 10 t ha<sup>-1</sup>), while by the using ameliorative PK-fertilization there is tendency to increases of maize grain protein contents. A grain starch content was independent on liming and PK-treatments on very acid soil located near Pavlovac in Croatia.

Table 2. Response of maize (the 2013 growing season) to liming and phosphorus fertilization (November 2008).

Liming (the factor A) by the hydrated lime (A1 = 0, A2 = 10 t ha <sup>-1</sup> ) and ameliorative phosphorus (P <sub>2</sub> O <sub>5</sub> kg ha <sup>-1</sup> : B1= 0, B2 = 500, B3 = 1000, B4 = 1500 ) fertilization (the factor B) in autumn 2008: impacts on maize status in the 2013 growing season ( realized plant density:100% = 57143 plants ha <sup>-1</sup> )												
P <sub>2</sub> O <sub>5</sub> * kg ha <sup>-1</sup>	Lime			Lime			Lime			Lime		
	A1	A2	x B	A1	A2	x B	A1	A2	x B	A1	A2	x B
	Grain yield (t ha <sup>-1</sup> )			Grain moisture at harvest (%)			Realized plant density (% of planned)			Barren plants (%)		
B1	2.50	6.55	4.52	18.5	18.5	18.5	64.3	96.5	80.4	39.4	10.7	25.0
B2	2.74	7.00	4.87	18.4	18.7	18.6	70.0	95.4	82.7	39.3	9.4	24.3
B3	2.90	7.33	5.15	18.4	18.7	18.6	73.9	93.6	83.7	39.6	9.6	24.6
B4	3.29	8.65	5.97	18.5	18.0	18.3	75.2	92.5	83.8	32.0	7.6	19.8
x A	2.86	7.38		18.5	18.5		70.8	94.5		37.6	9.3	
	P <sub>0.05</sub>		P <sub>0.01</sub>	P <sub>0.05</sub>		P <sub>0.01</sub>	P <sub>0.05</sub>		P <sub>0.01</sub>	P <sub>0.05</sub>		P <sub>0.01</sub>
A	0.85		1.22	ns			8.8		12.3	8.7		11.3
B	0.53		0.76	ns			ns			4.6		ns
AB	1.92		1.38	ns			ns			13.9		19.4
* basic fertilization of all treatments (160 N + 75 P <sub>2</sub> O <sub>5</sub> + 75 K <sub>2</sub> O kg ha <sup>-1</sup> ); in the next years (2009-2013) only basic fertilization of the experiment.												

Table 3. Response of maize (the 2013 growing season) to liming and phosphorus fertilization (November 2008).

Liming (the factor A) by the hydrated lime (A1 = 0, A2 = 10 t ha <sup>-1</sup> ) and ameliorative phosphorus (P <sub>2</sub> O <sub>5</sub> kg ha <sup>-1</sup> : B1= 0, B2 = 500, B3 = 1000, B4 = 1500 ) fertilization (the factor B) in autumn 2008: impacts on grain quality parameters in the 2013 growing season											
P <sub>2</sub> O <sub>5</sub> * kg ha <sup>-1</sup>	Lime			Lime			Lime				
	A1	A2	x B	A1	A2	x B	A1	A2	x B		
	Protein (%)			Oil (%)			Starch (%)				
B1	8.95	9.25	9.10	3.38	3.30		67.85	66.43			
B2	9.33	9.43	9.38	3.73	3.55		68.00	67.80			
B3	9.23	9.34	9.29	3.69	3.73		68.13	68.00			
B4	9.38	9.35	9.37	3.63	3.58		68.83	69.52			
x A	9.22	9.34		3.68	3.62		68.32	68.44			
	P <sub>0.05</sub>		P <sub>0.01</sub>		P <sub>0.05</sub>		P <sub>0.01</sub>		P <sub>0.05</sub>		P <sub>0.01</sub>
A	ns				ns				ns		
B	ns				0.18		0.25		ns		
AB	ns								ns		
* basic fertilization of all treatments (160 N + 75 P <sub>2</sub> O <sub>5</sub> + 75 K <sub>2</sub> O kg ha <sup>-1</sup> ); in the next years (2009-2013) only basic fertilization of the experiment.											

Also, in the 4-year period of 2009-2012 liming considerably affected on grain yield of maize by average yield increase for 31% with differences among years from 18% in 2010 to 47% in 2011. As in 2013 growing season, P fertilization impact was considerably lower because yields were increased in three years from 6% in 2009 to 19% in 2011, while in 2012 differences of yield among P treatments were non-significant. By comparison of yield realized by three ameliorative P rates and the control, P effect on maize yield was only 8% (4-year averages: 6.14 and 6.65 t ha<sup>-1</sup>, for control and P rates, respectively). With exception of the first year of testing, for significant increase of maize yield was adequate the lowest rate of applied P in amount 500 kg P<sub>2</sub>O<sub>5</sub> ha<sup>-1</sup> (Table 4). Response of maize to liming and P fertilization in 2009-2012 period elaborated in our earlier studies (Kojljjenovic et al., 2013, 2015a, 2015b).

Table 4. Response of maize to liming and P fertilization in the 2009-2012 period (Kojljjenovic et al., 2013, 2015a, 2015b)

Liming (the factor A) by the hydrated lime (A1 = 0, A2 = 10 t ha <sup>-1</sup> ) and ameliorative phosphorus (P <sub>2</sub> O <sub>5</sub> kg ha <sup>-1</sup> : B1= 0, B2 = 500, B3 = 1000, B4 = 1500 ) fertilization (the factor B) in autumn 2008: impacts on grain yield of maize in four consecutive growing seasons 2009 -2012												
	2009			2010			2011			2012		
	A1	A2	x B	A1	A2	x B	A1	A2	x B	A1	A2	x B
	Grain yield (t ha <sup>-1</sup> )			Grain yield (t ha <sup>-1</sup> )			Grain yield (t ha <sup>-1</sup> )			Grain yield (t ha <sup>-1</sup> )		
B1	7.30	10.07	8.68	7.97	9.92	8.94	4.40	5.53	4.97	1.82	2.08	1.95
B2	7.37	10.65	9.01	8.66	10.28	9.47	4.59	7.19	5.89	1.98	2.24	2.11
B3	7.61	10.66	9.13	9.23	10.24	9.73	4.60	7.09	5.85	1.85	2.36	2.11
B4	7.82	10.60	9.21	8.55	10.17	9.36	4.68	7.06	5.87	1.67	2.49	2.08
x A	7.52	10.49	<b>9.00</b>	8.60	10.15	<b>9.38</b>	4.57	6.72	<b>5.65</b>	1.83	2.29	<b>2.06</b>
A effect			+39%			+18%			+47%			+25%
B effect			+6%			+9%			+19%			ns
	A	B	AB	A	B	AB	A	B	AB	A	B	AB
P 0.05	0.81	0.43	ns	0.32	0.33	ns	0.45	0.34	0.49	0.17	ns	ns
P 0.01	1.49	ns	ns	0.59	0.45		0.83	0.47	0.67	0.30		

## Conclusions

The results of the study of the impact of liming and P fertilization in 2013 growing season in the Mahovljani (the fifth year of research), clearly show the extended effect of the applied agroameliorative measures on maize grain yield. On the treatment where is applied 10 t ha<sup>-1</sup> lime material and phosphorus fertilizer, the yield of maize was 7.86 t ha<sup>-1</sup> which was higher for 4.52 t ha<sup>-1</sup> or 258% than the control variant (2.586 t ha<sup>-1</sup>). However, the same effect was not reflected on the quality properties of corn grains.

## References

- Jelic M., Milivojevic J., Dugalic G., Djekic V., Sekularac G., Paunovic A., Biberdzic M., Tmusic N. (2015): Liming of acid soils in central Serbia. XX Savjetovanja o biotehnologiji. University of Kragujevac. Faculty of agronomy Cacak., Proceedings, Vol. 20 (22), pp 51-58.
- Josipovic M., Kovacevic V., Brkic I. (2013): Liming and PK-fertilization effects on maize yield and grain quality. . Proceedings of 12th Alps-Adria Scientific Workshop Opatija, Doberdò, Venezia –Croatia–Italy, Növénytermelés 62 (Suppl.): 75-78.
- Komljenovic I., Markovic M., Djurasinovic G., Kovacevic V. (2013): Response of maize to liming and ameliorative phosphorus fertilization. *Advanced Crop Science* 3 (3): 225–232.
- Komljenovic I., Misic M., Markovic M., Pesevic D., Markovic M. (2014): The climate data analysis of Banja Luka area as the basis of agricultural adaptation to climate change planning, In: Conference proceedings of People, Buildings and Environment 2014, an international scientific conference, Kroměříž, Czech Republic, pp. 592-603 (ISSN: 1805-6784).
- Komljenović I., Markovic M., Djurasinovic G., Kovacevic V. (2015a): Response of maize to liming and ameliorative phosphorus fertilization. *Novenytermeles* 64 (Suppl.): 35-38.
- Komljenovic I., Markovic M., Djurasinovic G., Kovacevic V. (2015b): Response of maize to liming and phosphorus fertilization with emphasis on weather properties effects. . *Columella - Journal of Agricultural and Environmental Sciences* 2 (1): 29-35.
- Markovic M, Supic D (2003). Osobine pseudogleja na području Gradiške s prijedlogom meliorativnih mjera (Pseudogley properties of Gradiska area with recommendation of their agromelioration) . *Agroznanje* IV: 142-154.
- Markovic M, Komljenovic I, Delalic Z, Kovacevic V (2006). Phosphorus a limiting factor of the field crops yield under conditions of the northern Bosnia. *Lucrari Stiintifice, Seria Agronomie, Universitatea de Stiinte Agricole si Medicina Veterinaria Iasi*, 49: 218-222.
- Okiljevic V, Predic T, Lukic R, Markovic M (1997): Poljoprivredno zemljište Republike Srpske /Agricultural soils of Republic of Srpska/, *Agroznanje* I (1): 15-23.
- Resulovic H, Custovic H (2002). *Pedologija, Opšti dio (knjiga 1) / Soil Science, General Part (book 1)*. University of Sarajevo.



## GERMINATION CHARACTERS AND EARLY SEEDLING GROWTH OF WHEAT (*Triticum aestivum* L.) VARIETIES UNDER SALT STRESS CONDITIONS

Mirjana JOVOVIĆ<sup>1\*</sup>, Vesna TUNGUZ<sup>1</sup>, Milan MIROSAVLJEVIĆ<sup>2</sup>, Novo PRŽULJ<sup>3,1</sup>

<sup>1</sup>University in East Sarajevo, Faculty of Agriculture, Bosnia and Herzegovina

<sup>2</sup>Institute of Field and Vegetable Crops, Novi Sad, Serbia

<sup>3</sup>University in Banja Luka, Faculty of Agriculture, Bosnia and Herzegovina

\*Corresponding author: mirjanamojevic@gmail.com

### Abstract

The aim of this study was to determine the most tolerant winter wheat varieties to the influence of salinity at germination stage and early seedlings growth. The salinity stress was simulated in controlled conditions by adding different concentrations of NaCl solution to the growing media of five winter wheat variety. In all studied varieties the benchmark water potential in which they had germinated and had a good seedlings growth was of -0.3MPa. Under the stronger stress, -0.6MPa, all varieties showed reduction in the all examined parameters. The variety Bosanka, had the highest final germination and germination energy under salt stress. The parameters defining the development or percentage of strong seeds, coleoptile and root length, fresh and DW of root and coleoptile of a seed were more affected by salt stress than germination and germination energy. Biplot analysis showed that wheat cultivars grown under -0.6MPa osmotic had higher values of root/coleoptile ratio in relation to control and -0.3MPa treatment which is the most reliable for screening properties of the genotypes for drought resistance in seedling stage.

**Key words:** Winter wheat (*Triticum aestivum* L.), tolerance, NaCl, osmotic potential, biplot analysis

### Introduction

Wheat (*Triticum aestivum* L.) is regarded as one of the most important cereal crop, grown in different regions that can be characterized with increased salt level in the soil (Rana et al., 2013). It is a cereal grain that belongs to Poaceae family, which has been known as a semi-tolerant plant to drought and moderately salt-tolerant (Tester et al., 2003). Winter wheat is more salt tolerant compared to other crops such as durum wheat (*Triticum turgidum* ssp. *durum* L.), maize (*Zea mays* L.) and sorghum (*Sorghum bicolor* L.) (Fita et al., 2015). Stresses from the surrounding environment are limiting factor of agricultural production worldwide Roy et al. (2011). Germination is the basic indicator of seed quality and it highly depends on biotic and abiotic factors Vujakovic et al. (2011). The availability of water and its movement in the seed are very important for the process of germination, early growth and root elongation of coleoptile. These processes are under the influence of chemical potential, texture and the contact area of seed and soil. Salinity delays or prevents the seed germination through various factors, such as reduction of water availability, changes in the mobilization of stored reserves and affecting the structural organization of proteins TEMEL et al. (2015). Considering that the germination process is not possible without water, the main negative effect of salt in soils is reflected in creating osmotic potentials that will prevent the seeds from absorbing a sufficient amount of water and sprouts. Plant reaction to increased soil salinity manifests in stopping or reducing rate and duration of vegetative growth and leaf development (Läuchli and Grattan, 2007). Reduction in growth is a consequence of more physiological

responses including modifications of ion balance, water status, mineral nutrition, stomatal behavior, photosynthetic efficiency (Tavakkoli et al., 2010). The selection of genotypes that tolerate salt stress in this stage is therefore important, especially if the tolerance in the germination stage correlated with tolerance to salt, with the period of grain filling. The aims of this study were to examine the seed viability of selected winter wheat cultivars in saline stress and to determine the most tolerant cultivars to salinity stress at germination stage and early seedlings growth

## **Materials and Methods**

### ***The experiment***

The tests included examination parameters of germination in five different varieties of winter wheat (Jelena, Kristina, Orion, Bosanka and Nova Bosanka) under controlled conditions in the laboratory of the Faculty of Agriculture in East Sarajevo, Bosnia and Herzegovina. Three replicates of 50 uniform, healthy seeds were sterilized in 96 % alcohol for 30 seconds, washed with distilled water several times, and transferred into sterile Petri dishes. A double layer of filter paper was in a dish saturated with solution determined concentration of salt (Table 1) and it is dissolved with water potential close to zero (control), then -0.3 and -0.6MPa. Into each petri dish 15 ml of solution was dispensed. Control petri dishes were filled with distilled water. Sodium chloride to induce stress of salt. Petri dishes were incubated for 7 days, at the temperature of 25°C. During this experiment, the following parameters were determined: germination energy, final germination, Vigor Test or percentage of strong seeds, coleoptile and root length, fresh and DW of root and coleoptile, and root/coleoptile DW ratio. To determine the DW of the root and coleoptile seedlings were dried for 24 hours at 80°C.

### ***Data analysis***

Data was processed using two-way analysis of variance, with software Infostat 10. Means were compared using Duncan's multiple range test. Principal component analysis (PCA) was used to determine interdependence between the traits.

## **Results and Discussion**

Results from our study showed that increase in osmotic potential had an adverse effect on wheat final germination and germination energy (Table 1). By increasing NaCl concentration (decreasing osmotic potential), germination energy and germination percent decreased almost linearly in studied wheat cultivars. The variety Orion was the most sensitive variety to the influence of lowest osmotic potential (-0.6MPa) and its germination energy compared to control reduced from 92% to 5%. Percentage of germination decreased by 69% in salt stress compared to the control. Decrease and delay in germination of winter wheat in saline medium, have also been reported by Rahman et al. (2000). The cultivar with highest germination percentage at zero potential, -0.3MPa and -0.6 MPa was Bosanka. Therefore, this cultivar could be grown under decreased osmotic conditions. Similar results were obtained by Braga et al. (1999), in seeds of bean where the potentials between -0.4 and - 0.6MPa, led to a decline in the value of parameters examined as germination percentage and germination.

There was a significant difference in the parameter vigor classification (Table 1) and by decreasing osmotic potential vigor percent declined gradually from 0MPa to -0.3MPa and further drastically at -0.6MPa under salt treatment. Generally, most wheat varieties were sensitive to the influence of osmotic potential of -0.6MPa where their values drastically fall close to zero. Khatun et al. (2013), and Moud and Maghsoudi (2008) also found differential sensitivity of wheat genotypes based on seedling growth in their studies and they suggested

that seedling growth is one of the most important characters for screening salt tolerance during an early stage of the growth.

Table 1. Impact of water deficit induced by NaCl concentrations during germination on five wheat varieties

Water deficit induced by NaCl concentrations* during germination and wheat varieties* status											
NaCl (MPa)				NaCl (MPa)				NaCl (MPa)			
0	-0.3	-0.6	x	0	-0.3	-0.6	x	0	-0.3	-0.6	x
Germination energy (%)				Germination (%)				Vigor (%)			
84.3 <sup>b</sup>	84.7 <sup>b</sup>	70.3 <sup>d</sup>	79.8 <sup>A</sup>	87.7 <sup>bc</sup>	86.7 <sup>c</sup>	71.7 <sup>efg</sup>	82.0 <sup>A</sup>	60.3 <sup>b</sup>	11.3 <sup>f</sup>	0 <sup>g</sup>	23.9 <sup>C</sup>
92.0 <sup>a</sup>	77.3 <sup>c</sup>	49.7 <sup>f</sup>	73.0 <sup>B</sup>	94.3 <sup>ab</sup>	78.7 <sup>d</sup>	51.7 <sup>h</sup>	74.9 <sup>B</sup>	80.3 <sup>a</sup>	21.3 <sup>e</sup>	11.0 <sup>f</sup>	37.6 <sup>A</sup>
76.3 <sup>c</sup>	76.3 <sup>c</sup>	41.7 <sup>g</sup>	64.8 <sup>C</sup>	77.3 <sup>de</sup>	76.3 <sup>de</sup>	66.7 <sup>g</sup>	73.4 <sup>B</sup>	47.6 <sup>c</sup>	25.3 <sup>e</sup>	0 <sup>g</sup>	24.3 <sup>C</sup>
49.7 <sup>f</sup>	78.0 <sup>c</sup>	58.0 <sup>e</sup>	61.9 <sup>D</sup>	74.0 <sup>def</sup>	79.0 <sup>d</sup>	69.0 <sup>fg</sup>	74.0 <sup>B</sup>	25.7 <sup>e</sup>	25.3 <sup>e</sup>	0 <sup>g</sup>	17.0 <sup>D</sup>
96.7 <sup>a</sup>	66.7 <sup>d</sup>	8.0 <sup>h</sup>	57.1 <sup>E</sup>	96.7 <sup>a</sup>	71.0 <sup>efg</sup>	30.0 <sup>i</sup>	65.9 <sup>C</sup>	47.0 <sup>c</sup>	33.7 <sup>d</sup>	11.3 <sup>f</sup>	30.7 <sup>B</sup>
79.8 <sup>A</sup>	76.6 <sup>B</sup>	45.5 <sup>C</sup>	67.3	86.0 <sup>A</sup>	78.3 <sup>B</sup>	57.8 <sup>C</sup>	74.0	52.2 <sup>A</sup>	23.4 <sup>B</sup>	4.5 <sup>C</sup>	26.9
Coleoptile length (mm)				Root length (mm)				Coleoptile fresh weight (g)			
69.4 <sup>b</sup>	34.0 <sup>f</sup>	3.7 <sup>h</sup>	35.7 <sup>C</sup>	67.7 <sup>b</sup>	54.2 <sup>c</sup>	17.7 <sup>e</sup>	46.5 <sup>C</sup>	0.527 <sup>b</sup>	0.334 <sup>d</sup>	0.047 <sup>f</sup>	0.297 <sup>C</sup>
59.0 <sup>c</sup>	41.4 <sup>e</sup>	3.0 <sup>h</sup>	22.1 <sup>D</sup>	71.1 <sup>b</sup>	57.7 <sup>c</sup>	21.3 <sup>e</sup>	50.0 <sup>B</sup>	0.680 <sup>a</sup>	0.413 <sup>c</sup>	0.222 <sup>e</sup>	0.438 <sup>B</sup>
69.7 <sup>b</sup>	47.9 <sup>de</sup>	20.8 <sup>g</sup>	46.1 <sup>A</sup>	71.2 <sup>b</sup>	67.3 <sup>b</sup>	35.9 <sup>d</sup>	58.1 <sup>A</sup>	0.743 <sup>a</sup>	0.571 <sup>b</sup>	0.202 <sup>e</sup>	0.505 <sup>A</sup>
80.2 <sup>a</sup>	47.7 <sup>de</sup>	7.9 <sup>h</sup>	45.3 <sup>A</sup>	53.3 <sup>c</sup>	53.7 <sup>c</sup>	30.0 <sup>d</sup>	45.7 <sup>C</sup>	0.690 <sup>a</sup>	0.506 <sup>b</sup>	0.058 <sup>f</sup>	0.418 <sup>B</sup>
52.3 <sup>d</sup>	44.5 <sup>e</sup>	20.3 <sup>g</sup>	39.0 <sup>B</sup>	79.1 <sup>a</sup>	70.0 <sup>b</sup>	19.9 <sup>e</sup>	56.3 <sup>A</sup>	0.553 <sup>b</sup>	0.528 <sup>b</sup>	0.224 <sup>e</sup>	0.435 <sup>B</sup>
66.1 <sup>A</sup>	35.6 <sup>B</sup>	11.2 <sup>C</sup>	37.6	68.5 <sup>A</sup>	60.6 <sup>B</sup>	25.0 <sup>C</sup>	51.3	0.635 <sup>A</sup>	0.471 <sup>B</sup>	0.151 <sup>C</sup>	0.419
Root fresh weight (g)				Root dry weight (g)				Coleoptile dry weight (g)			
0.031 <sup>ef</sup>	0.026 <sup>ef</sup>	0.020 <sup>g</sup>	0.026 <sup>D</sup>	0.012 <sup>h</sup>	0.010 <sup>i</sup>	0.007 <sup>j</sup>	0.010 <sup>D</sup>	0.066 <sup>d</sup>	0.026 <sup>g</sup>	0.009 <sup>h</sup>	0.034 <sup>E</sup>
0.054 <sup>b</sup>	0.090 <sup>a</sup>	0.055 <sup>b</sup>	0.066 <sup>A</sup>	0.018 <sup>ab</sup>	0.017 <sup>bc</sup>	0.016 <sup>cd</sup>	0.017 <sup>A</sup>	0.079 <sup>b</sup>	0.069 <sup>d</sup>	0.034 <sup>f</sup>	0.060 <sup>A</sup>
0.061 <sup>b</sup>	0.035 <sup>de</sup>	0.042 <sup>cd</sup>	0.046 <sup>B</sup>	0.014 <sup>ef</sup>	0.011 <sup>hi</sup>	0.008 <sup>j</sup>	0.011 <sup>C</sup>	0.083 <sup>b</sup>	0.029 <sup>g</sup>	0.003 <sup>i</sup>	0.038 <sup>D</sup>
0.053 <sup>b</sup>	0.052 <sup>bc</sup>	0.021 <sup>g</sup>	0.042 <sup>C</sup>	0.015 <sup>de</sup>	0.013 <sup>fg</sup>	0.008 <sup>j</sup>	0.012 <sup>B</sup>	0.089 <sup>a</sup>	0.067 <sup>d</sup>	0.012 <sup>h</sup>	0.056 <sup>B</sup>
0.036 <sup>de</sup>	0.091 <sup>a</sup>	0.023 <sup>fg</sup>	0.050 <sup>B</sup>	0.012 <sup>gh</sup>	0.019 <sup>a</sup>	0.005 <sup>k</sup>	0.012 <sup>B</sup>	0.074 <sup>c</sup>	0.058 <sup>e</sup>	0.003 <sup>i</sup>	0.044 <sup>C</sup>
0.047 <sup>B</sup>	0.059 <sup>A</sup>	0.032 <sup>C</sup>	0.046	0.014 <sup>A</sup>	0.014 <sup>A</sup>	0.009 <sup>B</sup>	0.012	0.078 <sup>A</sup>	0.050 <sup>B</sup>	0.012 <sup>C</sup>	0.047
Root /coleoptile ratio				* Wheat varieties				* NaCl amounts in different levels of water deficit			
0.173 <sup>f</sup>	0.386 <sup>de</sup>	0.825 <sup>c</sup>	0.462 <sup>C</sup>	<b>a</b>	Bosanka			<b>Ψ<sub>0</sub></b> the level of MPa		NaCl (g/l distilled water)	
0.231 <sup>ef</sup>	0.248 <sup>ef</sup>	0.481 <sup>d</sup>	0.320 <sup>D</sup>	<b>b</b>	Jelena						
0.167 <sup>f</sup>	0.375 <sup>de</sup>	2.536 <sup>a</sup>	1.026 <sup>A</sup>	<b>c</b>	Kristina			0	0		
0.169 <sup>f</sup>	0.198 <sup>ef</sup>	0.689 <sup>c</sup>	0.352 <sup>D</sup>	<b>d</b>	Nova Bosanka			-0.3	4.20		
0.161 <sup>f</sup>	0.332 <sup>de</sup>	1.439 <sup>b</sup>	0.644 <sup>B</sup>	<b>e</b>	Orion			-0.6	8.40		
0.180 <sup>C</sup>	0.308 <sup>B</sup>	1.194 <sup>A</sup>	0.560	x	Average						

Different letters indicate significant difference at P < 0.05 level.

Coleoptile and root length (Table 1) in our experiment interfered differently. At zero potential, both coleoptiles and root lengths reached their highest values. Other treatments gradually reduced seedling growth. At zero potential the highest root length was reported in the variety Orion followed by variety Jelena and Kristina. The Nova Bosanka variety had one of the highest coleoptile length at zero potential. On the other hand, it was among the most sensitive varieties to the influence of decreased osmotic potential since its coleoptiles length significantly decreased at -0.6 MPa. High salt concentration inhibits plant growth (Cuartero et al., 1999) and affects many aspects of plant metabolism, resulting in reduced growth and grain yield. Moud and Maghsoudi (2008) found significant differences among cultivars in terms of coleoptiles and root growth under salt-stress conditions and stated that salt stress inhibited coleoptile growth more than root growth. Related result is published by Qayyum (2011) in investigation of the effect of water deficiency on germination of different wheat genotypes, who found that the length of the coleoptile was significantly decreased in the water potential of -0.8 bar.

Fresh weight of coleoptiles and root (Table 1) were differently affected by water deficits. Under salt treatment, coleoptiles fresh weight decreased with increase of osmotic stress. Under NaCl stress root average fresh weight at water deficit of -0.3MPa showed higher weight (0.059g) than at zero potential (0.047g).

Across treatment, wheat varieties significantly differed in coleoptile dry weight (DW). One of the varieties, with highest average of coleoptile DW, was Jelena, as it had the highest coleoptile DW under conditions of -0.6MPa. Similar results were obtained for root dry weight. There were no differences between control and low salt stress in root dry weight. At -0.6 MPa the variety Kristina had the lowest root dry weight. These results indicate that low salt concentrations stimulate the roots growth. Significant reduction of root growth occurred only at highest NaCl concentration. Our results are in agreement with Machado Neto et al. (2004) they reported that in soybean roots DW decrease under conditions of high salinity in soybean.

Root/coleoptile ratio (RCR) is one of the several ratios which gives estimates of the distribution of DM between the different plant organs (Hunt 1990). It is a measure of distribution of DM between the root and the shoot systems and it is a good indicator for effects on root and shoot dry weights. The RCR was under significant influence of NaCl level (Table 1). Under NaCl treatment RCR across varieties increased from 0.180 (control) to 0.308 (-0.3MPa) and to 1.194 (-0.6MPa). Across treatment wheat varieties significantly differed in RCR. The variety with average highest RCR ratio was Kristina and also had highest RCR under conditions of -0.6 MPa. Our results are in agreement with (Maghsoud et al., 2008) who reported increase of RCR in wheat cultivars under the conditions of salt stress. This kind of an increase in RCR indicates that proportion of DM allocated to the coleoptile was decreased compared to the roots.

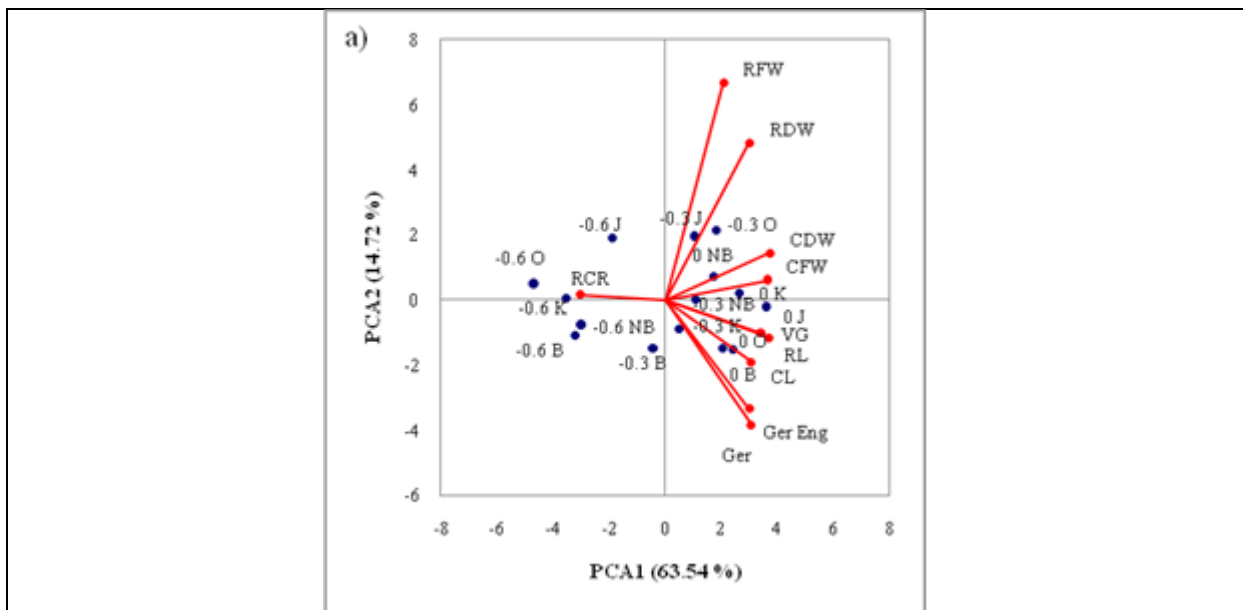


Figure 1. PCA analysis of trait association of winter wheat cultivars (Bosanka – B, Kristina – K, Jelena – J, Nova Bosanka – NB and Orion – O) grown under different level (0 MPa – O, -0.3 MPa – -0.3 and -0.6 MPa – -0.6) of NaCl

The biplot of the principal component analysis (PCA) illustrates the relationships between the means of the studied traits in wheat cultivars grown under different level of NaCl (Figure 1). The cultivar × treatment points and traits vector are placed on biplot according to their PCA scores. Biplot revealed similar interrelationship between studied traits in wheat cultivars at

different NaCl levels. Germination (Ger) and germination energy (GerEng) were in high positive association as indicated by acute angles. Moreover, root fresh (RFW) and DW (RDW) and coleoptile fresh weight (CFW) and DW(CDW) were highly associated under influence of different NaCl level. There was positive association between root and coleoptile weight (both dry and fresh). Root length was in positive association with GerEng, indicating an early germination improves root growth. On the other hand, under conditions of NaCl treatment coleoptiles length (CL) was in positive association with Ger and GerEng. Biplot showed that wheat cultivars grown under lowest osmotic potential (-0.6MPa) had higher values of root/coleoptiles ratio (RCR) in relation to control and -0.3MPa treatment. This data indicates that coleoptile growth is more suppressed than root under condition of low osmotic potential.

### **Conclusion**

Based on the results of this study it can be concluded that there are significant differences between the examined cultivars. Although the gradual increase of the NaCl treatment was followed by a reduction in all the analyzed parameters in selected cultivars. Significant decrease occurred only at high salt treatments (-0.6MPa) and it could be an indication of their sensitivity to stressful conditions. We can conclude that the limit values of water resources when plant, under the influence of sodium chloride, in all varieties can germinate quite well and have a good increase in seedling were at -0.3 MPa, i.e. in low stress. Salt tolerance for seedling DW maintained a significant positive correlation with rate of germination, germination vigor index, shoot length, and root length, which indicates that these parameters could be used as selection criteria for screening wheat genotypes against salt stress. Besides the standard techniques and commonly used data analysis, biplot offer additional options, preferably in the portion of a visual representation and understanding of important interactions that shown in the present data sets from surveys seed science research.

### **References**

- Braga, L. F., Sousa, M. P., Braga, J. F., Sá, M. E. (1999): Efeito da disponibilidade hídrica do substrato na qualidade fisiológica de feijão. *Revista Brasileira de Sementes* 21: 95-102.
- Fita, A., Rodríguez-Burruezo, A., Boscaiu M., Prohens J., Vicente O. (2015): Breeding and domesticating crops adapted to drought and salinity: a new paradigm for increasing food production. *Front. Plant Sci.* 6:978.
- Cuartero, J., Munoz, R.F. (1999): Tomato and salinity. *Scientia Horticulture.* 78:83–125.
- Hunt, R. (1990). *Basic Growth Analysis: Plant growth analysis for beginners.* Unwin Hyman, London.
- Khatun, M., Hafiz, MHR., Hasan, MA., Hakim, MA, Siddiqui, MN. (2013): Response of wheat genotypes to salt stress in relation to germination and seedling growth. *Int. J. Biores. Stress Manag.* 4(4): 635-640
- Läuchli, A., Grattan, S. (2007): *Plant Growth And Development Under Salinity Stress.* In: Jenks M.A., Hasegawa P.M., Jain S.M. (eds) *Advances in Molecular Breeding Toward Drought and Salt Tolerant Crops.* Springer, Dordrecht.
- Machado - Neto, Santurino, M.S., Bomfim, C.D., Custodio, C.C. (2004): Water Stress Induced by Mannitol and Sodium Chloride in Soybean Cultivars, 47: 521-529.
- Moud, A.M., K. Maghsoudi. (2008): Salt Stress Effects on Respiration and Growth of Germinated Seeds of Different Wheat (*Triticum aestivum* L.) Cultivars. *World J Agri Sci* 4 (3): 351-358.

- Qayyum, A., Razzaq, A., Ahmad, M., Jenks, M. (2011): Water stress causes differential effects on germination indices, total soluble sugar and proline content in wheat (*Triticum aestivum* L.) genotypes. *African Journal of Biotechnology*.10: 14038-14045.
- Rahman, M., Kayani, S.A., Gul, S. (2000): Combined effects of temperature and salinity stress on corn cv. Sunahry. *Pak. J. Biol.Sci.* 3(9): 1459-1463
- Rana, R.M., Rehman, S., Ahmed, J., Bilal, M. (2013): A comprehensive overview of recent advances in drought stress tolerance research in wheat (*Triticum aestivum* L.). *Asian Journal of Agriculture and Biology* 1: 29–37.
- Roy, S.J., Tucker, E.J., Tester, M. (2011). Genetic analysis of abiotic stress tolerance in crops. *Curr Opin. Plant Biol* 14: 232-239.
- Tavakkoli, E., Rengasamy, P., McDonald, K.G. (2010): High concentrations of Na<sup>+</sup> and Cl<sup>-</sup> ions in soil solution have simultaneous detrimental effects on growth of faba bean under salinity stress. *Journal of Experimental Botany*, 61: 4449-4459.
- Temel, H.Y., Gol D., Kahriman, A., Tanyolac M.B. (2014): Single nucleotide polymorphism discovery through Illumina- based transcriptome sequencing and mapping in lentil. *Turk. J. Agric. For.* 38: 1–19.
- Tester, M., Davenport, R. (2003): Na<sup>+</sup> tolerance and Na<sup>+</sup> transport in higher plants. *Ann Bot.*, 91:503–527.
- Vujakovic M., S., Balešević-Tubić, D., Jovićić, K., Taški-Ajduković, D., Petrović, Z., Nikolić, V., D (2011): Viability of soybean seed produced under different agrometeorological conditions in Vojvodina. *Genetika* 43(3): 625 -638.

## MAINSTEM LEAF DEVELOPMENT IN SPRING BARLEY

Novo PRŽULJ<sup>1,5\*</sup>, Vojislava MOMČILOVIĆ<sup>2</sup>, Milan MIROSAVLJEVIĆ<sup>2</sup>, Zoran JOVOVIĆ<sup>3</sup>, Dragan MANDIĆ<sup>4</sup>, Miloš NOŽINIĆ<sup>4</sup>

<sup>1</sup>Faculty of Agriculture, University of Banja Luka, Bosnia and Herzegovina

<sup>2</sup>Institute of Field and Vegetable Crops, Novi Sad, Serbia

<sup>3</sup>Biotechnical Faculty, University of Montenegro, Montenegro

<sup>4</sup>Agricultural Institute of the Republic of Srpska, Banja Luka, Bosnia and Herzegovina

<sup>5</sup>Faculty of Agriculture, University of East Sarajevo, Bosnia and Herzegovina

\*Corresponding author: novo.przulj@gmail.com

### Abstract

Interval between appearance of successive leaves (phyllochron, PI) in grasses is determined by timing of leaf initiation at the stem apex and duration of leaf tip elongation through the whorl of mature sheaths. The objective of this study was to evaluate PI of main stem leaf (MSL) development during tillering of six spring barley varieties, which differed in origin, earliness, spike type and some other traits. The studies were carried out in the field at the Institute of Field and Vegetable Crops Novi Sad, Serbia (45°20'N, 15°51'E, 86m asl) during 1999-2001 period. The experiments were arranged in a randomized complete block design with three replications and planting rate of 200 viable seeds per m<sup>-2</sup>. Three random plants in each plot were labeled for monitoring during growing. PI was estimated every 2-3 days using Haun scale. Growing-degree-days (GDD) were used as time scale with base temperature of 0°C. PI was the reciprocal of the slope determined by regression of MSL against GDD using data from each plant within a cultivar. When plotted against thermal time leaf appearance was a strictly linear function of temperature. Across cultivars, the lowest PI was in 2000 – 81 GDD and the highest in 2001 – 89 GDD. Across years and leaves PI arranged from 65.5 in the variety Gustoe to 80.1 in the variety Jelen. All three factors, i.e., year, variety, and their interaction, were included in the PI determination of the first leaf. In all three years, first leaf demanded more days for appearance due to lower temperatures and shorter daylength. Of all six leaves studied, the second leaf was most strongly influenced by genetic constitution of cultivars and 75% of total variation belonged to this component of variation. Variation of PI of the third, fourth and fifth leaf was mainly determined by interaction GxY and year. It seems that in our investigation temperatures had a strong effect on leaf appearance. The linearity suggests that MSL stage can be used as a predictive measure of plant development and it can retroactively show the quality of the preemergent seedbed environment.

**Keywords:** *Spring barley (Hordeum vulgare L.), phyllochron, Haun scale, tillering, growing degree days*

### Introduction

Morphological changes of barley plant can be used for the evaluation of both, plant development and growth environment (Klepper *et al.*, 1982; Rickman *et al.*, 1983). Mainstem leaf (MSL) appearance and proportion of tiller formation are parameters useful for the evaluation of germination and vegetative development. Haun (1973) developed a scale which quantitatively describes the vegetative developmental stages in spring wheat. The time spent for leaf elongation, i.e., the time from leaf appearance to the appearance of the next leaf, measured in growing-degree-days (GDD), is designated as phyllochron interval (PI). Fast

emergence is positively related with MSL (Krenzer and Nipp, 1991). Smaller PI, i.e., lower GDD, represents faster development and leaf appearance. PI is influenced by temperature and daylength (Cao and Moss, 1989a; 1989b). Baker *et al.* (1986) found a decrease and Kenzer *et al.* (1991) found an increase in PI in wheat under water deficit conditions, while Bauer *et al.* (1984) did not establish a dependence of MSL appearance on soil moisture content.

Investigations of Dofing (1995) and Sharratt (1999) referred to the subarctic environment, while little is known about MSL growth of spring barley in semiarid conditions of growing. The objective of this study was to evaluate MSL development during tillering of spring barleys, which differed in origin, earliness, spike type and some other traits, grown in a semiarid environment.

## Material and Methods

*Field trials.* Six spring barley varieties were grown in Novi Sad, (45° 20' N, 15° 51' E, 86m asl) from 1999 to 2001. The experiments were arranged in a randomized complete block design with three replications with plots 2m long and 1m wide, containing 6 rows 20 cm apart. The planting rate was 200 viable seeds per m<sup>2</sup>. Three random plants in each plot were labeled for monitoring during growing. Phyllochron was estimated every 2-3 days using Haun scale (Haun, 1973). Growing-degree-days (GDD) were used as time scale with base temperature of 0°C.

PI, measured as GDD per leaf, was the reciprocal of the slope determined by regression of MSL against GDD using data from each plant within a cultivar (Baker *et al.*, 1986). Only MSL measurements greater than or equal to 1.0 were used in the regression because it is difficult to estimate partial emergence of the first leaf since there is no antecedent leaf for comparison.

*Statistical analysis.* A mixed model was used with varieties considered as fixed and years as random effects (Zar, 1996). Heritability for a single year was estimated as the ratio  $\sigma^2_G / (\sigma^2_G + \sigma^2_E)$ , (Singh *et al.*, 1993).

*Weather.* At the time of planting in 1999, the mean daily temperature was increased and this year had the highest sum ( $\Sigma=52^\circ\text{C}$ ) in pre-emergence period (Figure 1). The amount of available water during that period was appropriate. In the period following first leaf appearance, there occurred a temperature decrease and a water deficit. In the last third of March, the temperatures were moderate, with a slow increasing trend, and a water deficit was recorded. In the year 2000, low temperatures persisted till the last third of March, with the lowest temperature sums for 10-day periods among the three years (Figure 1). From the middle of the last third of March, the temperature continually increased. Water deficit was again recorded in this year. In 2001, low temperatures were recorded till the end of February and after that they continually increased till the end of tillering. The periods of emergence and tillering in this year were well supplied with water.



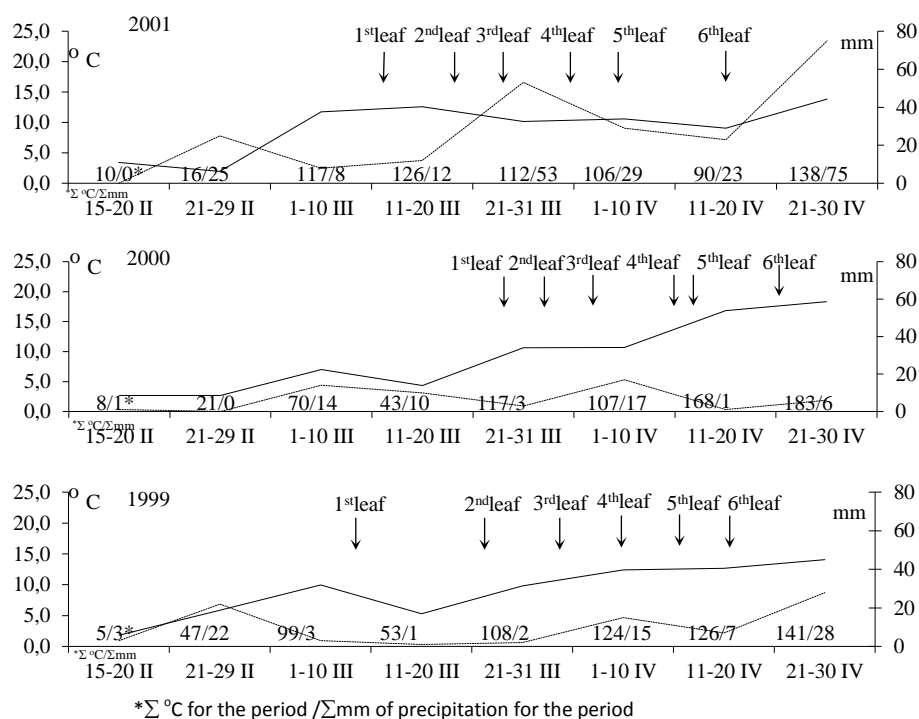


Figure 1. Ten-day average air temperature (—) and total ten-day precipitation (-----) in 1999, 2000, and 2001 growing seasons of spring barley in Novi Sad

### Results and Discussion

ANOVA showed that all three factors, i.e., year, variety, and their interaction, were included in the phyllochron determination of the first leaf (Table 1). The phyllochron of the first leaf was not precisely defined, since GDD from sowing to first leaf appearance was supposed to be the phyllochron. Year had a lower range of variation than variety (Table 2), although its component of variance was higher. Across cultivars, the lowest phyllochron was in 1999 and the highest in 2001 (Table 3). The Russian six-rowed variety Avans had the longest phyllochron interval for first leaf appearance. Interaction GxY occurred in all cultivars; Jelen, Nora, Alexis, and NS-135 had the shortest PI in 1999 while differences in the other two years could not be established. Avans significantly differed in all three years, while Gustoe had longer PI in 2001 than in the previous two years (data not shown). Significance of variety in first leaf appearance was also confirmed by a high value of heritability (Table 1).

Table 1. ANOVA and percentage of components of variance for phyllochron during tillering of six spring barley varieties in 1999-2001 growing seasons

Source of variation	Df	1 <sup>st</sup> leaf	2 <sup>nd</sup> leaf	3 <sup>rd</sup> leaf	4 <sup>th</sup> leaf	5 <sup>th</sup> leaf	6 <sup>th</sup> leaf
		Square mean					
Year (Y)	2	**	ns	**	**	**	ns
Variety (G)	5	*	**	ns	ns	ns	ns
G x Y	10	**	**	**	**	**	**
		% of components of variance					
Year (Y)		38	0	22	30	5	0
Variety (G)		31	75	0	0	0	23
G x Y		27	20	72	53	75	49
Error		4	5	6	17	20	28
Heritability		96.7	94.1	89.5	64.4	64.0	80.6

\*,\*\* Significant at 0.05 and 0.01 level, respectively;  
ns - not significant

In 1999, high temperatures during emergence caused a faster second leaf development so that it appeared 214.5 GDD after sowing (from Table 4). Low mean daily temperatures and water deficit after first leaf development in that year caused relatively more days for the second leaf appearance in relation to the other two years. Year did not effect second leaf appearance (Table 1) and PI across cultivars ranged from 72.1 in 1999 to 77.8 GDD in 2001 (Table 3). Total sum of GDD from sowing to second leaf appearance was shortest in 1999 (214.5) and longest in 2001 (245.6). Of all six leaves studied, the second leaf was most strongly influenced by genetic constitution of cultivars and 75% of total variation belonged to this component of variation (Table 1). Range of variation for cultivars was from 53.3 (Nora) to 125.2 GDD (Gustoe) (Table 2).

Table 2. Ranges of cultivar and year mean values for phyllochron during tillering in six spring barley varieties in 1999-2001 growing seasons

Leaf	Variety (n=6)	Year (n=3)	Mean
1 <sup>st</sup> leaf	127.5-202.8	142.4-167.8	155,2
2 <sup>nd</sup> leaf	53.3-125.3	72.1-77.8	74,1
3 <sup>rd</sup> leaf	40.3-114.8	62.8-83.3	75,8
4 <sup>th</sup> leaf	49.2-94.1	66.7-81.6	71,8
5 <sup>th</sup> leaf	41.8-79.0	54.5-63.9	60,5
6 <sup>th</sup> leaf	61.3-86.8	73.8-75.0	74,3

The two-rowed cultivars had shorter phyllochron of the second leaf than the six-rowed cultivars. Thermal requirements for the second leaf were consistent among years in the two-rowed cultivars, while significant differences occurred in all three six-rowed cultivars. High heritability values (Table 1) showed that the established variability for second leaf appearance was under strong genetic control.

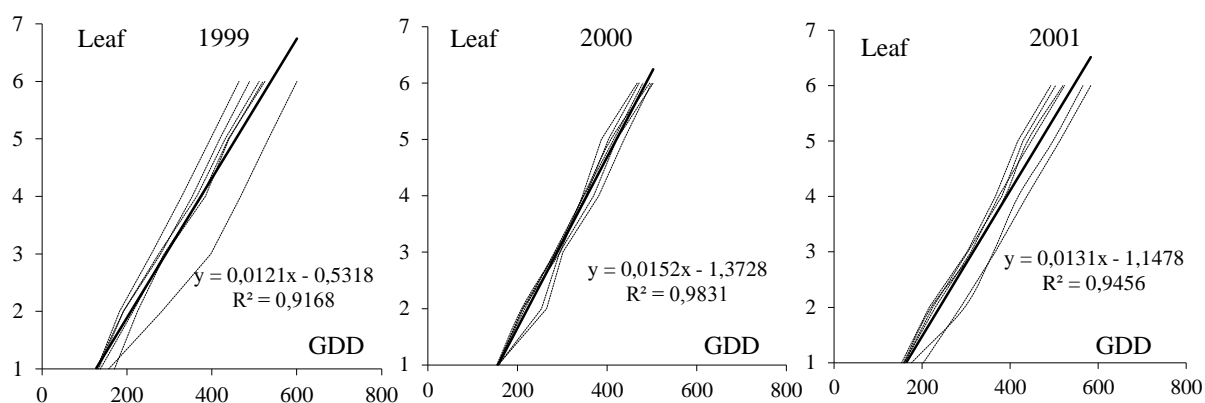
Variation of phyllochron of the next three leaves, third, fourth and fifth, was mainly determined by interaction GxY and year (Table 1). In the components of variance, year participated from 5 to 30% and interaction from 53 to 75% of total variation (Table 1). Range for variation for these leaves, similar to the previous two, was larger among years than among cultivars (Table 2). The shortest PI for these three leaves was registered in 2000.

Table 3. Means of phyllochron across cultivars and years in GDD during tillering of six spring barley varieties in 1999-2001 growing seasons

Year	1 <sup>st</sup> leaf	2 <sup>nd</sup> leaf	3 <sup>rd</sup> leaf	4 <sup>th</sup> leaf	5 <sup>th</sup> leaf	6 <sup>th</sup> leaf
	GDD					
1999	142.4	72.1	83.3	81.6	63.9	75.0
2000	155.5	72.4	62.8	66.7	54.5	74.0
2001	167.8	77.8	81.5	67.2	63.1	73.8
LSD <sub>0.05</sub>	2.63		3.30	3.84	3.67	
LSD <sub>0.01</sub>	3.53		4.43	5.15	4.92	
Jelen	146.9 <sup>cd</sup>	61.2 <sup>d*</sup>	87.4	70.4	53.5	80.1
Nora	145.3 <sup>d</sup>	57.3 <sup>d</sup>	78.8	66.4	61.6	69.1
Alexis	148.7 <sup>cd</sup>	61.9 <sup>d</sup>	77.9	72.1	58.2	76.9
NS-135	150.6 <sup>c</sup>	67.8 <sup>c</sup>	76.7	72.6	62.1	76.7
Avans	176.8 <sup>a</sup>	78.2 <sup>b</sup>	62.0	80.5	60.5	77.4
Gustoe	163.1 <sup>b</sup>	118.0 <sup>a</sup>	73.2	68.9	67.2	65.5
LSD <sub>0.05</sub>	3.72	5.05				
LSD <sub>0.01</sub>		6.78				

\* at 0.05 level of significance

The third and fifth leaf had close phyllochrons in 1999 and 2000, while the fourth leaf had the longest PI in 1999 and similar lengths of PI in the other two years. GxY interaction for these three leaves occurred in almost all cultivars. Variation in third leaf appearance was mainly controlled by cultivar, while about one third of variation in fourth and fifth leaf appearance was due to non-genetic factors. GxY interaction had the highest responsibility for PI of the



sixth leaf.

Figure 2. Heat units (GDD) required for the leaf appearance in six spring barley cultivars (— illustrates regression of leaf appearance against GDD for each investigated variety, - - - - - illustrates regression of average values of the six cultivars against GDD)

Variation across cultivars, i.e., among years, was minor, while across years it varied from 61.3 to 86.6 (Table 2). The cultivars Jelen and Gustoe did not differ in the phyllochron of the sixth leaf, while the other cultivars showed significant differences among the three years (data not shown). There was no consistency in the differences in PI among the cultivars; Alexis had the longer PI in 2000 NS-135 in 1999 and Avans the shortest in 2001.

The differences in the heat units for first leaf appearance suggest that the cultivars responded to accumulated GDD at this phase which agrees with observations of Baker *et al.* (1986) and Bauer *et al.* (1984). Avans and Gustoe originated from different ecological conditions in relation to the location of this experiment and it could be partially the reason for longer PI of the first leaf. Fast and uniform seedling emergence is especially desirable in short-season areas (semiartic, semiarid, arid), which provides adequate plant stand and establishment of effective plant canopy structure and yield. Early emerging seedlings have a longer time for growth in relation to late emerging ones. The results of early emergence is higher tillering, i.e., higher grain yield (Gan *et al.*, 1992).

In all three years, first leaf demanded more days for appearance due to lower temperatures and shorter daylength. Cao and Moss (1989a), found that decrease in phyllochron interval and increase in the rate of leaf appearance (leaves day<sup>-1</sup>) was associated with increase in daylength. It seems that in our investigation temperatures had a strong effect on leaf appearance. Indeed, in 1999, temperatures during sowing and germination were rather high and the first leaf appeared soon after sowing; after that, the temperatures dropped and more days were required for second leaf appearance (Figure 1). Water deficit that occurred at the time of sowing in 1999 could also be responsible for the increased rate of first leaf appearance. Baker *et al.* (1986) found lower PI values in wheat under non-irrigated field conditions, i.e., a higher rate of mainstem leaf. High air temperature at the time of sowing and emergence is expected to cause longer PI. That was confirmed in this study where high temperatures in the first 10 days of March 2001 (Figure 2, sum of mean daily temperature was 117°C) caused the longest PI of the first leaf in the three years. Appearance of the other five leaves in 1999 and all leaves in 2001 was in close symmetrical intervals, since temperatures were steady and without large fluctuations. In 2000, temperatures were lowest among the three years and the appearance of the first leaf was latest.

The relation between leaf development and GDD as illustrated in Figure 2 shows the close dependence of leaf development on accumulated GDD. The coefficients of determination ( $R^2$ ) were 0.92, 0.98, and 0.95 for 1999, 2000, and 2001, respectively, indicating that leaf development was mainly influenced by thermal conditions. Sharratt (1999) also reported high values of coefficients of regression for two spring barleys grown in interior Alaska ( $R^2=0.98$  and  $R^2=0.95$ ). These results are consistent with Kleper *et al.* (1982), whose results were the basis for suggesting a linear relationship between GDD and leaf emergence. The high dependence of spring barley leaf appearance on temperature found in this investigation confirmed the previously determined thermal requirements for leaf development in small grains.

Leaf appearance is a highly heritable trait and there is a strong relationship with accumulated thermal units. The linearity suggests that MSL stage can be used as a predictive measure of plant development. Also it can retroactively show the quality of the preemergent seedbed environment.

### Conclusions

Results from this study showed the high heritability of phyllochron in barley. High temperature and water deficit increase rate of mainstem leaf appearance. Selection for small phyllochron had the desirable indirect effect on reducing time to maturity, but could also reduce grain yield when not accompanied by an increase in leaf number. These results indicate that phyllochron is a good measure of plant development, and that it is associated with time to maturity and other developmental traits.

## References

- Baker J.T., Pinter P.J., Reginato r.J., Kanemasu E.T. (1986). Effects of temperature on leaf appearance in spring and winter wheat cultivars. *Agron. J.*, 78: 605-613.
- Bauer A., Frank A.B., Black A.L. (1984). Estimation of spring wheat growth rates and anthesis from ear temperature. *Agron. J.*, 76: 829-835.
- Cao W., Moss D.N. (1989a). Temperature effect on leaf emergence and phyllochron in wheat and barley. *Crop Sci.*, 29: 1018-1021.
- Cao W., Moss D.N. (1989b). Daylength effect on leaf emergence and phyllochron in wheat and barley. *Crop Sci.*, 29: 1021-1025.
- Dofing S.M. (1995). Phenological development-yield relationships in spring barley in a subarctic environment. *Can. J. Plant Sci.*, 75: 93-97.
- Gan Y., Stobbe E.H., Moes J. (1992). Relative date of wheat seedling emergence and its impact on grain yield. *Crop Sci.*, 32: 1275-1281
- Huan J.R. (1973). Visual quantification of wheat development. *Agron. J.*, 65: 116-119.
- Klepper B., Rickman R.W., Peterson C.M. (1982). Quantitative characterization of vegetative development in small grain cereals. *Agron. J.*, 74: 789-792.
- Krenzer E.G., Nipp T.L. (1991). Mainstem leaf Development and Tiller Formation in Wheat Cultivars. *Agron. J.*, 83: 667-670.
- Rickman R.W., Klepper B.L., Peterson C.M. (1983). Time distribution for describing appearance of specific culms of winter wheat. *Agron. J.*, 75: 551-556.
- Sharratt B. (1999). Thermal requirements for barley maturation and leaf development in interior Alaska. *Field Crops Research*, 63: 179-184.
- Singh M., Ceccarely S., Hamblin J. (1993). Estimation of heritability from varietal trials data. *Theor. Appl. Genetic.*, 86: 437-441.
- Zar J.H. (1996). *Biostatistical Analysis*, Third edition, Prentice-Hall, pp. 285-305.

**PHENOLOGICAL AND POMOLOGICAL ANALYSIS OF FRUIT  
AUTOCHTONOUS VARIETY OF SWEET CHERRY (*Prunus avium* L.) CV.  
“ALICA” IN MOSTAR AREA (BOSNIA AND HERZEGOVINA)**

Semina HADŽIABULIĆ\*, Jasna HASANBEGOVIĆ, Jasmina ALIMAN, Edin RAMIĆ,  
Ahmed DŽUBUR, Armin MUSTAFIĆ

University „Džemal Bijedić“ Mostar, Agromediterranean Faculty, Bosnia and Herzegovina

\*Corresponding author: semina.hadziabulic@unmo.ba

**Abstract**

The paper presents the results of a two-year study of flowering dynamics and fruit morphological characteristics of autochthonous sweet cherry (*Prunus avium* L.) the variety “Alica” within the period 2013-2014 in the area of Mostar in Bosnia and Herzegovina. The study included monitoring of phenological characteristics such as bloom phases, fruit setting and maturation, and morphological characteristics such as weight, length, width and thickness of the fruit, stone weight, stem length and randman. Results showed earlier vegetation on set, so phenophases lasted longer in 2014, which can be directly related to more favourable climatic conditions in that year. The bloom phase in 2014 lasted longer (11 days), due to the high precipitation period which caused prolonged blossom in comparison to shorter bloom phenophase in 2013, that lasted 7 days only. Shorter period of fruit development (34 days) was recorded in 2013, comparing to the period of fruit development in 2014 (42 days). The most of morphological characteristics such as average fruit weight, stone weight and fruit skin weight showed statistically significant differences depending on the year, so their values were higher in 2013, comparing to 2014. Higher values of fruit width, thickness and length of the fruit stalk were recorded in 2013 as well, while randman of fruits showed no significant variations in relation to the year. Based on the research results, it may be concluded that this, once very respectable variety, over the years has acquired adaptability to climate conditions and that it should be further on investigated as a valuable genetic potential.

**Keywords:** *Phenological and pomological characteristics, autochthonous, sweet cherry, Alica.*

**Introduction**

Cherry belongs to the genus *Prunus* of the *Rosaceae*, or rose family. The genus *Prunus* includes other stone fruits such as almond, apricot, plum, peach, and nectarine. There are many cherry species, but only a few have been domesticated. The sweet cherry (*Prunus avium* L.) produces large trees (3 metres to 4 metres tall), usually shaped somewhat like a pyramid. Autochthonous genotypes of fruit species are very important source of genetic variability and valuable material for breeding work.

Traditional cherry cultivation is present in the area of Bosnia and Herzegovina (BiH) for a long period, it has been extensive without special use of agrotechnics or plant protection. Though, this area has favourable ecological conditions for cultivation of this type of fruit, cherry production is on the sixth place of total fruit production in BiH.

Cherries cultivation is mostly present in the area of Mostar with varieties “Alica” and “Hrust” introduced during the period of Turkish and Austrian governing.

Domestic varieties are, according to Šoškić (1994), those that originate from BiH or they are cultivated in these ecological conditions for a long time, origin is unknown and they are

important because of their natural characteristics, so they represent plan resource of general and national importance. Due to the sudden and unprecedented industrialization, war operations, as well as natural disasters, autochthonous cherry varieties are threatened with extinction. Old local populations are increasingly being replaced by new, highly productive varieties, which is the basis of the progress of agricultural production. However, the fact that autochthonous varieties are characterized by many desirable characteristics should not be ignored, no breeding program can be effective without a wide variety of initial plant material. In addition, these varieties are not yet sufficiently pomologically or economically evaluated, nor have the degree of their inter variety variability been determined. The most valuable genotypes will find their place in breeding programs, so conserving the individuals that currently do not have the current production value, their positive characteristics have would come to light (Jarebica and Kurtović, 1997). For these reasons, the preservation of germplasm should provide the possibility for the creation of new genotypes (varieties and rootstocks of fruit trees), which will be able to fulfil the needs for the fruit of today's and future human generations (Mišić, 1987). A small number of authors dealt with studying of autochthonous cherry varieties in the territory of Herzegovina so, we can emphasize the researches of Stančević et al.(1983) and Pirnat et al. (1980). The aim of this research was to determine phenological and morphological characteristics of autochthonous variety of the variety “Alica” in the area of Mostar.

### **Material and Methods**

The research was carried out during 2013 and 2014, on the location of Mostar, in the private cherry orchard in Vrapčići in BiH. Materials used for research was autochthonous variety of sweet cherry the variety Alica.

Flowering was followed by recommendations of the International working group for pollination (Wertheim, 1996). The date of beginning of bloom was taken when 10% of flowers were open, full bloom– when 80% of flowers were open, the end of bloom – when 90% of petals were fallen.

Duration of bloom phase was determined by the number of days from the beginning to the end of bloom. Abundance was assessed according to a scale from 1 (no flowers) to 9 (abundant bloom). The date of harvest is taken as the time of maturation. Characteristics of fruit are determined on a sample of 30 fruits for variety. Standard morphometric methods were used to determine the weight of fruit, dimensions of the fruit, the length of the stalk . The results are processed by the statistical method of the analyses of variance. The significance of differences between mean values is determined by Tukey test at  $P=0,05$ .

International cheery descriptor “Descriptor list for IBPGR (Schmidt et al., 1985) was used for determination of qualitative fruit characteristics.

### **Results and Discussion**

Phenological observations comprehended the flow of phenophases: swelling of buds, beginning of bloom phase, full bloom, end of bloom, leafing, formation of first fruits, rash, and fruit maturation.

Table 1. Flowering phenophases of the cherry variety “Alica”

	<i>Phenophases</i>		<i>Bloom</i>			<i>Duration (days)</i>	<i>Full leafing</i>
	<i>Swelling buds</i>	<i>Green Tip</i>	<i>Beginning</i>	<i>Full</i>	<i>End</i>		
2013	19 <sup>th</sup> of March	28 <sup>th</sup> of March.	10 <sup>th</sup> of April	14 <sup>th</sup> of April	17 <sup>th</sup> of April	7	20 <sup>th</sup> of April
2014	6 <sup>th</sup> of March	11 <sup>st</sup> of March	20 <sup>th</sup> of March	31 <sup>st</sup> of March	31 <sup>st</sup> of March	11	3 <sup>rd</sup> of April

On the observed the variety “Alica”, the phenophase from swelling buds to the phenophase of green heads occurred within the period from the 19<sup>th</sup> of March in 2013 and 6<sup>th</sup> of March in 2014, till the 28<sup>th</sup> of March and 11<sup>th</sup> of March (Table 1). So, the phenophase of green tips started nine days after swelling buds in 2013 and in 2014 this period was five days.

Beginning of bloom phase of the variety “Alica” in 2013 “Alica” started on the 10<sup>th</sup> of April, while the beginning of bloom in 2014 was recorded on the 20<sup>th</sup> of March, this was caused by significantly higher temperatures in that period. The phenophase of full bloom was recorded on the 14<sup>th</sup> of April in 2013, while in 2014 it was recorded much earlier on the 31<sup>st</sup> of March. The end of bloom of “Alica” variety in the period 2013-2014 was recorded on the 17<sup>th</sup> of April in 2013 and 31<sup>st</sup> of March in 2014.

It may be concluded that all phenophases were moved forward in 2014, influenced by higher temperatures in the period from February to May and significantly higher precipitation in the same period.

Duration of bloom phase is an important category in bloom phase and it has been influenced by genetical characteristics of the variety and meteorological conditions during the bloom. Bloom phase duration for the observed period of 2013-2014 was 7 and 11 days.

Full leafing in the observed period of “Alica” variety occurred significantly later the bloom which was quite favourable in the cases of late frosts avoiding fruit tree damages. Full leafing was recorded on the 20<sup>th</sup> of April in 2013 and on the 3<sup>rd</sup> of April in 2014. Stančević (1967) emphasises that the flowering duration for 48 varieties of cherries was 11-17 days, Pirnat et al., (1980) concluded that this period is 12 days, while in this research similar data have been collected, so this period was 7 days due to the warm weather during bloom phase period.

Aliman et al., (2009) presented their research results including data on swelling buds of “Alica” variety on the 23<sup>rd</sup> of March in 2006, and on the 4<sup>th</sup> of March in 2007, bloom beginning was recorded on the 2<sup>nd</sup> of April and on the 18<sup>th</sup> of March, full bloom was recorded on the 7<sup>th</sup> of April and on the 25<sup>th</sup> of March, and the end of bloom on the 14<sup>th</sup> of April and on the 5<sup>th</sup> of April.

Aliman et al., (2009) in this research presented results on full leafing in 2006 which was recorded on the 16<sup>th</sup> of April, and on the 10<sup>th</sup> of April in 2007.

Table 2. Fruiting phenophases of the variety “Alica”

	<i>Fruit formation</i>	<i>Straw</i>	<i>Fruit maturation</i>	<i>Duration period of fruit development</i>
2013	21 <sup>st</sup> of April	15 <sup>th</sup> of May	25 <sup>th</sup> of May	34
2014	6 <sup>th</sup> of April	10 <sup>th</sup> of May	1 <sup>st</sup> of May	42



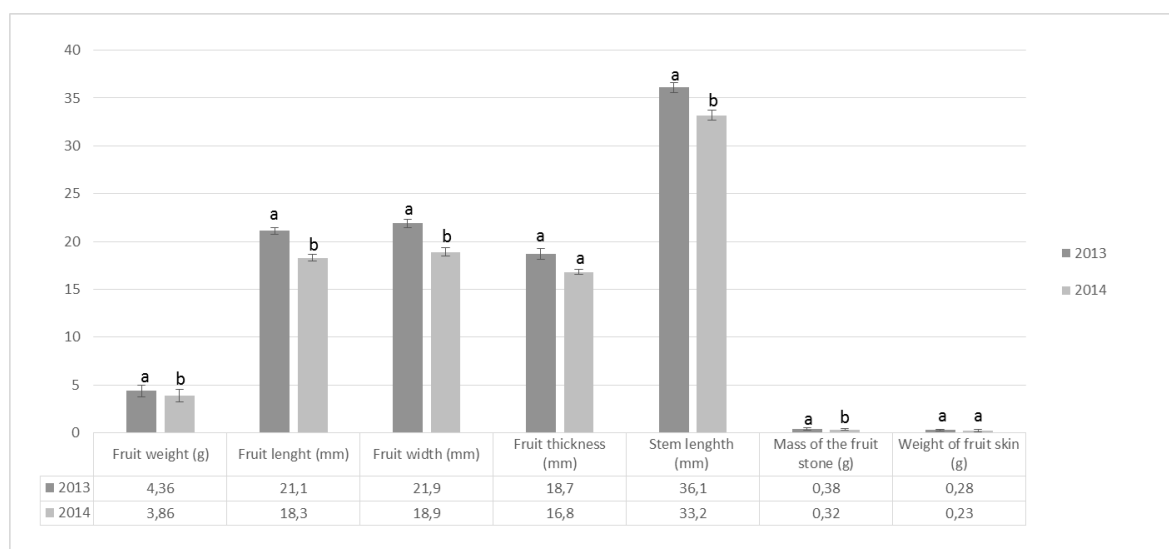
Forming of fruits the variety “Alica” was recorded on the 21<sup>st</sup> of April in 2013 and on the 6<sup>th</sup> of April in 2014. Straw phenophase in 2013 was spotted on the 15<sup>th</sup> of May and on the 10<sup>th</sup> of May in 2014. Fruit maturation was recorded earlier in 2014, on the 18<sup>th</sup> of May and on the 25<sup>th</sup> of May in 2013, which can be directly related to the climate conditions in the period 2013-2014 (Table 2).

Duration period of fruit development from the fruit setting to maturation is influenced by ecological and genetical variety characteristics and it is the time period of 22-62 days, averagely 44 days according to the previous researches (Jovanović, Miletić, 1988), which confirms the results of this research. It may also be noticed that duration of fruit development of “Alica” variety lasted 34 days.

Aliman et al., (2013) stated that their results show that fruit formation for “Alica” variety was recorded on 19<sup>th</sup> of April, straw on the 24<sup>th</sup> of May, fruit maturation on the 31<sup>st</sup> of May. According to the same authors, duration period of fruit development lasted 42 days, which is slightly different from results of this research.

Following the duration period of fruit development of the variety “Alica” in the studied period 2013-2014 it may be concluded that duration period of fruit development in 2013 lasted 34 days, while it was 42 days in 2014.

Graph 1. Fruit properties of the variety “Alica”



Remark: Average values are presented  $\pm$  SD (standard deviation). Different letter on average values show that years are significantly different in studied characteristic - Tukey test  $p \leq 0,05$

Fruit weight of studied the variety “Alica” showed statistical differences that depended on a study year. The average fruit weight in 2013 was 4,36 g, while in 2014 it was 3,86 g. Analysing the mass of the fruit stone the variety “Alica”, it may be concluded that it varied from 0,38 g in 2013 to 0,32 g in 2014 godini. Weight of fruit skin was 0,28 g, in 2013, and 0,26 g in 2014. The biggest average fruit width, thickness and stem length was recorded for “Alica” variety in 2013. Randman was within 85% in 2013 up to 83% in 2014.

Various analyses showed that fruit mass, length and width of fruit, stem length and mass of the fruit stone expressed statistically significant differences for the studied period 2013-2014, while thickness and skin of fruit did not express statistically significant differences in reference to the studied years.

The results of fruit properties the variety “Alica” are presented in Graph 1.

Important pomological characteristics of cherry fruit are: shape, largeness and dimensions (height, width and thickness) (Nikovski, 1998).

In this period whit rich selection of fruit types and varieties, there is an idea to bring back into production certain types and varieties with domestic origin which are fighting against its disappearance in the areas of Bosnia and Herzegovina. These individual trees carry on the long fight without human help so they become immune to pests and diseases which is of large importance since it reduces use of pesticide and produce healthy fruit. This means a lot for the health of humans but economic significance should not be underestimated.

### **Conclusions**

So, based upon the research on morphological and phenological characteristics of autochthonous “Alica” variety in the period 2013-2014 in the area of Mostar, the following conclusions can be made:

The phenophase of green tip started nine days after swelling buds in 2013 and while in 2014 it occurred five days later. Bloom phenophases of “Alica” variety started earlier in 2014 in comparison to 2013 due to the higher temperatures from February to May and significantly higher precipitation in 2014.

Bloom duration for the studied period 2013-2014 was 7 and 11 days, respectively. Fruit formation, straw and maturation of “Alica” variety was recorded much earlier in 2014 comparing to 2013. Variance analyses showed that fruit mass, length and width of fruit, stem length and mass of the fruit stone expressed statistically significant differences for the studied period 2013-2014, while thickness and skin of fruit did not express statistically significant differences in reference to the studied years.

Based upon these results it may be concluded that this is highly valuable autochthonous variety which needs to be preserved from disappearance since its positive characteristics can serve as valuable genetic potential in breeding programmes.

### **References**

- Aliman J. (2006): Dinamika cvjetanja i pomološke karakteristike domaćih i introdukovanih genotipova trešnje, Master thesis, Faculty of Agriculture and Food Sciences University of Sarajevo
- Aliman J., Drkenda P., Kurtović M. (2008). Postojeće stanje proizvodnje trešnje u FBiH i mogućnost njenog unapređenja. III savjetovanje o proizvodnji i preradi hrane sa međunarodnim učešćem agroTECH. Gradačac.
- Aliman, J., Drkenda P. (2009): Dynamic of blossoming of autochthonous and introduced cherry genotypes, 44st Croatian & 4th International Symposium on Agriculture. Opatija. Croatia.
- Aliman J, Džubur A, Hadziabulić S, Skender A, Manjgo L.,(2013): Etape sazrijevanja plodova autohtonih i introduciranih genotipova trešnje na području Mostara, 48th CROATIAN AND 8th INTERNATIONAL SYMPOSIUM ON AGRICULTURE, 17 th – 22nd February 2013, Dubrovnik, Croatia.
- Džubur A. (2002) – Trešnja i višnja, University Džemal Bijedić of Mostar
- Jarebica Dž., Kurtović M. (1997). Oplemenjivanje voćaka i vinove loze, Edis, Sarajevo
- Jovanović M., Miletić R.(1988). Pomološko-tehnološke osobine u važnijih sorti cherriesgajenih u uslovima Timočkog regiona, Journal of Yugoslav pomology 22, 84-85, 271-276, Čačak.
- Ninkovski I. (1998). Trešnja - Potez Uno, Beograd.
- Mišić P. (1987). Opšte oplemenjivanje voćaka- Nolit, Beograd.

- Pirnat M., Kapetanović N., Buljko M. (1980). Pomološke karakteristike sorti cherriesna području Mostara, *Journal of Yugoslav pomology* 1, Čačak.
- Stančević A., J.Smole, Buljko M., Mladar N., Rahović D. (1983). Novi jugoslovenski sortiment trešanja, *Journal of Yugoslav pomology* 17, Čačak.
- Stančević A. (1976). Biološko-privredne osobine samooplodne trešnje stela. *Journal of Yugoslav pomology*. 35-36, 81-83, Čačak.
- Stanković D. (1981). Trešnja i višnja, Nolit, Beograd Šoškić M. (1994). Oplemenjivanje voćaka i vinove loze, *Papirus*, Beograd.
- Stanković D. (1980) – Trešnja i višnja, Nolit, Beograd.
- Šoškić M. (2008) – Savremeno voćarstvo, PARTENON, Beograd.

## IMPACT OF HERBICIDE ADENGO ON MICROBIAL DIVERSITY OF SOIL UNDER CORN

Saud HAMIDOVIĆ<sup>1\*</sup>, Blažo LALEVIĆ<sup>2</sup>, Vedrana KOMLEN<sup>3</sup>, Milan PEŠIĆ<sup>4</sup>, Vera RAIČEVIĆ<sup>2</sup>, Hadi WAISI<sup>5</sup>, Amer SUNULAHPAŠIĆ<sup>6</sup>

<sup>1</sup>University of Sarajevo, Faculty of Agriculture and Food Sciences, Bosnia and Herzegovina,

<sup>2</sup>University of Belgrade, Faculty of Agriculture, Belgrade - Zemun, Serbia,

<sup>3</sup>University "Dzemail Bijedic", Agromediterranean Faculty, Mostar, Bosnia and Herzegovina

<sup>4</sup>Institute of Soil Science, Belgrade, Serbia

<sup>5</sup>Institute for Water Management "Jaroslav Cerni", Belgrade, Serbia

<sup>6</sup>Ministry of Agriculture, Water Management and Forestry of Central Bosnia Canton, Travnik, Bosnia and Herzegovina

\*Corresponding author: s.hamidovic@ppf.unsa.ba

### Abstract

In modern plant production usage of pesticides is necessary in order to obtain good quality of yield. In corn production, Adengo is one of the most used systemic herbicides for control of grasses and broadleaf weeds. Usage of inadequate concentrations of herbicides may have negative consequences for microbial diversity. The aim of this paper was determination of Adengo influence on microbial diversity in soil under corn. Experiment was performed in Ilidža municipality (Sarajevo canton, Bosnia and Herzegovina) by sowing seeds in spring 2016, followed by Adengo application in three various concentrations (0.22; 0.44; and 0.88 l/ha). Control treatment was untreated soil. Sampling for microbiological analyses was performed 15. 30. and 130 days after sowing. Microbial diversity of soil was determined using standard agar plate method. Total number of bacteria was determined on 0.1xTSA, ammonification bacteria on nutrient agar, nitrogen fixation bacteria and *Azotobacter* sp. on Fyodorov agar, fungi on Rose Bengal streptomycin agar, and actinomycetes on starch-ammonia agar. Microbial activity of soil was expressed as colony forming units per g of dry soil. The highest total bacterial number was detected at the end of experiment. Similar results were obtained for *Azotobacter* sp. and nitrogen fixation bacteria and fungi while highest abundance of ammonification bacteria was obtained in the start of experiment. Number of actinomycetes was highest after 330 days from sowing. These results may be useful for further application of herbicide Adengo in corn production, as well as other crops planting.

**Key words:** *Herbicide, microbial diversity, corn, Adengo*

### Introduction

Application of agrochemicals are irreplaceable part of traditional agriculture production (Carvalho, 2006). These chemicals have various impacts on soil characteristics (Gaherwal *et al.*, 2015). One of them is pesticide; this term covers a various compounds, such as insecticides, fungicides, rodenticides, herbicides etc. (Aktar *et al.*, 2009). Pesticides are important part of integrated pest management and may have a huge influence in agricultural production (Talebi *et al.*, 2011). Application of pesticides is often linked with high crop productivity and protection from pests (Singh and Datta, 2006). With the increased use of pesticides in agriculture, impact of these agrochemicals on soil processes has received more global attention (Andrea *et al.*, 2000). Every year, about  $3 \times 10^9$  kg of pesticides is applied worldwide (Pan-UK, 2003). Unfortunately, long-term dispersion of pesticides has negative

consequences for ecosystem (Castro *et al.*, 2005) and food chain, causing malfunction in living organisms (Arias-Estevez *et al.*, 2008). Also, pesticides affect microbial activity of soil, as well as structure of microbial communities (Cycon *et al.*, 2005), which are important parameters in transformation of organic matter, N and P cycling and crop productivity (Devare *et al.*, 2007). The pesticides are accumulated in surface layer of soil, where microbial activity is highest (Sethi *et al.*, 2015). The influence of pesticides on microbial diversity of soil may be various, depends on various factors (Monkiedje and Spiteller, 2002), such as chemical structure of pesticide, concentration of pesticide, structure of microbial population in soil, different soil characteristics etc. (Digrak and Ozcelik, 1998); in some cases, pesticides stimulate the microbial activity, but other pesticides have deleterious effects on soil microflora (Lo, 2010). Microorganisms play important role in agricultural ecosystem functioning, especially during the corn cultivation, which is one of the most cultivated crops in Bosnia and Herzegovina. Research of microbial activity is considered to be an adequate parameter of estimation of soil disturbance caused by various agricultural practices (Nannipieri *et al.*, 2003). Thus, the aim of this research was determination of soil microbial activity after application of herbicide Adengo.

### Material and methods

The experiment was performed at Butmir location (Ilidža municipality, Sarajevo canton, Bosnia and Herzegovina). In May 2016, sowing a corn seeds (Pioneer hybrid PR37NO1) was performed. After seeds sowing, treatment of soil by herbicides Adengo (Bayer AG, Germany) obtained from local distributor was conducted in order to prevent the growth of broad-leaved weeds and grasses. This herbicide was applied in three concentrations: 0.22; 0.44; and 0.88 l/ha. In control treatment, herbicide was not applied.

Soil sampling was performed 15; 30; and 130 days after sowing. Samples were taken from the depth 0 to 30 cm at several points in the field. In second and third sampling, samples were taken from the nearness of plants at several points. After preparation of composite sample, microbiological analyses were performed.

Total number of bacteria was determined using 0,1xTSA, ammonification bacteria on nutrient agar, nitrogen fixation bacteria and *Azotobacter* sp. on Fyodorov agar, fungi on rose bengal streptomycin agar (Peper *et al.*, 1995), and actinomycetes on starch-ammonia agar. Incubation for fungi was performed at 25°C for 5 days, while for *Azotobacter* sp., and other bacteria at 28°C for 2, and 6 days, respectively. After incubation, microbial activity of samples was expressed in colony forming units (CFU) per gram of absolutely dry samples.

### Results and discussion

Usage of pesticides and other agrochemicals affects the crucial functions and activity of soil microorganisms (Milošević and Govedarica, 2002). Enzyme systems of microorganisms comprise up to 90% of soil metabolic activity (Lee, 1994), and its number and activity may serve a good indicator of soil quality after pesticides application (Konstantinović *et al.*, 1999). In our study, microbial activity depends on type of microorganisms, time of sampling and herbicide concentrations.

Total number of bacteria may be used as an important parameter of soil fertility (Jarak and Čolo, 2007). In all treatments, at the end of experiment highest total number of bacteria was recorded. Similar trend was noticed in *Azotobacter* sp. number in most of treatments (tab. 2) In most of treatments, in first sampling higher number of bacteria was noticed compared with second sampling (tab. 1), while abundance of *Azotobacter* sp. was higher in second sampling.

Highest number of bacteria and *Azotobacter* sp. was noticed in treatment with 0.44 l/ha of herbicide after 130 days of sowing ( $122.3 \times 10^5$ , and  $103.7 \times 10^2$  CFU/g, respectively).

Table 1. Total number of bacteria in soil under corn (CFU x  $10^5$ /g)

Treatments	Time of sampling		
	15 days	30 days	130 days
Control	26.6	25.7	100.6
Adengo 0,22 l/ha	48.6	12.8	78.4
Adengo 0,44 l/ha	19.4	24.2	122.3
Adengo 0,88 l/ha	46.3	13.2	82.9

Nitrogen fixation bacteria are diverse and play important role in reduction of atmospheric nitrogen to ammonia (Orr *et al.*, 2011). In all treatments (except of control), the number of nitrogen fixation bacteria was lowest at the end of experiment. Increase of herbicide concentration was followed by increase of bacterial activity (tab. 3). In first sampling, highest activity of nitrogen fixation bacteria was noticed in treatment with highest herbicide concentration ( $276.9 \times 10^2$  CFU/g), in second sampling in treatment with 0.44 l/ha ( $166.7 \times 10^2$  CFU/g) and in third in control treatment ( $122.5 \times 10^2$  CFU/g).

Table 2. *Azotobacter* sp. in soil under corn (CFU x  $10^2$ /g)

Treatments	Time of sampling		
	15 days	30 days	130 days
Control	87.7	67.0	94.3
Adengo 0,22 l/ha	53.8	54.1	46.3
Adengo 0,44 l/ha	45.1	49.0	103.7
Adengo 0,88 l/ha	37.3	40.4	54.4

Table 3. Nitrogen fixation bacteria in soil under corn (CFU x  $10^2$ /g)

Treatments	Time of sampling		
	15 days	30 days	130 days
Control	92.0	150.4	122.5
Adengo 0,22 l/ha	250.0	79.0	40.3
Adengo 0,44 l/ha	73.7	166.7	53.1
Adengo 0,88 l/ha	276.9	146.9	55.7

Ammonification bacteria use proteins as an energy material (Miletić *et al.*, 2012) and its presence is one of the indicators of soil fertility (Sargsyan *et al.*, 2013). Abundance of ammonifiers is highest in soil with high level of nutrients (Marinković *et al.*, 2008). In all treatments (except of control) highest number of ammonifiers was recorded in first sampling. Inhibitory effect of herbicides was noticed 30 days after sowing, followed with increase of ammonifiers number in third sampling compared to second (tab. 4). Lowest number of ammonifiers was recorded in treatment with 0.22 l/ha of herbicides after 30 and 130 days of sowing (4.1; and  $10.3 \times 10^5$  CFU/g, respectively), while highest activity was noticed in first sampling of 0.88 l/ha treatment ( $30.5 \times 10^5$  CFU/g).

Table 4. Ammonification bacteria in soil under corn (CFU x 10<sup>5</sup>/g)

Treatments	Time of sampling		
	15 days	30 days	130 days
Control	12.2	21.6	25.1
Adengo 0,22 l/ha	21.4	4.1	10.3
Adengo 0,44 l/ha	16.8	12.1	15.2
Adengo 0,88 l/ha	30.5	10.6	14.8

Fungi are important systematic group of microorganisms which play a crucial role in decomposition of organic matter (Vieira and Nahas, 2005). They are more acid tolerant organisms compared to bacteria, thus, fungi are dominant microorganisms in acid soils (Rousk *et al.*, 2009). Actinomycetes are also involved in significant processes in soil (Ghorbani-Nasrabadi *et al.*, 2013); they may survive under various soil conditions and stimulate the plant development (Hamdali *et al.*, 2008). As can be seen from table 5, in most of samples, higher number of actinomycetes compared to fungi was recorded. In treatments with herbicide, highest number of fungi was noticed in first sampling, while abundance of actinomycetes was highest in second sampling. In control treatment fungal and actinomycetes activity was highest in second sampling.

Table 5. Fungi and actinomycetes in soil under corn (CFU x 10<sup>3</sup>/g)

Treatments	Fungi			Actinomycetes		
	Time of sampling					
	15 days	30 days	130 days	15 days	30 days	130 days
Control	9.5	26.6	13.7	105.9	274.0	108.0
Adengo 0,22 l/ha	66.8	9.4	15.4	51.3	87.7	18.0
Adengo 0,44l/ha	57.3	11.1	24.8	85.9	135.7	104.5
Adengo 0,88l/ha	70.3	19.0	7.8	54.6	159.0	48.0

Results of previous researches showed the various impact of herbicides on soil microflora. In general, its application can cause decrease of beneficial microorganisms number (Aktar *et al.*, 2009). For example, application of triclopyr inhibits activity of several bacterial populations (Pell *et al.*, 1998), glyphosate has negative influence on nitrogen-fixing bacteria (Santos and Flores, 1995), while 2,4-D reduces the growth of cyanobacteria (Singh and Singh, 1989). These results are similar with our observation (tab. 3), where inhibitory activity of herbicide can be seen after 130 days from sowing. On the other side, some researchers suggest that some herbicides have stimulatory effects on microbial activity. Jena *et al.* (1987) found that butachlor had stimulatory effect on growth of anaerobic nitrogen fixation bacteria. Glyphosate applied at high concentration produces a short-term stimulation of bacterial growth (Ratcliff *et al.*, 2006).

## **Conclusion**

These results confirm that herbicide Adengo has various effects on soil microbial activity. Its impact depends on applied concentrations and microbial populations. Our results may be useful for further application of herbicide Adengo in corn production.

## **Acknowledgements**

This research is partially supported by Ministry of Education, Science and Technological Development of the Republic of Serbia, Grant No. TR 31080.

## **References**

- Aktar M.W., Sengupta D., Chowdhury A. (2009). Impact of pesticides use in agriculture: their benefits and hazards. *Interdisciplinary toxicology*, vol. 2(1), pp. 1-12.
- Andrea M.M., Peres T.B., Luchini L.C., Pettinelli A. (2000). Impact of longterm pesticide application on some soil biological parameters. *Journal of environmental sciences and health Part B*, vol. 35, pp. 297-307.
- Arias-Estevez M., Lopez-Periago E., Martinez Carballo E., Simal-Gandara J., Mejuto J., Garcia-Rio L. (2008). The mobility and degradation of pesticides in soils and the pollution of groundwater resources. *Agriculture, ecosystems and environment*, vol. 123, pp. 247-260.
- Carvalho F.P. (2006). Agriculture, pesticides, food security and food safety. *Environmental science and policy*, vol. 9, pp. 685-692.
- Castro M., Silva-Ferreira A.C., Manaia C.M., Nunes O.C. (2005). A case study of molinate application in a Portuguese rice field: herbicide dissipation and proposal of a clean-up methodology. *Chemosphere*, vol. 59, pp. 1059-1065.
- Cycon M., Kaczynska A., Piotrowska-Seget Z., Kaczynska A., Kozdroj J. (2005). Microbiological character of a sandy loam soil exposed to tebuconazole and lambda-cyhalothrin under laboratory condition. *Ecotoxicology*, vol. 15(8), pp. 639-646.
- Devare M., Londono-R L.M., Thies J.E. (2007). Neither transgenic Bt maize (MON863) nor tefluthrin insecticide adversely affect soil microbial activity or biomass: a 3-year field analysis. *Soil biology and biochemistry*, vol. 39, pp. 2038-2047.
- Digrak M., Ozcelik S. (1998). Effect of some pesticides on soil microorganisms. *Bulletin of environmental contamination and toxicology*, vol. 60(1), pp. 916-922.
- Gaherwal S., Prakash M.M., Khasdeo K., Sharma A. (2015). Impact of selected chemical and herbal pesticide on beneficial soil microorganism. *International journal of microbiological research*, vol. 6(3), pp. 236-239.
- Ghorbani-Nasrabadi R., Greiner R., Alikhani H.A., Hamed J., Yakhchali B. (2013). Distribution of actinomycetes in different soil ecosystems and effect of media composition on extracellular phosphatase activity. *Journal of soil science and plant nutrition*, vol. 13(1), pp. 223-236.
- Hamdali H., Hafidi M., Virolle M.J., Ouhdouch Y. (2008). Growth promotion and protection against damping-off of wheat by two rock phosphate solubilizing actinomycetes in a P-deficient soil under greenhouse conditions. *Applied soil ecology*, vol. 40, pp. 510-517.
- Jarak M., Čolo J. (2007). *Mikrobiologija zemljišta*. Poljoprivredni fakultet Novi Sad.
- Jena P.K., Adhya T.K., Rajaramamohan Rao V. (1987). Influence of carbaryl on nitrogenase activity and combinations of butachlor and carbofuran on nitrogen-fixing microorganisms in paddy soils. *Pesticide science*, vol. 19, pp. 179-184.



- Konstantinović B., Govedarica M., Jarak M., Milošević N. (1999). Herbicide efficiency and their impact on microbiological activity in soil. Research progress in plant protection and plant nutrition, AAM, China Agriculture Press, Beijing, pp. 228-232.
- Lee K.E. (1994). The functional significance of biodiversity in soils. Presentation: 15th world congress of soil science, July 10-16, 1994, Acapulco, Mexico, vol. 4a, pp. 168-182.
- Lo C.C. (2010). Effect of pesticides on soil microbial community. Journal of environmental science and health Part B, vol. 45, pp. 348-359.
- Marinković J., Milošević N., Jarak M., Đurić S., Tintor B., Vasin J. (2008). Microbial properties of fluvisol at different locations in the vicinity of Novi Sad. A Periodical of scientific research on field and vegetable crops, vol. 45, pp. 215-223.
- Miletić Z., Knežević M., Stajić S., Košanin O., Đorđević I. (2012). Effect of European Black Alder monocultures on the characteristics of reclaimed mine soil. International journal of environmental research, vol. 6(3), pp. 703-710.
- Milošević N.A., Govedarica M.M. (2002). Effect of herbicides on microbiological properties of soil. Proceedings for natural sciences Novi Sad, vol. 102, pp. 5-21.
- Monkiedje A., Spiteller M. (2002). Effects of the phenylamide fungicides, mefenoxam and metalaxyl, on the microbial properties of a sandy loam and a sandy clay soil. Biology and fertility of soils, vol. 35, pp. 393-398.
- Nannipieri P., Ascher J., Ceccherini M.T., Landi L., Pietramellara G., Renella G. (2003). Microbial diversity and soil functions. European journal of soil science, vol. 54, pp. 655-670.
- Orr C.H., James A., Leifert C., Cooper J.M., Cummings S.P. (2011). Diversity and activity of free-living nitrogen-fixing bacteria and total bacteria in organic and conventionally managed soils. Applied and environmental microbiology, vol. 77(3), pp. 911-919.
- Pan-UK (2003). Current pesticide spectrum, global use and major concerns. [http://www.panuk.org/brie.ng/sida\\_fil/chap1.htm](http://www.panuk.org/brie.ng/sida_fil/chap1.htm)
- Pell M., Stenberg B., Torstensson L. (1998). Potential denitrification and nitrification tests for evaluation of pesticide effects in soil. Ambio, vol. 27, pp. 24-28.
- Peper I.L., Gerba C.P., Brendencke J.W. (1995): Environmental Microbiology. Acad. Press, San Diego, pp. 11-33.
- Ratcliff A.W., Busse M.D., Shestak C.J. (2006). Changes in microbial community structure following herbicide (glyphosate) additions to forest soils. Applied soil ecology, vol. 34, pp. 114-124.
- Rousk J., Brookes P.C., Baath E. (2009). Contrasting soil pH effects on fungal and bacterial growth suggest functional redundancy in carbon mineralization. Applied and environmental microbiology, vol. 75, pp. 1589-1596.
- Santos A., Flores M., (1995). Effects of glyphosate on nitrogen fixation of free-living heterotrophic bacteria. Letters in applied microbiology, vol. 20, pp. 349-352.
- Sargsyan M.A., Movsesyan H.S., Ghazaryan N.P., Sargsyan A.M., Avagyan A.M. (2013): Quantities of ammonifiers in brown forest soils after introduction of crystallophores. Proceedings of the Yerevan state University, Chemistry and biology, vol. 1, pp. 40-43.
- Sethi S., Pophle S., Varte N., Salve C., Waghela S. (2015). Microbial population response exposed to Different pesticides. International journal of scientific engineering and applied science, vol. 1(5), pp. 250-255.
- Singh S., Datta P. (2006). Screening and selection of most potent diazotrophic cyanobacterial isolate exhibiting natural tolerance to rice field herbicides for exploration as biofertilizer. Journal of basic microbiology, vol. 46, pp. 219-225.
- Singh J.B., Singh S. (1989). Effect of 2,4-dichlorophenoxyacetic acid and maleic hydrazide on growth of bluegreen algae (cyanobacteria) *Anabaena doliolum* and *Anacystis nidulans*. Scientific culture, vol. 55, pp. 459-460.

- Talebi K., Hosseininaveh V., Ghadamyari M. (2011). Ecological impacts of pesticides in agricultural ecosystem. In: Stoycheva, M. (Ed.), “Pesticides in the modern world – risks and benefits”, Chapter 8. Intech open, pp. 143-168.
- Vieira F.C.S., Nahas E. (2005). Comparison of microbial numbers in soils by using various culture media and temperatures. *Microbiological research*, vol. 160(2), pp. 197-202.

## MICROBIOLOGICAL PROPERTIES OF SOIL UNDER CORN AFTER APPLICATION OF HERBICIDE LUMAX

Saud HAMIDOVIĆ<sup>1\*</sup>, Amer SUNULAHPAŠIĆ<sup>2</sup>, Blažo LALEVIĆ<sup>3</sup>, Vera RAIČEVIĆ<sup>3</sup>, Milan PEŠIĆ<sup>4</sup>, Hadi WAISI<sup>5</sup>, Vedrana KOMLEN<sup>6</sup>

<sup>1</sup>University of Sarajevo, Faculty of Agriculture and Food Sciences, Bosnia and Herzegovina,

<sup>2</sup>Ministry of Agriculture, Water Management and Forestry of Central Bosnia Canton, Travnik, Bosnia and Herzegovina

<sup>3</sup>University of Belgrade, Faculty of Agriculture, Belgrade - Zemun, Serbia,

<sup>4</sup>Institute of Soil Science, Belgrade, Serbia

<sup>5</sup>Institute for Water Management "Jaroslav Cerni", Belgrade, Serbia

<sup>6</sup>University "Dzemail Bijedic", Agromediterranean Faculty, Mostar, Bosnia and Herzegovina

\*Corresponding author: s.hamidovic@ppf.unsa.ba

### Abstract

In contemporary crop production, several techniques were developed for protection from weeds. One of methods is herbicides application. Herbicide Lumax (Syngenta) can be used for control of annual grasses and broadleaf weeds in corn and sorghum. The usage of herbicide may influence the microbiological properties of soil, which is important parameter of soil fertility. The aim of this paper was determination of influence of herbicide Lumax on microbiological properties of soil. Experiment was set up in May 2016 in Ilidža municipality (Bosnia and Herzegovina) by sowing corn seeds and application of herbicide Lumax in three concentrations (2, 4, and 8 l/ha). Soil sampling for microbiological analyses was performed 15, 30, and 130 days after sowing. Determination of microbiological properties of soil was performed using standard methodology and agar plate method. Microbial activity was expressed as colony forming units per g of absolutely dry soil. Highest total number of bacteria and *Azotobacter* sp. was noticed at the end of experiment, while ammonification and nitrogen fixation bacteria in most of samples were most abundant 15 days after sowing. Fungi were most abundant in the start of experiment, while actinomycetes number was highest 30 days after sowing seeds. These results showed good adaptation of total bacteria and *Azotobacter* sp. in the presence of Lumax, while number of fungi, ammonification and nitrogen fixation bacteria in most of samples decreased during the growth of corn. This research may be useful for further experimental designs considering the impact of herbicides on microbial diversity in corn production.

**Key words:** *microorganisms, soil, corn, herbicide, Lumax*

### Introduction

Microorganisms play an important role in decomposition of organic matter in soil and cycling of nutrients (Pandey and Singh, 2004). In soil-microorganism-plant system, microorganisms, mostly bacteria and fungi, are considered as nutrient pool to crops (Subhani *et al.*, 2000). They affect the physical, chemical and biological characteristics of soil (Gulhane *et al.*, 2015). Activity and number of microorganisms in agricultural ecosystems depend on various factors. One of them is application of pesticides (Cycon and Piotrowska-Seget, 2007). They were introduced in agricultural production to protect crops from pests and pathogen microorganisms (Gaherwal *et al.*, 2015). In several last decades, application of pesticides has become a crucial parameter for high crop productivity (Singh and Datta, 2006). Unfortunately, repeat and long-term usage of pesticides has negative consequences for soil

characteristics (Sethi and Gupta, 2013) and global environment (Castro *et al.*, 2005). On the other side, researches focusing impact of pesticides on microbial population of soil reported stimulatory or inhibitory effect (Devare *et al.*, 2007). Pesticides interact with soil microorganisms and change physiological characteristics of microbial populations (Weber *et al.*, 2004). Microbiological characteristics are good parameter of soil quality (Winding *et al.*, 2005) because of early responses to disturbance of soil caused by agricultural crop production (Sethi and Gupta, 2013), especially in corn production, which is very intensive in central part of Bosnia and Herzegovina. Based on official report of Ministry of foreign trade and economic relations of Bosnia and Herzegovina (2016), corn production participates with 58% of total grain production in Bosnia and Herzegovina. Because of importance of high quality of corn and consequences caused by pesticide application, it is necessary to find methods for determination of soil quality disrupted by agricultural practices. The aim of this work was determination of influence of herbicide Lumax on microbiological activity of soil under corn.

### Material and methods

The experiment was performed in May 2016 at Butmir location (Ilidža municipality, Sarajevo canton, Bosnia and Herzegovina). After sowing a corn seeds (Pioneer hybrid PR37NO1), treatment of soil by herbicides Lumax (Syngenta) obtained from local distributor was conducted in order to prevent the growth of broadleaf weeds and annual grasses. This herbicide was applied in three concentrations (2, 4 and 8 l/ha). Control treatment was untreated soil.

Soil sampling was performed 15, 30 and 130 days after sowing, from the depth 0 to 30 cm at several points in the field. In second and third sampling, samples were taken from the nearness of plants at several points. After preparation of composite sample, microbiological analyses were performed using standard methodology. Total number of bacteria was determined on 0,1xTSA, ammonification bacteria on nutrient agar, nitrogen fixation bacteria and *Azotobacter* sp. on Fyodorov agar, fungi on rose bengal streptomycin agar (Peper *et al.*, 1995), and actinomycetes on starch-ammonia agar. Incubation for fungi was performed at 25°C for 5 days, while for *Azotobacter* sp., and other bacteria at 28°C for 2, and 6 days, respectively. After incubation, microbial activity of samples was expressed in colony forming units (CFU) per gram of absolutely dry samples.

### Results and discussion

Agricultural land management has significant influence on soil microbiological activity (Garcia-Orenes *et al.*, 2013). Various practices in agriculture, such as pesticides application, influence microbial structure and microbiological processes (Morugan Coronado *et al.*, 2015). Also, growth of soil microflora depends on plant-soil interactions (Grayston *et al.*, 1998) and soil type (Girvan *et al.*, 2003).

In our research, microbial activity was affected by type of microorganisms, time of sampling and herbicide concentrations. In all treatments, total number of bacteria was highest after 130 days from sowing (Tab. 1). In most of samples, application of Lumax had stimulatory influence on total number of bacteria compared to control, especially at the end of experiment. Busse *et al.* (2000) suggest that glyphosate stimulated microbial activity when was applied directly to soil. These authors found increase in total number of bacteria and *Pseudomonas*, *Bacillus*, *Arthrobacter* and *Xanthomonas* populations. In carbon-limiting soils, bacteria are able to use herbicides as carbon and energy sources, which can be linked with increase of bacterial activity (Radosevich *et al.*, 1995).

Ammonification is important process of proteins transformation into mineral form (Jarak *et al.*, 2003). Because the proteins are commonly originated from microorganisms, number of ammonification bacteria represent an important parameter of soil microbial activity (Golic *et al.*, 2014). In treatments with 2 and 8 l/ha, highest number of ammonification bacteria was noticed in the first sampling and lowest at the end of experiment (Tab. 1), while in control and in treatment with 4 l/ha of herbicide, during the experiment, increase of number of ammonification bacteria was recorded. Studies of Hart and Brookes (1996) show that glyphosate application increased the intensity of ammonification compared with control. On the other side, using atrazine and alachlor, decrease of ammonifiers was noticed (Konstantinović, 1999).

Total number of bacteria ( $\times 10^4$ CFU/g)					
Treatments		2 l/ha	4 l/ha	8 l/ha	Control
Time of sampling	15 days	419.3	482.6	625.0	266.5
	30 days	191.5	353.9	249.0	256.8
	130 days	1701.8	1504.6	1079.37	1005.6
Ammonification bacteria ( $\times 10^4$ CFU/g)					
Treatments		2 l/ha	4 l/ha	8 l/ha	Control
Time of sampling	15 days	349.8	212.7	291.7	121.5
	30 days	156.2	213.0	128.9	215.6
	130 days	114.0	263.3	84.0	251.2

Nitrogen fixation bacteria are responsible for fixing of atmospheric nitrogen and its transformation into available forms (Bogdanović, 1990). From these bacteria, *Azotobacter sp.* is recommended as a parameter of soil fertility and important factor of atmospheric nitrogen fixation (Golic *et al.*, 2014). In first sampling number of nitrogen fixation bacteria was higher in treatments with herbicide compared to control, while at the end of experiment, number of this important physiological group of microorganisms was higher in control (Tab. 2).

Nitrogen fixation bacteria ( $\times 10^2$ CFU/g)					
Treatments		2 l/ha	4 l/ha	8 l/ha	Control
Time of sampling	15 days	170.0	137.1	197.0	92.0
	30 days	121.1	225.9	121.2	150.4
	130 days	69.5	115.7	46.3	122.5
<i>Azotobacter sp.</i> ( $\times 10^2$ CFU/g)					
Treatments		2 l/ha	4 l/ha	8 l/ha	Control
Time of sampling	15 days	88.5	79.0	62.5	87.7
	30 days	71.3	59.3	55.8	67.0
	130 days	115.7	115.7	87.4	94.3

On the other side, in most of samples, number of *Azotobacter* sp. in first sampling was lower in control compared to treated soil, while after 130 days from sowing its number was higher in soil treated with low herbicide concentrations. Also, at the end of experiment, lowest number of nitrogen fixation bacteria and *Azotobacter* sp. was detected in treatment with highest herbicide concentration (tab. 2). High concentrations of herbicides reduce the nodules number, nitrogenase activity and ATP synthesis (Govedarica *et al.*, 1993). The herbicide 2,4-D showed growth inhibition of nitrogen fixation bacteria (Gaherwal *et al.*, 2015). In contrast, growth of nitrogen fixation bacteria were stimulated after application of Anilofos coupled with 2,4-D (Patnaik *et al.*, 1995).

Table 3. Fungi and actinomycetes in soil samples ( $\times 10^3$  CFU/g)

		Fungi ( $\times 10^3$ CFU/g)			
Treatments		2 l/ha	4 l/ha	8 l/ha	Control
Time of sampling	15 days	97.3	28.6	41.6	9.5
	30 days	34.3	20.6	20.6	26.6
	130 days	17.2	10.3	8.5	13.7
		Actinomycetes ( $\times 10^3$ CFU/g)			
Treatments		2 l/ha	4 l/ha	8 l/ha	Control
Time of sampling	15 days	59.0	92.0	49.5	105.9
	30 days	207.0	134.0	95.3	274.0
	130 days	62.6	64.4	60.0	108.0

Fungi are group of microorganisms responsible for litter decomposition and its number depends on litter composition and various abiotic and biotic factors (Taylor and Sinsabaugh, 2015). Actinomycetes plays an important role in organic matter decomposition, degradation of pollutants and production of bioactive compounds (Dilip *et al.*, 2013). In first sampling, number of fungi was lowest in control treatment. In all treatments, highest number of fungi was recorded in first sampling, followed with decreasing of fungal number until the end of experiment (Tab. 3). Various effects of different Lumax concentrations on fungal number were noticed in this study. Reduction of fungal number using glyphosphate was recorded in previous research (Ubuoh *et al.*, 2012), but some *Mucor* and *Aspergillus* species were tolerant to herbicide application. Herbicide application had negative consequences for actinomycetes development in soil in all treatments compared to control (Tab. 3). In researches of other authors, significant inhibition of actinomycetes number was recorded using Paraquat (Zain *et al.*, 2013) and nicosulfuron, metribuzin and glyphosate (Šantrić *et al.*, 2016).

### Conclusion

Our results suggest the various influence of herbicide Lumax on microbial diversity in soil under corn. Total number of bacteria and *Azotobacter* sp. showed good adaptability in the presence of different Lumax concentrations. On the other side, in most of samples, number of fungi, ammonification and nitrogen fixation bacteria was highest 15 days after sowing and decreased during corn growth. These results can be useful for further research of Lumax application considering the importance of beneficial soil microflora in corn production.

## **Acknowledgements**

This research is partially supported by Ministry of Education, Science and Technological Development of the Republic of Serbia, Grant No. TR 31080.

## **References**

- Bogdanović V. (1990). Presence of microorganisms in the disposal site. *Zemljište i biljka*, vol. 39, pp. 139-145.
- Busse M.D., Ratcliff A.W., Shestak C.J., Powers R.F. (2000). Non-target effects of glyphosate on soil microbes. Presentation; California weed science society (Volume 52), January 12-14, 2009, Sacramento, USA, pp. 146-150.
- Castro M., Silva-Ferreira A.C., Manaia C.M., Nunes O.C. (2005). A case study of molinate application in a Portuguese rice field: herbicide dissipation and proposal of a clean-up methodology. *Chemosphere*, vol. 59, pp. 1059-1065.
- Cycon M., Piotrowska-Seget Z. (2007). Effect of selected pesticides on soil microflora involved in organic matter and nitrogen transformations: pot experiment. *Polish journal of ecology*, vol. 55, pp. 207-220.
- Devare M., Londono-R, L.M., Thies J.E. (2007). Neither transgenic Bt maize (MON863) nor tefluthrin insecticide adversely affect soil microbial activity or biomass: a 3-year field analysis. *Soil biology and biochemistry*, vol. 39, pp. 2038-2047.
- Dilip C.V., Mulaje S.S., Mohalkar R.Y. (2013). A review on actinomycetes and their biotechnological application. *International journal of pharmaceutical scientific research*, vol. 4(5), pp. 1730-1742.
- Gaherwal S., Prakash M.M., Khasdeo K., Sharma A. (2015). Impact of selected chemical and herbal pesticide on beneficial soil microorganism. *International journal of microbiological research*, vol. 6(3), pp. 236-239.
- Garcia-Orenes F., Morugan-Coronado A., Zornoza R., Scow K. (2013). Changes in soil microbial community structure influenced by agricultural management practices in a mediterranean agro-ecosystem. *PLoS ONE*, vol. 8:e80522.
- Girvan M.S., Bullimore J., Pretty J.N., Osborn A.M., Ball A.S. (2003). Soil type is the primary determinant of the composition of the total and active bacterial communities in arable soils. *Applied and environmental microbiology*, vol. 69, pp. 1800-1809.
- Hart M.R., Brookes P.C. (1996). Soil microbial biomass and mineralisation of soil organic matter after 19 years of cumulative field applications of pesticides. *Soil biology and biochemistry*, vol. 28(12), pp. 1641-1647.
- Golic Z., Malic N., Raicevic V. (2014). Presence of different groups of microorganisms in deposol in reclamation at Stanari coal mine. Presentation: Fifth international scientific agricultural symposium „Agrosym 2014“, October 23-26, 2014, Jahorina, Bosnia and Herzegovina, pp. 777-782.
- Govedarica M., Jarak M., Milošević N. (1993). Mikroorganizmi i pesticidi. U: *Teški metali i pesticidi u zemljištima Vojvodine*, Poljoprivredni fakultet, Institut za ratarstvo i povrtarstvo, Novi Sad, pp. 107-111.
- Grayston S.J., Wang S., Campbell C.D., Edwards A.C. (1998). Selective influence of plant species on microbial diversity in the rhizosphere. *Soil biology and biochemistry*, vol. 30, pp. 369-378.
- Gulhane P.A., Gomashe A.V., Sundarkar K.M. (2015). Influence of pesticides on nitrogen fixing bacteria. *International journal of technical research and applications*, vol. 3(4), pp. 157-160.

- Jarak M., Belić M., Govedarica M., Milošević N., Đurić S. (2003). Effect of phosphogypsum and peat on microbiological and chemical properties of arenosol. *Zemljište i biljka*, vol. 52, pp. 1-6.
- Konstantinović, B. (1999). *Poznavanje i suzbijanje korova*, Univerzitet u Novom Sadu, Poljoprivredni fakultet, Novi Sad, Stylos.
- Ministry of foreign trade and economic relations of Bosnia and Herzegovina (2016). Annual report about agriculture, feed and rural development of Bosnia and Herzegovina.
- Morugan Coronado A., García-Orenes F., Cerda A. (2015). Changes in soil microbial activity and physicochemical properties in agricultural soils in Eastern Spain. *Spanish journal of soil science*, vol. 5(3), pp. 201-213.
- Pandey S., Singh D.K. (2004). Total bacterial and fungal population after chlorpyrifos and quinalphos treatments in groundnut (*Arachis hypogaea* L.) soil. *Chemosphere*, vol. 55, pp. 197-205.
- Patnaik G.K., Kanungo P.K., Moorthy B.T., Mahana P.K., Adhya T.K., Rao V.R. (1995). Effect of herbicides on nitrogen fixation ( $C_2H_2$  reduction) associated with rice rhizosphere. *Chemosphere*, vol. 30(2), pp. 339-343.
- Peper I.L., Gerba C.P., Brendencke J.W. (1995): *Environmental Microbiology*. Acad. Press, San Diego, pp. 11-33.
- Radosevich M., Traina S.J., Hao Y.I., Touvinen O.H. (1995). Degradation and mineralisation atrazine by a soil bacterial isolate. *Applied and environmental microbiology*, vol. 61, pp. 297-302.
- Šantrić Lj., Radivojević Lj., Gajić Umiljendić J., Sarić-Krsmanović M., Đurović-Pejčev R. (2016). Effects of herbicides on growth and number of actinomycetes in soil and in vitro. *Pesticides phytomedicine (Belgrade)*, vol. 31(3-4), pp. 121-128.
- Sethi S., Gupta S. (2013). Impact of pesticides and biopesticides on soil microbial biomass carbon. *Universal journal of environmental research and technology*, vol. 3(2), pp. 326-330.
- Singh S., Datta P. (2006). Screening and selection of most potent diazotrophic cyanobacterial isolate exhibiting natural tolerance to rice field herbicides for exploration as biofertilizer. *Journal of basic microbiology*, vol. 46, pp. 219-225.
- Subhani A., El-ghamry A.M., Changyong H., Jianming X. (2000). Effects of pesticides (herbicides) on soil microbial biomass – a review. *Pakistan journal of biological sciences*, vol. 3(5), pp. 705-709.
- Taylor D.L., Sinsabaugh R.L. (2015). *The soil fungi: occurrence, phylogeny, and ecology*. Chapter 4. *Soil microbiology, ecology, and biochemistry*. Elsevier Inc, pp. 77-109.
- Ubuoh E.A., Akhionbare S.M.O., Akhionbare W.N. (2012). Effects of pesticide application on soil microbial spectrum: case study- fecolart demonstration Farm, Owerri-West, Imo State, Nigeria. *International journal of multidisciplinary sciences and engineering*, vol. 3(2), pp. 34-39.
- Weber J.B., Wilkerson G.G., Reinhardt C.F. (2004). Calculating pesticide sorption coefficients ( $K_{sub(d)}$ ) using selected soil properties. *Chemosphere*, vol. 55, pp. 157-166.
- Winding A., Kerstin H.R., Rutgers M. (2005). The use of microorganisms in ecological soil classification and assessment concepts. *Ecological and environmental safety*, vol. 62(2), pp. 230-248.
- Zain N.M.M., Mohamad R.B., Sijam K., Morshed M., Awang Y. (2013). Effects of selected herbicides on soil microbial populations in oil palm plantation of Malaysia: A microcosm experiment. *African journal of microbiology research*, vol. 7(5), pp. 367-374.



## THE EFFECT OF MINERAL TOP – DRRESING ON THE YIELD AND PROTEINS CONTENT IN SOME FODDER PEA VARIETIES

Igor ĐURĐIĆ<sup>1</sup>, Tanja JAKIŠIĆ<sup>1</sup>, Vesna MILIĆ<sup>1</sup>, Branka GOVEDARICA<sup>1</sup>, Milan JUGOVIĆ<sup>1</sup>, Marija SPASIC<sup>2</sup>

<sup>1</sup>University of East Sarajevo, Faculty of Agriculture, Vuka Karadjica 30, Bosnia and Herzegovina

<sup>2</sup>Institute of Agricultural Economics, Belgrade, Serbia

Corresponding author: vesnamlc@yahoo.co.uk

### Abstract

Forage pea is becoming more and more important plant species as the source of proteins in fodder foods. Although the surfaces on which this plant is grown have been increasing in Bosnia and Herzegovina still the farmers' needs have not been satisfied. A biannual experiment ( period 2016- 2017) were set up on the Agricultural institute of Republic of Srpska with five sorts of spring pea (NS Dukat, NS Junior, Bakara, Saša and NS Javor) and different varieties of fertilization (control, NPK fertilization and NPK fertilization+nitrogen fertilization) so we could recommend the best variety to the farmers. Saša variety (29.72 t ha<sup>-1</sup>) because of its yield stands out as the best one, but it also had high proteins content (19.99%), which is compared to the Baccara variety Baccara (20.04%) slightly lower. For economic reasons it is not viable to perform nitrogen fertilization together with NPK fertilization because it doesn't affect the yield increase, but it makes production more costly. Nitrogen fertilization negatively affects the proteins content so for these reasons basic fertilization with NPK fertilizers is recommended.

**Keywords:** *forage pea, variety, yield, proteins, green mass*

### Introduction

Forage pea is, like other legumes, rich in proteins, which makes it an important source of forage food (Tawaha & Turk, 2004; Rapčan et al., 2009; Corre-Hellou & Crozat 2005, Lauk & Lauk 2008). The pea is used as a green forage, silage, hay, milled beans are used as a protein concentrate, for green fertilization and it leaves 80-160 kg ha<sup>-1</sup> of active nitrogen.

The forage peas green mass represents cheap and quality source for ruminants nutrition. It contains 17, 5 to 18, 3% of raw proteins in its dry matter in average, and its digestibility ranges between 77 and 88 % (DLG, 1997; Stjepanović et al., 2008). The protein content in the above ground mass and grain varies depending on genotype, year and location (Lhuiller-Sondélé i et al., 1999; Lecoœur & Sinclair, 2001; Santalla et al., 2001; Rapčan et al., 2006). Forage pea, compared to others legumes, has shorter vegetation, bigger green mass and bean yield, and is a good pre-crop for most cultivars (Rapčan et al., 2004).

In Bosnia and Herzegovina pea is, as cattle food, produced in low quantity for usage in green mass, while it has been produced in symbolic amounts as a bean for animal nutrition. Pea is primarily grown as spring pea for bean and green mass (Ćota & Čamdžija, 2010).

### Matherial and work methods

The experiment is set in 2016 and 2017 at an experimental field of Republic of Srpska Agricultural Institute in Banja Luka (160 meters above sea level). Field experiment was set in a random block system in four repetitions. Sowing was conducted with 12, 5 cm spacing between rows and 8 cm in the inside of a row in the basic parcels with combined surface of 5 m<sup>2</sup>. Seeds of five different spring varieties of forage pea were used for sowing: NS Dukat, NS Junior, Baccara, Saša, NS Javor. For the research of mineral feeding effecting on raw proteins content in peas above ground mass, together with control variety, the variety with basic fertilization of 350 kg ha<sup>-1</sup> with N<sub>8</sub>P<sub>24</sub>K<sub>24</sub> fertilizer was also used, as well as the variety with basic fertilization of 350 kg ha<sup>-1</sup> with N<sub>8</sub>P<sub>24</sub>K<sub>24</sub> fertilitzer+top-dressing of 27 kg ha<sup>-1</sup> (27% KAN was used) . In 2016 the sowing was conducted on April 15th, and harvesting on July 15th, while in 2017 the sowing was on March 23rd, and harvesting on July 6th. The samples of above ground mass were taken in the inflorescence stage from a surface of 1 m<sup>2</sup> from every repetition. After weighing the mass of the samples was recalculated into amount of above ground vegetative mass expressed with t ha<sup>-1</sup>. The content of raw proteins was determined by Weende (Kjeltec autosampler 1035-Tecator) in the laboratory of the Faculty of Agriculture in East Sarajevo. The obtained data were processed by multivariate analysis of variance (MANOVA) and tested with LSD test (STATISTICA 7.1 for Windows (Stat Soft 2005).

### Agroecological conditions

Total monthly rainfall and average air temperatures for years in which the research was conducted and perennial average in Banja Luka are showed in Table 1.

**Table 1.** Average monthly air temperatures (°C), monthly rainfall (mm) and perennial averages for Banja Luka

Month		I	II	III	IV	V	VI	VII
2016.	Temperature (°C)	2.3	7.6	8.0	13.5	16.2	21.5	23.3
	Rainfall (mm)	109.7	108.5	122.2	0.5	100.6	117.8	125.9
2017.	Temperature (°C)	-3.6	5.5	9.7	11.8	17.5		
	Rainfall (mm)	87.2	100.4	124.0	148.4	92.1		
Average 1981-2010	Temperature (°C)	0.6	2.3	6.8	11.5	16.5	19.8	21.8
	Rainfall (mm)	69.7	59.1	87.5	84.3	89.4	112.4	81.4

Regarding the temperature, the conditions were favorable for pea growth. Average monthly temperatures were above the perennial average in both years during the experiment, with only May 2016 having slightly lower average temperature compared to the perennial average. In the vegetation period, the rainfall varied year to year and month to month. In 2016, May was the extreme month with the rainfall of only 0, 5 mm, and in 2017, June and July were the dry months. Uneven rainfall affects the yield and quality of forage pea.

The soil on which the experiment was conducted is of good physical properties with plow depth up to 35 cm. According to agrochemical analysis performed in the Faculty of

Agriculture in East Sarajevo, the soil contains 0,13% of nitrogen, 8,6% of calcium, 2,05% humus, >40 mg/100 g phosphorus and 38,48 mg/100 g potassium. The soil reaction is neutral with pH in nKCl at 6,97.

### Results and discussion

The average green mass yield for all forage pea varieties was 20,83 t ha<sup>-1</sup>, regardless of experimental years and fertilization varieties. (Table 2).

**Table 2.** The effect of year, fertilization and variety on green mass yield

NPK amount	Variety	Year		Average
		2016	2017	
Control	NS Dukat	15.50	13.75	14.62
	NS Junior	21.50	19.00	20.25
	Baccara	17.25	16.75	17.00
	Saša	24.75	20.25	22.50
	NS Javor	12.50	11.50	12.00
	Prošjek	18.30	16.25	17.27
Basic fertilization	NS Dukat	21.25	18.25	19.75
	NS Junior	27.25	22.50	24.87
	Baccara	18.75	17.25	18.00
	Saša	35.25	23.00	29.12
	NS Javor	20.00	19.75	19.88
	Prošjek	24.50	20.15	22.32
Basic fertilization+ top-dressing	NS Dukat	20.83	20.25	20.54
	NS Junior	25.45	22.50	23.97
	Baccara	16.80	15.50	16.15
	Saša	41.05	34.00	37.52
	NS Javor	16.50	16.00	16.25
	Prošjek	24.12	21.65	22.89
Average	NS Dukat	19.19	17.42	18.30
	NS Junior	24.73	21.33	23.03
	Baccara	17.60	16.50	17.05
	Saša	33.68	25.75	29.72
	NS Javor	16.33	15.75	16.04
Total average		22.31	19.35	20.83
Treatments		F-test	LSD 0,05	LSD 0,01
A (year)		<.001	1.564	2.072
B (fertilization)		<.001	1.915	2.537
C (variety)		<.001	2.472	3.276
AxB (year x fertilization)		0.450	2.708	3.588
AxC (year x variety)		0.028	3.496	4.633
BxC (fertilization x variety)		<.001	4.282	5.674
AxBxC (year x fertilization x variety)		0.961	6.056	8.024

In 2016, the average green biomass yield was statistically significantly higher, compared to 2017 (19,35 t ha<sup>-1</sup>). In 2017, there was an unfavorable rainfall schedule, which significantly affected the green mass yield. Forage pea requires a lot of moisture, so the amount and the

schedule of rainfall during the vegetation period are crucial for bean and green mass formation. The amount of rainfall in May and the first ten days of June are significant for the spring peas yield (Kovac, 1994; Rapcan et al, 2006). The control variety, compared to others where mineral fertilizers were applied, had statistically significant smallest yield of green mass, while the differences in varieties with mineral top-dressing had no statistical significance.

The Saša variety (29,72 t ha<sup>-1</sup>) compared to other varieties had significantly higher yield, and the NS Junior variety (23,03 t ha<sup>-1</sup>) had higher yield when compared to NS Dukat, Baccara, NS Javor varieties, while there were not significant differences between these varieties. Hoffman i Dér (2003) established in their research that variety had a significant influence on fresh mass yield in pea, which is in accordance with our results. In every variety in the year 2016, there was a bigger yield in green mass compared to 2017. Unfavorable weather conditions in 2017 had an effect on significant decrease in the Saša variety because the difference between the researched years was 7,93 t ha<sup>-1</sup>. Year significantly affected the green mass yield in NS Junior variety also (3,4 t ha<sup>-1</sup>), while the differences in other varieties varied between 0,55 and 1,77 t ha<sup>-1</sup>.

The average raw proteins content for all tested varieties regardless of experimental years and fertilization varieties was 18,03% (table 3).

The proteins content in above ground green mass, from a statistic point of view, was significantly higher in 2016 (19,235), when compared to 2017. (16,74%). The fertilization did not have a significant effect on proteins content, as even in NPK fertilization+ nitrogen top-dressing variety there was determined the smallest protein content, which is in accordance with results gathered by Štafa et al. (1999). In the year+fertilization interaction we determined highly significant differences in proteins content. Larger proteins content was found in 2016 in all fertilization varieties, compared to 2017. The Baccara variety (20,04%) had the largest proteins content, and the NS Dukat (14,04%) had the smallest. The determined differences were highly significant from the statistical point of view, as well as the differences between the NS Dukat variety and varieties NS Junior, Saša and NS Javor. Significant difference in proteins content was determined between varieties NS Javor and Saša, and highly significant between Saša and NS Junior. Although all varieties had larger proteins percentage in 2016 than in 2017 it is interesting that there was a significant decrease of proteins percentage in the NS Dukat variety in 2017. In the control variety there in NS Dukat, NS Junior and Baccara there were more proteins, when compared to NPK fertilization+ nitrogen top-dressing variety.

**Table 3.** The effect of the year, fertilization and variety on pea's raw proteins percentage

NPK Amount	Variety	Year		Average
		2016	2017	
Control	NS Dukat	18.59	10.59	14.59
	NS Junior	18.61	16.80	17.70
	Baccara	20.58	19.57	20.07
	Saša	20.30	18.99	19.64
	NS Javor	18.38	16.94	17.66
	Prosjek	19.29	16.58	17.94
Basic fertilization	NS Dukat	19.13	9.04	14.09
	NS Junior	18.52	17.56	18.04
	Baccara	21.06	19.27	20.16
	Saša	20.81	20.50	20.65
	NS Javor	18.98	18.24	18.61
	Prosjek	19.70	16.92	18.31
Basic fertilization+top dressing	NS Dukat	17.08	9.79	13.44
	NS Junior	16.95	17.58	17.26
	Baccara	21.31	18.45	19.88
	Saša	20.24	19.11	19.67
	NS Javor	19.24	18.71	18.98
	Prosjek	18.96	16.73	17.85
Average	NS Dukat	18.27	9.81	14.04
	NS Junior	18.03	17.31	17.67
	Baccara	20.98	19.09	20.04
	Saša	20.45	19.53	19.99
	NS Javor	18.87	17.97	18.42
Total average		19.32	16.74	18.03
Treatments		F-test	LSD 0,05	LSD 0,01
A (year)		<.001	0.661	0.875
B (fertilization)		0.482	0.809	1.072
C (variety)		<.001	1.044	1.383
AxB (year x fertilization)		0.768	1.144	1.515
AxC (year x variety)		<.001	1.477	1.956
BxC (fertilization x variety)		0.775	1.809	2.396
AxBxC (year x fertilization x variety)		0.701	2.558	3.389

### Conclusion

Although the agroecological conditions were favourable for forage pea growth, unfavourable rainfall schedule during the experiment in 2017 affected the yield of green mass and the proteins content in above ground pea mass. During the usage of different mineral top – dressing treatments, the smallest yield of green mass was found in the control variety, while the usage of NPK fertilizers and the combination of NPK fertilizers and top – dressing did not significantly affected the differences in the yield. The use of mineral fertilizers, especially nitrogen, had a negative effect on the proteins content. The biggest green mass yield in both years of the experiment had the NS Saša variety, but the variety had a significant fluctuation depending on agroecological conditions. The smallest green mass yield had the NS Javor

variety. The Baccara variety had the highest protein content and the Dukat variety had the lowest.

### References

- Corre-Hellou G, Crozat Y (2005): N<sub>2</sub> fixation and N supply in organic pea (*Pisum sativum* L.) cropping systems as affected by weeds and pea weevil (*Sitona lineatus* L.). *Eur. J. Agron.* 22: 449-458
- Ćota J., Čamdžija S. (2010): Pea productive and quality characteristic in sarajevo region. *AgroSym*, 345-350.
- Group of authors (1997): DLG-Futterwerttabellen –Wiederkauer. Universität Hohenheim – Dokumentationsstelle.
- Hoffman F., Dér F. (2003). Yield of different green forage crops, in pure stand and in mixture. *Agriculturae Conspectus Scientificus.* 68 (4): 275-279.
- Kovac K. (1994): The effect of some intensification factors on the pea yield of intermediary type in maize-growing region (Czech). *Rostlinna Vyroba* 40(10), 949-956.
- Lauk R., Lauk E. (2008): Pea-oat intercrops are superior to pea-wheat and pea-barley intercrops. *Acta Agric. Scand. Section B: Plant Soil Sci.* 58: 139-144.
- Lecoeur J., Sinclair T.R. (2003). Harvest index increase during seed growth of field pea. *European Journal of Agronomy.* 14: 173-180.
- Lhuller-Sondele, A., Munier-Joilan N. G., Ney B. (1999): Dependence of seed nitrogen concentration on plant nitrogen availability during the seed filling in pea. *European Journal of Agronomy* 11, 157-166.
- Rapčan Irena, Mikleušević Marija, Jurišić M. (2009): Yields of two field pea cultivars in agroecologic conditions of Eastern Slavonia. 44th Croatian & 4th International Symposium on Agriculture, 634-638.
- Rapčan Irena, Bukvić Gordana, Grljušić Sonja, Teklić Tihana, Jurišić M. (2006): The influence of agroecological conditions and seed maturity on the grain yield and quality of field pea (*Pisum sativum* L.). *Mljekarstvo* 56 (4) 331-342.
- Rapčan Irena, Jurišić M., Grljušić Sonja (2004): Response of pea (*Pisum sativum* spp. *Arvense* L.) at sowing term, stand and nitrogen fertilization at area of Osijek. *Agronomski glasnik*, 33-45.
- Santalla M., Amurrio J. M., De Ron A. M. (2001): Food and feed potential breeding value of green, dry and vegetable pea germplasm. *Canadian Journal of Plant Science* 81(4), 601-610.
- Stjepanović M., Gantner R., Popović S., Čupić T., Knežević M., Vranić Marina (2008): Forage value of winter pea/wheat mixture at different terms of cutting. *Krmiva* 50, Zagreb, 1; 11-17.
- Štafa Z., Redžepović S., Grbeša D., Uher D., Maćešić D., Leto J. (1999): Effect of Inoculation and Top-Dressing with KAN on Yields and Characteristics of Winter Peas in Wheat Mixture. *ACS, Agric. conspec. sci.* Vol. 64, No. 3.
- Tawaha A.M., Turk M.A. (2004). Field pea seedling management for semiarid mediterranean conditions. *Journal of Agronomy & Crop Science.* 190: 86-92.

## **EFFECTS OF WEATHER CONDITIONS IN BOSNIA AND HERZEGOVINA FROM 2011 TO 2015 GROWING SEASONS REGARDING MAIZE GROWTH AND CLIMATIC CHANGE**

Vojo RADIC<sup>1\*</sup>, Vlado KOVACEVIC<sup>2</sup>, Ilija KOMLJENOVIC<sup>1</sup>, Meho MAJDANCIC<sup>3</sup>, Aleksandra FIGUREK<sup>1</sup>

<sup>1</sup>University of Banja Luka, Faculty of Agriculture Banja Luka, Bulevar vojvode P. Bojovicala, 78000 Banja Luka, Bosnia and Herzegovina

<sup>2</sup>University J. J. Strossmayer in Osijek, Faculty of Agriculture, Vladimira Preloga Street 1, 31000 Osijek, Croatia

<sup>3</sup>University of Tuzla, Faculty of Technology, University Street 8, 75107 Tuzla, Bosnia and Herzegovina

\*Corresponding author: vojo.radic@agro.unibl.org

### **Abstract**

Maize is main field crop on the arable lands of Bosnia and Herzegovina (B&H). In the 2011-2015 period, maize was grown on average 189 137 ha or close to 20% of arable land. The majority of maize growing area was situated in the northern lowland region and in Republic of Srpska (RS). Considerable variation of the yearly yield was found in this period from 2.7 t ha<sup>-1</sup> (2012) to 4.7 t ha<sup>-1</sup> (2014), mainly under influence of weather conditions. With that regard, precipitation and temperature regimes, particularly in July and August, had considerable effects. 2011, 2013 and 2015 growing seasons were more close to usual values. However, 2012 and 2014 were considerably deviated and characterized by drought and hot stress (2012) and excessive, but for maize more favorable, precipitation and the lower temperature (2014). Six meteorological stations were selected for weather characterization as follows: Bijeljina (BI), Tuzla (TZ), Gradacac (GR), Banjaluka (BL), Prijedor (PR) and Bihac (BH). Precipitation and mean air temperatures in the period 2011-2015 were compared to the long-term means 1961-1990 (LTM). In general, precipitation in the April-September period (LTM) was lower and temperatures higher in the eastern part (BI: 417 mm and 17.8 °C) than in western part (BI: 664 mm and 16.6 °C) of the country. These values for two deviated growing seasons were as follows: 288 mm and 20.0 °C in BI, 693 mm and 18.9 °C in BH (2012), 731 mm and 18.5 °C in BI, 1135 mm and 17.1 °C in BH (2014).

**Keywords:** *precipitation, temperature, maize yield, climatic change.*

### **Introduction**

Maize is main field crop on the arable lands of Bosnia and Herzegovina (B&H). In the 2011-2015 period, maize was grown close to 20% of arable land of the country. Average yield in the mentioned period was 3.92 t ha<sup>-1</sup> (AS, from 2012 to 2016) and it is low with the aspect of possibilities, the existence of high-yielding hybrids and environmental conditions under different systems of soil tillage (Jug et al., 2014). Weather conditions are also important factors of maize yield and weather excess accompanied with drought and high air temperature, particularly in July and August, are often in connection with low yields (Kovacevic et al., 2013, 2016; Kovacevic and Rastija, 2014; Majdancic et al., 2016). In the recent period there are considerable variations annual yields of maize among years mainly as affected by climatic change, particularly extreme drought during summer months (Kovacevic and Rastija, 2014). Aim of this study was testing maize yields in B&H for the recent 5-year period with emphasis on climatic change.

## **Material and methods**

The FAO database (FAO), releases of Agency for Statistics (AS) of Bosnia and Herzegovina (Agriculture, Environment and Regional Statistics: harvested area, total production and yield of main crops), statistical yearbooks Republic of Srpska (SYRS) and Federation of B&H (SYFB&H) were used as source of the arable land, harvested area and maize yield data. Publications of Hydrometeorological Institute of the Republic of Srpska in Banja Luka and Federal Hydrometeorological Institute in Sarajevo were perused for used the meteorological data as follows: monthly values of precipitation and mean air temperature, means of minimal and maximal air temperatures and their absolute values. B&H is administratively divided into two political entities (Federation of B&H or FB&H and Republic of Srpska or RS) and Brcko district.

Six meteorological stations (MS) situated in the northern part of the country - three from RS and three from FB&H - were selected for analyzing of weather data with the aspect of maize growth (Fig 1). The most western and the most eastern positions of Bihac and Bijeljina are air-distanced 320 km. Choice of this part of B&H is resulted by the fact that by these localities are covered majority growing area of maize in B&H.

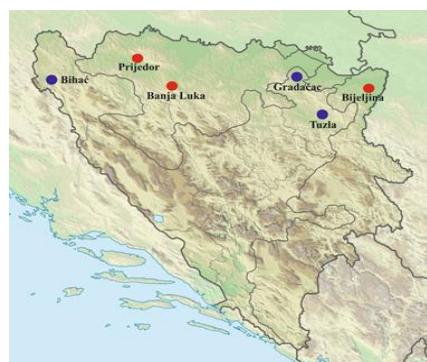


Fig. 1. Situation of MS in B&H

## **Results and discussion**

B&H has on disposal about 1 million ha of arable land and gardens and even close to 50% are fallow and uncultivated land. Maize harvested area in the 2011-2015 period was average 189 137 ha and close to decade 2000-2010 average. However, average maize yield 3.92 t ha<sup>-1</sup> is about 12% lower compared to the decade average. About 70% of maize harvested area are situated in RS. High variation of yields are mainly affected by weather conditions (Table 1).



**Table 1.** The harvested area and yields of maize in B&H and in level of the entities

Statistical data from 2011 to 2015 (FAO, AS, SYRS and SYFB&H)							
Average		Year					Average
2001-2010		2011	2012	2013	2014	2015	2011-2015
<b>Arable land and gardens (000 ha): total, fallow and unfarmed land</b>							
Total		1 009	1 006	998	1 011	1 029	1 010
Fallow and unfarmed		478	476	478	508	510	490
<b>Harvested area (ha) and yields of maize for grain (t ha<sup>-1</sup>)</b>							
Bosnia and Herzegovina							
ha	195 887	195 970	196 504	189 554	169 948	193 707	189 137
t ha <sup>-1</sup>	4.42	3.9	2.7	4.2	4.7	4.1	3.92
The entity Republic of Srpska (RS)							
ha	142 053	142 273	142 742	135 143	120 901	138 824	135 977
t ha <sup>-1</sup>	4.60	3.80	2.70	4.10	4.80	4.00	3.90
Federation of B&H (FB&H)							
ha	48 490	48 620	48 558	49 497	43 866	48 154	47 568
t ha <sup>-1</sup>	4.22	4.20	2.90	4.60	4.01	3.90	4.02
<b>Yield variations in B&amp;F (2001 - 2015 ):</b> from 2.7 t ha <sup>-1</sup> (2012) to 5.1 t ha <sup>-1</sup> (2004 and 2005)							

Precipitation in April-September of 2011-2015 (average of six MS) in amount 535 mm was at the level of 1961-1990 average (529 mm), but it was characterized by extreme variation from 352 mm in 2001 to 1000 mm in 2014 (Table 2).

**Table 2.** Precipitation, geographical coordinates and elevation (el.) above sea level

Precipitation in 2011-2015 period and long-term mean (LTM: 1961-1990)														
Year	Monthly precipitation (mm)							Monthly precipitation (mm)						
	Apr.	May	June	July	Aug	Sept	Σ	Apr.	May	June	July	Aug	Sept	Σ
<b>Bijeljina</b>							<b>Tuzla</b>							
44°45'24" N, 19°12'57" E; el. 91 m							44°32'17"N, 18°40'34"E; el. 239 m							
2011	32	78	51	86	1	16	<b>267</b>	29	86	74	147	13	14	<b>363</b>
2012	91	97	44	36	0	19	<b>287</b>	92	137	55	8	0	27	<b>319</b>
2013	28	182	57	37	18	51	<b>373</b>	31	168	74	55	36	79	<b>443</b>
2014	83	252	67	73	147	109	<b>731</b>	187	339	64	112	184	135	<b>1021</b>
2015	57	100	22	11	39	73	<b>302</b>	58	122	93	11	55	81	<b>420</b>
LTM	<b>68</b>	<b>81</b>	<b>86</b>	<b>68</b>	<b>61</b>	<b>53</b>	<b>417</b>	<b>76</b>	<b>92</b>	<b>111</b>	<b>94</b>	<b>84</b>	<b>64</b>	<b>521</b>
<b>Gradacac</b>							<b>Banjaluka</b>							
44°53'00" N; 18°26'00" E; el. 129 m							44°46'32" N, 17°11'08" E; el. 158 m							
2011	26	44	61	97	9	18	<b>255</b>	38	63	37	113	9	26	<b>286</b>
2012	111	121	90	45	1	36	<b>404</b>	103	168	70	53	2	92	<b>488</b>
2013	55	175	87	36	26	60	<b>439</b>	63	120	54	27	36	70	<b>370</b>
2014	145	301	72	80	194	129	<b>921</b>	214	218	97	139	276	284	<b>1228</b>
2015	50	124	43	6	72	113	<b>408</b>	54	118	61	21	23	75	<b>352</b>
LTM	<b>73</b>	<b>92</b>	<b>99</b>	<b>86</b>	<b>74</b>	<b>65</b>	<b>488</b>	<b>87</b>	<b>98</b>	<b>111</b>	<b>95</b>	<b>93</b>	<b>82</b>	<b>566</b>
<b>Prijedor</b>							<b>Bihac</b>							
44°46'32" N, 17°11'08" E; el. 158 m							44°48'49.7"N, 15°52'19.7"E; el. 231m							
2011	244	39	53	138	20	30	<b>524</b>	52	101	80	100	25	60	<b>418</b>
2012	87	116	64	35	1	64	<b>367</b>	128	155	74	104	39	193	<b>693</b>
2013	72	73	54	18	64	63	<b>344</b>	88	98	73	36	85	99	<b>479</b>
2014	164	219	78	127	142	237	<b>967</b>	187	199	87	228	105	329	<b>1135</b>
2015	49	115	85	24	104	124	<b>501</b>	91	172	80	44	97	150	<b>634</b>
LTM	<b>84</b>	<b>90</b>	<b>89</b>	<b>98</b>	<b>80</b>	<b>79</b>	<b>520</b>	<b>115</b>	<b>116</b>	<b>109</b>	<b>107</b>	<b>109</b>	<b>108</b>	<b>664</b>

However, the mean air temperature in 2011 -2015 period (April-September) was 18.9 °C or for 1.9 °C higher than in 1961-1990 with variation among years from 17.8 °C in 2014 to 19.7 °C in 2012 (Table 3). In general, precipitation quantities have increasing trend and

temperature decreasing trend in the direction from the east toward the west (1961-1990: Bijeljina 417 mm and 17.8 °C and Bihac 664 mm and 16.6 °C). Average minimal and average maximal temperature in the 2011-2015 period (Table 4) was 13.4 °C and 25.6 °C in Bijeljina, 11.9 °C and 24.9 °C in Bihac (averages 1961-1990: 13.7 °C and 24.4 °C, 10.5 °C and 22.8 °C, for Bijeljina and Bihac, respectively). Absolute minimal air temperature in 2011-2015 period (Table 5) was recorded in April of 2012 (Bijeljina -2.8 °C and Bihac -4.0 °C (1961-1990: Bijeljina -0.6 °C and Bihac -4.6 °C), while values for absolute maximal temperature were for 2011-2015 period were recorded in August of 2012 (Bijeljina 40.3 °C) and 2013 (Bihac 42.0 °C). Comparison these values with 1961-1990 period (34.7 °C in Bijeljina and 38.6 °C in Bihac) indicating global warming (Chi-Chung et al., 2004, FAO, 2007). The 2012 growing season was unfavorable for maize growth because of lower precipitation and the higher temperature in April-September period (means of 6 stations: 427 mm and 19.8 °C). Especially unfavorable weather conditions were observed in August for all tested sites with exception Bihac (from 0 to 2 mm precipitation and mean air temperature between 24.1 °C in Prijedor to 25.8 °C in Gradacac; Bihac 39 mm and 22.9 °C: Tables 1-2). Absolute maximal air temperature in Bijeljina was in three 10-day periods of August 2012 from 35.6 °C to 40.3 °C and by these stress conditions was also exposed maize in the eastern parts of Croatia and Hungary, as well as in the northern part of Serbia in Vojvodina province (Table 6). As affected by these conditions maize yields in 2012 were low in B&H (2.74 t ha<sup>-1</sup>), in the neighbouring Croatia (4.34 t ha<sup>-1</sup>) and Serbia (2.78 t ha<sup>-1</sup>), as well as in Hungary (3.98 t ha<sup>-1</sup>) and yield decrease in 2012 compared to normal weather conditions in 2010 were between 38% (Croatia and Hungary: in B&H 40%) and 53% in Serbia (Kovacevic et al., 2013).

**Table 3.** Monthly mean air temperatures

Year	Air temperatures in 2011-2015 and long-term mean (LTM: 1961-1990)													
	Mean air temperature (°C)							Mean air temperature (°C)						
	Apr.	May	June	July	Aug	Sept	X	Apr.	May	June	July	Aug	Sept	X
	<b>Bijeljina</b>							<b>Tuzla</b>						
2011	13.6	16.8	21.4	23.3	23.4	20.6	<b>19.9</b>	12.1	14.3	19.2	21.2	22.0	19.4	<b>18.0</b>
2012	12.7	16.1	23.0	25.2	24.2	18.9	<b>20.0</b>	11.5	14.8	21.4	23.9	23.3	18.3	<b>18.9</b>
2013	13.2	17.1	20.7	23.4	24.0	16.4	<b>19.1</b>	12.8	15.7	18.6	20.9	21.6	15.0	<b>17.4</b>
2014	13.1	16.1	20.8	22.6	21.4	17.0	<b>18.5</b>	11.5	14.5	18.5	20.3	19.6	15.6	<b>16.7</b>
2015	12.5	18.5	21.2	25.7	24.5	18.7	<b>20.2</b>	10.7	16.6	19.0	23.3	22.9	17.3	<b>18.3</b>
<i>LTM</i>	<b>11.0</b>	<b>16.3</b>	<b>19.8</b>	<b>21.7</b>	<b>21.1</b>	<b>16.8</b>	<b>17.8</b>	<b>10.4</b>	<b>14.8</b>	<b>17.7</b>	<b>19.3</b>	<b>18.9</b>	<b>15.5</b>	<b>16.1</b>
	<b>Gradacac</b>							<b>Banjaluka</b>						
2011	13.8	16.5	21.1	22.6	24.0	21.6	<b>19.9</b>	13.0	16.0	21.2	23.1	23.7	20.2	<b>19.5</b>
2012	13.3	16.8	22.8	25.2	25.8	20.1	<b>20.7</b>	12.7	16.1	23.0	25.2	24.2	18.9	<b>20.0</b>
2013	14.1	16.6	20.4	23.6	23.7	16.9	<b>19.2</b>	13.4	16.6	20.4	23.0	23.5	16.7	<b>18.9</b>
2014	12.9	15.8	20.4	21.8	21.1	16.7	<b>18.1</b>	13.1	15.8	20.3	21.7	20.6	16.4	<b>18.0</b>
2015	12.8	17.7	20.7	25.0	24.4	18.8	<b>19.9</b>	11.8	17.4	20.9	25.2	24.0	18.3	<b>19.6</b>
<i>LTM</i>	11.3	<b>15.9</b>	<b>19.0</b>	<b>20.9</b>	<b>20.3</b>	<b>16.9</b>	17.4	<b>10.9</b>	<b>15.6</b>	<b>18.9</b>	<b>20.6</b>	<b>19.7</b>	<b>15.9</b>	<b>16.9</b>
	<b>Prijedor</b>							<b>Bihac</b>						
2011	11.2	14.1	18.4	20.3	21.0	18.4	<b>19.3</b>	12.5	15.2	19.8	22.0	21.8	19.1	<b>18.4</b>
2012	12.4	16.5	22.8	24.8	24.1	18.5	<b>19.9</b>	12.2	15.3	22.4	23.5	22.9	17.0	<b>18.9</b>
2013	13.5	16.7	20.4	23.1	23.1	16.4	<b>18.9</b>	12.5	15.4	19.3	22.0	21.7	15.7	<b>17.8</b>
2014	13.5	16	20.6	21.8	20.7	16.6	<b>18.2</b>	12.3	14.9	19.5	20.5	19.8	15.5	<b>17.1</b>
2015	11.8	17.7	20.6	24.4	23.1	17.2	<b>19.1</b>	11.6	17.3	20.0	23.8	22.1	17.0	<b>18.6</b>
<i>LTM</i>	<b>11.1</b>	<b>15.8</b>	<b>19.1</b>	<b>20.8</b>	<b>21.0</b>	<b>16.4</b>	17.4	<b>10.7</b>	<b>15.1</b>	<b>18.9</b>	<b>20.0</b>	<b>19.2</b>	<b>15.9</b>	<b>16.6</b>

**Table 4.** Mean minimal and mean maximal air temperatures in Bijeljina and Bihac

Month	Air temperatures in 2011-2015 and long-term mean (LTM: 1961-1990)											
	Bijeljina						Bihac					
	2011	2012	2013	2014	2015	LTM	2011	2012	2013	2014	2015	LTM
	Mean minimal air temperature (°C)						Mean minimal air temperature (°C)					
Apr.	7.6	6.6	6.7	8.2	5.8	<b>5.5</b>	6.0	7.0	5.9	7.6	6.0	<b>5.1</b>
May	10.6	10.9	11.6	10.4	12.3	<b>10.1</b>	8.4	8.7	10.3	9.2	11.7	<b>9.1</b>
June	15.3	16	14.6	14.7	14.5	<b>13.6</b>	13.3	15.2	12.7	13.3	13.0	<b>12.2</b>
July	17.1	18.3	15.9	16.9	17.9	<b>14.8</b>	15.5	16.0	14.4	14.8	16.1	<b>13.3</b>
Aug	16.5	15.8	16.8	16.2	17.6	<b>14.2</b>	14.7	14.3	14.7	14.4	16.1	<b>13.0</b>
Sept.	13.7	13.1	11.2	13.3	13.9	<b>11.0</b>	12.0	12.0	10.0	12.3	12.9	<b>10.3</b>
Mean	<b>13.5</b>	<b>13.5</b>	<b>12.8</b>	<b>13.3</b>	<b>13.7</b>	11.5	<b>11.7</b>	<b>12.2</b>	<b>11.3</b>	<b>11.9</b>	<b>12.6</b>	10.5
	Mean maximal air temperature (°C)						Mean maximal air temperature (°C)					
Apr.	19.5	19.5	20.1	18.8	17.1	<b>17.8</b>	19.0	17.8	18.5	17.8	18.0	<b>16.3</b>
May	20.3	22.8	23.6	21.9	24.3	<b>22.8</b>	22.7	22.0	21.5	20.9	23.3	<b>21.0</b>
June	27.6	30.4	26.2	26.8	27.9	<b>25.7</b>	26.2	29.1	25.6	26.3	27.1	<b>24.2</b>
July	29.4	32.8	30.0	28.8	24.9	<b>27.9</b>	28.8	30.8	29.4	26.4	31.8	<b>26.7</b>
Aug	31.3	33.6	30.9	27.7	27.9	<b>27.9</b>	30.4	32.3	29.9	26.1	29.3	<b>26.2</b>
Sept.	28.9	27	23.4	22.4	21.6	<b>24.3</b>	27.2	23.4	22.8	20.3	22.2	<b>22.6</b>
Mean	<b>26.2</b>	<b>27.7</b>	<b>25.7</b>	<b>24.4</b>	<b>24.0</b>	24.4	<b>25.7</b>	<b>25.9</b>	<b>24.6</b>	<b>23.0</b>	<b>25.3</b>	22.8

**Table 5.** Absolute minimal and absolute maximal temperature in Bijeljina and Bihac

Month	Air temperatures in 2011-2015 and long-term mean (LTM: 1961-1990)											
	Bijeljina						Bihac					
	2011	2012	2013	2014	2015	LTM	2011	2012	2013	2014	2015	LTM
	Absolute minimal air temperature (°C)						Absolute minimal air temperature (°C)					
Apr.	3.0	-2.8	0.4	2.0	-0.4	<b>-0.6</b>	-0.4	-4.0	-0.3	1.1	-1.1	<b>-4.6</b>
May	1.4	5.7	5.2	4.0	5.4	<b>3.9</b>	0	0.7	3.4	2.2	4.5	<b>-2.4</b>
June	9.8	8.1	9.6	9.2	9.3	<b>7.9</b>	8.2	9.2	5.1	7.0	6.0	<b>2.4</b>
July	9.3	12.3	10.6	12.7	11.0	<b>9.9</b>	7.5	8.8	10.5	8.4	9.8	<b>4.4</b>
Aug	10.2	9.7	11.7	9.2	12.0	<b>8.8</b>	6.9	8.9	8.8	8.2	10.2	<b>3.6</b>
Sept.	8.0	5.4	5.8	6.2	6.0	<b>4.8</b>	6.7	2.9	3.4	4.0	5.0	<b>-2.4</b>
Mean	<b>7.0</b>	<b>6.4</b>	<b>7.2</b>	<b>7.2</b>	<b>7.2</b>	5.8	<b>4.8</b>	<b>4.4</b>	<b>5.2</b>	<b>5.2</b>	<b>5.7</b>	0.2
	Absolute maximal air temperature (°C)						Absolute maximal air temperature (°C)					
Apr.	25.2	29.6	31.1	24.6	27.3	<b>26.2</b>	26.1	30.0	29.9	25.5	25.5	<b>30.8</b>
May	30.6	32.2	31.8	29.8	32.4	<b>30.2</b>	29.9	31.1	31.2	29.6	32.8	<b>32.6</b>
June	34.6	36.6	36.1	33.3	34.3	<b>32.9</b>	32.9	37.0	35.8	34.6	32.7	<b>34.6</b>
July	37.2	38	39.2	33.4	37.8	<b>34.7</b>	39.6	38.0	39.3	33.1	37.9	<b>38.6</b>
Aug	38.0	40.3	39.1	34.4	37.8	<b>33.4</b>	38.1	40.0	42.0	33.2	35.6	<b>37.4</b>
Sept.	35.4	34.6	29	28.6	38.8	<b>31.6</b>	36.1	29.6	29.3	28.1	34.4	<b>35.0</b>
Mean	<b>33.5</b>	<b>35.2</b>	<b>34.4</b>	<b>30.7</b>	<b>34.7</b>	31.5	<b>33.8</b>	<b>34.3</b>	<b>34.6</b>	<b>30.7</b>	<b>33.2</b>	34.8

**Table 6.** Mean maximal and absolute maximal temperature in the 2012 growing season

Month	The 2012 growing season: average (AverageM) and absolute (AbsoluteM) maximal airtemperature in the 10-days intervals (a = 1-10; b = 11-20; c = 21-30/31)											
	AverageM (°C)			AbsoluteM (°C)			AverageM (°C)			AbsoluteM (°C)		
	a	b	c	a	b	c	a	b	c	a	b	c
	<b>Osijek (Croatia)</b>						<b>Novi Sad (Serbia)</b>					
July	35.8	30.7	29.0	37.0	36.0	35.0	35.5	31.2	29.6	37.1	34.8	36.6
August	33.3	29.5	33.8	40.1	34.6	40.3	33.5	29.6	33.9	38.4	33.9	39.7
	<b>Debrecen (Hungary)</b>						<b>Bijeljina (B&amp;H)</b>					
July	34.5	27.7	28.9	36.6	31.8	33.2	36.2	32.0	30.6	37.8	37.0	38.0
August	31.9	26.2	32.4	37.5	34.1	36.7	34.7	30.8	35.1	40.2	35.6	40.3
	<b>Precipitation (mm): in bracket = LTM:1961-1990</b>											
	<b>Osijek</b>			<b>Debrecen</b>			<b>Novi Sad</b>			<b>Bijeljina</b>		
July	48	(65)		49	(66)		48	(61)		36	(72)	
August	4	(58)		13	(61)		4	(55)		0	(66)	
April-Sept.	293	(368)		250	(346)		227	(339)		288	(436)	

Alleviation of unfavorable weather stress for maize growth is possible by application corresponding soil and crop management practice, for example, soil ploughing in autumn instead of spring and incorporation before ploughing phosphorus and particularly potassium mineral fertilizer according soil test, liming of acid soils and growing of drought more tolerant hybrids (Kovacevic and Rastija, 2014; Komljenovic et al., 2010, 2015; Kovacevic and Loncaric, 2014; Markovic et al., 2008).

### Conclusions

Weather conditions, particularly long drought period and high air temperature adversely affected on maize yields. With that regards, the 2012 and 2014 growing season are typical examples of recent climatic change characterizing by global warming and extremely oscillation of weather in short period. The first mentioned year was unfavorable and the second mentioned year very favorable for maize growth. By adequate soil and crop management is possible to alleviate stress provoked by weather and stabilizing yields of maize among years.

### Acknowledgements

The authors are thankful to Hydrometeorological Institute of the Republic of Srpska in Banja Luka and Federal Hydrometeorological Institute in Sarajevo for meteorological data used in this study.

### References

- AS (Agency for Statistics of Bosnia and Herzegovina): Harvested area, production, and yields of more important crops, First releases: Number 3 from 25. 01. 2012, Number 4 from 22. 01. 2013, Number 5 from 27. 01. 2014, Number 6. from 20. 01. 2015, Number 7. from 15. 01. 2016, Number 8 from 18 January 2017 ([www.bhas.ba](http://www.bhas.ba)).
- Basic F., Herceg N. (2010). Principles of Agronomy. Sinopsis d.o.o. Zagreb (in Croatian)
- Chi-Chung, C., Mc Carl B. A., Schimmelpfennig D. (2004): Yield variability as influenced by climate: A statistical investigation. *Climatic Change*, 66: 239-261.
- FAO (2007). Climate Change: ClimateChange Impacts, Adaptation and Vulnerability. IPCC WG II fourth Assessment Report. (<http://www.ipcc.ch/SPM6avr07.pdf>).

FAO: <http://faostat.fao.org>.

- Komljenović I., Marković M., Kondić D., Kovacević V. (2010). Response of maize to phosphorus fertilization on hydromorphic soil of Bosnian Posavina area. *Poljoprivreda* 16(2): 9-13.
- Jug, D., Komljenović, I., Jug Irena, Birkas Marta, Vukadinović Vesna, Marković, M., Djurdjević, B., Stipesević, B., Brozović, B., Knežević, S., Kotorac, F. (2014). Prilagodba sustava obrade tla u nepovoljnim vremenskim prilikama. *Agriculture in Nature and Environment Protection. Proceeding of 7th International Scientific/Professional Conference*, Vukovar: 168-173.
- Komljenović I., Marković M., Djurašinić G., Kovacević V. (2015). Response of maize to liming and phosphorus fertilization with emphasis on weather properties effects. *Columella - Journal of Agricultural and Environmental Sciences* 2 (1): 29-35.
- Kovacević V., Kovacević D., Pepo P., Marković M. (2013). Climate change in Croatia, Serbia, Hungary and Bosnia and Herzegovina: comparison the 2010 and 2012 maize growing seasons. *Poljoprivreda / Agriculture* 19 (2): 16-22.
- Kovacević V., Lončarić Z. (2014): Using of carbocalk for improvement of soil fertility. *Technologica Acta*, 7: 1-8.
- Kovačević V., Radić V., Iljkić D., Jović J., Majdančić M. (2016). Weather conditions in the 2013-2015 growing seasons for maize in Croatia and Bosnia and Herzegovina. *International Journal AgroFor*, 1 (1): 95-102.
- Kovacević V., Rastija M. (2014). *The Cereals* (university textbook). University J. J. Strossmayer in Osijek, Faculty of Agriculture (in Croatian).
- Majdanić M., Basic M., Salkić B., Kovacević V., Jović J. (2016). Weather conditions and yields of maize in Federation of Bosnia and Herzegovina with emphasis on Tuzla Canton. *Works of the Faculty of Agriculture and Food Sciences Univ. Sarajevo LXI* (66/1): 303-307.
- Marković M., Komljenović I., Todorović J., Biberdžić M., Delalić Z. (2008). Response of maize to liming in northern Bosnia. *Cereal Res. Commun.* 36 (Suppl.): 2079-2082.
- SYRS (2011-2015): *Statistical Yearbooks of Republic of Srpska*, Banja Luka.
- SYFB&H (2011-2015): *Statistical Yearbooks of Federation B&H*, Sarajevo.

## INHERITANCE OF productivity IN F<sub>1</sub> COTTON DIALLEL CROSSES (*Gossypium HIRSUTUM* L.)

Valentina DIMITROVA, Ana STOILOVA\*, Minka KOLEVA

Field Crops Institute – 6200 Chirpan, Bulgaria

\*Corresponding author: saldzhieva@abv.bg

### Abstract

The studies on genetic control of productivity are important for the breeding of new productive cotton varieties. Six varieties (*G. hirsutum* L.), differing in productivity were included in a half diallel cross, in 2010-2011, with the aim to investigate the inheritance of productivity. In 2012 another half diallel cross, including other six parents was made. The study was carried out in the experimental field of the Field Crops Institute in Chirpan. One set of F<sub>1</sub> hybrids and their parents were studied. The components of variability caused by the additive and dominant effects and their ratios, the variability due to the conditions of the environment were determined. Based on these, the indexes of inheritance of productivity were calculated. It was found that the productivity in the studied sets of crosses was controlled by a complex genetic system, in which the overdominance action of genes predominated especially in F<sub>1</sub>-2011 and F<sub>1</sub>-2012 without P<sub>5</sub>. Statistically significant were both additive and dominant effects. Dominant gene action was superior to additive one for both diallel crosses and reflects the importance of dominant variance in the inheritance of productivity. The parents had different dominance (recessiveness) in F<sub>1</sub> – 2010-2011 during the two years of the exploration probably due to their specific reaction to the year conditions. Because of high degree of dominance, weakly genetic variability and different expression of genes observed in F<sub>1</sub> – 2010-2011 quick and successful selection can not be expected.

**Keywords:** cotton, *G. hirsutum* L., diallel analysis, productivity

### Introduction

Diallel analysis has been frequently used method in the selection of different cultures, including cotton, to obtain valuable information about the genetic components and parameters of inheritance for a particular set of parents, and an assessment of their general and specific combining ability (Hayman, 1954, Griffing, 1956, Mather and Jinks, 1982).

A number of authors, using various schemes of complete and incomplete diallel crosses, have been established the breeding value of a large number of cotton varieties and the effects of gene action on the characteristics related to yield and fibre quality (Dukre *et al.*, 2009; Khan *et al.*, 2011; Batool, 2011). Singh *et al.* (2011) concluded that additive and non-additive gene effects played a parallel role in the inheriting of seed cotton yield. Others, Gamal *et al.* (2009), Ali *et al.* (2009), Makhdoom (2011) reported the superiority of non-additive gene action. The Abbass *et al.* (2008), Khan *et al.* (2011), Igbal *et al.* (2011), Sarwar *et al.* (2011) studies supported the greater importance of additive genes.

The aim of this study was to establish through diallel analysis the parameters of some genetic components and indexes of inheritance of productivity in F<sub>1</sub> cotton hybrids (*G. hirsutum* L.).

### Material and Methods

The hybrid populations of two diallel crosses were investigated. In 2010-2011 in one diallel cross 6 upland cotton varieties (4 Bulgarian and 2 foreign) were included: Beli Iskar - P<sub>1</sub>;

Barut 2005 (Turkish) - P<sub>2</sub>; Darmi - P<sub>3</sub>; Mytra (Greek) - P<sub>4</sub>; Helius - P<sub>5</sub> and Dorina - P<sub>6</sub>. In 2012, in another diallel cross, 6 other varieties, except Helius, were included: Chirpan-539 - P<sub>1</sub>; Helius - P<sub>2</sub>; Rumi - P<sub>3</sub>; Boyana - P<sub>4</sub>; Natalia - P<sub>5</sub> and Nelina - P<sub>6</sub> (Bulgarian selection). An incomplete diallel scheme was used, including the parents and one set of F<sub>1</sub> hybrids from direct crosses. The study was carried out in the experimental field of the Institute of Field Crops in Chirpan. The trials were set in three replicates, the parents and their F<sub>1</sub> hybrids were sown in 2 rows of 2.4 m in a 60×20×1 sowing scheme. Ten plants from each replication were accounted. Dispersion and diallel analyses, adequate of diallel scheme, were applied to the data processing (Mather and Jinks, 1982). The data suitability for diallel analysis was evaluated with the regression coefficient  $b$  and  $t$  (Wr-Vr) (Mather and Jinks, 1982).

The following components of genotypic variation along with their standard errors were calculated:  $D$  – additive genetic variance;  $H_1$  and  $H_2$  – dominance variances;  $F$  - shows the ratio of dominant to recessive genes in parents;  $E$  - variability due to the influence of environmental conditions. On the basis of the above components, the following indicators were calculated:  $(H_1/D)^{1/2}$  - average degree of dominance in each locus;  $H_2/4H_1$  - ratio of the positive and negative alleles in the loci showing dominance in the parents;  $K_D/K_R$   $[(4DH_1)^{1/2}+F/(4DH_1)^{1/2}-F]$  - shows the ratio of dominant to recessive genes in parents;  $k = (h^2/H_2)$  - number of effective factors;  $H^2$  and  $h^2$  – coefficients of heritability in a broad and in a narrow sense, calculated by Mather and Jinks (1982). The strong and significant variation of Wr-Vr of the parental arrays and deviation of regression coefficient  $b$  from 1 ( $b \neq 0$ ;  $b = 1$ ) were used to check the existence of epistasis. In the model  $b < 1$  indicates the presence of complementary epistasis.

### Results and Discussion

Diallel analyses of the productivity per plant were made for F<sub>1</sub> - 2010-2011 (1<sup>st</sup> diallel cross) and F<sub>1</sub> - 2012 (2<sup>nd</sup> diallel cross), with and without exclusion of parents from the diallel schemes. Due to the specific reaction to the conditions of years, the parents from F<sub>1</sub> - 2010-2011 changed their ranking by years and the change of grading was more significant for the varieties Mytra, Darmi and Dorina. Parents with high (P<sub>5</sub> - Helius) and low (P<sub>2</sub> – Barut 2005) values of the studied trait generally retained their positions. The differences between P<sub>5</sub> - Helius and P<sub>2</sub> – Barut 2005 were large - 32.5 g and 20.7 g/plant, respectively, average for the two years. The preliminary analysis of the variance (ANOVA) showed significant differences among the genotypes (data are not given here). In F<sub>1</sub>-2012, the differences between P<sub>5</sub> - Natalia and P<sub>4</sub> - Boyana, with highest and lowest productivity, respectively, were small - 20.8 g and 16.4 g per plant.

The regression coefficient -  $b$  for the F<sub>1</sub>-2012 was significantly less than unity, indicating the presence of complementary epistasis (Table 1). The variation of parental arrays under the Wr-Vr criterion for the F<sub>1</sub> - 2010-2011 and F<sub>1</sub>-2012 was statistically insignificant and do not indicate the presence of non-allelic interactions. In all analyses, however, the regression coefficients were low (with low values) and it is considered that the regression lines in diallel graphs do not adequately represent the Wr/Vr relationship because of existence of epistasis. Many authors reported incomplete or partial adequacy of characters contributed to the seed cotton yield and fiber quality (Abbass *et al.*, 2008; Ali *et al.*, 2008; 2009). According to Jinks (1954) and Jana (1972) the exclusion of one or more parents, bringing epistatic effects, from diallel scheme could improve the adequacy of the data with the additive-dominance model. After exclusion of one of the parents - P<sub>6</sub> (Dorina) from the F<sub>1</sub> -2010-2011 diallel scheme, the resulting set improved the results adequacy for diallel analysis. The F<sub>1</sub>-2012 diallel scheme from which P<sub>5</sub> (Natalia) was excluded provided the most constant values of the Wr-Vr which improve the data adequacy to the additive-dominance model.

Table 1. Additive-dominance model and epistasis tests for the productivity/plant in two diallel crosses - F<sub>1</sub>-2010-2011 and F<sub>1</sub>-2012

Diallel cross Year	Excluded parent	$b_{Wr/Vr}$	$0>b>0$	$1>b>1$	$t(W_r-V_r)$
F <sub>1</sub> - 2010	-	$0.690 \pm 0.211$	3.270 <sup>++</sup>	1.469	0.948
	P <sub>6</sub>	$0.851 \pm 0.167$	5.096 <sup>++</sup>	0.892	0.663
F <sub>1</sub> - 2011	-	$0.614 \pm 0.242$	2.537 <sup>+</sup>	1.595	0.929
	P <sub>6</sub>	$0.715 \pm 0.217$	3.295 <sup>++</sup>	1.313	0.920
F <sub>1</sub> - 2012	-	$0.568 \pm 0.211$	2.692 <sup>++</sup>	2.047 <sup>+</sup>	1.368
	P <sub>5</sub>	$0.719 \pm 0.304$	2.365 <sup>+</sup>	0.924	0.389

The diallel results were significantly improved with the exclusion of P<sub>6</sub> in F<sub>1</sub>-2010-2011 and P<sub>5</sub> in F<sub>1</sub>-2012, but the regression test, as a more accurate, showed incomplete adequacy of results in F<sub>1</sub>- 2011 without P<sub>6</sub> and in F<sub>1</sub>-2012 without P<sub>5</sub> because of low values of regression coefficients, suggesting that other parents were also carriers of non-allelic interactions. Both parents (P<sub>6</sub> and P<sub>5</sub>) were removed after successively exclusion of each parent.

Both additive and dominance gene effects were statistically significant (Table 2). The parameter *D* had relatively lower values revealing that the additive gene action had less importance for the variation of studied trait. Dominance gene action was superior to additive, both *H*<sub>1</sub> and *H*<sub>2</sub> dominance components, except *H*<sub>2</sub> in F<sub>1</sub>-2010 without P<sub>6</sub>, were greater than additive component (*D*) during all years of research, indicating greater importance of dominance variance in the inheritance of productivity. The parameter *H*<sub>1</sub> shows a high degree of dominance. The indicator *H*<sub>1</sub>/*D* expresses overdominance in both crosses, and *H*<sub>1</sub>/*D*<sup>1/2</sup> - overdominance in each individual locus showing non-additive type of gene action and that the dominant genes were in increasing position, confirmed by positive values of *h*<sup>2</sup> which were significant in F<sub>1</sub>- 2010-2011 and insignificant in F<sub>1</sub>- 2012. From *M*<sub>LI</sub>-*M*<sub>LO</sub> it is visible that on average for the entire diallel crosses, the overdominance was in direction of increasing productivity. The second dominant parameter *H*<sub>2</sub> had also high values close to those of *H*<sub>1</sub> in F<sub>1</sub>-2012. The *H*<sub>2</sub>/*4H*<sub>1</sub> ratio showed unequal distribution of positive and negative alleles in the loci exhibited dominance in the parents, which was well expressed in F<sub>1</sub>-2010 and F<sub>1</sub>-2011 with a full set of parents, and less in F<sub>1</sub>-2011 with the excluded parent P<sub>6</sub> (Dorina), as well in F<sub>1</sub>-2012. The parameter *F* had a positive sign in all years, but its values were significant only for F<sub>1</sub>-2010, which means that the dominance alleles exceeded recessive ones, while for F<sub>1</sub>-2011 and F<sub>1</sub>-2012 these values were insignificant and it should be assumed that dominance and recessive alleles had relatively equal frequencies. The *K*<sub>D</sub>/*K*<sub>R</sub> ratio reflects superiority of dominance alleles over the recessive alleles, less pronounced for F<sub>1</sub>-2011. The coefficient of heritability in a narrow sense (*h*<sup>2</sup>) was very low to moderate due to the large influence of dominance gene action in the inheritance of this trait. This means that an effective improving the productivity could only be achieved in later hybrid generations - F<sub>3</sub>-F<sub>4</sub> when dominance gene effects have declined. Significant negative correlation coefficients between (*Wr*+*Vr*) values and parental mean meanings reveal that the parents containing dominant genes were responsible for increased productivity per plant. The *k* values (number of effective factors) indicate at least 2 to 3 genes or groups of genes controlling productivity.

The varieties Darmi (P<sub>3</sub>), Helius (P<sub>5</sub>), Beli Iskar (P<sub>1</sub>) and Dorina (P<sub>6</sub>) (F<sub>1</sub> - 2010-2011), Rumi (P<sub>3</sub>) and Chirpan-539 (P<sub>1</sub>) (F<sub>1</sub>-2012), showed high productivity, had low *Wr*+*Vr* values. This means that their high productivity was determined by dominant genes with unidirectional enhancing productivity effect (Table 3).



**Table 2.** Genetic components of productivity/plant in two diallel combinations - F<sub>1</sub> - 2010-2011 and F<sub>1</sub> - 2012

Genetic components	F <sub>1</sub> - 2010		F <sub>1</sub> - 2011		F <sub>1</sub> - 2012	
	Full set of parents b=0.690	Without P <sub>6</sub> b=0.851	Full set of parents b=0.614	Without P <sub>6</sub> b=0.715	Full set of parents b=0.568	Without P <sub>5</sub> b=0.719
Parameters						
D	81.161±12.807	99.989±8.058	3.806 ± 1.125	4.488±1.328	1.776±0.332	1.000±0,303
F	80.780±31.286	69.983±20.129	1.720±2.748	2.276±3.318	1.409±0.811	1.276±0.756
H <sub>1</sub>	152.258±32.511	123.936±21.762	30.058±2.855	34.457±3.588	4.558±0.843	7.065±0.817
H <sub>2</sub>	116.752± 29.042	100.128±19.734	24.774±2.550	30.898±3.254	4.089±0.753	6.371±0.741
h <sup>2</sup>	238.734±19.548	191.563±13.326	27.229±1.717	30.091±2.197	4.738±0.507	5.482±0.501
E	0.460±4.840	0.434±3.290	0.496±0.425	0.457±0.542	0.479±0.125	0.395±0.124
Indicators						
H <sub>1</sub> /D	1.876	1.239	7.898	7.678	2.566	7.065
H <sub>1</sub> /D <sup>1/2</sup>	1.370	1.113	2.810	2.771	1.602	2.658
M <sub>L1</sub> - M <sub>L0</sub>	59.747	47.960	6.876	8.096	1.251	1.434
H <sub>2</sub> /4H <sub>1</sub>	0.192	0.202	0.206	0.224	0.224	0.225
K <sub>D</sub> /K <sub>R</sub>	2.141	1.917	1.175	1.201	1.658	1.632
r xp (W <sub>r</sub> +V <sub>r</sub> )	-0.978	-0.993	-0.703	-0.745	-0.926	-0.944
k	2.045	1.913	1.099	0.974	1.159	0.860
Heritability %						
H <sup>2</sup>	0.990	0.992	0.952	0.959	0.750	0.820
h <sup>2</sup>	0.377	0.514	0.355	0.261	0.218	0.095

**Table 3.** Average values of parents and their ranking on degree of dominance/recessivity for productivity/plant in F<sub>1</sub> - 2010-2011 and F<sub>1</sub> - 2012

Parents	F <sub>1</sub> - 2010					F <sub>1</sub> - 2011					F <sub>1</sub> - 2012					
	Full set of parents			Without P <sub>6</sub>		Full set of parents			Without P <sub>6</sub>		Full set of parents			Without P <sub>5</sub>		
	x	W <sub>r</sub> + V <sub>r</sub>	R	W <sub>r</sub> + V <sub>r</sub>	R	x	W <sub>r</sub> + V <sub>r</sub>	R	W <sub>r</sub> + V <sub>r</sub>	R	Parents	x	W <sub>r</sub> + V <sub>r</sub>	R	W <sub>r</sub> + V <sub>r</sub>	R
P <sub>1</sub>	43.9	41.3	5	51.5	4	18.7	4.1	1	0.8	1	P <sub>1</sub>	18.1	1.8	3	1.4	2
P <sub>2</sub>	23.0	218.8	6	221.8	5	18.5	4.9	2	6.1	2	P <sub>2</sub>	19.1	1.9	4	1.6	3
P <sub>3</sub>	44.6	19.5	3	22.5	1	17.2	7.1	3	9.0	3	P <sub>3</sub>	19.4	0.7	2	0.4	1
P <sub>4</sub>	46.5	27.1	2	33.2	3	13.6	19.1	6	24.0	5	P <sub>4</sub>	16.4	4.5	6	4.8	5
P <sub>5</sub>	46.1	34.7	4	27.6	2	18.9	13.0	5	16.2	4	P <sub>5</sub>	20.8	0.3	1	-	-
P <sub>6</sub>	43.6	11.9	1	-		18.8	11.0	4	-	-	P <sub>6</sub>	17.9	3.6	5	2.7	4

The varieties Darmi(P<sub>3</sub>), Dorina (P<sub>6</sub>), Beli Iskar (P<sub>1</sub>) (F<sub>1</sub> - 2010-2011), Rumi (P<sub>3</sub>) and Natalia (P<sub>5</sub>) (F<sub>1</sub>-2012) were the parents containing most dominant genes and were best suited for including in crosses, while the varieties Barut (P<sub>2</sub>), Mytra (P<sub>4</sub>) (F<sub>1</sub> - 2010-2011), Boyana (P<sub>4</sub>) and Nelina (P<sub>6</sub>) (F<sub>1</sub>-2012) had most recessive genes. Helius variety had a non-permanent dominance, high in 2010 and 2012, and low in 2011. Foreign varieties Mytra and Barut also had a non-permanent dominance/recessivity. These varieties were unable to realize their productive potential under our conditions due to a delay in ripening and have given unstable yields. In some cases degree of dominance varied with the change in diallel scheme after the exclusion of one of the parents.

Summarized results show that the productivity/plant in both diallel crosses was determined by a complex genetic system, in which the overdominance action of genes predominated. The overdominance reveals the presence of nonallelic interactions, which were more strongly pronounced in F<sub>1</sub>-2011 with and without P<sub>6</sub> and in F<sub>1</sub>-2012 without P<sub>5</sub>. Due to overdominance some parameters (H<sub>1</sub> and H<sub>2</sub>) and indicators (K<sub>D</sub>/K<sub>R</sub>), as well as heritability values (h<sup>2</sup>), in F<sub>1</sub>-2011 without P<sub>6</sub> and in F<sub>1</sub>-2012 without P<sub>5</sub>, were more strongly influenced by dominant effects. In both crosses the inheritance was incompletely dominant to overdominant, some crosses showed significant specific combining ability (data not given). The model worked correctly in F<sub>1</sub>-2010 without P<sub>6</sub> (with the highest value of regression coefficient and very weak overdominance) and showed that the genetic control of productivity per plant was largely non-additive and this was observed in all diallel analyses. Overdominance type of inheritance of productivity was reported by Ahmad *et al.* (2005), Iqbal *et al.* (2005) and Khan *et al.* (2009). In the relatively complexity of this feature, low additive variation, and influence of the year conditions on genetic control, a rapid and successful selection could not be expected. In all cases, non-additive gene effects predominated and the selection for productivity has to be conducted in later hybrid generations. The results obtained from this study were in accordance with those by Gamal *et al.* (2009), Ali *et al.* (2009), Khan *et al.* (2009; 2011) and Makhdoom (2011), who also reported that the seed cotton yield/plant was more strongly influenced by the non-additive gene effects.

### Conclusion

Genetic control of productivity in both studied diallel crosses was largely non-additive. The overdominance action of genes predominated with manifestation of complementary epistasis. Greater participation of non-additive genetic variation and relatively low coefficients of heritability suggested that a rapid and successful selection could not be expected, effective selection for improving the productivity could be achieved in later hybrid generations - F<sub>3</sub>-F<sub>4</sub>.

### References

- Abbass, A., Ali M.A., Khan T.M. (2008). Studies on gene effects of seed cotton yield and its attributes in five American cotton cultivars. *J. Agric. Soc. Sci.*, 4: 147-152.
- Ahmad R.D., Malik A.J., Hassan G., Subhan M. (2005). Estimation of combining ability for seed cotton yield and its components in inter-varietal crosses of cotton (*Gossypium hirsutum* L.). *Gomal University Journal of Research*, 21: 1-6.
- Ali M.A., Khan I.A., Awan S.I., Ali S., Niaz S. (2008). Genetics of fibre quality traits in cotton (*Gossypium hirsutum* L.). *Australian J. Crop Sci.*, 2: 10-17.
- Ali M.A., Abbas A., Younas M., Khan T.M., Hassan H.M. (2009). Genetic basis of some quantitative traits in upland cotton (*G. hirsutum* L.). *Plant Omics J.*, 2 (2): 91-97.
- Batool S. (2011). Diallel studies and heritability estimates using Hayman's approach in upland cotton. M. Sc. Thesis, Khyber Pakhtunkhwa Agril. Univ. Peshawar, Pakistan.
- Dukre V.B., Burghate, S.K., Patil, S.P. (2009). Diallel analysis for heterosis studies in upland cotton. *Journal of Cotton Research and Development*, Hisar, 23 (2): 217-221.
- Gamal I.A.M., Abd-El-Halem S.H.M. and Ibrahim E.M.A. (2009). A genetic analysis of yield and its components of Egyptian cotton (*Gossypium hirsutum* L.) Under Divergent Environments. *American-Eurasian J. Agric. and Environ. Sci.*, 5 (1): 5-13.
- Griffing B. (1956). Concept of general and specific combining ability in relation to diallel crossing systems. *Austral J. Biol. Sci.*, 9: 463-493.
- Hayman B.I. (1954). The analysis of variance of diallel crosses. *Biometrics*, 10: 235-244.

- Iqbal M., Khan R.S.A., Hayat K. and Khan N.I. (2005). Genetic variation and combining ability for yield and fiber traits among cotton F1 hybrid population. *J. Biol. Sci.*, 5 (6): 713-716.
- Iqbal M., Khan M.A., Jameel M., Yar M.M., Javed Q., Aslam M.T., Iqbal B., Shakir S. and Ali A. (2011). Study of heritable variation and genetics of yield and yield components in upland cotton. *African Journal of Agricultural Research*, 6 (17), 4099-4103.
- Jana M.K. (1972). Genetic analysis of some quantitative traits in jute. PhD Thesis, Kalyani University, Kalyani.
- Jinks J.L. (1954). The analysis of continuous variation in a diallel cross of *Nicotiana rustica* varieties. *Genetics*, 39: 767-788.
- Khan N.U., Hassan G., Kumbhar M.B., Marwat K.B., Khan M.A., Parveen A., Aiman U. and Saeed M. (2009). Combining ability analysis to identify suitable parents for heterosis in seed cotton yield, its components and lint % in upland cotton. *Ind. Crops & Prod.*, 29: 108-115.
- Khan S. A., N.U. Khan, F. Mohammad, M. Ahmad, I.A. Khan, Z. Bibi, I.U. Khan (2011). Combining ability analysis in intraspecific F1 diallel cross of upland cotton. *Pak. J. Bot.*, 43 (3): 1719-1723.
- Makhdoom K. (2011). Combining ability estimates through line×tester analysis and heritability in upland cotton. M.Sc (Hons.) Thesis, Khyber Pakhtunkhwa Agril. Univ. Peshawar, Pakistan.
- Mather K., Jinks J.L (1982). *Biometrical Genetics*, 3rd ed. London Chapman and Hall, pp. 396.
- Sarwar G., Baber M., Hussain N., Khan I.A., Naeem M., Ullah M.A. and Khan A.A. (2011). Genetic dissection of yield and its components in upland cotton (*Gossypium hirsutum* L.). *African Journal of Agricultural Research*, 6 (11): 2527-2531.
- Singh P., Mittal V.P., Brar K.S. (2011). Analysis of first degree statistics to estimate gene effects in cotton (*Gossypium hirsutum* L.). *Journal of Cotton Research and Development*, 25 (2): 165-167.

## STUDY ON RESISTANCE TO ABIOTIC AND BIOTIC STRESS FACTORS IN INTRODUCED SWEET CHERRY CULTIVARS FROM KYUSTENDIL REGION OF BULGARIA

Simeon KRUMOV<sup>1</sup>, Aneliya BORISOVA<sup>1\*</sup>, Nicolay CHRISTOV<sup>1</sup>, Zhao LINGLING<sup>2</sup>, Tang MEILING<sup>2</sup>

<sup>1</sup>Institute of Agriculture, 2500 Kyustendil, Bulgaria

<sup>2</sup>Yantai Academy of Agricultural Science, Shandong province, P.R. China

\*Corresponding author: aneliya@gmail.com

### Abstract

Response of 16 new introduced sweet cherry cultivars and one hybrid from Poland and China to winter hardiness and late spring frost was evaluated, and their phytosanitary status was determined. The research was conducted in the experimental sweet cherry orchard planted in the spring of 2012 at the Institute of Agriculture – Kyustendil. The study on the resistance of cultivars to low winter temperatures was conducted under natural conditions in 2016 and 2017, and in 2016 for the late spring frosts. Young leaf or petal samples were taken from 84 trees and were analysed by ELISA for the presence of PNRSV (*Prunus necrotic ring spot virus*), PDV (*Prune dwarf virus*), CLRV (*Cherry leaf roll virus*) and RpRSV (*Raspberry ring spot virus*), PPV (*Plum pox virus*) and ACLSV (*Apple chlorotic leaf spot virus*) infection. In 2016 (-19.9°C), all investigated cultivars had a higher resistance to winter cold than the standard Van. In 2017 (-29.5°C) with the highest cold resistance was cultivar Kozerska, in which the damage of flower buds was 79.2%. It was found that 13 of studied cultivars had higher cold hardness than Van. Young fruit sets were damaged completely without cultivar difference after the late spring frost on 27<sup>th</sup> April, 2016 (- 4,0°C). The most significant damages with deep longitudinal cracks on the stem of the trees were found in cultivars Kristin, Van, Van Compact, Rucsandra, Techlovan, Tieton, Huldra and Bigalise pozna. The total infection rate in the investigated orchard was 52.4%. Among the viruses, PDV infection was the most frequent (29.8%), followed by mixed infection - PNRSV + PDV (11.9%), PNRSV (5.9%) and ACLSV (4.8%). The different cultivars were infected to a different degree. PPV, CLRV and RpRSV were not present in the sweet cherry orchard.

**Keywords:** *Sweet cherry, Winter hardiness, Late spring frost, Resistance, Viruses.*

### Introduction

The Kyustendil region is one of the main producers of sweet cherry fruits in Bulgaria. The climate in the region is moderate continental, characterized by cold winters and conditions for late spring frosts. One of the high-priority breeding goals in the selection of sweet cherries are cold hardiness and late bloom; the late bloom is to prevent from damage caused by spring frost in the northern districts and low chill requirement in the southern districts (Sansavini and Lugli, 2008). Significant attention is paid to this problem abroad (Lang et al., 1997; Blažková, 2004; Szewczuk et al., 2007; Kask et al., 2009), as well as in Bulgaria (Georgiev et al., 2001; Lichev and Papachatzis, 2009; Christov et al., 2015).

To date, seven virus species have been identified in sweet cherry trees in Bulgaria. They include *Prunus necrotic ring spot virus* (PNRSV), *Prune dwarf virus* (PDV), *Apple chlorotic leaf spot virus* (ACLSV) (Milusheva and Borisova, 2005; Borisova et al, 2013), *Cherry leaf roll virus* (CLRV), *Arabis mosaic virus* (ArMV), *Raspberry ring spot virus* (RpRSV), *Apple*

*mosaic virus* (ApMV) (Milusheva and Zhivondov, 2009; Milusheva et al., 2014). Among them, the *Illarvirus* species PDV and PNRSV have been reported as the most common and economically important in sweet cherry orchards in the Kyustendil region (Borisova and Christov, 2012; Borisova et al., 2013), while the most distributed virus in Plovdiv region of Bulgaria is proved to be CLRV (Milusheva et al., 2014). It is very important to know the phytosanitary status of the investigated new sweet cherry cultivars and elites, because virus contaminations can reflect on the evaluation of their biological and economic properties.

The aim of this study was to evaluate 16 newly introduced sweet cherry cultivars and one elite to winter hardiness, spring frost, along with their phytosanitary status and potential to grow in the Kyustendil region.

### Material and Methods

The research was conducted in the experimental sweet cherry orchard at the Institute of Agriculture – Kyustendil, planted in the spring of 2012 with newly introduced cultivars from Poland and China. The objects of the study were the cultivars Rucsandra, Kristin, Victor, Bigalise pozna, Bigalise, Black pearl, Sweetheart, Techlovan, Charna z turwil, Vasiliča, Tieton, Santina, Sparkle, Huldra, Star z Chech, Van compact and hybrid 8-102. As controls were used the cultivars Van and Kozerska. The trees were grafted on *P. mahaleb* rootstocks, with planting distances of 6 x 5 m.

The study on the resistance of the investigated cultivars to low winter temperatures and late spring frosts was conducted under natural conditions in 2016 and 2017. The air temperatures were measured in standard meteorological cell (2 m in height). The percentage of damage was calculated based on generally accepted methodology by longitudinal cross-section of buds and their observations under a binocular. After the late spring frost from 27 April 2016, observation of damage of young fruits and multiannual wood was made. The results concerning damages after winter frosts were processed by the method of analysis of variance using the LSD-test to prove statistical significance of the differences found between the control and the variants. The evaluation was made at levels of significance  $P < 0,05$ ,  $P < 0,01$  and  $P < 0,001$  (Maneva, 2007).

Leaf samples in phenophase "slicing the leaf bud" were tested for PNRSV (*Prunus necrotic ringspot virus*), PDV (*Prune dwarf virus*), CLRV (*Cherry leaf roll virus*) and RpRSV (*Raspberry ring spot virus*) infection, while completely formed petals or young leaves were tested for PPV (*Plum pox virus*) infection and ACLSV (*Apple chlorotic leaf spot virus*). The double antibody sandwich-ELISA (DAS-ELISA) (Clark and Adams, 1977) was applied to test PPV, PNRSV, PDV, CLRV, RpRSV; whereas DAS-simultaneous ELISA (Flegg and Clark, 1979) was performed to detect ACLSV, using commercial kits (Loewe Company, Germany).

### Results and Discussion

On 24<sup>th</sup> January 2016, the absolute minimum air temperature had fallen to -19.9°C. The duration of the impact of the temperatures under -18.0°C was 2.5 hours. The absolute maximum temperatures in these days were with low negative values. In the concrete conditions, all investigated cultivars had a higher resistance to cold than the standard cultivar Van, with 66.7% of damaged flower buds (Table 1). The cultivars Santina and Bigalise pozna had the highest cold resistance, with respectively 3.2% and 4.3 % of damaged flower buds. Very good resistance to this stress factor had also the cultivars Kozerska (7.2%), Krustin (8.3%), Huldra (9.5%), Sparkle (9.8%) and hybrid 8-102 (15.9%). In previous studies carried out at the institute, it was found that cultivar Kozerska had very good winter hardiness, after -27.5 °C it was reported 65.9% of damaged flower buds, while for Van they were around

92.0% (Georgiev et al., 1990). The highest percentage of damage to the generative organs was found in cultivar Van (66.7 %), followed by cultivars Black pearl (61.3%), Star z check (56.9%), Van compact (52.7%) and Rusandra (41.6%). This temperature value is relative border at which the damages are low and it is possible to get a normal yield. After the statistical analysis the differences between control and investigated cultivars are positively proven, except for the cultivars Black pearl, Star z check and Van compact in which the differences are insignificant to the control (Table 1). On 8<sup>th</sup> January 2017, the absolute minimum air temperature reached -29.5 °C. The duration of the impact of the temperatures under -18.0°C was 13 hours. In these critical temperatures, the highest cold resistance had the cultivar Kozerska, in which the damage of flower buds was 79.2%. For the other cultivars, the damages were from 87.8% to 99.7%. This shows that for most of the studied cultivars this temperature is fatal to their generative organs. 13 of the investigated cultivars had proven higher cold resistance than the control cultivar (Table 1).

Table 1 Damages after low winter temperatures in January 2016 and 2017 and late spring frosts in April 2016 in the introduced sweet cherry cultivars

Cultivars	Winter frost damages to flower buds		Spring frost damages to:	
	2016 (-19.9°C)	2017 (-29.5°C)	young fruits	stem of trees
	%	%	%	symptom*
Charna z turwil	20.9 ***	99.7 n.s.	100	+
Techlovan	22.4 ***	98.0 n.s.	98.4	++
Rusandra	41.6 **	97.7 n.s.	100	++
Krustin	8.3 ***	96.8 *	100	++
Victor	21.8 ***	94.9 ***	100	++
Bigalise pozna	4.3 ***	96.5 **	100	++
Tieton	18.0 ***	95.0 ***	97.2	++
Hybrid 8-102	15.9 ***	96.9 *	97.7	0
Santina	3.2 ***	92.6 ***	100	+
Huldra	9.5 ***	95.5 ***	98,5	++
Sparkle	9.8 ***	96.8 *	96.5	0
Van compact	52.7 n.s.	95.9 **	100	++
Sweetheart	20.4 ***	95.1 ***	98,3	+
Vasilica	24.1 ***	99.5 n.s.	100	+
Bigalise	20.4 ***	98.0 n.s.	98.5	0
Black pearl	61.3 n.s.	96.7 *	100	+
Star z check	56.9 n.s.	88.8 ***	100	0
Kozerska	7,2 ***	79.2 ***	96.3	0
<b>Van (standard)</b>	<b>66.7</b>	<b>99.5</b>	<b>100</b>	<b>++</b>
<i>F</i>	12,2943	39,47581		
<i>SD</i>	8,120479	1,074204		
<i>LSD (0,05)</i>	16,48	2,18		

\* (0) - stems without symptoms; (+) – slight swellings with cracks on the bark of the stems; (++) - longitudinal cracks on the stems

On 27<sup>th</sup> April 2016, it was registered late spring frost with an absolute minimum temperature of -4.0°C, with long duration of impact (5.0 h). In this period, all the tested cultivars had fruits with the size of a pea. All the fruits were 100% damaged at this critical temperature. No differences between the cultivars were found. According to Georgiev (2001), the most sensitive to frosts are pistils and young fruit sets. In some cultivars, it was found damages to

the stems of the trees in the form of slight swellings with cracks on the bark and longitudinal cracks. The most significant damages with deep longitudinal cracks to the stem of the trees was found in the cultivars Kristin, Van, Van Compact, Rucsandra, Techlovan, Tieton, Huldra and Bigalise pozna (Table 1). With low swellings and slight surface cracks on the bark were the cultivars Charna z turwil, Victor, Santina, Sweetheart and Vasilica. In the rest investigated cultivars, there were not established damages to the stem of trees caused by the late spring frost. In order to understand the sanitary status of the cherry trees grown in the investigated new experimental sweet cherry orchard, a total of 84 sweet cherry trees were tested for the presence of six RNA plant viruses by ELISA. The total infection rate in the investigated orchard came up to 52.4%. Among the viruses, PDV infection was the most frequent (29.8%), followed by mixed infection - PNRSV + PDV( 11.9%), PNRSV (5.9%) and ACLSV (4.8%) . PPV, CLRV and RpRSV were not present in the sweet cherry orchard (Table 2). Similar results were reported about sweet cherry plantations of Central-Western Spain (Sanchez et al., 2015). The ELISA results revealed that 72% of the sweet cherry trees were infected by at least one of the viruses, PDV was in the highest infection rate.

Table 2. Viruses detected by ELISA in experimental sweet cherry orchard planted in the spring of 2012 with newly introduced cultivars at Institute of Agriculture – Kyustendil, Bulgaria

Cultivars	Tested samples	Infected samples No. (%)	PNRSV	PDV	PPV	CLRV	RpRSV	ACLSV	PNRSV + PDV
Rucsandra	8	0	0	0	0	0	0	0	0
Kristin	5	5	0	5	0	0	0	0	0
Victor	5	1	0	1	0	0	0	0	0
Bigalise pozna	7	3	0	2	0	0	0	0	1
Van compact	11	11	0	11	0	0	0	0	0
Black pearl	1	1	1	0	0	0	0	0	0
Sweetheart	3	3	3	0	0	0	0	0	0
Techlovan	5	0	0	0	0	0	0	0	0
Charna z turwil	4	0	0	0	0	0	0	0	0
Vasilica	2	2	0	1	0	0	0	0	1
Tieton	6	6	0	3	0	0	0	0	3
Kozerska	6	4	0	0	0	0	0	4	0
Santina	3	3	1	1	0	0	0	0	1
Van	6	1	0	1	0	0	0	0	0
Sparkle	3	3	0	0	0	0	0	0	3
Huldra	1	0	0	0	0	0	0	0	0
Star z Chech	1	1	0	0	0	0	0	0	1
Bigalise	2	0	0	0	0	0	0	0	0
8-102	5	0	0	0	0	0	0	0	0
<b>TOTAL</b>	<b>84</b>	<b>44</b> 52.4%	<b>5</b> 5.9%	<b>25</b> 29.8%	<b>0</b>	<b>0</b>	<b>0</b>	<b>4</b> 4.8 %	<b>10</b> 11.9%

The data from the tests has shown that different cultivars were infected to a different degree. A single infection of PNRSV was found in tree trees of cultivar Sweetheart, one tree Black pearl and one Santina. PDV was detected in 100% of the trees of the cultivars Kristin and Van compact, in 50% of the trees of the cultivar Tieton, two trees of the cultivar Bigalise pozna

and in one tree of the cultivars Victor, Vasilica, Santina and Van. In 100% of investigated trees of the cultivar Sparkle, 50% of Tieton and one tree of the cultivars Bigalise pozna, Vasilica, Santina and Huldra was found mixed infection of PNRSV + PDV. There was also found a single infection of ACLSV in 4 trees of the cultivar Kozerska.

In field observations, in our study were not identified symptoms of the virus infection on leaves of the studied cultivars, although ELISA tests confirmed the presence of viral infection in some of them. These results are in confirmation of the results of other authors, according to which after natural infection PNRSV, PDV and ACLSV are symptomless in most cultivars in some years (Smith et al., 1988; Hadidi et al., 2011).

The aim of this experimental sweet cherry orchard was to introduce new cultivars to the region of Kyustendil and to evaluate their adaptation to the regional conditions by fruit quality and quantity. It would be hard to have reliable data from the trees carrying virus infections which can affect these aspects. This material is inappropriate for propagation purpose.

### **Conclusions**

All investigated cultivars had a higher resistance to winter cold than the standard cultivar Van, at air temperature  $-19.9^{\circ}\text{C}$ . When temperatures fell to  $-29.5^{\circ}\text{C}$ , the damage was severe. At this temperature, the highest degree of cold resistance had the cultivar Kozerska, with 79.2% damaged flower buds.

The young fruit set was damaged completely without cultivar difference after late spring frost on April 27<sup>th</sup> 2016 ( $-4.0^{\circ}\text{C}$ ). The most significant damages with deep longitudinal cracks to the stem of trees were found in the cultivars Kristin, Van, Van Compact, Rucsandra, Techlovan, Tieton, Huldra and Bigalise pozna.

The total infection rate in the investigated orchard was 52.4%. Among the viruses, PDV infection was the most frequent (29.8%), followed by mixed infection - PNRSV + PDV (11.9%), PNRSV (5.9%) and ACLSV (4.8%). PPV, CLRV and RpRSV were not present in the sweet cherry orchard.

### **Acknowledgement**

This article is published with the financial support of the Ministry of Education and Science /Fund "Scientific Research"/ - Contract DNTS/China 01/8/ 6.11.2014.

### **References**

- Blažková, J. (2004). Resistance to abiotic and biotic stressors in sweet cherry rootstocks and cultivars from the Czech Republic. *Journal of Fruit and Ornamental Plant Research*, vol. 12, 2004, 303-311.
- Borisova A., Kamenova I., Borovinova M. (2013). Viral and fungal diseases of stone fruit species in Kyustendil region. *Journal of Mountain Agriculture on the Balkans*, vol. 16, 1, 164-182.
- Borisova A., Christov N. (2012). Influence of PNRSV and PDV on some vegetative and reproductive properties of cherry cultivars. *Proceedings and abstracts of Third congress of virology with Internationals participation*, 114-120.
- Christov N., S. Krumov, M. Popovska (2015). Sensitivity of cherry cultivars and elites to low winter temperatures. *Book of proceedings, scientific conferece "Challenges in modern agricultural production"*. Skopje, 113-116.
- Clark, M.F., A.N. Adams, (1977). Characteristics of the microplate method of enzyme-linked immunosorbent assay for the detection of plant viruses. *Journal of General Virology* 34: 475-483.



- Flegg, C. L., M. F. Clark, (1979). The detection of apple chlorotic leaf spot virus by a modified procedure of enzyme-linked immunosorbent assay (ELISA). *Ann. Appl. Biol.*, 91: 61-65.
- Georgiev, V., K. Doichev, et. al., (1990). Effect of 1985 January and February colds on some fruit-tree species at the Kyustendil valley. *Kyustendil*, 67 p.
- Georgiev, V., M. Borovinova, A. Koleva, (2001). Sweet cherry. *Zemizdat, Sofia*, 352 p.
- Hadidi A., M. Barba, T. Candresse, W. Jelkmann, (2011). Virus and virus-like diseases of pome and stone fruits. *APS Press, St. Paul, MN, USA*.
- Kask, K., H. Jänes, P. Ardel, (2009). Sources of winter hardiness in sweet cherry breeding in Estonia. *Acta Hort.*, 814, 805-808.
- Lang, G., W. Howell, D. Ophardt, G. Mink, (1997). Biotic and abiotic stress responses of interspecific hybrid cherry rootstocks. *Acta Hort.* 451, 217-224.
- Lichev, V., A. Papachatzis, (2009). Cold hardiness of the rootstocks for the sweet cherry and its transfer onto the scion. *Agricultural Sciences, Yr. 1, 2*, 31-36
- Maneva S. (2007) *Mathematical methods in plant protection*. PhD Thesis, Sofia, 201 p.
- Milusheva, S., A. Borisova, (2005). The incidence of Prunus necrotic ring spot (PNRS) and Prune dwarf (PDV) viruses in Prunus species in South Bulgaria. *Biotechnol.&Biotechnol. Equipmnet* 19, 2, 42- 45.
- Milusheva, S., A. Zhivondov, (2009). Spread of some sap transmissible viruses in cherry. *Plant Science*, 46 (1): 63-66.
- Milusheva, S., S. Malchev, A. Zhivondov, (2014). Virus status of new bred cherry cultivars and elites. *Bulg. J. Agric. Sci.*, 20: 1137-1141.
- Sánchez R. P., R. M. Corts, P. G. Benavides, M. A. Sánchez, (2015). Main viruses in sweet cherry plantations of Central-Western Spain. *Sci. agric. (Piracicaba, Braz.)* vol.72 no.1
- Sansavini, S., S. Lugli, (2008). Sweet cherry breeding programs in Europe and Asia. *Acta Hort.* 795, 41-58.
- Smith, I. M., J. Dunez, D.H. Phillips, R.A. Lelliott, S.A. Archer, (1988). *European handbook of plant diseases*. Blackwell Scientific, Oxford, UK.
- Szewczuk, A. , E. Gudarowska, D. Dereń, (2007). The estimation of frost damage of some peach and sweet cherry cultivars after winter 2005/2006. *Journal of Fruit and Ornamental Plant Research*, vol. 15, 55-63.

## EVALUATION OF SPRING FROST TOLERANCE AND VIRUS STATUS OF SOME APPLE CULTIVARS AND HYBRIDS IN BULGARIA

Stanislava DIMITROVA, Aneliya BORISOVA\*

Institute of Agriculture - Kyustendil, 2500 Kyustendil, Bulgaria

\*Corresponding author:anelija@gmail.com

### Abstract

The aim of the present study was to evaluate 15 new introduced apple cultivars and 5 hybrids to spring frost tolerance and the occurrence of main pome fruit viruses. The research was conducted in two experimental apple orchards planted in the spring of 2002 and 2007 at the Institute of Agriculture – Kyustendil, Bulgaria. The study on the tolerance to late spring frosts was conducted under natural conditions in 2016. On 27<sup>th</sup> April, it was registered an absolute minimum temperature of -4.0°C, with long duration of the impact (5.0 h). The best resistance to late spring frost showed young fruit sets of hybrid 1/5 and cultivars Fuji Nagafu 6, Oregon Spur, Teser T219, Super Chief, Scarlet Spur. There were no symptoms caused by spring frost on their fruits. The cultivars Ginger Gold, Arkcharm and the standard Prima were the most susceptible, in which the damages were about 90.0%. All samples were tested by DAS - ELISA for the presence of Apple mosaic virus (ApMV) and by Cocktail – ELISA for Apple chlorotic leaf spot virus (ACLSV) and Apple stem grooving virus (ASGV). Of the total 104 tested trees, 67.3% were infected with ACLSV and 3.8% with ASGV. A mixed infection by both ACLSV and ASGV was identified in 3.8% of tested trees. ApMV was not detected in investigated cultivars and hybrids.

**Keywords:** *Apple, Cultivar, Late spring frost, Resistance, Virus status.*

### Introduction

The specific agroecological conditions of the region is one of main determining factors for the right choice of the most appropriate species and cultivars. A limiting factor when choosing a place for apple orchards is the absolute minimum and maximum temperatures during different seasons, as well as the frequency of early autumn and late spring frosts, summer heats, the amount of vegetation rainfall, relative air humidity, strength and direction of wind, etc. (Bergamini and Faedi, 1984; Cline, 1998; Dzhuvinov et al., 2002; Blagov, 2011).

The reaction of apple cultivars to extreme winter colds and late spring frosts is the subject of many studies, because they can cause significant damage to the fruit yield (Zhelev, 1991). The frequency of occurrence of spring frost in some areas and the damage that they cause to the fruit harvest is the reason why spring frosts are limiting factor in apple cultivation.

Among biotic factors, apple is susceptible to infection by bacteria, fungi, phytoplasma, viruses and viroids. Among viruses the major ones are *Apple chlorotic leaf spot virus* (ACLSV), *Apple mosaic virus* (ApMV), *Apple stem grooving virus* (ASGV) and *Apple stem pitting virus* (ASPV) (Desvignes et al., 1999). All of them are economically important and common pathogens in commercial cultivars (Campbell, 1963; Posnette et al., 1963; Hadidi et al., 2011). ApMV is the most important virus, while the other three viruses ACLSV, ASPV and ASGV are latent (Nemeth, 1986). Latent viral infections in many apple (*Malus domestica* Bork.) cultivars and rootstocks can cause significant yield reduction up to 60%, particularly when occurring in mixed infections (Posnette, 1989). Economic impact and economic value

of viral diseases, of virus-free and infected apple cultivars was investigated by many authors (Maxim et al., 2004; Kviklys and Stankienė, 2005; Cieszłinska and Rutkowski, 2008, Öztürk et al., 2015). Virus-infected plants are more susceptible to various environmental stresses (Zawadzka, 1989).

The aim of the presented study was to evaluate 15 new introduced apple cultivars and 5 hybrids to spring frost tolerance and the occurrence of main pome fruit viruses.

### Materials and Methods

The research was conducted in two experimental apple orchards at the Institute of Agriculture – Kyustendil. The Institute is located 5 km east from the town, at the altitude of 450 m above sea level in the southwest part of Bulgaria. The meteorological conditions in this region for 2016 were: average yearly temperature + 12.0°C, the coolest month – December with average monthly temperature –1.2°C, the warmest month – July with average monthly temperature + 23.0°C, average sum of rainfall – 548 mm, date of the first autumn frost – October 29<sup>nd</sup>, date of the last spring frost – April 27<sup>th</sup>.

The first orchard was established in the spring of 2002. The objects of the study were new introduced cultivars Cadel, Ginger Gold, New Jonagold, Braeburn, Rosana, Rubinola, Fuji Nagafu 6, Oregon Spur, Arkcharm, Charden, Belgolden, Redstar, Scarlet Spur, Super Chief, Teser T219. Prima and Golden Delicious cultivars were used as controls. The second orchard was planted in the spring of 2007 with 5 apple hybrids 1/3 (Molly's Delicious - open pollinated), 1/5 (Malus robusta x Liberty), 1/26 (Melrose x Kent), 2/28 (Prima x Florina) and 2/30 (Prima x Sekai-ichi), selected at the same institute. The trees were grafted on MM 106 rootstock and planted at a distance of 4.5 x 2.5 m.

The study on the hardiness of the investigated apple cultivars to late spring frosts was conducted under natural conditions in 2016. On 27<sup>th</sup> April it was registered an absolute minimum air temperature of -4.0°C, with long duration about 5.0 hours. Twelve days after the late spring frost it was made the observation and the percentage of damage on young fruits was calculated. At this time the fruit size of all investigated cultivars and hybrids was about 20 mm in diameter (BBCH-72).

In total, 104 accessions of apple from 18 cultivars and 5 hybrids were tested using randomly collected samples of fully developed leaves and petals and processed using Enzyme Linked ImmunoSorbent Assay (ELISA) in two consecutive years – 2015 and 2016. All samples were tested by Double Antibody Sandwich- ELISA for the presence of *Apple mosaic virus* (ApMV) (Clark and Adams, 1977). DAS-ELISA for ACLSV and ASGV were conducted according to the modification suggested by Flegg and Clark (1979). Diagnostic kits of Loewe Phytodiagnostica GmbH (Sauerlach, Germany) were used.

### Results and Discussion

The late spring frost caused injuries both in the leaves and fruits. In leaves of all studied cultivars and hybrids, besides the separation of the epidermis from the other tissues, they became wrinkled and deformed. The injuries to young fruits were different in shape and intensity (Table 1). On the surface of fruits of Cadel, New Jonagold, Braeburn, Golden Delicious cultivars, and the hybrids 2/28, 2/30 and 1/3 were observed corking deformations called frost rings (Fig.1). The cultivars Ginger Gold, Rosana and Charden reacted with longitudinally cracking on fruits (Fig. 2). On the fruits of Arkcharm, Prima, Rubinola and hybrid 1/26 mixed damages from frost ring, cracked and russeting were observed. These symptoms were not observed in the rest cultivars - Fuji Nagafu 6, Oregon Spur, Scarlet Spur, Super Chief, Teser T219 and hybrid 1/5.



Figure 1. Corking deformations (frost rings) on fruit of hybrid 1/3 after late spring frost



Figure 2. Longitudinal cracking on fruits of Ginger Gold cultivar after late spring frost

Table 1. Damages on apple cultivars and hybrids from spring late frost (- 4.0°C)

Cultivar /Hybrid	Symptoms on the fruits	Damaged fruits, %
Cadel	frost rings, without cracking	70.0
Ginger Gold	longitudinal cracking	90.0
New Jonagold	frost ring and russeting	41.5
Braeburn	frost ring, without cracking	43.8
Rosana	longitudinal cracking and resination	81.7
Rubinola	frost ring, cracking of a cross and resination	83.5
Fuji Nagafu 6	no	0
Oregon Spur	no	0
Arkcharm	frost ring and longitudinal cracking	90.2
Charden	longitudinal cracking	10.4
Belgolden	russeting	89.3
Redstar	russeting	45.8
Scarlet Spur	no	0
Super Chief	no	0
Teser T219	no	0
Prima	frost ring and longitudinal cracking	91.2
Granny Smith	slight surface russeting	20.3
Golden Delicious	frost ring, without cracking	72.3
2/28	frost rings, without cracking	52.4
2/30	frost rings, without cracking	60.5
1/3	frost ring, without cracking	71.4
1/5	no	0
1/26	cracking and russeting	50.3

The results showed that the most sensitive to late spring frosts were the young fruits of the cultivars Ginger Gold, Arkcharm, Belgolden and Prima, in which about 90% of the fruits had the described symptoms. High levels of damages were also found in cultivars Cadel, Golden Delicious, Rosana, Rubinola and hybrid 1/3 - from 70 to 83%. The relatively resistant were young fruits of cultivars Charden and Granny Smith. The best resistance to late spring frost showed young fruit sets of hybrid 1/5 and cultivars Fuji Nagafu 6, Oregon Spur, Teser T219, Super Chief, and Scarlet Spur.

The symptoms on the fruits were maintained till the harvest. Although serious change in the taste of the damaged fruits was not found, they were non-marketable and used only for processing in juices and jams.

The incidence of ACLSV, ASGV and ApMV in the tested apple trees of investigated cultivars and hybrids are reported in Table 2.

Table 2. Viruses detected in the investigated apple cultivars and hybrids by ELISA.

Cultivar /Hybrid	Samples			Viruses detected			
	Tested	Infected	Infection rate (%)	ACLSV	ASGV	ApMV	ACLSV + ASGV
<b>Cadel</b>	5	3	60.0	3	0	0	0
<b>Ginger Gold</b>	5	5	100	5	0	0	0
<b>New Jonagold</b>	5	5	100	5	0	0	0
<b>Braeburn</b>	5	5	100	5	0	0	0
<b>Rosana</b>	5	5	100	5	0	0	0
<b>Rubinola</b>	5	5	100	5	0	0	0
<b>Fuji Nagafu 6</b>	5	5	100	4	0	0	1
<b>Oregon Spur</b>	4	4	100	3	0	0	1
<b>Arkcharm</b>	5	4	80.0	4	0	0	0
<b>Charden</b>	5	2	40.0	2	0	0	0
<b>Belgolden</b>	4	1	25.0	1	0	0	0
<b>Redstar</b>	5	5	100	5	0	0	0
<b>Scarlet Spur</b>	5	5	100	5	0	0	0
<b>Super Chief</b>	5	4	80.0	2	0	0	2
<b>Teser T219</b>	5	3	60.0	3	0	0	0
<b>Prima</b>	1	1	100	1	0	0	0
<b>Granny Smith</b>	5	4	80	1	3	0	0
<b>Golden Delicious</b>	5	2	40.0	1	1	0	0
<b>2/28</b>	5	1	20.0	1	0	0	0
<b>2/30</b>	4	3	75.0	3	0	0	0
<b>1/3</b>	2	1	50.0	1	0	0	0
<b>1/5</b>	5	2	40.0	2	0	0	0
<b>1/26</b>	4	3	75.0	3	0	0	0
<b>Total</b>	104	78	75.0 %	70 (67.3%)	4 (3.8%)	0	4 (3.8%)

Of the total 104 tested trees from 18 apple cultivars and 5 hybrids, 67.3% were infected with ACLSV and 3.8% with ASGV. A mixed infection by both ACLSV and ASGV was identified in 3.8% of tested trees. ApMV was not detected in investigated cultivars and hybrids. The distribution of these viruses was recorded as more or less frequent in all cultivars. Some of them were 100% infected with ACLSV - Ginger Gold, New Jonagold, Braeburn, Rosana, Rubinola, Redstar, Scarlet Spur. A mixed infection was found in two trees of Super Chief, one tree of cultivars Fuji Nagafu 6 and Oregon Spur. The detection of these viruses in apple orchard agrees in our previous observation on ACLSV and ASGV incidence in field-grown apple orchards regardless the age of orchards (Borisova et al., 2014). ACLSV was more frequent than ASGV in the tested orchards. No ApMV infection was found. A quite high level (about 75%) of incidence of ACLSV, based on detection by ELISA was reported by Kryczyński et al. (1995) of several apple cultivars in Poland and some cultivars were infected 100%.

Similarly severe ACLSV infection in main cultivars of intensive orchards was reported by Polk et al. (1997) in the Czech Republic. In Turkey, 126 out of 174 tested samples of apple in orchards and commercial gardens were infected with at least one virus (Caglayan et al., 2006). 36.8% of virus-infected plants were found in the apple collection in Romania (Popescu et al., 2004). The study of apple cultivars collection in Albania showed a very high level of virus contamination: ASPV (98.6%), ACLSV (97.8%), ASGV (91.4%) (Myrta et al., 2003). In our investigation although ACLSV and/or ASGV were detected in 75 % tested trees, no indications were obtained on the susceptibility of these cultivars. These viruses were in latent infections.

### **Conclusion**

The studied cultivars and hybrids reacted in a different way to late spring frost. Symptoms of young fruit were most pronounced in the Ginger Gold, Arkcharm and Prima cultivars, and damages were about 90%. Although their fruit were not seriously altered in taste, they were non-marketable and can only be used for processing in juices and jams. Hybrid 1/5 and cultivars Fuji Nagafu 6, Oregon Spur, Teser T219, Super Chief, Scarlet Spur had the best resistance to late spring frost, and they are the most suitable for the specific climatic conditions.

The results obtained in the present work show high level of virus contamination – 75.0% in average. The high incidence of ACLSV in the tested orchards calls for an evaluation of the health status of nursery trees before their cultivation in the field.

### **References**

- Bergamini, A., Faedi, W. (1984). *Monografia di cultivar di melo Roma*, vol. 2.
- Blagov, A. (2011). Some results of agrobiological investigation of apple cultivars and hybrids in Kyustendil region. *Plant Science*, 48, 14-19.
- Borisova, A., Borovinova, M., Kamenova, I. (2014). Major diseases of apple trees in Kyustendil region of Bulgaria. *Turkish Journal of Agricultural and Natural Sciences*, Special Issue 1, 695-700.
- Caglayan, K., Ulubas, S. C., Gazel, M., Jelkmann, W. (2006). Detection of four apple viruses by ELISA and RT-PCR assays in Turkey. *Turkish Journal of Agriculture and Forestry*, 30, (4), 241–246.
- Campbell, A.I. (1963). The effect of some latent virus infections on the growth and cropping of apples. *Journal of Horticultural Sciences* 38, 15–19.
- Cieslinska, M., Rutkowski, K. P. (2008). Effect of Apple chlorotic leaf spot virus on yield and quality of fruits ‘Golden Delicious’ and ‘Shampion’ apple trees. *Acta Horticulturae*, 781, 67–71.
- Clark, M.F., Adams, A.M. (1977). Characteristics of the micoplate method of enzyme-linked immunosorbent assay (ELISA) for the detection of plant viruses. *Journal of General Virology* 34, 475-481
- Cline, J. (1998). Evaluating new apple cultivars. *Canadian Fruitgrower*, April, 15-17.
- Desvignes, J.C., Boyé, R., Cornaggia, D., Grasseau, N. (1999). *Virus diseases of fruit trees*. Paris, Centre Technique Interprofessionnel des Fruits et Légumes, 202.
- Dzhubinov, V., Radulov, D., Penev, R. (2002). *The Apple Garden*. Zemizdat, Sofia, 376 pp.
- Flegg, C.L., Clark, M. F. (1979). The detection of apple chlorotic leafspot virus by a modified procedure of enzyme – linked immunosorbent assay. *Annals of Applied Biology* 91,61-65.

- Hadidi, A., Barba, M., Candresse, T., Jelkmann, W. (2011). *Virus and Virus-like Diseases of Pome and Stone fruits*. St. Paul, Minnesota U.S.A., American Phytopathological Society Press, 428 pp.
- Kryczyński, S., Szyndel, M.S., Paduch-Cichal, E., Głowacki, M. (1995): Virus-infection status of some apple propagative material plantations in Poland. *Phytopathologia Polonica* 10, 22: 75–84.
- Kviklys, D., Stankienė, J. (2005). Effect of health status of planting material on cv. *Shampion* apple yield and growth. *Sodininkystė ir daržininkystė*, 24 (4), 48–56.
- Maxim, A., Zagrai, L., Zagrai, I., Isac, M. (2004). Studies on the influence of Apple stem grooving virus on tree growth of various apple cultivars in the nursery. *Acta Horticulturae*, 657, 41–44.
- Myrta, A., Di Terlizzi, B., Stamo, B., Al Rwahnih, M., Savino, V., Carraro, L. (2003). A preliminary account of the presence of pome fruit viruses in Albania. *Acta Horticulture*, 657, 55–58.
- Nemeth, M. (1986). *Virus, Mycoplasma and Rickettsia Diseases of Fruit Trees*. Dordrecht, Boston, Lancaster, Nijhoff and Dr. W. Junk Publishers, pp. 750.
- Popescu, S., Constantin, G., Mazilu, C. R. (2004). Apple viral diseases diagnosed in the germplasm collection at I.C.D.P. Maracineni-Romania. *Acta Horticulturae*, 657, 51–54.
- Polk, J., Zieglerova, J., Bouma, J. (1997). Diagnosis and distribution of apple chlorotic leaf spot virus in pome fruits in Czech Republic. *Zahradnictví – Horticultural Science (Prague)* 24, 89–94.
- Posnette, A.F. (1963). Virus diseases of apples and pears. Technical Communication of Bureau Horticulture in East Malling 30, 141.
- Posnette, A. F. (1989). Losses caused by virus and virus-like diseases. In: *Virus and Virus-like Diseases of Pome Fruits and Simulating Noninfectious Disorders* (P.R. Fridlund, ed.), Washington, Cooperative Extension College of Agriculture and Home Economics Washington State University Pullman, pp. 3–6.
- Zawadzka, B. (1989). The influence of virus and mycoplasma diseases on frost damage of apple trees. *Acta Horticulture* 235, 59-68.
- Zhelev, I., Jouvinov, V. (1991). Evaluation of some apple cultivars in dense plantations relating to the late spring colds. *Plant Science*, 28 (3-6), 67-72.
- Öztürk, Y., Kaymak, S., Atay, E., İşçi, M., Şenyurt, H., Çevik, B. (2015). The effect on yield and fruit quality of some virus diseases in 'Granny Smith' apple cultivar. *Bitki Koruma Bülteni*, 55 (4), 317-330.

## INFLUENCE OF GRASS ESTABLISHMENT WITH SOME LEGUME SPECIES ON THE BIOCHEMICAL COMPOSITION OF 'BLACK SATIN' BLACKBERRY FRUITS

Diyan GEORGIEV<sup>1\*</sup>, Teodora MIHOVA<sup>1</sup>, Maria GEORGIEVA<sup>1</sup>, Petya IVANOVA<sup>2</sup>, Georgi POPSKI<sup>1</sup>, Galya NAYDENOVA<sup>3</sup>, Dimitar MITEV<sup>1</sup>

<sup>1</sup>Research Institute of Mountain Stockbreeding and Agriculture - Troyan, 281 Vasil Levsky Str., 5600 Troyan, Bulgaria

<sup>2</sup>Food Research and Development Institute, 154 Vasil Aprilov Str., 4000 Plovdiv, Bulgaria

<sup>3</sup>Experimental Station on Soybean, 61 Ruski Str., 5200 Pavlikeni, Bulgaria

\*Corresponding author: d\_georgiev\_@abv.bg

### Abstract

Blackberry is one of the main berry crops. It is not particularly demanding on soil and climate conditions. Foothill regions are suitable area for its cultivation, where plants develop to a large extent their biological and economic potential. The experiment was conducted during the period 2014-2016 in a plantation of the Research Institute of Mountain Stockbreeding and Agriculture (Bulgaria) at altitude of 400 m on grey forest soils. The experimental setting consists of interrow grass cover with common bird's-foot-trefoil, bird's-foot-trefoil of Aegean region and vetch. The influence of grass cover on some indicators of the biochemical composition and flowering characteristics of fruits was studied of 'Black Satin' blackberry cultivars. Higher values were registered in the content of anthocyanins and pectin. The grass cover with bird's-foot-trefoil and vetch had no influence on the colour characteristics of fruits. There were no significant differences in relation to the average weight of different fruit variants.

**Keywords:** *blackberries, cultivars, chemical composition, fruit weight*

### Introduction

Blackberry is one of the traditional crops with proven economic and social efficiency in the foothill and mountain regions of Bulgaria. Most of the plantations are located on slopes, which require anti-erosion systems for maintaining of soil surface. The soils in the mountain and hilly areas are among the most infertile in Bulgaria – with poor drainage, overdamping surface, low in organic matter, digestible forms of phosphorus and poorly supplied with mobile forms of nitrogen. These regions are catchment areas, where the use of pesticides is not desirable. What has been pointed so far requires the study of artificial grass cover as an adequate and effective practice for maintaining of soil surface in plantations of small-sized fruit species in the region of Troyan (Petkov, Petrov, 1998; Gergov et al., 2004). It is also necessary for the development and approval of environmentally friendly technologies for organic production of blackberries. Blackberry fruits are distinguished by a specific taste, aroma and rich biochemical composition (Boycheva et al., 1999). The very good balance of sugars and acids makes them attractive both for fresh consumption and for processing into various derivatives/products. Nowadays the interest to small-sized fruit species has been increased and especially to introduced varieties (Stoyanova et al., 2015). The aim of study was to follow the influence of some legumes on the biochemical composition and colour characteristics of fruits of 'Black Satin' blackberry cultivar.



## **Material and Methods**

The experiment was conducted in the period 2014 – 2016 in the collection plantation of Research Institute of Mountain Stockbreeding and Agriculture – in Troyan.

The object of the present paper is 'Black Satin' blackberry cultivar. 'Black Satin' is American cultivar that was introduced in Bulgaria in 1984. The bush has a moderate growth, with average number of shoot, thornless. It is relatively resistant to high temperatures and drought, but it is susceptible to winter frosts. Fruits are globose-conical to oblong, with intensive black colour, with a glance (Velchev & Boycheva, 1983; Hristov et al., 1988; Ivanov, 2003).

The following variants of grass cover for soil surface were studied: control, common bird's-foot-trefoil, bird's-foot-trefoil of Aegean region and vetch.

Biochemical composition of fruits of the studied cultivar was conducted in the chemical laboratory in the institute, as the following indicators were observed: dry matter weight (%), refractometric determination of dry matter, total sugars % (total, inverted and sucrose) according to the method of Schoorl and Regenbogen; acids % (malic acid); ascorbic acid according to method of Fialkov; tanning according to Levental method; anthocyanins according to method of Fuleki and Francis; pectin according to Melitz method. Analyses were conducted in the chemical laboratory of RIMSA.

The fruit colour was determined according to Gardener in the Food Research and Development Institute – Plovdiv.

The colour was determined according to Gardner – using the laboratory apparatus 'GOLORGRAD2000' of BYK-GARDNER INC. USA. The blackberry samples were grounded in laboratory apparatus MPIЯ–2M with 4 mm diameter of grid holes. The sample was deaerated in a vacuum chamber at vacuum of 0.85 kPa for 10 min.

The indicators were given according to the system CIE Lab. Chromaticity coordinates L, and b were taken for the measurement: L - colour brightness; + a - red; -a green; +b - yellow, -b - blue.

Precipitation amount in the period from April – September were significantly higher than the annual average for that area.

In 2014 were reported 820.4 l, for 2015 – 594.2 l and for 2016 484.8 l, as for a ten-year period there were 528.51 l.

## **Results and Discussion**

Data from biochemical composition of fruits are presented in Table 1. The analysis of results shows varying in the values of the individual indicators of the biochemical composition of fruits throughout the period, probably due to different agro-meteorological conditions.

The highest average dry matter weight was recorded in the variants with common bird's-foot-trefoil - 16.06% and bird's-foot-trefoil of Aegean region - 15.93% (Table 2). As in 2015, its amount reached up to 18.16% in the control fruits, and it was the least in the vetch variant – 11.28% in 2014.

There were no large differences in the average refractometric dry matter of different experimental settings that were in the range from 9.33% (variant with vetch) to 10.40% (control). There was no significant variation in that indicator amount either during the years of study.

In 2015, a higher content of total sugars was found in control fruits and the variants with bird's-foot-trefoil, which were in the range from 6.35 % to 7.85 %. In the variant with vetch, the values were almost identical for a three-year period. There were no significant differences in the amounts of total sugars among the variants average for the period.

Values were almost identical also in the case of inverted sugar. They were higher in the

control (7.20%) and the common bird's-foot-trefoil (7.85 %) in 2015. There were no significant differences for the other two variants. They were the least average for the period in the variant with bird's-foot-trefoil of Aegean region - 5.40%

There was no sucrose in the control and variant with vetch. For the other variants, there were minimum amounts only in one of the years.

Organic acids were in close values among variants in the experiment. The average amounts were in the range 0.5 %-0.6 %.The content of ascorbic acid varied over the years in all variants. On the average, this indicator was higher for the common bird's-foot-trefoil – 20.53 mg/% and bird's-foot-trefoil of Aegean region – 22.88 mg/%. Similar results were reported by Skrovankova et al. (2015). Tanning substances were recorded in different values for each year of the variants. The highest amounts were determined for bird's-foot-trefoil of Aegean region – 0.333 % (2016) and vetch – 0.333 % (2015). They were the most for the above mentioned variants average for the period. Over the years the values of anthocyanins reached 129.35 mg /% (bird's-foot-trefoil of Aegean region) and 97.58 mg /% (common bird's-foot-trefoil) in 2015 and the lowest were reported in variants with vetch - 40.16 mg /% in 2014. Average for the period, they were the most in the variant with bird's-foot-trefoil of Aegean region – 98.92 mg /% (Figure 1). There was a significant variation of pectin in the study period. Its values increased twice and even more in different years.

The highest amounts were reported in the variants with vetch – 2.320% and with common bird's-foot-trefoil – 1.400% in 2016. The highest average value of the indicator was also obtained for these variants for the period.

The parameters of the fruit color characteristics are presented in Table 3.

In terms of fruit brightness, there were no significant differences for all variants. There were higher values in the control and common bird's-foot-trefoil variant. Red colour shade was higher in the control and for vetch variant. Yellow colour had the highest values for the same two variants.

Table 1. Biochemical composition of 'Black Satin' cultivar for different variants of grass cover for the period 2014-2016.

Grass cover variants	Year	DM weight (%)	DM according RE (%)	Total sugars (%)	Inverted sugar (%)	Sucrose (%)	Acids (%)	vit.C (mg/%)	Tannins (%)	Anthocyanins (mg)	Pectin (%)
Control	2014	10,20	8,00	6,15	6,15	0,00	0,540	26,40	0,170	86,29	0,530
	2015	18,16	12,20	7,20	7,20	0,00	0,640	17,60	0,270	60,65	0,060
	2016	16,20	11,00	5,50	5,50	0,00	0,580	7,04	0,291	58,39	1,270
Common bird's-foot-trefoil	2014	13,10	7,50	5,85	5,85	0,00	0,600	28,16	0,212	55,00	0,520
	2015	17,26	12,00	7,85	7,85	0,00	0,570	26,40	0,270	97,58	0,620
	2016	17,83	8,60	5,00	4,05	0,90	0,580	7,04	0,208	55,81	1,400
Trefoil of Aegean region	2014	14,04	8,50	5,70	5,70	0,00	0,600	26,40	0,148	76,77	0,590
	2015	17,75	11,00	6,35	5,50	0,81	0,510	35,20	0,291	129,35	0,430
	2016	16,00	10,30	5,00	5,00	0,00	0,520	7,04	0,333	90,65	1,120
Vetch with barley	2014	11,28	8,00	6,65	6,65	0,00	0,600	24,64	0,170	40,16	0,180
	2015	16,84	11,00	6,65	6,65	0,00	0,640	17,60	0,333	72,58	1,000
	2016	16,98	9,00	6,50	6,50	0,00	0,580	7,04	0,290	59,35	2,320

Table 2. Biochemical composition of 'Black satin' cultivar for different variants of grass cover, on the average for 2014-2016

Grass cover variants	DM weight(%)	DM according RE (%)	Total sugars(%)	Inverted sugar (%)	Sucrose (%)	Acids (%)	vit.C ((mg/%)	Tannins (%)	Anthocyanins (mg)	Pectin (%)
Control	14,85	10,40	6,28	6,28	0,00	0,59	17,01	0,244	68,44	0,620
Common bird's-foot-trefoil	16,06	9,37	6,23	5,92	0,30	0,58	20,53	0,230	69,46	0,847
Trefoil of Aegean region	15,93	9,93	5,68	5,40	0,27	0,54	22,88	0,257	98,92	0,713
Vetch with barley	15,03	9,33	6,60	6,60	0,00	0,61	16,43	0,264	57,36	1,167

Table 3. Colour characteristics of fruits for grass cover variants

Grass cover variants	Indicators		
	L	a	b
Control	14.98	31.74	8.67
Common bird's-foot-trefoil	14.83	29.33	7.39
Trefoil of Aegean region	13.27	30.30	7.87
Vetch with barley	14.02	31.04	8.16

The highest average fruit weight was recorded for the variant with bird's-foot-trefoil of Aegean region – 3.30 g and the control – 2.85 g, and it was the lowest for the vetch variant – 2.50 g. Variation of that indicator is great for all variants.

Table 4. Fruit weight (g) of 'Black satin' cultivar for different variants of grass cover

Grass cover variants	Year	Min	Max	Average	STDEV	VC
Control	2015	2,00	5,33	3,20	0,97	30,16
	2016	2,00	5,00	2,85	1,50	52,63
Common bird's-foot-trefoil	2015	2,92	4,33	2,92	0,69	23,50
	2016	1,75	5,00	2,65	1,63	61,32
Trefoil of Aegean region	2015	3,18	4,50	3,18	0,67	20,96
	2016	3,00	5,00	3,30	1,00	30,30
Vetch with barley	2015	2,67	3,67	2,67	0,72	26,98
	2016	2,00	4,70	2,50	1,35	54,00

### Conclusion

An analysis was conducted of the influence of interrow grass cover with some legumes over the biochemical composition and colour parameters of 'Black Satin' blackberry fruits. Higher anthocyanin values were recorded for grass cover with bird's-foot-trefoil of Aegean region, and pectin in the three variants in comparison with control. The grass cover with bird's-foot-trefoil of Aegean region had a positive influence over the fruit size of 'Black Satin' cultivar.

### References

- Boycheva R., Velchev V., Stoyanova N., Tsoleva E. (1999). Small-sized fruit species. Fermer, Sofia, pp. 5-8.
- Gergov, I., Petrov P., Mihaylova P. (2004). Economic results of the testing of new systems for maintaining of soil surface in young raspberry plantation. *Journal of Mountain Agriculture on the Balkans*, Vol. 7, No 6, 784-792.
- Hristov L. Ivanov A., Koserkov A., Nachevski V. (1988). Berries in our garden. Zemizdat, Sofia, pp. 86.
- Ivanov A. (2003). Berries. *Dionis*, Sofia, pp. 147-148.
- Petkov T., Petrov P. (1998). Environmentally friendly approaches for maintaining the soil surface in fruit-bearing raspberry plantations. *Journal of Mountain Agriculture on the Balkans*, Vol. 1, No 3-4, 336-342.
- Skrovankova S., Sumczynski D., Mlcek J., Jurikova T., Sochor J. (2015). Bioactive compounds and antioxidant activity in different types of berries. *Int. J. Mol. Sci.*, 16, 24673-24706; doi:10.3390/ijms161024673
- Stoyanova N., Antonova V., Serbezova D. (2015). A study of introduced black currant varieties. *Plant Science*, Vol. LII, No 2, 25-28.
- Velchev V., Boycheva R. (1983). Biological and biochemical characteristic of blackberry. *Gardening and vine-growing*, 1, 11-20.

## COMPARATIVE INVESTIGATION OF THREE CHERRY CULTIVARS WITH DIFFERENT STEM HEIGHTS

Denica D. SERBEZOVA<sup>1</sup>, Iliyana S. KRISHKOVA<sup>2\*</sup>

<sup>1</sup>Faculty of Agronomy University of Forestry, Sofia, Bulgaria

<sup>2</sup>Institute of Agriculture, Kyustendil, Bulgaria

\*Corresponding author: email: krishkova@abv.bg

### Abstract

A comparative investigation of the growth and reproductive parameters of trees of the cherry cultivars: Kozerska, Stella, and Stefania with five different cutting heights of the stem and summer pruning was conducted during the period 2008–2014 in the experimental field of the Institute of Agriculture – Kyustendil, Bulgaria. The cultivars were grafted on mahaleb rootstock and planted at a spacing of 5 x 5 m. The growth of the trees of all cultivars was most vigorous at heights of the stems of 70 and 110 cm. The application of summer pruning led to suppression of the growth, which was with the lowest value among the treatments tested. During the period of full fruit-bearing, the highest fruit yields and largest fruits were obtained in the treatments with trees whose stems were shortened at 70 and 110 cm above the soil surface. Summer pruning and cutting of the stems at 25 cm above the soil surface retarded the transition of the trees into full fruit-bearing. Cultivar Stella shortened to 70 cm had the best economic performance (1,534 euro/ha), followed by Stefania at 110 cm (1,498 euro/ha); the lowest values of this parameter were observed in Kozerska at a stem height of 70 cm and summer pruning applied (264 euro/ha). Stella and Stefania had better growth and economic properties than Kozerska.

**Keywords:** *cherry, cultivar, growth, yield, height of the stem.*

### Introduction

Technology improvement is one of the most important priorities in cultivating species and varieties (Micic et al., 2008; Rozpara et al., 2008). In addition to the variety features, the growth factor and the height of the crown are an exceedingly important element contributing to a more efficient fruit harvesting (Radomirska et al., 2010). In a study of five varieties and four rootstocks during the fruiting period, formed as a spindle with a supporting structure, it was found that in the trees with the spindle shape were more vigorously growing (Blazkova et al., 2010). In Hungary, a cherry rootstock that is suitable for hand picking and in accordance with the requirements of the European market has been proposed (Hrotko et al., 2008). The formation system has a significant impact on cherry tree growth and yield (Radunic et al., 2011), eventually reflecting on the economic efficiency of production.

In this respect, it is critically important to study the growth and reproduction behavior of individual cherry varieties, which was the aim of this study.

### Material and Methods

The investigation was conducted in the experimental field of the Agricultural Institute - Kyustendil (Bulgaria) during the period 2008-2014. The studied cultivars: Kozerska, Stella, and Stefania were grafted onto a mahaleb rootstock and grown at a distance of 5 m in the row and between rows.

The experiment was conducted in accordance with the standard method in four replications, with three trees in each replication, or 12 trees per treatment of pruning. We studied five treatments of stem-cutting height in each variety representing different heights of the stem from the soil surface achieved by application of summer pruning: I - 25 cm; II - 70 cm; III - 110 cm; IV - 150 cm; and V - 70 cm.

A free-growing tree crown was used, and the orchard was maintained in fallow using shallow cultivations (at a depth of 8–10 cm) and autumn deep plowing. All other agro-technical measures were the same for all varieties and treatments of pruning. We obtained and analyzed: stem diameter, tree height, diameter of the crown, average yield (kg/tree), gross output (euro/ha) and production costs (euro/ha).

## **Results and Discussion**

After planting, the stem diameters of all the studied cultivars and pruning variants were approximately the same, ranging from 1.06 cm to 1.42 cm.

Over the seven years of study, there was a tendency for increasing of stem diameter, which was more expressed at the lower stem height. We assume that phenomenon was due to a better balance between the over-ground and underground part of the trees (Table 1). Stem diameter in cv. Kozerska varied from 8.6 cm to 11.76 cm; in Stella, from 8.5 to 10.26 cm; and in Stefania, from 8.0 cm to 12.8 cm. The differences were statistically significant for 2012, 2013, and 2014. Therefore, during the studied period, the smaller stems grew more rapidly.

The growth of stem depended on variety, and the stems of Stefania trees grew faster, followed in descending order by those of Kozerska and Stella. With the exception of Kozerska, the stems on which summer pruning had been applied exhibited the least vigorous growth. This can be explained by influence summer pruning exerts on the dynamics of tree growth processes.

The treatments with stem reduction influenced the height and the average diameter of the crowns, and hence the volumes of the crowns, which was also statistically confirmed (Table 2). In all studied varieties, with the exception of Kozerska from variant I, the crowns of the trees of variants II and III grew faster, which we attribute to the better proportion of their underground and above-ground parts. These differences were also statistically significant for 2012, 2013, and 2014, with the exception of Kozerska. The crowns of the trees on which summer pruning was performed had the lowest growth. Therefore, the experimental trees of Stefania and Stella demonstrated the most vigorous growth (excluding Kozerska) when the stem was cut on 70 cm and 110 cm of height. Therefore, summer pruning reduces the growth of experimental trees.

In 2013 and 2014, the trees were in their full fruit-bearing period (Table 3). It is clear from the table that for the Kozerska variety in 2013, the lowest quantity of fruits were obtained from summer-pruned trees (3 kg), and the highest in the third-variant (18 kg). This tendency was not sustained in 2014. The lowest fruit yields were obtained in the variant with summer pruning of Stella, from 7 to 23 kg in 2013; this trend remained in 2014. The fruit production received from Stefania ranged from 3 kg in 2013 to 16 kg in 2014. Regardless of the pruning variant, the variety and the year, the highest yields were obtained from the Stella variety, which was the weakest growing. Therefore, yields depend on, and are inversely proportional to, the vigor of the variety.

Table 3. Average yield per tree (kg)

Variety	Variant	2013	2014	Total
Kozerska	I	15	52	67
	II st	11	49	60
	III	18	43	61
	IV	15	53	68
	V	3	39	42
	<b>Sd</b>	<b>0.708</b>	<b>0.971</b>	
	<b>f</b>	<b>1.309</b>	<b>0.717</b>	
	<b>LSD 0.05</b>	<b>1.635</b>	<b>2.244</b>	
Stella	I	15	80	95
	II st	18	103	121
	III	26	63	89
	IV	18	44	62
	V	7	23	30
	<b>Sd</b>	<b>0.533</b>	<b>2.653</b>	
	<b>f</b>	<b>3.477</b>	<b>3.345</b>	
	<b>LSD 0.05</b>	<b>1.232</b>	<b>6.128</b>	
Stefania	I	12	73	85
	II st	12	70	82
	III	37	103	140
	IV	6	14	20
	V	2	16	18
	<b>Sd</b>	<b>0.352</b>	<b>1.577</b>	
	<b>f</b>	<b>30.224</b>	<b>14.089</b>	
	<b>LSD 0.05</b>	<b>0,8137</b>	<b>3.642</b>	

Depending on the variety, the highest yields in 2013–2014 were obtained from Stella trees, followed in descending order by Stefania and Kozerska. The highest yield during the study period was obtained from the third variant in Stefania variety, amounting to 140 g per tree, whereas the lowest was obtained by the trees of the summer pruning variant of the Stefania variety.

Regardless of the variety, the lowest yield for the study period was obtained in the V variant, whereas the highest was established in variants II and III. As a result, the summer fruit harvest at the beginning of the fruiting period was growing more slowly compared to variant II and III, which shows that the trees shortened to 70 cm and 110 cm were faster garnished with fruitwood.

In 2013 and 2014 the average fruit weight varied according to the variants of the pruning and the variety. Kozerska variety produced the largest yield among all III variants (8.0 g), whereas it was the smallest in variant V (6.9 g) in 2013. In 2014, for the same variety, the fruits of the II variant were the largest and the smallest in the IV variant - 7.8 g. By 2013, in all variants where larger fruits were formed, although the yield was much higher. This means that the trees had not reached their maximum potential. The largest fruits in the year 2013 from the variant II (8.9 g), and the smallest among the IV variants were obtained from Stella variety. There was no significant difference in the size of the fruits in 2013 and 2014. In 2013, the fruits of variants I and II were the largest, whereas V variant was the smallest from the Stefania variety. In 2010, the fruits of variant II (9.9 g) were the largest, whereas the smallest were from variant V (8.9 g). It is obvious that, despite the higher yields of Stefania variety in 2014, larger fruits were obtained on lower stems at the beginning of full fruiting. The fruit size

depended on the specific variety, and those of Stefania were the largest, followed in descending order by the ones produced by the trees of Kozerska and Stella.

The obtained and analyzed data in the experimental cherry orchards with different stem-cutting heights indicate that the variant shortened to 110 cm expressed the best economic results in 2013 among all three varieties. Nevertheless, Stefania had an advantage over the other cultivars examined (Figure 1). The lowest values were obtained in the variants in which the trees were shortened to 70 cm and summer pruning was implemented. In 2014, the gross output was significantly higher than that in 2013, which was caused by the higher yields. The indicator values ranged from 757 to 2,774 euro/ha. Values of the indicator were the highest in the variants shortened to 150 cm for Kozerska (1,028 euro/ha), 70 cm for Stella, and 110 cm for Stefania (2,774 euro/ha). In two of the varieties, the lowest results were obtained again in the variants whose height was reduced to 70 cm by summer pruning. In all variants, Stella had better results than the other two varieties, except variant III, where Stefania performed better. In 2015, in individual variants, no yield and no gross output was obtained. For the Kozerska and Stella varieties, the values of the indicator were the highest in the variant where the trees were cut to 70 cm, respectively 1,176 and 1,610 euro/ha, and for Stefania at 110 cm (1,274 euro/ha). The trend for the lowest results for the cuts of 70 cm and summer pruning was retained. Average for the period 2013–2015, the highest value is the gross production of the Stella variety, shortened to 70 cm (1,534 euro/ha), followed by Stefania at 110 cm (1,498 euro/ha), and the lowest was obtained in Kozerska at the height of 70 cm and summer pruning applied (264 euro/ha). Stella and Stefania had higher results than the corresponding variants of Kozerska.

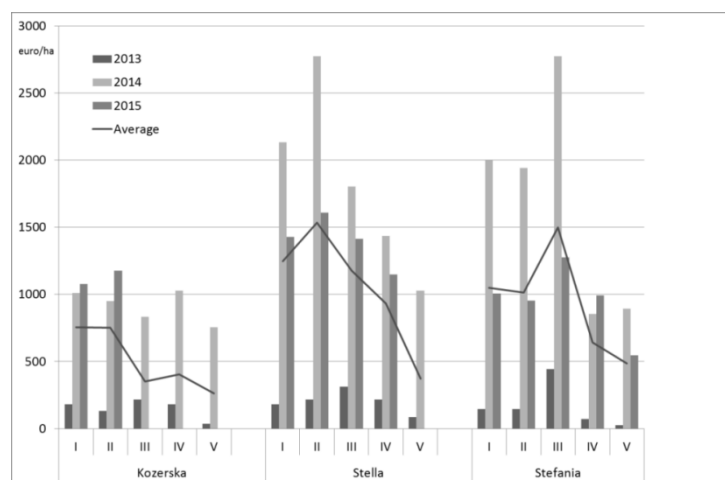


Fig. 1. Gross production, euro/ha



Table 1. Average stem diameter, cm

Variety	Variant	After planting	2008	2009	2010	2011	2012	2013	2014	Growth
Kozerska	I	1.13	1.74	2.78	4.89	5.95	7.84	10.53	12.84	11.71
	II st	1.20	2.16	3.28	4.70	5.60	7.15	9.45	11.54	10.34
	III	1.12	2.18	3.27	4.57	5.11	6.09	7.61	9.72	8.6
	IV	1.08	1.99	3.07	4.86	5.68	6.78	8.55	10.87	9.79
	V	1.06	1.75	2.90	4.77	5.46	6.63	8.59	10.84	9.78
	Sd						<b>0.435</b>	<b>0.563</b>	<b>0.671</b>	
	F						<b>4.472</b>	<b>7.786</b>	<b>5.802</b>	
	LSD 0.05						<b>1.005</b>	<b>1.3</b>	<b>1.55</b>	
Stella	I	1.42	1.97	2.88	4.61	5.73	7.43	10.01	12.32	10.9
	II st	1.42	1.95	2.82	4.51	5.51	7.19	9.52	11.49	10.07
	III	1.33	2.28	3.30	5.23	6.20	7.48	9.45	11.55	10.22
	IV	1.40	2.45	4.11	5.30	6.15	7.30	8.89	11.12	9.72
	V	1.35	2.09	3.23	4.70	5.37	6.19	7.99	9.89	8.54
	Sd						<b>0.360</b>	<b>0.466</b>	<b>0.528</b>	
	F						<b>4.329</b>	<b>5.476</b>	<b>5.648</b>	
	LSD 0.05						<b>0.832</b>	<b>1.076</b>	<b>1.218</b>	
Stefania	I	1.23	1.90	3.27	5.36	6.52	8.39	10.39	13.99	12.76
	II st	1.20	1.98	3.09	4.88	6.06	7.70	9.98	12.59	11.39
	III	1.24	2.33	3.66	5.90	7.39	9.04	11.09	13.55	12.31
	IV	1.23	2.31	3.39	5.15	5.84	7.46	9.23	12.37	11.14
	V	1.25	2.17	3.31	4.33	5.21	5.60	7.14	9.33	8.08
	Sd						<b>0.500</b>	<b>0.609</b>	<b>0.666</b>	
	F						<b>10.467</b>	<b>12.376</b>	<b>15.020</b>	
	LSD 0.05						<b>1.155</b>	<b>1.407</b>	<b>1.538</b>	

Table 2. Size of the crown, m

Variety	Variant	2010			2011			2012			2013			2014			Growth of volume, m <sup>3</sup>
		height, m	diameter, m	volume, m <sup>3</sup>	height, m	diameter, m	volume, m <sup>3</sup>	height, m	diameter, m	volume, m <sup>3</sup>	height, m	diameter, m	volume, m <sup>3</sup>	height, m	diameter, m	volume, m <sup>3</sup>	
Kozerska	I	2.13	1.52	1.28	2.34	1.55	1.47	3.33	2.63	6.03	3.82	2.84	8.06	4.10	2.81	8.47	7.19
	II st	2.05	1.26	0.87	2.33	1.49	1.35	3.36	2.48	5.41	3.50	2.61	6.24	3.65	2.53	6.11	5.24
	III	1.98	1.19	0.75	2.13	1.27	0.90	2.75	2.01	2.91	3.32	2.51	5.47	3.53	2.24	4.63	3.88
	IV	2.45	1.39	1.30	2.51	1.44	1.36	3.31	2.27	4.46	3.53	2.29	4.84	3.58	2.22	4.62	3.32
	V	2.21	1.57	1.42	2.03	1.27	0.86	3.18	2.43	4.91	3.27	2.56	5.61	3.98	2.60	7.04	5.62
	<b>Sd</b>									<b>0.575</b>			<b>0.563</b>			<b>0.671</b>	
	<b>F</b>									<b>8.520</b>			<b>7.786</b>			<b>5.802</b>	
<b>LSD 0.05</b>									<b>1.328</b>			<b>1.3</b>			<b>1.55</b>		
Stella	I	1.78	1.14	0.61	2.11	1.33	0.98	3.15	2.16	3.85	3.45	2.39	5.16	3.12	2.24	4.10	3.49
	II st	1.87	1.16	0.66	2.13	1.36	1.03	2.34	2.34	4.64	3.42	2.38	5.07	2.98	2.33	4.23	3.57
	III	2.32	1.37	1.15	2.49	1.59	1.65	2.43	2.43	5.52	3.63	2.87	7.82	3.20	2.55	5.44	4.29
	IV	2.57	1.24	1.04	2.55	1.42	1.34	2.23	2.23	4.57	3.40	2.63	6.15	3.15	2.25	4.17	3.13
	V	1.92	1.21	0.74	1.79	1.10	0.57	1.98	1.98	2.69	3.07	2.42	4.70	3.00	2.08	3.40	2.66
	<b>Sd</b>									<b>0.625</b>			<b>0.986</b>			<b>0.628</b>	
	<b>F</b>									<b>5.827</b>			<b>2.801</b>			<b>2.699</b>	
<b>LSD 0.05</b>									<b>1.444</b>			<b>2.278</b>			<b>1.451</b>		
Stefania	I	1.96	1.30	0.89	2.22	1.44	1.20	2.22	2.22	4.23	3.48	2.69	6.59	3.90	2.62	7.00	6.11
	II st	1.95	1.19	0.72	2.28	1.43	1.22	2.09	2.09	3.73	3.40	2.56	5.83	3.78	2.88	8.20	7.48
	III	2.51	1.49	1.47	2.68	1.84	2.37	2.42	2.42	5.81	3.93	2.94	8.89	4.00	2.91	8.86	7.39
	IV	2.22	1.27	0.95	2.41	1.45	1.33	2.00	2.00	3.51	3.70	2.54	6.25	3.82	2.27	5.15	4.20
	V	1.61	0.98	0.41	1.61	1.08	0.49	1.70	1.70	1.72	2.80	2.05	3.08	3.08	1.99	3.19	2.78
	<b>Sd</b>									<b>0.896</b>			<b>1.861</b>			<b>1.244</b>	
	<b>F</b>									<b>5.392</b>			<b>2.552</b>			<b>7.037</b>	
<b>LSD 0.05</b>									<b>2.068</b>			<b>4.298</b>			<b>2.874</b>		

## **Conclusions**

The growing characteristics of cherry varieties are influenced by the height of stem reduction. They are best realized when the stem is cut at 70 and 110 cm, whereas the weakest growth is observed in trees that have been subjected to summer pruning.

At the beginning of full fruiting, the highest total yield was obtained from cherry trees with a stem height reduced to 70 and 110 cm (from 60 kg to 140 kg per tree). The fruits harvested in these treatments were also the largest (from 8.3 to 9.9 g).

In addition, we found that the summer pruning and cutting of the stems at 25 cm from the soil surface leads to later fruiting of the cherry varieties and formation of smaller fruits. The height of the cherry stem shortening does not significantly affect the content of dry matter, sugars, and acids in the fruits as well as the chemical composition of the leaves. The highest value of gross production was established in the trees of Stella variety that had been shortened to 70 cm and those of Stefania reduced to 110 cm.

## **References**

- Blazkova J., H. Drahosova, I. Hlusickova (2010). Tree vigour, cropping, and phenology of sweet cherries in two systems of tree training on dwarf rootstocks. *Hort. Sci. (Prague)*, 37: 127–138.
- Hrotko K., Magyar L., Gyeviski M. (2008). Achievements in high density cherry orchard systems in Hungary. *Bulletin UASVM. Horticulture* 65(1): 225-230.
- Micic N., Duric G., Cvetkovic M., Marinkovic D. (2008). Contemporary systems of cherry growing. *Zbornik naučnih radova*. 14 (5): 33-47.
- Radicevic S., R.Cerovic, S. Maric, M. Dordevic (2011). Flowering time and incompatibility groups – cultivar combination in commercial sweet cherry (*Prunus avium* L.) orchard. *Genetika*.43 (2): 397 -406.
- Radomirska, I., V. Lichev, A. Papachatzis (2010). Prime cost of production and costs for growing cherry cultivar “Stella” grafted on 10 rootstocks with different growth manifestations. *Journal of Mountain Agriculture on the Balkans*, Vol. 13 (3), 756-766.
- Rozpara E., Z. Grzyb, P. Bielicki (2008). Influence of various soil maintenance methods in organic orchard on the growth and yielding of sweet cherry trees in the first years after planting. *Journal of Fruit and Ornamental Plant Research*. 16: 17-24.

## EFFECTIVENESS OF TWO TYPES OF CROWN PRUNING OF SOUR CHERRY CULTIVAR ERDI BÖTERMÖ

Iliyana KRISHKOVA<sup>1\*</sup>, Denica SERBEZOVA<sup>2</sup>

<sup>1</sup>Institute of Agriculture, Kyustendil, Bulgaria

<sup>2</sup> Faculty of Agronomy University of Forestry, Sofia, Bulgaria

\*Corresponding author: krishkova@abv.bg

### Abstract

The influence of two types of pruning, a voluminous crown with different numbers of skeletal branches (5–6 and 15–18), of trees of the sour cherry cultivar Erdi Bötermö on the growth characteristics, chemical composition of the fruits and leaves, and the economic performance was examined. The investigations were carried out during the period 2006–2015 in the experimental field of the Institute of Agriculture – Kyustendil, Bulgaria. The orchard was established with sour cherry trees grafted on mahaleb rootstock and planted at distances of 5 x 4 m (500 trees/ha). The free-growing crown with 15–18 branches induced a better growth than that in the trees with 5–6 branches. The trees with 5–6 branches entered earlier the period of full fruit-bearing and had higher yields compared to those of the trees with 15–18 branches. The latter trees were more vigorous, and their yield and average fruit weight were greater. The number of skeletal branches exerted no effect on the content of dry matter, sugars, and acids in the fruits and leaf chemical composition. The resulting balance value amounted to 2,430 €/ha. The economic evaluation confirmed that a crown with 5–6 skeletal branches provided higher economic returns.

**Keywords:** *cherry, forming a crown, economic impact*

### Introduction

Sour cherry is an economically valuable fruit species with production traditions in our country (Mitov et al., 1990; Vasilev et al., 1982). The biological and economic qualities of sour cherry allow it to take a worthy place in the fruit-growing of Bulgaria. Valuable nutritional, medicinal, and dietary qualities make it a desirable fruit on both the domestic and the outside market. In the last 30 years there has been a decline in the production of sour cherry despite the favorable conditions for the cultivation of this species in our country (Sotirov and Radomirska, 2012). A number of factors influence the economic efficiency of fruit production in perennial fruit crops - choice of the appropriate site for orchard establishment, the variety-rootstock combinations used, agrotechnical measures applied, material and labor costs, demand and supply of fruits and their conversion price (Bashev, 1990; Zimbrek et al., 1995). Unfortunately, the studies conducted to identify and analyze the factors affecting the economic efficiency of sour cherry fruit production in Bulgaria are scarce. A previous comparative study was performed of six variety-rootstock combinations. Sour cherry trees of the varieties Schatten Morelle and Meteor, grafted on seedlings of the cherry variety Drogan's Yellow and mahaleb rootstocks SL-64 and T-36 were used in the experiments. A good economic effect was obtained for the experimental trees, which were cultivated under identical agrotechnical conditions, expressed. The combination of cv. Meteor on T-36 mahaleb rootstock had the highest economic efficiency and additional profit obtained. The profitability of the costs of yielding the additional fruit production is 614%, which is a guarantee of a high return of each cost (Saeva and Koukov, 1998).

Sour cherry production in Bulgaria is characterized by many problems that require purposeful and hard work to improve yield quantity and quality. Therefore, the purpose of the present study was to investigate the productivity and economic performance of two types of the crown pruning of the sour cherry cultivar Erdi Bötermö.

### **Material and Methods**

The experiment was established in 2006 in the experimental field of the Institute of Agriculture – Kyustendil in Bulgaria. Experimental Erdi Bötermö trees, grafted on a mahaleb rootstock and planted at a distance of 5 m between the rows and 4 m in the rows or 500 pcs / ha, were used for the experiments.

The field trial was based on the long- plot method in four replications with four trees in each replication.

We studied a tree shape with a different number of skeleton branches:

Variant I - free crown with 15–18 branches;

Variant II - free crown with 5–6 branches (standard).

The orchard interrows were maintained in fallow, with 6–8 shallow treatments and autumn deep plowing. Irrigation was carried out by over-crown sprinkling and plant protection through ground-mounted devices.

The balance value of the plantation, used as an economic indicator in the study, includes all production costs associated with the establishment and cultivation of the plants until fruit-bearing. During the fruit growing period, the main economic indicators were calculated annually: gross output, euro/ha; production costs, euro/ha; net income, euro/ha; rate of profitability, %. The necessary funds for obtaining fruit production were established on the basis of actual costs incurred in accordance with the standardized norms and tariffs for labor and mechanized works used in the Institute of Agriculture - Kyustendil as well as taking into account the market prices of the raw materials and other materials utilized. The valuation of production was determined using the actual realization prices in the individual years.

### **Results and Discussion**

The balance value of one hectare of sour cherry plantation amounts to 2,369.35 euro/ha (Table 1). In the year of planting, the material costs significantly exceed labor costs. In the structure of material costs, the expenses for planting material and fertilizers account for a major share. Koprivlenski and Krinkov (2002) obtained similar results, who found that in the establishment of permanent crops, 50% of the material costs incurred were for planting material and 40% for fertilizers. In our investigation, the labor costs in both variants were identical because of the implementation of the same technology of establishment. Mechanized services required the largest part of the financial resources spent (71.32%) due to the relatively high degree of mechanization of the labor processes during planting. Labor costs accounted for the remaining 28.68%.

Differences in costs were hardly observed during the growing period until initiation of fruiting, except for those incurred only in the first year, when replanting of a small part of the trees was carried out.

Table 1. Balance value, euro/ha.

Types of costs	Establishment and First growing season	Second growing season	Third growing season	Total costs for the period
Labor costs	469.90	286.25	253.95	1,010.10
Mechanized	335.10	180.25	197.50	712.85
Labor	134.80	106.00	56.45	297.25
Materials	1,190.30	95.95	73.00	1,359.25
Production costs	1,660.20	382.20	326.95	2,369.35

The average stem diameter of the test plants was almost the same (1.03 cm in the treatment with 15–18 branches and 1.00 cm in the trees with 5–6 branches), (Table 2). Altogether, for the 10-year study period, there was a slight, but statistically significant predominance in the increase in stem thickness of the experimental plants formed with 15–18 branches over that of the standard treatment (5–6 branches). We consider that the stronger pruning had led to a better plant growth response in the trees formed with 15–18 branches characterized by greater leaf mass and a higher number and length of the annual shoots.

In the first year of measurement (2010), the height, the diameter of the crowns, and hence the volumes were equal (Table 3). In 2011, there was a tendency for a faster crown growth in the trees formed with 15–18 branches, which is explained by their larger leaf weight. These differences in crown size were also observed in 2013 and 2015, but were statistically significant only in 2015.

For the first time, the trees of both varieties yielded in 2009, producing from 3.1 to 3.9 kg/tree with a slight predominance of the standard (Table 4). In 2010, these tree yields doubled, maintaining the same trend, but less pronouncedly expressed. In 2011, the fruits obtained were three times more than in 2009 (from 9.8 to 10.8 kg/tree). However, in 2012 and 2013, this difference was variable. In 2014 and 2015, a larger quantity of fruit was harvested in the standard variant. The difference between the yields of the different variants was insignificant, but every year the trees of the standard treatment produced larger fruit quantities, which can be explained by the weaker pruning of the crown, hence the weaker tree growth.

Table 4. Average yield per tree, kg

Variety	Variant	2009	2010	2011	2012	2013	2014	2015
Erdi Böttermö	I	3.1	7.2	9.8	12.7	28.0	28.0	30.0
	IIst	3.9	7.8	10.8	13.8	26.8	28.6	31.0
	Sd				2.428	3.250	2.196	2.171
	f				0.196	0.131	9.444	0.245
	LSD 0.05				7.72	10.33	6.984	6.903

The average weight of the fruits shows a slight tendency opposite to that of the quantities of fruits obtained. Somewhat larger were the fruits of trees of variant I (15–18 branches), which is explained by the greater growth but a lower fruit yield from the trees. We also found that the annual climatic conditions had an impact on the size of the fruit.

Importantly, the annual climatic conditions during the period of study had a greater influence on the contents of dry matter, sugars, and acids in the fruit than the treatments with varying pruning intensity.

Laboratory analyses were carried out 3th year, revealing that the pruning aimed at forming the crown shape exerted no influence on the chemical composition of the leaves.

The data obtained and analyzed for the seven-year fruiting period (2009–2015) show that the gross output in value terms in the examined variants, broadly follows the tendency of changes of the average yield (Table 5). The gross output obtained for both variants is the highest in 2014. The average gross production is the largest for trees with 5–6 skeleton branches, 3,011.0 euro/ha, which is 3.5% higher than that of the trees formed with 15–18 skeletal branches.

The production costs required to grow a one-hectare sour cherry orchard of the studied variants ranged from 1,307.5 euro/ha for V1 in 2009 to 3,323.7 euro/ha for V2 in 2014 (Table 6). Since an identical cultivation technology was employed in the two treatments, their material costs were the same in the respective year, and the average for the period amounted to 292.4 euro/ha. The differences in labor costs are determined by the different average yields and the associated costs of harvesting additional fruit production. In 2010 and 2011, the labor costs were significantly higher than those in 2009 and 2012 due to the need to perform sanitary pruning in both variants. In the remaining years, the higher yields had an impact on the value of the production costs.

Table 5. Gross production, euro/ha

Variant	2009	2010	2011	2012	2013	2014	2015	Average for the period
V1	403.0	1,368.0	1,568.0	2,889.3	4,060.0	5,110.0	4,950.0	2,906.9
V2	507.0	1,482.0	1,728.0	3,139.5	3,886.0	5,219.5	5,115.0	3,011.0

Table 6. Production costs, euro/ha

Variant	Costs	2009	2010	2011	2012	2013	2014	2015	Average for the period
V1	Production	1,307.5	1,865.6	2,436.7	1,310.3	2,440.9	3,269.1	2,919.1	2,221.3
	Material	387.1	210.6	268.1	248.8	338.3	338.6	255.4	292.4
	Labor	920.4	1,655.0	2,168.6	1,061.5	2,102.6	2,930.5	2,663.8	1,928.9
V2	Production	1,345.0	1,903.2	2,493.7	1,381.5	2,363.1	3,323.7	2,997.7	2,258.3
	Material	387.1	210.6	268.1	248.8	338.3	338.6	255.4	292.4
	Labor	958.0	1,692.6	2,225.7	1,132.8	2,024.8	2,985.1	2,742.4	1,965.9

Table 2. Average stem diameter, cm

Variety	Variant	After planting	2006	2007	2008	2009	2010	2011	2012	2013	2014	2015	Growth
Erdi Bötermö	I	1.03	1.33	2.15	3.80	5.49	6.70	7.76	8.51	9,08	9.82	10.51	9.48
	II (standard)	1.00	1.28	2.18	3.79	5.39	6.65	7.43	8.24	8,79	9.58	10.20	9.20
	Sd								0.276	0.310	0.280	0.340	
	f								0.957	0.861	0.767	0.821	
	LSD 0.05								0.878	0.985	0.890	1.079	

Table 3. Crown size, m

Variety	Variant	2010			2011			2012			2013			2014			2015		
		Height, m	Diameter, m	Volume, m <sup>3</sup>	Height, m	Diameter, m	Volume, m <sup>3</sup>	Height, m	Diameter, m	Volume, m <sup>3</sup>	Height, m	Diameter, m	Volume, m <sup>3</sup>	Height, m	Diameter, m	Volume, m <sup>3</sup>	Height, m	Diameter, m	Volume, m <sup>3</sup>
Erdi Bötermö	I	1.99	2.02	2.12	2.23	2.40	3.36	2.58	2.33	3.66	2.84	3.02	6.78	2.71	3.22	7.35	2.64	3.35	7.75
	II (st)	1.99	2.02	2.12	2.18	2.26	2.91	2.64	2.30	3.65	2.76	2.84	5.82	2.82	3.13	7.23	2.74	3.09	6.84
	Sd								0.121	0.548		6.141	0.513		0.024	0.356		5.358	0.445
	f								6.119	5.466		8.832	3.254		13.740	5.064		23.095	4.918
	LSD 0.05								0.385	1.742		0.195	1.63		7.504	1.132		0.170	1.415



The magnitude of the average yields had a significant impact on the amount of the net income received. On average for the survey period, treatment V2 formed a higher net profit of 752.7 euro/ha (Fig. 1). Thus, the net income per hectare obtained was 8.9% higher than that of treatment V1. The profitability rate was 33.3% for the variant V2 (5–6 branches) and 30.9% for the V1 (15–18 branches).

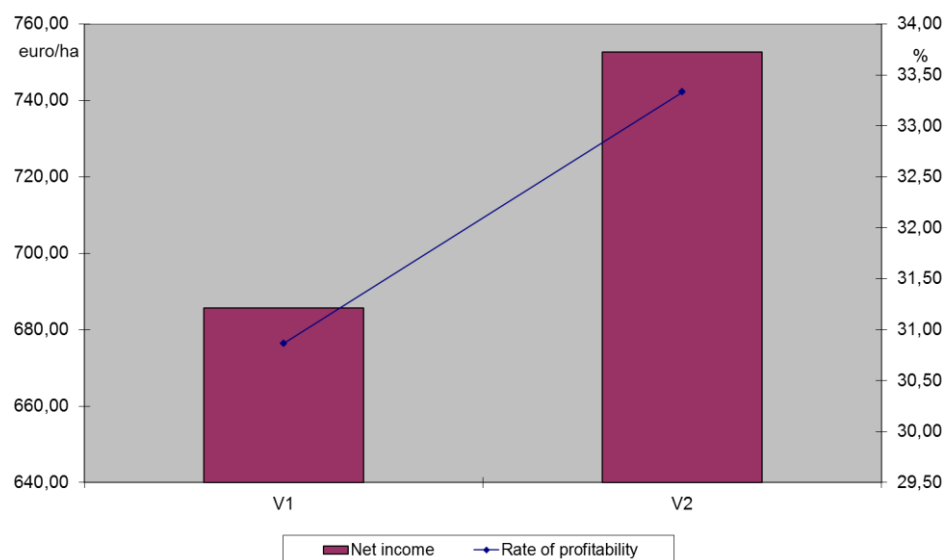


Fig. 1. Average net income (euro/ha) and rate of profitability (%) for the period 2009–2015

### Conclusions

The balance value per one hectare of sour cherry orchard amounts to 2,369.35 euro/ha. The free crown with 15–18 branches induces a more vigorous growth of Erdi Böttermö trees than the free crown with 5–6 skeletal branches. Furthermore, the crown with 5–6 skeletal branches initiates earlier and more abundant fruit-bearing than that with 15–18 branches. The more vigorous tree growth and yield increased are associated with the rise in the average weight of the fruit. This finding indicates that trees possess the potential for even higher fruit yields. The formation of the crown does not affect the contents of dry matter, sugars, and acids in the fruit as well as leaf chemical composition. The economic assessment of the experimental treatments confirmed that the crown with 5–6 skeletal branches produced higher economic results.

### References

- Bashev, Hr. (1990). Essence, content and reporting of pre-production costs in agriculture. *Economics and Management of Agriculture*, 2, 74-77.
- Vasilev, V., V. Georgiev, V. Belyakov (1982). Cherry and sour cherry. Plovdiv, Ed. "Hr.G. Danov".
- Koprivlenski, V., H. Krinkov (2002). Methodological Approaches for the Formation and Update of the Value of Perennial Plants. *Economics and Management of Agriculture*, 2, 41-47.
- Mitov P., T. Angelov, N. Dimov, G. Pepelyankov, D. Dyakov (1990). Fruit growing. *Zemizdat*, 375p.
- Saeva, S., Kukov, X. (1998). Economic efficiency at sour cherry according variety-rootstock combination. C: Proceedings of the Fourth Scientific and Practical Conference of

Young Scientists and Fruit Professionals with International Participation "Fruit Growing in Contemporary Conditions", Kyustendil, 74-77

Sotirov. D., I. Radomirska (2012). Production of sour cherries in the world and Bulgaria - state and trends. *Plant Sciences*, 49 (5), 33-39.

Zimbrek, T., Kero, K., Miljkovic, I. and Pavicic, N. (1995). Development and current problems in the production and sale of fruit in Croatia with particular regard to apple production. *Acta Hort. (ISHS)* 340: 403-408

## CORRELATION AND PATH-COEFFICIENT INTERACTION BETWEEN YIELD PARAMETERS AND CROP MANAGEMENT OF PEAS

Nidal SHABAN<sup>1</sup>, Kadhu EMAN<sup>2</sup>, Todorka MOKREVA<sup>3</sup>, Zeina EL SEBAALY<sup>4</sup>

<sup>1</sup>Department of Horticulture, Faculty of Agriculture, University of Forestry in Sofia, St “kliment ohridski”, 1797Sofia, Bulgaria

<sup>2</sup>Agricultural Academy Suhodolska 30Sofia 1517

<sup>3</sup>Faculty of Economics-Agricultural University Mendeleev12 Plovdiv 4000

<sup>4</sup>Lebanese University, Faculty of Agricultural Engineering and Veterinary Medicine, Dep. Horticulture, Beirut, Lebanon

\*Corresponding author: nidalshaban@abv.bg

### Abstract

Path-coefficient analysis is very important statistical technique that can be used to quantify the interrelationship of different yield components. It was applied to study the interaction of applied agronomic activities on productivity of mid-early Bulgarian garden peas *Pisum sativum* cv. Promethei seeking to minimize pesticide use and to maintain sustainable quality and quantity of yield, and to prevent underground water pollution caused by using Dual 930EK/930g/l-s (metachloras) minimized herbicide doses from vegetative herbicide Basagran-200g/l (Bentazon) and Fusillade-200g/l (Fluasifop-P-Butil). Data was collected from long years trials on plants treated with different combinations of foliar suspension fertilizer Lactofol<sup>®</sup> with insecticides and herbicides. Results showed that grain yield (0.997), dry matter of the grain (0.996), Chlorophyll "a" (0.993), Zn (0.992), N (0.991), grain/whole pod ratio (0.984), total nitrogen (0.982), K (0.975), weight of 50 grains (0.973) fresh weight of 50 beans (0.962), fertile pollen (0.961), plant density/ m<sup>2</sup> (0.873), the length of beans (0.871), sterile pollen (0.837) had positive impact on yield. Dry matter, grain yield, dry matter of grains, chla, N, weight of 50 pods, fertile pollen, and plant density/ m<sup>2</sup> showed positive direct and indirect effects on yield. Other factors such as sugars (0.797), chlorophyll “b” (0.739), and starch (0.620) had an indirect effect on total yield. Grain yield should be given prior attention in field pea improvement programmers due to its major influence on yield. This research gave valuable information about which steps of agro techniques needs more attention to enhance best quality and quantity of sustainable yield.

**Keywords:** Correlation; path-coefficient, garden peas, growth, yield.

### Introduction

Garden peas are highly valued crops worldwide with multiple uses in food consumption. Grain peas are highly nutritious and are rich in protein (27%), complex carbohydrates (42.65%), vitamins, minerals, dietary fibers and antioxidant compounds (Urbano *et al.*, 2003). Yields and production areas have increased during the last years (Shaban *et al.*, 2014). The total harvested area in Bulgaria is of 882 ha, with a total production of 17358 tonnes (FAOSTAT, 2014). One of the best methods to ensure high quantity and quality of garden peas is to apply new agro technical solutions while protecting ecosystems from pollution (Shaban, 2007). Grain yield of peas is a complex character and is the product of several contributing factors affecting yield directly or indirectly. Correlation analysis provides information about association of plant characters and therefore, leads to a directional model for yield prediction. Path coefficient analysis quantifies the interrelationships between different components in

their direct and indirect effects on grain yield (Aashfaq *et al.*, 2003).

In agricultural production, higher interaction between different parameters and the presence of contrasting developments in their effects on the yield is often not possible to separate the effects with significant impact on mathematical modeling- water efficiency and its contribution to the yield (Chowdhry *et al.*, 2000). Application of Path- analysis in determining the independent variables in the construction of production function allows to identify the most significant of them and the nature of their interaction in forming the productivity of individual plants (Jedynski, 2001) (Narwal *et al.*, 1999). Path- analysis has advantages in terms of assessment of the factors and influences the prognostic results than classical statistical methods. Production function analysis has advantages in the yield of agricultural crops not only because it allows establishing relationships but is also valued and key indicators such as average and marginal efficiency coefficient of elasticity and production rate alternative variables (Nayeem and Baig, 2003). It explores the dependence of the rate of change in volume of the factors forming yield (Steel and Torrie, 1984). For instance, on peas, it was found that plant height showed positive direct effect on seed yield and that No. of pods/plant is a highly reliable component for yield indications (Tiwari *et al.*, 2001; Singh *et al.*, 2001; Arya *et al.*, 2004; Singh J.D. and Singh I.P., 2005 and Singh J.D. and I.P. Singh 2006). In the same trend, Ceyhan *et al.* (2005) found that the correlation between seed yield with plant height, No. of pods/ plant and biological yield/plant and No. seeds/pod was highly significant and positive. Correlation studies showed that the grain yield was positive correlated with plant height, No. of pods/plant and No. of seeds/pod.

The present study was conducted in order to investigate the interrelationship of yield components and applied new techniques (mixed foliar fertilizer with decreased pesticide doses) and their contribution to yield of peas.

### **Material and Methods**

Data was collected through long years field trial with mid-early garden peas of the cultivar Promethei. Seeds were sown with the help of a tribler with a distance of 30 cm between rows and 5 cm between plants. The experimental design adopted was RCBD (Randomized Complete Block Design) with four replications. All agronomic practices were kept uniform. Plants were treated with different combinations of foliar suspensions fertilizer Lactofol® with insecticides and herbicides. At maturity, ten monitored plants were chosen from each replication for measuring the number of pods, number of grains per pods, grain weight per pod (g), weight of 50 pods(g) and grain yield per plant (g). Moreover, plant physiology was analyzed through three measurements of photosynthetic and transpiration intensity, and through analysis of photosynthetic pigments (chl.a, chl.b and carotenoids). Chemical composition of plants was evaluated by testing the micro and macro-nutrients contents. Weed density was monitored and recorded as well during the consecutive experimental years.

Correlation coefficients were calculated for fixing the degree of association of the different investigated parameters and pea yield as well as among themselves. Correlations were calculated based on Singh and Chaudray (1985) and path coefficient analysis was carried out as suggested by Dewey *et al.* (1955), Singh and Chaudray (1985), Soomro (2010) and Arbuckle (2009). Analysis was done using AMOS Ver. 18 Software.

### **Results and Discussion**

Results of correlations between the yield of green peas and each of the studied parameters of direct and indirect Path-factor are given in Table 1. The model of research indicated that the total impact of the studied indications on the yield of peas was variant and ranged between

strongly positive to strongly negative. The strongest overall positive impact on the yield of peas was exerted by the grain yield (5.4%) and the absolute dry matter content in whole pods (ACB\*) (5.4%) followed by dry matter of the grains (5.3%), Chla (5.3%), total Zn (5.3%), grain/pod rate (5.2%), total nitrogen (5.2%), total K (5.1%), weight of 50 grains (5.1%), weight 50 pods (5%), pollen fertility (5%), ACB B in grain (5%), plants/ m<sup>2</sup> (4.1%), length of pods (4.1%), pollen sterility (3.8%) and transpiration at third measurement E3 (3.6%). A lower significant effect on yield was observed for the parameters sugar content (3.4%), Chl.b (2.9%), E2 (2.9%), disorder post first treatment (2.6%) and starch content (2.1%). Finally, yield was also influenced by other factors (2.9%)

Table 1. Partial function of studied parameters on yield structure of green peas.

General variability of yield					
Partial function of studied parameters 97.1%. from:					
No		100.0	No		100.0
1	Plants/m <sup>2</sup>	4.1	12	Weight of 50 grains	5.1
2	Disorders post first treatment	2.6	13	Grain /pod rate	5.2
3	Absolute dry matter in whole pods ACB*	5.4	14	Absolute dry matter in grains ACB	5.0
4	Sugars	3.4	15	Pods length	4.1
5	Total nitrogen	5.2	16	Grain yield	5.4
6	Starch	2.1	17	Pollen fertility	5.0
7	Dry matter/ grain	5.3	18	Pollen sterility	3.8
8	N	5.3	19	E2- Transpiration at second measurement	2.9
9	K	5.1	20	E3 Transpiration at third measurement	3.6
10	Zn	5.3	21	Chla	5.3
11	Weight of 50 pods	5.0	22	Chlb	2.9
	Other factors: 2.9%				

Correlations in figure 1 reflected a moderate positive correlation between pollen fertility and weed density (0.4) as well as with weeds weight (0.58). On the other hand, total Ca was negatively correlated with those two parameters (-0.57 and -0.55 respectively).

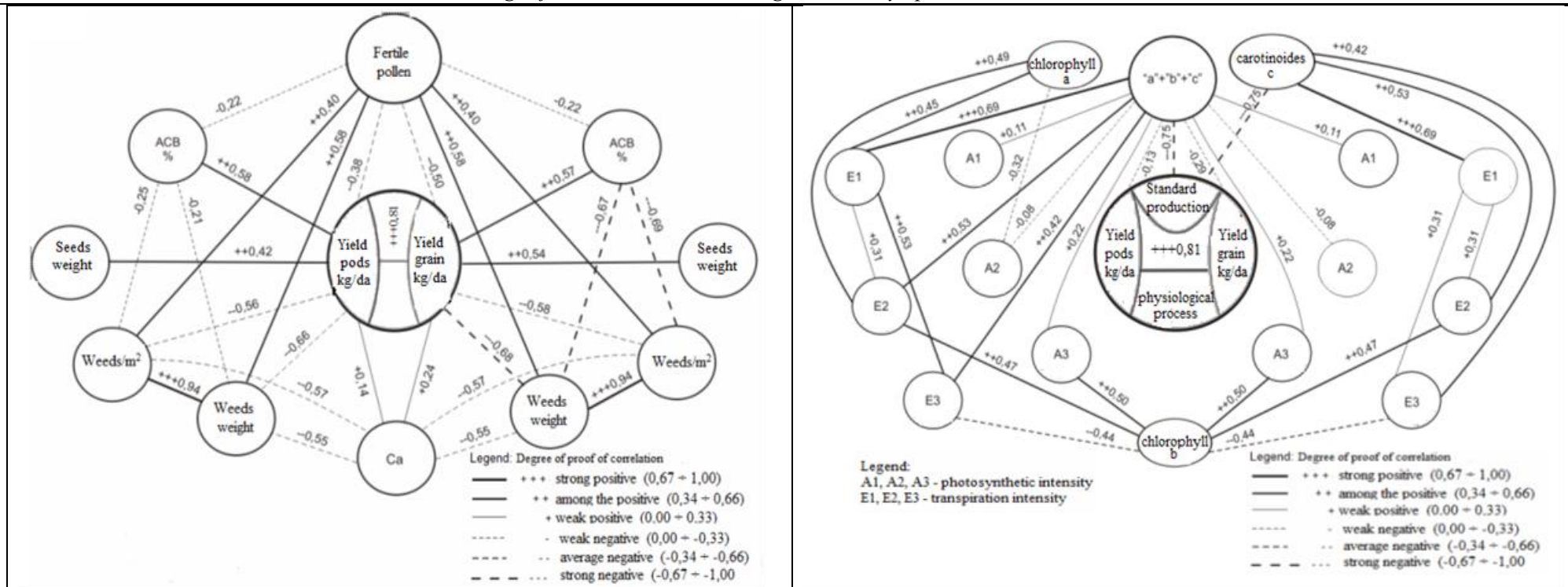
Results in figure 2 illustrated the existing correlations between physiological parameters and yield. When considering the physiological activity of plants it seemed that photosynthetic pigments (chl.a, chl.b and carotenoids) were positively correlated with transpiration rate and with photosynthetic intensity with some exceptions: chla was negatively correlated with A2 (-0.32) and chl. b was negatively correlated with E3 (-0.44). In general, correlations between photosynthetic pigments formation with transpiration intensity were stronger than those with photosynthetic intensity. For instance, the correlation coefficient of chl.a, chl.b and carotenoids (a+b+c) with E1 was +0.69 while with A1 it was of +0.11.

Moreover, the parameters ACB (%) had a strong positive influence on grain yield (0.62) and pods yield (0.58). Total Cu content had a strong positive influence on grain yield (0.51) and a weak positive influence on pods yield (0.27). In addition, total N and total Ca content had a weak positive influence on yield, while total P content showed an indirect positive influence (Fig. 3).

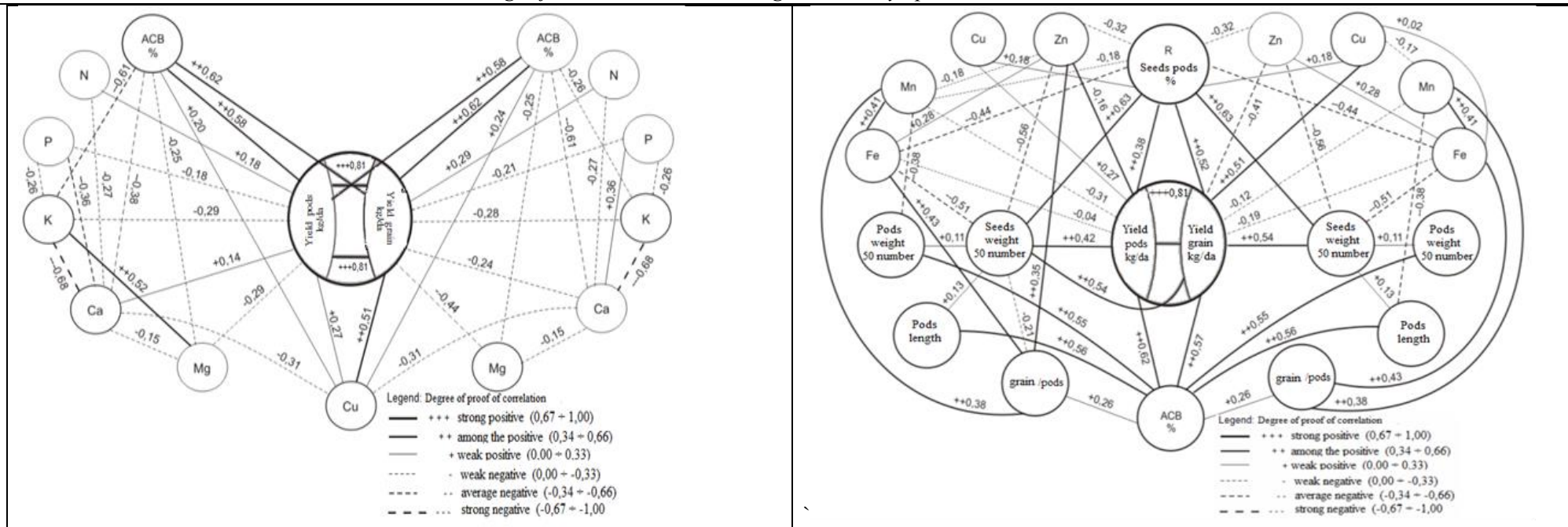
Results in the figure 4 showed that in general, pods characteristics such as the number of grains per pod, weight of 50 grains, and weight of 50 pods had always a strong direct positive influence on each other as well as on pods yield and grain yield consequently on productivity. For example, the weight of 50 seeds was positively correlated with grain yield and pods yields with 0.54 and 0.42 respectively. In addition, the figure 4 illustrated the direct and indirect

effects of different chemical parameters (Fe, Mn, Cu and Zn) on all the previously cited pods characteristics as well as on pods length. For instance, Zn, Fe and Mn had a moderate positive direct influence on number of grains per pods with respective correlation coefficients of 0.35, 0.43 and 0.38. On the other hand, Mn influenced directly and negatively the pods length (-0.38).

The figure 5 represented the correlation between the photosynthetic intensity, transpiration intensity, pollen viability, pods yield and grain yield. In specific, pollen fertility has a moderately direct positive influence on grain yield (0.5), and a moderately negative influence on pods yield (-0.38). Additionally, this parameter was negatively correlated with photosynthetic intensity (A1: -0.2 and A2: -0.35). On the contrary, pollen sterility was positively correlated to photosynthetic intensity (A1: 0.39 and A2: 0.45).



Impacts of treatment with Lactofol® and pesticides on correlation coefficients between yield and peas parameters (Fig 1: left) and between yield and plastid pigments content and photosynthetic and transpiration intensity (Fig 2: right)



Impacts of treatment with Lactofol® and pesticides on correlation coefficients between yield and biological values (Fig 3: left) and productivity parameters (Fig 4: right) of peas.



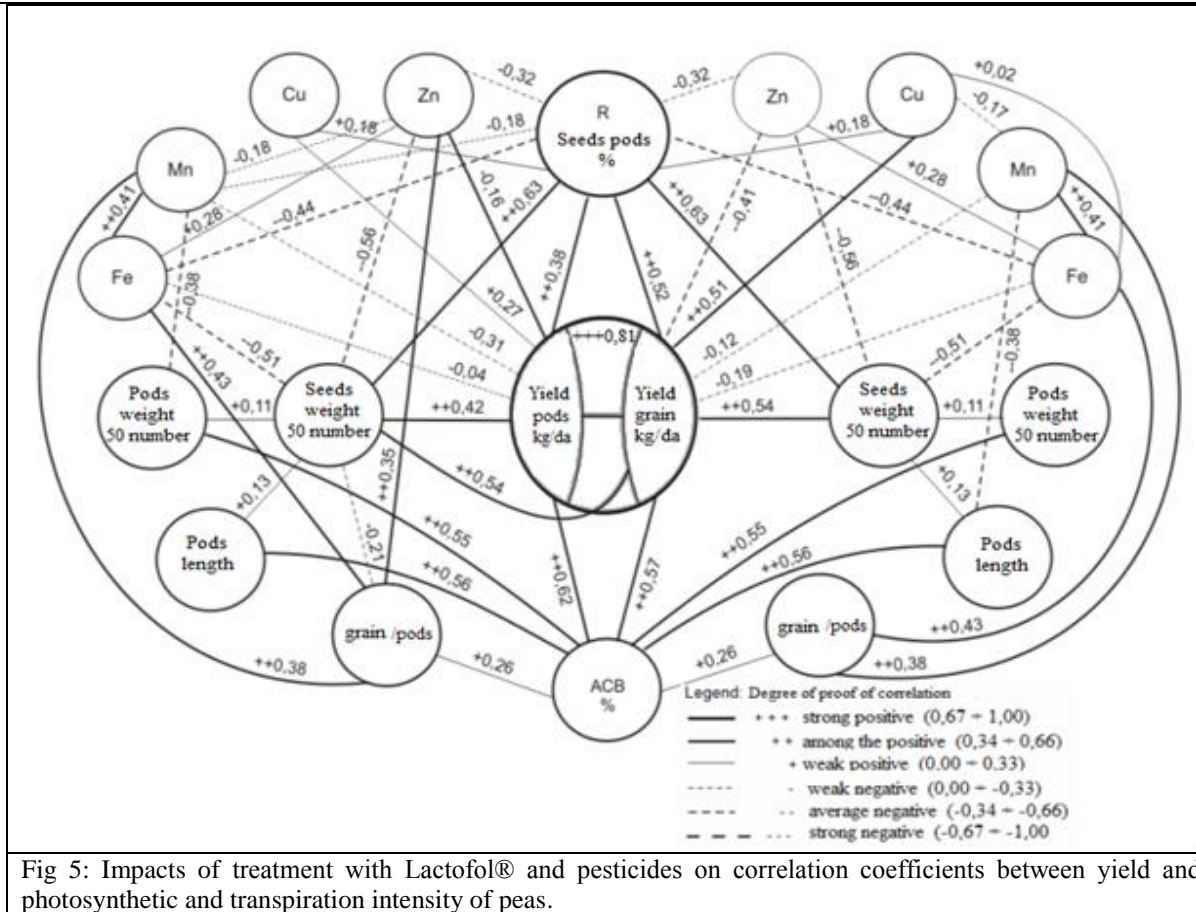


Fig 5: Impacts of treatment with Lactofol® and pesticides on correlation coefficients between yield and photosynthetic and transpiration intensity of peas.

Grain yield should be given prior attention in field pea improvement programmers because of its major influence on yield. Those results came in conformity with those of earlier studies where a positive association of seed weight and grain yield / plant was reported (Manhata *et al.*, 2001, Arya *et al.*, 2004, Singh V. and S.P. Singh, 1999, Singh J.D. and I.P. Singh, 2005, Gul *et al.*, 2005, Patel *et al.*, 2006). Also, it was found previously by Arya *et al.*, 2004, Singh J.D. and I.P. Singh, 2005) that No. of pods / plant exerted highest direct effect on seed yield in field pea. This indicates that No. of pods / plant is highly reliable component on yield. It was also found in the study of Sarawat *et al.* (1994) that there is significant positively correlation between grain yield with, No. of pods / plant and 100 seed weight in pea. No. of pods / plant were also reported to be positive correlated in pea

### Conclusions

The application of foliar suspension fertilizer Lactofol<sup>®</sup> combined with insecticides and herbicides has induced different effects of the studied parameters (morphological, physiological and reproductive) on the yield. In general, this type of treatment has amplified the effects of macro and micro-nutrients in plants, dry matter accumulation and those of pods characteristics on plant yields. Moreover, crop performance was more correlated to the transpiration intensity and less to the photosynthetic intensity while yields were the most affected by grain and pods productions. It seemed that the use of Lactofol had an indirect negative effect on photosynthetic pigments however it caused a direct beneficial impact on quantity and quality of the produce. Also, the negative correlation that was observed between weed incidence and yields could lead to the assumption that Lactofol might help controlling weeds while maintaining high quality yields. Also, the impact of post-treatment disorders on yields was lowered since results clearly demonstrated a low correlation between this parameter and yields.

Lactofol could be applied with decrease pesticide doses as a potential method in GAP (Good Agricultural Practices) as a new element of growing technology of green peas in order to reduce the excessive random application of chemicals, consequently to help sustaining the ecosystem by preventing underground water pollution.

### References

- Aashfaq M., Khan A.S. and Zulfiqar A. (2003). Association of morphological traits with grain yield in wheat. *Int. J. Agri. Biol.*, 5: 262–264.
- Arbuckle J. L, Amos 18 Users Guide, 2009. Amos Development Corporation. SPSS Inc., USA.ISBN-13:978- 1-56827-404-1, through (Analysis of Moment Structures) AMOS Ver. 18 Software.
- Arya S., B.P.S. Malik R. Kumar and R. Dhrai (2004). Variability, correlation and path analysis in field pea ( *Pisum sativum* L.). *J. Res. Harayana Agric. Univ.* 34:149-153.
- Ceyhan E. and M.A. Avci (2005). Combining Ability and Heterosis for Grain Yield and Some Yield Components in pea (*Pisum sativum* L.). *Pakistan Journal of Biological Sciences.* 8(10): 1447-1452.
- Chowdhry M.A., M. Ali, G.M. Subhani and I. Khaliq. (2000). Pathcoefficients analysis for water use efficiency, evapo–transpirationefficiency and some yield related traits in wheat at different microenvironments. *Environ. Ecol.*, 9: 906–10.
- Dewey D. R and K. M. Lu (1959). Correlation and path coefficient analysis of components of crested wheat grass seed production. *Agronomy J.* 51:515-518.
- Food and Agriculture Organization of the United Nations. (2014). FAOSTAT Database. FAO. Retrieved September 8, 2017, from: <http://www.fao.org/faostat/en/#data/QC>

- Gul I, M. Sumerli, B.T. Bicer and Y. Yilmaz (2005). Heritability and correlation studies in pea ( *Pisum arvense* L. ) Lines. *Asian J. Plant Sci*, 4:154-158.
- Jedynski S. (2001). Heritability and path coefficient analysis of yield components in spring wheat. *International journal of agriculture & biology*. 1560–8530/2004/06–1–138–142.<http://www.ijab.org>.
- Mahanta I.C, N. Senapati, K. Samal and A. Dhal (2001). Genetic variability performance, character association and coheritability in field pea ( *Pisum sativum* L. ). *Indian J. Agric. Sci.*, 24:92-96.
- Nayeem K.A. and K.S. Baig (2003). Correlation studies in durum wheat. *J. Res. Angrau.*, 31: 116–21.
- Narwal N.K., P.K. Verma and M.S. Narwal (1999). Genetic variability, correlation and path coefficient analysis in bread wheat in two climatic zones of Haryana. *Agric.Sci. Diget*.
- Patel P.J., N.H. Patel, B.H. Prajapati , S.B.S. Tikka and P.T. Patel. (2006). Correlation and path analysis in field pea. *Ind. J. Pulses Res*. 19:109-110.
- Sarawat P, F.L. Stoddard, D.R. Marshall and S.M. Ali (1994). Heterosis for yield and related characters in pea. *Euphytica*. 80:39-48.
- Shaban N. (2007). Agrobiological complex assessment of mixed application of pesticides with foliar fertilizer on growth and development of Tomato, French bean and peas. Doctor of Sciences Thesis Sofia 2007.
- Shaban N., Bistrechyanov S., Moscovia T., Eman K., Ivanka M., Miroslav T. and Pavel B.: 2014 Vegetable production of traditional crops.
- Singh R. K., and B. D. Chaudhary (1985). *Biometrical Methods in Quantitive Genetic Analysis*. Rev.ed, pp318, Kalyani publishers, Ludhiana, New Dlhi. India.
- Singh V. and S.P. Singh (1999). Vaiability and correlation studies in pea ( *Pisum sativum* L. ). *Ann. Agri. Bio Res*, 4:87-91
- Singh S.K. and S.B.L. Srivastava (2001). Comparison of direct and indirect effects of yield traits on yield in tall and dwarf genotypes of pea ( *Pisum sativum* L. ). *Indian Genet. Resour*, 14: 201-202.
- Singh J.D. and I.P. Singh (2005). Studies on correlation and path analysis in field pea ( *Pisum sativum* L. ). *Natl. J. Plant Improve*, 7:59-60.
- Singh J.D. and I.P. Singh (2006). Genetic variability, heritability, expected genetic advance and character association in field pea ( *Pisum sativum* L.). *Legume Res*, 29:65-67.
- Soomro Z. A. (2010). Estimation of Gene Action and Selection Parameters in Quantitative and Qualitative Traits of *Gossypium hirsutum* L, Ph.D. Thesis , Sindh Agriculture University, Through Department of Plant Breeding and Genetics , Faculty of Crop Production, Tandojam
- Steel R.G.D. and J.H. Torrie (1984). *Principles and Procedures of Statistic:McGraw-Hill*, 1997 - Mathematics - 666 pages.
- Tiwari, S.K, H.L. Singh, R. Kumar, H.K. Nigam and A.P. Singh, 2001. A postmortem of selection parameters in pea ( *Pisum sativum* L. ). *Res. Crops*, 2:237-242.
- Urbano G., Aranda P. and Gomez-Villalva E. (2003). Nutritional evaluation of pea (*Pisum sativum* L.) protein diets after mild hydrothermal treatment and with and without added phytase. *Journal of Agricultural and Food Chemistry*, 51: 2415-2420.

## BRIEF POMOLOGICAL DESCRIPTION OF PERSPECTIVE SWEET CHERRY ELITES (*PRUNUS AVIUM L.*)

Nicolai CHRISTOV, Simeon KRUMOV\*

Institute of agriculture – Kyustendil, 2500, Bulgaria

\*Corresponding author: sd\_krumov@abv.bg

### Abstract

It was performed a brief pomological description of sweet cherry elites № 32/25 (Van x Stela), № 5750 (Kordia x self-pollination), № 3419 (4C–1821 x self-pollination), № 5752 (Kordia x self-pollination), № 1890 (Germersdorf x self-pollination) and № 6374 (Stella x Germersdorf), created at Institute of agriculture - Kyustendil. It was found that all elites, except for № 1890, have later flowering compared to the standard Van. According to the duration of ripening, the studied elites belong to the following 2 groups: middle medium ripening (the second decade of June) - elites № 5752, № 6374, № 3419, № 1890, № 32/25 and late ripening (early July) - elite № 5750. The biometric analysis showed that all sweet cherry elites have large fruits. In the different elites the form of fruit is cordate to wide-cordate, with dark red to black color of the skin. The flavor of all elites is sweet-sour with the exception of elite № 3419 which taste is defined as a sour-sweet. The coloring of the fruit juice is pink in standard Van and elite № 1890 to ruby-red in elite № 5752. The results of the annually conducted tastings show that the researched sweet cherry elites in the region of Kyustendil have high taste qualities.

**Key words:** *Sweet cherry, Elites, Pomological description*

### Introduction

Sweet cherry (*Prunus avium L.*) is a fruit species with large ecological plasticity and is one of the main fruit crops in Bulgaria. A premise for this is the favorable soil and climatic conditions in the country.

For increase in the fruit yield, it is important to select a self-fertile, fruitful and highly resistant to diseases and stress conditions cultivars (Georgiev et al., 2001).

Intensive breeding work for the creation of new sweet cherry cultivars is conducted in all countries with well developed production of sweet cherry fruits in accordance with the contemporary quality requirements for the cultivars to be marketable, as well as with increased resistance to stress factors (Sansavini and Lugli, 2008; Kankaya et al., 2005; WangYulinq, 2002; Long et al., 2008; Kappel, et al., 2002; Grandi et al., 2013; Vercammen et al., 2008; Milatović et al., 2013). Worldwide have been created more than 140 perspective new sweet cherry cultivars over the past decade (Sansavini and Lugli, 2008).

As a result of intensive breeding work in the last years, in Bulgaria have been created and approved several sweet cherry cultivars such as Stefania, Daneliya, Dima, Alekston, Vasinika, Kosara, Rosita, Rozalina and others (Georgiev et al., 2001; Zhivondov et al., 2011; Christov et al., 2015). The purpose of this research is to make a brief pomological description of perspective sweet cherry elites, presented in different stages of selection good biological and economic properties.

## **Material and Methods**

The research was conducted during the period 2013-2015 at the experimental sweet cherry plantation of the Institute of Agriculture – Kyustendil in Bulgaria. The object of the study were elites № 32/25 (Van x Stela), № 5750 (Kordia x self-pollination), № 3419 (4C – 1821 x self-pollination), № 5752 (Kordia x self-pollination), № 1890 (Germersdorf x self-pollination), № 6374 (Stela x Germersdorf). The cultivar Van was used as control. The trees were planted in the spring of 2002 at distance of 6 x 5 m in the rows and formed in free growing crown. They are grafted on P. mahaleb rootstock IK-M9, grown without irrigation. Each sweet cherry elite was represented by 5 trees.

The soil in the experimental plantation is highly leached, slightly sandy clay, cinnamon forest soil with a neutral reaction. The availability of assimilable phosphorus is low to moderate, while the assimilable nitrogen is very low. The research of sweet cherry elites was performed according to the established methodology for the study of the plant resources in the fruit growing (Nedev et al., 1979). The taste evaluation of the fruits was done organoleptically on the 5-grade scale (Nedev et al., 1979).

The obtained experimental results were processed by the method of analysis of variance, using the LSD-test to prove statistical significance of the differences found between the control and the variants. The evaluation was made at levels of significance  $P < 0,05$ ,  $P < 0,01$  and  $P < 0,001$  (Maneva, 2007).

## **Results and Discussion**

The phenological observations showed that the beginning of full flowering occurred the earliest in the control Van and elite № 1890 (10.04) and the latest in elite № 5750 for the period of the survey (2013-2015). The beginning of the full flowering for the other elites began almost at the same time - from 14.04 to 15.04 (Table. 1).

The relatively later flowering is an advantage for the region in view of the fact, that the probability of passing the last spring frost in the five-day period from 7th to 11th April is 52% and from 12th to 16th April - 82%.

Depending on the climatic conditions, the phenophase varied from 12 to 16 days over the years, the earliest occurred in 2014 and the latest in 2015. According to the period of ripening of the fruits in the region of Kyustendil, the elites refer to the following groups: medium ripening - № 5752, № 6374, № 3419, № 1890 and № 32/25 (the second ten days of June) and late ripening - № 5750 (the first days of July). The standard cultivar Van refers to the group of medium ripening. During the period of investigation the cultivar Van ripened 2 to 4 days later than the other elites in the group (Table 1).

The harvest was done in a consumable maturity of the fruits, after which biometric and chemical analyses were performed (Table 2). It was found that the comparatively highest average mass of fruit exceeding the standard Van (7.4 g) had the elites № 6374 (8.5 g) and № 32/25 (7.5 g). The lowest value of the indicator had № 3419 (5.8 g). The rest elites took an intermediate position. The same trend was observed in relation to the size of the fruit. The largest diameter (measured in the widest part of the fruit) had the fruits of the elite № 6374 and № 32/25 (24.3 mm), and the smallest were of the standard cultivar Van (21.5 mm) (Table 2).

The average fruit mass was the highest in 2014, which we suggested was due to the heavy rainfalls during the fruit growing period. The other years were characterized by very high average air temperatures and prolonged droughts, which affected the size of the fruits.

The mechanical analysis showed that the average stone mass was approximately the same for all sweet cherry elites - from 0.22 g for the standard Van, № 5752 and № 3419 to 0.28 g for

№ 6374. The mass of the fruit stem is from 0.09 g in elites № 3419 and 5750 to 0.13 g in Van and № 5752 (Table. 2).

Table 1. Phenological observations of sweet cherry elites for the period 2013-2015

Sweet cherry elites	Year	Beginning of full flowering		Time of ripening	
		date	(+) or (-) days in comparison to „Van”	date	(+) or (-) days in comparison to „Van”
№ 32/25 (Van x Stela)	2013	17.04	+1	19.06	-4
	2014	06.04	+3	21.06	-1
	2015	22.04	+5	24.06	+1
	x*	14.04	+4	22.06	-2
№ 5752 (Kordia x self-pollination)	2013	19.04	+3	15.06	-8
	2014	07.04	+4	19.06	-3
	2015	22.04	+5	25.06	0
	x	15.04	+5	20.06	-4
M					
№ 5750 (Kordia x self-pollination)	2013	20.04	+4	30.06	+7
	2014	09.04	+6	04.07	+12
	2015	25.04	+8	06.07	+11
	x	17.04	+7	03.07	+9
№ 6374 (Stela x Germersdorf)	2013	17.04	+1	15.06	-8
	2014	07.04	+4	20.06	-2
	2015	21.04	+4	24.06	-1
	x	14.04	+4	20.06	-4
№ 1890 (Germersdorf x self-pollination)	2013	11.04	-5	22.06	-1
	2014	03.04	0	22.06	0
	2015	16.04	-1	23.06	-2
	x	10.04	0	22.06	-2
№ 3419 (4C – 1821 x self-pollination)	2013	18.04	+2	18.06	-5
	2014	06.04	+3	20.06	-2
	2015	22.04	+5	23.06	-2
	x	14.04	+4	21.06	-3
Van (standart)	2013	16.04	-	23.06	-
	2014	03.04	-	22.06	-
	2015	17.04	-	25.06	-
	x	10.04	-	24.06	-

\*average for the period

The sweet cherry elites № 6374 and № 32/25 statistically proven exceeded the control cultivar in terms of diameter of the fruit. Differences in other biometric indicators were insignificant. Under the experiment conditions, all sweet cherry elites had good fertility. The highest average yield per tree had elite № 5752 (32.8 kg), followed by № 1890 (31.7 kg). The lowest yield, average for the study period, was reported in № 6374 (22.7 kg). Elites № 32/25 (28,5 kg) and № 3419 (25.2 kg) also exceeded the value of the standard Van (24.0 kg).

The established differences to the control in terms of the average yield were positively proven in elites № 5752 and №1890. For the other elites, the differences were insignificant to the control.

The combination of sugars and acids in the fruit juice is very important for the quality of the sweet cherry fruits. The quantitative content of these chemical components is directly related to the biological properties of the cultivar and the weather conditions during the ripening period.

The average results of the chemical analysis showed that the soluble dry matter was the highest in the fruits of elite No 1890 - 20.1%. In the other studied elites, the dry matter content value was lower than the standard Van - 19.3%. The ratio is similar in terms of the total sugar content of the fruits. The highest percentage of total sugar had elite No 1890 - 10.1%, and the lowest had No 6374 - 7.7%.

The highest percentage of titratable acidity had the standard cultivar Van - 0.49%, followed by elite No 5752 - 0.46%. In the other elites titratable acidity was in the range from 0.37% in elite No 1890 to 0.44% in elites No 5750 and No 3419 (Table 2).

Table 2. Comparative biometric and chemical analysis of sweet cherry elites for the period 2013 - 2015

Sweet cherry elites	Year	Average fruit mass g	Average fruit diameter mm	Average stone mass g	Average fruit stem mass g	Average yield per tree kg	Chemical analysis		
							Dry matter Re, %	Sugars %	Titratable acids %
№ 32/25 (Van x Stella)	2013	7,6	24,8	0,27	0,11	18,7	19,6	9,22	0,44
	2014	8,1	25,1	0,26	0,12	27,3	16,5	7,90	0,33
	2015	6,7	22,9	0,25	0,13	39,5	16,0	8,31	0,42
	x*	7,5 <sup>n.s.</sup>	24,3 <sup>++</sup>	0,26 <sup>n.s.</sup>	0,12 <sup>n.s.</sup>	28,5 <sup>n.s.</sup>	17,4 <sup>n.s.</sup>	8,5 <sup>n.s.</sup>	0,39 -
№ 5752 (Kordia x self-pollination)	2013	6,4	23,0	0,21	0,13	28,8	16,2	7,37	0,55
	2014	7,0	23,3	0,23	0,14	22,8	17,7	9,18	0,37
	2015	5,5	19,8	0,22	0,11	46,7	17,2	8,48	0,45
	x*	6,3 <sup>n.s.</sup>	22,0 <sup>n.s.</sup>	0,22 <sup>n.s.</sup>	0,13 <sup>n.s.</sup>	32,8 <sup>++</sup>	17,0 <sup>n.s.</sup>	8,34 <sup>n.s.</sup>	0,46 <sup>n.s.</sup>
№ 5750 (Kordia x self-pollination)	2013	6,4	21,8	0,28	0,10	18,8	18,4	8,88	0,49
	2014	7,1	22,0	0,26	0,09	16,8	18,7	8,90	0,40
	2015	6,5	20,8	0,27	0,09	38,2	18,2	9,20	0,42
	x*	6,7 <sup>n.s.</sup>	21,5 <sup>n.s.</sup>	0,27 <sup>n.s.</sup>	0,09 <sup>n.s.</sup>	24,6 <sup>n.s.</sup>	18,4 <sup>n.s.</sup>	9,0 <sup>n.s.</sup>	0,44 <sup>n.s.</sup>
№ 6374 (Stella x Germersdorf)	2013	9,2	24,8	0,29	0,11	18,0	17,0	8,34	0,43
	2014	11,0	26,3	0,29	0,14	17,2	15,0	7,50	0,40
	2015	5,3	21,7	0,27	0,12	33,0	14,5	7,36	0,37
	x*	8,5 <sup>n.s.</sup>	24,3 <sup>++</sup>	0,28 <sup>n.s.</sup>	0,12 <sup>n.s.</sup>	22,7 <sup>n.s.</sup>	15,5 -	7,7 <sup>n.s.</sup>	0,40 -
№ 1890 (Germersdorf x self-pollination)	2013	6,3	22,4	0,24	0,09	33,5	19,8	10,3	0,40
	2014	7,0	23,6	0,23	0,11	21,2	19,5	9,15	0,32
	2015	5,4	21,4	0,24	0,10	40,3	21,0	10,7	0,39
	x*	6,2 <sup>n.s.</sup>	22,5 <sup>n.s.</sup>	0,24 <sup>n.s.</sup>	0,10 <sup>n.s.</sup>	31,7 <sup>++</sup>	20,1 <sup>n.s.</sup>	10,1 <sup>n.s.</sup>	0,37 --
№ 3419 (4C – 1821 x self-pollination)	2013	6,9	23,0	0,24	0,11	16,5	18,3	8,48	0,45
	2014	6,6	23,7	0,22	0,09	18,0	19,0	9,60	0,43
	2015	4,0	19,0	0,21	0,08	41,2	15,0	7,64	0,44
	x*	5,8 <sup>n.s.</sup>	21,9 <sup>n.s.</sup>	0,22 <sup>n.s.</sup>	0,09 <sup>n.s.</sup>	25,2 <sup>n.s.</sup>	17,4 <sup>n.s.</sup>	8,57 <sup>n.s.</sup>	0,44 <sup>n.s.</sup>
Van (standard)	2013	7,3	22,7	0,23	0,12	7,5	24,0	11,6	0,61
	2014	8,9	23,2	0,21	0,12	31,5	17,5	8,9	0,46
	2015	6,1	18,7	0,22	0,14	33,0	16,5	7,80	0,41
	x*	7,4	21,5	0,22	0,13	24,0	19,3	9,42	0,49
<i>F</i>		2,978873	6,598382	22,31218	4,43252	5,47521	2,1429	1,6875	2,8358
<i>SD</i>		0,759842	0,661168	7,834005	1,04907	2,38856	1,4857	0,8318	3,5027
<i>LSD 0,05</i>		1,656	1,441	1,707	2,285	5,207	3,238	1,813	0,0763

\*average for the period

Beside the content and the ratio of the chemical components, the appearance and the proportions of the fruits are also important for their quality - shape, dimensions and coloring of the skin. Different sizes, shape and coloring are preferred depending on the purpose of the fruits - for fresh consumption or for processing.

All investigated sweet cherry elites had large fruit. The shape of the fruit was from cordate to wide cordate, with dark-red to nearly-black colored skin. The taste of all of them was sweet-sour, with the exception of elite No 3419, which taste was defined as sour-sweet. The coloring of the fruit juice was from pink for Van and elite No 1890 to ruby red for No 5752 (Table 3).

The results of the annually conducted organoleptic degustations show that the studied sweet cherry elites in the Kyustendil region had high taste qualities. In the three years of study, the highest (maximum) taste qualities/properties had standard cultivar Van (5.0 grade) and the lowest - elite № 5750 (3.75). For the other cultivars, the organoleptic evaluation showed very high results - from 4.0 to 4.5 grades (Table 3).

Table 3. Shape and organoleptic qualities of the fruit in sweet cherry elites

Sweet cherry elites	Fruit shape	Flavor	Fruit skin color	Fruit flesh color	Fruit juice color	Organoleptic taste valuation (5 grade scale)
№ 32/25 (Van x Stella)	Wide cordate	Sweet-sour	Dark red	Pink-red	Wine red	4,5
№ 5752 (Kordia x self-pollination)	Cordate with round tip	Sweet-sour	Dark red to black	Dark red	Ruby-red	4,0
№ 5750 (Kordia x self-pollination)	Cordate	Sweet-sour	Dark red	Red	Light red	3,75
№ 6374 (Stella x Germersdorf)	Cordate	Sweet-sour	Dark red	Red	Red	4,0
№ 1890 (Germersdorf x self-pollination)	Cordate	Sweet-sour	Dark red to black	Pink	Pink	4,0
№ 3419 (4C – 1821 x self-pollination)	Wide cordate	Sour-sweet	Nearly black	Red	Dark red	4,5
<b>Van (standart)</b>	Wide cordate to spherical	Sweet-sour	Dark red	Pink	Pink	5,0

### Conclusions

The studied sweet cherries, except for elite № 1890, have a later flowering than the standard cultivar Van. According to the period of the ripening of the fruits in the region of Kyustendil, the elites refer to the following groups: medium-ripening - № 5752, № 6374, № 3419, № 1890 and № 32/25 (the second ten days of June) and late-ripening - № 5750 (the first days of July). All sweet cherry elites have good fertility. According to the adopted classification, they have large fruits. The shape of the fruit is from cordate to wide cordate, with dark-red to nearly-black colored skin. The taste is sweet-sour, with the exception of elite № 3419, which taste is defined as sour-sweet. The coloring of the fruit juice is from pink at Van and elite № 1890 to ruby red at № 5752. In consumable maturity, the sugar content of fruits in the studied elites is between 7.7% and 10.1% and titratable acidity - from 0.37% to 0.49%. Organoleptic taste evaluations show high results - from 3.75 grades for № 5750 to 5.0 grades for the standard Van.

### Acknowledgement

This article is published with the financial support of the Ministry of Education and Science /Fund "Scientific Research"/ - Contract DNTS/China 01/8/ 6.11.2014.

### References

Christov, N., Domozetov D., Borovinova M., et al. (2015), Sweet cherry. Brochure, Kyustendil, 20 p.



- Georgiev V., Borovinova M., Koleva A. (2001). Sweet cherry. Zemizdat, Sofia, 352 p.
- Grandi, M., Lugli S., Correale R. (2013). Fruit quality changes in postponed picking in new cherry cultivars. <http://www.ciliegio.unibo.it/images/stories/doc/poster2013/>.
- Kankaya, A., et al, (2005). Evaluation of some sweet cherry cultivars on Gi 5 and Gi 6 rootstocks in Bayramic, Turkey. 5 – th International Cherry Symposium - 8, Bursa, Tubitak, Abstracts - 17.
- Kappel, F., Toivonen P., McKenzie L., Stan S. (2002). Storage characteristics of new sweet cherry cultivars. *HortScience* 37 (1), 139 – 143.
- Long, L. E., Nunez-Elisea R., Cahn H. (2008). Evaluation of Sweet Cherr Cultivars and Advanced Selections Adapted to the Pacific Northwest, USA. *Acta Horticulturae*: 5 (vol 1), 255-259.
- Maneva S. (2007). Mathematical methods in plant protection. PhD Thesis, Sofia, 201 p.
- Milatović, D., Dejan P., Durović B., Dordević B., Vulić T., Zec G. (2013). Pomological properties of sweet cherry cultivars grafted on ‘Colt’ rootstock. *Journal of Agricultural Sciences*, 58, 1, 61-72.
- Nedev N., Grigorov I., Baev H., Serafimov S. (1979). Methodology for the study of plant resources in fruit plants. “Hr. G. Danov”, Plovdiv, Bulgaria, 151 p.
- Sansavini, S., Lugli S. (2008). Sweet cherry breeding programs in Europe and Asia. V International Cherry Symposium. *Acta Hort. (ISHS)* 795:41 - 58.
- Vercammen, J., Van Daele G., Vanrykel T. (2008). Testing of sweet cherry varieties in Belgium. 5 – th International Cherry Symposium, 463-468.
- Wang Y. (2002). Genetic resources of deciduous fruit and nut crops in China. China Agric. Sci. and Technology Press.
- Zhivondov, A., Malchev S., Tsareva I. (2011). Sensory profile and chemical components of fruits of sweet cherry cultivars and elites. *Plant science*, 48, 24 – 30.

## ALLELOPATHIC EFFECT OF SOME WEED SPECIES ON GERMINATION AND INITIAL DEVELOPMENT OF *LACTUCA SATIVA*

Ekaterina VALCHEVA<sup>1</sup>, Vladislav POPOV<sup>1</sup>, Plamen MARINOV-SERAFIMOV<sup>2</sup>, Irena GOLUBINOVA<sup>2</sup>, Bogdan NIKOLOV<sup>3</sup>, Iliana VELCHEVA<sup>3</sup>, Slaveya PETROVA<sup>3\*</sup>

<sup>1</sup>Department of Agroecology and Protection of Agroecosystems and Population, Agricultural University of Plovdiv, Plovdiv, Bulgaria

<sup>2</sup>Institute of Forage Crops, Plevan, Bulgaria

<sup>3</sup>Department of Ecology and Environmental Conservation, University of Plovdiv “Paisii Hilendarski”, Plovdiv, Bulgaria

\*Corresponding author: sl.petrova@abv.bg

### Abstract

Aim of this study was to evaluate the allelopathic effect of 10 invasive weeds in forage crops (*Abutilon theophrasti* Medik., *Amaranthus blitoides* S. Wats, *Amaranthus retroflexus* L., *Aristolochia clematidis* L., *Cirsium arvense* Scop. (L.), *Chenopodium album* L., *Matricaria perforata* Merat., *Setaria viridis* (L.) P. Beauv., *Sonchus arvensis* L. and *Sorghum halepense* (L.) Pers.) on the germination and the initial development of *Lactuca sativa* L. cultivar Great Lakes. Ex-situ experiment was carried out as follows: 20 ml (0.75%) agar were pipetted into Petri dishes and the dried weed biomass was added at concentrations 0.05, 0.1, 0.2, 0.4, 0.8% w/v. Samples were stored at  $18 \pm 2^\circ\text{C}$  for 72 h, then 10 seeds of test plant were placed into agar. Distilled water was used as a control. Samples were placed in a thermostat-operated device at  $22 \pm 2^\circ\text{C}$  for 5 days and the number of germinated seeds, % of germination against the control, length of the hypocotyl, root and seedling were measured. Index of plant development (GI) was calculated for assessment of the allelopathic effect of weeds on the early seedling growth and the initial development. Most pronounced inhibition on the seed germination and GI (especially of the radix) was found for *Matricaria perforata* and *Amaranthus retroflexus* where  $\text{LC}_{50}=0.2-0.4\%$  w/v and  $\text{LC}_{100}<0.8\%$  w/v. Allelopathic potential of *Cirsium arvense*, *Setaria viridis* and *Sorghum halepense* could be defined as weak as  $\text{LC}_{50}=0.5-0.8\%$  w/v and the lowest concentrations stimulated both germination and hypocotyl development.

**Keywords:** *allelopathy, weed management, Lactuca sativa, germination, initial development*

### Introduction

Weeds constantly accompany the crop plants and can lower crop productivity by 34% (Oerke, 2006) or cause significant damages which often exceed the total losses from the diseases and pests (Kubiszewski and Cleveland, 2012). Importance of weed control in forage production should not be overlooked, especially when the high investment cost associated with high production is considered. Weeds reduce forage yield by competing for water, sunlight, and nutrients. In addition to yield losses, weeds can also lower forage quality, increase the incidence of disease and insect problems, cause premature stand loss, and create harvesting problems. Some weeds are unpalatable to livestock or, in some cases, may be poisonous. Currently, most reliable weed control methods include herbicide application, mechanical weeding and hand weeding. Due to the evolution of herbicide resistance in weeds and their negative impacts on environmental, human and animal health, many authors revealed that diversity in weed management tools ensures sustainable weed control and reduces chances of

herbicide resistance development (Jabran *et al.*, 2015). In today's "organic farming", the integrated weed management systems are increasingly being applied, including allelopathic interactions between some plant species as an alternative method of weed control.

Along with its importance in natural ecosystems, allelopathy also has vast implications in agricultural systems. Various allelopathic interactions including weed-weed, weed-crop, and crop-crop have been observed. Because of the increased interest in various agricultural systems where plant interactions are critical, knowledge of allelopathy is a necessity. Allelopathic compounds are metabolites released from plants that might be beneficial or detrimental to the growth of receptor plants. These compounds are involved in the environmental complex of managed or natural ecosystems. Allelopathic compounds have been shown to play important roles in the determination of plant diversity, dominance, succession, and climax of natural vegetation and in the plant productivity of agroecosystems (Chou, 1999).

Aim of this study was to evaluate the allelopathic effect of 10 invasive weeds in forage crops (*Abutilon theophrasti* Medik., *Amaranthus blitoides* S. Wats, *Amaranthus retroflexus* L., *Aristolochia clematitidis* L., *Cirsium arvense* Scop. (L.), *Chenopodium album* L., *Matricaria perforata* Merat., *Setaria viridis* (L.) P. Beauv., *Sonchus arvensis* L. and *Sorghum halepense* (L.) Pers.) on the germination and the initial development of *Lactuca sativa* L. cultivar Great Lakes.

## Material and methods

### Collection and preparation of plant material

Aboveground biomass from ten invasive weed species (Table 1) in forage crops was collected in a natural environment of weed infestation in Institute of Forage Crops, Pleven at BBCH 51-55 (Hess *et al.*, 1997). No separated aboveground biomass of available weed species was chopped together to the length of 0.5-3.0 cm, drying to a constant dry weight at  $50 \pm 5^\circ\text{C}$  and was grind in grinder Retsch SM – 1 at a sieve size of 1.0 mm.

According to Macias *et al.* (2000) and Yasmin *et al.* (2011) the most commonly used test species in allelopathic bioassays is lettuce (*Lactuca sativa* L.). This species is considered to be an ideal screening agent due to a fast germination rate and a high sensory.

Table 1. Taxonomy of the experimental weed species and life cycle

№	Species name	Family	Class	Life cycle
1	<i>Abutilon theophrasti</i> Medik.	Malvaceae	Dicotyledonous	Annual
2	<i>Amaranthus blitoides</i> S. Wats	Amaranthaceae	Dicotyledonous	Annual
3	<i>Amaranthus retroflexus</i> L.	Amaranthaceae	Dicotyledonous	Annual
4	<i>Aristolochia clematitidis</i> L.	Aristolochiaceae	Dicotyledonous	Annual
5	<i>Cirsium arvense</i> Scop. (L.)	Asteraceae	Dicotyledonous	Perennial
6	<i>Chenopodium album</i> L.	Chenopodiaceae	Dicotyledonous	Annual
7	<i>Matricaria perforata</i> Merat.	Asteraceae	Dicotyledonous	Annual
8	<i>Setaria viridis</i> (L.) P. Beauv.	Poaceae	Monocotyledonous	Annual
9	<i>Sonchus arvensis</i> L.	Asteraceae	Dicotyledonous	Perennial
10	<i>Sorghum halepense</i> (L.) Pers.	Poaceae	Monocotyledonous	Perennial

### Experimental design

Ex-situ experiment was carried out as follows: 20 ml (0.75%) agar were pipetted into Petri dishes and the dried weed biomass was added at concentrations 0.05, 0.1, 0.2, 0.4, 0.8% w/v. Samples were stored at  $18 \pm 2^\circ\text{C}$  for 72 h, then 10 seeds of test plant were placed into agar according to the adapted method of Fujii *et al.* (2003) and Takemura *et al.* (2013). Distilled water was used as a control. Each treatment consisted of five replicates including the control treatment. Samples were placed in a thermostat-operated device at  $22 \pm 2^\circ\text{C}$  for 5 days and

the number of germinated seeds, % of seed germination against the control, length of the hypocotyl, root and seedling were measured.

#### Allelopathic effect assessment

Index of plant development (GI) was calculated for assessment of the allelopathic effect of weeds on the early growth and the initial development of the root, hypocotyl and seedling. It was determined by the equation of Gariglio *et al.* (2002):

$$GI = \left[ \left( \frac{G}{G_0} \right) \times \left( \frac{L}{L_0} \right) \right] \times 100$$

where  $G$  and  $G_0$  – seed germination (%) in each treatment and in the control, respectively;  $L$  – average length (mm) of the root, hypocotyl and seedling in experimental treatment, respectively, transformed into percentage as against the control treatment;  $L_0$  – average length (mm) of the radix, hypocotyl and seedlings in the control treatment considered as 100%.

Percentage of seed germination was calculated after preliminary arcsin-transformation following the formula  $Y = \arcsin \sqrt{(x\%/100)}$ , forwarded by Hinkelman and Kempthorne (1994), and to induce half-maximal inhibition of growth ( $LC_{50}$ ) and  $P=0.05$  confidence intervals were calculated according to Hamilton *et al.* (1977).

All collected data were analyzed using the software Statgraphics Plus for Windows Ver. 2.1 and Statistica Ver. 10.

### Results and discussion

Allelopathic effect of the tested ten invasive weeds in forage crops on *L. sativa* cultivar Great Lakes varied according to the plant species and the concentration applied (Table 2).

Percentage of seed germination decreased in all experimental treatments with the increment of the weed concentration (from the 0.05 to 0.8 % w/v), the differences being statistically significant at  $P=0.05$ . Stimulatory effect on the germination process (103.6 % against the control) were found for *A. blitoides* and *A. clematitis* at 0.05 % w/v concentration; for *C. arvensis*, *S. viridis* and *S. halepense* at two lowest weed concentrations (0.05 and 0.1 % w/v); and also for *S. arvensis* at 0.05, 0.1, 0.2 and 0.4 % w/v weed biomass in the media.

Most weak pronounced was the inhibitory effect of *S. viridis* and *A. theophrasti* where the  $LC_{50} > 0.8$  % w/v was found. Strongest inhibition exhibited *M. perforata* with  $LC_{50}=0.1-0.2$  % w/v and  $LC_{100}=0.4-0.8$  % w/v, followed by *A. retroflexus* ( $LC_{50}=0.2-0.4$  % w/v and  $LC_{100}=0.4-0.8$  % w/v), *A. clematitis*, *C. arvensis* and *Ch. album* ( $LC_{50}$  and  $LC_{100}$  were in the range 0.4-0.8 % w/v).

Negative effect on the seed germination could be explained by the presence of the glycol alkaloids, tannins and other active substances in the weed biomass which exerted strong toxicity on the test plant. At higher concentrations they had a lethal effect on the seeds of *L. sativa* whereas at lower concentrations they inhibited the germination process at a different extent (Agarwal *et al.*, 2002). Differences in the inhibitory effect could be explained both by the biological characteristics of the studied weed species and the diffusion of the soluble allelochemicals from the dried weed biomass into the agar media (Sangeetha and Bascar, 2015).

Data for the length of the root, hypocotyl and seedling (mm) had a great importance for objective assessment of the differences at the initial developmental stages of the test plant depending on the weed species and the weed concentration (Table 2). Depressive effect of the ten studied weed species on the growth of seedlings in all experimental treatments as compared to the control treatment was found. Length decrement was most pronounced at higher concentration and the differences were statistically significant at  $P=0.05$ . Stimulatory effect was observed for the hypocotyl growth in the experimental treatments with 0.05 and 0.1 % w/v of *C. arvensis*, *S. viridis* and *S. halepense*.

Table 2. Allelopathic effect of ten studied weed species on the seed germination, growth and initial development of *Lactuca sativa* L. cultivar Great Lakes

Allelopathic effect of weeds (concentrations of weed biomass in % w/v: 0.05, 0.1, 0.2, 0.4 and 0.8) on <i>Lactuca sativa</i> properties: lengths (mm) of root (A), hypocotyl (B) and seedling (C); seed germination (C%) against the control (D); index (%) of plant development (GI) of the radix (E), hypocotyl (F) and seedling (G)										
	0.05	0.1	0.2	0.4	0.8	0.05	0.1	0.2	0.4	0.8
	<i>Abutilon theophrasti</i> Medik.					<i>Amaranthus blitoides</i> S. Wats				
<b>A</b>	6.00c	2.44b	2.88b	1.50a	1.00a	3.80bc	4.11c	3.50abc	2.00a	2.33ab
<b>B</b>	14.33d	9.56c	7.50bc	6.75b	3.60a	12.50c	14.89cd	11.33bc	7.75ab	4.00a
<b>C</b>	20.33d	12.00c	10.38ab	8.25b	4.60a	16.30c	19.00c	14.83bc	9.75ab	6.33a
<b>D</b>	85.3	82.4	73.4	74.0	51.8	103.6	85.3	58.5	45.1	38.1
<b>E</b>	33.5	13.2	13.8	7.3	4.0	25.8	23.0	13.4	5.9	5.6
<b>F</b>	69.9	45.0	31.5	28.6	12.5	74.0	72.6	37.9	20.0	8.4
<b>G</b>	52.9	30.2	23.3	18.6	8.5	51.5	49.5	26.5	13.4	7.1
	<i>Amaranthus retroflexus</i> L.					<i>Aristolochia clematitis</i> L.				
<b>A</b>	6.56c	4.44b	4.63b	3.00b	0.00a	3.20c	2.56c	1.63b	1.50b	0.00a
<b>B</b>	11.67c	16.33b	12.13c	6.00b	0.00a	6.50d	4.33c	2.88b	2.67b	0.00a
<b>C</b>	18.22cd	20.78d	16.75c	9.00b	0.00a	9.70cd	6.89d	4.50c	4.17b	0.00a
<b>D</b>	85.3	85.3	73.4	38.1	0.0	103.6	85.3	73.4	58.5	0.0
<b>E</b>	36.6	24.8	22.3	7.5	0.0	21.7	14.3	7.8	5.7	0.0
<b>F</b>	56.9	79.6	50.9	13.1	0.0	38.5	21.1	12.1	8.9	0.0
<b>G</b>	47.4	54.1	37.5	10.5	0.0	30.7	17.9	10.1	7.4	0.0
	<i>Cirsium arvense</i> Scop. (L.)					<i>Chenopodium album</i> L.				
<b>A</b>	12.63d	6.00c	4.30b	2.75ab	1.14a	4.33d	3.67d	2.14c	1.00b	0.00a
<b>B</b>	20.25c	17.80c	13.90b	9.25a	6.86a	15.89e	13.00d	9.43c	2.71b	0.00a
<b>C</b>	32.88d	23.80c	18.20b	12.00a	8.00a	20.22e	16.67d	11.57c	3.71b	0.00a
<b>D</b>	103.6	103.6	73.4	65.5	0.0	85.3	85.3	65.5	65.5	0.0
<b>E</b>	70.5	40.7	29.2	13.2	5.7	24.2	20.5	9.2	4.3	0.0
<b>F</b>	98.7	105.4	82.3	38.8	30.1	77.5	63.4	35.3	10.1	0.0
<b>G</b>	85.6	75.2	57.5	26.9	18.8	52.6	43.4	23.1	7.4	0.0
	<i>Matricaria perforata</i> Merat.					<i>Setaria viridis</i> (L.) P. Beauv.				
<b>A</b>	12.67d	6.75c	4.25b	2.33ab	0.00a	7.60b	7.70b	4.44a	3.33a	3.00a
<b>B</b>	17.78d	12.63c	9.50b	7.67b	0.00a	17.50b	18.90b	10.00a	8.67a	10.14a
<b>C</b>	30.44d	19.38c	13.75b	10.00b	0.00a	25.10b	26.60bc	14.44a	12.00a	13.14a
<b>D</b>	85.3	73.4	45.1	38.1	0.0	103.6	103.6	85.3	82.4	65.5
<b>E</b>	70.8	32.5	12.6	5.8	0.0	51.5	52.2	24.8	18.0	12.4
<b>F</b>	86.7	53.0	24.5	16.7	0.0	103.6	111.9	48.8	40.8	36.7
<b>G</b>	79.4	43.5	19.0	11.6	0.0	79.5	84.2	37.7	30.2	25.4
	<i>Sonchus arvensis</i> L.					<i>Sorghum halepense</i> (L.) Pers.				
<b>A</b>	8.30b	6.80bc	5.40b	3.00a	2.00a	8.50c	4.70b	3.22ab	2.83ab	1.25a
<b>B</b>	14.70bc	14.20b	12.50b	8.30a	5.25a	20.60d	19.10d	13.33c	9.67b	5.25a
<b>C</b>	23.00c	21.00bc	17.90b	11.30a	7.25a	29.10d	23.80c	16.56b	12.50b	6.50a
<b>D</b>	103.6	103.6	103.6	103.6	45.1	103.6	103.6	85.3	58.8	44.8
<b>E</b>	56.3	46.1	36.6	20.3	5.7	57.7	31.9	18.0	10.9	3.5
<b>F</b>	87.0	84.1	74.0	49.1	13.1	122.0	113.1	65.0	32.5	13.0
<b>G</b>	72.8	66.5	56.7	35.8	9.7	92.0	75.2	43.1	22.4	8.6

Inhibition of the root and hypocotyl growth was strongest at the 0.4 % w/v of *Ch. album* reaching up to 93% and 84%, respectively. Inhibitory effect of the ten weed species on the root length was obvious than on the hypocotyl length. Similar results were obtained by Al Hamdi *et al.* (2001), Inderjit and Streibig (2001), and Belz and Hurle (2004) who reported that the root had the highest sensitivity to allelochemicals and its length is more affected than shoot growth. Root length may be a key parameter to verify allelopathic strength. Higher inhibition of roots compared with shoots may be due to their more intimate contact with the allelochemicals in the agar media.

Index of plant development (GI) showed that although the relatively high LC<sub>50</sub> value (0.4-0.8 w/v) *A. clematidis* exerted very strong allelopathic effect on the early growth and the initial development of the root, hypocotyl and seedling of test plant (61-79% inhibition) even at low concentration (0.05% w/v). Similar results were found also for *A. retroflexus* where the inhibition was between 43 and 63%. Our data confirmed the findings of Ali *et al.* (2013), Takemura *et al.* (2013), Baličević *et al.* (2015) that the effect of the allelochemicals is manifested already during the seed germination but it is more pronounced during the growth and accumulation biomass of seedlings of the test-plants.

### Conclusion

Most pronounced inhibition on the seed germination and the initial plant development (especially of the radix) was found for *Matricaria perforata* Merat. and *Amaranthus retroflexus* L. where LC<sub>50</sub>=0.2-0.4% w/v and LC<sub>100</sub><0.8% w/v. Allelopathic potential of *Cirsium arvense* Scop. (L.), *Setaria viridis* (L.) P. Beauv. and *Sorghum halepense* (L.) Pers. could be defined as weak as LC<sub>50</sub>=0.5-0.8% w/v and the lowest concentrations stimulated both germination and hypocotyl development.

### References

- Agarwal A., Gahlot A., Verma R., Rao P. (2002). Effects of weed extracts on seedling growth of same varieties of wheat, *Journal of Environmental Biology*, Vol. 23 (№1), pp. 19-23.
- Al Hamdi B., Inderjit-Olofsdotter M., Streibig J.C. (2001). Laboratory Bioassay for Phytotoxicity: An Example from Wheat Straw, *Agronomy Journal*, Vol. 93, pp. 43-48.
- Ali H.H., Tanveer A., Nadeem M.A., Javaid M.M., Kashif M.S., Chadhar A.R. (2013). Allelopathic effects of *Rhynchosia capitata* on germination and seedling growth of mungbean, *Planta Daninha*, Vol. 31 (№3), pp. 501-509.
- Baličević R., Ravlić M., Mišić M., Mikić Iv. (2015). Allelopathic effect of *Aristolochia clematidis* L. Proceedings. In: 50th Croatian and 10th International Symposium on Agriculture, Opatija, Croatia, 2015, pp. 54-58.
- Belz R.G., Hurlle K. (2004). A novel laboratory screening bioassay for crop seedling Allelopathy, *Journal of Chemical Ecology*, Vol. 30, pp. 175-198.
- Chou C.H. (1999). Roles of Allelopathy in Plant Biodiversity and Sustainable Agriculture, *Critical Reviews in Plant Sciences*, Vol. 18 (№5), pp. 609-636.
- Fujii Y., Parvez S., Parvez M., Ohmae Y., Iida O. (2003). Screening of 239 medicinal plant species for allelopathic activity using the sandwich method, *Weed Biology and Management*, Vol. 3 (№ 4), pp. 233-241.
- Gariglio N. F., Buyatti M., Pillati R., Gonzales R. D., Acosta. M. (2002). Use a germination bioassay to test compost maturity of willow (*Salix* sp.) sawdust, *New Zealand Journal of Crop of Horticultural Science*, Vol. 30, pp. 135-139.
- Hamilton M., Russo R., Thurston R., Spearman-Karber T. (1977). Method for Estimating Median Lethal Concentrations in Toxicity Bioassays, *Environmental Science and Technology*, Vol. 11 (№ 77), pp. 714-719.
- Hess M., Barralis G., Bleiholderà H., Buhr L., Eggers T.H., Hack H., Stauss R. (1997). Use of the extended BBCH scale general for the descriptions of the growth stages of mono- and dicotyledonous weed species, *Weed Research*, Vol. 37 (№ 6), pp. 433-441.
- Hinkelman K., Kempthorne O. (1994). Design and analysis of experiments. Vol. I: Introduction to experimental design, New York: John Wiley and Sons. Inc., pp. 495.

- Inderjit M.O., Streibig J.C. (2001). Wheat (*Triticum aestivum*) interference with seedling growth of perennial ryegrass (*Lolium perenne*) of density and age, *Weed Technology*, Vol. 15, pp. 807-812.
- Jabran K., Mahajan G., Sardana V., Chauhan B.S. (2015). Allelopathy for weed control in agricultural systems, *Crop Protection*, Vol. 72, pp. 57-65.
- Kubiszewski I., Cleveland C. (2012). United Nations Conference on Environment and Development (UNCED), Rio de Janeiro, Brazil, Retrieved from <http://www.eoearth.org/view/article/156773>.
- Macias F.A., Castellano D., Molinillo J.M.G. (2000). Search for a standard phytotoxic Bioassay for allelochemicals: selection of a standard target species, *Journal of Agricultural and Food Chemistry*, Vol. 98, pp. 2512-2521.
- Oerke E.C. (2006). Crop losses to pests, *Journal of Agricultural Sciences*, Vol. 144, pp. 31-43.
- Sangeetha C., Baskar P. (2015). Allelopathy in weed management: A critical review, *African Journal of Agricultural Research*, Vol. 10 (№ 9), pp. 1004-1015.
- Takemura T., Sakuno E., Kamo T., Hiradate S., Fujii Y. (2013). Screening of the Growth-Inhibitory Effects of 168 Plant Species against Lettuce Seedlings, *American Journal of Plant Sciences*, Vol. 4 (№ 5), pp. 1095-1104.
- Yasmin A., Akram A., Fayyaz-Ul-Hassan. Naeem M. Sh., Saqib M. (2011). Preliminary screening of some higher plants for evaluation of their allelopathic potential, *Crop & Environment*, Vol. 2 (№ 2), pp. 52-59.

## INFLUENCE OF FOLIAR ANTIBROADLEAVED HERBICIDES ON LENGTH OF THE PRIMARY ROOT OF COTTON SEEDS (*GOSSYPIUM HIRSUTUM* L.)

Teodora BARAKOVA<sup>1\*</sup>, Grozi DELCHEV<sup>2</sup>, Neli VALKOVA<sup>1</sup>

<sup>1</sup>Field Crops Institute, 6200, Chirpan, Bulgaria

<sup>2</sup>Department of Plant Production, Faculty of Agriculture, Trakia University, 6000 Stara Zagora, Bulgaria

\*Corresponding author: [tedi\\_mendeve@abv.bg](mailto:tedi_mendeve@abv.bg)

### Abstract

The trial was carried out during 2013-2015, comprising twelve cotton cultivars - Chirpan-539, Helius, Trakia, Viki, Filipopolis, IPK-Veno, Boyana, Avangard, Natalia, Darmi, Dorina and Nelina (*Gossypium hirsutum* L.). Influence of herbicides Bazagran 480 SL (bentazone), Pulsar 40 (imazamox) and Express 50 SX (tribenuron-methyl) was studied. These herbicides were used during the budding stage of cotton. The herbicide Bazagran 480 SL has the highest phytotoxicity on the length of the primary root of seeds of the cotton cultivar Trakia and the lowest on the cultivar Natalia. The herbicide Pulsar 40 has the highest phytotoxicity on the length of the primary root of seeds of the cotton cultivar Dorina and the lowest on the cultivars IPK-Veno and Natalia. The herbicide Express 50 SX has the highest phytotoxicity on the length of the primary root of seeds of the cotton cultivar Boyana and the lowest on the cultivar Helius. From the aspect of cotton growing technology, technologically the most valuable are cultivars Viki, Filipopolis, IPK-Veno, Boyana, Avangard, Natalia, Darmi, Dorina and Nelina by foliar treatment with herbicide Bazagran 480 SL. Technologically the most valuable are cultivars Chirpan-539, Helius, Viki, IPK-Veno, Boyana and Natalia by foliar treatment with herbicide Pulsar 40. Technologically the most valuable are cultivars Helius and Trakia by foliar treatment with herbicide Express 50 SX. These variants combine high lengths of the primary root and high stability of this index during the different years.

**Key words:** *Cotton, Herbicides, Foliar treatment, Cultivars, Length of primary root*

### Introduction

Cotton is a crop that is characterized by long growing season and weak competitive capacity to weeds. Therefore, it is highly sensitive to weeding still in the earliest stages of its development (Ashok et al., 2006).

Problem in contemporary farming is secondary weed infestation of crop (Boz, 2000; Bukun, 2004). The competition of weeds leads to a decrease in the cotton plants height, the number and length of the fruit twigs, the number of boxes per plant and the yield (Salimi et al., 2006). In the application of the herbicide during the growing season of the cotton often a manifestation of phytotoxicity, this affects the growth and development, yield, quality of the fiber and the crop properties of the seed of crop (Barakova and Delchev, 2016). When applying herbicides to combat annual weeds during cotton growing, a phytotoxic effect on cotton and a reduction in September yield (Stoychev et al., 2010). Cotton plants show symptoms of damage in the application of the herbicide Staple (pyrithiobac-sodium) for the control of annual broadleaf weeds during cotton vegetation (Vargas and Wright, 1994) The fight against secondary weed infestation is extremely difficult and must look for new approaches and herbicides technology for growing cotton, which are efficacy and selective to crop (Gao et al., 2005).



The aim of this research is to investigate the effect of foliar antibroadleaved herbicides on the length of the primary root of the seeds from different cotton cultivars (*Gossypium hirsutum* L.).

### Materials and methods

The trial was carried out during 2013-2015, comprising twelve cotton cultivars - Chirpan-539, Helius, Trakia, Viki, Filipopolis, IPK-Veno, Boyana, Avangard, Natalia, Darmi, Dorina and Nelina (*Gossypium hirsutum* L.). Influence of herbicides Bazagran 480 SL (bentazone) – 1.5 l/ha, Pulsar 40 (imazamox) – 1.2 l/ha and Express 50 SX (tribenuron-methyl) 50 g/ha was studied. These herbicides were used during the budding stage of cotton. It was investigated herbicides Bazagran 480 SL (bentazone), Pulsar 40 (imazamox) and Express 50 SX (tribenuron-methyl). They are treated during budding stage of cotton. The experiment was conducted under the block method, in 4 repetitions; the size of the crop plot was 20 m<sup>2</sup>. The foliar herbicides were treated after the herbicidal combination Dual gold 960 EC (S-metholahlor) – 1.2 l/ha + Goal 2 E (oxifluorfen) – 1.2 l/ha, which is applied after sowing before emergence for controlling of primary weed infestation in cotton. Spraying is done with a knapsack sprayer with a working solution 300 l/ha. It was investigated the length of the primary root of cotton seeds. The seeds were taken from the 12 cotton cultivars treated during the vegetation with the respective herbicides. It was accounted is the length of the primary root on 7<sup>th</sup> day. The math processing of the data was done according to the method of analyses of variance (Shanin 1977; Barov, 1982; Lidanski 1988). The stability of herbicides and cultivars for length of the primary root with relation to years was estimated using the stability variances  $\sigma_i^2$  and  $S_i^2$  of Shukla (1972), the ecovalence  $W_i$  of Wricke (1962) and the stability criterion  $YS_i$  of Kang (1993).

### Results and discussion

The herbicide Bazagran 480 SL applied during cotton vegetation, mean for the investigated period, has the highest phytotoxicity on the length of the primary root of the seeds from cultivar Trakia (Table 1). At this herbicides is measured at the lower value of the indicator compared to the other cultivars – 5.5 cm. The lowest is the action of Bazagran on cultivar Natalia – 8.4 cm. This is due to the smaller phytotoxicity of the herbicide on the root length of this cultivar. Cultivar Trakia is characterized as the most sensitive to the herbicide Bazagran 480 SL and variety Natalia - the most resistant to this herbicide.

The herbicide Pulsar 40 has the highest phytotoxicity on the length of the primary root of the seed from cultivar Dorina – 3.5 cm. Of the tested cultivars it is defined as the most sensitive to this herbicide. Cultivars IPK-Veno and Natalia have the biggest length of the primary root compared to the other cultivars, respectively – 6.7 cm and 6.6 cm. Pulsar influence the less on this indicator on these cultivars.

The herbicide Express 50 SX has the highest phytotoxicity on the length of the primary root of the seed from cultivar Boyana – 3.5 cm. Cultivar Helius has the biggest length of the primary root – 7.4 cm. Express influence the less on this indicator on this cultivar. Cultivar Boyana is the most sensitive to this herbicide in terms of the length of the primary root.

Analysis of variance for length of the primary root of cotton seeds (Table 2) shows that the herbicides have influence on the primary root – 9.1 % on the variants. The reason for this is the phytotoxic action of some of the herbicides. The strength of influence of years is 6.7 % and the strength of influence cultivars is 7.8 %. The influence of years, of cultivars and of herbicides is very well proven at  $p \leq 0.01$ . There is an interaction between herbicides and meteorological conditions of years (AxB) – 4.8 %, between cultivars and meteorological

conditions of years (AxC) – 11.3 %, and between cultivars and herbicides (BxC) – 22.7 %. They are very well proven at  $p \leq 0.1$ . There is interaction between three experiment factors (AxBxC) – 35.9 %. It also is very well proven at  $p \leq 0.1$ .

Table 1. Length of the primary root, cm (2013-2015).

Herbicides	Cultivars	2013	2014	2015	Mean
Bazagan	Chirpan-539	3.5	10.3	3.4	5.7
	Helius	5.5	5.4	6.5	5.8
	Trakia	5.5	5.4	5.8	5.5
	Viki	5.5	5.7	8.1	6.4
	Filipopolis	6.0	8.1	6.2	6.8
	IPK-Veno	6.0	9.3	3.9	6.4
	Boyana	6.0	5.9	7.1	6.3
	Avangard	7.0	7.4	6.3	6.9
	Natalia	8.2	8.7	8.2	8.4
	Darmi	6.0	6.2	6.0	6.1
	Dorina	7.0	6.3	7.3	6.9
	Nelina	6.0	7.0	5.4	6.1
Pulsar	Chirpan-539	6.0	5.1	7.0	6.0
	Helius	6.0	5.8	6.4	6.1
	Trakia	6.0	6.1	4.3	5.5
	Viki	6.4	6.4	5.4	6.1
	Filipopolis	7.3	7.4	2.9	5.9
	IPK-Veno	7.6	7.7	4.9	6.7
	Boyana	6.8	6.9	4.8	6.2
	Avangard	6.3	6.4	3.0	5.2
	Natalia	7.6	7.7	4.5	6.6
	Darmi	6.2	6.3	4.7	5.7
	Dorina	4.1	2.2	4.1	3.5
	Nelina	6.0	2.3	6.5	4.9
Express	Chirpan-539	5.5	5.6	4.9	5.3
	Helius	6.2	9.8	6.2	7.4
	Trakia	7.2	7.3	5.4	6.6
	Viki	6.0	6.2	2.5	4.8
	Filipopolis	5.5	5.6	4.9	5.3
	IPK-Veno	5.8	3.3	5.8	5.0
	Boyana	3.6	3.3	3.6	3.5
	Avangard	5.2	4.2	5.2	4.9
	Natalia	5.8	5.9	4.2	5.3
	Darmi	5.8	5.8	5.1	5.6
	Dorina	5.7	4.5	5.7	5.3
	Nelina	5.6	5.5	4.7	5.3

LSD, cm:

F.A	$p \leq 5\% = 0.08$	$p \leq 1\% = 0.1$	$p \leq 0.1\% = 0.2$
F.B	$p \leq 5\% = 0.08$	$p \leq 1\% = 0.1$	$p \leq 0.1\% = 0.2$
F.C	$p \leq 5\% = 0.1$	$p \leq 1\% = 0.2$	$p \leq 0.1\% = 0.3$
AxB	$p \leq 5\% = 0.1$	$p \leq 1\% = 0.2$	$p \leq 0.1\% = 0.3$
AxC	$p \leq 5\% = 0.3$	$p \leq 1\% = 0.4$	$p \leq 0.1\% = 0.5$
BxC	$p \leq 5\% = 0.3$	$p \leq 1\% = 0.4$	$p \leq 0.1\% = 0.5$
AxBxC	$p \leq 5\% = 0.5$	$p \leq 1\% = 0.7$	$p \leq 0.1\% = 0.9$

Table 2. Analyses of variance for length of the primary root.

Source of variation	Degrees of freedom	Sum of squares	Influence of factor, %	Mean square
Total	215	480.6	100	-
Tract of land	1	0.02	0.1	0.02
Variants	107	472.7	98.3	4.4***
Factor A - Years	2	32.3	6.7	16.1***
Factor B - Herbicides	2	44.0	9.1	22.0***
Factor C - Cultivars	11	37.6	7.8	3.4***
AxB	4	23.2	4.8	5.8***
AxC	22	54.1	11.3	2.5***
BxC	22	109.3	22.7	5.0***
AxBxC	44	172.4	35.9	3.9***
Pooled error	107	7.8	1.6	0.1

\* $p \leq 5\%$     \*\* $p \leq 1\%$     \*\*\* $p \leq 0.1\%$

Based on proven herbicide x year interaction and cultivar x year interaction, it was evaluated stability parameters for each variant for length of the primary root of cotton seeds with relation to years (Table 3). It was calculated the stability variances  $\sigma_i^2$  and  $S_i^2$  of Shukla, the ecovalence  $W_i$  of Wricke and the stability criterion  $YS_i$  of Kang.

Stability variances ( $\sigma_i^2$  and  $S_i^2$ ) of Shukla, which recorded respectively linear and nonlinear interactions, unidirectional evaluate the stability of the variants. These variants which showed lower values are considered to be more stable because they interact less with the environmental conditions. Negative values of the indicators  $\sigma_i^2$  and  $S_i^2$  are considered 0. At high values of either of the two parameters -  $\sigma_i^2$  and  $S_i^2$ , the variant are regarded as unstable. At the ecovalence  $W_i$  of Wricke, the higher are the values of the index, the more unstable is the variant.

On this basis, using the first three parameters of stability, it is found that by foliar treatment with herbicide Bazagran 480 SL stable are cultivars Avangard and Natalia. By treatment with herbicide Pulsar 40 stable is cultivar Viki, and by treatment with herbicide Express 50 SL stable are cultivars Chirpan-539, Filipopolis, Darmi and Nelina. Other variants have high instability - values of stability variance  $\sigma_i^2$  and  $S_i^2$  of Shukla and ecovalence  $W_i$  of Wricke are the highest and mathematically proven. The reason for this high instability is greater variation in lengths of the primary roots during years of experience as weather conditions affect those most. At part of them there is instability from linear and nonlinear type - proven values  $\sigma_i^2$  and  $S_i^2$ . At another part of them, instability is a linear type - proven values  $\sigma_i^2$ , the values of  $S_i^2$  are not proven.

To evaluate the complete efficacy of each herbicide should be considered as its effect on length of the primary root of cotton seeds and its stability - the reaction of cotton to this variant during the years. Valuable information about the value of technologic value of the variant give the stability criterion  $YS_i$  of Kang for simultaneous assessment of length of the primary root and stability, based on the reliability of the differences in yield and variance of interaction with the environment. The value of this criterion is experienced that using nonparametric methods and warranted statistical differences we get a summary assessment aligning variants in descending order according to their economic value.

Generalized stability criterion  $YS_i$  of Kang, taking into accounts both the stability and value of length of the primary root gives a negative assessment of cultivars Avangard, Dorina and Nelina, treated by Pulsar 40, and Viki, IPK-Veno, Boyana, Avangard, Natalia and Dorina treated by Express 50 SX. They are characterized as the most unstable and with low values.

Table 3. Stability parameters for the variants for length of the primary root with relation to years.

Herbicides	Cultivars	$\bar{x}$	$\sigma_i^2$	$S_i^2$	$W_i$	$YS_i$
Bazagran	Chirpan-539	5.7	28.2**	36.6**	53.5	7
	Helius	5.8	2.4**	-0.04	4.6	9
	Trakia	5.5	0.9**	-0.06	1.8	4
	Viki	6.4	7.6**	0.5**	14.5	23+
	Filipopolis	6.8	1.8**	3.6**	3.7	27+
	IPK-Veno	6.4	11.1**	6.0**	21.3	22+
	Boyana	6.3	2.6**	-0.03	5.2	20+
	Avangard	6.9	-0.07	-0.02	0.06	37+
	Natalia	8.4	0.1	0.1	0.5	39+
	Darmi	6.1	0.2*	-0.03	0.7	18+
	Dorina	6.9	1.8**	0.2	3.6	28+
Nelina	6.1	0.3*	0.5**	0.8	22+	
Pulsar	Chirpan-539	6.0	4.1**	0.2	7.9	13+
	Helius	6.1	1.2**	-0.05	2.4	14+
	Trakia	5.5	0.5**	0.02	1.2	3
	Viki	6.1	-0.05	-0.01	0.08	22+
	Filipopolis	5.9	9.3**	0.8**	17.7	12
	IPK-Veno	6.7	2.6**	0.2	5.1	26+
	Boyana	6.2	1.0**	0.07	2.1	19+
	Avangard	5.2	4.4**	0.4*	8.7	-4
	Natalia	6.6	3.8**	0.3*	7.3	24+
	Darmi	5.7	0.3*	0.01	0.8	11
	Dorina	3.5	4.4**	2.8**	8.4	-10
Nelina	4.9	14.9**	10.1**	28.3	-6	
Express	Chirpan-539	5.3	-0.08	-0.06	0.03	9
	Helius	7.4	6.8**	10.3**	13.0	30+
	Trakia	6.6	0.7**	0.04	1.5	25+
	Viki	4.8	5.4**	0.3*	10.5	-7
	Filipopolis	5.3	-0.08	-0.06	0.03	9
	IPK-Veno	5.0	6.7**	4.9**	12.8	-5
	Boyana	3.5	0.7**	0.06	1.4	-9
	Avangard	4.9	1.8**	0.7**	3.7	-8
	Natalia	5.3	0.4**	0.01	1.0	-1
	Darmi	5.6	-0.07	-0.03	0.04	12
	Dorina	5.3	2.3**	1.1**	4.5	-2
Nelina	5.3	-0.01	0.02	0.08	5	

None of these cultivars receive negative evaluation by foliar treatment with herbicide Bazagran 480 SL. According to this criterion, the most valuable technologically appears cultivars Viki, Filipopolis, IPK-Veno, Boyana, Avangard, Natalia, Darmi, Dorina and Nelina by foliar treatment with herbicide Bazagran. The most valuable technologically appears cultivars Chirpan-539, Helius, Viki, IPK-Veno, Boyana and Natalia by foliar treatment with herbicide Pulsar. Cultivars Helius and Trakia have the highest evaluation by foliar treatment with herbicide Express. They combine relatively high lengths of the primary root of cotton seeds with high stability during the different years of the investigation.

## Conclusions

The herbicide Bazagran 480 SL has the highest phytotoxicity on the length of the primary root of seeds of the cotton cultivar Trakia and the lowest on the cultivar Natalia.

The herbicide Pulsar 40 has the highest phytotoxicity on the length of the primary root of seeds of the cotton cultivar Dorina and the lowest on the cultivars IPK-Veno and Natalia.

The herbicide Express 50 SX has the highest phytotoxicity on the length of the primary root of seeds of the cotton cultivar Boyana and the lowest on the cultivar Helius.

From the aspect of cotton growing technology, technologically the most valuable are cultivars Viki, Filipopolis, IPK-Veno, Boyana, Avangard, Natalia, Darmi, Dorina and Nelina by foliar treatment with herbicide Bazagran 480 SL. Technologically the most valuable are cultivars Chirpan-539, Helius, Viki, IPK-Veno, Boyana and Natalia by foliar treatment with herbicide Pulsar 40. Technologically the most valuable are cultivars Helius and Trakia by foliar treatment with herbicide Express 50 SX. These variants combine high lengths of the primary root and high stability of this index during the different years.

## References

- Ashok Y. (2006). Integrated control of weeds in cotton. *Environment and Ecology* 24 S (Special 3A), 883-885.
- Barakova T., Delchev, Gr. (2016). Selectivity and stability of vegetation-applied herbicides at cotton (*Gossypium hirsutum* L.). *Agricultural Science and Technology*, vol. 8, № 2, 121-126, pp , 2016.
- Barov, V. (1982). Analysis and schemes of the field experience. NAPO, Sofia, p. 668.
- Boz O. (2000). Determination of weed flora, distribution and density of weed species occurring in cotton growing in Aydin. *Turkey herbology dergisi*, vol.3, 10-16.
- Bukun B. (2004). Critical periods or weed control in cotton in Turkey. *Weed Research*, vol. 44, 404-412.
- Gao X. H. (2005). The effect of different mixed herbicides in controlling weeds. *China Cotton* vol. 32, 19-23.
- Kang M. (1993). Simultaneous selection for yield and stability: Consequences for growers. *Agronomy Journal*, 85: 754-757.
- Lidanski, T. 1988. *Statistical methods in biology and agriculture*, Sofia, p. 376.
- Salimi H. (2006). Determination of the critical period of weed control in cotton fields (*Gossypium hirsutum* L.). *Applied Entomology and Phytopatology*, vol. 74 (1), 35-37
- Shanin, Yo. (1977). *Methodology of the field experience*. BAS, p. 384.
- Shukla G. (1972). Some statistical aspects of partitioning genotype - environmental components of variability. *Heredity*, 29: 237-245.
- Stoychev D., Dimitrova, M., Dimova, D. (2010). Effects of Various Herbicides on Early – Ripeness and Yield of Cotton. BALWOIS – Ohrid, Republic of Macedonia, 25-29 May.
- Vargas R., Wright, S. (1994). Nightshade control with phrithiobace (Staple) in California. *Proceedings Beltwide Cotton Conferences*, San Diego, California, USA, 1689-1691.
- Wricke G. (1962). Über eine Methode zur Erfassung der ökologischen Streubreite in Feldersuchen. *Pflanzenzuecht*, 47: 92-96.

## **INFLUENCE OF SOME HERBICIDES AND THEIR MIXTURES WITH GROWTH REGULATOR AND FOLIAR FERTILIZER ON COTTON SEED GERMINATION (*GOSSYPIUM HIRSUTUM* L.)**

Teodora BARAKOVA<sup>1\*</sup>, Grozi DELCHEV<sup>2</sup>, Neli VALKOVA<sup>1</sup>

<sup>1</sup>Field Crops Institute, 6200, Chirpan, Bulgaria

<sup>2</sup>Department of Plant Production, Faculty of Agriculture, Trakia University, 6000 Stara Zagora, Bulgaria

\*Corresponding author: [tedi\\_mendeva@abv.bg](mailto:tedi_mendeva@abv.bg)

### **Abstract**

The trial was carried out during 2013-2015, comprising two cotton cultivars – Helius and Darmi (*Gossypium hirsutum* L.). Herbicides Goal 2 E (oxifluorfen), Linuron45 SC (linuron), Wing P (pendimethalin + dimethenamid), Merlin 750 WG (izoxaflutole), Bazagran 480 SL (bentazone) were studied. These herbicides were used alone or in combinations with the growth regulator Amalgerol premium or the foliar fertilizer Lactofol O during the budding stage of cotton. The foliar treatment with tank mixtures Wing P + Amalgerol and Wing P + Lactofol lead to the highest seed germination in case of the cultivar Helius. The foliar treatment comprising the herbicide Bazagran or the tank mixture Bazagran+ Lactofol leads to the highest seed germination in case of the cultivar Darmi. The highest phytotoxicity on seed germination of the cultivar Helius was recorded after using the herbicide Merlin and the tank mixture Goal+ Amalgerol. The highest phytotoxicity on seed germination of the cultivar Darmi was recorded after using the herbicide Linuron and its tank mixtures with Amalgerol and Lactofol. From the aspect of cotton growing technology, technologically the most valuable are combinations of all herbicides with Lactofol, which are followed by Linuron + Amalgerol, Wing + Amalgerol, Merlin + Amalgerol and sole use of herbicide Bazagran on cultivar Helius. Technologically the most valuable are herbicides Goal and Bazagran and tank mixtures Goal + Amalgerol, Merlin + Amalgerol, Bazagran + Amalgerol, Wing + Lactofol and Bazagran + Lactofol on cultivar Darmi. These variants combine high lengths of the seed germination and high stability of this index during the different years. The sole use of the herbicides Linuron and Merlin has low assessment and should be avoided.

**Key words:** *Cotton, Herbicides, Foliar fertilizer, Growth regulator, Seed germination*

### **Introduction**

Cotton is one of the most valuable crops for Bulgaria. At cotton growing weed control is critical to the yield and quality of production. Problem in contemporary farming is secondary weed infestation of crop. Critical periods of weed infestation in cotton are from 1-2 weeks of cotton germination to the 11<sup>th</sup>-12<sup>th</sup> week of the cotton development (Bukun, 2004), from the appearance of first fruit-bearing twig until the end of flowering (Salimi et al. 2006) and the second true leaf stage to budding stage (Stoychev, 2013). There is often phytotoxicity by the application of herbicides during the cotton growing season (Ashok et al., 2006). Phytotoxicity slows growth and development of cotton plants, reduces structural elements of yield and decreases cotton yield, degrades fiber quality (Barakova and Delchev, 2016; Barakova, 2017). The fight against secondary weed infestation is extremely difficult and must look for new approaches and herbicides which exhibit excellent selectivity in technology for cotton growing.

The aim of this research is to investigate the influence of foliar herbicides and tank mixtures with growth regulator and foliar fertilizer on cotton seed germination on two cotton cultivars - Heliuss and Darmi (*Gossypium hirsutum* L.).

### Materials and methods

The trial was carried out during 2013-2015, on leached vertisol soil type, with two cotton cultivars – Heliuss and Darmi (*Gossypium hirsutum* L.). The experiment was conducted under the block method, in 4 repetitions; the size of the crop plot was 20 m<sup>2</sup>.

Herbicides Goal 2 E (oxifluorfen) - 800 ml/ha, Linuron45 SC (linuron) - 2 l/ha, Wing P (pendimethalin + dimethenamid) - 4 l/ha, Merlin 750 WG (izoxaflutole) - 50 g/ha, Bazagran 480 SL (bentazone) - 1.5 l/ha were studied. These herbicides were used alone or in combinations with the growth regulator Amalgerol premium - 8 l/ha or the foliar fertilizer Lactofol O - 5 l/ha during the budding stage of cotton. The foliar herbicides were treated after the herbicidal combination Dual gold 960 EC (S-metholahlor) – 1.2 l/ha + Goal 2 E (oxifluorfen) – 1.2 l/ha, which is applied after sowing before emergence for controlling of primary weed infestation in cotton. Spraying is done with a knapsack sprayer with a working solution 300 l/ha. Weeds in the economic control are removed by hoeing - 3 times during cotton vegetation.

It was investigated the seed germination of cotton. The seeds were taken from the 2 cotton cultivars treated during the vegetation with the respective herbicides and tank mixtures. It was accounted is the length of the primary root on 7<sup>th</sup> day.

The math processing of the data was done according to the method of analyses of variance (Shanin 1977; Barov, 1982; Lidanski 1988). The stability of herbicides and cultivars for seed germination with relation to years was estimated using the stability variances  $\sigma_i^2$  and  $S_i^2$  of Shukla (1972), the ecovalence  $W_i$  of Wricke (1962) and the stability criterion  $YS_i$  of Kang (1993).

### Results and discussion

All herbicides reduced laboratory seed germination on cultivar Heliuss. This is due to their phytotoxic action these herbicides have on cotton plants. Laboratory germination is decreased by the Goal + Lactofol O, Merlin + Lactofol O and Bazagran + Lactofol O (Table 1). They are accounted values lower than that of the economic control – 92.5 %. The highest phytotoxic effect on the laboratory germination has herbicide Merlin 750 WG - 84.0 %, and herbicidal herbicide combinations Goal + Amalgerol, Merlin + Amalgerol, Bazagran + Amalgerol, mixture Goal + Amalgerol - 82.5 %. The other herbicide combinations do not affect the values of the index. The biggest laboratory seed germination is obtained by use of Wing P + Amalgerol - 98.2 % and Wing P + Lactofol O - 97.8 %. The reason for this is that the growth regulator Amalgerol and foliar fertilizer Laktofol reduce phytotoxic effects of the herbicide Wing P in cultivar Heliuss.

All herbicides reduced the laboratory seed germination of cultivar Darmi too, due to their phytotoxicity on this cultivar. Laboratory germination is decreased by all herbicides and herbicide combinations compared with that of economic control – 96.5 %. In cultivar Darmi growth regulator Amalgerol and foliar fertilizer Laktofol not reduce phytotoxic effects of either of the herbicides. The highest phytotoxic effect on the laboratory germination has herbicide Linuron 45 SC – 79.2 % and herbicidal mixture Linuron + Amalgerol – 78.3 % and Linuron + Lactofol O – 82.7 %. The biggest laboratory seed germination is obtained by use of Bazagran 480 SL – 96.0 % and Bazagran + Lactofol O – 95.0 %. Bazagran has the weakest phytotoxicity on seed germination. All herbicides applied alone have a phytotoxic effect on laboratory germination of the seeds of the two cotton cultivars. All herbicide combinations

with foliar fertilizer Lactofol O have bigger seed germination combinations compared with that of sole used herbicides. Lactofol O reduces the phytotoxic effect of the herbicides on this index. Growth regulator Amalgerol reduces phytotoxicity on laboratory seed germination only of herbicides Linuron 45 SC, Wing P and Merlin 750 WG on cultivar Helius.

Table 1. Laboratory seed germination, % (2013-2015).

Cultivars	Variants	2013	2014	2015	Mean
Helius	no treated control	77.5	80.0	87.5	81.7
	economic control	90.0	100.0	87.5	92.5
	Goal 2 E	87.5	87.5	87.5	87.5
	Linuron 45 SC	90.0	89.5	87.5	89.0
	Wing-P	90.0	85.0	90.0	88.3
	Merlin 750 WG	84.5	85.0	82.5	84.0
	Bazagran 480 SL	90.0	100.0	85.0	91.7
	Amalgerol	80.0	85.0	97.5	87.5
	Goal 2 E + Amalgerol	90.0	80.0	77.5	82.5
	Linuron 45 SC + Amalgerol	92.5	97.5	92.5	94.2
	Wing-P + Amalgerol	97.0	97.5	100.0	98.2
	Merlin 750 WG + Amalgerol	90.0	85.0	100.0	91.7
	Bazagran 480 SL + Amalgerol	90.0	85.0	97.5	90.8
	Lactofol O	80.0	87.5	100.0	89.2
	Goal 2 E + Lactofol O	92.0	90.0	92.5	91.5
	Linuron 45 SC + Lactofol O	95.0	96.5	92.5	94.7
	Wing-P + Lactofol O	97.0	96.5	100.0	97.8
Merlin 750 WG + Lactofol O	97.0	82.5	97.5	92.3	
Bazagran 480 SL + Lactofol O	92.0	97.5	87.5	92.3	
Darmi	no treated control	75.0	92.5	85.0	84.2
	economic control	97.0	94.5	95.0	96.5
	Goal 2 E	95.0	95.0	92.5	94.2
	Linuron 45 SC	85.0	80.0	72.5	79.2
	Wing-P	95.0	85.0	92.5	90.8
	Merlin 750 WG	92.0	85.0	90.0	89.0
	Bazagran 480 SL	98.0	90.0	100.0	96.0
	Amalgerol	80.0	85.0	90.0	85.0
	Goal 2 E + Amalgerol	95.0	92.5	95.0	94.2
	Linuron 45 SC + Amalgerol	80.0	80.0	75.0	78.3
	Wing-P + Amalgerol	95.0	82.5	95.0	90.8
	Merlin 750 WG + Amalgerol	92.5	92.5	92.5	92.5
	Bazagran 480 SL + Amalgerol	95.0	87.5	100.0	94.2
	Lactofol O	80.0	82.5	95.0	85.8
	Goal 2 E + Lactofol O	98.0	65.5	92.5	85.3
	Linuron 45 SC + Lactofol O	80.5	87.5	80.0	82.7
	Wing-P + Lactofol O	90.0	87.5	92.5	90.0
Merlin 750 WG + Lactofol O	95.0	80.0	97.5	90.8	
Bazagran 480 SL + Lactofol O	95.0	95.0	95.0	95.0	

LSD, %:

F.A	p≤5%=0.3	p≤1%=0.4	p≤0.1%=0.5
F.B	p≤5%=0.2	p≤1%=0.3	p≤0.1%=0.4
F.C	p≤5%=0.8	p≤1%=1.0	p≤0.1%=1.3
AxB	p≤5%=0.4	p≤1%=0.6	p≤0.1%=0.7
AxC	p≤5%=1.3	p≤1%=1.8	p≤0.1%=2.3
BxC	p≤5%=1.1	p≤1%=1.4	p≤0.1%=1.9
AxBxC	p≤5%=1.9	p≤1%=2.5	p≤0.1%=3.2

Foliar fertilizer Lactofol O reduces phytotoxicity on the laboratory seed germination only of herbicides Merlin 750 WG and Linuron 45 SC on cultivar Darmi. Analysis of variance for laboratory germination of cotton seeds (Table 2) shows that the herbicides and their



combinations have big influence on the seed germination – 25.1 % on the variants. The reason for this is the phytotoxic action of some of the herbicides. The strength of influence of years is 3.3 % and the strength of influence cultivars is 0.7 %. The influence of years, of cultivars and of herbicides is very well proven at  $p \leq 0.01$ . There is an interaction between cultivars and meteorological conditions of years (AxB) – 1.4 %, between herbicides and meteorological conditions of years (AxC) – 31.3 %, and between cultivars and herbicides (BxC) – 24.1 %. They are very well proven at  $p \leq 0.1$ . There is interaction between three experiment factors (AxBxC) – 12.9 %. It also is very well proven at  $p \leq 0.1$ .

Table 2. Analyses of variance for laboratory seed germination.

Source of variation	Degrees of freedom	Sum of squares	Influence of factor, %	Mean square
Total	455	11295.5	100	-
Tract of land	3	31.8	0.3	31.8***
Variants	113	11160.0	98.8	98.7***
Factor A - Years	2	376.5	3.3	188.3***
Factor B - Cultivars	1	82.4	0.7	82.8***
Factor C - Herbicides	18	2831.5	25.1	157.3***
AxB	2	154.9	1.4	77.4***
AxC	36	3536.8	31.3	98.2***
BxC	18	2724.9	24.1	151.4***
AxBxC	36	1453.1	12.9	40.4***
Pooled error	339	102.8	0.9	0.9

\* $p \leq 5\%$     \*\* $p \leq 1\%$     \*\*\* $p \leq 0.1\%$

Based on proven herbicide x year interaction and cultivar x year interaction, it was evaluated stability parameters for each variant for length of the laboratory germination of cotton seeds with relation to years (Table 3). It was calculated the stability variances  $\sigma_i^2$  and  $S_i^2$  of Shukla, the ecovalence  $W_i$  of Wricke and the stability criterion  $YS_i$  of Kang. Stability variances ( $\sigma_i^2$  and  $S_i^2$ ) of Shukla, which recorded respectively linear and nonlinear interactions, unidirectional evaluate the stability of the variants. These variants which showed lower values are considered to be more stable because they interact less with the environmental conditions. Negative values of the indicators  $\sigma_i^2$  and  $S_i^2$  are considered 0. At high values of either of the two parameters -  $\sigma_i^2$  and  $S_i^2$ , the variant are regarded as unstable. At the ecovalence  $W_i$  of Wricke, the higher are the values of the index, the more unstable is the variant. On this basis, using the first three parameters of stability, it is found that at cultivar Helius stable are herbicide combinations Wing P + Amalgerol, Wing P + Lactofol O and Goal + Lactofol O. At cultivar Darmi stable are Goal + Amalgerol and Wing P + Lactofol O. Other variants have high instability - values of stability variance  $\sigma_i^2$  and  $S_i^2$  of Shukla and ecovalence  $W_i$  of Wricke are the highest and mathematically proven. The reason for this high instability is greater variation in seed germination during years of experience as weather conditions affect those most. At part of them there is instability from linear and nonlinear type - proven values  $\sigma_i^2$  and  $S_i^2$ . At another part of them, instability is a linear type - proven values  $\sigma_i^2$ , the values of  $S_i^2$  are not proven. To evaluate the complete efficacy of each herbicide should be considered as its effect on laboratory germination of cotton seeds and its stability - the reaction of cotton to this variant during the years. Valuable information about the value of technologic value of the variant give the stability criterion  $YS_i$  of Kang for simultaneous assessment of length of the primary root and stability, based on the reliability of the differences in yield and variance of interaction with the environment. The value of this criterion is experienced that using nonparametric methods and warranted statistical differences we get a summary assessment aligning variants in descending order according to their economic value.

Table 3. Stability parameters for the variants for laboratory seed germination with relation to years.

Cultivars	Variants	$\bar{x}$	$\sigma_i^2$	$S_i^2$	$W_i$	$YS_i$
Helius	no treated control	81.7	36.7**	58.7**	73.2	-8
	economic control	92.5	137.8**	13.4**	264.8	22+
	Goal 2 E	87.5	3.3*	-1.5	9.9	4
	Linuron 45 SC	89.0	13.4**	2.0	29.0	5
	Wing-P	88.3	3.9*	6.0*	11.0	7
	Merlin 750 WG	84.0	15.2**	-0.5	32.4	-5
	Bazagran 480 SL	91.7	176.7**	3.6*	336.4	18+
	Amalgerol	87.5	135.3**	192.3**	260.0	0
	Goal 2 E + Amalgerol	82.5	102.0**	179.4**	196.9	-7
	Linuron 45 SC + Amalgerol	94.2	37.9**	6.0*	75.5	24+
	Wing-P + Amalgerol	98.2	0.8	3.3	5.1	41+
	Merlin 750 WG + Amalgerol	91.7	77.1**	12.0**	149.7	18+
	Bazagran 480 SL + Amalgerol	90.8	45.6**	2.8	90.0	12
	Lactofol O	89.2	179.7**	283.6**	344.2	7
	Goal 2 E + Lactofol O	91.5	-1.4	-0.9	0.9	24+
	Linuron 45 SC + Lactofol O	94.7	25.1**	-0.9	51.2	28+
	Wing-P + Lactofol O	97.8	-0.5	1.2	2.6	40+
Merlin 750 WG + Lactofol O	92.3	105.5**	56.1**	203.6	20+	
Bazagran 480 SL + Lactofol O	92.3	89.5**	-1.5	173.3	20+	
Darmi	no treated control	84.2	193.3**	252.7**	370.0	-4
	economic control	96.5	15.2**	-0.5	32.4	31+
	Goal 2 E	94.2	15.8**	1.1	33.6	24+
	Linuron 45 SC	79.2	110.2**	113.5**	212.5	-9
	Wing-P	90.8	34.5**	48.3**	69.0	12
	Merlin 750 WG	89.0	13.4**	24.5**	29.0	5
	Bazagran 480 SL	96.0	28.6**	8.0**	58.0	30+
	Amalgerol	85.0	40.8**	81.8**	81.0	-3
	Goal 2 E + Amalgerol	94.2	-0.8	0.4	2.1	32+
	Linuron 45 SC + Amalgerol	78.3	37.0**	8.8**	73.9	-10
	Wing-P + Amalgerol	90.8	70.7**	45.0**	137.5	12
	Merlin 750 WG + Amalgerol	92.5	3.3*	-1.5	9.9	26+
	Bazagran 480 SL + Amalgerol	94.2	45.2**	-0.7	89.2	24+
	Lactofol O	85.8	99.7**	118.6**	192.5	-1
	Goal 2 E + Lactofol O	85.3	549.1**	449.9**	1044.1	-2
	Linuron 45 SC + Lactofol O	82.7	65.9**	10.8**	128.5	-6
	Wing-P + Lactofol O	90.0	-0.1	-1.4	3.5	18+
Merlin 750 WG + Lactofol O	90.8	133.2**	41.9**	256.1	12	
Bazagran 480 SL + Lactofol O	95.0	3.3*	-1.5	9.9	33+	

Generalized stability criterion  $YS_i$  of Kang, taking into accounts the stability and value of seed germination gives a negative assessment of herbicide Merlin 750 WG and herbicide combination Goal 2 E + Amalgerol on cultivar Helius. Negative assessment on cultivar Darmi has herbicide Linuron 45 SC and its combinations with Amalgerol and Lactofol O, and also herbicide combination Goal 2 E + Amalgerol. They are characterized as the most unstable and with low values. According to this criterion, technologically the most valuable are herbicide combinations Goal 2 E + Lactofol O, Linuron 45 SC + Lactofol O, Wing P + Lactofol O, Merlin 750 WG + Lactofol O, Bazgran 480 SL + Lactofol O, Linuron 45 SC + Amalgerol, Wing P + Amalgerol and Merlin 750 WG + Amalgerol, also sole use of herbicide Bazgran 480 SL on cultivar Helius. Technologically the most valuable are herbicides Goal 2 E and Bazgran 480 SL and herbicide combinations Goal 2 E + Amalgerol, Merlin 750 WG + Amalgerol, Bazgran 480 SL + Amalgerol, Wing P + Lactofol O and Bazgran 480 SL +

Lactofol O on cultivar Darmi. They combine relatively high values of the laboratory germination of cotton seeds and high stability during the years of the investigation. The sole use of the herbicides Linuron 45 SC and Merlin 750 WG receive low assessment and should be avoided. This is due to the high phytotoxicity of these two herbicides.

### **Conclusions**

The foliar treatment with tank mixtures Wing P + Amalgerol and Wing P + Lactofol lead to the highest seed germination in case of the cultivar Helius. The foliar treatment comprising the herbicide Bazagran or the tank mixture Bazagran+ Lactofol leads to the highest seed germination in case of the cultivar Darmi.

The highest phytotoxicity on seed germination of the cultivar Helius was recorded after using the herbicide Merlin and the tank mixture Goal+ Amalgerol. The highest phytotoxicity on seed germination of the cultivar Darmi was recorded after using the herbicide Linuron and its tank mixtures with Amalgerol and Lactofol.

From the aspect of cotton growing technology, technologically the most valuable are combinations of all herbicides with Lactofol, which are followed by Linuron + Amalgerol, Wing + Amalgerol, Merlin + Amalgerol and sole use of herbicide Bazagran on cultivar Helius. Technologically the most valuable are herbicides Goal and Bazagran and tank mixtures Goal + Amalgerol, Merlin + Amalgerol, Bazagran + Amalgerol, Wing + Lactofol and Bazagran + Lactofol on cultivar Darmi. These variants combine high lengths of the seed germination and high stability of this index during the different years.

The sole use of the herbicides Linuron and Merlin has low assessment and should be avoided.

### **References**

- Ashok Y. (2006). Integrated control of weeds in cotton. *Environment and Ecology* 24 S (Special 3A), 883-885.
- Barakova T., Delchev, Gr. (2016). Selectivity and stability of vegetation-applied herbicides at cotton (*Gossypium hirsutum* L.). *Agricultural Science and Technology*, vol. 8, № 2, 121-126, pp , 2016.
- Barakova, T. (2017). Development of elements of integrated weed control during cotton vegetation and testing of cotton genotypes (*Gossypium hirsutum* L.) for resistance to herbicides to exclude manual labor in its cultivation. Dissertation, Chirpan.
- Barov, V. (1982). Analysis and schemes of the field experience. NAPO, Sofia, p. 668.
- Bukun B. (2004). Critical periods or weed control in cotton in Turkey. *Weed Research*, vol. 44, 404-412.
- Kang M. (1993). Simultaneous selection for yield and stability: Consequences for growers. *Agronomy Journal*, 85: 754-757.
- Lidanski, T. (1988). Statistical methods in biology and agriculture, Sofia, p. 376.
- Salimi H. (2006). Determination of the critical period of weed control in cotton fields (*Gossypium hirsutum* L.). *Applied Entomology and Phytopatology*, vol. 74 (1),35-37
- Shanin, Yo. (1977). Methodology of the field experience. BAS, p. 384.
- Shukla G. (1972). Some statistical aspects of partitioning genotype - environmental components of variability. *Heredity*, 29: 237-245.
- Stoychev, D. (2013). Competition between the cotton and the main types of weeds and the possibilities to fight them. Dissertation, Plovdiv.
- Wricke G. (1962). Über eine Methode zur Erfassung der ökologischen Streubreite in Feldersuchen. *Pflanzenzuecht*, 47: 92-96.

## INFLUENCE OF ENVIRONMENT ON YIELD STRUCTURE CHARACTERISTICS AND GRAIN YIELD OF PEAS GROWN IN SOUTH-CENTRAL BULGARIA

Tsenka ZHELIAZKOVA\*, Dimitar PAVLOV, Mariya GERDZHIKOVA

Trakia University, 6000 Stara Zagora, Bulgaria

\*Corresponding author: tsenka@abv.bg

### Abstract

Pea is a valuable leguminous crop essential for the balanced nutrition of men and animals. The aim of study was to establish the relationship between yield and yield characteristics of grain legumes spring pea (*Pisum sativum* L.) and wintering pea (*Pisum arvense* L.) and impact of climate factors of Central South Bulgaria on peas yield. The survey was conducted during 2004–2013 in the experimental base of the Plant Growing Department at Trakia University, Stara Zagora. The experiment was conducted by the block method in 4 repetitions. The plants were grown according to the conventional technology. Results obtained for the grain yield and structure components were statistically processed by ANOVA and regression equations among the yield and climatic parameters were developed. It was established that in the environment conditions of Bulgaria *P. sativum* were high productive, compared to *P. arvense*. Good correlations were found between the morphological characteristics. Interpopulation variation (94.48 – 99.90%) of the grain yield and yield characteristics was significantly higher compared to the intrapopulation. The values of the yield and yield structure characteristics depend in a great extent of climatic parameters. Regression equations were developed on this base, which allows preliminary assessment of peas grain productivity with approximate accuracy for practical purposes. Studies to determine the effect of pea variety and year showed that climate conditions over the years as factor had the highest impact on the yield (68.72%). The type of pea as factor had a higher effect on the morphological parameters and yield structure elements (42.54 – 96.28%).

**Keywords:** *Equations, Peas, Climatic conditions, Yield, Morphological characteristics*

### Introduction

Variability of yields and their dependence on climatic factors are one of the most important problems in crop production. This entails the search for new alternative solutions related to crop tolerance to abiotic stressors (Cutforth et al., 2007; Stagnari et al., 2017). From abiotic factors in Bulgaria the bigger role have temperature and humidity, which further defines the expression and effect of biotic factors. Their interaction and complex influence on grain, fix negative effect on leguminous yields, which is the reason for the reduction of their areas (Kirilov, 2016; McMurray et al., 2011). One of the most widespread cereal crops, both in the European Union and in Bulgaria, is peas (Kirilov, 2016). One of his major advantages is that under the terms of a typical continental climate with frequent droughts, without irrigation gives high yields of protein with low cost. (Tekeli and Ates, 2003; Zhelyazkova et al., 2007, 2012). Pea yields are influenced to a significant extent by the environmental conditions and the genotype (Acikgoz et al, 2009; Bueckert et al., 2015; Dore et al., 1998), as their variability by year is an extremely large with a coefficient of variation of 30% (Kuzmova, 2001).

The magnitude of yield on spring pea is influenced most by the change of the main meteorological elements, especially of the precipitation in the spring (Dore et al., 1998;

Kouzmova, 2003). In a good security with moderate rainfall and temperature it blooms longer, the plants are higher and more pods. When rainfall is less and the temperatures of the air – higher height, mass, number of legumes and grains of a plant are lower (Bueckert et al., 2015; McMurray et al., 2011). Excessive moisture during flowering and ripening period can become a reason for obtaining low yields due to lodging of plants, rotting the bottom of the stems, the development of diseases and low insemination (Angelova and Kouzmova, 2001; Kouzmova, 2003; McMurray et al., 2011). Uncertain yields of spring pea varieties are a serious reason to look for a way out in the growing of varieties for the wintering grain (and Kouzmova Angelova, 2001; Cutforth et al., 2007; Kouzmova, 2001; Zhelyazkova et al., 2007). Risk factor in growing wintering peas is the temperature during the winter period as a stronger correlation of indicators of yield with temperature compared to the conditions of humidity can be searched in the autumn-winter water supply, and not solely from the fallen precipitation (Koeva et al., 1990).

The purpose of this study is to establish productive capabilities of grain legumes spring peas (*Pisum sativum* L.) and wintering peas (*Pisum arvense* L.) under the environmental conditions of South-Central Bulgaria, the influence of climatic conditions on productivity and structural elements by examining the relationships between them for a longer period of time.

### Materials and methods

The survey was conducted during the period 2004–2013 on the experimental base of the "Plant Growing" Department at Trakia University, Stara Zagora. A field experiment was conducted to establish the growth and productivity of annual grain legumes spring pea (*Pisum sativum* L.) cultivar Bogatir and wintering pea (*Pisum arvense* L.) cultivar Mir. The experiment was conducted by the block method in 4 repetitions, after a wheat as preceding crop.

The legumes were grown according to the conventional technology adopted in the country and the region, without irrigation. For meteorological evaluation of the test period, the degree of certainty of water and air temperature was calculated by the formula  $P=i/(n+1)*100$ , where: P- certainty; i – serial number of individual members in the row (sorted in descending order for the precipitation patterns and amounts in ascending order for the annual average and growing temperatures); n-total number of items in the line. Representative order with 40 members (1974 – 2013) was used. For very moist and cool are considered years with 0-25%, for moderate wet and cool with an average 25 - 50%, the security for medium-dry and warm with average security 50 - 75% dry and warm – 75 to 100% (Delibaltov et al., 1962). During the experiment the yield of grain in standard humidity (13%) were established and the following morphological parameters were studied: plant height at harvesting, number of pods and grain per plant, grain mass per plant and 1000 grain mass. The data obtained was processed statistically and used to establish the correlation and regression equation by means of StatSoft STATISTICA for Windows (2013).

The soil in the area was typical *Gleic Chromic Luvisols*, moderately supplied with hummus, with a slight acidic reaction, poorly supplied with nitrogen and phosphorus and very well supplied with potassium. These soil conditions are favorable for the development and growth of the grain legumes.

### Results and discussion

In the climatic respect the years during which the study was conducted, are characterized by uneven distribution of precipitation. The most humid is a 2005 (P = 2.5%), when the annual amount of precipitation is with 50.7% over the average for the period 1936 - 2002 (Table 1).

Very moist are 2004, 2007, 2009 and 2012. The most dry is 2011 with the annual amount of rainfall with 31.6 percent below average for a long-term period and security 85.0%. In terms of the amount of spring peas growing rains (March - June) average for the test period is 192.6 mm, which is 8.7% below normal.

Table 1. Climate conditions, average for the year and vegetation periods.

Year	Rains, mm				Temperature, °C			
	I-XII	P, %	X-VI	III-VI	I-XII	P, %	X-VI	III-VI
2004	602.9	20.0	404.7	207.1	12.3	40.0	9.2	13.9
2005	824.3	2.5	445.2	196.8	11.8	12.5	9.2	13.9
2006	506.8	55	435.0	220.9	12.3	45.0	8.3	14.4
2007	730.5	5.0	373.4	241.3	13.2	80.0	10.4	15.5
2008	534.4	37.5	545.8	247.1	12.8	70.0	9.0	15.1
2009	588.2	25.0	322.2	145.3	13.0	75.0	9.8	14.7
2010	725.4	7.5	535.6	218.1	13.2	82.5	9.8	14.4
2011	374.2	85.0	298.4	89.3	12.2	37.5	9.5	14.1
2012	617.0	17.5	482.9	174.5	13.6	90.0	8.8	15.6
2013	534.1	40.0	516.0	185.1	13.7	92.5	10.8	16.1
2004-2013	603.8	29.5	435.9	192.6	12.8	62.5	9.5	14.8
1936-2002	547.0		462.1	210.9	12.4		9.3	14.2

\*P - degree of certainty according to the monthly sum of the precipitation and the average monthly air temperature, %

The greatest amount of rainfall during growing period was registered in 2008 – 247.1 mm (17.2% above normal), and the smallest in 2011 – 89.3 mm (57.7% below normal). For wintering peas greatest amount rainfall during growing period (October – June) was registered in 2008 – 545.8 mm (28.4% above normal), and the smallest as it was for spring peas in 2011 – 298.4 mm, (29.8% below normal). In terms of average annual air temperatures-six of the experimental years are warm – 2007, 2008, 2009, 2010, 2012, and 2013. 2005 – is a cool with security and 12.5%, average cool are 2004, 2006, and 2011 years (P = 37.5% to 45%). The highest temperatures during reproductive phases of peas (May - June) are taken into account in 2013. Average air temperature during the growing season of spring peas (March - June) in seven of the experimental years was with values above normal as they are highest in 2013 with about 2.0 °C above normal. Winter conditions in most of the experimental years are normal and there is no reported damage by low temperatures on crops of wintering peas. In the months of January and February of 2012 have reported record low temperatures, respectively 1.3 and 3.5 °C below normal, but formed though a thin snow cover and high winter resistance of pea variety “Mir” have led to minimal frost damages and formation of crop with optimal density. Analysis of the integral effect of the two main meteorological factors rainfall and air temperature indicates that within the growing season the peas in the ten years of study there are exceptions by month, with the result that different conditions have been created for the development of plants and their productivity.

The most valuable product in peas is grain. On average for the period of the research productivity of peas grown in the region of South-Central Bulgaria is 2196.9 kg.ha<sup>-1</sup> with variation of 1092.5 to 3303.3 kg.ha<sup>-1</sup> (Table 2). Spring pea is distinguished by an average of 9.5% higher productivity. The most favorable in terms of productivity of the peas are the 2004, 2008 and 2010.

Table 2. Yield potential and morphological structure parameters of pea by years, average for the period 2004 – 2013, n=80.

Year	Yield of grain, kg.ha <sup>-1</sup>	Stem height, cm	Pods per plant, number	Grains per plant, number	Grain mass per plant, g	1000 grain mass, g
Spring pea ( <i>Pisum sativum</i> L.)						
2004	3303.3	122.3b	5.95a	25.10a	6.05a	221.75a
2005	2361.3a	77.8a	5.60a	24.60a	5.37a	215.85a
2006	2422.0a	80.0a	5.83a	23.95a	4.90b	214.42a
2007	1092.5	43.1	4.85a	22.20a	4.65b	201.17a
2008	3071.5	97.3a	6.28a	26.20a	6.20a	214.20a
2009	2409.3a	80.0a	5.35a	24.57a	5.60a	203.10a
2010	2800.0	85.8a	6.10a	25.90a	5.75a	221.40a
2011	2025.0	52.4c	5.43a	26.18a	4.95ab	205.20a
2012	1912.5	89.2a	5.23a	26.03a	4.80b	186.35b
2013	1685.0c	44.4c	4.88a	22.95a	4.40b	198.30
Average	2308.2A	77.2***	5.55***	24.70***	5.27***	208.17***
Wintering pea ( <i>Pisum arvense</i> L.)						
2004	2316.3a	148.5d	7.25b	33.82b	3.70b	119.70c
2005	2141.3b	143.2d	7.53b	32.17b	3.50b	114.40c
2006	1908.8	141.8d	7.10b	31.70b	3.32b	113.60c
2007	2198.5b	131.1b	9.85b	35.52b	4.48b	126.01c
2008	2604.5	148.8d	11.38	56.34	6.42a	113.94c
2009	2128.0b	142.8d	7.97b	34.32b	3.80b	114.05c
2010	2425.0a	149.9d	7.72b	35.20b	3.47b	121.10c
2011	1625.0c	123.3b	7.27b	33.92b	3.25b	116.40c
2012	1850.0	151.1d	7.12b	33.20b	3.60b	115.95c
2013	1660.0c	113.7b	7.60b	32.30b	3.10b	132.50c
Average	2085.7A	139.4***	8.08***	35.80***	3.86***	118.77***
All groups	2196.98	108.3	6.85	30.31	4.57	163.47
SD	512.91	36.74	1.64	7.63	1.08	45.85
CV	263081.2	1350.01	2.69	58.28	1.17	2101.81
SEE	57.35	4.11	0.18	0.85	0.12	5.13
Min	1072	41.7	4.7	21.6	3	111.19
Max	3318	156	12.1	61.75	7.2	222.2

Different letters denote statistically significant differences among variants at P < 0.05

\*\*\* - Statistically significant differences of average values among peas varieties at P< 0.001.

The lowest yields of spring peas were reported in 2007, when the distribution of rainfall is growing extremely uneven-there is highly drought in April lasted until the third decade of May as growing 26.6% of rainfall fell at the end of March, and 52.3% in the period 20 - 30 May. On the other hand, at the time of flowering and ripening phases (May and June) average monthly air temperatures are record high – with 1.6 - 2.4 °C above normal, which has affected negatively on productivity. Low productivity in both types of peas is recorded in 2011, 2012 and 2013 makes good impression that the uneven distribution of precipitation during the growing season of 2012, accompanied by monthly average air temperatures during maturation (June) with 2.8 °C above the multi-annual average for the same period, affect the development

of spring peas. In wintering pea yield this year is almost equal with spring pea. As the winter culture, it has outpaced the development of spring peas, which incurred drought in June 2012, have not responded so negatively to the massiveness of the grain as in spring peas. The height of the stem in peas is highly changing indication as to research period has seen a difference in height almost doubled – from 43.08 up 122.25 cm in spring peas and 113.0 to 151.1 cm in wintering. Arid 2007, 2011 and 2013 have created prerequisites for the formation of the stems with the lowest height compared to other years and in both types of peas. Pea crop grown in agri-environmental conditions of Central South Bulgaria formed an average of 6.8 pods per one plant with 30.3 grains. The highest number of pods and grains from the plant in both types of peas is recorded in 2008. The smaller number of legumes and grains from the plant in the spring peas is recorded in 2007 characterized with sensitive dry periods and temperatures above optimal, not seen in wintering peas, which uses more autumn-winter water supplies. In wintering peas the number of pods is lowest in 2006, characterized by a sharp cold observed in January, coupled with the lack of snow cover and drought extended the period of reproductive phases. Similarly, the impact of weather conditions on the mass of the grains of the plant so that once again the highest in both species, and average for the test period were recorded in 2008. Spring peas formed a grain with a mass of 5.27 g per plant, which is higher with 26.65% compared to wintering peas. Data on the weight of 1000 grains indicate that the most massive grain of spring peas is received in 2004, 2005 and 2010, and the smaller in 2012 and 2013. The mass of 1000 grain in wintering peas is with 46.95% lower than that in the spring peas. As winter culture the highest in 2013-as, he has outpaced the development of spring peas, which is probably the reason the dry and hot period in May and June 2013 not to affect the masiveness of the grain. Analysing the relationship between productivity, plant height and yield structural elements in peas it was established that grain yield is in a good positive correlation with the specific mass of grains per plant ( $r = -0.812$ ) (Table 3). The height of the stem is in a good positive correlation to

Table 3. Correlation among the pea parameters, n=80

Parameters	Yield of grain, kg.ha <sup>-1</sup>	Stem height, cm	Pods per plant, number	Grains per plant, number	Grain mass per plant, g	1000 grain mass, g
Yield of grain, kg.ha <sup>-1</sup>	1.000					
Stem height, cm	0.228	1.000				
Pods per plant, number	0.144	0.742*	1.000			
Grains per plant, number	0.079	0.700*	0.929*	1.000		
Grain mass per plant, g	0.620*	-0.364	-0.090	-0.043	1.000	
1000 grain mass, g	0.312	-0.812*	-0.732	-0.726	0.674*	1.000

\* Statistical significance at  $P < 0.05$

the number of pods and grains per plant ( $r = 0.700 - 0.742$ ) and very good negative relation with the mass of 1000 grains ( $r = -0.812$ ). Number of pods per plant is in a very good correlation with the number of grains ( $r = 0.929$ ), and the mass of the grains is in a good correlation with the weight of 1000 grains ( $r = 0.674$ ).

The statistical analysis for the variation of grain productivity and the structural elements that determined it show that the interpopulation variation is significantly higher (94.48 – 99.90%), while the variation within populations was minimal (0.10 – 5.52%) Interpopulation variation was highest for the mass of the grains from plants and less on the weight of 1000 grains.

Climate conditions during the years as factor had a higher impact on the peas yield (68.72%),  $P < 0.0001$  (Table 4).

The power of influence of climate conditions over the years on the indicators of the stem height, number of pods and grain from the plant, mass of grains per plant and weight of 1000



grains is significantly lower. On the height parameters and structural elements the type of peas (42.54-96.28%) as a factor has the greater influence. As in grain yield such as in parameters number of pods and grain per plant and mass of the grains per plant is observed lower interaction among type of culture with climate conditions (13.8-25.18%).

Table 4. Influence of factors on the grain yield and yield structure characteristics, %

Source of variation	Yield of grain, kg.ha <sup>-1</sup>	Stem height, cm	Pods per plant, number	Grains per plant, number	Grain mass per plant, g	1000 grain mass, g
Pea Variety	4.76	72.51	60.03	53.46	42.54	96.28
Year	68.72	21.95	20.75	24.53	38.14	1.46
Pea Variety*Year	25.18	4.15	16.87	18.70	13.80	2.16
Error	1.33	1.39	2.36	3.31	5.52	0.10

Correlation analysis shows that with the most positive impact on productivity of spring peas in a region of Central South Bulgaria are precipitation in June ( $r = 0.819$ ) and negatively impact the temperatures during the period May-June  $r = (-0.668) - (-0.715)$ . With the strongest influence on the number of pods, the mass of the grains of the plant and the mass of 1000 seeds in spring peas are precipitation in June ( $r = -0.633 - 0.657$ ) and temperatures in the second half of the growing season, May-June,  $r = (0.654) - (0.838)$ .

The yield of grains in wintering peas is positively correlated with precipitation during the period March-June ( $r = 0.682$ ). On the number of pods and grains and the mass of the grains from plant greatest affect had rainfall in April ( $r = 0.456 - 0.663$ ) and temperatures in March ( $r = 0.715 - 0.749$ ). With the strongest influence on the weight of 1000 grains in wintering peas are the temperatures during the growing season (October - June) -  $r = 0.841$ .

The good relationships between productivity and structural elements of productivity and on the other hand between the morphological indices of grain yield and climatic factors, allow to develop regression dependences for evaluation of mentioned parameters by climatic factors. The yields of grain and the structural elements of yield in spring peas are determined with high accuracy depending on the amount of rainfall in June ( $R = 0.632 - 0.819$ ) and temperatures in May ( $R = 0.653 - 0.715$ ) (Table 5). Grain yields in wintering peas are determined with high accuracy depending on rainfall during the period March-June ( $R = 0.682$ ). The number of legumes and the mass of the grains from a plant in wintering peas are determined with high accuracy depending on the temperatures in March ( $R = 0.715 - 0.944$ ). Developed regression equations are with a good degree of confidence ( $P < 0.05$ ) and allow to carry out for a preliminary assessment of the productivity of the peas with sufficient accuracy for practical purposes.

Table 5. Regression equations for predicting of grain yield and yield structure characteristics based on climate conditions.

Equation	*R	SEE	F	P<
Spring pea ( <i>Pisum sativum</i> L.)				
Yield of grain, kg.ha <sup>-1</sup>				
$Y = 1053.31 + 20.478 W_{VI}$	0.819	335	16.33	0.003731
$Y = 8781.665 - 365.731 T_V$	0.715	2242	8.38	0.020073
Pods per plant, number				
$Y = 4.837 + 0.0116 W_{VI}$	0.632	0.3	5.35	0.049549
$Y = 10.496 - 0.279 T_V$	0.741	1.5	9.75	0.014203

Grains per plant, number				
$Y = 26.74 - 0.0519 W_{III}$	0.762	0.66	11.13	0.010305
$Y = 37.285 - 0.707 T_V$	0.653	5.1	5.98	0.040249
Grain mass per plant, g				
$Y = 4.334 + 0.0152 W_{VI}$	0.653	0.41	5.98	0.040250
$Y = 10.898 - 0.318 T_V$	0.667	2.2	6.43	0.034937
1000 grain mass, g				
$Y = 190.978 + 0.280 W_{VI}$	0.657	7.5	6.08	0.038947
$Y = 371.335 - 7.484 T_{VI}$	0.837	37.6	18.83	0.002480
Wintering pea ( <i>Pisum arvense</i> L.)				
Yield of grain, kg.ha <sup>-1</sup>				
$Y = 1194.332 + 4.629 W_{III-VI}$	0.682	346.0	6.97	0.029753
Pods per plant, number				
$Y = 0.920 + 1.008 T_{III}$	0.715	2.4	8.37	0.020096
$Y = 33.506 - 7.976 T_{II} + 0.608 T_{III}^2$	0.863	13.0	10.23	0.008359
Grains per plant, number				
$Y = 29,602 + 0.161 W_{IV}$	0.662	3.1	6.26	0.036792
$Y = 39.737 - 0.484 W_{IV} + 0.00644 W_{IV}^2$	0.984	1.2	113.76	0.000005
Grain mass per plant, g				
$Y = - 1.460 + 0.751 T_{III}$	0.749	1.6	10.24	0.012607
$Y = 26.058 - 8.937 T_{III} + 0.514 T_{III}^2$	0.944	6.0	28.76	0.000420
1000 grain mass, g				
$Y = 18.686 - 64.254 T_{X-VI} + 3.714 T_{X-VI}^2$	0.917	139.0	18.69	0.001559
$Y = 114.179 - 2.87 T_{II} + 1.236 T_{II}^2$	0.924	1.4	20.51	0.001183

\*R- coefficient of determination; SEE- standard error of estimation; F- ratio among the variables; P- Statistical significance; W – Precipitation, mm; T – Temperature, °C; I; V;VI; III-VI –months

### Conclusion

In non-irrigated conditions in the area of South-Central Bulgaria productivity of peas is an average of 2197.0 kg.ha<sup>-1</sup> for spring peas with 9.54 percent higher than wintering peas. There are good correlations between the yield and structural elements in peas. The yield of grain is in good relation with the mass of the grains per plant, the number of pods is in a very good correlation with the number of grains of the plant, and the mass of the grains with the weight of 1000 grains.

Interpopulation variation of productivity and morphological parameters is significantly higher (94.48 – 99.90%) compared to the variation within the population (0.10 – 5.52%). Climatic conditions during the year have the most powerful influence (68.72%) on the yield of grain. The type of peas as a factor has the greater influence (42.54 - 96.28%) on height parameters and structural elements. The most powerful influence on productivity, the number of pods, the mass of the grains of the plant and the mass of 1000 seeds in spring peas exerts rainfall in June and temperatures during the period May-June. In wintering peas strong influence on productivity had precipitation during the period March-June. On the number of pods and grains and the mass of the grains from a plant in wintering peas mainly affect rainfall in April and temperatures in March. Developed on this base regression dependences allow to carry out a preliminary assessment of the productivity with satisfactory accuracy for practical purposes.

## References

- Acikgoz E., Ustun A., Gul I., Anlarsal E., Tekeli A., Nizam I., Avcioglu R., Geren H., Cakmakci S., Aydinoglu B., Yucel C., Avci M., Acar Z., Ayan I., Uzun A. (2009). Genotype x environment interaction and stability analysis for dry matter and seed yield in field pea (*Pisum sativum* L.) Spanish Journal of Agricultural Research, 7(1), 96-106.
- Angelova S., Kouzмова K. (2001). Influence of agrometeorological conditions of South Central Bulgaria on development and yield of grain in some varieties wintering peas. Plant science, Sofia, 38, N 7-10, 327-330.
- Bueckert A., Wagenhoffer S., Hnatowich G., Warkentin D. (2015). Effect of heat and precipitation on pea yield and reproductive performance in the field. Can. J. Plant Sci., 95, 629–639.
- Cutforth H. W., McGinn S. M., McPhee K. E., Miller P. R. (2007). Adaptation of Pulse Crops to the Changing Climate of the Northern Great Plains. Agronomy Journal, 99, 1684–1699.
- Delibaltov I., Conev H., Conev I. (1962). Projecting irrigation regime of agricultural crops. Izvestia of IHIM, v. 3, Sofia.
- Dore T., Meynard J., Sebillotte M. (1998). The role of grain number, nitrogen nutrition and stem number in limiting pea crop (*Pisum sativum*) yields under agricultural conditions. European Journal of Agronomy, 8, 29-37.
- Kirilov A. (2016). Role of leguminous fodder crops for sustainable agriculture. Journal of Mountain Agriculture on the Balkans, vol. 19, 2, 46-84.
- Koeva R., Popova S. (1990). Bioclimatica determination of yield from some wintering pea. Plant science, Sofia, 27, 3, 57-64.
- Kouzмова K. (2001). Ecological approach in variety assessment under the occurred climate changes: 1. Methodological considerations. 2. Geography and trends in global yield of pea. 3. Assessment of productive potential of some fodder pea varieties under different climatic conditions. 4. Optimum temperature for pea development. Scientific papers Agricultural University - Plovdiv, 46, 3, 367-390.
- Kouzмова K. (2003). Effect of agrometeorological conditions on same vegetative and reproductive behaviours of peas. Bulgarian Journal of Ecological Science, Ecology and future, 2, 1, 47-50.
- McMurray L. S., Davidson J. A., Lines M. D., Leonforte A., Salam M. U. (2011). Combining management and breeding advances to improve field pea (*Pisum sativum* L.) grain yields under changing climatic conditions in south-eastern Australia. Euphytica, 180, 69–88.
- Stagnari F., Maggio A., Galieni A., Pisante M. (2017). Multiple benefits of legumes for agriculture sustainability: an overview. Chemical and Biological Technologies in Agriculture, 4, 2, 1–13.
- Tekeli A. S. and Ates E. (2003). Yield and its components in field pea (*Pisum arvense* L.) Lines Journal Of Central European Agriculture (on line), vol. 4, 4, 313 – 317.
- Zhelyazkova T., Pavlov D., Ivanova I., Nenkova D. (2007). Influence of some plant growth regulators on winter pea (*Pisum arvense* L.) productivity. Journal of mountain agriculture on the Balkans, 10, 3, 499-511.
- Zhelyazkova T., Gerdzhikova M., Pavlov D. (2012). Effect of some plant growth regulators with retarding activity on spring pea for grain. Journal of Central European Agriculture, 13, 4, 837-849.

## STUDY ON VARIATION AND ASSOCIATION OF GRAIN QUALITY TRAITS IN DURUM WHEAT GENOTYPES

Krasimira TANEVA<sup>1</sup>, Violeta BOZHANOVA<sup>1\*</sup>, Ivanka PETROVA<sup>2</sup>

<sup>1</sup>Field Crops Institute, 6200 Chirpan, Bulgaria

<sup>2</sup>Institute of Cryobiology and Food Technology, 1407 Sofia, Bulgaria

\*Corresponding author: violetazb@gmail.com

### Abstract

Knowledge on variability and association of grain quality parameters is important for building an appropriate plant breeding strategy for improving these basic traits for durum wheat. The study was carried out to determine the variation and correlation of the following traits: protein content (PC), wet gluten (WG), yellow pigment and SDS sedimentation value of 24 durum wheat genotypes - varieties and breeding lines of different origin: Bulgaria (FCI – Chirpan, DAI - G. Toshevo), Europe, CYMIT - Mexico and ICARDA - Syria. All genotypes were grown under field conditions in competitive variety trial in three replications during three harvest years (2014 – 2016) in the experimental field of Field Crops Institute – Chirpan, Bulgaria. All parameters were evaluated on whole grains on standard methods. For statistical processing of the data variation analysis, analysis of variance (ANOVA) and correlation analysis were used. The variance component due to genotype explained most of the total variation for the traits: yellow pigment - 66.1 % and SDS sedimentation value - 92.9 %, while the variation of the PC is determined mostly by the environment (51.2 %) and the variation of WG – by the interaction between genotype and environment (45.24 %). Three Bulgarian breeding lines – M- 376 - 16, 26 %; M-6433 – 16,19 % and M-287 – 15,65 % are distinguished with the highest PC - average of three years. With regard to WG three breeding lines exceed foreign varieties DF-009114002 and Auradur, which have the highest values for this trait among all studied varieties. The foreign variety TD -97 is characterized by the highest YP - 9,83 %. All studied foreign varieties are characterized by stronger gluten and greatly exceed Bulgarian breeding materials with regards to the trait SDS. The greatest variation in the sample of the studied genotypes was found for traits YP and SDS. No statistically significant positive correlation was observed between protein and gluten content and gluten strength.

**Key words:** *plant breeding, durum wheat, grain quality traits, variation, correlation*

### Introduction

Protein content (PC) and gluten strength are the most important characteristics in assessing the culinary quality of pasta products. The link between the quantity and quality of protein with the culinary potential of durum wheat is complex and is influenced by other factors as well. Generally, durum wheat dough high in protein and with stronger gluten are tough and non-sticky and are ideal for processing into pasta with excellent culinary quality (Dexter and Matsuo, 1980; Matsuo et al., 1982; Autran et al., 1986; D'Egidio et al., 1990; Feillet and Dexter 1996; Dexter and Marchylo, 2000; Petrova and Cheleev, 2005; Sissons et al., 2005; Dexter, 2008). Protein content in durum wheat ranges from 10 to 21% depending on variety, climate, agro-technology and environmental conditions (Zwingelberg, 1996). Protein and gluten content is an important, but not a sufficient condition for the production of high quality products. This depends mainly on the quality of proteins, respectively gluten strength. Gluten

quality can be successfully determined by its colloidal properties in lactic acid solution. The sedimentation test is well suited for early screening of high gluten and good pasta quality lines of durum wheat since it is more influenced by the genotype than by the environmental conditions.

Concentration of yellow pigments in the grain is an important trait of durum wheat quality and is due to carotenoids. They contribute to the yellow color of semolina and macaroni. The yellow pigment is a highly inherited trait due to an additive genetic effect (controlled by more than one gene), making it very suitable for selection in early generations (Johnston et al., 1983, Joppa and Williams, 1988).

To improve durum wheat quality the efforts of plant breeders should be directed to the creation of cultivars with high protein content, strong gluten and a high content of yellow pigments. One of the most significant problems in this regard is the small differences in the variation of genes controlling these traits in modern durum wheat cultivars (Blanco et al., 1994). This calls for a large number of genotypes of different ecological and geographical origin to be included in the plant breeding programs. Knowledge on variability and association of grain quality parameters is important for building of appropriate breeding strategy for improvement of these basic for durum wheat traits.

The objective of the present study is to be identified the variation of traits related to the quantity, quality and colour of the protein/gluten in the grain and to establish correlations between them in a sample of 24 durum wheat genotypes - cultivars and breeding lines of different ecological and geographical origin.

### **Material and Methods**

The study includes 24 durum wheat genotypes - cultivars and breeding lines of different origin: Bulgaria (FCI - Chirpan, DAI - G. Toshevo), Europe, CYMIT - Mexico and ICARDA - Syria. All genotypes were grown under field conditions in competitive variety trial in three replications during three harvest years (2014 – 2016) in the experimental field of Field Crops Institute – Chirpan, Bulgaria. The following parameters have been analyzed: protein content (PC %), wet gluten content (WG %), yellow pigments (YP) in the grain and SDS-sedimentation value. For comparison the standard varieties Predel and Saturn-1 were used. Protein content in the grain has been determined by the Keldahl method (N x 5,7) according to BDS EN ISO 20483: 2006 and of wet gluten according to BDS EN ISO 21415-2: 2008. The gluten strength assessment has been done by sedimentation volume of whole ground grain with protein detergent sodium dodecyl sulfate (SDS) (ICC 151: 1990). The content of the yellow pigments has been determined spectrophotometrically according to BDS EN ISO 11052: 2006. The principle of the method is extraction of pigments with water-saturated n-butanol and reading the optical density of the clear filtrate at a wavelength of 440 nm. The amount of yellow pigments is calculated as ppm DM versus a standard curve with pure  $\beta$ -carotene.

For statistical processing of the data software package Statistica 6.0. has been used (StatSoft, Inc. 2002). Variation analysis, analysis of variance (ANOVA) and correlation analysis have been applied.

### **Results and Discussion**

According to the analysis of variance (Table 1), the genotype, the years of growing and the interaction between them have a reliable influence on the variation of the studied traits. Percentages of total sums of squares accounted for genotype, year (environment), and G×E interaction were used to indicate the variation attributed to each component. The variation of protein content in grain is mostly due to the environmental conditions (51.20%), while the

variation in the wet gluten content in grain (45.24%) to the genotype-environment interaction. A number of authors have found that protein and wet gluten content in durum wheat grain is largely influenced by environmental conditions (especially years) and report significant involvement of the genotype-environment interaction in the overall variation of these traits (Mariani et al. 1995, Ames et al., 1999, Dechev, 2004). The variation of the parameters yellow pigment content in grain (66.10%) and the SDS-sedimentation value (92.90%) is accounted for to the greatest extent by the genotype. Braaten et al. (1962) and Rharrabti et al. (2003) also reported significant influence of genotype and slight influence of the environment in variation of the SDS-volume and yellow pigment content parameters.

Table1. Analyses of variance on some studied traits in durum wheat genotypes

Traits	Source of variation, % from the total variation								
	Genotype			Year			Interaction		
	SS	MS	$\eta^2$ %	SS	MS	$\eta^2$ %	SS	MS	$\eta^2$ %
Protein content grain	59.18	2.57**	32.54	93.11	46.56**	51.20	28.90	0.63**	15.89
Wet gluten grain	958.4	41.7**	35.72	500.7	250.4**	18.66	1213.9	26.4**	45.24
Yellow pigment grain	193.030	8.393**	66.10	79.541	39.770**	27.24	19.233	0.418**	6.59
SDS	42521.2	1848.7	92.90	266.7	133.3	0.58	2799.0	60.8	6.12

\*\* = Significant at 1% probability level

Table 2 and Table 3 present the results of the three years of study and the average values for these years of the following traits: protein, wet gluten, yellow pigments content in the grain, and SDS sedimentation volume.

Protein content and gluten strength are the most important characteristics in assessing the culinary quality of pasta products. In the first year of study, protein content in the grain in the studied genotype samples ranged from 13.71 to 17.65%. Only in four lines protein content in the grain is lower than 13.7-14.6%. In the other lines and cultivars it is around and above 15%. In the second year protein content compared to the 2014 harvest is lower and ranges from 12.60 to 14.99%. During harvest 2016 high protein content and, respectively, wet gluten yield in grain are reported, ranging from 13.99 to 17.43% for the protein and from 26.6 to 36.4% for wet gluten. Protein and wet gluten content averaged for the three years of study ranged from 13.96-16.26% protein and 19.2-32.5% wet gluten, respectively. On average, for the three years of study, the highest values for the traits protein and wet gluten content in the grain were found for the lines M-376 (16.26% protein and 31.63% wet gluten) and D-6433 (16.19% protein and 32.5% wet gluten).

Through SDS-volume protein quality is characterized and, above all, gluten strength. In all three harvest years, the data show that strong gluten in the SDS-volume traits is shown by five breeding lines - D-8367, D-8362, D-8370, TD-97, DF-009114002, the four foreign cultivars Betadur, Selyemdur, Auradur and Superdur, the Bulgarian cultivar Severina and the standards Predel and Saturn 1. The SDS-sedimentation volume of these samples averaged for the three years of study ranges from 45-74.33 cm<sup>3</sup>. One of the reasons for the very low quality of gluten in some samples from the 2014 harvest is the severe damage to the grain by sunn pest (*Eurygaster integriceps*) (3 -10%) in addition to the fact that they belong to weak gluten

durum wheat with low SDS volumes. All studied lines and cultivars in harvest 2015 have much stronger gluten compared to gluten from harvest 2014. Sunn pest damage has an adverse effect on the gluten quality of all lines and cultivars, but the degree of impact depends on wheat genotype (Petrova, 2002). Strong gluten lines and cultivars have more internal reserves to meet the enzyme attacks in sunn pest damage and to manifest still good culinary potential with damage of over 5%, as is in line D-8367, cultivar Auradur standard variety Saturn 1. This is of great importance for durum wheat in Bulgaria, where sunn pest damage is often an accompanying factor during its cultivation.

Concentration of yellow pigments in the grain is an important sign of durum wheat quality and is due to carotenoids. During the 2014 harvest, the yellow pigment content in the studied sample of genotypes ranged from 6.85-11.74 ppm. All foreign cultivars have high concentration of yellow pigments (8-10 ppm) and give products of the desired colour (6.5-8.3 ppm). In the 2015 harvest, in all genotypes significantly lower levels of yellow pigments were reported compared to 2014 and 2016 harvests, ranging from 5.01-9.45 ppm. The harvest year 2015 is characterized by more rainfall during the vegetation period - 158.2% compared to the norm, incl. during the grain filling phases. According to Graham and Rosser (2000), stress as moisture deficit during the various stages of grain filling or high temperatures influences the concentration and composition of pigments and contributes to the occurrence of genotype-environment interactions. According to the same authors, concentration of pigments correlates slightly positively with average temperatures and slightly negatively with rainfall during grain filling, the latter dependence being confirmed by our results as well. During harvest 2016, the yellow pigment content in the studied sample of genotypes ranged from 5.94-10.93 ppm. On average for the three years of the study the highest content of yellow pigments in the grain have the lines: M-431 (10.71 ppm), M-615 (9.21 ppm), TD-97 (9.83 ppm), the foreign varieties Superdur (9.09 ppm), Selyemdur (9.01 ppm) and the standard variety Predel (9.25 ppm).

The greatest variation in the overall variation of traits in the sample of studied genotypes determined on the basis of variation coefficients, was found for the traits SDS sedimentation volume (CV-44.20%) and yellow pigment content (CV-14.69%), and the least for the protein content of grain (CV-4.43%). The largest variation in individual years was found for the trait wet grain content in grain during the 2014 harvest (CV-22.04%), probably due to the high levels of sunn pest damage in the respective year.

The presence of large variation in the sample of the studied cultivars and breeding lines for the traits SDS-sediment volume and yellow pigment content, as well as the predominant effect of the genotype in this variation are a prerequisite for including genotypes with the highest values on these parameters in hybridization programs for their breeding improvement.

Table 2. Mean values of traits protein content and wet gluten content of grain in durum wheat genotypes

Genotype	Protein content of grain, %				Wet gluten content of grain, %			
	2014 year	2015 year	2016 year	Avarage	2014 year	2015 year	2016 year	Avarage
Predel	15,36	13,79	15,01	14,72	31,2	26,8	30,8	29,6
Saturn-1	14,76	12,79	15,36	14,3	28,4	24,5	31,4	28,1
Severina	15,28	13,76	15,58	14,87	29,2	26,3	31,4	28,97
Superdur	15,81	13,86	15,94	15,2	32	26,7	33	30,57
Selyemdur	14,92	14,11	15,48	14,84	30	27,5	32	29,83
Betadur	14,63	13,94	14,88	14,48	27,2	27,7	30,2	28,37
Auradur	15,53	14,05	16,09	15,22	31,2	27,6	33	30,6
TD-97	15,12	12,78	14,6	14,16	30,4	24,1	28,6	27,7
DF-009114002	15,2	14,06	15,93	15,06	31	27,5	33,4	30,63
D-7724	13,71	13,22	15,52	14,15	24,4	25,6	31	26,98
M-287	16,47	13,36	17,12	15,65	30,6	25,3	35,2	30,37
D-7557	14,09	12,94	15,1	14,04	26	24,9	29,8	26,9
M-6433	16,16	14,99	17,43	16,19	30,8	30,3	36,4	32,5
M-615	14,37	13,86	14,23	14,15	26	26,7	26,6	26,43
M-376	17,65	14,54	16,58	16,26	33,2	28,3	33,4	31,63
M-431	15,3	14,95	15,85	15,37	29,6	30,4	33,4	31,13
D-8138	15,99	13,62	15,68	15,1	29	26,1	30,6	28,57
D-8308	16	14,06	15,44	15,17	1	27,6	29	19,2
D-8326	14,89	13,52	14,17	14,19	26	26,3	27,4	26,57
DV-8359	15,07	12,61	14,42	14,03	28,9	24,2	27,6	26,9
D-8362	15,13	12,77	13,99	13,96	28,8	24,8	27	26,87
D-8370	15,15	12,60	15,75	14,5	29,6	24,1	32,2	28,63
D-7864	15,04	13,18	14,9	14,37	26,8	25,4	29,4	27,2
D-8367	14,55	14,38	15,7	14,88	26,2	28,3	30,6	28,37
Mean x	15,26	13,66	15,45	14,79	27,81	26,54	30,98	28,44
Min/Max	13,71-17,65	12,60-14,99	13,99-17,43	13,96-16,26	1,00-33,2	24,1-30,4	26,6-36,4	19,2-32,5
Variance	0,68	0,49	0,75	0,43	37,59	3,13	6,50	6,94
Std. dev.	0,82	0,70	0,87	0,66	6,13	1,77	2,55	2,64
CV	5,39	5,11	5,61	4,43	22,04	6,67	8,23	9,26

Table 3. Mean values of traits yellow pigment content of grain and SDS-sedimentation value in durum wheat genotypes

Genotype	Content of yellow pigments, ppm				SDS-sedimentation value, sm <sup>3</sup>			
	2014 year	2015 year	2016 year	Avarage	2014 year	2015 year	2016 year	Avarage
Predel	8,97	8,61	10,16	9,25	42	50	46	46
Saturn-1	8,58	6,40	8,31	7,76	46	60	59	55
Severina	6,85	5,77	6,13	6,25	42	46	47	45
Superdur	10,1	7,81	9,36	9,09	57	60	64	60,33
Selyemdur	10,23	7,70	9,1	9,01	60	76,5	74	70,17
Betadur	8,38	6,48	7,92	7,59	43	64	63	56,67
Auradur	8,48	6,41	8,5	7,79	49	61	59	56,33



TD-97	10,51	8,97	10	9,83	43	47	53	47,67
DF-009114002	7,81	6,17	7,06	7,01	68	81	74	74,33
D-7724	8,33	6,88	8,39	7,87	31	30	35	32
M-287	7,23	5,02	6,59	6,27	20	21	24	21,67
D-7557	8,77	7,71	9,01	8,5	19	19	21	19,67
M-6433	7,18	5,01	5,94	6,04	22	21	26	23
M-615	10,12	8,52	8,98	9,21	26	26	31	27,67
M-376	8,84	7,24	7,77	7,95	20	25	20	21,67
M-431	11,74	9,45	10,93	10,71	27	31	30	29,33
D-8138	8,08	6,29	7,45	7,27	29	24	21	24,67
D-8308	7,24	6,51	6,67	6,81	18	26	20	21,33
D-8326	8,62	8,17	9,23	8,67	23	23	28	24,67
DV-8359	10,19	7,06	8,22	8,49	19	18	20	19
D-8362	7,97	5,78	6,76	6,83	60	48	45	51
D-8370	10,17	7,51	9,06	8,91	64	42	50	52
D-7864	9,32	6,64	7,95	7,97	20	24	22	22
D-8367	9,33	7,82	7,98	8,38	59	54	43	52
Mean x	8,88	7,08	8,23	8,06	37,79	40,73	40,63	39,72
Min/Max	6,85- 11,74	5,01- 9,45	5,94- 10,93	6,04- 10,71	18,00- 68,00	18,00- 81,00	20,00- 74,00	19,00- 74,33
Variance	1,54	1,39	1,67	1,40	286,17	370,11	328,94	308,1
Std. dev.	1,24	1,18	1,29	1,18	16,92	19,24	18,14	17,55
CV	13,97	16,68	15,73	14,69	44,76	47,23	44,64	44,20

A correlation analysis has been performed to detect relationships between the studied traits based on the results of the three years of the trial (Table 4). A significant proven positive correlation between protein content and wet gluten content in grain has been found ( $R = 0.52$ ) and this relationship has been reported by a number of other authors (Ames et al., 2003). There are weak and unproven positive interrelationships between gluten strength (SDS-sedimentation volume) and wet gluten quantity in grain and between the yellow pigments and the SDS-sedimentation volume. We also found unproven and weak negative interactions of protein content with gluten strength and yellow pigment content. There is contradictory information in literature relating to the studied relationships. A number of authors report the presence of a positive correlation between protein content and SDS volume (Fowler and De La Roche, 1975; Autran and Galterio, 1989; Galterio et al., 1993; Novaro et al., 1997; Porceddu et al. 1998), and others - for moderate negative correlation (Autran et al., 1986 and Boggini et al., 1997). According to a third group of authors, protein content and gluten quality are independent and unrelated traits (Grzybowski and Donnelly, 1979, Quick and Donnelly, 1980). No proven correlations between yellow pigment content and protein content in grain have been found so far (Ruiz et al., 2005) and our results confirm the same. The contradictory information regarding relationships among the studied traits related to grain quality can probably be explained by the different methods used to measure gluten strength, various genotypes and growing conditions.

Table 4. Correlations ( r ) between grain quality traits in durum wheat

Traits	Wet gluten content of grain	Content of yellow pigments of grain	SDS-sedimentation value
Protein content of grain	0.52*	-0.31	-0.10
Wet gluten content of grain		0.06	0.29
Content of yellow pigments of grain			0.10

\*Significant at 0.05 level of probability

### Conclusions

A statistically reliable influence of genotype, environmental conditions (years) and the interaction among them has been found in the expression of the traits: protein, wet gluten, yellow pigments content in grain and SDS-sedimentation volume. The variation of protein content in grain (51.20%) is due mostly to the environmental conditions, while variation in wet gluten content in grain (45.24%) to the genotype/environment interaction. The variation of the traits yellow pigment content in grain (66.10%) and SDS-sedimentation volume (92.90%) is due to the greatest extent to the genotype.

All genotypes are characterized by a good level of protein quantity and a good potential for its accumulation.

The largest variation in the sample of studied genotypes determined on the basis of the coefficients of variation - CV was found for the traits SDS sedimentation volume and yellow pigment content and the least - for protein content. The presence of large variation in the sample of the studied cultivars and breeding lines on these traits important for durum wheat quality, as well as the predominant influence of the genotype in this variation are a prerequisite for including genotypes with the highest values on these traits in hybridization programs for breeding improvement of Bulgarian durum wheat.

A statistically proven positive correlation between the content of grain protein and gluten and lack of proven correlations between the quantity and quality of protein and yellow pigments have been established.

### References

- Ames N. P., Clarke J. M., Marchylo B. A., Dexter J. E., Woods S. M. (1999). Effect of Environment and Genotype on Durum Wheat Gluten Strength and Pasta Viscoelasticity. *Cereal Chem.* 76(4):582-586.
- Autran J. C., Abecassis J., Feillet P. (1986). Statistical evaluation of different technological and biochemical tests for quality assessment in durum wheats. *Cereal Chem.*, 63: 390-394.
- Autran J. C. and Galterio G. (1989). Associations between electrophoretic composition of proteins, quality characteristics and agronomic attributes of durum wheats II. Protein - quality associations. *Journal of Cereal Science* 9:195-215.
- Blanco A., Zacheo S., Antonacci M., Tribuzio G. and Bufano A.G. (1994). Frumenti diploidi selvatici e miglioramento della qualità del frumento duro. *Atti IV Giornate Internazionali sul Grano Duro, Foggia 1992, Italy*, pp. 101-115.

- Boggini G., Doust M. A., Annicchiarico P. and Pecetti L. (1997). Yielding ability, yield stability and quality of exotic durum wheat germplasm in Sicily. *Plant Breeding* 116:541-545.
- Braaten M. O., Lebsack K. L. and Sibbitt L. D. (1962). Intergeneration relations of physical properties of dough and carotenoid pigment content in durum wheat. *Crop Sci.* 2: 277–281.
- Clarke F. R., Clarke J. M., McCaig T. N., Knox R. E. and DePauw R. M. (2006). Inheritance of yellow pigment concentration in seven durum wheat crosses. *Can. J. Plant Sci.* 86: 133-141.
- Dechev D. (2004). Stability and interaction of durum wheat genotypes with the conditions of years of gluten and protein content in the grain., *Plant Science*, 41, 248-251.
- Dexter J. E. , Matsuo R. R. (1980). Relationship between durum wheat protein properties and pasta dough rheology and spaghetti cooking quality. *J. Agric. Food Chem.*, 28 (5), pp 899–902.
- Dexter J., Marchylo B. A. (2000). Recent trends in durum wheat milling and pasta processing: Impact on durum wheat quality requirements. In: *Durum wheat, semolina and pasta quality*. pp. 77-101.
- Dexter J. E. (2008). The history of durum wheat breeding in Canada and summaries of recent research at the Canadian Grain Commission on factors associated with durum wheat processing. ICC conference, Istanbul, Turkey, 24-27 April, 2008.
- Feillet P., Dexter J. E. (1996). Quality requirements of durum wheat for semolina milling and pasta production. In: J. E. Kruger, R. B. Matsuo, and J. W. Dick, eds. *Pasta and noodle technology*. American Association of Cereal Chemistry, St Paul, MN, p.p. 95–131.
- Feillet P, Autran J. C., Icard-Verniere C. (2000). Bases biochimiques du brunissement des pâtes alimentaires. *Options Méditerranéennes, Série A*, 40: 431-438.
- Fowler D. B. and de la Roche I. A. (1975). Wheat quality evaluation. 3. Influence of genotype and environment. *Canadian Journal of Plant Science* 55:263-269.
- Galterio G., Grita L. and Brunori A. (1993). Pasta making quality in *Triticum durum*. New indices from the ratio among protein components separated by SDS-PAGE. *Plant Breeding* 110:290-296.
- Graham R. D. and Rosser J. M. (2000). Carotenoids in staple foods: Their potential to improve human nutrition. *Food Nutr. Bull.* 21: 404–409.
- Graybosh R. A., Peterson C. J., Baenziger P. S., Shelton D. R. (1995). Environmental modification of hard red winter wheat flour protein composition. *J. Cereal Sci.* 22, 45–51.
- Grzybowski R. A. and Donnelly B. J. (1979). Cooking properties of spaghetti and factors affecting cooking quality. *Journal of Agricultural Food Chemistry* 27:380-384.
- Johnston R. A., Quick J. S., Hammond J. J. (1983). Inheritance of semolina color in six durum wheat crosses. *Crop Sci.*, 23: 607-610.
- Joppa L. R., Williams N. D. (1988). Langdon durum disomic substitution lines and aneuploid analysis in tetraploid wheat. *Genome.* 30:222-228.
- Mariani B. M., D'Egidio M. G., Novaro P. (1995). Durum Wheat Quality Evaluation: Influence of Genotype and Environment. *Cereal Chem.* 72(2):194-197.
- Matsuo R. R., Dexter J. E., Kosmolak F. G., Leisle D. (1982). Statistical evaluation of tests for assessing spaghetti-making quality of durum wheat. *Cereal Chem.*, 59: 222-228.
- Novaro P., D'Egidio M. G., Bacci L. and Mariani B. M. (1997). Genotype and environment: their effect on some durum wheat quality characteristics. *Journal of Genetics and Breeding* 51:247:252.
- Petrova I. (2002). Effect of bug damage on cooking potential of Bulgarian durum wheat varieties depending on their gluten strength. *Bulg. J. Agric. Sci.*, 8: 245-250.

- Petrova I., Cheleev D. (2005). Comparative assessment of the protein / gluten quality criteria for durum wheat. Scientific Works of University of Food Technology, p. 52, pp. 2: 59-64. (Bg)
- Porceddu E., Turchetta T., Masci S., D'ovidio R., Lafiandra D., Kasarda D. D., Impiglia A. and Nachit M. M. (1998). Variation in endosperm protein composition and technological quality properties in durum wheat. *Euphytica* 100:197-205.
- Quick J. S. and Donnelly B. J. (1980). A rapid test for estimating durum wheat gluten quality. *Crop Science* 20(6):816-818.
- Rharrabti Y., Villegas D., Royo C., Martos-Nuñez V., García del Moral L. F. (2003). Durum wheat quality in Mediterranean environments: II. Influence of climatic variables and relationships between quality parameters. *Field Crops Research*, Volume 80, 133-140.
- Ruiz M., Vazquez J. F., Carrillo J. M. (2005). Genetic Bases of Grain Quality, Chapter 12, p 349-375 in *Durum Wheat Breeding, Current Approaches and Future Strategies*, Volume 1, Food Products Press An Imprint of The Haworth Press, Inc. New York, London, Oxford.
- Sissons M. J., Egan N. E., Gianibelli M. C. (2005). New insights into the role of gluten on durum pasta quality using reconstitution method. *Cereal Chem.*, 82: 601-608.
- Zwingelberg H. (1996). Mahleigenschaften von Durumweizenprovenienzen. *Getreide Mehl Brot*, 50 (6): 328-332.

## BEAN (*PHASEOLUS VULGARIS* L.) GERMINATION AND SEEDLING GROWTH AS AFFECTED BY SILVER NANOPARTICLES

Amal Z. HEGAZI<sup>1\*</sup>, Fatma A. GHARIB<sup>2</sup>, Safia M. GHAZI<sup>2</sup>, Asmaa G. ABD EL HAFZ<sup>2</sup>  
Ahmed I. EL-BATAL<sup>3</sup>

<sup>1</sup> Vegetable crops seed production and technology dept. Horticulture Research Institute, Agriculture Research Centre, Giza, Egypt

<sup>2</sup> Botany and Microbiology dept., Faculty of science, Helwan University, Egypt

<sup>3</sup> Drug Radiation Research Dept, Biotechnology Division, National Centre for Radiation Research and Technology (NCRRT), Atomic Energy Authority, Cairo, Egypt

\*Corresponding author: hegaziamal@gmail.com

### Abstract

Silver nanoparticles (AgNPs) are one of the most widely used engineered nanoparticles (ENPs) that are expected to enter natural ecosystems. This study reports on the effect of soaking three cultivars (Bronco, Nebraska and Valantino) of the common bean (*Phaseolus vulgaris* L.) for 12h in aerated solution of gum Arabic-coated silver nanoparticles (GA-AgNPs  $\approx$ 16.7nm), polyvinyl pyrrolidone- coated silver nanoparticles (PVP-AgNPs  $\approx$ 23 nm), and silver nitrate (AgNO<sub>3</sub>), each at 0.0, 10, 20, 40, 60, 80 and 100 ppm, on germination and seedling growth. The control and the treated seeds were germinated at 25°C  $\pm$ 0.5 under dark controlled conditions for 7 days. AgNPs and AgNO<sub>3</sub> significantly improved germination percentage, germination rate and seedling growth criteria of the three tested cultivars, as compared with their corresponding controls. The three cultivars responded in more or less similar trends to the different concentrations of the treatment solutions. With the three cultivars under study, the magnitude of improvement was always greater for GA-AgNPs than for PVP-AgNPs and AgNO<sub>3</sub>. Moreover, both AgNPs and AgNO<sub>3</sub> up to 100 ppm significantly increased the activities of polyphenol oxidase, peroxidase and catalase than those of the control. Meanwhile, the enzyme activities progressively increased with the increase of each of the AgNPs under investigation, as well as AgNO<sub>3</sub>. The results indicated successful use of AgNPs and AgNO<sub>3</sub> up to 60 and 40 ppm, respectively, for enhancing the germination potential and subsequent seedling growth of the bean cultivars under study.

**Key words:** *Bean; Phaseolus vulgaris; Silver Nanoparticles; Silver nitrate; Antioxidant enzymes*

### Introduction

Common bean (*Phaseolus vulgaris* L.), family *Fabaceae*, is an economically important vegetable crop produced throughout the world for its edible fruit. Beans are important food to people of all income categories as a source of dietary protein, complex carbohydrates, fibers and other important dietary necessities (Kutoš *et al.*, 2003). Dry beans contain high levels of phenols, starch, vitamins, fibre and fructo-oligosaccharides (Cristiane *et al.*, 2013).

Silver is an important plant-growth stimulator, including silver salt (Ag NO<sub>3</sub>), silver silicate and silicate with a water soluble polymer (Sharon *et al.*, 2010). Silver nanoparticles (AgNPS) are atomic or molecular aggregates, with at least one dimension between 1 and 100 nm (Roco 2003), that can drastically modify their physico-chemical properties, compared to the bulk material (Nel *et al.*, 2006). Silver nanoparticles are synthesized by chemical reduction using polyvinyl pyrrolidone as a dispersant (Zhang *et al.*, 1996), by gamma rays irradiation at room

temperature and ambient pressure (El-Batal *et al.*, 2013& 2014), and via green synthesis using gum acacia (gum Arabic) as stabilizer for capping silver nanoparticles. The interaction of plant cell with the engineered nanoparticles leads to the modification of plant gene expression and associated biological pathways, which eventually affect plant growth and development (Khiew *et al.*, 2011; Feizi *et al.*, 2013). The impact of AgNPs on higher plants appears to depend on the species, age of plant, the size and concentration of the particles and the experimental conditions (Khiew *et al.*, 2011). Silver nanoparticles increased root elongation of *Eruca sativa* seedlings at 10 mg Ag/L of either PVP-AgNPs or AgNO<sub>3</sub> (Vannini *et al.*, 2013) and enhanced seedlings growth of *Brassica juncea* at 25 and 50 ppm silver nanoparticle (Sharma *et al.*, 2012a). However, the mechanisms that mediate the effects of AgNPs in plants remain unknown. Therefore, it is important to increase our knowledge about these mechanisms before implementing large-scale agricultural utilization of AgNPs.

Thus, the present study intended to investigate the effect of soaking three cultivars (Bronco, Nebraska and Valantino) of common bean (*Phaseolus vulgaris* L.) in different concentrations of gum Arabic- coated silver nanoparticles (GA-AgNPs), poly-vinyl pyrrolidone- coated silver nanoparticles (PVP-AgNPs) and silver nitrate AgNO<sub>3</sub> on the percent and rate of seed germination, seedlings growth criteria, as well as to evaluate their possible effect on the activities of some antioxidant enzymes in Bronco and Nebraska seedlings.

## Materials and Methods

### Synthesis of silver nanoparticles

Gum Arabic (GA) coated silver nanoparticles (GA-AgNPs≈16.7nm) and poly vinylpyrrolidone (PVP) coated silver nanoparticles (PVP-AgNPs≈23 nm) were synthesized using gamma-radiolytic reduction method at 15 kGy dose and 1mM AgNO<sub>3</sub>. Silver nanoparticles (GA-AgNPs and PVP-AgNPs) were characterized by UV-vis spectroscopy, dynamic light scattering (DLS), transmission electron microscopy (TEM), fourier transform infrared (FT-IR) spectroscopy and X-ray diffraction (XRD) according to Abd El Hafz (2016) and El-Batal *et al.* (2016).

### Plant Materials and Treatments

A homogenous lot of seeds of three cultivars (Bronco, Nebraska and Valantino) of common bean (*Phaseolus vulgaris* L.) were provided by the Horticulture Research Institute, Agriculture Research Center, Giza, Egypt. The seed indexes, i.e. weight of 100 seeds of the used cultivars are 14.44, 46.47 and 24.02 for Bronco, Nebraska and Valantino, respectively.

The seeds of the three bean cultivars were surface sterilized and then washed thoroughly with bi-distilled water. Afterwards, seeds of each variety were equally divided into two batches and each batch was subdivided into groups (100 seeds each) to be soaked in the different working solutions. Soaking of seeds was carried out by arranging a constant number of seeds of each batch in a zigzag pattern on Whatman No.3 filter paper of constant area (20 X 60 cm). Afterwards, the rolls were placed for 12 h in an upright position in plastic boxes, each containing a constant amount of the treatment solutions (GA-AgNPs, PVP-AgNPs and AgNO<sub>3</sub>) at concentrations of 20, 40, 60, 80 and 100 ppm, in addition to distilled water as a control. Soaking was carried out in a controlled cabinet (germinator) at 25°C ±0.5 under dark conditions. Afterwards, the seeds of the control and each treatment (4 replicates, 25 seeds each) were washed thoroughly with distilled water, and then allowed to germinate (as the method described previously but the plastic boxes were containing constant amounts of distilled water) for 7 days. The different germination and growth criteria were recorded for the three tested cultivars. The germination experiment was carried out in 2014 at Vegetable Crop Seed Production and Technology Department, Horticulture Research Institute, Agriculture Research Center, Egypt.

### **Growth Measurement**

The germination percentage (%) and the germination rate (days to complete germination) were calculated. At least 10 randomly choice 7-day-old seedlings were taken from each treatment and the control for measurements of different growth criteria (seedling and root length (cm), fresh and dry weights (g) per seedling). The collected samples were either dried in an oven at 105°C until constant dry weight was obtained or representative fresh samples were taken for determination of fresh weights and assaying enzymatic activities.

### **Enzyme Activities**

Catalase, peroxidase and polyphenol oxidase activities were assayed in 7-day-old seedlings of Bronco and Nebraska cultivars presoaked for 12 h in GA-AgNPs, PVP- AgNO<sub>3</sub> or AgNO<sub>3</sub> solutions, each at 0.0, 20, 60 and 100 ppm following the method of Kar & Mishra (1976) with some modification as described by Iturbe-Ormaetxe *et al.* (1998). Peroxidase and polyphenol oxidase activities were expressed as the change in optical density/g fresh weigh/hour at 430 nm. Catalase activity was expressed as μM H<sub>2</sub>O<sub>2</sub> destroyed/g fresh weight/hour.

### **Statistical analysis**

Statistical Analysis of the data was carried out using one-way analysis of variance (ANOVA) using least significant difference (LSD at 5% level) according to Snedecor & Cochran (1990) followed by Duncan's Multiple Comparison Test (Duncan 1955).

## **Results and Discussion**

In this study, the germination percentage and the rate of germination of the control (H<sub>2</sub>O) and the differently treated three bean cultivars (Bronco, Nebraska and Valantino) under study are shown in Table 1. The germination percentage and rate were generally significantly enhanced, as compared to corresponding controls, in response to soaking for 12 hours in different concentrations of gum Arabic-coated silver nanoparticles (GA-AgNPs), poly-vinyl pyrrolidone-coated silver nanoparticles (PVP-AgNPs) and AgNO<sub>3</sub>. Moreover, the percentage of abnormal germination was also reduced, in response to the different applied treatments (Table 1). With the three cultivars under study, best results were obtained in response to soaking seeds in solutions at 60 ppm of either GA-AgNPs or PVP-AgNPs, or 40 ppm AgNO<sub>3</sub>. However, the germination percentage and rate of the three bean varieties were positively affected by increasing GA-AgNPs or AgNPs up to 60 ppm and AgNO<sub>3</sub> concentrations up to 40 ppm, and then these values were progressively decreased at higher concentrations (still higher than control). These conclusions were in alliance with those obtained with *Brassica juncea*, in response to treatment with 100 ppm silver nanoparticles (Sharma *et al.*, 2012a) and 25 ppm gold nanoparticles (Arora *et al.*, 2012). The enhanced percentage of germination might be attributed to an increased permeability of the seed testa, thus facilitating the admission of water and di-oxygen into the cells, which would then accelerate germination and concomitant metabolic processes (Zheng *et al.*, 2005). In this connection, nanoparticle solutions showed different effects on seed germination of different plants (Rico *et al.*, 2011). Table 2 shows the main growth criteria of 7-day-old seedlings resulting from pre-sowing seed soaking for 12 hours in different concentrations of each of the two experimented silver nanoparticle solutions (GA-AgNPs and AgNPs) and AgNO<sub>3</sub>. In case of the control, the seedling and the root lengths as well as the fresh and dry weights per seedling were highest in Nebraska

Table 1: Percentage of normal and abnormal germination and rate of germination of three bean varieties (Bronco, Nebraska and Valentino) as affected by presoaking of seeds for 12h in gum Arabic- coated silver nanoparticles (GA-AgNPs), poly-vinyl pyrrolidone- coated silver nanoparticles (PVP-AgNPs) and AgNO<sub>3</sub>, followed by 7 days germination at 25°C±0.5. The rate of germination represents time (days) required for maximum germination. Each value represents the mean of 4 replicates (each of 50 seeds) for germination potential. Different letters indicate significant differences between treatments (Duncan test, P ≤ 0.05). The means in each column followed by similar letters are not significantly different.

Treatments	Conc. (ppm)	Normal germination (%)			Abnormal germination (%)			Total germination (%)			Germination rate (days)		
		Bronco	Nebraska	Valentino	Bronco	Nebraska	Valentino	Bronco	Nebraska	Valentino	Bronco	Nebraska	Valentino
Control	0.0	84 f	77 h	76 f	3 de	3 b	2 c	87 e	80 g	78 h	1.35 a	1.41 a	1.25 a
GA-AgNPs	20	91 de	89 de	91 cd	1 ef	1 bc	1 c	92 d	90 e	92 e	1.17 efg	1.13 g	1.08 f
	40	96 ab	98 ab	98 a	1 ef	0 c	0 c	97 abc	98 b	98 b	1.02 j	1.08 h	1.04 gh
	60	98 a	100 a	100 a	1 ef	0 c	0 c	99 a	100 a	100 a	1.02 j	1.02 k	1.00 i
	80	96 ab	99 a	100 a	1 ef	1 bc	0 c	97 abc	100 a	100 a	1.03 j	1.04 j	1.02 hi
	100	89 e	99 a	98 a	3 de	1 bc	1 c	92 d	100 a	99 ab	1.19 de	1.04 j	1.08 f
PVP-NPs	20	90 e	88 fg	91 cd	2 def	2 bc	1 c	92 d	90 e	92 e	1.22 c	1.21 d	1.12 e
	40	94 bc	92 c	95 b	2 def	2 bc	1 c	96 bc	94 c	96 c	1.08 i	1.12 g	1.06 fg
	60	98 a	99 a	100 a	0 f	1 bc	0 c	98 ab	100 a	100 a	1.06 i	1.04 j	1.02 hi
	80	93 cd	96 b	100 a	3 de	2 bc	0 c	96 bc	98 b	100 a	1.16 fg	1.06 i	1.04 gh
	100	85 f	84 g	85 e	6 bc	6 a	5 b	91 d	90 e	90 f	1.21 cd	1.19 e	1.13 de
AgNO <sub>3</sub>	20	89 e	86 fg	90 d	3 de	2 bc	2 c	92 d	88 f	92 e	1.30 b	1.32 b	1.16 bc
	40	95 bc	91 cd	91 cd	1 ef	1 bc	1 c	96 bc	92 d	92 e	1.11 h	1.13 g	1.08 f
	60	91 de	90 cde	93 bc	4 cd	2 bc	1 c	95 c	92 d	94 d	1.15 g	1.17 f	1.12 e
	80	85 f	86 fg	83 e	7 ab	6 a	9 a	92 d	92 d	92 e	1.18 ef	1.21 de	1.15 cd
	100	81 g	72 i	78 f	9 a	8 a	10 a	90 d	80 g	88 g	1.30 b	1.30 c	1.18 b
LSD 5%		2.48	2.06	2.35	2.41	2.66	2.23	2.04	1.99	1.81	0.024	0.018	0.026



Table 2: Growth criteria of 7 day-old seedlings (germinated at 25°C±0.5) of three bean varieties (Bronco, Nebraska and Valentino) as affected by seed presowing for 12h in gum Arabic- coated silver nanoparticles (GA-AgNPs), poly-vinyl pyrrolidone- coated silver nanoparticles (PVP-AgNPs) and AgNO<sub>3</sub>. Each value represents the mean of 10 replicates for growth criteria. Different letters indicate significant differences between treatments (Duncan test, P ≤ 0.05). Means, in each column, followed by similar letters are not significantly different.

Treatments	Conc. (ppm)	Seedling length (cm)			Root length (cm)			Seedling fresh weight (g)			Seedling dry weight (g)		
		Bronco	Nebraska	Valentino	Bronco	Nebraska	Valentino	Bronco	Nebraska	Valentino	Bronco	Nebraska	Valentino
Control	0.0	22.1 n	28.0 n	24.9 o	13.8 l	14.2 n	12.6 p	5.07 o	8.38 n	6.33 o	0.160 k	0.607 l	0.365 k
GA-AGNPs	20	35.4 e	34.7 h	30.5 h	15.8 f	18.5 f	14.6 j	6.60 e	11.10 d	8.30 g	0.380 d	0.947d	0.560 F
	40	38.4 c	37.5 d	35.7 ef	19.3 b	20.6 c	20.1 c	7.27 c	11.30 c	8.71 d	0.440 c	1.025 c	0.617 d
	60	40.1 a	42.7 a	45.8 a	20.3 a	22.5 a	21.2 a	8.13 a	12.47 a	10.05a	0.570 a	1.157 a	0.767 a
	80	37.7 d	38.4 c	41.4 b	16.1 e	19.6 d	20.9 b	6.24 h	10.76 f	9.35 b	0.280 g	0.927de	0.720 c
	100	30.3 h	31.8 i	40.2 c	14.5 i	18.1 g	19.7 d	6.04 l	10.30 h	8.05 j	0.210 i	0.787 i	0.510 h
PVP-NPs	20	31.5 g	31.6 j	28.5 l	15.1h	16.2 h	14.2 l	6.50 g	9.97 j	8.21 h	0.340 e	0.835 h	0.530 g
	40	35.5 e	35.7 f	29.1 k	15.9 f	18.8 e	15.0 i	7.08 d	10.78 e	8.52 e	0.400 d	0.925 e	0.597 e
	60	39.3 b	42.4 b	37.5 d	18.4 d	22.3 b	18.9 e	7.55 b	11.38 b	9.28 c	0.470 b	1.090 b	0.740 b
	80	31.5 g	36.8 e	35.5 f	15.1 g	18.1 g	18.1 f	6.13 j	10.56 g	7.75 k	0.250 h	0.885 f	0.507 h
	100	28.2 k	31.4 k	35.8 e	14.1 k	14.5 m	16.8 g	5.39 m	9.12 l	7.70 l	0.190 j	0.675 k	0.450 i
AgNO <sub>3</sub>	20	29.3 i	30.6 m	26.7 m	14.3 j	15.1 k	13.4 n	6.17 i	9.67 k	8.12 i	0.310 f	0.760 j	0.51gh
	40	34.5 f	35.0 g	31.7 g	18.8 c	16.3 h	16.6 h	6.57 f	10.31 h	9.26 c	0.340 e	0.907 e	0.710 c
	60	29.1 j	31.7 i	30.0 i	14.6 i	15.3 i	14.4 k	6.12 j	10.17 i	8.45 f	0.280 g	0.857 g	0.565 f
	80	26.7 l	31.4 k	29.8 j	14.4 j	15.2 j	13.7 m	6.09 k	9.66 k	7.51 m	0.250 h	0.785 i	0.445i
	100	24.2 m	30.9 l	26.0 n	14.0 k	14.6 l	12.8 o	5.15n	8.40 m	7.20 n	0.180 j	0.627 l	0.405 j
LSD 5%		0.131	0.122	0.146	0.075	0.075	0.113	0.016	0.013	0.031	0.023	0.020	0.018

cultivar followed by those in Valentino. In case of the different three applied treatments, the above mentioned growth criteria of seedlings were mostly significantly increased, relative to corresponding controls, from 20 to 80 ppm concentrations. In this respect, best performance was induced by 60 ppm of either GA-AgNPs or AgNPs and 40 ppm AgNO<sub>3</sub>. Regarding the stimulatory effects of the experimented AgNPs, GA-AgNPs was more efficient than AgNPs at comparable concentrations. GA- AgNPs at 60 ppm induced highest significant increase in the seedling fresh and dry weights. Our results could be reinforced by those of other workers where rise in the concentration of AgNPs from 20 to 60 ppm increased shoot and root lengths of common bean (*Phaseolus vulgaris* L.) and corn (*Zea mays* L.) crops (Salama 2012), as well as root elongation of *Eruca sativa* seedlings, in response to PVP-AgNPs or AgNO<sub>3</sub> (Vannini *et al.*, 2013). Promotion of plant growth by AgNPs was also recorded in *Brassica juncea* (Sharma *et al.*, 2012a) as well as *Panicum virgatum* and *Phytolacca americana* (Yin *et al.*, 2012). The enhanced seedling growth rates might be attributed to a nanoparticle- elevation effect of some enzyme activities, stimulation of antioxidant activity, and increased abilities for absorbing and utilizing water, as has been concluded by Lu *et al.* (2002) in soybeans. Such increases might be also assumed to be mediated by NPs-modulation of endogenous phytohormones that are known to balance cell proliferation (Shu *et al.*, 2015; Li *et al.*, 2016). In the present study, the activity levels of the antioxidant enzymes peroxidase (POD), catalase (CAT) and polyphenol (PPO) oxidase were assayed in 7-day-old seedlings of cultivars Bronco and Nebraska. In this respect, H<sub>2</sub>O<sub>2</sub> as a strong oxidant that produces highly active OH<sup>-</sup> via the Haber–Weiss reaction (Kehrer 2000), can be decomposed into H<sub>2</sub>O and O<sub>2</sub> by peroxidase (POD) and catalase (CAT), thereby preventing potential ROS damage to plants (Rakhra *et al.*, 2015). Farther, Phenol compounds leads to more powerful radical scavenging activity (Siddique *et al.*, 2010; Spiridon *et al.*, 2011), therefore functional analysis of polyphenol oxidases is of peculiar significance. The results of the present work showed that presowing soaking treatments of seeds for 12 h in GA-AgNPs, PVP-AgNPs and AgNO<sub>3</sub> solutions induced progressively increased activities of POD, CAT, and PPO, in the 7-day-old seedlings of Bronco and Nebraska cultivars, with increasing the concentrations of each solution from 20 up to 100 ppm (Figure 1). The activities of the above mentioned enzymes in seedlings of the two cultivars were obviously higher than those of corresponding controls, particularly with 60 and 100 ppm treatments. In both the studied cultivars, the enhancement effect was maximum for the three enzymes (POD, CAT, and PPO) at 100 ppm AgNO<sub>3</sub> treatment, followed by PVP-AgNPs and finally GA-AgNPs, each also at 100 ppm. The results of the present work, indicating enhancement of antioxidant enzymes in response to AgNPs and AgNO<sub>3</sub> treatments, were consistent with those of Krishnaraj *et al.* (2012) in leaf samples of *Bacopa monnieri* plants subjected to AgNPs treatment, Sharma *et al.* (2012a) in *Brassica juncea* seedlings using AgNPs, and Wang *et al.* (2015) in radish root using AgNPs and AgNO<sub>3</sub>.

According to Krasensky & Jonak (2012), the metabolic network of plants must be reconfigured under different conditions in order to allow both the maintenance of metabolic homeostasis and the production of compounds that ameliorate any stress. To this extent we might conclude that the network of antioxidant/ oxidant levels might be taken as markers to speculate the most suitable treatments for the bean cultivars under investigation. Thus, on these bases, the efficacy of the production of compounds that ameliorate any stress.

To this extent we might conclude that the network of antioxidant/ oxidant levels might be taken as markers to speculate the most suitable treatments for the bean cultivars under investigation. Thus, on these bases, the efficacy of the applied treatments can be arranged in the following order: GA- AgNPs> PVP-AgNPs> AgNO<sub>3</sub>, with exclusion of 100ppm of each.

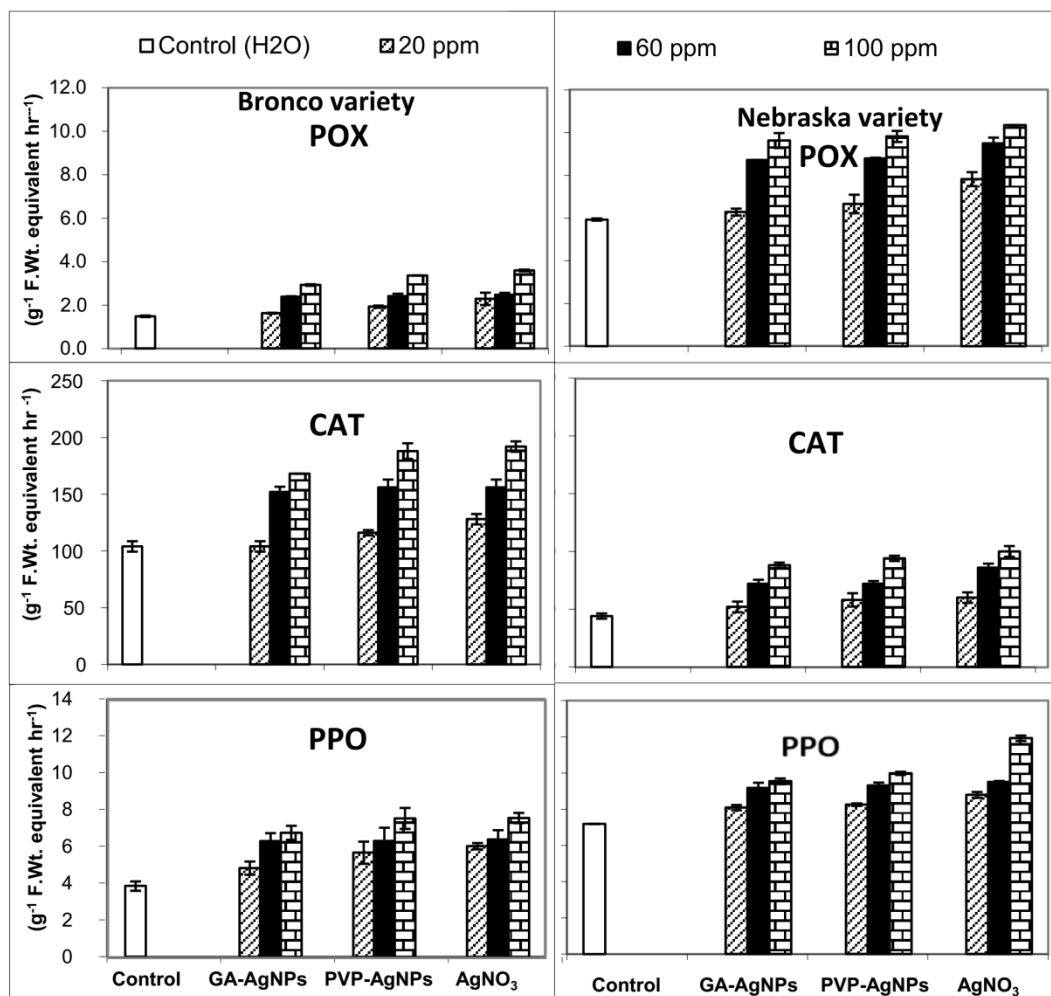


Figure 1: Changes in the activities of peroxidase (POX), catalase (CAT) and polyphenol oxidase (PPO) (/g fresh weight/ hour) of 7-day-old seedlings of Bronco and Nebraska varieties as affected by seed presoaking for 12h in silver nanoparticles (GA-AgNPs, PVP-AgNPs) or silver nitrate (AgNO<sub>3</sub>) each at 0, 20, 60 and 100 ppm and grown in dark at 25°C±0.5. Vertical bars represent ± SE.

In this respect, it should be mentioned that the differential enhanced POD, CAT and PPO activities as antioxidants are assumed to represent a defense of the studied common bean cultivars against reactive oxygen species (ROS) alleviation resulting from AgNPs and AgNO<sub>3</sub> treatments. The inconsistent trends in our results for CAT in Bronco cultivar might therefore be due to: a. different adaptation strategies in Bronco and Nebraska to cope with the applied treatments, and b. efficient scavenging of ROS requires the action of other antioxidant enzymes and nonenzymatic antioxidants that have not been assayed herein. In this connection, Sharma *et al.* (2012b) reviewed that whether ROS would serve as signaling molecules or could cause oxidative damage to the tissues depends on the delicate equilibrium between ROS production, and their scavenging.

## Conclusion

The present study demonstrates that seed soaking three common bean cultivars (Bronco, Nebraska and Valentino) in solutions of AgNPs (GA-AgNPs, PVP-AgNPs) and AgNO<sub>3</sub> solutions at different concentrations (20-100 ppm) significantly improved germination percentage, germination rate and seedling growth criteria, as compared to corresponding controls. Generally, GA-AgNPs was the most effective treatment in enhancing germination potentials and seedling growth parameters followed by PVP-AgNPs and finally AgNO<sub>3</sub> treatment, compared to controls. A reverse situation was recorded with the antioxidant enzymes POD, CAT, and PPO, where their activities were highest in treatment with AgO<sub>3</sub> followed by PVP-AgNPs and finally GA-AgNPs.

## References

- Abd El Hafz A.G.M. (2016). Physiological Study on Effects of Silver Nanoparticles on Germination and Growth of Bean (*Phaseolus vulgaris* L.) Plant. M.Sc. Thesis in Plant Physiology, Botany and Chemistry Department, Helwan University, Cairo, Egypt.
- Arora S., Sharma P., Kumar S., Nayan R., Khanna P.K., Zaidi M.G.H. (2012). Gold-nanoparticle induced enhancement in growth and seed yield of *Brassica juncea*. *Plant Growth Regul.* 66: 303–310.
- Cristiane R.S., Carlos A., Schlege V. (2013). Pinto beans (*Phaseolus vulgaris* L.) as a functional food: Implications on Human Health. *Agric.* 3: 90–111.
- Duncan D.B. (1955). Multiple Range and Multiple F Test. *Biometrics.* 11: 1–42.
- El-Batal A.I., Gharib F.A.E., Ghazi S.M., Hegazi A.Z., Abd El Hafz A.G.M. (2016). Physiological responses of two varieties of common Bean (*Phaseolus vulgaris* L) to foliar application of silver nanoparticles. *Nanomaterials and Nanotechnology.* 6 (13): 1-16.
- El-Batal A.I., El-Baz A.F., Abo Mosalam F.M., Tayel A.A. (2013). Gamma irradiation induces silver nanoparticles synthesis by *Monascus purpureus*. *J. Chem. Pharm. Res.* 5: 1–15.
- El-Batal A.I., Haroun B.M., Farrag A.A., Baraka A., El-Sayyad G.S. (2014). Synthesis of silver nanoparticles and incorporation with certain antibiotic using gamma irradiation. *Br. J. Pharm. Res.* 4: 1341.
- Feizi H., Amirmoradi H., Abdollahi F., Pour S.J. (2013). Comparative effects of nanosized and bulk titanium dioxide concentrations on medicinal Plant *Salvia officinalis* L. *Annu. Rev. Res. Biol.* 3: 814–24.
- Iturbe-Ormaetxe I., Isuredo P.R., Arrese-Igor C., Becana C. (1998). Oxidative damage in Pea plants exposed to water deficit or paraquat. *Plant Physiol.* 116: 173–181.
- Kar M., Mishra D. (1976). Catalase, Peroxidase and Polyphenol oxidase activities during rice leaf senescence. *Plant Physiol.* 57: 315.
- Kehrer J.P. (2000). The Haber–Weiss reaction and mechanisms of toxicity. *Toxicology.* 149: 43–50.
- Khiew P., Chiu W., Tan T., Radiman S., Abd-Shukor R., Chia C.H. (2011). Palm Oil: Nutrition, Uses and Impacts. Capping effect of palm-oil based organometallic ligand towards the production of highly monodispersed nanostructured material. *Nova Science.* 189–219.
- Krasensky J., Jonak C. (2012). Drought, salt and temperature stress-induced metabolic rearrangements and regulatory networks. *J. Exp. Bot.* 63: 1593–1608.

- Krishnaraj C., Jagan G., Ramachandran R., Abirami S.M., Mohan N., Kalaichelvan P.T. (2012). Effect of biologically synthesized silver nanoparticles on (*Bacopa monnieri* L.). *Wettst. Plant growth metabolism. Process Biochem.* 47: 651–658.
- Kutoš T., Golob T., Kač M., Plestenjak A. (2003). Dietary fiber content of dry and processed beans. *Food Chem.* 80: 231–235.
- Li C., Li J., Chong K., Harter K., Lee Y., Leung J., Martinoia E., Matsuoka M., Offringa R., Qu L., Schroeder J., Zhao Y. (2016). Toward a molecular understanding of plant hormone actions. *Molecular Plant.* 9: 1–3.
- Lu C.M., Zhang C.Y., Wu J.Q., Tao M.X. (2002). Research of the effect of nanometer on germination and growth enhancement of *Glycine max* and its mechanism in Soybean. *Sci.* 21: 168–172.
- Nel A., Xia T., Mädler L., Li N. (2006). Toxic potential of materials at the nano level. *Sci.* 311: 622–627.
- Rakhra G., Sharma A.D., Singh J. (2015). Anti-oxidative potential of boiling soluble antioxidant enzymes in amelioration of drought-induced oxidative stress in tolerant and sensitive cultivars of *Triticum aestivum*. *J. Crop. Sci. Biotechnol.* 18: 103-122.
- Rico C.M., Majumdar S., Duarte-Gardea M., Peralta-Videa J.R., Gardea T.J.L. (2011). Interaction of nanoparticles with edible plants and their possible implications in the food chain. *J. Agric. Food Chem.* 59: 3485–3498.
- Roco M.C. (2003). Broader societal issue on nanotechnology. *J. Nano. Res.* 5: 181–189.
- Salama H.M.H. (2012). Effects of silver nanoparticles in some crop plants, common bean (*Phaseolus vulgaris* L.) and corn (*Zea mays* L.). *Int. Res. J. Biotech.* 3: 190-197.
- Sharma P., Jha A.B., Dubey R.S., Pessarakli M. (2012b). Reactive oxygen species, oxidative damage, and antioxidative defense mechanism in plants under stressful conditions. *J. Bot.* 2012: 1-26.
- Sharma P., Bhatt D., Zaidi M.G.H., Saradhi P.P., Khanna P.K., Arora S. (2012a). Silver nanoparticle-mediated enhancement in growth and antioxidant status of *Brassica juncea*. *Appl. Biochem. Biotechnol.* 167: 2225–2233.
- Sharon M., Choudhary A.K., Kumar R. (2010). Nanotechnology in agricultural diseases and food safety. *J. Phytol.* 2: 83–92.
- Shu K., Liu X.D., Xie Q., He Z.H. (2015). Two faces of one seed: hormonal regulation of dormancy and germination. *Mol. Plant.* 9 (1): 34-45.
- Siddique N.A., Mujeeb M., Najmi A.K., Akram M. (2010). Evaluation of antioxidant activity, quantitative estimation of phenols and flavonoids in different parts of *Aegle marmelos*. *African J. Plant Sci.* 4: 1-5.
- Snedecor G.W., Cochran W.G. (1990). *Statistical methods*, 8th ed. Ames: Iowa State University Press.
- Spiridon I., Bordirlau R., Teaca C. (2011). Total phenolic content and antioxidant activity of plants used in traditional Romanian herbal medicine. *Central Eur J Biol.* 6: 388- 396.
- Vannini C., Domingo G., Onelli E., Prinsi B., Marsoni M., Espen L., Bracale M. (2013). Morphological and proteomic responses of *Eruca sativa* exposed to silver nanoparticles or silver nitrate. *PLOS One.* 8: 1–8.
- Wang L., Zhu J., Wu Q., Huang Y. (2015). Effects of silver nanoparticles on seed germination and seedling growth of radish (*Raphanus sativus* L.). *International Conference on Civil, Mater. Environ. Sci. (CMES 2015)*.
- Zhang Z., Zhao B., Hu L. (1996). PVP protective mechanism of ultrafine silver powder synthesized by chemical reduction processes. *J. Solid State Chem.* 121: 105–110.
- Zheng L., Hong .F, Lu S., Liu C. (2005). Effect of nano-TiO<sub>2</sub> on strength of naturally aged seeds and growth of spinach. *Biol. Trace Element Res.* 104: 83–91.

## RESPONSE OF WHEAT GROWTH ANALYSIS AND NITROGEN USE EFFICIENCY TO NITROGEN LEVELS AND SEEDING RATES

El-Sayed GHEITH\*, El-Metwally EL-METWALLY, Ramadan SHEMI

Agronomy Department, Faculty of Agriculture, Cairo University, Egypt

\*Corresponding author: Gheith2010@yahoo.com

### Abstract

Two field experiments were carried out during 2014/2015 and 2015/2016 seasons at Agricultural and Experimental Research Station at Giza, Faculty of Agriculture, Cairo University, Egypt to study the influence of three nitrogen levels (75, 100 and 125 kg N/fad.), one faddan = 4200m<sup>2</sup>, three seeding rates (200, 300 and 400 grains/m<sup>2</sup>) on growth of three wheat cultivars (Sakha-94, Gemmiza-9 and Giza-168). Flag leaf area in both seasons, absolute growth rate (AGR), leaf area index (LAI) at 80 and 100 days in the second season, net assimilation rate (NAR) increased significantly with increasing N levels up to 125 kg N/fad. Nitrogen use efficiency (NUE) significantly decreased with increasing N levels. Seeding rates significantly affected LAI and AGR at 80 in the first season as well as AGR at 80 and 100 days in both seasons. The highest values for the previous traits were produced with seeding 300 or 400 grains/m<sup>2</sup>. Seeding rates did not affect NAR and NUE. All studied traits except AGR at 80 days in the second season, NAR at 80 days in the first one and NUE in both seasons were significantly affected by cultivars. All interactions had significant effect on some studied traits either in one season or in both seasons. Some interactions had significant effect on NAR. Moreover, none of the tested interactions affected NUE significantly. The overall findings indicated that seeding Gemmiza-9 or Giza-168 with 300 or 400 grains/m<sup>2</sup> and application of 125 kg N/fad. could be more beneficial in the study area.

**Key words:** *Wheat, N levels, seeding rates, cultivars.*

### Introduction

Wheat (*Triticum aestivum* L.) is cultivated worldwide primarily/mainly as a food commodity. It is one of the type dominate crop in the world as well as in Egypt. During recent years, many approaches have been made towards improvement yield potentials of wheat crop. Men depend on wheat crop for food and feed animals (Hussain *et al.*, 2012 ; Gheith *et al.*, 2013). Nitrogen fertilization is the most important factors in front of wheat agronomist for achieving large grain yield targets. Crop growth parameters depend on environment condition. Achieving higher growth of wheat is well governed by planting on suitable density and applying of optimal nitrogen levels and favorable climatic condition. The growth attributes are directly influenced by different nitrogen levels (Iftikhar *et al.*, 2012; Achakzai, 2012; Gheith *et al.*, 2013) as well as by cultivars (Javaid Iqbal *et al.*, 2012; Gheith *et al.*, 2013). It is a well-established fact that plant structure is determined by growth parameters such as dry matter accumulation, flag leaf area, leaf area index, crop growth rate, relative growth rate, net assimilation rate, relative water content, relative chlorophyll content, plant height and number of tillers/m<sup>2</sup>. These concepts not only involve the final crop yield and its components, but a probe into physiological events that have occurred early in the growth stages causing variation in yield potential (El-Seidy *et al.*, 2015). The present study was designed to investigate the effect of nitrogen fertilizer levels, seeding rates on growth of three wheat cultivars.

## Materials and methods

Wheat cultivars (Sakha-94, Gemmiza-9 and Giza-168) were studied under three seeding rates (200, 300 and 400 grains/m<sup>2</sup>) and three nitrogen levels, i.e. 75, 100 and 125 kg/fad. (one faddan = 4200 m<sup>2</sup>). Experiments were conducted at Agricultural and Experimental Research Station at Giza, Faculty of Agriculture, Cairo University, Egypt during two successive winter seasons 2014/2015 and 2015/2016. The experimental soil was clay loam in texture with 1.6 and 1.9% organic matter, 46.5 and 49.8 ppm available N, 13.7 and 15.3 ppm available P, 336.0 and 367 ppm available K, 2.3 and 2.4 mmhos/cm 25<sup>0</sup> CEC and 7.6 and 7.7 PH in both seasons, respectively.

The preceding crop was corn in the two seasons. Grains of each cultivar were sown in 10 rows (2.0 m long and 20 cm apart) on the third week of November in both seasons. These experiments were laid out in a randomized complete block design having split-split-plot arrangement with four replications. All recommended culture practices were applied according to Ministry of Agriculture recommendations.

Number of days to 50% heading, flag leaf area at 100 days from sowing, Absolute growth rate (AGR) according to Radford (1967), Net assimilation rate (NAR) according to Rodford (1967), leaf area index (LAI) according to Watson (1952) were estimated. Nitrogen use efficiency (NUE) is defined as the extra grain yield harvest for each increase in applied nitrogen according to Good *et al.* (2004) and Rasmaussen *et al.* (2015). All the data collected during the both seasons were subjected to statistical analysis using Excel data sheet by using statistical software package MSTAT-C (Michigan State University, 1990). Least significant differences test (LSD) at 5% probability was used to test the significances among mean values of each treatment (Steel and Torrie, 1977).

## Results and discussion

### Number of Days to 50% Heading

Results presented in Tables (1 and 2) show that significant effect for nitrogen levels in the first season. It is evident from these results that heading was delayed from 88.50 to 90.38 days in the first season and from 88.86 to 89.58 days in the second one by increasing N levels from 75 to 125 kg N/fad. The increment in heading period may be due to nitrogen addition that favored vegetative growth which in turn delayed time of heading. These results are in harmony with those obtained by Hamam and Khaled (2009) and Gheith *et al.* (2013). No significant effect for seeding rates on heading was recorded. Moreover, significant variations among the cultivars in number of days to heading were noticed. Gemmiza-9 recorded the highest values, while Giza-168 gave the lowest values in both seasons. These variations in cultivars partially reflect their different genetic background. These results are in agreement with those obtained by Gheith *et al.* (2013). Number of days to 50% heading was significantly affected by all studied interactions in both seasons. The earliest treatment was seeding Giza-168 with 200 or 400 grains/m<sup>2</sup> and fertilizing with 75 or 100 kg N/fad.

### Flag Leaf Area

Flag leaf area was significantly affected by nitrogen levels in both seasons and by cultivars in the first season. On the contrary, this effect was not significant with seeding rates in both seasons (Tables 1 and 2). The highest flag leaf area was observed with application of 100 kg N/fad., while the lowest values were produced at 75 kg N/fad. in both seasons. These results are in harmony with those of Ali (2012) and Gheith *et al.* (2013) who revealed those highly significant differences between N levels on this trait. Flag leaf area decreased with increasing

seeding rates without any significant in both seasons. Moreover, Gemmiza-9 ranked 1<sup>st</sup>, Sakha-94 ranked 2<sup>nd</sup> and Giza-168 came 3<sup>rd</sup> in the first season. All interactions had significant effect on flag leaf area in both seasons, except N levels × seeding rates and N levels × seeding rates × cultivars in the first season. Seeding Giza-168 with 300 grains/m<sup>2</sup> and application of 100 kg N/fad. had the largest flag leaf area.

#### **Leaf Area Index (LAI)**

Differences in LAI throughout the different growth stages due to nitrogen levels were significant at 80 and 100 days age in the second season only (Tables 1 and 2). Increasing N levels up to 125 kg N/fad. increased LAI at 60, 80 and 100 days. The increase in LAI occurred may be differences due to the increase in leaf expansion. These results are in agreement with those obtained by Ali (2012) and Alam (2013). LAI was not statistically affected by seeding rates at all samples in both seasons, except at 80 days in the first season, where the highest value (9.78) was observed at 400 grains/m<sup>2</sup>. The superior cultivar was Gemmiza-9 which produced the highest LAI, while the lowest values recorded by Giza-168 at all stages in both seasons. These results might be attributed to the prevailed differences in the makeup of cultivars. All interactions had significant effect except N levels × seeding rates and N levels × cultivars in first season at 60 days. At 80 days, this trait significantly affected by all interactions except seeding rates × cultivars in the second season. At 100 days, N level × seeding rates and seeding rates × cultivars and all studied interactions significantly affected this trait in both seasons. Generally, the largest value was obtained with seeding Gemmiza-9 or Giza-168 with 300 or 400 grains and application of 125 kg N/fad.

#### **Absolute Growth Rate (AGR)**

The absolute growth rate Table (1 and 2) showed that AGR become slower at 80 days and declined again at 100 days. These observations are in harmony with those of Asif *et al.* (2010) and Gul *et al.* (2015). AGR was significantly lower with application of 75 kg N/fad. in both seasons. AGR with 125 kg N/fad. had superiority over that of 75 kg N/fad. AGR of wheat has a significant relation with nitrogen fertilization because most of plants were healthy and vigorous which may help the plants to absorb water and light more efficiency have resulted higher AGR (Gul *et al.*, 2013). These results are in harmony with those obtained by Asif *et al.* (2010), Alam (2013) and Gul *et al.* (2013). AGR significantly affected by changing in seeding rates at 80 and 100 days in both seasons, except at 80 days in the first one. The highest values were recorded with seeding 400 grains/m<sup>2</sup>. Moreover, the tested cultivars had a significant effect on AGR at both stages in both seasons, except at 80 days in the second season. Gemmiza-9 and Giza168 ranked first at both stages and seasons, respectively. All studied interactions had significant effect on AGR at both stages in both seasons (Tables 1 and 2). Generally, the best combination was seeding Gemmiza-9 or Giza-168 with 300 or 400 grains/m<sup>2</sup> and application of 125 kg N/fad.

#### **Net Assimilation Rate (NAR)**

NAR increased significantly with increasing N levels up to 125 kg N/fad. at both times in the second season (Tables 1 and 2). Seeding rates significantly affect NAR at both times and seasons. Moreover, cultivars affected NAR significantly at 80 days in the first season and at 80 and 100 days in second one. At 80 days, Gemmiza-9 ranked first, Giza-168 ranked second and Sakha-94 ranked third in the first season. Whereas, at 80 and 100 days Giza-168 ranked first, Sakha-94 ranked second and Gemmiza-9 ranked third in the second season. The differences in NAR between cultivars might be attributed to the differences in their genetic makeup. All studied interactions except seeding rates × cultivars and N level × seeding rates × cultivars did not significantly affect NAR at 80 days in both seasons. Whereas, all interactions except nitrogen × cultivars and seeding rates × cultivars had significant effect on this trait at 100 days in second season.

#### **Nitrogen Use Efficiency (NUE)**



Nitrogen use efficiency was significantly affected by changing in nitrogen level in both seasons. Nitrogen use efficiency was gradually decreased with increasing nitrogen levels up to 125 kg N/fad. The highest NUE values (38.64 and 32.76) were produced at 75 kg N/fad., while the lowest values (23.97 and 22.05) were obtained at 125 kg N/fad. It is evident that when N levels were increased from 75 to 125 kg N/fad. NUE was decreased by 38% and 33% in both seasons, respectively. These results are in harmony with those obtained by Violeta *et al.* (2015) and Limin *et al.* (2016) who concluded that the NUE of wheat decreased with increasing N fertilization levels. Moreover, Limin *et al.* (2016) indicated that when N levels increased from 90 to 180 kg N/ha. NUE was decreased by an average of 19%. Also, Rahman *et al.* (2011) and Kumari (2011) found the same results. Moreover, non of the tested interactions affected NUE significantly in both seasons.

Table 1. Effect of nitrogen fertilizer levels, seeding rate and wheat cultivars on some growth characters and NUE in 2014/2015 season.

Factors and its interactions	No. of days to 50% heading	Flag leaf area (cm <sup>2</sup> )	LAI			AGR (g/day)		NAR (g/m <sup>2</sup> /day)		NUE
			60 days age	80 days age	100 days age	80 days age	100 days age	80 days age	100 days age	
N level (kg/fad.)										
75	88.50	33.85	4.40	8.22	9.17	1.07	1.69	3.30	4.17	38.64
100	89.91	39.95	4.85	9.05	9.18	1.14	1.77	3.37	4.18	27.24
125	90.38	39.62	5.29	9.14	9.29	1.14	1.79	3.56	4.21	23.97
LSD	1.35	2.70	NS	NS	NS	0.06	NS	NS	NS	9.21
Seeding rate (grains/m <sup>2</sup> )										
200	89.52	39.09	4.06	7.94	9.02	1.11	1.60	3.61	4.01	27.36
300	89.55	38.37	5.57	8.71	9.33	1.08	1.77	3.06	4.15	31.25
400	89.72	37.96	4.91	9.78	9.29	1.17	1.87	3.56	4.04	31.23
LSD	NS	NS	NS	0.93	NS	NS	0.16	NS	NS	NS
Wheat cultivar										
Sakha-94	91.11	38.48	4.65	8.94	9.24	0.95	1.79	3.07	4.11	31.33
Gemmiza-9	94.41	39.89	5.40	9.97	10.44	1.41	1.84	3.81	3.87	30.42
Giza-168	83.27	37.06	4.49	7.51	7.96	0.99	1.58	3.35	4.22	28.99
LSD	0.73	1.57	0.64	0.67	0.97	0.09	0.16	0.33	NS	NS
Significance of studied factors and interactions										
N level (N)	*	*	NS	NS	NS	*	NS	NS	NS	*
Seeding rate (S)	NS	NS	NS	*	NS	NS	*	NS	NS	NS
Cultivar (C)	*	*	*	*	*	*	*	*	NS	NS
N × S	*	NS	NS	*	*	*	*	NS	*	NS
N × C	*	*	NS	*	NS	*	*	NS	*	NS
S × C	*	*	*	*	NS	*	*	*	*	NS
N × S × C	*	NS	*	*	*	*	*	*	*	NS

\* = Significant and NS = Not significant at 0.05 level.

Table 2. Effect of nitrogen fertilizer levels, seeding rate and wheat cultivars on some growth characters and NUE in 2015/2016 season

Factors and its interactions	No. of days to 50% heading	Flag leaf area (cm <sup>2</sup> )	LAI			AGR (g/day)		NAR (g/m <sup>2</sup> /day)		NUE
			60 days age	80 days age	100 days age	80 days age	100 days age	80 days age	100 days age	
			N levels (kg/fad.)							
75	88.86	53.41	4.97	10.65	9.63	1.36	2.54	3.50	3.67	32.76
100	89.27	57.31	5.60	11.67	11.23	1.55	3.12	4.08	3.93	22.78
125	89.58	55.12	5.61	12.27	11.71	1.58	3.39	4.16	4.07	22.05
LSD	NS	3.26	NS	1.23	0.29	0.10	0.42	0.47	0.32	1.32
Seeding rate (grains/m <sup>2</sup> )										
200	88.44	56.20	5.05	11.59	10.39	1.46	2.93	3.90	3.97	25.48
300	89.25	55.68	5.40	11.07	11.08	1.36	3.16	3.66	4.10	26.07
400	89.52	53.96	5.57	11.94	11.10	1.67	3.92	4.17	3.60	26.03
LSD	NS	NS	NS	NS	NS	0.14	0.45	NS	NS	NS
Wheat cultivar										
Sakha-94	90.63	54.23	5.14	11.11	10.04	1.45	2.69	4.02	3.70	26.38
Gemmiza-9	94.25	55.64	5.92	13.31	12.01	1.46	3.03	3.27	3.41	25.73
Giza-168	82.83	55.97	5.12	10.19	10.53	1.58	3.32	4.44	4.56	25.47
LSD	0.75	NS	0.60	1.21	0.96	NS	0.45	0.54	0.58	NS
Significance of studied factors and interactions										
N level (N)	NS	*	NS	*	*	*	*	*	*	*
Seeding rate (S)	NS	NS	NS	NS	NS	*	*	NS	NS	NS
Cultivar (C)	*	NS	*	*	*	NS	*	*	*	NS
N × S	*	*	*	*	*	*	*	NS	*	NS
N × C	*	*	*	*	NS	*	*	NS	NS	NS
S × C	*	*	*	NS	NS	*	*	NS	NS	NS
N × S × C	*	*	*	*	*	*	*	NS	*	NS

\* = Significant and NS = Not significant at 0.05 level.

### Conclusions

The results of this study showed that flag leaf area, absolute growth rate, leaf area index, net assimilation rate were increased significantly with increasing N levels up to 125kg N/fad. On the contrary, NUE significantly decreased with increasing N levels. The highest values for the above traits were produced with seeding either 300 or 400 grains/m<sup>2</sup>. All studied traits (except AGR and NAR in one season) significantly affected by cultivars in both season. The over all finding indicated that seeding Gemmiza-9 with either 300 or 400 grains/m<sup>2</sup> and application of 125 kg N/fad. could be more beneficial in the study area

## References

- Achakzai, A.K.K. (2012). Effect of various levels of nitrogen fertilizer on some vegetative growth attributes of pea (*Pisum sativum* L.) cultivars. *Pak. J. Bot.*, 44 (2): 655-659.
- Alam, M.S. (2013). Growth and yield potentials of wheat as affected by management practices. *Afr. J. Agric. Res.*, 8 (47): 6068-6072.
- Ali, R. (2012). Effect of planting date and nitrogen on growth and morphological traits of dry land wheat in Yassoj of Iran. *Ann. Biol. Res.*, 3 (7): 3263-3266.
- Asif, M., A. Ali, M. Maqsood and S. Ahmad (2010). Growth radiation use efficiency and yield parameters of wheat affected by different levels of irrigation and nitrogen. *Int. Conf. Bioinformatics and Biomedical Technol.*, 434-437.
- El-Seidy, E.H.E., Kh.A. Amer, A.A. El-Gammal and E.E. El-Shawy (2015). Growth analysis and yield response of barley as affected by irrigation regimes. *Egypt. J. Agron.*, 35 (1): 1-19.
- Gheith, E.M.S., O.Z. El-Badry and S.A. Wahid (2013). Response of growth and straw yield of some wheat genotypes to sowing dates and nitrogen levels. *Zagazig J. Agric. Res.*, 40 (5): 809-815.
- Good, A.G., A.K. Shrawat and D.G. Muench (2004). Can less yield more? is reducing nutrient input into the environmental compatible with maintaining crop production. *Trends Plant Sci.*, 597-605.
- Gul, H., A.Z. Hana, S.K. Khalil, H.R. Rehman, S. Anwar, B. Saeed and H. Akbar (2015). Crop growth analysis and seed development fertilization, *Pak. J. Bot.*, 45 (3): 951-960.
- Hamam, M. S. and A. Khaled (2009). Stability of wheat genotypes under different environments and their evaluation under sowing dates and nitrogen fertilizer levels. *Aust. J. Basic and Appl. Sci.*, 3 (1): 206-217.
- Hussain, M., M. Niaz, M. Iqbal, T. Iftikhar and J. Ahmad (2012). Emasculation techniques and detached tiller culture in wheat and maize crosses. *J. Agric. Res.*, 50 (1): 1-19.
- Iftikhar, T., L.K. Babar, S. Zahoor and N.G. Khan (2010). Impact of land pattern and hydrological properties of soil on cotton yield. *Pak. J. Bot.*, 42 (5): 3023-3028.
- Javaid-Iqbal, K. Hayat and S. Hussain (2012). Effect of sowing dates and nitrogen levels on yield and yield components of wheat (*Triticum aestivum* L.). *Pakistan J. Nut.*, 11 (7): 531- 536.
- Kumari, S. (2011). Yield response of wheat (*Triticum aestivum* L.) to early and late application of nitrogen: Flag leaf Develop. and Senesc. *J. Agric. Sci.*, 3 (1): 170-182.
- Limin, G., L. Tiening, W. Jingfeng, L. Peng, D. Shuting, Z. Bingqiang, S. Hwat-Bing, Z. Jiwang, Z. Bin and L. Juan (2016). Lysimeter study of nitrogen losses and nitrogen use efficiency of Northern Chinese wheat. *Field Crops Res.*, 188: 82-95.
- Michigan State University (1990). 4 series guide to MSTAT- c. Michigan. Michigan S. Univ.
- Radford, P.J. (1967): Growth analysis formula, their use and abuse. *Crop Sci.*, 7 (3): 171-175.
- Rahman, M.M., A. Hossain, M.A. Hakim, M.R. Kabir and M.M.R. Shah (2011). Performance of wheat genotypes under optimum and sowing condition. *Int. J. Sustain. Crop Prod.*, 4 (6) : 34-39.
- Rasmaussen, I.S., D.B. Dresboll and K.Th. Kristensen (2015). Winter wheat cultivars and nitrogen (N) fertilization effects on root growth, N uptake efficiency and N use efficiency. *Europ. J. Agron.*, 68: 38-49.
- Steel, R.C. and S.H. Torrie (1997). In *Principles and Procedures of Statistics*. McGraw Hill Book company, Inc., New York, London.

- Violeta, M., K. Vesna, T. Zorica, B. Zorica, D.R. Aleksandarsimic and G. Marija (2015). Nitrogen fertilizer influence on wheat yield and use efficiency under different environmental conditions. *Chilean J. Agric. Res.*, 75 (1): 92-97.
- Watson, D.J. (1952). The physiological basis of variation in yield. *Afr. J. Agric. Res.*, 5 (9): 881-892.

## **EFFECT OF DODDER WEED (*Cuscuta epilinum* L.) CONTROL ON STRAW, SEED AND FIBER YIELDS OF THREE VARIETIES OF FLAX "*Linum usitatissimum* L."**

Ramadan EL-REFAEY<sup>1</sup>; Emadeldeen RASHWAN<sup>1</sup>, Ehab RAMADAN<sup>2</sup>

<sup>1</sup>Department of Agronomy, Faculty of Agriculture, Tanta University, Egypt

<sup>2</sup>Field Crops Research, Institute, ARC, Egypt

\*Corresponding author: emad.rashwan@agr.tanta.edu.eg

### **Abstract**

Field experiments were carried out at El-Gemmeiza Agricultural Research Station. Gharbiua Governorate, Egypt during the two successive winter seasons of 2012/13 and 2013/14. In order to study the effect of dodder weed control treatments (control, hand combing, spraying with sinal, spraying with select super, spraying with a mixture of (sinal and select super) and benzoic acid) on yield, yield component as well as quality for three flax varieties (Sakha 1, Giza 10 and Souzana). Souzana variety gave the tallest plants and recorded the highest values of technical stem length, fiber fineness, fiber length, total fiber percentage and fiber yield per faddan. Moreover it gave the thinnest stem diameter and the lowest values of straw yield per plant and per faddan, in both seasons. Sakha 1 was superior and gave the highest values of stem diameter, straw yield per plant and per faddan, while it recorded the lowest values of plant height, technical stem length, fiber fineness, fiber length; total fiber percentage and fiber yield per faddan, whereas Giza 10 came in the intermediate for all studied traits. On the other side, the select supper recorded the highest values of plant height, technical stem length, straw yields per plant and per faddan, fiber length, total fiber percentage and fiber yield per faddan. Furthermore, the application of the mixture of (sinal and select super) recorded the highest values of main stem diameter, number of apical branches per plant, number of capsules per plant, number of seeds per capsule, fertility percentage, oil percentage and seed index. Moreover, the highest values of seed yield per faddan, oil yield per faddan and the finest fiber were recorded by the hand combing treatment.

**Keywords:** *Flax, dodder, control, fiber, straw, Cuscuta epilinum.*

### **Introduction**

Flax can be a food resource as well as a fiber crop due to the fiber extracted from the stem of the plant. Flax fiber types are grown in cooler regions of the world, such as many countries in Europe, also in Egypt and China, whereas linseed (oil types of flax) is grown in Canada, Argentina and India. In Egypt, flax is grown during the winter season for both, its seeds and fiber (higher economic benefits). The cultivated area decreased in the last three decades due to the great competition with the other winter crops. Therefore, it is necessary to increase flax productivity per unit area to compensate this shortage. Moreover, it is a poor competitor with weeds and its spreading is considered one of the most effective factors that decreases flax productivity. Dodder (*Cuscuta epilinum* L.) is the most dangerous weed that harming flax plants in the field. It has no normal roots and leaves, its stems twine around flax plants, attaching to them by gaustoria. Stems are yellow-green, thread-like, slightly branched, 1.5 mm in diameter. Flowers are sessile, yellowish-white, aggregated by 5-15 into dense glomes. Maximum productivity of seeds is 4000 seeds. It is a fast growing plant; one individual plant can infest up to 120 flax plants, and the speed of infesting new plants is faster if the flax is still in succulent stage. Infestations of flax plants with dodder highly decrease fiber and seed

yields, therefore, the specific objectives of this research were:

- 1- Comparing among three flax varieties to evaluate their performance.
- 2- Study the influence of dodder weeds control on yield, yield component as well as quality for these three flax varieties and determine the most effective dodder control treatment.

### Material and methods

The present investigation was carried out at El-Gemmeiza Agriculture Research Station, Gharbiua Governorate, Egypt during the two successive winter seasons of 2012/13 and 2013/14. The effect of dodder weed (*Cuscuta epilinum* L.) control on yield, yield component as well as quality for three flax varieties was the main objective of this study. The preceding crop was sorghum (*Sorghum vulgare*) in the first season, while it was sunflower (*Helianthus annuus*) in the second one. The two experiments were sown on 1<sup>st</sup> of November 2012 and 4<sup>th</sup> of November 2013. Field experiment was carried out each season using a split-plot design with four replications. Flax varieties were plotted in the main plots and weed control treatments were arranged in the sub-plots, where each sub-plot size was 6 m<sup>2</sup> (2x3 m). The main plots included three flax varieties (Sakha 1 a local dual purpose type, Giza 10 a local fiber type and Souzana an imported fiber type). In this study six treatments were used as follows:

Control (weeds were not controlled).

Hand control (removing the dodder plants by hand) at 30, 60 and 90 days from sowing.

Spraying with sinal %10 (2.6 chloro 5.7 dim thoxy .3 methyl 1.2 .4 triad 2010 (1.5) apymidine 2 sulfonilide 100 cm<sup>3</sup>/20 L.w after 30 days from sowing.

Spraying with select super 12.540 (chethodium 2.5%) after 30 days from sowing at the rate of 100 cm<sup>3</sup>/20 L.w.

Spraying with a mixture of (sinal % 10 and select super) after 30 days from sowing with 100cm<sup>3</sup>/20 L.w.

Benzoic acid was sprayed after 30 days from sowing at the rate of 500 (p.p.m) as an organic acid.

A sample of ten plants was taken at random from each plot to estimate some of growth characters. The characters which were estimated were: straw yield characters (plant height, technical stem length, stem diameter, straw yields per plant and per faddan), seed yield characters (number of apical branches, number of capsules per plant, number of seeds per capsules, fertility percentage, seed yield per faddan, oil percentage, oil yield per faddan and seed index) and fiber yield and its technological characters (fiber length, fiber percentage, fiber yield per faddan and fiber fineness which was determined using Radwan and Momtaz's method (1966) according to the following equation where:  $N.m = (N \times L) / W$

The analysis of variance was used for the two experiments (using MSTAT-C) according to Snedecor and Cochran (1982). The least significant difference (L. S. D) test at 0.05 and 0.01 levels of significance was used to indicate mean comparison. The data was statistically analyzed for each season and the homogeneity of experimental error, in both seasons, was tested. Then the combined analysis of data was performed for the characters over two seasons (Le Clerg *et al.*, 1962) to present the first and second order interactions.

## Results and Discussion

A- Straw yield and its related characters:

In both seasons, the analysis of variance for plant height, technical stem length, main stem diameter, straw yield per plant and straw yield per faddan showed highly significant differences among the three tested flax varieties: Giza 10, Sakha 1 as local varieties as well as Souzana variety as an imported variety.

The results in Table (1) cleared that, Souzana and Giza 10 varieties gave the tallest plants and recorded the highest values of technical stem length in the first season without any significant difference between them. However, Giza 10 ranked the second with highly significant difference after Souzana variety in the second one. On the other hand, Sakha 1 variety recorded the lowest values of these traits in both seasons. The present results are mainly due to the differences in the genetical constitution of these genotypes.

These results are in a good agreement with those obtained by *El-Deep (2002)*, *Abou-Zaied and Mousa (2007)*, *Assar (2008)*, *El-Refaey et al. (2010)* and *El-Refaey et al. (2015)*, where they indicated that, fiber types were superior in total height and technical stem length compared with dual-purpose and oil types.

In both seasons, Sakha 1 (dual-purpose type) gave the thicker stem diameter, followed by Giza 10 with highly significant differences between them. On the other hand, the thinnest measurement was obtained from Souzana in both seasons. The present results are mainly due to the genetic differences and potentiality between the fiber and dual-purpose genotypes of flax. These results are in a good agreement with those obtained by *Assar (2008)*, *El-Refaey et al. (2010)* and *El-Refaey et al. (2015)* where they revealed that dual and oil types surpassed fiber types in main stem diameter. Also, *El-Refaey et al. (2009)* indicated that ideal fiber types are characterized by the thin stem diameter.

Sakha 1 gave the highest values of straw yield per plant and per faddan, followed by Giza 10 which came in the intermediate. While, Souzana gave the lowest values of straw yield per plant and per faddan in both seasons. These results are mainly due to differences in the genetic make up of the three tested varieties. It is worthy to mention that, Sakha 1 genotype surpassed other genotypes in main stem diameter, number of apical branches and consequently surpassed other genotypes in straw yield per plant and per faddan. These results are in the same line with those obtained by *Zahana (2004)*, *Abdel-Dayem (2007)*, *El-Refaey et al. (2010)* and *El-Refaey et al. (2015)*, where they concluded that dual-purpose types were significantly superior the other genotypes regarding to straw yield per plant and per faddan.

Results in Table (2) indicated that, in both seasons the select super as a herbicide treatment gave the best results in all straw yield and its related characters except main stem diameter. In both seasons, the select super recorded the highest values of plant height, technical stem length, straw yield per plant and straw yield per faddan, followed by the mixture (sinal and select super) then the hand combing treatment, benzoic acid, sinal and the control treatment which gave the lowest values, (in a descending order). However, the only noticeable change in the data trend was in main stem diameter, where the select super treatment ranked the second after the mixture of (sinal and select super) in both seasons. However, the select super and mixture (sinal and select super) treatments had no significant differences with respect to straw yields per plant and per faddan. It is obvious that, all tested herbicides positively affected straw yield and its related characters when compared to the control objects. These results are in a good agreement with those obtained by (*Mankowski et al, 2015*) where they found a positive effect of herbicides on the length of the straw and explained it by its negative influence on the weed growth, as weeds competing with flax plants for water and nutrition elements can reduce plant height, technical length, stem diameter and consequently straw yield per plant. Also, *Heller (2007)* indicated that, the greater number of weeds reduced

number of flax plants per unit area, which may lead to reduction in straw yield per faddan. In addition, *Soliman and Hamza (2010)*, reported that, the reduction in straw yield values under hand combing and control treatments reflected the negative impacts of the dodder on flax growth, which may be occurred as a result of the competition among flax plants and dodder weed. Also, the results showed that using the tested herbicides was necessary to eliminate this weed and to avoid its negative impacts on flax plants. Worthy to note that, among the studied herbicides, select supper was the best and recorded the highest values of plant height, technical stem length, straw yield per plant and straw yield per faddan, and this superiority of the select supper may be due to that, it is a member of the cyclohexanedione group of herbicides and has the inhibition of acetyl coA carboxilase mode of action. Also, the variation among the studied herbicides on straw yield and its related characters may be due to the special phytotoxic action of each herbicide on flax, which expressed by deformations and plant necroses, the increased rate of maturation and reduced yield (*Mankowski et al, 2015*). Also, may be a result of dodder weeds resistance which may initiate by the using of the same herbicide repeatedly.

The interaction between seasons and flax varieties had highly significant effect on stem diameter and straw yield per plant (Figure 1). However, Sakha 1 variety in the second season recorded the highest values of stem diameter and straw yield per plant. Also, the interaction between flax varieties and weed control treatments had highly significant effect on plant height, technical stem length, main stem diameter and straw yield per faddan (Figure 2). The select supper significantly recorded the highest plant height and technical stem length under Souzana variety. On the other hand, the mixture of (sinal and select super) significantly recorded the highest main stem diameter and straw yield per faddan under Sakha 1 variety.

Table (1): Means of straw yield and its related characters as affected by flax varieties in both seasons:

Varieties	Plant height (cm)	Technical stem length (cm)	Stem diameter (mm)	Straw yield (gm) per plant	Straw yield (ton) per faddan
Season 2012/13					
Giza 10	107.656	101.530	1.461	2.260	4.032
Sakha 1	98.662	92.741	1.486	2.584	4.351
Souzana	113.528	108.010	1.288	1.981	3.391
L.S.D <sub>0.01</sub>	8.330	8.059	0.1703	0.1563	0.1514
Season 2013/14					
Giza 10	109.857	103.765	1.496	2.327	4.418
Sakha 1	101.032	94.494	1.736	2.967	4.734
Souzana	117.107	110.584	1.311	2.012	3.796
L.S.D <sub>0.01</sub>	6.037	7.975	0.1611	0.1236	0.1296

Table (2): Means of straw yield and its related characters as affected by weed control treatments in both seasons

Treatments	Plant height (cm)	Technical stem length (cm)	Stem diameter (mm)	Straw yield (gm) per plant	Straw yield (ton) per faddan
Season 2012/13					
Control	72.169	68.162	0.514	0.467	2.903
Hand combing	112.903	106.859	1.616	2.550	4.114
Sinal	104.853	98.646	1.468	2.427	3.924
Select super	121.425	115.606	1.646	2.847	4.206
Mixture(Si+Se)	117.933	111.573	1.702	2.885	4.358
benzoic acid	110.408	103.717	1.522	2.475	4.043
<b>L.S.D<sub>0.01</sub></b>	<b>2.426</b>	<b>2.921</b>	<b>0.041</b>	<b>0.2536</b>	<b>0.170</b>
Season 2013/14					
Control	73.768	68.615	0.620	0.606	3.303
Hand combing	116.195	109.905	1.712	2.713	4.491
Sinal	108.488	101.249	1.572	2.589	4.271
Select super	124.203	117.611	1.750	3.007	4.593
Mixture(Si+Se)	120.821	114.102	1.810	3.056	4.845
benzoic acid	112.517	106.205	1.624	2.640	4.393
<b>L.S.D<sub>0.01</sub></b>	<b>2.531</b>	<b>2.653</b>	<b>0.0400</b>	<b>0.262</b>	<b>0.069</b>



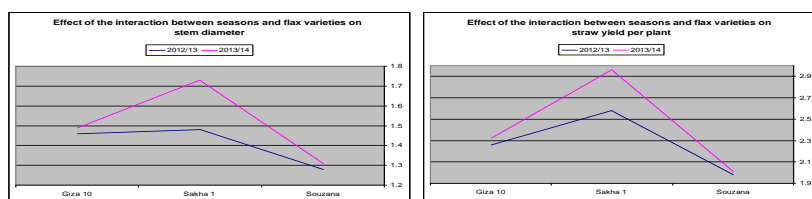


Figure (1): Effect of the interaction between seasons and flax varieties on stem diameter and straw yield per plant

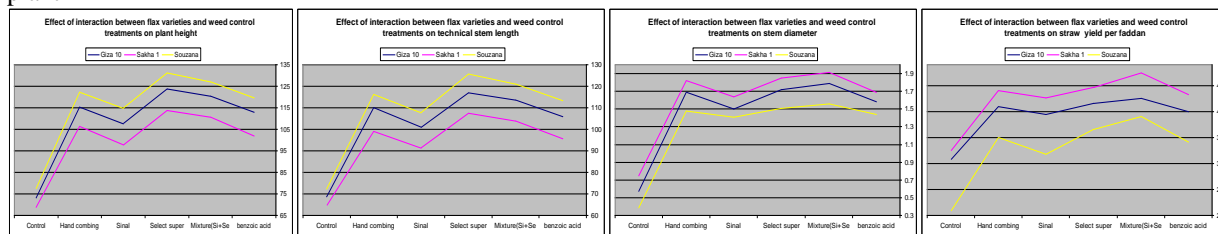


Figure (2): Effect of interaction between flax varieties and weed control treatments on straw yield and its related characters:

#### B- Seed yield and its related characters:

Data in Table (5) presented that, Sakha 1 recorded the significantly highest values for all seed yield related traits, followed by Giza 10 variety. However, the lowest values were noticed by Souzana variety in both seasons. The highest means of seed yield and its related characters for Sakha 1 as a dual purpose type are attributed to the genetic constitution of the variety. The trend of data was so clear and similar to expectations as it is known that, the dual purpose type is superior in seed yield and its related characters compared with fiber types. Also, local fiber type tended to be higher in seed yield and its related characters compared with imported fiber types due to its adaptation to the climatic factors in Egypt. These results are in harmony with those mentioned by **Abdel-Dayem (2007)**, **Abou-Zaied and Mousa (2007)**, **Assar (2008)**, **El-Seidy et al. (2010)** and **El-Seidy et al. (2015)** where they pointed out that, oil types produce the maximum values of seed yield and its related characters, while the lowest values were recorded by fiber types. However, the dual types come in the intermediate. Also, **El-Shimy and Moawed (2000)** and **Omar (2002)** noticed that, local dual-purpose types surpassed imported and local fiber types in seed yield and its related characters.

Data in Table (6) revealed that, in both seasons, the application of the mixture of (sinal and select super) recorded the significantly highest values in all seed yield and its related characters, except seed and oil yields per faddan where the best weed control treatment was hand combing in these respects. Application of the select supper herbicide ranked the second after the mixture of (sinal and select super) with highly significant differences for number of apical branches per plant, number of seeds per capsule, fertility percentage and oil percentage traits. However, the differences between the two weed control treatments didn't reach to the level of significance for number of capsules per plant and seed index traits. Utilization of benzoic acid as a herbicide ranked in the third grade after the mixture of (sinal and select super) and the select super with highly significant differences with application of sinal herbicide which ranked the fourth grade and hand combing treatment which ranked the fifth grade for number of apical branches per plant, number of capsules per plant and oil percentage traits. On the other hand, the control treatment gave the lowest values in both seasons. This might be attributed to the fact that flax plants in control plots were exposed to severe competition with flax dodder. These results are in a good agreement with those obtained by **Ghalwash and Soliman, (2008)** and **Soliman and Hamza (2010)**, where they revealed that, application of herbicides significantly increase number of capsules per plant, number of seeds per capsule, fertility percentage, oil percentage and seed index. Also, they reported that, herbicides application was necessary to eliminate dodder and to avoid its negative impacts on flax plants. Noticeable changes in the data trend were observed in seed

and oil yields per faddan traits, where the hand combing treatment ranked the first, followed by the mixture of (sinal and select super), then the select supper, sinal, benzoic acid and control treatment, in a descending order, in both seasons.

It is obvious that, all tested herbicides negatively affected seed yield per faddan and consequently decreased oil yield per faddan compared to the hand combing treatment. These results may be due to the bad effect of the herbicides on pollen vitality. These results are in harmony with those obtained by *Guo et al., (2009)*, where they found that all herbicides significantly decreased pollen germination and pollen tube growth in *S. canadensis* at relatively low doses. Also, *Schmitz et al., (2013)*, reported that herbicides caused a sub lethal effect by reducing flower intensity by 85% on the common buttercup. In addition, *Boutin et al. (2014)*, reported that, delays in flowering and reduced seed production occurred widely in plants sprayed at the seedling stage or at later reproductive periods.

The interaction between seasons and flax varieties had highly significant effect on number of seeds per capsule and fertility percentage traits (Figure 3). However, Sakha 1 variety in the second season recorded the significantly highest values of number of seeds per capsule and fertility percentage, compared to the other interactions. Moreover, the interaction between flax varieties and weed control treatments had highly significant effect on number of apical branches per plant, number of seeds per capsule, fertility percentage, seed yield per faddan, oil percentage, oil yield per faddan and seed index (Figure 4). The mixture of (sinal and select super) recorded the significantly highest values of number of apical branches per plant, number of seeds per capsule, fertility percentage, oil percentage and seed index under Sakha 1 variety. On the other hand, the hand combing treatment recorded the significantly highest seed and oil yields per faddan under Sakha 1 variety.

Table (5): Means of seed yield and its related characters as affected by flax varieties in both seasons:

Varieties	Number of apical branches	Number of capsules per plant	Number of seeds per capsule	Fertility percentage (%)	Seed yield per faddan (kg)	Oil Percentage (%)	Oil yield per faddan (kg)	Seed index (gm)
Season 2012/13								
Giza 10	4.446	11.571	7.050	70.496	323.562	32.421	105.1	6.154
Sakha 1	4.593	12.976	7.157	71.571	528.957	35.190	186.5	8.152
Souzana	4.172	9.827	6.979	69.792	230.528	31.050	71.70	5.374
L.S.D 0.01	0.055	1.248	0.087	0.895	3.761	0.415	2.718	0.390
Season 2013/14								
Giza 10	4.474	11.837	7.560	75.600	323.785	32.482	105.3	6.190
Sakha 1	4.665	13.079	7.705	77.046	529.972	35.232	187.1	8.195
Souzana	4.241	10.033	7.181	71.813	230.662	31.253	72.21	5.427
L.S.D 0.01	0.055	1.247	0.110	1.075	3.698	0.402	2.660	0.382

Table (6): Means of seed yield and its related characters as affected by weed control treatments in both seasons:

Treatments	Number of apical branches	Number of capsules per plant	Number of seeds per capsule	Fertility percentage (%)	Seed yield per faddan (kg)	Oil Percentage (%)	Oil yield per faddan (kg)	Seed index (gm)
Season 2012/13								
Control	3.747	9.808	6.857	68.575	208.423	32.074	67.48	6.428
Hand combing	4.151	10.712	6.994	69.942	413.217	32.667	137.6	6.451
Sinal	4.430	11.280	7.024	70.242	383.593	32.819	128.4	6.537
Select super	4.673	12.347	7.130	71.300	390.432	33.234	132.2	6.636
Mixture(Si+Se)	4.813	12.899	7.310	73.100	394.488	33.514	134.6	6.693
benzoic acid	4.609	11.703	7.056	70.558	375.940	33.012	126.4	6.617
L.S.D 0.01	0.133	0.636	0.069	0.732	3.804	0.237	1.438	0.188
Season 2013/14								
Control	3.801	10.001	7.268	72.675	208.911	32.182	67.85	6.465
Hand combing	4.212	10.893	7.412	74.117	413.847	32.765	138.1	6.492
Sinal	4.489	11.467	7.453	74.525	383.939	32.923	128.8	6.578
Select super	4.728	12.541	7.552	75.517	390.832	33.336	132.6	6.685
Mixture(Si+Se)	4.863	13.087	7.727	77.267	394.962	33.611	135.0	6.744
benzoic acid	4.668	11.909	7.482	74.817	376.347	33.117	126.8	6.660
L.S.D 0.01	0.133	0.640	0.069	0.699	3.826	0.237	1.411	0.188

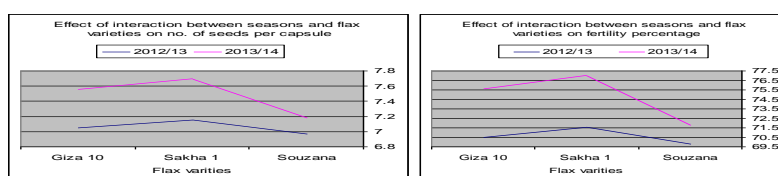


Figure (3): Effect of interaction between seasons and flax varieties on seed yield and its related characters.

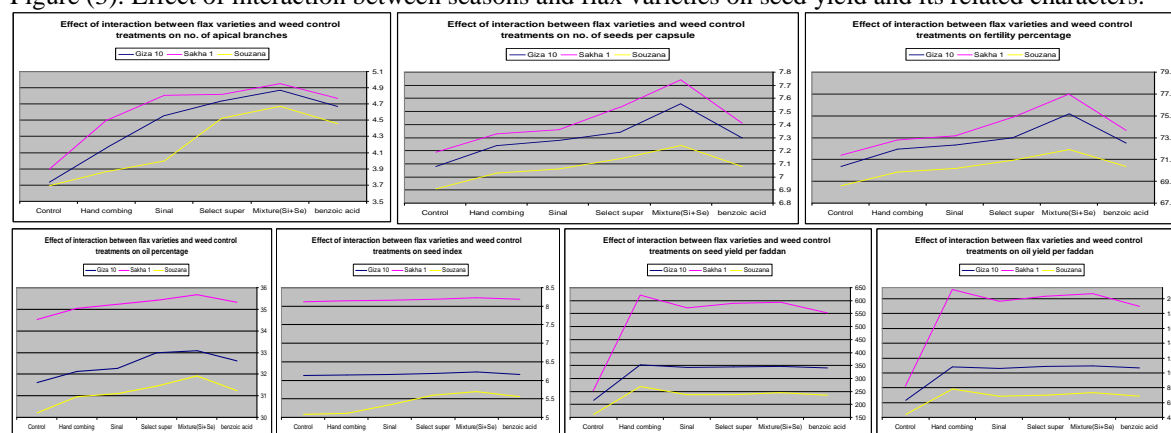


Figure (4): Effect of interaction between flax varieties and weed control treatments on seed yield and its related characters

### C- Fiber yield and its technological characters:

Data in Table (9) cleared that, Souzana variety ranked the first and recorded the significantly highest values for all fiber yield and its technological characters, followed by Giza 10 which ranked the second with highly significant difference than Souzana variety for these characters. On the other hand, Sakha 1 variety recorded the lowest values of these traits in both seasons. The trend of these results may be due to the genetical differences among fiber and dual-purpose types, such differences could be attributed to genetic constituents of varieties, whereas, Souzana and Giza 10 are behaved as fiber types and Sakha 1 is a dual-purpose type. Also, worthy to mention that fiber types gave the highest values of fiber percentage which were proportionally with the loss in straw yield per faddan after retting. The loss in straw yield per faddan after retting for dual-purpose type (Sakha 1 variety) was higher than the other fiber types. These results are completely agreed with those obtained by *El-Refaey et al. (2010)*, where they showed that imported fiber types recorded the highest fiber fineness, fiber length, total fiber percentage and fiber yield per faddan, followed by the local fiber types then the dual-purpose types, while the lowest values were recorded by oil types. Also, *Kineber*

(2004), Zahana (2004) and El-Refaey et al. (2015), noted that fiber types-generally-exceeded dual and oil types in fiber fineness, fiber length, fiber percentage and fiber yield per faddan due to its genetic potential.

Results in Table (10) indicated that, in both seasons the select supper as a herbicide treatment gave the best results in all fiber yield and its technological characters, except fiber fineness character. Select supper recorded the highest values of fiber length, total fiber percentage and fiber yield per faddan, followed by the mixture of (sinal and select super) then the hand combing treatment, benzoic acid, sinal and the control treatment which gave the lowest values (in a descending order). However, the only noticeable variation in the data trend was in fiber fineness, where the control and hand combing treatments recorded the finest fiber with no significant difference between them, followed by the mixture of (sinal and select super), then select super and sinal. On the other hand, the most coarseness fiber was recorded by benzoic acid in both seasons. It is obvious that, the select supper and the mixture of (sinal and select super) herbicides positively affected fiber length, total fiber percentage and fiber yield per faddan when compared to the hand combing treatment, in both seasons. However, hand combing treatment was highly significant surpassed sinal and benzoic acid for these traits, with no significant difference with benzoic acid only in fiber yield per faddan, in both seasons. From these results, it could be concluded that, the trend of fiber length was similar to that of technical stem length. Moreover, the reduction in straw yield per faddan with application of sinal or benzoic acid comparing with application of select supper or the mixture of (sinal and select super) caused the same trend in fiber yield per faddan character.

These results are in a good agreement with those obtained by (Mankowski et al, 2015) where they found a positive effect of some herbicides (application of chlorsulfuron and linuron) on fiber length and fiber yield but in the same time other herbicides may have an equal negative effect comparing with control plots on these traits. (Karimmojeni et al., 2013), showed that, in despite of high herbicidal effectiveness of bentazon, it reduced both the amount and quality of the fiber yield when compared to chlorsulfuron. Also, (Rennebaum et al., 2002), reported that, active substance of herbicides used in flax cultivation had a significant impact on both the thinness of the fiber (tex) and its divisibility (Nm) whereas, thicker and less divisible fiber was obtained after bentazon than from the control plots.

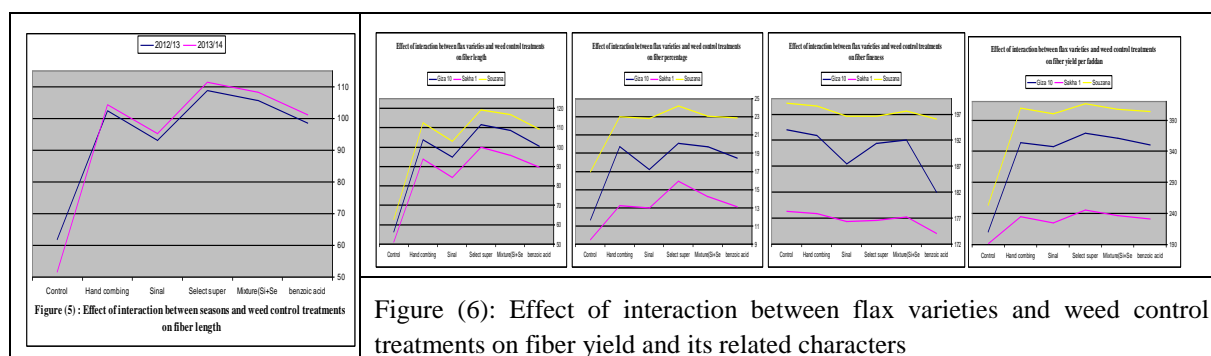
The interaction between seasons and weed control treatments had highly significant effect on fiber length Figure (5). However, the select supper herbicide in the second season recorded the longest fiber length. Furthermore, the interaction between flax varieties and weed control treatments had highly significant effect on fiber fineness, fiber length, total fiber percentage and fiber yield per faddan (Figure 6). The select supper herbicide recorded the highest values of fiber length, total fiber percentage and fiber yield per faddan under Souzana variety. On the other hand, the control treatment as well as hand combing recorded the finest fiber under Souzana variety, where there is no significant difference between the two interactions.

**Table (9): Means of fiber yield and its technological characters as affected by flax varieties in both seasons:**

Varieties	Fiber fineness (N.m)	Fiber length (cm)	Fiber percentage	Fiber yield per faddan (kg)
Season 2012/13				
Giza 10	189.645	95.729	17.692	331.608
Sakha 1	176.679	86.082	13.114	226.587
Souzana	197.382	103.195	22.115	380.761
L.S.D 0.01	<b>1.587</b>	<b>7.352</b>	<b>0.743</b>	<b>3.726</b>
Season 2013/14				
Giza 10	190.257	96.094	17.905	332.098
Sakha 1	176.787	85.395	13.213	228.397
Souzana	197.523	104.487	22.197	381.547
L.S.D 0.01	<b>1.576</b>	<b>5.679</b>	<b>0.726</b>	<b>3.843</b>

**Table (10): Means of fiber yield and its technological characters as affected by weed control treatments in both seasons:**

Treatments	Fiber fineness (N.m)	Fiber length (cm)	Fiber percentage	Fiber yield per faddan (kg)
Season 2012/13				
Control	190.334	61.582	12.611	217.970
Hand control	189.658	102.265	18.591	330.702
Sinal	186.642	93.090	17.619	324.171
Select super	188.042	108.898	20.003	343.156
Mixture(Si+Se)	188.813	105.692	18.942	333.967
Benzweek acid	183.923	98.486	18.077	327.946
L.S.D 0.01	<b>1.314</b>	<b>2.445</b>	<b>0.554</b>	<b>3.115</b>
Season 2013/14				
Control	190.621	51.349	12.746	218.549
Hand control	189.942	104.231	18.718	331.921
Sinal	186.928	95.295	17.753	324.588
Select super	188.327	111.525	20.125	345.881
Mixture(Si+Se)	189.104	108.414	19.072	335.980
Benzweek acid	184.213	101.137	18.217	329.164
L.S.D 0.01	<b>1.308</b>	<b>3.113</b>	<b>0.555</b>	<b>2.882</b>



### Conclusions and recommendation

Souzana variety performance surpassed other varieties in respect to fiber yield traits, whereas Sakha 1 was superior in seed yield traits. The select super as a herbicide treatment recorded the highest values of straw and fiber yield traits, while the mixture of (sinal and select super) gave the highest values of seed yield traits

This study suggests that under heavy infestation of dodder weed in flax fields, it is recommended to use the select super that will increase the straw and fiber yields and its related characters in case of cultivation fiber types. On the other hand, it is recommended to apply the mixture of (sinal and select super) in case of cultivation dual purpose types.

## References

- Abdel-Dayem, M. A. (2007). Response of some flax genotypes to combinations of NPK fertilizer. *J. Agric. Sci. Mansoura Univ.*, 34(5): 53-61
- Abou- Zaiied, T.A. and A. M. Mousa (2007). Effect of different NPK treatments on yield and yield components of two flax varieties. *J. Agric. Sci. Mansoura Univ.*, 32(10): 8057 - 8064.
- Assar, M. B. (2008). Evaluation of some flax genotypes under different conditions. M.Sc., Fac. Agric., Tanta Univ., Egypt. 86 pp.
- Boutin, C.; B. Strandberg; D. Carpenter; S.K. Mathiassen and P.J. Thomas (2014). Herbicide impact on non-target plant reproduction: What are the toxicological and ecological implications?. *Environmental Pollution*, (185) 295-306
- El- Shimy, G. H. and E. A. Moawed (2000). Effect of different potassium and nitrogen fertilizer levels on Giza 8 and Viking flax varieties. *J. Agric. Sci. Mansoura Univ.*, 25 (10): 5993-6007.
- El-Refaey, R.A.; E.H. El-Seidy; T.A. Abou-Zaiied and E.A.Rashwan, (2010). Evaluation of some genotypes of flax (*Linum usitatissimum* L.) for fiber and its related characters under different plant densities and retting methods. The 12th Conference of agronomy, Suez Canal Univ., Fac., Environ., Agric, Sci., El- Arish, Egypt. 20-22 September, 165-187.
- El-Refaey, R. A; E. H. El-Seidy; T. A. Abou-Zaiied; U. A. Abd El-Razek, E. A. Rashwan (2015). Effect of different mineral and biological nitrogenous fertilizers combinations on straw yield and fiber quality of some flax '*Linum usitatissimum* L.' Genotypes *Glob. J. Agric. Food Safety Sci.*, Vol.2 (3): pp. 346 – 364.
- El-Refaey, R.A.; E.H. El-Seidy; T.A. Abou-Zaiied and A.A. Ewes (2009). Breeding for the ideal plant type of fiber in flax through line X tester analysis. The Fifth Inter, Conf. of Sustain. Agric. Develop. Fac. of Agric. Fayoum Univ.,: 69-84.
- El-Seidy E. H.; R. A. El-Refaey; T. A. Abou-Zaiied; U. A. Abd El-Razek and E.A.Rashwan (2015). Effect of different mineral and biological nitrogenous fertilizers combinations on seed yield and its components of some flax '*Linum usitatissimum* L.' Genotypes. *Glob. J. Agric. Food Safety Sci.*, Vol.2 (3): pp. 365 – 383.
- El-Seidy E.H.; R.A. El-Refaey; T.A. Abou-Zaiied and E.A.Rashwan, (2010). Evaluation of some flax genotypes for seed yield and its related characters under different plant densities. The 12th Conference of Agronomy, Suez Canal univ., Fac., Environ., Agric, Sci., El-Arish , Egypt. 20-22 September, 691- 703.
- Ghalwash, A.M. and I.E. Soliman, (2008). Efficiency of some weed control treatments on annual weeds, growth characters and yield and its components of flax (*Linum usiatissimum* L.). *Egypt. J. Agric. Res.* 86(1): 383-394.
- Guo, S.L.; H.W. Jiang; F. Fang and G.Q. Chen (2009). Influences of herbicides, uprooting and use as cut flowers on sexual reproduction of *Solidago canadensis*. *Weed Res.*49 (3): 291-299.
- Heller, K. (2007). The technologies of fibrous crops (flax and hemp) growing and processing in sustainable and multifunctional development of agriculture. *Fragm. Agron.* 24, 181–186.
- Karimmojeni, H.; A. G. Pirbaloti; P. Kudsk; V. Kanani and A. Ghaforia (2013). Influence of post emergence herbicides on weed management in spring-sown linseed. *Agronomy Journal.* 105 (3): 821-826.
- Kinebar, M. E. A. (2004). Effect of environmental conditions on yield and its quality of two flax cultivars. *J. Agric. Sci. Mansoura Univ.*, 44(8): 1-12.

- Man'kowski, J.; K. Pudelko, J. Kołodziej and T. Kara (2015). Effect of herbicides on yield and quality of straw and homomorphic fibre in flax (*Linum usitatissimum* L.). *Industrial Crops and Products*. 70: 185–189.
- Omar, T. S. (2002). Response of some flax strains to row spacing and nitrogen fertilization. Ph.D. Thesis. Fac. Agric, Moshtohor, Banha, Univ.
- Radwan, S. RH. and A. Momtaz (1966). The technological properties of flax fibers and the methods of estimating them. *El-Falaha J.* 46(5): 466-476 (In Arabic).
- Rennebaum, H.; E.Grimm; K. Warnstorff and W. Diepenbrock (2002). Fibre quality of linseed (*Linum usitatissimum* L.) and the assessment of genotypes for use of fibres as a by-product. *Ind. Crops Prod* 16, 201–215.
- Schmitz J., K. Schäfer and CA. Brühl (2013). Agrochemicals in field margins-assessing the impacts of herbicides, insecticides, and fertilizer on the common buttercup (*Ranunculus acris*). *Environ. Toxicol. Chem.*; 32(5):1124-31.
- Soliman, I. E. and A.M.Hamza (2010). Evaluation of some herbicides against flax dodder (*Cuscuta epilinum*) in fibre flax (*Linum usitatissimum* L.) cultivation. *J. Plant Prot. Res.*50: 372–377.
- Zahana, A. E. A. (2004). Response of some flax genotypes to different nitrogen fertilization levels in newly reclaimed sandy soil. *J. Agric. Sci., Mansoura Univ.*, 29 (1): 1-10.

## EFFECT OF SOME MICROELEMENTS AND GROWTH SUBSTANCES ON YIELD, YIELD COMPONENTS AND CHEMICAL COMPOSITION TRAITS IN SOME FABIA BEAN CULTIVARS

EL-Refaey, Ramadan Aly<sup>1</sup>; Usama Abd El Hameid Abdel-Razek<sup>1</sup>, Adel Mohamed EL-Garhy<sup>2</sup>, Mohamed Karam Sayed Ahmed<sup>3</sup>

<sup>1</sup>Agron. Dept., Fac.of Agric., Tanta Univ. EL-Gharbia, Egypt

<sup>2</sup>Food legume Research Section –Field Crops Research Institute –A.R.C. EL-Giza, Egypt

<sup>3</sup>Agron.Dept., Facu. Of Agric., Tanta Univ. EL-Gharbia, Egypt

Corresponding author. usama.eldesouky@agr.tanta.edu.eg or usama20012001@gmail.com

### Abstract

The present study was carried out at Itay EL-Baroud Agriculture Research Station farm, EL-Behaira governorate, Egypt during the two agriculture seasons of 2012/13 and 2013/ 14. Three faba bean varieties Nubaria 1, Giza 716 and Sakha 1 were used in the present study to examine seed yield, its components and chemical composition under four commercial growth substances with control. In the first season of 2012/13, the three faba bean cultivars were sown and evaluated in experiment designed in a split plot design with three replications. The result indicates that, the cultivar Nubaria 1 expressed the best desirable mean values for number of branches/plant, 100- seed weight, seed yield /plant, seed yield. in both seasons and number of pods/plant, number of seeds/plant in 2012/13, carotain content, chlorophyll B and protein percentage in both seasons. The growth substance Crop plus showed the most desirable effect on plant height, number of pods/plant, number of seeds/pod, number of seeds/plant, 100- seed weight, seed yield/plant and seed yield in both seasons, carotain content, chlorophyll A, chlorophyll B, protein percentage and carbohydrate percentage in both seasons.

### Keyword:

### Introduction

Faba bean is an annual legume known botanically as *vicia faba* l. The crop is known by many names, most of which refer to a particular subgroup rather than the whole species. The world harvested area of faba bean, dry was 2.15 million hectares and the total production was 4.14 million tons in 2014 while, the harvested area in Egypt was 37677 hectares and the production quantity was 134175 tons in 2014 (FAO STAT 2014). Faba bean is used as human food in developing countries and as animal feed, horses, poultry and pigeons in industrialized countries. It can be used as a vegetable, either green or dried, fresh or canned. Spraying plant growth substances such as GA and IAA had significantly affected plant height (cm), number of branches/plant, number of pods/plant, number of seeds/pod, number of seeds/plant, 100–seed weight (g) seed weight of plant, and seed yield (ton/ha) (Kandil *et al.* (2011).

The aims of this study were to estimate the effect of some growth substances on yield and yield quality of three faba bean cultivars to determine the best cultivar and the best growth substance that may use under Delta condition to improve seed yield and its quality of faba bean.



## Materials and Methods

The present study was carried out at Itay EL-Baroud Agriculture Research Station farm, EL-Behaira governorate, Egypt during two agriculture seasons of 2012/13 and 2013/14. Three faba bean varieties Nubaria 1, Giza 716 and Sakha 1 were used in the present study to examine seed yield, and chemical components under four commercial growth substances with control i.e., Dotra Firt, Dotra Micro Plus, Dotra Frost, Crop Plus and control. During the two seasons. The commercial name, chemical component of the four growth substances are presented in Table 1.

Table 1: The commercial name, chemical component of the four growth substances

no	Commercial name	Chemical components	Added rate/ ha.
1	<b>Dotra Firt</b>	19% N + 19% P + 19% K + 4.14% S	6 (kg/ha.)
2	<b>Dotra Micro Plus</b>	2% Zn + 4% Fe + 2% Mn.	2.4 (later/ha.)
3	<b>Dotra Frost</b>	3% B + 1% Mo	600 (ml later/ha.)
4	<b>Crop Plus</b>	1.2% Cytokinin + 0.8 % Oxcine + 3% Zn + 1.7 % Fe + 1.4 % Mn + 1.3% Cu + 4.5% S + 9% Citric acid	600 (ml later/ha.)
5	<b>Control</b>	Without any add.	Without any added

In the first season 2012/ 13, the three faba bean cultivars were sown in 15/11/ 2012 and evaluated in experiment designed in a split plot design with three replications. The plot size was 5 ridges. Each ridge was 4 meters long and 0.6 meters apart. Seeds were sown on two side of the ridge at 15 cm hill spacing with one seed per hill. Meanwhile the growth substances were sprayed three times after 50, 65 and 85 days from sowing. The following readings and measurements were recorded as on individual plants basis at harvest. Data were recorded as average of 10 individual random plants chosen from each experimental plot. In the second season 2013/ 14 the experiment was repeated with the same procedure.

### Studied characters were: -

Data were recorded as follows: -

**A-Seed yield and yield components traits:** At harvest, 10 plants from each plot were chosen randomly and the data recorded as follows:

Plant height (cm), number of branches/ plant, number of pods/plant, number of seeds/pod, number of seeds/plant, 100-Seed weight (g), seed yield /plant (g) and seed yield (ardab/ha.)

**B-Chemical traits:** Carotain content (mg/g), chlorophyll A: (mg/g), chlorophyll B (mg/g) fresh weight, protein percentage and total carbohydrates%

The data were analyzed by using Two-way ANOVA followed by LSD test through Mstat-C. The treatments means were compared using least significant difference (LSD) tested at significant levels of 5% and 1% respectively as described by Gomez and Gomez (1984).

## Results and discussions

### 1-Effects of cultivars, growth substances and their interactions on yield and yield components.

**Cultivar effects:** It could be detected from the presented results in Table 2 that, Nubaria 1 cv. had highly significant difference in mean values for number of pods/ plant in 2012/13 with no significant difference than Giza 716, 100-seed weight (g), seed yield/plant (g) and seed yield(ardab)/ha. in both seasons. While, Giza 716 cv. exceeded the three cultivars used in number of branches/plant in both seasons with no significant difference than the cultivar Nubaria 1, number of pods /plant and number of seeds/ pods in 2013/14 season. Finally, Sakha 1 cv. expressed the highest significant mean values for plant height in both seasons. With respect to number of seeds /pod in both seasons and number of seeds /plant in 2012/13 season, the results revealed insignificant differences among the three cultivars. The differences between cultivars may due the widely genetic makeup among them and this result

was in agreement with those reported by Talaat, and Abdallah (2008), Kandil *et al.* (2011) and Khalil *et al.* (2015).

**Growth substances effects:** From the present results listed in Table 2. It could be clear that, the differences between all growth substances and the control treatment were highly significant for all yield and yield components traits in both seasons. However, Crop plus treatment significantly exceeded all others treatments for all yield and yield components traits, except number of seeds/pod where the superiority of this trait was recorded by Dotra micro plus and Dotra frost treatments, with no significant difference between the two treatments. Although, the superiority of Crop plus treatment for yield and yield components traits, this exceeded did not differ significantly from Dotra micro plus for plant height and number of branches/plant in both seasons and Dotra first for 100-seed weight in the first season. This exceeded of Crop plus treatment in yield and yield components compared with all others treatments, this could be due to the highest ability of this growth substance to increase the total numbers of flowers/plant, reduced shedding percentage and promoted pod setting. The superiority of Crop plus might be due to its chemical composition, where the growth substance contains three growth regulators, cytokinen, Oxcine and Citric acid in its composition and these substances absent in other growth substances (Table 1). Moreover, these components had high ability to increase holding flowers and pods. The application of growth substances such as Crop plus and Dotra micro plus alone or in mixtures resulted in significant increases in yield and its components. Such increases might be due to the fact that ions of Zn, Fe and Mn are co-factors of several enzymes, but rarely if ever with a high degree of specificity (Mourad *et al.* (2004). The previous results were in agreement with those reported by El-Hawary *et al.* (1991), Hegazy *et al.* (1992), Hegazy *et al.* (1993), Shehata and Bondok (1996), Mahmoud *et al.* (2006), El-Gizawy and Mehasen (2009), Hanafy *et al.* (2010), Davood (2013) and Ali and Sadiq (2014).

**The interactions:** It could be clear through the results shown in Table 3 that, highly significant effect of the interaction between cultivars and growth substances on plant height, number of pods/plant, number of seeds/plant, seed yield/plant and seed yield/ha in both seasons. The highest values of the interactions for plant height were presented in the combinations of Crop plus with the three cultivars and these interactions exceeded all other interactions. However, the interactions between Dotra Micro Plus treatment and the cultivars Giza 716 and Sakha 1 did not significantly differ than the three interactions mentioned before with respect to plant height in both seasons. On the other side, the significant of the interactions were absent for number of branches/plant, number of seeds/pods and 100-seed weight, indicating that the three cultivars had not a different response to the different growth substances for these traits. For no. of pods/plant, the interactions between Crop Plus treatment and the three cultivars had highly significant difference than the other interactions in both seasons. For no. of seeds /plant, the interactions, Crop Plus x Nubaria 1, Crop Plus x Giza 716 and Crop Plus x Sakha 1 exceeded the other interactions in this respect in both seasons. However, the interactions; Dotra Frost x Nubaria 1 and Dotra Frost x Sakha 1 in the first season and the interactions ; Dotra Frost x Giza 716 and Dotra Micro Plus x Giza 716 in the second season did not significantly differ than the other interactions pointed out with respect to no. of seeds /plant. For seed yield (g) / plant, the results in Table 5 indicated that, the interaction between Crop Plus treatment with Nubaria 1 cv. was significantly exceeded the other interactions in both seasons with respect to seed yield/ plant and seed yield (ardab)/ha, the results pointed out that, the interaction between Crop Plus treatment and Nubaria 1 cv. had a superiority over the other interactions in the first season, while the interaction between Crop Plus and each of Nubaria 1 and Giza 716 were significantly exceeded the other interactions in the second season. This result in harmon with those reported by Magdi (2011) where he found significant differences between cultivar and spray treatment interaction for

plant height, number of branches/plant total green yield, weight of 10 pods, pod length and weight of 100 green seeds and Khalil *et al.* (2015) found that, the interaction between calcium nutrition and varieties had a significant effect on weight of seeds/plant, seed index and harvest index, in both seasons.

## **2- Effects of cultivars, growth substances and their interactions on chemical composition traits.**

**Cultivars effects:** It could be clear from the results shown in Table 4 that, Giza 716 cv. had highly significant mean values for carotain in the second season and chlorophyll A in the first one and carbohydrate % in both seasons. With respect to carotain in 2012/13season, chlorophyll A, and B and protein content in 2013/14 season, the results revealed insignificant differences among the three cultivars. Nubaria 1 cv. seemed to be surpassed the other cultivars for carotain content in 2013/14 season and chlorophyll B and protein content in 2012/13 season. Meanwhile, Sakha 1 cv. expressed highly significant mean values for chlorophyll A in 2012/13 season. From the comparison between the three cultivars in chemical composition, it could be clear that, the cultivar Giza 716 followed by Nubaria 1 were the best among all tested genotypes. The differences between the three tested cultivars may due to the widely diversity in genetic constitution of these cultivars and the ability of each cultivars to uptake and accumulation the micro- nutrients from the soil. Also, it may be due to the difference in leaf area and the total canopy and the ability of canopy to absorption these micro- elements. The cultivars differences in chemical composition were reported before by Magdi (2011) which indicated that, significant differences were observed among the cultivars with respect to chemical compositions.

**Growth substances effect:** It could be clear that the differences between all growth substances and the control treatment were highly significant for all chemical composition traits in both seasons. However, Crop plus treatment significantly exceeded all others treatments for chemical composition traits as shown as in Table 4. The control treatment seemed to be the worst among all treatments in all chemical composition traits. Generally, the growth substances play a major role in increase chemical compositions of faba bean cultivars. This result was in agreement with those reported by Mahmoud *et al.* (2006) which indicated that, boron foliar fertilization in a concentration of 25 – 50 ppm as spray solution in combination with 96 ton nitrogen/ha as soil treatment has significantly increased seed protein and carbohydrate. Ibrahim *et al.* (2007) found that, all the used bio regulators caused significant increase in the protein and total carbohydrate percentage of the produced seeds resulted from the treated plants. El-Gizawy and Mehasen (2009) reported that, adding 72 ton/P<sub>2</sub>O<sub>5</sub> mixed with PDB markedly increased protein%, N%, P%, N and P uptake, Hanafy *et.al.* (2010) indicated that, addition of humic acid as well as foliar application with novavol, putrescine and vegi max significantly increased plant pigments, i.e. chlorophyll a, total chlorophyll and carotenoids concentrations either in leaves or pods. Similar results were found by Abou EL-Yazied and Mady (2012), Amin *et al.* (2014) and Reda *et al.* (2014).

**The interaction effects:** The highest significant values of the interactions were presented in the combinations of Crop plus with Nubaria 1 cultivar for carotain in both seasons and the interaction between Crop Plus and the three cultivars i.e. crop Plus x Nubaria 1, Crop Plus x Giza 716 and Crop Plus x Sakha 1 for chlorophyll A in both seasons, as shown as in Table 5. With respect to chlorophyll B, the interaction between Crop Plus and Nubaria 1 in both seasons and Crop Plus with Sakha 1 in the second season were significantly surpassed the other interactions. The interactions between Crop Plus and each of the three cultivars in both seasons and between Dotra Micro Plus and each of the three cultivars in the first season gave the significantly highest values for protein content. For carbohydrate percentage, the interaction between Crop Plus and each of the three cultivars in both seasons had a superiority in this respect. This indicated that, the three cultivars had a different response to the different growth substances and the confirms the overlapping effect of the cultivars with the resulting

effect on the growth substances in these traits, and this overlap value will vary depending on the cultivar and the degree of its response to the growth substance.

Table 2. Effect of cultivars, growth substances treatments, yield and yield components and their interactions in both seasons.

Factor s	Plant height(cm)		No. of branches/pl ant		No. of pods/plant		No. of seeds/po d		No. of seeds/plant		100-seed weight(g)		Seed yield /plant (g)		Seed yield (ardab)/ha.	
	S <sub>1</sub>	S <sub>2</sub>	S <sub>1</sub>	S <sub>2</sub>	S <sub>1</sub>	S <sub>2</sub>	S <sub>1</sub>	S <sub>2</sub>	S <sub>1</sub>	S <sub>2</sub>	S <sub>1</sub>	S <sub>2</sub>	S <sub>1</sub>	S <sub>2</sub>	S <sub>1</sub>	S <sub>2</sub>
<b>Cultivar (A)</b>																
<b>Nubaria 1</b>	111.72	114.56	3.98	3.81	9.94	12.49	2.79	2.27	27.75	28.35	107.13	105.39	30.17	30.55	33.53	30.32
<b>Giza 716</b>	115.06	116.86	4.05	4.08	9.78	13.22	2.82	2.32	27.58	30.65	83.99	82.65	24.13	25.52	29.90	27.89
<b>Sakha 1</b>	119.06	121.35	3.13	3.34	9.31	12.81	2.93	2.33	27.32	29.46	76.33	75.33	21.38	22.1	27.10	25.03
<b>F – test</b>	**	**	**	**	*	*	NS	NS	Ns	*	**	**	**	**	**	**
<b>LSD 0.01</b>	3.942	3.888	0.574	0.479	-	-	-	-	-	-	3.214	1.934	2.074	2.012	1.68	1.25
<b>Growth substances (B)</b>																
<b>Control</b>	106.52	108.17	3	2.82	6.28	8.12	2.93	2.39	18.42	19.43	85.47	84.98	18.17	17.89	23.57	20.27
<b>Crop plus</b>	125.02	126.33	4.57	4.77	14.07	18.67	2.58	2.11	36.37	39.34	93.68	91.88	34.73	36.68	37.66	38.23
<b>Dotra frost</b>	108.57	111.72	3.35	3.23	10.58	13.6	3.16	2.56	33.4	33.95	84.17	83.08	26.06	26.15	28.95	25.88
<b>Dotra micro plus</b>	120.27	123.37	4.2	4.52	9.65	13.15	3.18	2.68	30.72	34.16	89.61	88.76	27.72	30.65	34.54	31.92
<b>Dotra firt</b>	116.03	118.37	3.48	3.38	7.8	10.67	2.42	1.93	18.85	20.55	92.8	90.22	19.46	18.89	26.21	22.46
<b>F – test</b>	**	**	**	**	**	**	**	**	**	**	**	**	**	**	**	**
<b>LSD 0.01</b>	5.408	3.755	0.45	0.414	0.827	0.765	0.52	0.56	2.069	2.933	2.631	2.552	1.713	2.43	1.12	1.24
<b>A B Interaction</b>																
<b>F – test</b>	**	**	Ns	Ns	**	**	NS	NS	**	**	Ns	Ns	**	**	**	**

Table 3. Effect of the interaction between the three cultivars and the five growth substance on seed yield and yield components traits of faba bean.

Treatments		Plant height(cm)		No. of pods/plant		No. of seeds/plant		Seed yield /plant (g)		Seed yield(ardab) /ha.	
		S <sub>1</sub>	S <sub>2</sub>	S <sub>1</sub>	S <sub>2</sub>	S <sub>1</sub>	S <sub>2</sub>	S <sub>1</sub>	S <sub>2</sub>	S <sub>1</sub>	S <sub>2</sub>
Control	Nubaria 1	104	106.65	6.95	7.35	17.8	18.15	20.58	21.64	25.776	22.56
	Giza 716	105.25	106.5	5.7	8.95	18.8	19.2	18.06	16.44	23.28	19.224
	Sakha 1	110.3	111.35	6.2	8.05	18.65	20.93	15.87	15.6	21.648	18.96
Crop Plus	Nubaria 1	122.9	123.95	13.7	18.15	37.25	39.18	43.23	43.07	41.232	41.064
	Giza 716	124.8	125.65	14.65	19.55	35.75	40.6	31.88	35.73	37.632	39.096
	Sakha 1	127.35	129.4	13.85	18.3	36.1	38.25	29.1	31.26	34.056	34.512
Dotra Frost	Nubaria 1	106.3	108.35	10.5	13.25	35.05	32.98	33.71	30.41	33.504	28.368
	Giza 716	108.3	111.3	10.85	14.1	32.45	37.38	24.64	27.37	28.08	27.672
	Sakha 1	111.1	115.5	10.4	13.45	32.7	31.5	19.85	20.68	25.248	21.6
Dotra Micro Plus	Nubaria 1	115.05	120.45	10.25	13.75	30.15	32.55	31.45	35.54	38.136	34.128
	Giza 716	121.2	123.15	9.6	12.7	31.75	35.88	26.99	30.95	34.848	32.76
	Sakha 1	124.55	126.5	9.1	13	30.25	34.05	24.71	25.47	30.624	28.848
Dotra Firt	Nubaria 1	110.35	113.4	8.3	9.95	18.5	18.9	21.91	22.08	29.04	25.464
	Giza 716	115.75	117.7	8.1	10.8	19.15	20.18	19.08	17.1	25.68	20.712
	Sakha 1	122	124	7	11.25	18.9	22.58	17.39	17.49	23.904	21.216
LSD 0.01		9.36	5.72	1.32	1.33	4.68	5.08	2.97	4.21	1.944	2.136

Table 4. Effects of cultivars, growth substances and their interactions on chemical traits during 2012/13 and 2013/14 seasons.

Factors	Carotain		Chlorophyll a		Chlorophyll B		protein %		carbohydrate %	
	S <sub>1</sub>	S <sub>2</sub>	S <sub>1</sub>	S <sub>2</sub>	S <sub>1</sub>	S <sub>2</sub>	S <sub>1</sub>	S <sub>2</sub>	S <sub>1</sub>	S <sub>2</sub>
<b>Cultivar (A)</b>										
Nubaria 1	0.51	0.5	0.67	0.74	0.53	0.52	30.43	30.29	47.56	49.74
Giza 716	0.49	0.5	0.68	0.74	0.52	0.51	29.68	29.64	50.24	51.44
Sakha 1	0.52	0.49	0.68	0.74	0.52	0.52	29.64	29.45	47.85	49.23
F – test	Ns	*	**	Ns	**	Ns	*	Ns	**	**
LSD 0.05	-	0.008	-	-	-	-	0.72	-	-	-
LSD 0.01	-	-	0.005	-	0.006	-	-	-	1.737	0.887
<b>Growth substances(B)</b>										
Control	0.4	0.37	0.5	0.52	0.4	0.38	24.81	24.38	44.12	45.63
Crop plus	0.63	0.63	0.89	0.99	0.69	0.72	36.13	36.81	54.32	55.5
Dotra frost	0.44	0.45	0.57	0.62	0.44	0.42	26.38	25.71	46.1	47.75
Dotra micro plus	0.59	0.57	0.77	0.92	0.59	0.61	33.63	33.35	50.64	52.86
Dotra firt	0.47	0.46	0.65	0.64	0.49	0.46	28.64	28.72	47.58	48.95
F – test	**	**	**	**	**	**	**	**	**	**
LSD 0.01	0.009	0.012	0.007	0.005	0.006	0.007	2.507	1.858	1.228	0.937
<b>A B Interaction</b>										
F – test	**	**	**	**	**	**	**	**	**	**

Table 5. Effect of the interaction between the three cultivars and the five growth substance treatments on chemical

Factors		Carotain (mg/g F.W.)		chlorophyll A		chlorophyll B		protein %		carbohydrate %	
		S <sub>1</sub>	S <sub>2</sub>	S <sub>1</sub>	S <sub>2</sub>	S <sub>1</sub>	S <sub>2</sub>	S <sub>1</sub>	S <sub>2</sub>	S <sub>1</sub>	S <sub>2</sub>
Control	Nubaria 1	0.4	0.37	0.5	0.52	0.39	0.39	25.12	25.81	42.71	44.72
	Giza 716	0.4	0.36	0.5	0.52	0.39	0.38	24.51	23.14	45.94	46.83
	Sakha 1	0.4	0.37	0.5	0.52	0.4	0.38	24.8	24.2	43.72	45.34
Crop Plus	Nubaria 1	0.64	0.65	0.89	0.98	0.71	0.72	37.97	38	53.63	55.62
	Giza 716	0.62	0.63	0.89	0.99	0.68	0.71	34.24	35.21	55.75	56.4
	Sakha 1	0.64	0.62	0.9	0.99	0.67	0.73	36.18	37.21	53.58	54.47
Dotra Frost	Nubaria 1	0.44	0.45	0.56	0.62	0.45	0.42	26.41	26.08	45.26	47.99
	Giza 716	0.43	0.45	0.57	0.62	0.44	0.42	27.65	26.39	47.76	49.01
	Sakha 1	0.45	0.45	0.58	0.62	0.44	0.42	25.07	24.65	45.27	46.24
Dotra Micro Plus	Nubaria 1	0.59	0.59	0.76	0.92	0.61	0.61	33.82	32.53	49.98	52.23
	Giza 716	0.57	0.58	0.77	0.92	0.58	0.61	33	33.56	51.86	53.9
	Sakha 1	0.6	0.55	0.77	0.93	0.57	0.61	34.07	33.97	50.09	52.47
Dotra Firt	Nubaria 1	0.46	0.45	0.64	0.63	0.5	0.46	28.85	29.03	46.23	48.12
	Giza 716	0.46	0.46	0.65	0.64	0.5	0.46	28.99	29.91	49.91	51.09
	Sakha 1	0.48	0.46	0.67	0.64	0.49	0.46	28.09	27.23	46.62	47.65
LSD 1%		0.016	0.021	0.012	0.009	0.01	0.012	5.34	3.47	2.98	1.662

### References

- Abou EL-Yazied A. and M. A. Mady. (2012). Effect of Boron and Yeast Extract Foliar Application on Growth, Pod Setting and both Green Pod and Seed Yield Of Broad Bean (*Vicia Faba L*). *J. of American Sci.* 8(4): 517-534.
- Ali, H. J. and A.Sadiq,(2014). Obaid effect of foliar fertilizers spray, boron and theirinteraction on broad bean (*vicia faba l.*) yield. *Scientific Papers. Series B, Horticulture.* 8 (2):78-91.
- Amin,A. A.; H. F. Abouziena; M. T. Abdelhamid; El-Sh. M. Rashad and A. E. Fatma Gharib (2014). Improving growth and productivity of faba bean plants by foliar application of thio urea and aspartic acid. *International J. of Plant and Soil Sci.* 3(6): 724-736.
- Davood, H. (2013). Phosphorus fertilizers effect on the yield and yield components of faba bean (*Vicia faba L.*) *Annals of Biolo. Res.,* 4 (2):181-184.
- El-Gizawy, N.Kh.B. and S.A.S. Mehasen (2009). Response of faba bean to bio, mineral phosphorus Fertilizers and foliar application with zinc. *World App. Sci. J.* 6 (10): 1359-1365.
- El-Hawary, N. A.; M. M.El-Mihi,; I. O.Metwally,; M. A.El-Masry, and A. S.Kamel, (1991). Influence of intercropping patterns and foliar spray with micronutrients on growth and yield of faba bean and onion.*Annals of Agricultural Science, Moshtohor;* 29(2):669-679.
- FAOSTAT (2014). *Production, Crops, Faba bean, 2014 data".* Food and Agriculture Organization. 2014.
- Gomez, K.A. and A.A. Gomez, (1984). *Statistical Procedures for Agricultural Research* (2 ed.). John wiley and sons, NewYork, p 680.
- Hanafy A., A. H.; M. R. Nesiem; A. M.Hewedy, and H. El-S. Sallam, (2010). Effect of some simulative compounds on growth, yield and chemical composition of snap bean plants grown under calcareous soil conditions. *J.l of Amer.Sci.,* 6 (10) 260-271.
- Hegazy, M. H.; D. N.Abadi, andS. A. Genaidy, (1993). Effects of some micronutrients and methods of application and rhizobium inoculation on faba bean.*Egy.J. of Agric. Res.,* 71(1):21-33.

- Hegazy, M. H.; D.N Abadi, and S. A. Genaidy, (1992). Effects of some micronutrients and methods of application and rhizobium inoculation on faba bean. *Egy. J. of Agric. Res.*, 70(4):1011-1023
- Ibrahim, M.E, B.; M.A., A. El-Moursi and N.A. Gaafar (2007). Improvement of growth and seed yield quality of vicia faba L. plants as affected by application of some bio regulators. *Australian J. of Basic and App. Sci.*, 1(4): 657-666.
- Kandil, A.A.; A.E.Sharief and A.S.A. Mahmoud (2011). Reduction of flower dropping in some faba bean cultivars by growth regulators foliar application. *J. of App. Sci. Res.*, 7(12): 1883-1889.
- Khalil, N. A.; W. A. Al-Murshidy, A. M. Eman, and R. A. Badawy (2015). Effect of plant density and calcium nutrition on growth and yield of some faba bean varieties under saline conditions. *J. of International Sci. Publications*. 3 (1): 1314-1323.
- Magdi, A. N. (2011). Effect of some foliar application on yield and its components in broad bean (*Vicia Faba L.*). *Egypt. J. Agric. Res.*, 89 (3), 1071-1084
- Mahmoud, M. S.; A. F. El- Sayed; E. Z.A. M. Aly and A.K. Mohamed (2006). Boron/Nitrogen Interaction Effect on Growth and Yield of Faba Bean Plants Grown under Sandy Soil Conditiona. *Int. J. of Agri. Res.* 1(4):322-330.
- Mourad, A. K.; S. A.Hammad,; G. Z.Guirguis,;O. A. Zaghoul, and H. A.Sadek, (2004). Action of some micronutrients on the infestation and yield components of faba bean by the aphid, *Aphis craccivora* Koch (Aphididae, Homoptera) and the leaf miner, *Liriomyzatrifolii* (Burgess) (Agromyzidae, Diptera). *Comm. in Agric. and App. Bio.Sci.* 69(3):291-304.
- Reda, Fatma.; Magdi T. Abdelhamid and S. R. El-Lethy (2014). The role of zn and b for improving *Vicia faba L.* tolerance to salinity stress. *Middle East J. of Agric. Res.*, 3(4): 707-714.
- Shehata, S. A. M. and M. A. Bondok, (1996). Induction of pod setting and shedding reduction in faba bean (*Vicia faba L.*) by the auxin transport inhibitors TIBA and NPA. *Ann. of Agric. Sci. Cairo*, 41(1):35-49.
- Talaat, Neveen, B. and A.M.Abdallah (2008). Response of faba bean (*vicia faba l.*) To dual inoculation with rhizobium and va mycorrhiza under different levels of n and p fertilization. *J. of App. Sci. Res.*, 4(9): 1092-1102.

## EFFECT OF CLIMATE ON SOIL ORGANIC MATTER IN FARMING SYSTEMS IN FOUR REGIONS OF GERMANY

Lucie CHMELÍKOVÁ\*, Harald SCHMID, Kurt-Jürgen HÜLSBERGEN

Chair of Organic Agriculture and Agronomy, Technische Universität München

\*Corresponding author: lucie.chmelikova@mytum.de

### Abstract

Soil organic matter (SOM) has long been considered a key factor in sustaining the physical, chemical and biological properties of soil. A network of 40 pairs of organic and conventional farms across four regions of Germany was established focusing on research on climate impacts and sustainability indicators in agricultural production. In one part of the joint project “Climate Effects and Sustainability of Agricultural Systems – Analyses in a Network of Pilot Farms” soil chemical, biological and physical properties were investigated. We aimed to study the influence of climate (precipitation, temperature and altitude) on SOM ( $C_{org}$  and  $N_t$ ) in four regions (East, South, West and North) of Germany. To analyse different effects on soil properties soil samples were taken between 2009 and 2011 on 80 farms (10 pairs of neighbouring farms in four regions). The measurements are based on 207 plots located on cropland and 56 plots located on grassland. The data was analysed with cluster analyses. The analysis created and compared four groups with similar climate data and four groups of plots with similar  $C_{org}$  and  $N_t$ . In cropland 46.9% of the plots with similar climate data had similar SOM in depth 0-30 cm. In grassland this was the case for 48.2% of the plots in depth 0-10 cm and only 37.5% in depth 10-30 cm. The results suggested a higher effect of climate variables on SOM in cropland than in grassland. The differences might be caused by different site conditions. For further research other site conditions (soil texture, ground water etc.) will be included.

**Keywords:** *Carbon, Nitrogen, Precipitation, Grassland, Cropland*

### Introduction

To achieve sustainable land use, it is important to understand the influences of agriculture on biotic, abiotic and structural parameters of soils. To answer these questions, a network of 40 pairs of organic and conventional farms across four regions of Germany (East, South, West, and North) was established with focus on research on climate impacts and sustainability indicators in agricultural production. The 10 farm pairs in each region are composed of 10 organic and 10 conventional managed farms. The chosen farm pairs (organic and conventional) were selected close together. In consequence the farm pairs in each region have similar soil and climatic conditions. The farms can be classified as cash-crop, dairy and mixed farms. In a part of the joint project “Climate Effects and Sustainability of Agricultural Systems – Analyses in a Network of Pilot Farms” soil chemical, biological and physical indicators are investigated. This article is focusing only on soil organic carbon (SOC).

SOC plays a key role in the global carbon cycle. Lately carbon sequestration in surface soils, especially in relation to agricultural land-use, has often been discussed as a possible mitigation strategy for global climate change (Davidson et al. 2000; Martin et al. 2011).

The SOC content depends on many factors, e.g. climatic conditions and land-use. The relationship between climatic variables and the amount of organic carbon in the soil is well



known. According to Chaplot et al. (2010), variability in SOC was correlated with average annual precipitation and was affected by land use. E.g. more SOC was localized under shifting cultivation than under continuous cultivation. Despite land-use, Arrouays et al. (2001) identified contrasting climatic conditions and elevation as the main factors for the soil carbon distribution in France as well. To climate conditions include temperature and its indirect effect - soil moisture (Conant et al. 2011). Temperature is an important factor controlling SOM turnover (Haddix et al. 2011). According to Martin et al. (2011), the effect of temperature was important, but less than the effect of precipitation. As suggested by Jenny (1941) and Post et al. (1982), cool conditions and wet soils can impede decomposition, and SOC is highest under cool and moist conditions and lowest under hot and dry conditions. Climate conditions also affect yield and thus the input of carbon to the soil.

Here is a remarkable lack of information about the status quo of organic carbon in agricultural soils. We therefore aimed to study the effects of organic as well as conventional farming on soil organic matter in four regions (East, South, West and North) of Germany. The aims of the present study were to (i) report the soil organic carbon ( $C_{org}$ ) and (ii) total nitrogen ( $N_t$ ) content. For the evaluation of the SOC an inventory of the SOC content was carried out. Further, the content of SOC was investigated in relation to climate conditions (annual sum of precipitation, seasonal mean of temperature and altitude). We studied these factors controlling the levels of organic matter in soils in order to identify sustainable strategies for land management and to properly assess SOC in relation to potential greenhouse gas (GHG) emissions.

### **Material and Methods**

In total at 80 farms across four regions of Germany (East, South, West, and North) soil samples were taken. 207 soil samples were collected from arable land and 56 from grassland. The elevation of the monitoring plots in the South region (Tertiary Hills and Allgäu) ranges from 444 to 776m, in the West region (Lower Rhine Bay and Mittelgebirge) from 21 to 421m, in East region (Loess dry sites in Central Germany and diluvial sites Altmark and Spreewald) from 28 to 316m and in the North region (North and East Baltic-Sea coastal region) from -4 to 52m. The study areas include maritime climate in the north, dry-continental conditions in the east of Germany, high-precipitation areas in pre-alpine region in the South and mild humid climate in the west with typical soil conditions for the areas.

In arable land/cropland, the soil was sampled in fields with winter cereals. At each experimental site all data were collected in four sampling plots, each 10 m × 10 m in size. Each monitoring plot is a square of about 100m<sup>2</sup> and the positions of the corners have been exactly measured and their coordinates determined with a global positioning system (GPS). For each monitoring plot there is a database with detailed information comprising crops, intermediate crops, amount and kind of mineral and organic fertilizers applied and tillage (management practice data). This SOM investigation was only one part of a larger sampling including various chemical, physical and biological soil properties.

Samples were collected on cropland from the soil layer 0-30 cm and in layers 0-10cm and 10-30cm for grassland. To measure bulk density in the middle of each study site 5 undisturbed soil cores were collected. For the bulk density the steel cores (54 mm internal diameter and 40 mm height, with wall thickness approximately 1.5 mm) were used for sampling grassland at 0-10 cm and 10-30 cm depth, taking five replications of each undisturbed soil per plot. For arable land, the two depths were not differentiated and together 10 cores were taken up. In the laboratory the soil samples were weighted and later dried in the oven at 105°C for 24 h.

Soil samples for analysis were air dried and passed through a 2 mm sieve. Basic components of SOM ( $C_{org}$  and  $N_t$ -content) were simultaneously determined by the dry combustion method

(Dumas method) in a vario Max CNS elemental analyzer (ELEMENTAR, Germany). Soil samples composed of carbonates were treated in a muffle furnace. After oven drying of the sediment to constant weight (or dry matter) and cooling to room temperature, organic matter was combusted to ash and carbon dioxide at temperatures 550°C. The organic carbon ( $C_{org}$ ) was calculated as  $C_{org} = C_t - C_{carbonate}$ .

The SOC and  $N_t$  variability was evaluated using cluster analysis in the STATISTICA 8.0 program (Statsoft, Tulsa). This analysis was based on the content  $C_{org}$  and  $N_t$  and on climate conditions (annual sum of precipitation, seasonal mean of temperature and altitude) for different sites.

### Results and Discussion

Over two years (2009-2011), 263 plots (207x cropland with winter cereals, 56x grassland) of 80 organically and conventionally managed farms were sampled and soil samples were analysed. The plots were located in four regions in Germany (East, South, West, and North). For first evaluation, the plots were characterized by climate conditions (annual sum of precipitation, seasonal mean of temperature and altitude).

In the first step, the cluster analysis created four groups of plots with similar climate conditions. The regions were hereby redefined. Some plots in regions had similar climate conditions with plots in other regions, e.g. because of its location in mountain areas. The climate characteristics of 4 groups in crop land as well as in grassland are shown in Tables 1 and 2.

Table 1. Four groups of sites with winter cereals defined through/with their similar climate conditions (annual sum of precipitation, seasonal mean of temperature and altitude).

		Precipitation (mm) annual sum	Temperature (°C) seasonal mean	Altitude (m)
Group 1 n = 76	Min	675	8.4	-4
	Mean	739	9.2	55
	Max	820	10.8	235
Group 2 n = 71	Min	510	8.2	12
	Mean	568	8.7	78
	Max	641	9.6	220
Group 3 n = 11	Min	450	8.8	91
	Mean	451	9.0	168
	Max	452	9.1	297
Group 4 n = 48	Min	785	7.3	341
	Mean	934	7.6	509
	Max	1109	8.0	665

In cropland, the first group was described by 675-820 mm of annual precipitation sum with 8.4-10.8°C and hight at -4-235 m a.s.l. The second group was defined by 510-641 mm, 8.2-9.6 °C and 12-220 m a.s.l., the third by 450-452 mm, 8.8-9.1°C and 91-297 m a.s.l. and the fourth by 785-1109 mm, 7.3-8.0°C and 341-665 m a.s.l.

In grassland, the first group was described by 785-1109 mm of annual precipitation sum with 7.3-8.3°C and altitude at 329-632 m a.s.l. The second group was defined by 1228-1507 mm, 6.9-7.2 °C and 650-776 m a.s.l., the third by 686-820 mm, 8.4-10.8°C and -3-209 m a.s.l. and the fourth by 451-641 mm, 8.4-9.6°C and 20-305 m a.s.l.

Table 2. Four groups of grassland sites defined through/with their similar climate conditions (annual sum of precipitation, seasonal mean of temperature and altitude).

		Precipitation (mm) annual sum	Temperature (°C) seasonal mean	Altitude (m)
Group 1	Min	785	7.3	329
n = 11	Mean	982	7.8	490
	Max	1109	8.3	632
Group 2	Min	1228	6.9	650
n = 12	Mean	1367	7.0	747
	Max	1507	7.2	776
Group 3	Min	686	8.4	-3
n = 19	Mean	750	9.2	58
	Max	820	10.8	209
Group 4	Min	451	8.4	20
n = 14	Mean	550	8.8	92
	Max	641	9.6	305

In the second step, the cluster analysis created four groups of plots in cropland with similar  $C_{org}$ ,  $N_t$  and C:N ratio. Details are shown in Table 3.

Table 3. Four groups of sites with winter cereals with their similar  $C_{org}$ ,  $N_t$  and C:N ration in the soil depth 0-30 cm.

		$C_{org}$ (%)	$N_t$ (%)	C:N ratio
Group 1	Min	0.65	0.04	14.4
n = 29	Mean	1.75	0.11	16.3
	Max	2.41	0.15	19.3
Group 2	Min	0.50	0.04	11.4
n = 87	Mean	1.26	0.10	12.4
	Max	2.41	0.21	14.3
Group 3	Min	2.52	0.21	10.4
n = 16	Mean	3.73	0.32	11.7
	Max	5.59	0.54	13.5
Group 4	Min	0.53	0.05	8.1
n = 77	Mean	1.40	0.14	10.4
	Max	2.37	0.23	11.4

The members of four groups with similar climate conditions were compared with members of the four groups with similar values  $C_{org}$ ,  $N_t$ , and C:N ratio. In cropland 46.9% of the plots with similar climate conditions had similar SOM in depth 0-30 cm.  $C_{org}$  of plots with winter cereals ranged from 0.5 to 5.59%,  $N_t$  ranged from 0.04 to 0.54% with C:N ratio between 8.1 to 19.3. The cluster analysis created four groups of plots with similar  $C_{org}$ ,  $N_t$  and C:N ratio in grassland as well. The groups for the depth 0-10 cm are defined in Table 4 and for the depth 10-30 cm in Table 5.

The groups were separately compared for depths 0-10 cm and 10-30 cm. In the upper layer, 48.2% of the plots had similar climate and SOM conditions. Only 37.5% of the plots had similar climate and SOM conditions in depth 10-30 cm. In grassland in depth 0-10 cm,  $C_{org}$  ranged from 2.28 to 18.25%,  $N_t$  from 0.13 to 1.61% with C:N ratio from 7.6 to 18.1. In the depth 10-30 cm,  $C_{org}$  ranged from 0.92 to 21.62%,  $N_t$  from 0.07 to 1.85% with C:N ratio from 8.1 to 19.2.

Table 4. Four groups of grassland with their similar  $N_t$ ,  $C_{org}$  content and C:N ratio in the upper 10 cm in the soil.

		$C_{org}$ (%)	$N_t$ (%)	C:N ratio
Group 1	Min	3.32	0.36	7.6
n = 13	Mean	5.25	0.52	10.0
	Max	10.13	0.98	10.9
Group 2	Min	11.49	0.76	9.6
n = 5	Mean	13.71	1.22	11.7
	Max	18.25	1.61	15.6
Group 3	Min	2.28	0.13	9.7
n = 26	Mean	3.16	0.28	11.5
	Max	4.93	0.37	18.1
Group 4	Min	5.15	0.52	9.8
n = 12	Mean	7.95	0.72	11.1
	Max	10.65	1.04	12.6

Table 5. Four groups of grassland with their similar  $N_t$ ,  $C_{org}$  content and C:N ratio in the depth 10-30 cm in the soil.

		$C_{org}$ (%)	$N_t$ (%)	C:N ratio
Group 1	Min	1.10	0.09	11.0
n = 5	Mean	1.42	0.12	11.6
	Max	1.98	0.17	12.9
Group 2	Min	0.92	0.09	8.1
n = 12	Mean	2.34	0.23	10.0
	Max	5.07	0.50	11.0
Group 3	Min	1.01	0.07	12.9
n = 26	Mean	2.86	0.19	15.2
	Max	4.55	0.35	19.2
Group 4	Min	6.01	0.48	10.1
n = 13	Mean	8.93	0.77	11.8
	Max	21.62	1.85	16.8

We concluded, that the climate conditions are one of the main influences on SOC. However, Wiesmeier et al. (2013) suggested climate effects (mean annual temperature and precipitation) had minor importance in cropland soils because these are attenuated by management.

Generally lower  $C_{org}$  and  $N_t$  content in the soil were found for cropland soils. Grassland soils stored more amount of SOC in both soil layers as suggested by many authors (e.g. Arrouays et al. 2006; Leifeld et al. 2005). In accordance with results of Leifeld et al. (2005) organic carbon increased in grassland with altitude.

Further, Leifeld et al. (2005) evaluated the clay content and its influence on the variability in SOC concentrations in the fine earth of arable soils. However, he effect was not significantly related to SOC in grassland soils at higher altitudes. Probably, the differences in SOC can be explained on sites with different land-use by several other influences. Different land-use is associated with different bulk density (BD). In the next step, SOC stocks will be converted to the soil volume.

Further research is needed and other soil parameters should be taken into account as well as the farm characteristics (farm type. crop rotation. fertilizers. tillage. etc.). The study of the main factors affecting the spatial SOC distribution may improve the selection of suitable land

use and management designed to enhance the C sequestration and predict the potential impacts of changes in climate and land use on GHGs emission from soils.

### **Conclusions**

We studied the influence of climate, soil and organic as well as conventional farming on SOM in four regions of Germany. Climate conditions affected SOC pools the most, followed by agricultural land-use and soil characteristics. Nevertheless, more factors need to be taken into account to properly evaluate GHG emissions and enhance carbon sequestration.

### **Acknowledgements**

The study is funded by the German Federal Ministry of Food and Agriculture within the research framework “Federal Organic Farming Scheme and other forms of sustainable agriculture” (BÖLN) under the project title “Climate effects and sustainability of organic and conventional farming systems - investigations a network of pilot farms”. The project partners are Technische Universität München, Johann Heinrich von Thünen Institute, Rheinische Friedrich-Wilhelms-Universität Bonn, Martin-Luther-Universität Halle-Wittenberg and Bioland Beratung. Warm thanks go to our farmers who provided access to their land.

### **References**

- Arrouays D., Deslais W., Badeau V. (2001). The carbon content of topsoil and its geographical distribution in France. *Soil Use and Management*, Vol. 17, pp. 7–11.
- Chaplot V., Bouahom B., Valentin C. (2010). Soil organic carbon stocks in Laos. Spatial variations and controlling factors. *Global Change Biology*, Vol. 16, pp. 1380–1393.
- Conant R.T., Ryan M.G., Ågren G.I., Birge H.E., Davidson E.A., Eliasson P.E. et al. (2011). Temperature and soil organic matter decomposition rates - synthesis of current knowledge and a way forward. *Global Change Biology*, Vol. 17, pp. 3392–3404.
- Davidson E.A., Trumbore S.E., Amundson R. (2000). Soil warming and organic carbon content. *Nature*, Vol. 408, pp. 789–790.
- Haddix M.L., Plante A.F., Conant R.T., Six J., Steinweg J.M., Magrini-Bair K. et al. (2011). The Role of Soil Characteristics on Temperature Sensitivity of Soil Organic Matter. *Soil Science Society of America Journal*, Vol. 75, pp. 56–68.
- Jenny H. (1941). *Factors of Soil Formation*. McGraw-Hill, New York.
- Leifeld J., Bassin S., Fuhrer J. (2005). Carbon stocks in Swiss agricultural soils predicted by land-use, soil characteristics and altitude. *Agriculture Ecosystems & Environment*, Vol. 105, pp. 255–266.
- Martin M.P., Wattenbach M., Smith P., Meersmans J., Jolivet C., Bouillon L., Arrouays D. (2011). Spatial distribution of soil organic carbon stocks in France. *Biogeosciences*, Vol. 8, pp. 1053–1065.
- Post WM, Emanuel WR, Zinke PJ, Stangenberger AG (1982) Soil carbon pools and world life zones. *Nature*, Vol. 298, pp. 156-159.
- Wiesmeier M., Hübner R., Barthold F., Spörlein P., Geu U., Hangen E. et al. (2013). Amount, distribution and driving factors of soil organic carbon and nitrogen in cropland and grassland soils of southeast Germany (Bavaria). *Agriculture, Ecosystems & Environment*, Vol. 176, pp. 39–52.

## ROOT DISTRIBUTION OF SUGAR BEET AND WINTER CEREALS ON DIFFERENT SOILS

Lucie CHMELÍKOVÁ\*, Harald SCHMID, Sebastian WOLFRUM, Kurt-Jürgen HÜLSBERGEN

Chair of Organic Agriculture and Agronomy, Technische Universität München

\*Corresponding author: lucie.chmelikova@mytum.de

### Abstract

Root distribution plays an important role in estimating soil organic carbon in agroecosystems. The evaluation of root distribution is difficult due to laborious measurements and root variability. Soil texture affects root penetration and thus alters the morphology and distribution of roots. The soil profile wall method is suitable for evaluating the effects of soil and other variables on root length density (RLD). RLD of winter cereals (wheat and rye) and their preceding crop sugar beet was observed using the profile wall method up to 2 m depth at three sites in Lower Saxony (Germany). The sites differed in soil texture comprising sandy (sand 84%, silt 14%, clay 4%), silty (1%, 80%, 19%) and clayey (2%, 56%, 42%) sites. Generally, the winter cereals had higher RLD than sugar beet and simultaneously the differences in RLD were higher between the sites. The results indicated a high variability of RLD in the topsoil (sugar beet: 0.394 - 0.973 cm cm<sup>-3</sup>, winter cereals: 2.172 - 5.553 cm cm<sup>-3</sup>). For both, sugar beet and winter cereals, importance of soil texture increased in the subsoil (soil layers 60-90 cm and 90-120 cm). In the depth 60-90 cm, the highest RLD of all species was found at the silty site. In the depth 90-120 cm the highest RLD was recorded for sugar beet at the clayey site. In this soil layer the highest RLD of sugar beet was recorded at the silty site. RLD of sugar beet and winter cereals was correlated at all sites ( $p < 0.05$ ). The correlation coefficient at the sandy site was  $r=0.85$  ( $df=25$ ), followed by the silty site with  $r=0.83$  ( $df=25$ ) and clayey site with  $r=0.69$  ( $df=25$ ). This might indicate that sandy soil texture influences the species similarly.

**Keywords:** *Beta vulgaris*, Profile wall method, Root length density, Winter wheat.

### Introduction

Root distribution of crops plays an important role in maintaining water and nutrient supply to plant tissues. It also contributes to the maintenance of soil organic matter (Jenkinson & Coleman, 2008). Additionally, roots are important because of their close relationship to the yield of aboveground organs (Lamb et al., 2000).

The evaluation of root distribution is difficult due to the variability in root distributions and soil properties. The root length density (RLD) can be used to assess root distribution. RLD is an important parameter for characterizing root system features and spatial distribution at different soil depths. RLD, expressed as cm root length per cm<sup>3</sup> of soil volume, reflects the relative distribution of root length in the soil profile. One way of assessing the RLD is the profile wall method. It is used to evaluate changes in soil structure induced by agricultural management considering compaction and the presence of cracks (Neves et al., 2003). Additionally, it describes the relationship between soil characteristics and root variability. Knowledge about root distribution over the soil profile and with time can be used in the design of crop rotations with improved N use efficiency (Kristensen & Thorup-Kristensen,

2004). Hence, more studies about root distribution with depth are needed. Further, Thorup-Kristensen et al. (2009) suggested that observations below 1 m are important in order to understand N dynamics in wheat cultivation.

Soil texture also affects root penetration and thus alters the distribution of roots. Anderson (1988) recorded more deep roots in fine- and coarse-textured soils than in medium-textured soils.

Although the RLD of different crops under different soil conditions has frequently been studied, there is a lack of studies under field conditions on real farms. The present study was therefore conducted to investigate the spatial distribution of RLD of sugar beet and the winter cereals (wheat and rye) that followed sugar beet in the crop rotation.

The main aim of this paper was to answer the following research questions: (i) How does the RLD of sugar beet and winter cereals differ according to depth? (ii) Is there some relationship between RLD of the preceding crop sugar beet and the RLD of winter cereals?

### **Material and Methods**

The RLD measurements were taken from three sites on a conventionally-managed farm in Lower Saxony. The sites differed in soil texture comprising sandy (sand 84%, silt 14%, clay 4%), silty (1%, 80%, 19%) and clayey (2%, 56%, 42%) sites. Sugar beet was investigated in 1987 and winter cereals in the following year using the profile wall method (Böhm, 1979) in all cases. Winter wheat was investigated at the silty and clayey sites, winter rye at the sandy site. The experimental areas were located at an altitude ranging from 100 to 145 m. a.s.l. The average annual precipitation and temperature ranged from 610 mm and 8.3°C at 100 m a.s.l. to 680 mm and 8.6°C at 145 m a.s.l. The distance between rows was 45 cm for sugar beet at all sites and 12.5 cm for the winter cereals. The yield of all crops was recorded. The sugar beet was sampled four times during the season (from BBCH 33 to BBCH 59) and cereals twice in BBCH 32 and BBCH59. For the evaluations, the mean of the sampling dates was used.

RLD and root distribution over the soil profile were assessed using the profile wall method. A rectangular pit was dug at each site at right angles to the plant rows down to 2 m soil depth. The counting depth at all sites was 2 m. On each sampling date two counts were carried out, and before each count a fresh profile layer was prepared by removing a 0.2 m soil layer. Each sampling transect was 0.9 m (measured perpendicular to the rows).

Steel nails (with heads 3 mm wide) were pushed into the profile wall at intervals of 10 cm and afterwards the soil layer was smoothed by washing away about 3 mm of soil with a sprayer. The correct thickness of the removed layer was indicated by the nail markers. After smoothing the roots were visible and root lengths were counted using a square grid with square size of 5 x 5 cm. The root diameter was not measured. For the estimation of root length a screwdriver with a tip edge 5 mm in width was used to define one countable root unit. Thus, every part of an exposed main or lateral root was counted. RLD ( $\text{cm cm}^{-3}$ ) was calculated for each grid cell by dividing root length (root unit count x 0.5 cm) by the volume of the sprayed-off soil layer (5 x 5 x 0.3 cm).

### **Results and Discussion**

Generally, the winter cereals had higher RLD than sugar beet. Winter wheat and winter rye had higher RLD than sugar beet. The different RLD distributions of winter wheat and sugar beet at the three sites with different soils are shown in Figure 1.

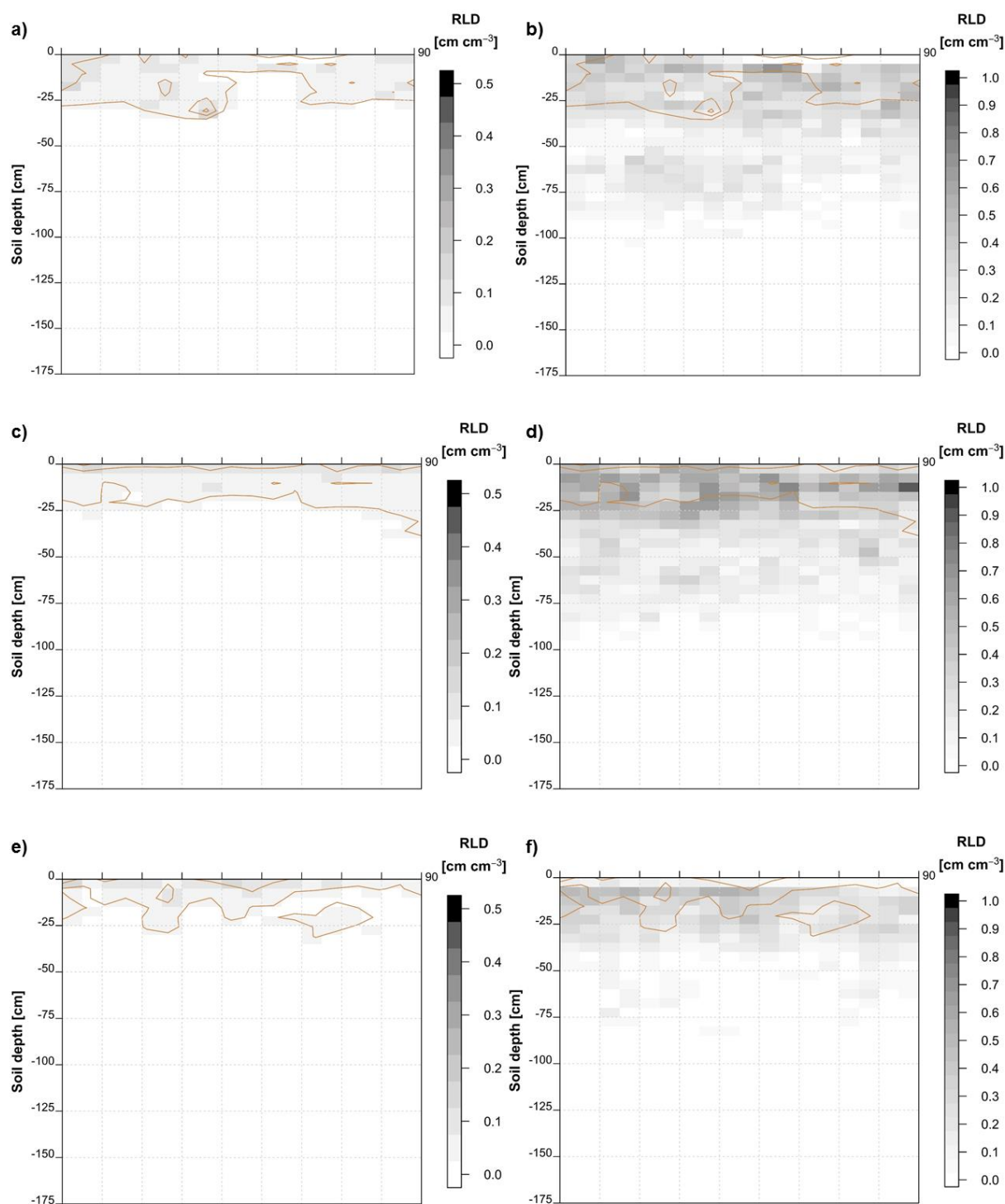


Figure 1. Profile walls at sandy site (a) sugar beet and (b) winter rye; at silty site (c) sugar beet and (d) winter wheat and at clayey site (e) sugar beet and (f) winter wheat

Sugar beet (BBCH 59) roots were recorded from 0 to a depth of 165 cm at the clayey site, from 0 to a depth of 115 cm at the silty site and from 0 to a depth of 85 cm at the sandy site. One year later, winter wheat (BBCH 59) roots were recorded from 0 to a depth of 90 cm at the clayey site, from 0 to a depth of 125 cm at the silty site. Winter rye (BBCH 59) roots were recorded from 0 to a depth of 135 cm at the sandy site.



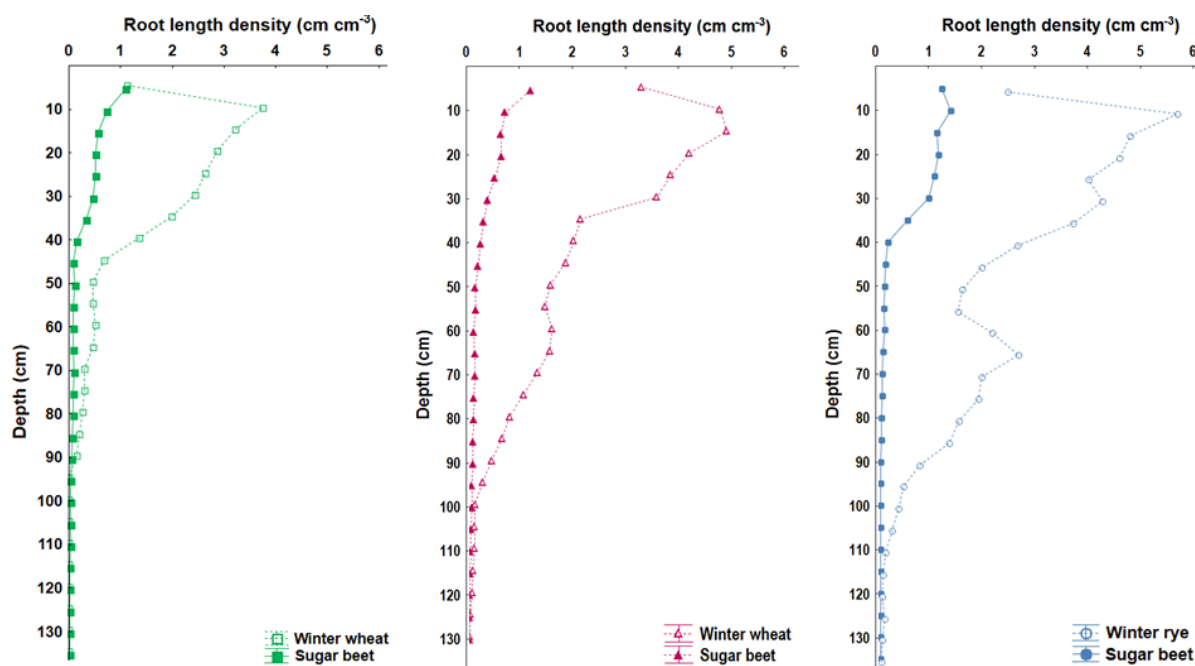


Figure 2. The RLD distribution of winter wheat and sugar beet at (a) clayey, (b) silty and the RLD distribution of winter rye and sugar beet at (c) sandy site

The RLD in the topsoil was significantly higher than in the subsoil. The results indicated a high variability of RLD in the topsoil. RLD of sugar beet ranged between 0.394 - 0.973  $\text{cm cm}^{-3}$  and RLD of winter cereals between 2.172 - 5.553  $\text{cm cm}^{-3}$ . For both, winter cereals and sugar beet, the importance of soil texture increased in the subsoil (soil layers 60-90 cm and 90-120 cm), where RLD was affected through bulk density and water availability. In the depth 60-90 cm, the highest RLD of all species was found at the silty site. In the depth 90-120 cm the highest RLD was recorded for sugar beet at the clayey site. In this soil layer the highest RLD of sugar beet was recorded at the silty site. In Figure 2, RLD of sugar beet and winter cereals was correlated at all sites ( $p < 0.05$ ). The correlation coefficient at the sandy site was  $r=0.85$  ( $df=25$ ), followed by the silty site with  $r=0.83$  ( $df=25$ ) and clayey site with  $r=0.69$  ( $df=25$ ). This might indicate that sandy soil texture influences both crops similarly.

Thus, the taproots of a dicot (sugar beet) and fibrous monocot roots (cereals) had different root distributions, sugar beet having lower RLD. This fact is in accordance with results of Mengel et al. (2001). He reported that monocots had much longer roots than dicots. Hamblin & Tennant (1987) even reported that the root lengths of cereals were consistently 5-10 times larger than those of legumes.

For the assessment of the RLD the profile wall method was chosen, which has advantages and limitations (Vepraskas & Hoyt, 1988; Basilio de Azevedo *et al.*, 2011). One of the limitations is that the profile method was not applicable in the deep subsoil on clayey soil. Kücke et al. (1995) used the method only down to 0.45 m soil depth because the clay swelled so much that the marking nails disappeared when the trench wall was sprayed with water. For that reason the winter wheat at the clayey site was investigated only up to 0.9 m. Nevertheless, this qualitative method provides a unique set of relative comparisons that cannot be obtained using other methodologies.

## **Conclusions**

Winter cereals had higher RLD than sugar beet. The root distribution of winter cereals was correlated with root distribution of sugar beet mostly at the sandy site. The deepest roots were recorded for sugar beet (BBCH 59) with roots down to a depth of 165 cm at the clayey site.

## **References**

- Anderson, E.L. (1988). Tillage and N fertilization effects on maize root growth and root:shoot ratio. *Plant and Soil*, Vol. 108, pp. 245–251.
- Basilio de Azevedo, M.C., Chopart, J.L. & Medina, C.d.C. (2011). Sugarcane root length density and distribution from root intersection counting on a trench-profile. *Scientific Agriculture*, Vol. 68, pp. 94–101.
- Böhm, W. (1979). *Methods of studying root systems*. Springer-Verlag, Berlin.
- Hamblin, A.P. & Tennant, D. (1987). Root length density and water uptake in cereals and grain legumes: How well are they correlated? *Australian Journal of Agricultural Research*, Vol. 38, pp. 513–527.
- Jenkinson, D.S. & Coleman, K. (2008). The turnover of organic carbon in subsoils. Part 2. Modelling carbon turnover. *European Journal of Soil Science*, Vol. 59, pp. 400–413.
- Kristensen, H.L. & Thorup-Kristensen, K. (2004). Root growth and nitrate uptake of three different catch crops in deep soil layers. *Soil Science Society of America Journal*, Vol. 68, pp. 529–537.
- Kücke, M., Schmid, H. & Spiess, A. (1995). A comparison of four methods for measuring roots of field crops in three contrasting soils. *Plant and Soil*, Vol. 172, pp. 63–71.
- Lamb, J.F.S., Johnson, L.D., Barnes, D.K. & Marquez-Ortiz, J.J. 2000. A method to characterize root morphology traits in alfalfa. *Canadian Journal of Plant Science*, Vol. 80, pp. 97–104.
- Mengel, K., Kirkby, E.A., Kosegarten, H. & Appel, T. (2001). *Principles of plant nutrition*. Kluwer Academic Publishers, Dordrecht.
- Neves, C.S.V.J., Feller, C., Guimarães, M.F., Medina, C.C., Filho, J.T., Fortier, M. (2003). Soil bulk density and porosity of homogeneous morphological units identified by the Cropping Profile Method in clayey Oxisols in Brazil. *Soil and Tillage Research*, Vol. 71, pp. 109–119.
- Thorup-Kristensen, K., Cortasa, M.S. & Loges, R. (2009). Winter wheat roots grow twice as deep as spring wheat roots, is this important for N uptake and N leaching losses? *Plant and Soil*, Vol. 322, pp. 101–114.
- Vepraskas, M.J. & Hoyt, G.D. (1988). Comparison of the trench-profile and core methods for evaluating root distributions in tillage studies. *Agronomy Journal*, Vol. 80, pp. 166–172.

## STUDY OF THE PERFORMANCE OF BREAD WHEAT CULTIVARS CARRYING THE 1BL.1RS WHEAT-RYE CHROMOSOMAL TRANSLOCATION WITH PHYSIOLOGICAL CRITERIA

Chryssanthi I. PANKOU<sup>1</sup>, Fokion PAPATHANASIOU<sup>2</sup>, Theano B. LAZARIDOU<sup>2</sup>, Ioannis N. XYNIAS<sup>2\*</sup>

<sup>1</sup>Laboratory of Genetics and Plant Breeding, School of Agriculture, Aristotle University of Thessaloniki, 54124 Thessaloniki, Greece

<sup>2</sup>School of Agricultural Technol. & Food Technol. and Nutrition, Western Macedonia University of Applied Sciences Terma Kontopoulou, 53 100 Florina, Greece

\*Corresponding author: ixynias@teiwm.gr; ioannis\_xynias@hotmail.com

### Abstract

The 1BL.1RS wheat-rye chromosome translocation offers to the host cultivar, among others, high yield potential and drought resistance. In order to study how the above traits are affected by this translocation, three Hellenic spring wheat varieties with translocation (cvs. Acheron, Elissavet and Orfeas) and six without the translocation (cvs. Apollonia, Acheloos, Vergina, Doirani, Nestos and Strymonas) were used. The Russian cultivar Kavkaz/Cgn was used as control. The complete randomized block design was applied with four replications and the experiment was established in the main farm of the Western Macedonia University of Applied Sciences in Florina. The following physiological traits were measured: total chlorophyll content, chlorophyll fluorescence, CO<sub>2</sub> assimilation rate, stomatal conductance, intercellular CO<sub>2</sub> concentration and transpiration rate. No significant differences were recorded except for total chlorophyll content. Cultivar Achellos, which does not carry the translocation and is characterized by high yield potential, differed significantly from all the other cultivars in total chlorophyll content. Regarding the other traits, cultivar Doirani performed better in stomatal conductance, cultivar Nestos in intercellular CO<sub>2</sub> concentration and cultivar Acheloos in transpiration rate, but the differences were not significant. In order to find out the effect of the physiological traits on yield potential the above results were compared to the yield performance of the corresponding cultivars. This comparison led to the conclusion that the 1BL.1RS chromosome translocation does not give an advantage regarding the physiological traits studied. Further research is required to confirm the results of the present study.

**Keywords:** *yield potential, drought resistance, chlorophyll, assimilation rate.*

### Introduction

One of the main problems in releasing new cultivars is that this new germplasm has to be grown on marginal environments due to the irrational waste of territorial resources noticed in previous years. Furthermore, the drought in spring is the crucial obstacle of agricultural production in the southern regions of Europe (Yau and Saxena, 1997) complicating the problem. Thus, one of the most decisive factors in all breeding programs is the identification and integration of genes into cultivated varieties that confer resistance or tolerance to drought (Blum, 1988). This led breeders and especially those working on wheat, to look for new gene pools to face the problem (Fehr, 1987). According to various reports bread wheat (*Triticum aestivum* L em Thell) cultivars carrying the 1BL.1RS wheat-rye chromosome translocation are characterized among other traits by high yield potential (Kim *et al.*, 2004; Xynias *et al.*, 2007) and resistance to drought (Hoffmann, 2008). The 1BL.RS translocation is originated

from cv. Kavkaz/Cgn, and according to Weng *et al.* (2007) possesses resistance genes to different biotic and abiotic stress conditions. The unique traits of the translocation are attributed to genes located on the short arm of the first chromosome of rye (Schlegel and Meinel, 1994; Xynias *et al.*, 2007). Common physiological traits used to recognize increased stress tolerance are gas exchange parameters such as assimilation rate (A), stomatal conductance ( $g_s$ ), transpiration rate (E) and intercellular CO<sub>2</sub> concentration ( $c_i$ ), chlorophyll content and chlorophyll fluorescence (Hura *et al.*, 2007; Živčák *et al.*, 2008). Physiological traits have showed a good correlation with tolerance to stresses and yield parameters with a high heritability and repeatability (Fotovát *et al.*, 2007; Sayar *et al.*, 2008).

The aim of the present study was to investigate the effect of the 1BL.1RS wheat-rye chromosomal translocation on six physiological traits and elucidate how they affect yield and drought resistance.

## Materials and Methods

### *a. Plant material*

For the purpose of the study, nine Hellenic bread wheat cultivars (eg. Acheron, Elissavet, Orfeas, Apolonia, Acheloos, Vergina, Doirani, Nestos and Strymonas) that were developed at the Cereal Institute of Thessaloniki (Anonymous 1985) and the Russian cultivar Kavkaz/Cgn, one of the donors of the 1BL.1RS wheat-rye chromosome translocation (Xynias *et al.*, 2006; Weng, 2007) were used. Three of the Hellenic cultivars were found to carry the 1BL.1RS wheat-rye chromosome translocation (cvs. Acheron, Elissavet and Orfeas) whereas the other six cultivars, were lacking the specific translocation (Xynias *et al.*, 2006; Peros *et al.*, 2015).

### *b. Method*

The examined cultivars and the control were sown in early November 2015 in a field at the University of Applied Sciences of W. Macedonia Farm in Florina Greece (40°46' N, 21°22' E, 707 m asl), in a sandy loam soil with pH 6.3, organic matter content 14.0 g kg<sup>-1</sup>, N-NO<sub>3</sub> 100 mg kg<sup>-1</sup>, P (Olsen) 50.3 mg kg<sup>-1</sup> and K 308 mg kg<sup>-1</sup> and water holding capacity 21.8% (0 to 30 cm depth). Seedbed preparation included mouldboard plough, disc harrow and cultivator. Nitrogen and P<sub>2</sub>O<sub>5</sub> at 80 and 40 kg ha<sup>-1</sup>, respectively, were incorporated into the soil as diammonium phosphate (20-10-0) before sowing. The crop was kept free of weeds by hand hoeing when necessary. The Randomized Complete Blocks (RCB) experimental design was applied, with four replications (Steel and Torrie, 1960). The plots were consisted of five rows (plot area 3m<sup>2</sup>) of which the three inner were threshed (harvest area 1.8m<sup>2</sup>).

The mechanically harvested grain was weighed and a sample of grain was dried in an oven at 105° C for 24 h to determine grain moisture content. Grain yield was referred to 12% grain moisture. Chlorophyll content readings were taken with a hand-held dual-wavelength meter (SPAD 502, Chlorophyll meter, Minolta Camera Co., Ltd., Japan). For each plot six fully expanded flag leaves per plot were used when the plants were at physiological maturity with six measurements per leaf, a total of 36 readings per plot. A portable photosynthesis system (LI-6400 XT, Li-Cor, Lincoln, Nebraska, USA) equipped with a 2X6 (12 cm<sup>2</sup>) open top narrow leaf chamber was used for determinations of CO<sub>2</sub> assimilation rate (A), transpiration rate (E), stomatal conductance to water vapour ( $g_s$ ), and intercellular CO<sub>2</sub> concentration ( $C_i$ ) during grain filling period. Leaf gas exchange was measured on the fully expanded flag leaf during the grain-filling period on six plants from each plot from 09:00-12:00 in the morning to avoid high vapor-pressure deficit and photoinhibition at midday. The quantum photosynthetic yield of photosystem (PS) II or Y was measured with the portable OS5p Chlorophyll Fluorometer (Opti-Sciences Inc. Hudson, NH, USA).

The means were compared according to the L.S.D. method. The data obtained were analyzed statistically with Mstat-C (Freed and Eisensmith, 1986).

### Results and Discussion

Significant differences were recorded between the examined cultivars in yield (significant differences at  $p = 1\%$ , Table 1). Regarding the physiological traits studied, only in total chlorophyll content the differences were significant. In all other physiological traits no differences were observed between the examined cultivars regardless of the presence of the translocation (Table 1).

Table 1. Analysis of variance of bread wheat with and without the 1BL.1RS wheat-rye chromosomal translocation regarding yield and six physiological traits.

Source	df	Yield	Total chlorophyll content	Chlorophyll fluorescence (Y)	CO <sub>2</sub> assimilation rate (A)	Stomatal conductance (g <sub>s</sub> )	Intercellular CO <sub>2</sub> concentration (Ci)	Transpiration rate (E)
		MS	MS	MS	MS	MS	MS	MS
Factor	3	**	**	ns	ns	ns	ns	ns
Replications	9	**	*	ns	**	ns	**	**
Error	27							
CV		16.3	7.37	17.55	12.08	49.42	7.77	15.25

Source: Author s' elaboration based on the obtained results.

Table 2. Ranking of the bread wheat cultivars according to yield and total chlorophyll content.

Cultivar	Yield	Total chlorophyll content
Acheron	880.4 a	41.10 c
Apolonia	868.1 a	44.13 c
Doirani	688.7 b	49.22 ab
Elissavet	657.1 bc	45.30 bc
Vergina	652.2 bc	45.60 bc
Acheloos	580.7 bc	51.53 a
Strymonas	546.8 c	41.67 c
Kavkaz/Cgn	344.7 d	41.28 c
Nestos	277.8 d	44.97 bc
Orfeas	209.6 d	41.64 c
LSD	135.2	4.77

Source: Author s' elaboration based on the obtained results.

Yield ranged from 880.4 g per harvest plot in cultivar Acheron to 209.6 g per harvest plot area in cultivar Orfeas (Table 2). Both of these last cultivars carry the 1BL.1RS wheat rye chromosome translocation. The insufficient yield performance of cvs. Orfeas Nestos and Kavkaz/Cgn can be attributed to the inappropriate soil characteristics of the field where those cultivars were grown (relatively high water holding capacity in conjunction with very low temperatures). Cultivar Apolonia, which does not carry the translocation, was ranked second performing equally well with cultivar Acheron. The above results suggest that there must be no any effect of the wheat rye chromosome translocation. Sufficient yield can be produced by elite cultivars despite the effect of the translocation. This questionable effect of the translocation was also reported in other studies. Lazaridou *et al.* (2017) suggested that any positive effect of the translocation on the host cultivar is determined by the genetic background of the host cultivar itself.

Except for the total chlorophyll content, no differences were recorded in all other traits. Cultivar Acheloos, which does not carry the translocation, was ranked first in total chlorophyll content. This was expected since this cultivar has large leaves and is considerably robust. As for the other traits, cv. Doirani performed better in stomatal conductance, cv. Nestos in intercellular CO<sub>2</sub> concentration, and cv. Acheloos in transpiration rate, but the differences were not significant.

### **Conclusions**

A first estimate of these results leads to the conclusion that the 1BL.1RS wheat rye chromosomal translocation does not give any advantage over the physiological traits studied. The correlation of the aforementioned traits with yield, further complicate the conclusion, probably suggesting that any positive effect of the translocation could be influenced by the genetic background of the host cultivar. However, further research is required to verify this last statement.

### **References**

- Anonymous. (1985). Cereal Varieties. Hellenic Ministry of Agriculture, Thessaloniki (in Hellenic).
- Blum A. (1988). Plant breeding for stress environments. CRC Press, Inc. Boca Raton, Florida, pp. 223.
- Fehr W. R. (1987). Principles of cultivar development. Vol.1. Theory and techniques. Macmillan Publishing Company, N. York, pp 536.
- Fotovat R., Valizadeh M., Toorchi M. (2007). Association between water-use efficiency components and total chlorophyll content (SPAD) in wheat (*Triticum aestivum* L.) under well-watered and drought stress conditions. *Journal of Food Agriculture and Environment*, vol. 5, pp. 225-227.
- Freed R. D., Eisnsmith S. P. (1986). Mstat C. Michigan State University, Lansing, Michigan, USA.
- Hoffmann B. (2008). Alteration of Drought Tolerance of Winter Wheat Caused by Translocation of Rye Chromosome Segment 1RS. *Cereal Research Communications*, vol 36, pp. 269–278.
- Hura T., Grzesiak S., Hura K., Thiemt E., Tokarz K., Wędzony M. (2007). Physiological and biochemical tools useful in drought-tolerance detection in genotypes of winter triticale: Accumulation of ferulic acid correlates with drought tolerance. *Annals of Botany*, vol. 100, pp. 767-775.
- Kim W., Johnson J. W., Baenziger P. S., Lukaszewski A. J., Gaines C. S. (2004). Agronomic effect of wheat-rye translocation carrying rye chromatin (1R) from different sources. *Crop Sci.*, vol. 44, pp. 1254-1258.
- Lazaridou T. B., Pankou C. I., Xynias, I. N., Roupakias D. G. (2017). Effect of the 1BL.1RS Wheat- Rye Translocation on the Androgenic Response in Spring Bread Wheat. *Cytology and Genetics*, vol. 6, (accepted for publication).
- Peros H., Dalezios G., Liakakos E., Delis C., Lazaridou T. B., Xynias I. N. (2015). Molecular detection of the 1BL.1RS translocation in Hellenic bread wheat cultivars. *Cereal Res. Commun.*, vol. 43, pp. 318-325.
- Sayar R., Khemira H., Kameli A., Mosbahi M. (2008). Physiological tests as predictive appreciation for drought tolerance in durum wheat (*Triticum durum* Desf.). *Agronomy Research*, vol. 6, pp. 79-90.

- Schlegel R., Meinel A. (1994). A quantitative trait locus (QTL) on chromosome arm 1RS of rye and its effects on yield performance of hexaploid wheat. *Cereal Research Communications*, vol. 22, pp. 7-13.
- Weng Y., Azhaguel P., Devkota R. N., Rudd J. C. (2007). PCR-based markers for detection of different sources of 1AL.1RS and 1BL.1RS wheat-rye translocations in wheat background, *Plant Breeding*, vol. 126, no. 5, pp. 482-486.
- Xynias I. N., Kozub N., Sozinov I. (2006). Seed storage protein composition of Greek bread wheat cultivars. *Plant Breeding*, vol. 125, pp. 408-410.
- Xynias I. N., Kozub N., Sozinov I., Sozinov A. (2007). Biochemical Markers in Wheat Breeding. *International Journal of Plant breeding*, vol. 1, pp. 1-9.
- Yau S. K., Saxena M. C. (1997). Drought as a global concern in plant protection. In Jexic, S. & Pekic, S. (eds), "Drought and Plant Protection", Belgrade, Yugoslavia, pp. 15-22.
- Živčák M., Brestič M., Olšovská K. (2008). Application of photosynthetic parameters in the screening of wheat (*Triticum aestivum* L.) genotypes for improved drought and high temperature tolerance. In Allen, J.F., Gantt, E., Golbeck, J.H., Osmond, B. (eds.), "Photosynthesis: Energy from the Sun". 14th International Congress in Photosynthesis, Springer, Berlin – Heidelberg, pp. 1247-1250.

## HOW COULD BE AFFECTED SEED GERMINATION RATES OF WINTER CEREALS

Kyriakos D. GIANNOULIS<sup>1</sup>, Elpiniki SKOUFOGIANNI<sup>1</sup>, Dimitrios BARTZIALIS<sup>1</sup>,  
Konstantina ADRASKELA<sup>1</sup>, Nikolaos G. DANALATOS<sup>1</sup>

University of Thessaly, Department of Agriculture, Crop Production & Rural Environment, Volos, Greece

\*Corresponding author: kyriakos.giannoulis@gmail.com

### Abstract

Seed germination is the most critical stage in life cycle of cereal plants while temperature is the main factor affecting plant growth and development. In this study, was investigated the effect of different temperatures and the use of two new ingredients for seed dipping of winter cereals (*Triticum durum*, *Triricum aestivum*, *Avena sativa*, *Hordeum vulgare*, and *Secale cereale*). Seed germination rate was measured at different temperatures in the range 2-22°C in a growth chamber with constant parameters (light, water). In each species there were three treatments (blanc, ingredient A, ingredient B) which were repeated four times for each temperature value, where 200 seeds were placed in different separate containers. The measurements were taken at a-day intervals for the increased temperatures and at a three-day interval for the low temperatures. A seed was deemed to have germinated when at least 1 mm of radicle was visible. Temperature seems to be the most limited factor on germination process while the increase of 5 degrees is enough to give better germination results and in association with the dipped seeds with the tested ingredients shown that winter cereals had different germination rates which may help farmers to have a substantial germination risk. It was found that ingredients A and B did not play a significant role in germination except the case of *Triticum durum* where helped it to present better germination rate than the blanc treatment. The temperature of 12-22°C represents the optimum seed germination in a period of 8-10 days for *Triricum aestivum*, *Avena sativa*, *Hordeum vulgare*, and *Secale cereale* regardless of the different treatments.

**Keywords:** *germination rate, winter cereals, temperature, ingredients.*

### Introduction

Cereals are grasses widely cultivated for its seed. A cereal grain is a worldwide staple food (Shewry, 2009; Mauser, 2014). The more widely grown winter cereal is wheat and it is grown on more land area than any other food crop (FAOSTAT, 2014), and the world trade in wheat is greater than for all other crops combined (Curtis et al., 2002).

One of the most crucial factors that affect plant growth and specifically the rate of plant growth and development is the temperature. The most critical stages in the plant life cycle is seed germination and seedling establishment (Walck et al., 2011; Baskin and Baskin, 2014).

There is a defined range of maximum and minimum temperatures form the boundaries of observable growth for each species. Furthermore, Hatfield et al. (2008, 2011, 2015) found an index of cardinal temperature values for different annual crops of different species.

Successful crop establishment, which is crucial for reliable plant production, depends on seed quality, environmental factors and genotypes. A review of the literature confirmed that the differences in the responses of cereal seeds and seedlings to different temperatures were associated with their geographic origin.



Since germination speed is very important for about earliness in the plant growing it can differ according to species, soil structures, sowing methods and especially temperature and soil moisture ratios. Knowledge of seed germination response to environmental factors is required not only for understanding and predicting the ecological adaptation of the species but also for formulating effective strategies for restoration.

The effect of temperature can be modeled by thermal time and predict seed germination progress well but also to provide “a measure of physiological time” and yield coefficients (Bradford 2002).

The purpose of this study was to quantify the germination temperatures of five winter cereals (*Triticum durum*, *Triticumaestivum*, *Hordeum vulgare*, *Avena sativa*, *Secalecereale*) in a range of temperatures and the use of two ingredients as vegetation accelerators.

### Material & Methods

This research was carried out in the laboratory of Agronomy and Applied Crop physiology in the University of Thessaly. The study was performed in a growth chamber adjusted to 5 different temperatures (22, 17, 12, 7, 5°C) for five winter cereals (*Triticum durum*, *Triricum aestivum*, *Avena sativa*, *Hordeum vulgare*, and *Secale cereale*). In each species there were three treatments (blank, Vitanica RZ, Nutriseed) which were repeated four times for each temperature value, where 200 seeds were placed in different separate containers. The used ingredients are commercial preparations containing phytocones, amino acids, vitamins, algal extract of *Ecklonia maxima* and of course nitrogen, potassium, while the pH is about 3.5. The measurements were taken at a-day intervals for the increased temperatures and at a three-day interval for the low temperatures. A seed was deemed to have germinated when at least 1 mm of radicle was visible. The number of germinants was measured at frequent and regular intervals by the rate of germination. The maximum germination percentage for each temperature treatment was calculated as the average of the four replicates. The rate of germination was taken as the reciprocal of the time at which 50% of this maximum germinant number was reached.

### Results and Discussion

As shown in Figure 1, the germination of five winter cereals (*Triticum durum*, *Triticumaestivum*, *Hordeum vulgare*, *Avena sativa*, *Secalecereale*) at 22°C varied at different levels. The wheat presented top germination as from the 2<sup>nd</sup> day showed rapid germination of seeds (about 90% for Vitanica RZ and, 95% for Nutriseed vs 20% for Blanc), and on day 8 reached the final percentage. All the other winter cereal seeds hierarchical followed: *Secale cereale* > *Hordeum vulgare* > *Triticum durum* > *Avena sativa* for the two vegetation accelerators. For the blank treatment followed: *Secale cereale*, *Triticum aestivum* > *Hordeum vulgare* > *Avena sativa* > *Triticum durum*.

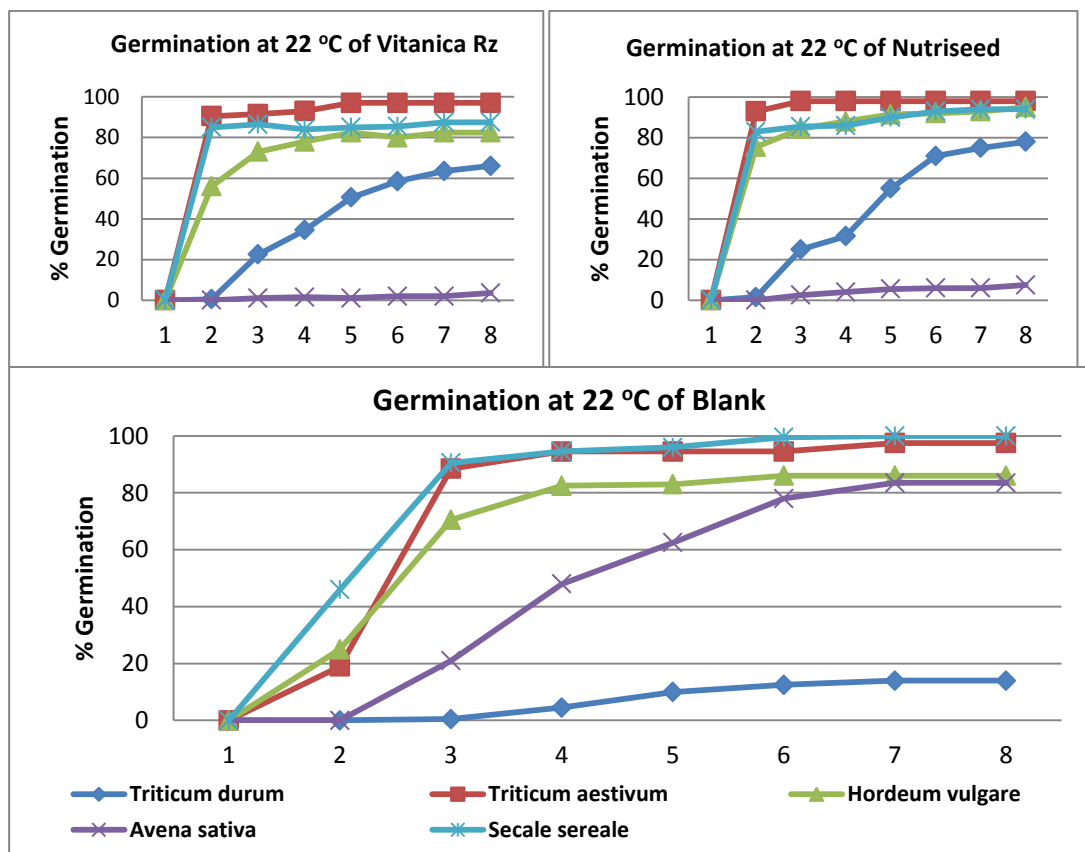
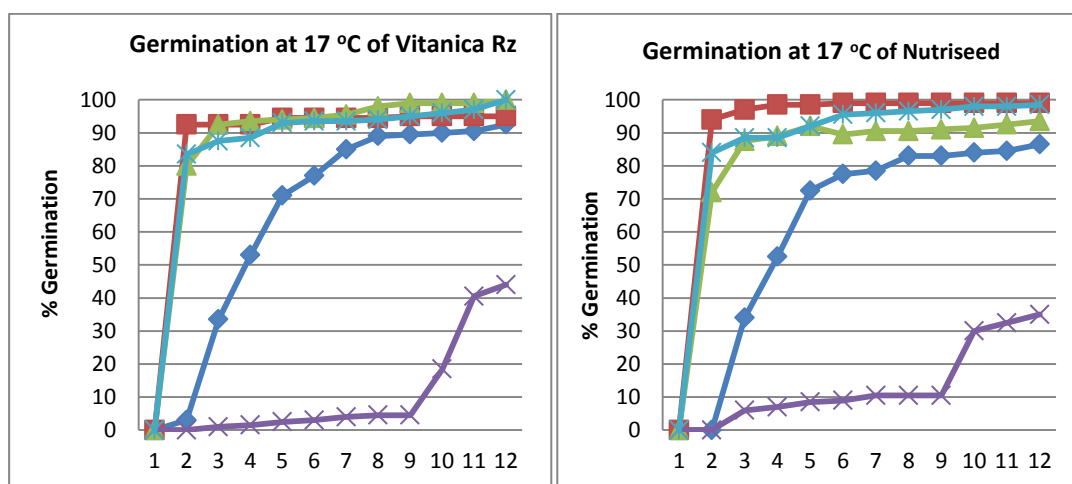


Figure 1. Seed germination percentage of five winter cereals (*Triticum durum*, *Triricum aestivum*, *Avena sativa*, *Hordeum vulgare*, and *Secale cereale*) at 22°C under three different treatments.

Decreasing the temperature by 5 degrees of Celcium (up to 17°C), the germination of the below five winter cereals (Figure 2) varied at different levels. *Secale cereale* presented top germination as from the 2<sup>nd</sup> day increased the germination percentage up to 82-90%, for all treatments while *Avena sativa* showed better germination as far as the blanc treatment is concerned (on the 12<sup>th</sup> day reached the final percentage 90%).



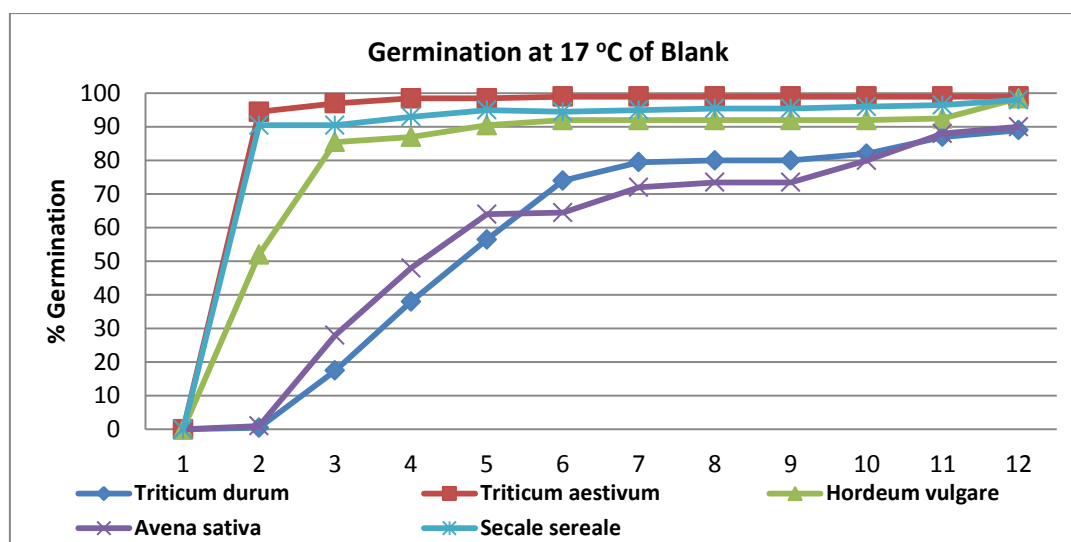
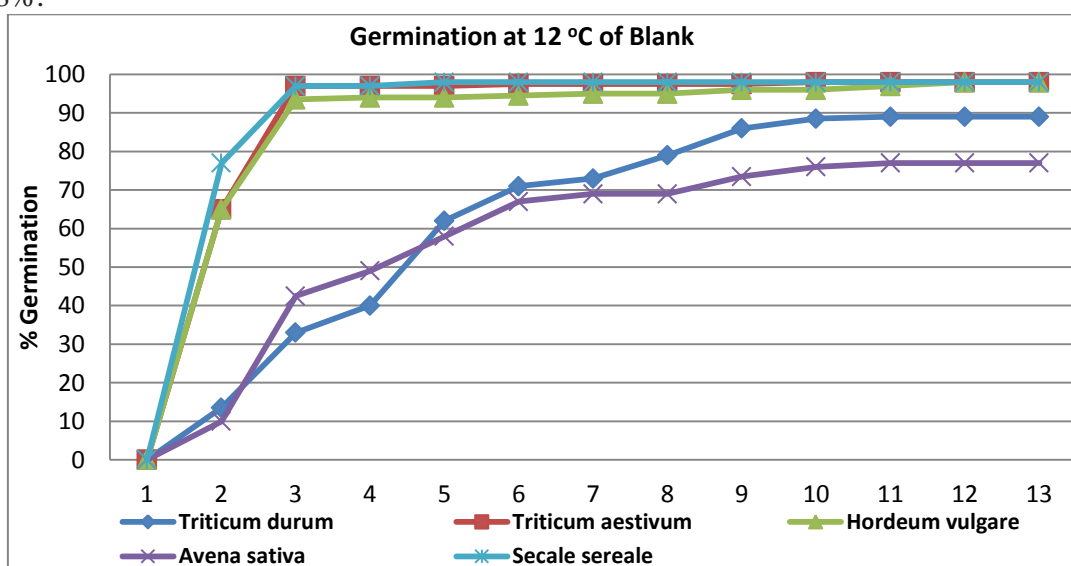


Figure 2. Seed germination percentage of five winter cereals (*Triticum durum*, *Triticumaestivum*, *Avena sativa*, *Hordeum vulgare*, and *Secalecereale*) at 17°C under three different treatments.

As shown in Figure 3, the placement of seeds at a temperature of 12 °C showed similar results for all the treatments. The only difference is the *Avena sativa* which doubled the germination rate at the blanc treatment vs germination accelerators treatments. Vitanica Rz excelled against Nutriseed in the case of *Avena sativa* and *Triticum durum* up to 10<sup>th</sup> day. *Triticum durum* germination at the 9<sup>th</sup> day was about 90 % while in case of Nutriseed reached the top of 98%.



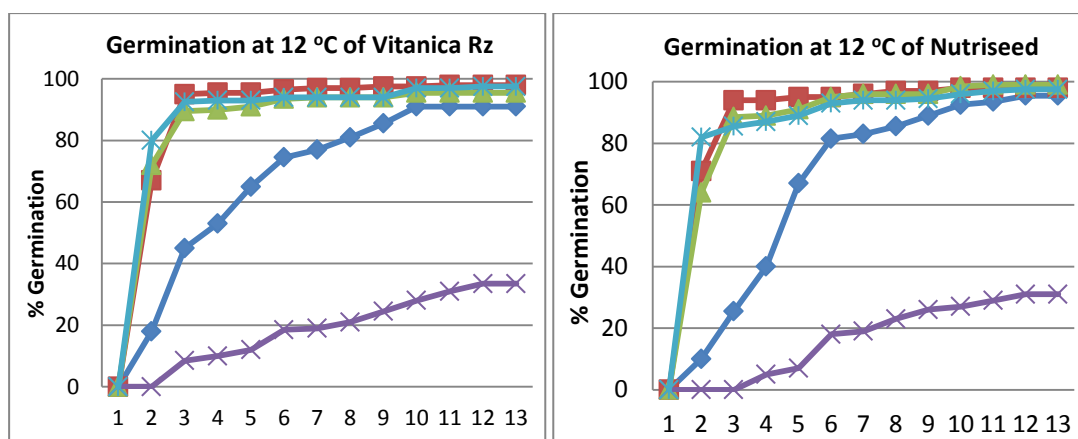


Figure 3. Seed germination percentage of five winter cereals (*Triticum durum*, *Triticum aestivum*, *Avena sativa*, *Hordeum vulgare*, and *Secale cereale*) at 12°C under three different treatments.

Furthermore, decreasing the temperature more, 7°C as shown in Figure 4 the germination rate slowed down for all the species and all the treatments. Specifically, all winter cereal seeds reached the maximum germination (60-100% of germination) on the 10<sup>th</sup> day. In this case, the hierarchy that was noticed is: *Secale cereale*, *Triticum aestivum* > *Hordeum vulgare* > *Triticum durum* > *Avena sativa*. *Avena sativa* showed better performance in the Nutriseed treatment.

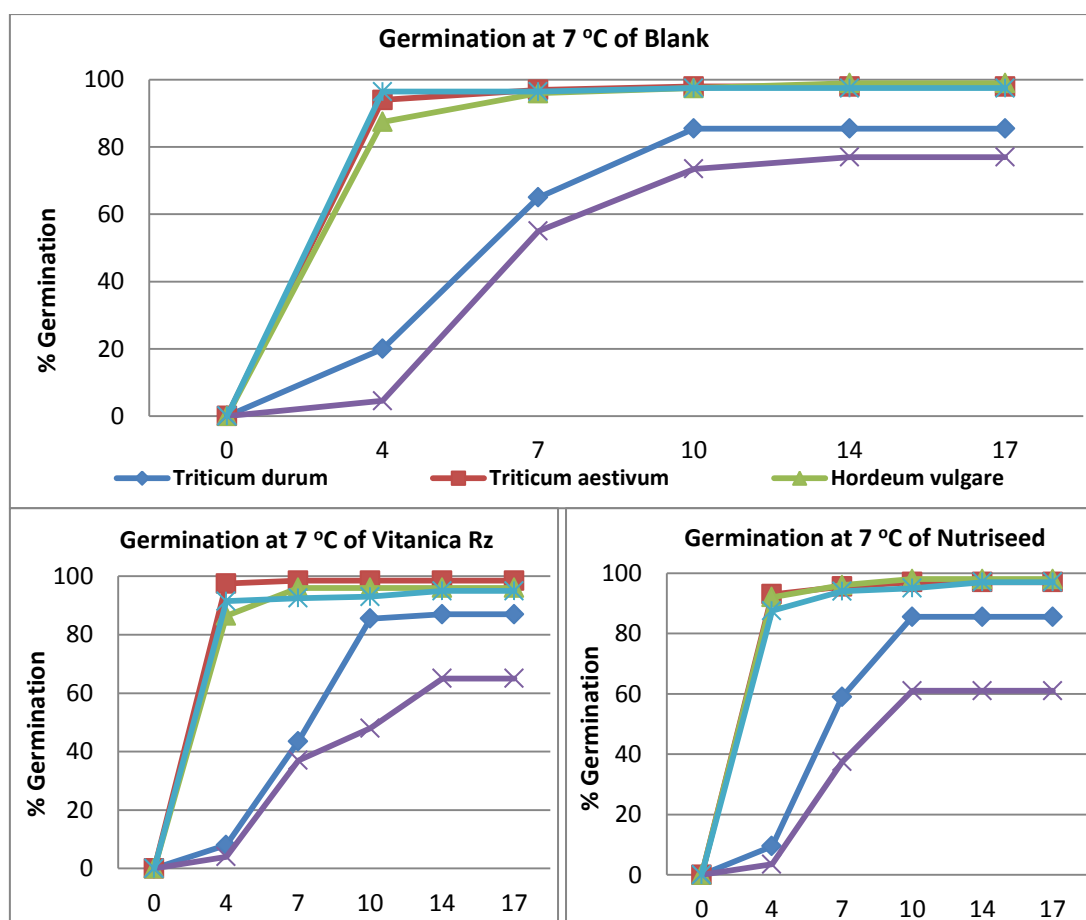


Figure 4. Seed germination percentage of five winter cereals (*Triticum durum*, *Triticum aestivum*, *Avena sativa*, *Hordeum vulgare*, and *Secale cereale*) at 7°C under three different treatments.

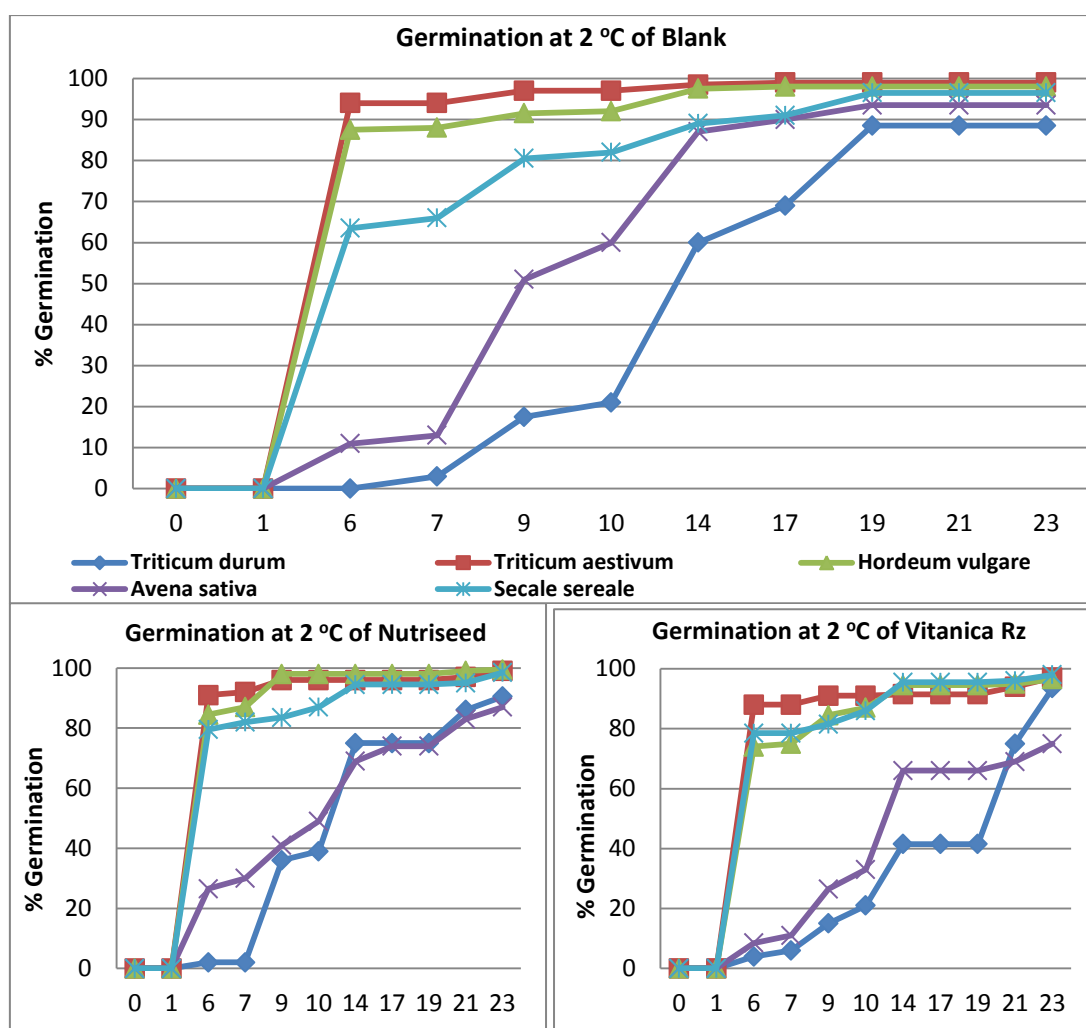


Figure 5. Seed germination percentage of five winter cereals (*Triticum durum*, *Triricum aestivum*, *Avena sativa*, *Hordeum vulgare*, and *Secale cereale*) at 2°C under three different treatments.

Finally, decreasing the temperature 5 °C further (2 °C) the germination time increased to 23 days. In this temperature, Nutrised treatment showed better presentation than the two other treatments. *Triricum aestivum*, *Hordeum vulgare*, *Secale cereale* reached the 100% of germination (9 to 14 day) while *Avena sativa* and *Triticum durum* reached the 90% (23 day). In each temperature was noticed that *Triricum aestivum* reached the maximum germination while *Avena sativa* the minimum. Moreover, only in the case of 17°C *Avena sativa* was able to reach the final germination percentage of 95%.

### Conclusions

*Triricum aestivum* is the most vigorous seed at tested temperatures (2, 7 12, 17, 22°C) of the five winter cereals. On the other hand, *Avena sativa* was found to have less seed germination percentage, and only at temperature of 17°C reached 90% germination (blank treatment). In the case of *Avena sativa* an important postpone germination appeared in the vegetative accelerator treatments in relation to the blank treatment, at the temperatures 7 up to 22 °C. Additionally, in the case of 2, 7, 12, 17, 22°C the germination period was 14, 14, 10, 10, 8 days for all the winter cereals, respectively. According to the above results, it is concluded that the temperatures of 12-22°C represent the optimum seed germination, in a period of 8-10

days for *Triticum aestivum*, *Avena sativa*, *Hordeum vulgare*, and *Secale cereal*, regardless of the different treatments.

As a general conclusion, Vitanica RZ and Nutriseed may satisfactory helped *Triticum durum* to present better germination rate at 22°C.

In the case of the other seeds, vegetative accelerators did not show significant superiority.

Finally, all the five winter cereals could be proposed as cultivation in Greece.

### References

- Bradford K.J. (2002). Application of hydrothermal time to quantifying and modelling seed germination and dormancy. *Weed Sci.* 50, pp248-260.
- Curtis B.C, Rajaraman S., MacPherson H.G., (2002). "Bread Wheat". Food and Agriculture Organization of the United Nations.
- FAOSTAT (2014). Crops/World Total/Wheat/Area Harvested/2014 (pick list). United Nations, Food and Agriculture Organization, Statistics Division. Archived from the original on 6 September 2015. Retrieved 8 December 2016.
- Hatfield J.L., Boote K.J., Fay P., Hahn L., Izaurralde R.C., Kimball B.A., Mader T., Morgan J., Ort D., Polley W., Thomson A., Wolfe D. (2008). Agriculture. In: *The Effects of Climate Change on Agriculture, Land Resources, Water Resources, and Biodiversity in the United States. A Report by the U.S. Climate Change Science Program and the Subcommittee on Global Change Research.* Washington, DC., USA, p. 362.
- Hatfield J.L., Boote K.J., Kimball B.A., Ziska L.H., Izaurralde R.C. (2011). Climate Impacts on Agriculture: Implications for Crop Production. *Agron. J.*, 103, pp. 351–370.
- Hatfield L.J., Prueger H. J. (2015). Effect on plant growth and development. In: *Temperature and Climate Extremes.* Volume 10 (A) pp 4-10.
- Mauseth J.D., (2014). Botany. Jones & Bartlett Publishers. p.223. ISBN978-1-4496-4884-8.
- Shewry P.R., (2009). *Wheat Journal of Experimental Botany*,60(6): 1537–1553.

## THE EFFECT OF DIFERENT FERTILIZATION SCENARIOS ON PRODUCTIVITY OF WHEAT AND BARLEY

Dimitrios BARTZIALIS<sup>1</sup>, Kyriakos D. GIANNOULIS<sup>1</sup>, Elpiniki SKOUFOGIANNI<sup>1</sup>, Sophia DAMPLIA<sup>1</sup>, Konstantinos TSAKIRIDIS<sup>1</sup>, Efstathios PAVLAKOS<sup>2</sup>, Nicholaos G. DANALATOS<sup>1</sup>

<sup>1</sup>University of Thessaly, Dept. of Agriculture, Crop Production & Rural Environment, Volos, Greece

<sup>2</sup>Compo Expert Hellas S.A., Marousi, Athens

\*Corresponding author: kyriakos.giannoulis@gmail.com

### Abstract

Wheat and barley are the most common cereals which are the most widely grown of all crops, and they consists those cereals with the highest economical interest. Plant breeders produced many varieties to increase the grain yield, to reduce the plant's sensitivity and the final quality. Moreover, many chemical substances are sold stating that they can increase the final yield and the seed quality and more specifically the protein content. For the purposes of this study the effect of different fertilization scenarios was investigated on the growth and final yield of wheat and barley, grown on a fertile clay loamy soil at Velestino (Thessaly plain; central Greece) in 2016-17. It was demonstrated that both crops at the *treatment 1* (with microgranular easy start 11-48-0, 20 kg ha<sup>-1</sup>) obtained quicker germination and reached numerically superiority on biomass during the early growing stages. This quicker germination of the above cereals may be helpful for farmers who live in rather cool micro-environments, and their sowing in the fall may be postponed for some weeks without substantial germination risk. In both cases *Triticum durum* and *Hordeum vulgare* there were found significant differences for the harvested grain yield for the fertilized practices with the *treatment 1* produced higher yields.

**Keywords:** *Wheat, barley, yield, biomass, Greece.*

### Introduction

Levelling-off or reduced rates of improvement in cereal crop yields are common features of agriculture worldwide (Bell et al., 1995; Calderini and Slafer, 1998; Slafer and Peltonen-Sainio, 2001).

There are two major contributors to changes in yield trends: genetic improvements and changes to crop management practices. Developments in both depend on growing conditions. Challenges arising from the environment are emphasized at the edge of the agricultural production area.

The Mediterranean agricultural region comprises the lands surrounding the Mediterranean Sea: the southern strip of Europe, northern lands of Africa and west Asia. This region is characterized by relatively cold and wet winters, dry and hot spring-summer (Aschmann, 1973) while the soils have typically low fertility (Ryan et al., 2009). Rainfall seasonality restricts agriculture to winter-spring crops and the amount and variation of rainfall drives relatively low and highly variable yield.

Drought and heat stress, particularly during flowering and grain filling, are the main climatic characteristics of the Mediterranean region (Loss and Siddique, 1994; Acevedo et al., 1999). The term "terminal stress" has been used to characterize these environments, hence the emphasis on agronomic practices and crop traits to balance water use, before and after

anthesis to reduce the likelihood of extreme water deficit during grain filling (Fischer, 1979; Mitchell et al., 1996; van Herwaarden et al., 1998b; Leport et al., 1999; Sadras, 2002; Palta et al., 2004).

From a physiological point of view, the strong correlation between cereal yield and grain number and the modest contribution of grain size to yield variation in European Mediterranean environments, highlights the importance of growing conditions between stem elongation and few days after flowering, when grain number is determined. Management and environmental conditions that favor growth during this period have a direct impact on grain number and yield.

Fertilization and liming are critical management practices for wheat production. A properly managed fertility program, including recommended fertilization and liming practices, can improve yield and quality more than any other single management practice. Such a program includes soil testing, knowledge of crop nutrient requirements and removal, timely application of nutrients, and record-keeping.

Nitrogen rates and timing of application are key management factors for making good wheat yields. Nitrogen is also the most expensive fertilizer nutrient and variable input cost for wheat. Therefore, nitrogen rates should be based on soil potential, cultivar, realistic yield goal, previous crop and residual N.

Seasonal rainfall is therefore the main source of water as well as a key driver of yield (Keatinge et al., 1986; Garabet et al., 1998). Water stress has thus been considered the dominant yield-limiting factor in these environments (Loss and Siddique 1994; Bennet et al., 1998; Acevedo et al., 1999). Water availability, however, only accounts for part of the variation in yield in these environments, typically about one-third (French and Schultz, 1984a,b; Sadras and Angus, 2006).

This study was conducted in the main agricultural plain (Thessaly) to evaluate the effect of different fertilization practices in the performance of the main winter cereal crops (*Triticum durum* and *Hordeum vulgare*) cultivated in Greece.

### Materials and methods

For the purposes of the study, field experiments were established in East Thessaly (Velesino, Volos). The selected crops were *Triticum durum* and *Hordeum vulgare*, in order to assess the effect of different fertilization scenarios in their performance, which are the most prevalent winter cereals in Greece.

**Soil characteristics.** Velesino soil is characterized as Calcixerollic Xerochrept according to USDA classification (1975). It is a clay loam (sand 19-21%; clay 39-41%, silt 38-42%) calcareous (pH = 8.1-8.3) rich in organic matter (2.3-2.7% in soil profile of 40cm).

**Field management and experimental design.** The selected varieties were “Meridiano” in case of *Triticum durum* and “Grace” in case of *Hordeum vulgare*. Sowing was occurred using a modern seeding machine applying 200 kg ha<sup>-1</sup> seeds at the first ten days period of November 2016. There was performed pre- and post-emergence herbicide application, to control weeds. Basic fertilization applied one-two days before sowing using a dispenser and then the fertilizer was incorporates using a rotary cultivator.

**Triticum durum.** The experimental design of *Triticum durum* was a completely randomized design with four fertilization treatments and four replications (blocks). Specifically, Treatment 1: basic fertilization (200 kg ha<sup>-1</sup> of Novatec 22-8-10, with nitrification inhibitor and 20 kg ha<sup>-1</sup> of microgranular easy start B.S. 11-48-0), nitrogen fertilization (200 kg ha<sup>-1</sup> of Novatec 40-0-0, with nitrification inhibitor), foliar fertilization (Basfoliar 36-0-0: 3 l ha<sup>-1</sup> and Basfoliar Triple Flo: 0.75 l ha<sup>-1</sup> with micronutrients Zn, Cu, Mn).



Treatment 2: seed coat with Nutriseed (0.3 l ha<sup>-1</sup>) basic fertilization (200 kg ha<sup>-1</sup> of Novatec 22-8-10 with nitrification inhibitor), nitrogen fertilization (200 kg ha<sup>-1</sup> of Novatec 40-0-0 with nitrification inhibitor), and foliar fertilization (Basfoliar 36-0-0: 3 l ha<sup>-1</sup> and Basfoliar Triple Flo: 1.5 l ha<sup>-1</sup> with micronutrients Zn, Cu, Mn).

Treatment 3: Common cultivation practice used in Greece with basic fertilization (250 kg ha<sup>-1</sup> of 20-10-10), and surface fertilization (300 kg ha<sup>-1</sup> of 34.5-0-0).

Treatment 4: Zero fertilization (Control).

**Hordeum vulgare.** The experimental design of *Hordeum vulgare* was a completely randomized design with four fertilization treatments and four replications (blocks). Specifically,

Treatment 1: basic fertilization (150 kg ha<sup>-1</sup> of Novatec 22-8-10 with nitrification inhibitor and 20 kg ha<sup>-1</sup> of microgranular easy start B.S. 11-48-0), nitrogen fertilization (150 kg ha<sup>-1</sup> of Novatec 40-0-0), foliar fertilization (Basfoliar 36-0-0: 5 l ha<sup>-1</sup> and Basfoliar Triple Flo: 0.75 l ha<sup>-1</sup>).

Treatment 2: seed coat with Vitanica RZ (0.24 l ha<sup>-1</sup>) basic fertilization (150 kg ha<sup>-1</sup> of Novatec 22-8-10 with nitrification inhibitor), nitrogen fertilization (150 kg ha<sup>-1</sup> of Novatec 40-0-0 with nitrification inhibitor), foliar fertilization (Basfoliar 36-0-0: 3 l ha<sup>-1</sup> and Basfoliar Triple Flo: 0.755 l ha<sup>-1</sup> with micronutrients Zn, Cu, Mn).

Treatment 3: Common cultivation practice used in Greece with basic (200 kg ha<sup>-1</sup> of 20-10-10), and surface fertilization (250 kg ha<sup>-1</sup> of 34.5-0-0).

Treatment 4: Zero fertilization (Control).

**Measurements.** Fresh and dry biomass was monitored by means of samplings (3 samplings per experiment through crop life cycle till the final harvest; analytically according to Zadocks scale: 1st sampling at tillering 21-29, 2nd sampling at anthesis-flowering 61-69 and 3rd sampling at ripening stage 91-99). To avoid any border effect, 1 m<sup>2</sup> in the inner plot was harvested in each sampling above the ground. The samples were weighed fresh and then a sub-sample was taken for further laboratory measurements. The plants of each sub-sample were oven-dried at 65 °C until constant weight (3-4 days) and weighed again to determine the final dry weights.

The statistical package GenStat (7th Edition) was used for the analysis of variance (ANOVA) within sample timings for all measured and derived data. The LSD<sub>0.05</sub> was used as the test criterion for assessing differences between means (Steel and Torrie, 1982).

**Meteorological data.** Meteorological data were recorded in Velestino from the established meteorological station of University of Thessaly.

## Results and Discussion

**Meteorological data.** In Figure 1 is illustrated the average temperature and precipitation during crop growth. Decreased air temperatures for the season were prevailed during sowing but also through the whole crop life cycle. Precipitation was almost the same but the real problem occurred in few days. Almost zero precipitation and low air temperature in early November resulted a postponed germination but hopefully without problems in terms of the final population plants and the successful establishment of crops. Both in late April and early May unsatisfactory rainfall occurred, so it was expected a decreased final yield which did not allow better exploitation of fertilization.

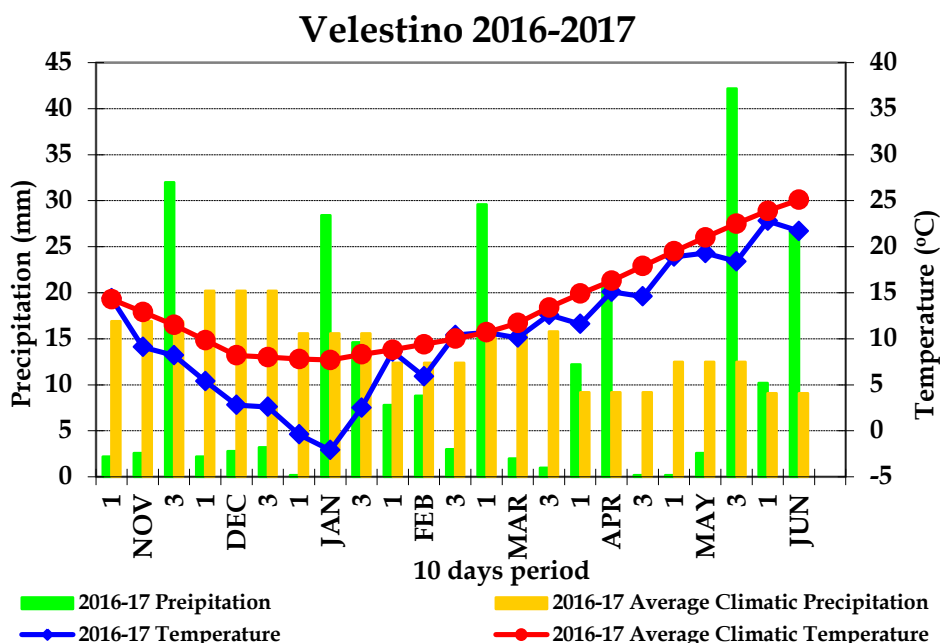


Figure 1. Average air temperature and precipitation (●, ■) for ten days period at Velestino in 2016-2017, and the average climatic conditions of the region during the last 50 years (●, ■).

### Yield and growth characteristics

***Triticum durum*.** The results have shown none statistical significant differences between the tested fertilization practices except of grain yield (Table 1) which is the product of economic value.

There were not noticed statistically significant differences for the fresh and the dry weight of durum wheat during the first samplings on 17-3-2017 (Zadocks scale: tillering 21-29) and 7-5-2017 (Zadocks scale: anthesis-flowering 61-69), but in all cases demonstrated numerically superiority of the 1<sup>st</sup> and 2<sup>nd</sup> fertilization scenarios.

Only during the final growing stage was clearly shown on field that plants of the fertilized treatments had bigger grains (data not shown). This observation was confirmed at the final harvest (Table 1) were the fertilized treatments had statistically significant differences in comparison with the control treatment while the treatment 1 produced higher yields.

**Table 1.** Fresh, dry biomass and grain yield of *Triticum durum* under fertilization practices and fertilizer combinations.

Characteristic		Factor				
		Fresh Biomass 17-3-2017 (kg ha <sup>-1</sup> )	Dry Biomass 17-3-2017 (kg ha <sup>-1</sup> )	Fresh Biomass 7-5-2017 (kg ha <sup>-1</sup> )	Dry Biomass 7-5-2017 (kg ha <sup>-1</sup> )	Grain Yield (kg ha <sup>-1</sup> )
Fertilization practice	Treatment-1	6407	1064	31630	15682	4120 b
	Treatment-2	6467	1024	33940	15937	4161 b
	Treatment-3	5848	954	29600	14550	3840 ab
	Treatment-4	5482	914	28250	12547	3576 a
<b>LSD<sub>0.05</sub></b>		ns	ns	ns	ns	422,9
<b>CV (%)</b>		18.4	15.4	13.6	16.2	9.6

ns: non-significant

**Hordeum vulgare.** The same results were also noticed in case of barley. Specifically, it was observed that there were not statistical significant differences between the tested fertilization practices except the grain yield at the final harvest (Table 2).

There were not noticed statistically significant differences for the fresh and the dry weight of barley during the first samplings on 17-3-2017 and 7-5-2017. Also in all cases demonstrated numerically superiority of the 1<sup>st</sup> and 2<sup>nd</sup> fertilization scenarios.

During the final growing stage (Zadocks scale: ripening stage 91-99) was clearly shown on field that plants of the fertilized treatments had bigger grains (data not shown). This observation was confirmed at the final harvest (Table 2) were the fertilized treatments had statistically significant differences in comparison with the control treatment while the treatment 1 produced higher yields.

**Table 2.** Fresh, dry biomass and grain yield of *Hordeum vulgare* under fertilization practices and fertilizer combinations.

Characteristic		Factor				
		Fresh Biomass 17-3-2017 (kg ha <sup>-1</sup> )	Dry Biomass 17-3-2017 (kg ha <sup>-1</sup> )	Fresh Biomass 7-5-2017 (kg ha <sup>-1</sup> )	Dry Biomass 7-5-2017 (kg ha <sup>-1</sup> )	Grain Yield (kg ha <sup>-1</sup> )
Treatment-1		12811	1444	42300	13796	5261 b
Treatment-2		11015	1249	40980	13489	5018 b
Treatment-3		10316	1204	40100	13177	4836 ab
Treatment-4		10125	1084	34140	12380	4339 a
<b>LSD<sub>0.05</sub></b>		ns	ns	ns	ns	530.2
<b>CV (%)</b>		38.8	26.6	14.2	10.9	10.7

ns: non-significant

## Conclusions

In both crops, *Triticum durum* and *Hordeum vulgare*, there were found significant differences for the harvested grain yield for the fertilized practices with the *treatment-1* be the quantifiable one. Due to the fact that the above results were found through the first year of experimentation, safer conclusions expected to arise after the repetition of the experiments in the same place for a second and a third year. In case that the results of the third year will confirm the previous results then fertilization practice of the *treatment-1* should be proposed in future fertilization schemes.

## Acknowledgments

This research was funded by COMPO EXPERT Hellas S.A., Athens, Greece and carried out by the Laboratory of Agronomy and Applied Plant Physiology, Department of Agriculture Crop Production & Rural Environment, University of Thessaly.

## References

- Acevedo H.E., Silva P.C., Silva H.R., Solar B.R., (1999). Wheat production under Mediterranean environments. In: Satorre, E.H., Slafer, G.A. (Eds.), *Wheat: ecology and physiology of yield determination*. Haworth Press, Inc, New York, p. 503.
- Aschmann H., (1973). Distribution and peculiarity of Mediterranean ecosystems. In: di Castri, F., Mooney, H.A. (Eds.), *Mediterranean type ecosystems*. Springer-Verlag, Heildeberg, pp. 11–19.
- Bell M.A., Fischer R.A., Byerlee D., Sayre K., (1995). Genetic and agronomic contributions to yield gains: a case study for wheat. *Field Crops Research* 44, 55–65.
- Bennet S.J., Saidi N., Enneking D., (1998). Modelling climatic similarities in Mediterranean areas: a potential tool for plant genetic resources and breeding programmes. *Agric. Ecosyst. Environ.* 70, 129–143.
- Calderini D.F., Slafer G.A., (1998). Changes in yield and yield stability in wheat during the 20th century. *Field Crops Research* 57, 335–347.
- Fischer R.A., (1979). Growth and water limitation of dryland wheat yield in Australia: a physiological framework. *J. Aust. Inst. Agric. Sci.* 45, 83–94.
- French R.J., Schultz J.E., (1984a). Water use efficiency of wheat in a Mediterranean-type environment. I. The relation between yield, water use and climate. *Aust. J. Agric. Res.* 35, 743–764.
- French R.J., Schultz J.E., (1984b). Water use efficiency of wheat in a Mediterranean-type environment. II. Some limitations to efficiency. *Aust. J. Agric. Res.* 35, 765–775.
- Keatinge J.D.H., Dennett M.D., Rodgers J., (1986). The influence of precipitation regime on the crop management of dry areas in northern Syria. *Field Crops Res.* 13, 239–249.
- Leport L., Turner N.C., French R.J., (1999). Physiological responses of chickpea genotypes to terminal drought in a Mediterranean-type environment. *Eur. J. Agron.* 11, 279–291.
- Loss S.P., Siddique K.H.M., (1994). Morphological and physiological traits associated with wheat yield increases in Mediterranean environments. *Adv. Agron.* 52, 229–275.
- Mitchell J.H., Fukai S., Cooper M., (1996). Influence of phenology on grain yield variation among barley cultivars grown under terminal drought. *Aust. J. Agric. Res.* 47, 757–774.
- Palta J.A., Turner N.C., French R.J., (2004). The yield performance of lupin genotypes under terminal drought in a Mediterranean-type environment. *Aust. J. Agric. Res.* 55, 449–459.

- Ryan J., Ibrikci H., Sommer R., McNeill A., (2009). Nitrogen in rainfed and irrigated cropping systems in the Mediterranean region. *Adv. Agron.* 104, 53–136.
- Sadras V.O., (2002). Interaction between rainfall and nitrogen fertilization of wheat in environments prone to terminal drought: economic and environmental risk analysis. *Field Crops Res.* 77, 201–215.
- Sadras V.O., Angus J.F., (2006). Benchmarking water-use efficiency of rainfed wheat in dry environments. *Aust. J. Agric. Res.* 57, 847–856.
- Slafer G.A., Peltonen-Sainio P., (2001). Yield trends of temperate cereals in high latitude countries from 1940 to 1998. *Agricultural and Food Science in Finland* 10, 121–131.
- Steel R.G.D., Torrie J.H., (1982). *Principles and Procedures of Statistics. A Biometrical Approach*, 2nd ed. McGraw-Hill, Inc, p. 633.

## THE EFFECT OF NUTRIENT SOLUTION COMPOSITION ON DEVELOPMENT OF *Cichorium spinosum* PLANTS

Panagiota KOLOVOU<sup>1</sup>, Vasilios ANTONIADIS<sup>2</sup>, Anestis KARKANIS<sup>3</sup>, Isabel C.F.R. FERREIRA<sup>4</sup>, Spyridon PETROPOULOS<sup>1\*</sup>

<sup>1</sup>Laboratory of Vegetable Production, University of Thessaly, Fytokou Street, 38446, N.Ionia, Magnissia, Greece

<sup>2</sup>Laboratory of Soil Science, University of Thessaly, Fytokou Street, 38446, N.Ionia, Magnissia, Greece

<sup>3</sup>Laboratory of Weed Science, University of Thessaly, Fytokou Street, 38446, N.Ionia, Magnissia, Greece

<sup>4</sup>Mountain Research Centre (CIMO), ESA, Polytechnic Institute of Bragança, Campus de Santa Apolónia, 1172, 5300-253 Bragança, Portugal

\*Corresponding author: spetropoulos@uth.gr

### Abstract

In the present study, the effect of nutrient solution composition on plant growth and quality of *Cichorium spinosum* L. was examined. Five fertilizer treatments were applied through irrigation water differing in the nitrate: ammonium nitrogen ratio of total nitrogen, namely (1) 100:0, (2) 75:25, (3) 50:50, (4) 25:75, 5) 0:100 NO<sub>3</sub>:NH<sub>4</sub>, while an extra treatment (6) with total nitrogen only in urea form was applied. All the treatments received the same amount of fertilizer units (20-20-20 mg L<sup>-1</sup> of N, P and K, respectively). Plants were grown in 2 L pots containing peat (Klassman-Deilmann KTS2) and harvested three times during the growing period, and when they reached marketable size. At each harvest day, plant development was assessed (number, fresh and dry weight of leaves, and rosette diameter). The results suggest that nitrogen form has a significant effect on plant growth and yield of *C. spinosum* plants. In particular, fresh weight and number of leaves, and rosette diameter were significantly increased when ratio of nitrate: ammonium nitrogen was 75:25 or 0:100, especially in the 1<sup>st</sup> harvest, while in the 3<sup>rd</sup> harvest treatment 100:0 showed the best results. However, this did not affect total fresh weight and number of leaves which were higher for treatments 100:0 and 75:25, respectively. Therefore, higher ammonium nitrogen rates seem to be beneficial for plant development only during the early stages, while at later growth stages nitrate nitrogen has better results. In any case, ureic nitrogen is not suggested since it has severe effects on plant development, probably due to toxicity issues.

**Keywords:** Ammonium nitrogen, *Cichorium spinosum* L., nitrate nitrogen, stamnagathi, urea

### Introduction

*Cichorium spinosum* L. is a wild edible chicory, which is self-grown in Crete and other regions of island and mainland of Greece. Rich in vitamins, minerals, fatty acids and antioxidants, with a distinct bitter flavor, it is also very popular abroad. Given the fact that it grows nearby coastal areas which suffer from high salinity, it is a well-adapted species under adverse conditions with considerably low cultivation needs (Chatzoulakis and Klapaki, 2006). As a fresh product, it has important nutritional value and achieves very high prices in the retail market. Therefore, it would be beneficial to study its cultivation for commercial purposes (Meliou et al., 2003; Zeghichi et al., 2003; Simopoulos, 2004).

Modern agricultural practices have rendered the application of fertilizers necessary for higher yields and better quality of final products. Nitrogen has a fundamental role in biosynthesis of acids, proteins, enzymes and chlorophyll of plants, rendering it an essential macronutrient (Barker et al., 1974). However, despite the positive effect of nitrogen fertilizers on yield and

quality, they can be toxic if supplied in irrational rates, especially in leafy vegetables which tend to accumulate nitrates with severe effects on human health (Hord et al., 2009). Moreover, apart from the overall nitrogen application rate, nitrogen form may affect the quality of the final product, especially phytonutrients content such as organic and fatty acids (Fontana et al., 2006; Szalai et al., 2010).

Although during the last few years farmers in many Mediterranean countries have started to commercially cultivate the species, scarce literature is available the nutrient requirements and the effect of fertilizers rates on yield. Therefore, the aim of the present study was to evaluate the effect of various ammonium and nitrate nitrogen rates on growth and development of *Cichorium spinosum* plants.

### Materials and Methods

Plants were grown from seeds as previously described by Anesti et al. (2017). *Cichorium spinosum* L. seedlings were obtained from Vianame S.A. (Crete, Greece) at the stage of 3-4 leaves. Seeds were put in seed trays containing peat on 27/09/2016. Transplantation was carried out on 14/02/2016 and young seedlings were put in 2 L pots containing peat (Klassman-Deilmann KTS2). After transplantation, six fertilizer treatments were applied, namely (1) 100:0, (2) 75:25, (3) 50:50, (4) 25:75, 5) 0:100 NO<sub>3</sub>:NH<sub>4</sub>, while an extra treatment (6) with total nitrogen only in urea form was applied. One seedling was put in each pot, while each treatment consisted of 20 pots. Nutrient solution composition of each treatment is presented in Table 1. The various solutions were prepared by using appropriate amounts of the following fertilizers: a) ammonium nitrate (34.5% total nitrogen, with a ratio of 1:1 for NO<sub>3</sub>-N: NH<sub>4</sub>-N), b) potassium nitrate (13.5% of nitrate nitrogen and 46% of K<sub>2</sub>O), c) magnesium nitrate (11% of nitrate nitrogen and 15% of MgO), d) monopotassium phosphate (52% of P<sub>2</sub>O<sub>5</sub> and 34% of K<sub>2</sub>O), e) ammonium sulphate (21% of ammonium nitrogen and 24% of 24 of SO<sub>3</sub>), f) mono-ammonium phosphate (12% of ammonium nitrogen and 61% of P<sub>2</sub>O<sub>5</sub>), and g) urea (46% of ureic nitrogen).

Table 1. Nutrient solution composition for each treatment (mg L<sup>-1</sup>).

Fertilizer type	Treatments (NO <sub>3</sub> <sup>-</sup> :NH <sub>4</sub> <sup>+</sup> )					
	100:0	75:25	50:50	25:75	0:100	Urea
Total nitrogen	200	200	200	200	200	200
NO <sub>3</sub> <sup>-</sup>	200	150	100	50	0	0
NH <sub>4</sub> <sup>+</sup>	0	50	100	150	200	0
Urea	0	0	0	0	0	200
K	200	200	200	200	200	200
P	200	200	200	200	200	200
Ca	0	0	0	0	0	0
Mg	178.3	136.3	0	0	0	0
S	0	0	0	136.4	252.8	24.0

Harvests was carried out on 22/03, 06/04 and 25/04/2016 for the 1<sup>st</sup>, 2<sup>nd</sup> and 3<sup>rd</sup> harvest, respectively. On each day of harvest, rosette diameter, number of leaves, fresh and dry weight were measured. For dry weight evaluation, samples of fresh leaves were oven dried at 72 °C to a constant weight (approximately for 48 hours). Water content was estimated as % percentage by subtracting dry weight from the initial fresh weight.

Experimental design was laid out according to Completely Randomised Design (n=20). Statistical analysis was conducted with the aid of JMP v 4.0.2 (SAS Institute Inc.) and Statgraphics 5.1.plus (Statistical Graphics Corporation). Data were evaluated by analysis of

variance (ANOVA), whereas the means of values were compared by Tukey's HSD Test with  $\alpha = 0.05$ .

### Results and Discussion

According to the results of Table 2, the ammonium fertilizer affects the growth and the quality of *Cichorium spinosum*. More specific, in the 1<sup>st</sup> harvest fresh weight was higher in treatment 0:100, followed by treatment 75:25, whereas the treatment with ureic nitrogen had negative effect on yield. In contrast, Szalai et al. (2010) have reported a negative effect of high ammonium nitrate concentration in nutrient solution on fresh weight of purslane plants, which could be due to the shorter growth cycle of purslane comparing to *C. spinosum* plants that does not allow nitrification of ammonium nitrate to take place. Moreover, according to Marschner (1995) and Britto and Kronzucker (2002), the negative effects of ammonium nitrogen have been associated with changes of pH of growth medium and the toxicity of free  $\text{NH}_4^+$ . Considering that in our study no negative effects of ammonium nitrogen were observed in the early growth stages (1<sup>st</sup> harvest), it could indicate a cumulative effect of  $\text{NH}_4^+$  on growth media which is being established only at late growth stages and after the application of significant amounts of nutrient solution. In a previous study of Anesti et al. (2016), it has been suggested that high ammonium nitrogen rates (up to approximately 50% of total nitrogen) have a beneficial effect only when multiple harvest are applied which could also indicate the negative effect of accumulation of  $\text{NH}_4^+$  in tissues of plants where no successive harvests are applied.

In the following harvests and especially for the 3<sup>rd</sup> harvest and for total fresh weight (Tables 3 to 5), the highest content of nitrates (100:0) in nutrient solution resulted in higher fresh weight. Ge (2002) and Wang et al. (2005) have also reported that high nitrate: ammonium nitrogen ratios resulted in higher plant yield of spinach, while Ulrich et al. (2017) have also suggested the beneficial effect of nitrates on fresh weight of lettuce plants. In the study of Ulrić et al (2017), it is also reported that high nitrate nitrogen rates increased leaf length and number of leaves, which also observed in the present study. This could be attributed to the fact that nitrogen in nitrate form is more easily available to plants than ammonium nitrogen and urea, as well as to the cumulative toxicity effects of ammonium nitrogen. This is more apparent after the first and second harvest where the temperature increase induces biosynthesis, therefore resulting in a significantly higher total fresh weight. Similar trends with fresh weight were observed for the number of leaves and rosette diameter in the 1<sup>st</sup> and 3<sup>rd</sup> harvest, with nutrient solution containing 100% of nitrate nitrogen having the better results, except for total number of leaves which was higher for treatment 75:25 (Table 2 and 4). However, this did not affect total fresh weight yield which was higher for treatment 100:0, as already mentioned. Dry weight did not show specific trends between the various treatments and harvests (Tables 2 to 5). In contrast, Wang et al. (2009) have reported an increase of dry weight in spinach leaves when ammonium nitrogen content increased.

In addition, the treatment where nitrogen applied in the form of ureic nitrogen had detrimental effects on plant development, probably due to toxicity effects which affected negatively all the measured parameters, except for dry weight of leaves.



Table 2. The effect of nitrate: ammonium nitrogen rates on development of *Cichorium spinosum* plants in the first harvest.

Treatment (NO <sub>3</sub> <sup>-</sup> :NH <sub>4</sub> <sup>+</sup> )	Fresh weight (g)	Rosette diameter (cm)	Number of leaves	Dry weight
100:0	13.9±2.6 bc	25.9±6.6 ab	12.9±3.4 c	9.1±1.3 ab
75:25	15.7±4.3 ab	29.1±8.7 a	17.4±6.1 a	8.8±1.0 b
50:50	13.2±1.7 cd	22.9±5.8 bc	14.5±4.6 abc	9.8±0.9 ab
25:75	13.5±1.6 c	24.1±3.8 bc	13.9±2.6 bc	10.6±0.2 a
0:100	16.7±3.2 a	26.0±5.5 ab	16.7±5.3 ab	9.4±0.8 ab
Urea	11.3±1.4 d	21.2±4.6 c	9.1±3.0 d	10.1±1.1 ab

\*Means in columns followed by different letters without parenthesis, and means in columns followed by different letters in parenthesis are significantly different at p<0.05 by Tukey's HSD test.

Table 3. The effect of nitrate: ammonium nitrogen rates on development of *Cichorium spinosum* plants in the second harvest.

Treatment (NO <sub>3</sub> <sup>-</sup> :NH <sub>4</sub> <sup>+</sup> )	Fresh weight (g)	Rosette diameter (cm)	Number of leaves	Dry weight
100:0	12.9±2.2 a	25.3±3.7 a	7.7±4.3 c	6.7±0.9 b
75:25	12.1±3.1 a	22.8±5.4 b	7.7±2.4 c	6.4±0.7 b
50:50	10.7±0.9 b	20.6±3.7 b	8.1±3.0 bc	4.9±1.7 b
25:75	12.5±2.5 a	21.7±5.5 b	8.7±3.0 b	6.7±1.0 c
0:100	11.9±1.0 a	21.3±2.7 b	9.5±5.0 a	9.5±1.1 a
Urea	10.6±0.8 b	18.7±3.3 c	9.3±3.3 a	7.1±0.5 b

\*Means in columns followed by different letters without parenthesis, and means in columns followed by different letters in parenthesis are significantly different at p<0.05 by Tukey's HSD test.

Table 4. The effect of nitrate: ammonium nitrogen rates on development of *Cichorium spinosum* plants in the third harvest.

Treatment (NO <sub>3</sub> <sup>-</sup> :NH <sub>4</sub> <sup>+</sup> )	Fresh weight (g)	Rosette diameter (cm)	Number of leaves	Dry weight
100:0	19.0±4.5 a	27.3±7.2 a	19.9±6.8 a	8.6±0.9 c
75:25	14.4±2.9 b	19.9±4.4 b	17.9±6.8 b	11.7±0.8 b
50:50	12.8±1.3 c	19.6±3.4 b	15.4±4.5 c	11.5±1.3 b
25:75	15.1±4.0 b	26.9±8.7 a	12±6.0 e	14.1±0.3 a
0:100	13.2±2.1 c	19.1±4.9 b	13.9±5.7 d	11.3±0.2 b
Urea	11.8±1.2 d	19.9±4.1 b	11.5±4.3 e	10.8±0.4 b

\* Means in columns followed by different letters without parenthesis, and means in columns followed by different letters in parenthesis are significantly different at p<0.05 by Tukey's HSD test.

Table 5. The effect of nitrate: ammonium nitrogen rates on total fresh weight and number of leaves of *Cichorium spinosum*.

Treatment (NO <sub>3</sub> <sup>-</sup> :NH <sub>4</sub> <sup>+</sup> )	Total fresh weight (g)	Total number of leaves
100:0	45.8 a	40.5 b
75:25	42.2 b	43.0 a
50:50	36.7 c	38.0
25:75	41.1 b	34.6 c
0:100	41.8 b	40.1 b
Urea	33.7 d	29.9 d

\* Means in columns followed by different letters without parenthesis, and means in columns followed by different letters in parenthesis are significantly different at  $p < 0.05$  by Tukey's HSD test.

### Conclusions

The application of high nitrate rates (75:25 and 100:0 NO<sub>3</sub><sup>-</sup>:NH<sub>4</sub><sup>+</sup>) to *Cichorium spinosum* plants resulted in a significant increase of total fresh weight, mostly through the formation of more leaves. In addition, ammonium nitrogen (0:100) was beneficial only at the first harvest when plant requirements for nitrogen are lower comparing to the later stages when higher temperatures increase biosynthetic rates and therefore nitrogen uptake. Finally, ureic nitrogen had negative effect on fresh weight and total number of leaves, probably due to toxicity effects, therefore it cannot be proposed as a sole nitrogen source in nutrient solutions.

### References

- Anesti S., Fasoli K., Petropoulos S., Ntatsi G., Antoniadis V., Ferreira I.C.F.R. (2016). Effect of ammonium fertilizer on growth and quality of *Cichorium spinosum* plants. In VII international scientific agriculture symposium “Agrosym 2016” (pp. 827–833).
- Barker, A.V., Maynard D.N., Mills H.A. (1974). Variations in nitrate accumulation among spinach cultivars. *Journal of the American Society for Horticultural Science*, 99: 132-134.
- Britto, D.T, Kronzucker, H.J. (2002). NH<sub>4</sub><sup>+</sup> toxicity in higher plants: a critical review. *Journal of Plant Physiology*, 159: 567-584.
- Chartzoulakis, K., Klapaki, G. (2000). Response of two greenhouse pepper hybrids to NaCl salinity during different growth stages. *Scientia Horticulturae*, 86: 247-260.
- Fontana, E., Hoeberechts, J., Nicola, S., Cros, V., Palmegiano, G.B., Peiretti, P.G. (2006). Nitrogen concentration and nitrate ammonium ratio affect yield and change the oxalic acid concentration and fatty acid profile of purslane (*Portulaca oleracea* L.) grown in a soilless culture system. *Journal of the Science of Food and Agriculture*, 86: 2417-2424.
- Ge, X.G. (2002). *Vegetable garden soil and fertilization* Agriculture Press of China, Beijing. p. 212.
- Hord, N.G., Tang, Y., Bryan, N.S. (2009). Food sources of nitrates and nitrites: the physiologic context for potential health benefits. *American Journal of Clinical Nutrition*, 90: 1-10.
- Marschner H (1995). *Mineral nutrition of higher plants*. Second Edition. Academic Press, New York. pp. 247-252
- Meliou, E., Magiatis, P., Skaltsounis, A.L. (2003). Alkylresorcinol derivatives and sesquiterpene lactones from *Cichorium spinosum*. *Journal of Agricultural and Food Chemistry*, 51: 1289-1292

- Simopoulos, A. (2004). Omega-3 fatty acids and antioxidants in edible wild plants. *Biological Research* 37: 263-277.
- Szalai, G., Dai, N., Danin, A., Dudai, N., Barazani, O. (2010). Effect of nitrogen source in the fertilizing solution on nutritional quality of three members of the *Portulaca oleracea* aggregate. *Journal of the Science of Food and Agriculture* 90(12): 2039-2045.
- Urlić, B., Jukić, Š.M., Becker, C., Kläring, H.-P., Krumbein, A., Ban, S.G., Schwarz, D. (2017). Effect of NO<sub>3</sub> and NH<sub>4</sub> concentrations in nutrient solution on yield and nitrate concentration in seasonally grown leaf lettuce. *Acta Agriculturae Scandinavica, Section B — Soil & Plant Science*, doi: doi.org/10.1080/09064710.2017.1347704
- Wang, J., Sun, X.X., Shen, Q., Zhou, Y. (2005). Effects of some replacement of nitrate by ammonium on the biomass yield and quality of spinach. *Soil*, 37(6): 605-608
- Wang, J., Zhou, Y., Dong, C., Shen, Q., Putheti, R. (2009). Effects of NH<sub>4</sub><sup>+</sup>-N/ NO<sub>3</sub><sup>-</sup>-N ratios on growth, nitrate uptake and organic acid levels of spinach (*Spinacia oleracea* L.). *African Journal of Biotechnology*, 8(15): 3597-3602.
- Zeghichi, S., Kallithraka, S., Simopoulos, A.P. (2003). Nutritional composition of molokhia (*Corchorus olitorius*) and stamnagathi (*Cichorium spinosum*). *World Review in Nutrition and Dietetics*, 91: 1-21.

## IN-VITRO SCREENING OF DURUM AND BREAD WHEAT GENOTYPES FOR DROUGHT RESISTANCE USING POLYETHYLENE GLYCOL

Theano B. LAZARIDOU\*, Ioannis N. XYNIAS

School of Agricultural Technology & Food Technology and Nutrition, Western Macedonia University of Applied Sciences Terma Kontopoulou, 53 100 Florina, Greece

\*Corresponding Author: thelaz@florina.teiwm.gr ; thelazaridou@yahoo.gr

### Abstract

Durum and bread wheat are two of the most important crops for global economy. However, their productivity is limited by drought, which is nowadays the main abiotic stressing factor. In order to study the effect of drought stress eight durum wheat (Anna, Sifnos, Mavragani, Elpida, Mexicali, Papadakis, Thraki, and Athos) and seven bread wheat cultivars (Acheron, Orfeas, Apollonia, Acheloos, Doirani, Nestos and Strymonas) were evaluated at three levels of drought treatment in completely randomized design with four replications. Mature embryos of the aforementioned genotypes, were cultured in modified MS solid medium with two different concentrations of polyethylene glycol (5 and 10% PEG 8000), whereas a same medium but without PEG was used as control. The response of the genotypes was measured as embryo germination and callus production. Cultivar Acheron, which carries the 1BL.1RS wheat rye translocation, was the only one not affected by the presence of PEG. The drought treatment reduced the proportion of embryo germination in all other cultivars. This reduction was smaller in bread wheat Acheloos and Apollonia and in durum wheat in cultivars Thraki and Anna, whereas in two durum wheat cultivars (Papadakis and Mexicali) no germination was recorded in the presence of PEG. Regarding the second trait studied, the callus production was not affected by the presence of PEG. Surviving of the germinated plants cultured on the same medium with the presence of PEG decreased with increasing the osmotic stress. It was concluded that there are considerable differences in drought resistance between the genotypes studied.

**Keywords:** *wheat, drought resistance, embryo germination, callus production, translocation*

**Abbreviations:** MS: Murashige & Skoog medium, PEG: Polyethylene glycol

### Introduction

Drought is a worldwide problem and a major proportion of agriculture land is affected with varying degrees of drought. Water deficit combined with extreme temperatures lead to drought which is the main abiotic stressing factor that limits the growth and productivity of the crops in the Mediterranean area. Furthermore durum and bread wheat, two of the most important crops for global economy are affected by drought, as regard to their productivity and quality (Singh and Chaudhary, 2006). In order to meet the needs of modern agriculture and in an attempt to face the prevailing drought conditions in the southern part of Europe, the creation and use of high-yielding varieties that are resistant to biotic and abiotic stresses and adapted to extreme environments is considered necessary (Acevedo and Fereres, 1994). Water stress acts by decreasing the percentage and rate of germination and seedling growth. Germination of seeds in the most critical phases of plant life is greatly influenced by draught and salinity (Misra and Dwivedi, 2004). Thus, the evaluation of the existing genetic material characterized by resistance to draught is the only approach that could decisively contribute to

the problem. Applying osmotic stress during the regeneration phase was found to be the most efficient for drought tolerance (Hsissou and Bouharmont, 1994). Polyethylene glycol (PEG) a draught induced chemical is frequently used to screen out draught tolerant varieties at early stage of seedlings under laboratory conditions. Previous studies revealed that PEG can be used to modify the osmotic potential of nutrient solution culture and thus induce plant water deficit in a relatively controlled manner (Zhu *et al.*, 1997). Polyethylene glycol of high molecular weights have been used to simulate drought stress in plants as non penetrating osmotic agents lowering the water potential in a way similar to soil drying. Application of polyethylene glycol or mannitol as osmotic stressing agent is an efficient and simple enough method to be used for rapid evaluation of drought tolerance in a large number of genotypes (Hassanein, 2010). Soliman and Hendawy (2013) reported that PEG 8000 can be used as water stress creating agent under *in vitro* conditions for durum wheat genotypes.

This study was undertaken to evaluate *in vitro* the drought resistance of sixteen Greek bread and durum wheat cultivars under drought stress conditions using polyethylene glycol 8000.

### Materials and methods

For the purpose of the study seeds of eight durum wheat (Anna, Sifnos, Mavragani, Elpida, Mexicali, Papadakis, Thraki, and Athos) and seven bread wheat cultivars (Acheron, Orfeas, Apollonia, Acheloos, Doirani, Nestos and Strymonas) developed at the Cereal Institute of Thessaloniki (Cereal Institute 1985) were used. The effect of drought stress was measured *in vitro* at different osmotic potential levels. Mature embryos of the aforementioned genotypes, were cultured onto a MS solid medium supplemented with thiamine 0.5mg/l, glutamine 150mg/l, 2.4D 1.5mg/l, NAA 0.5mg/l and two different concentrations of polyethylene glycol (5 and 10% PEG 8000), whereas mature embryos were incubated on the same medium without PEG to serve as control. Before the incubation in the medium the seeds of all cultivars were placed in petri dishes on wet filter paper for five hours. (Kondic and Sesek, 1998). Then the seeds were surface sterilized with 90% ethanol for 1 minute and then with 70% solution of commercial bleach and consequently washed with distilled water for three times. After four weeks the number of germinated embryos was measured, and the proportion of germinated embryos in three different concentrations of PEG was compared. The germinated plants were cultured in the same medium supplemented with 5% and 10% PEG respectively. Survival and the callus production were measured. The response of the genotypes and the resistance to drought was measured as embryo germination and callus production. Statistical analysis was performed using chi-square two-way table format and proportion comparisons were performed by the z means test.

### Results and Discussion

The presence of PEG affected the embryo germination in all bread and durum wheat cultivars studied except the bread wheat cultivar Acheron (tab. 1, fig. 1). The proportion of germination ranged from 2.5 % in cultivar Apollonia to 32.5 in cultivar Anna in the control treatment, whereas it ranged from 0 (cultivars Papadakis and Mexicali) to 20 (cultivar Acheron) and from 0 (cultivars Papadakis and Mexicali) to 23.4 (cultivar Acheron) in 5% and 10% concentration of PEG, respectively. Thus the drought treatment reduced the proportion of embryo germination in all cultivars except the bread wheat cultivar Acheron. This reduction was smaller in bread wheat cultivars Acheloos and Apollonia and in durum wheat in cultivars Thraki and Anna, whereas in three bread wheat cultivars (Doirani, Orfeas and Strymonas) and one durum wheat cultivar Athos no germination was recorded in the higher concentration of PEG (10%) and in two durum wheat cultivars (Papadakis and Mexicali) no germination was recorded in the presence of PEG (5% or 10% concentration) (tab. 1, fig. 1, fig. 2). This

reduction is statistically significant, except in the durum wheat cultivar Thraki. In this cultivar even though the proportion of germination is very low seems to be not affected by the presence of PEG. Additionally the bread wheat cultivar Acheloos and the durum wheat cultivars Anna and Elpida exhibited a quite high proportion of germination in the presence of PEG, so they showed tolerance under the drought stress conditions.

The presence of PEG was lethal to the isolated embryos of durum wheat cultivars Papadakis and Mexicali and the highest concentration of PEG (10%) was lethal to the isolated embryos of cultivars Doirani, Orfeas, Strymonas, and Athos. The surviving ability of the wheat varieties was used earlier as a screening technique in order to characterize them as tolerant to draught or not (Khakwani *et al.*, 2011).

Table 1. The embryo germination (% of incubated seeds) of seven bread wheat and eight durum wheat cultivars in control and with 5% PEG and 10% PEG

Cultivar	Control	5% PEG	10% PEG
Acheron	22.2	20.0	23.4
Apollonia	2.5	1.1	1.5
Doirani	7.5	4.7	0.0
Nestos	15.3	1.7	2.7
Orfeas	1.5	1.9	0.0
Acheloos	17.2	6.0	8.7
Strymonas	3.8	1.2	0.0
Athos	10.4	3.6	0.0
Thraki	2.8	1.4	2.7
Mavragani	20.0	1.3	2.7
Papadakis	15.6	0.0	0.0
Sifnos	28.0	2.0	3.1
Elpida	57.1	6.0	18.2
Mexicali	3.7	0.0	0.0
Anna	32.5	5.0	22.2

The presence of the 1BL.1RS wheat-rye translocation in many modern bread wheat cultivars offers to the cultivars a number of important agronomic traits, i. e. high yield potential (Kim *et al.*, 2004), broad adaptation, resistance to drought and biotic stress conditions and a sustainable wheat production (Lazaridou *et al.*, 2017). The bread wheat cultivar Acheron, which carries this translocation, was the only one not affected by the presence of PEG. (fig. 3a, 3b, fig. 4a, 4b). This may be an evidence that the aforementioned translocation really prevents plants with drought tolerance. Regarding the second trait studied, the callus production was not affected by the presence of PEG. Soliman and Hendawy (2013) studied the response to immature embryo culture, and the *in vitro* drought tolerance of six durum wheat genotypes. Their results showed that increasing PEG concentration in the medium callus growth parameters are gradually decreasing revealing a negative correlation between callus fresh weight and increase of the concentrations of PEG. However, this was in disagreement with the results of the present study.

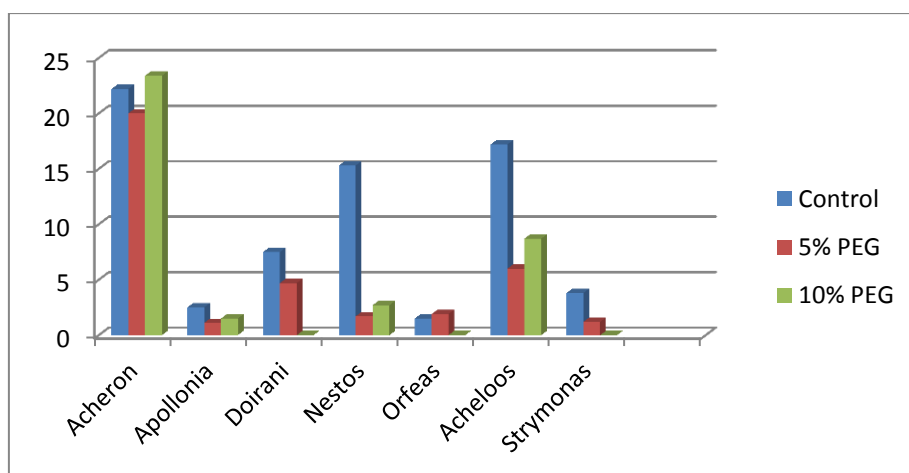


Figure 1. Effect of drought stress on embryo germination of seven bread wheat cultivars

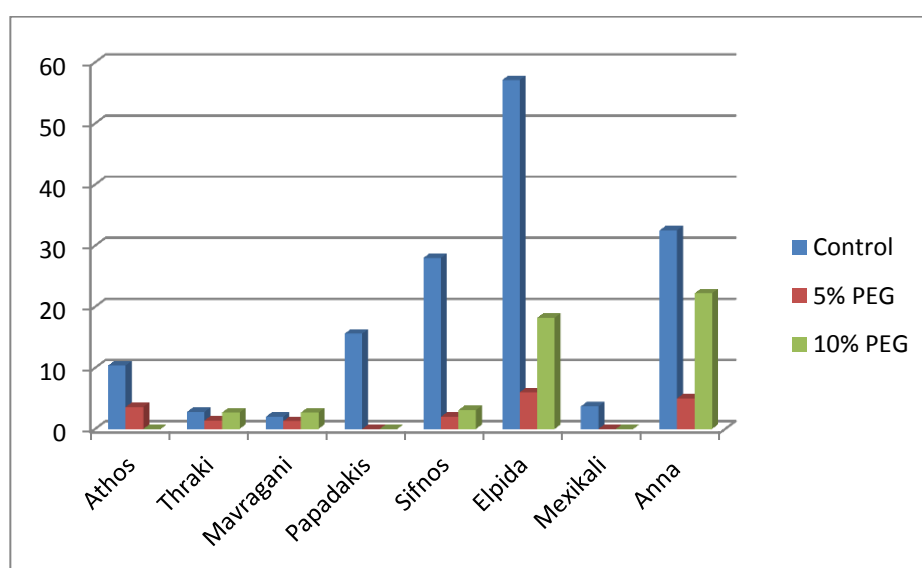


Figure 2. Effect of drought stress on embryo germination of eight durum wheat cultivars

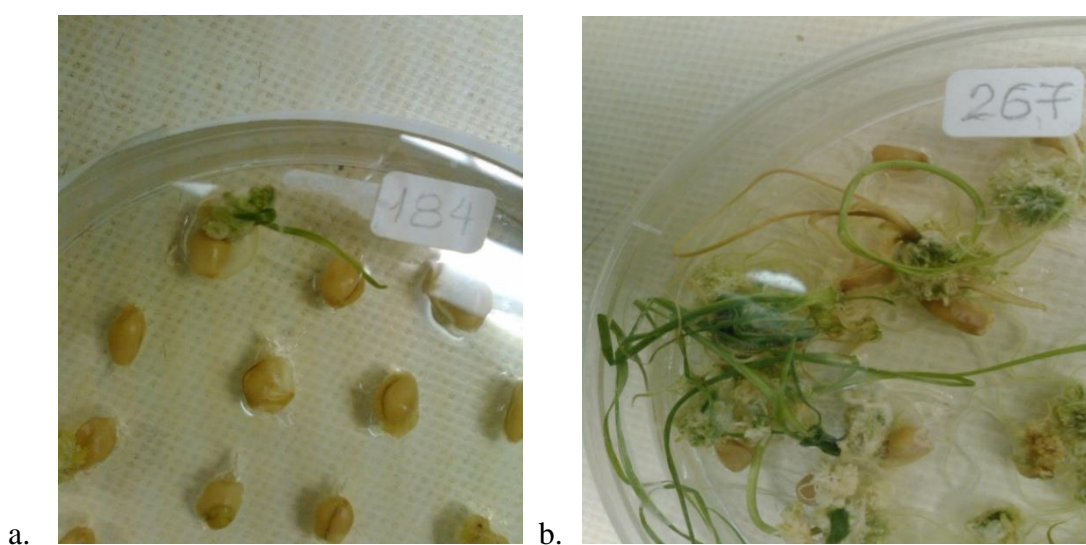


Figure 3. a. Seeds incubated in the culture medium without PEG b. Seeds germinated in the culture medium without PEG

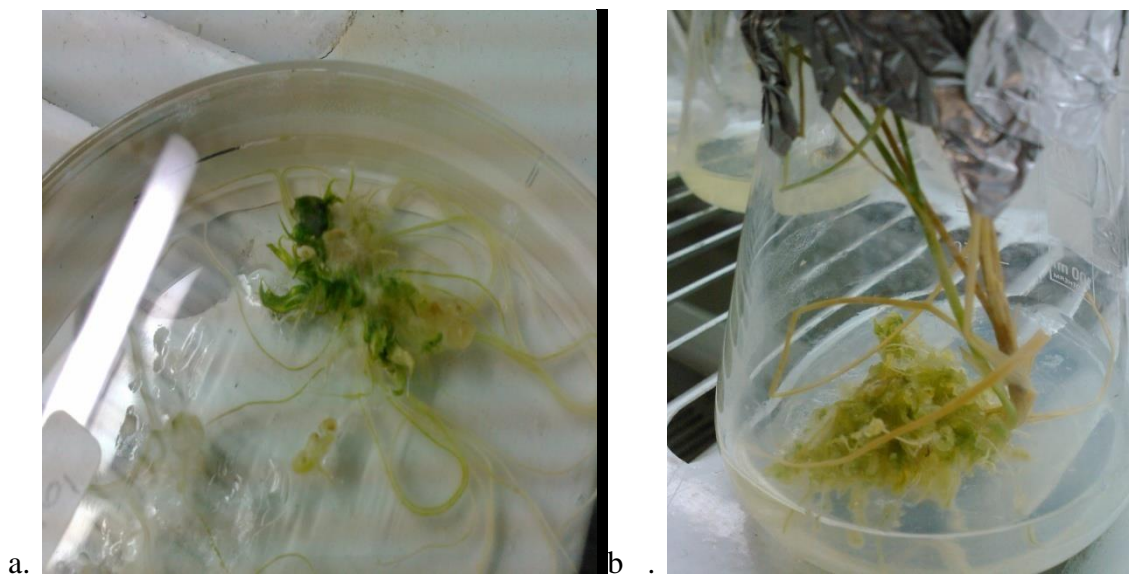


Figure 4. a. Seeds germinated in the culture medium with PEG 10%. b. Callus production

### Conclusions

There are considerable differences in drought resistance between the genotypes studied. The presence of PEG, or otherwise the drought stressing conditions reduced the embryo germination in all cultivars studied except in cultivar Acheron which is characterized as resistant to drought. Additionally the cultivars Acheloos (bread wheat), Anna and Elpida (durum wheat) were found to be more resistant to drought conditions compared to the other genotypes, whereas Mexikali, Papadakis, Doirani, Orfeas, Strymonas, and Athos were the most sensitive to drought stress conditions. The bread wheat cultivar Acheron, which carries the 1BL.1RS wheat rye translocation, was the only one not affected by the presence of PEG. The presence of the translocation in this cultivar seems to help its resistance to drought, but further research is needed to confirm it.

### References

- Acevedo E., Fereres E. (1994). Resistance to abiotic stresses. In Hayward, M. D., Bosemark, N. O. and Romagosa, I. (eds) Plant breeding: principles and prospects. Chapman and Hall, London. pp. 406-421.
- Cereal Institute of Thessaloniki. (1985): Cereal Varieties, Hellenic Ministry of Agriculture, Thessaloniki (in Hellenic).
- Hassanein Anber. (2010). Establishment of Efficient in vitro Method for Drought Tolerance Evaluation in Pelargonium. Journal of Horticultural Science & Ornamental Plants 2(1): 08-15.
- Hsissou D., Bouharmont J. (1994). In vitro selection and characterization of drought tolerant plants of durum wheat (*Triticum durum* Desf.). *Agronomie*, 2: 65-70.
- Khakwani Abdul Aziz, Dennett MD., Munir M. (2011). Early growth response of six wheat varieties under artificial osmotic stress condition. *Pak.J. Agri. Sci.* 48(2): 119-123.
- Kim W., Johnson J.W., Baenziger P.S., Lukaszewski A.J., Gaines C.S. (2004). Agronomic effect of wheat-rye translocation carrying rye chromatin (1R) from different sources, *Crop Science*, vol. 44, no. 4, pp. 1254-1258.
- Kondic Ankica, Sesek S. (1998). In vitro selection of wheat genotypes for herbicide tolerance. In: Proceed, of 2nd Balkan Symposium on Field Crops 16-20 June 1998, Novi Sad , Yugoslavia, Vol. 1, 169-171.



- Lazaridou T.B., Pankou C.I., Xynias, I.N., Roupakias D.G. (2017). Effect of the 1BL.1RS Wheat- Rye Translocation on the Androgenic Response in Spring Bread Wheat. *Cytology and Genetics*, vol. 6, (accepted for publication).
- Misra N., Dwivedi U.N. (2004). Genotypic difference in salinity tolerance of greengram cultivars. *Plant Sci.*, 166: 1135-1142.
- Murashige T., Skoog F. (1962). A revised medium for rapid growth and bioassays with tobacco tissue cultures. *Physiologia Plantarum* 15: 473-497.
- Singh G., Chaudhary H. (2006). Selection parameters and yield enhancement of wheat (*Triticum aestivum* L.) under different moisture stress condition. *Asian Journal of Plant Sciences*, 5: 894-898.
- Soliman Hemaïd, Hendawy Mohamed. (2013). Selection for Drought Tolerance Genotypes in Durum Wheat (*Triticum durum* Desf.) Under In vitro Conditions. *Middle-East Journal of Scientific Research* 14(1): 69-78.
- Zhu J.K., Hasegawa P.M., Bressan R.A. (1997). Molecular aspects of osmotic stress in plants: *Critical Rev. Plant Sci.* 16: 253-277.

## **COMPARING THE YIELD OF PULSES USING DIFFERENT INTEGRATED CROP MANAGEMENT STRATEGIES: A CASE STUDY IN INDIA**

Suresh K. MUDDA<sup>1\*</sup>, Chitti B. GIDDI<sup>2</sup>

<sup>1</sup>District Agricultural Advisory and Transfer of Technology Centre, Srikakulam, Acharya N G Ranga Agricultural University, A.P, India

<sup>2</sup>Crop protection, District Agricultural Advisory and Transfer of Technology Centre, Srikakulam, Acharya N G Ranga Agricultural University, A.P, India

\*Corresponding Author: skmudda@rediffmail.com

### **Abstract**

Poor population in India amounts to more than 300 million people, with almost 30 percent of rural population living in poverty. An estimated 43 per cent of children under the age of five years are malnourished (WFP, 2012). Pulses, being rich and cheap source of protein can supplement the diet for poor and malnourished people. Pulse crops can be grown in almost all types of climate and comes to harvest by 3-6 months of duration, with a minimum amount of water requirement. Keeping these things in view this study has been designed to study the production techniques viz., integrated crop management including integrated pest, diseases, weeds and nutrient management in pulses and also the cost of cultivation in the north coastal regions of Southern India in five locations each. The yields under each treatment that is ICM practices Vs farmers practices and also the cost benefit ratios in each crop and each location were studied and their average means were compared for analysis. The results of the study in case of pigeon pea, Mung bean and Urd bean will also give further directions and help to develop the concrete strategies through the implementation of the interventions in a mission mode by actively engaging all stake holders at various levels for the increased and sustainable pulse production under the National food security Mission Programme being implemented by Government of India to keep India as a zero hunger country in forthcoming years with safe and secured nutrition.

**Keywords:** *India, Food security, Pulses, ICM practices, Zero hunger.*

### **Introduction**

India's poor population amounts to more than 300 million people, with almost 30 percent of India's rural population living in poverty. Even though, the poverty has been on the decline in recent years, (rural poverty declined by 8 percentage points from 41.8% to 33.8% and urban poverty by 4.8 percentage points from 25.7% to 20.9%) (World Bank, 2012), the country is suffering from malnutrition and hungry population. An estimated 43 per cent of children under the age of five years are malnourished (WFP, 2012). Pulses, being rich and cheap source of protein can supplement the diet with more protein for poor and malnourished people. Pulses provide high quality protein complementing the cereal proteins for predominantly substantial vegetarian population of the country. Pulses also provide essential amino acids in adequate amounts and the food value will be increased manifold in terms of both economically and nutritionally. Pulses are also rich source of micro nutrients including Iron, which is of particular relevance in developing countries where every second pregnant woman and about 40% of preschool children are estimated to be anemic.

Pulses are mostly cultivated under rain fed conditions and do not require intensive irrigation facility and this is the reason why pulses are grown in areas left after satisfying the demand for cereal and cash crops. In addition to that pulses also improve soil fertility and physical structure, fit in mixed/inter-cropping system, crop rotations and dry farming and provide green pods for vegetable and nutritious fodder for cattle as well. Pulse crops can be grown in

almost all types of climate and comes to harvest by 3-6 months of duration, with a minimum amount of water requirement. Various agronomic researches have shown that improved cultivation practices, such as seed replacement with improved varieties, raised bed planting method, use of bio fertilizers, foliar application of fertilizers at critical stages in rain fed areas, application of secondary and micro-nutrients and adoption of appropriate modules for integrated weed and pest management, etc. have great potential in gearing-up pulses productivity.

#### Per capita availability of pulses in India

As a result of stagnant pulse production and continuous increase in population, the per capita availability of pulses has decreased considerably. The per capita per day availability of pulses in 1951 was 60 g that dwindled down to level of 35.4 g in the year 2010. (Commodity Profile for Pulses, 2017).

**Table 1: Per capita availability of pulses in India**

Year	Pulses availability (gms/capita/day)	Pulses availability (Kgs/capita/year)
1951	60.7	22.1
1961	69.0	25.2
1971	51.2	18.7
1981	37.5	13.7
1991	41.6	15.2
2001	30.0	10.9
2011	43.0	15.7
2014	47.2	17.2

Source: *Agricultural Statistics at a Glance, 2014*

So In order to meet the projected demand of 32 million tonnes of pulses by 2030, a growth rate of 4.2% has to be ensured. This will be achieved through the coordinated and concerted efforts followed in crop production and protection through certain strategic and scientific approaches. Production of major pulses is constrained by both biotic and abiotic stresses. For example the major constraints to productivity in pigeonpea are biotic stresses such as pod borer, pod fly, Fusarium wilt, and sterility mosaic disease. Similarly, pod borer, aphids, cutworm, powdery mildew, rust and wilt are the major pests and diseases affecting lentil production in India. The richness of legumes in N and P, makes them attractive for insect pests and diseases (Sinclair and Vadez, 2012). Poor drainage/water logging during the rainy season causes heavy losses to pigeonpea on account of low plant stand and increased incidence of phytophthora blight disease etc. (Gowda *et al.*, 2013). The most potential technologies in pulse production include improved crop establishment and management practices, integrated soil fertility and pest management practices, etc. which enhance not only the productivity and profitability but also warrants environmental and social sustainability besides nutritional security. (Vijaya punia, 2015)

Keeping these things in view this case study has been designed with the following objectives in the north coastal region of South India.

Evaluation of the crop performance through yield comparisons in case of the major pulse crops grown in this region *i.e* Pegin pea, Urd bean and Mung bean is studied with the objectives of

Integrated nutrient, pest and disease management in Pegin pea

Integrated weed , pest and disease management in green gram( Mung bean)

Integrated weed , pest and disease management in black gram (Urd bean)

## Materials and methods

Case study design of the experiment was taken up as the research and analysis were taken up in a limited area of North coastal region of South India comprising the state of Andhra Pradesh with tropical climate conditions mostly rainfed farming systems, where rice fallow pulses was the predominant cropping system was purposively selected by the researcher as a peculiar case for pulse production. In this region pigeon pea is generally grown as sole or intercrop as a first (kharif) crop and the remaining two crops viz, green gram and black gram are grown as second (rabi) crops. The respective treatments in the respective crops is based on the recommendations of the ICM package in each crop and were compared with the conventional farmers' practice. The field data was recorded in each hectare of farmer's fields of 5 nos each in each crop with treatments, against the farmer treated plots of one hectare each in each crop and the yields were compared and also the benefit cost ratios were worked out based on the prevailing market price of that particular crop.

## Results and discussion

Pigeonpea (Arhar) commonly known as red gram or tur is a very old crop of this country. It accounts for about 11.8% of the total pulse area and 17% of total pulse production of the country (Agricultural Statistics, 2013). The average yield per ha *i.e* the productivity of the crop is 650 kg/ha against the world average of 762 kg/ha, this region's average productivity is still low that is around 562 kg/ha. This gap is mostly because of the poor management practices of the crop and also because of the regular occurrence of pests and diseases in this region. So an evaluation study has been designed in the farmers' fields where a scientifically recommended package of practices was suggested in case of nutrient and pest management against *Maruca testulalis* and pod fly (*Melanagromyza obtuse*).

In general farmers use fertilizers with approximation without going for soil testing in case of pulse crops. But in this experiment a structured nutrient management schedule was developed based on the soil analysis in 5 locations and the yields were compared over three consecutive years. 25-30 kg N, 50-75 Kg P<sub>2</sub>O<sub>5</sub>, 30 kg K<sub>2</sub>O and 10-15 kg ZnSO<sub>4</sub> in one ha area are applied as Recommended doses of fertilizers. Applied 20 kg S per ha in addition to NP at the time of sowing. For correcting Zn deficiency, foliar spray of 0.5 kg ZnSO<sub>4</sub> with 0.25 kg lime or soil application of ZnSO<sub>4</sub> @ 25 kg per ha to one crop on Zn deficient soils is helpful to both the crop of pulse based cropping system. Mo deficiency is corrected by applying 1 kg sodium molybdate per ha and for boron deficient soils foliar spray of B @ 1.0 – 1.5 kg B per ha or soil application of 4 kg borax. Spray 1.0 per cent FeSO<sub>4</sub> to recoup the crop from Fe deficiency. Application of fertilizer is based on soil testing. The recommended practice is also supplemented with the application of FYM @ 2.5 T/ha, whereas, the farmers practice is general application of 50 Kgs of urea and 50 kgs of DAP or other complex fertilizers like 28-28-0 around 50 Kgs /ha.

Regarding the pest management in pigeonpea the crop is mostly affected by *Maruca* pod borer and pod fly in this region and causing 30-40% yield loss in various situations. Spraying with Monocrotophos (0.04%) or Chloropyrifos (0.05%) or Fenvalerate (0.004%) or Cypermethrin 0.004%. Imidachlopid 17.8 SL @ 70 g/ha. Use of neem seed kernels (5%) extract with 1 % soap solution was recommended as a practice for the control of *Maruca* pod borer and spraying of Monocrotophos (0.04%) or Dimethioate (0.03%) or Novaluron (0.01%) (Chitti Babu *et al.*, 2011). Flubendiamide 480 SC 48 g/ha solution was recommended as a practice for the control of fruit fly against the farmers practice of indiscriminate use of pesticides like acephate and monocrotophos in non-recommended doses.

**Table 3: Comparative yields in Pigeon Pea**

S. No	Year	No of locations	ICM package	FP	Yield increase	CB ratio
1	2014-15	5	518	364	42.3	1:1.50
2	2015-16	5	525	395	32.9	1:1.62
3	2016-17	5	540	372	45.0	1:1.45

The above table No 3 clearly indicates that there was a yield increase of 33 to 45 Percent over the three years with a benefit cost ratio of 1.45 to 1.62 depending on the season, cost of cultivation and the prevailing price situation. However there was an increasing trend in the yields in the treated plots when compared to farmers plots. In the treated plots a prescribed integrated crop management schedule was given including the pest and disease management, where as in the farmers plots no organised plant protection and nutrient management was taken up in all the five locations. So recommended practices of INM and IPM in Pigeon Pea will definitely contribute for significant yield increase and profitable for the farmer.

#### **Urd bean (black gram)**

Urd bean is popularly known as Blackgram which differs from other pulses in its peculiarity of attaining a mucilaginous pasty character when soaked in water. The significant character of this crop is its short duration and photo insensitive varieties, those fit well in different cropping situations, especially intensive crop rotations. The pulse legume is used as a green manure after picking the pods and with its characteristics to fix the atmospheric nitrogen. In this region of India, the blackgram is generally suffering from a peculiar weed infestation *Vicia sativa* which is almost similar in its seed and canopy characteristics. Control of this weed will definitely show the significant yield improvement in this region. Similarly sucking pests like aphids and diseases like Yellow Mosaic Virus, powdery mildew are also very common in this region.

*Vicia sativa* is a common weed in north coastal region of south India with the similar phenotypical characteristics of blackgram. Farmers generally cannot identify the weed in the early stages; hence they cannot go for weed management. To control this it is spraying of Sodium Aciflourfen 16.5%+ Cladinofop-Propargyl 8% EC type is used as a selective post emergence herbicide was taken up along with the other pest and disease control measures. The most common pests those affect the crop are sucking pests and whitefly, which also acts as the vector for spreading of the YMV.

To control the sucking pests Monocrotophos 40 EC @ 0.04% or Confidor 200 SL @ 7.5 ml/10 litre of water, to control whitefly Monocrotophos (0.04%) or Dimethoate (0.03%) are sprayed. In case of YMV incidence growing of the resistant varieties like LBG 752, Destroying the infected plants, Applying Phorate or Disulfoton granule @ 1 Kg a.i./hectare at the time of sowing, Spraying the crop with Metasystox @ 1 ml per litre of water to control vector population were practiced in a whole package form for three consecutive years and the yields were observed.

**Table 4: Comparative yields in Urd bean**

S. No	Year	No of locations	ICM package	FP	Yield increase	CB ratio
1	2014-15	5	650	453	43.5	1:1.46
2	2015-16	5	597	428	39.4	1:1.62
3	2016-17	5	675	474	42.4	1:1.51

The above table No 4 clearly indicates that there was an yield increase of 39 to 44 Percent over the three years with a benefit cost ratio of 1.46 to 1.62 depending on the season, cost of cultivation and the prevailing price situation. However there was an increasing trend in the yields in the treated plots when compared to farmers plots. In the treated plots a prescribed integrated crop management schedule was given including the pest and disease management, where as in the farmers plots no organized plant protection and weed management was taken up in all the five locations. So recommended practices of Integrated weed management and Integrated pest Management in Urd Bean will definitely contribute for significant yield increase and profitable for the farmer.

### Mung bean

Mung bean is popularly known as green gram. Short duration and photo insensitive varieties of mung bean fit well in many intensive cropping systems across the country. Summer greengram is especially help in sustaining the productivity levels of rice-wheat cropping system of Indo-Gangetic belt of northern India without any competition to rice or wheat, with additional yield of 10-15 q/ha.

The average yield per ha *i.e* the productivity of the crop is around 405 kgs against the national average of 461kgs/ha against the world average of 904kgs/ha. But the yield of this crop is mostly affected by the weeds, pests and diseases. The highest crop yield was obtained when weeds were removed 35 days after sowing. Any further delay in weed removal results in a corresponding decrease in yield. Cuscuta being the predominant weed in this region a comprehensive integrated strategy was adopted to control the other weeds along with cuscuta. A maximum of 2 hand-weedings in the initial stages of crop growth up to 30-35 days, were taken up to take care of the weed problem. Pre-emergence application of Lasso or Tok E-25 @ 2kg ai/ha in 1,000 litres of water ensures complete weed control. Application of Pendimethalin (PI) + Imazethapyr (POE) 1250+100 g a.i./ha at 0-3 (PI) and 20-25 (POE) DAS control weeds. The other pests and diseases are almost common in case of green gram and black gram.

To control the sucking pests Monocrotophos 40 EC @ 0.04% or Confidor 200 SL @ 7.5 ml/10 litre of water, to control whitefly Monocrotophos (0.04%) or Dimethoate (0.03%) are sprayed. In case of YMV incidence growing of the resistant varieties like LBG 752, Destroying the infected plants, Applying Phorate or Disulfoton granule @ 1 Kg a.i./hectare at the time of sowing, spraying the crop with Metasystox @ 1 ml per litre of water to control vector population were practiced in a whole package form for three consecutive years and the yields were observed. To control the powdery mildew spraying the crop with wettable Sulphur @ 3 g/litre of water or Dinocap @ 1 ml/litre water was taken up.

**Table 5: Comparative yields in Mung bean**

S. No	Year	No of locations	ICM package	FP	Yield increase	CB ratio
1	2014-15	5	684	476	43.6	1:1.46
2	2015-16	5	628	452	38.9	1:1.61
3	2016-17	5	690	498	38.5	1:1.58

The above table No 5 clearly indicates that there was an yield increase of 38.5 to 43.6 Percent over the three years with a benefit cost ratio of 1.46 to 1.61 depending on the season, cost of

cultivation and the prevailing price situation. However there was an increasing trend in the yields in the treated plots when compared to farmers plots. In the treated plots a prescribed integrated crop management schedule was given including the pest and disease management, where as in the farmers plots no organised plant protection and weed management was taken up in all the five locations. So recommended practices of Integrated weed management and integrated pest Management in Mung Bean will definitely contribute for significant yield increase and profitable for the farmer.

### **Summary and conclusions**

The North coastal region of South India comprising the state of Andhra Pradesh with tropical climate conditions mostly rain fed farming systems, where rice fallow pulses was the predominant cropping system was purposively selected as a case to study the strategies for pulse production. In this region pidgeon pea is generally grown as sole or intercrop as a first (kharif) crop and the remaining two crops viz, green gram and black gram are grown as second (rabi) crops in the research area that is the North coastal India is the largest producer, 25% of world's production, and consumer 27% of total pulses of the world. The domestic production is often less than the estimated demand *i.e.* 2324 million tons. So the regular periodic management practices with an integrated approach for weed, pest and disease control along with specific nutrient management principles will definitely contribute for significant yield increase in this region. Efforts through compilation have been made to have an access to most of the FAQs on pulses development, plan effort's impacts, scenario, strategies, post-harvest and processing aspects along-with the production technology. However, scientific and technological development without reaching farmers through proper distribution channels is not fruitful. Hence, the increased availability of quality seeds at the village level through innovative seed production and distribution mechanisms is important. Efforts need to be made to increase farm mechanization through varietal development and innovative custom hiring facilities to reduce peak season labour requirement. (Reddy, 2015)

It is also proposed for increasing production of pulses through area expansion and productivity enhancement; restoring soil fertility and productivity; creating employment opportunities; and enhancing farm level economy to restore confidence of farmers of targeted districts. The basic strategies were implementation of interventions in a mission mode through active engagement of all the stake holders at various levels. These interventions include promotion and extension of improved technologies *i.e.*, Seed, INM (micro-nutrient, soil amendments), IPM and resource conservation technologies (RCTs) and capacity building of farmers. Certain technological options including Short duration pulse cultivation, Pulses as summer crops, shift to pulses from other crops, Inter cropping will also help to increase the pulse production in this area. Interventions proposed were integrated with the district plan and target for each identified district was fixed. Constant monitoring and concurrent evaluation were done for assessing the impact of the interventions for a result oriented approach by the implementing agencies. In this paper, an attempt has been made to discuss improved pulse production practices which can play a vital role in sustainable pulse production in this region. Besides this, area expansion through their introduction in non-traditional area would also add to national pulse production. The improved production practices and strategies with context to pulses crop in Indian perspective discussed in this paper would definitely enlighten the agricultural professionals and policy makers to enhance their capabilities for sustainable pulse production in India in spite of various production vulnerabilities.

## References

- Agricultural Statistics at a Glance (2013). Govt. of India, Ministry of Agriculture. Directorate of Economics and Statistics. (<http://eands.dacnet.nic.in/PDF/Agricultural-Statistics-At-Glance2014.pdf>).
- Agricultural Statistics at a Glance (2014). Govt. of India, Ministry of Agriculture. Directorate of Economics and Statistics. <http://eands.dacnet.nic.in/Publication12-12-2013/Agricultureat%20a%20Glance2013/page1-23.pdf>
- Anonymous (2011). Vision 2030. Director, Indian Institute of Pulses Research, ICAR, Kanpur, India, pp.1-42.
- Burton E. Swanson, Robert P. Bentz and Andrew J S (1997) Improving Agricultural Extension. A reference manual. Food and Agriculture Organization of the United Nations. Rome, 1997
- Chitti Babu G., Madhumathi T, Arjuna rao P and Srinivasarao V (2011) Evaluation of different Insecticides and their Spray schedules against spotted pod borer, *Maruca vitrata* on blackgram. The Andhra Agricultural Journal. Vol.58 (2).
- Commodity profile for Pulses, March 2017. <http://agricoop.nic.in/sites/default/files/Pulses.pdf>. Accessed on 12/07/2017.
- FAO, WFP and IFAD. (2012). The State of Food Insecurity in the World 2012. Economic growth is necessary but not sufficient to accelerate reduction of hunger and malnutrition. Rome, FAO.
- Gosh Madhusudan (2011) Agricultural policy reforms and spatial integration of food grain markets in India. Jour. of Economics and Development. Vol. 36(2): Pages (15-36). <http://www.foodsecurityportal.org/india/resources>. Accessed on 08/07/2017
- <https://www.google.co.in/search?q=yellow+mosaic+of+black+gram> on 06/07/2017
- Laxmipathi Gowda C. L., Srinivasan S., and Gaur P. M. (2013) Enhancing the Productivity and Production of Pulses in India. Climate Change and Sustainable Food Security, ISBN: 978-81 87663-76-8, National Institute of Advanced Studies, Bangalore and Indian Council of Agricultural Research, New Delhi. 2013
- Reddy, A A. (2015) Pulses production Trends and strategies to become self-sufficient. Indian Farming. Vol. 65(6), Pages (02–10).
- Sinclair T R and Vadez V (2012). The future of grain legumes in cropping systems. Crop & Pasture Science. Vol.63, Pages (501-512).
- Singh, K. Sharma, U. S. Swaminathan, R. and Dashora, P. K. (2009). Management of insect pests of *Vigna radiata* (L.) Wilczek. Applied Ecology and Environmental Research. Vol. 7: Pages (99- 109).
- Swaminathan, R., Hussain, T. and Bhati, K. K (2007). Influence of crop diversity on host preference by major insect pests of kharif pulses. Indian Journal of Applied Entomology Vol. 21: Pages (59-62).
- Tiwari and Shivhare (2016). Pulses in India: retrospect and prospects. Government of India Ministry of Agriculture (Department Of Agriculture and Cooperation) Directorate of Pulses Development Vindhyaachal Bhavan, Bhopal (M.P.)
- Vijay Punia (2015) Improved crop management practices for sustainable pulse production: An Indian perspective Indian Journal of Agricultural Sciences. Vol. 85 (6): Pages (747–758).



## **ACCURATION TEST OF “PINANGGAL DWASA AYU” METHOD TO DETERMINE CROP ROTATION IN BALI PROVINCE (INDONESIA)**

Raden Mas BHISMO SRENGGORO KUNTONUGROHO<sup>1</sup>, Putu Giana EKA SUARDI<sup>2</sup>,  
Abdurrahman Muhammad FIKRI RASDI<sup>3</sup>

<sup>1</sup>Faculty of Agriculture, University Gadjah Mada, Indonesia

<sup>2</sup>Faculty of Geography, University Gadjah Mada, Indonesia

\*Corresponding author: bhismo173@gmail.com

### **Abstract**

Agriculture is one of the most contributing sector that support Indonesia's economic growth, placing in second highest contributor in GDP (Gross Domestic Product) in Indonesia (BPS, 2016). The importance of agriculture in Indonesia triggers the uprising of local wisdom related to agriculture. One of the so called local wisdom is “Pinanggal Dewasa Ayu” which harness the combination of traditional calendar system. This combination will reflects based on actual climate condition, so it can be utilized to determine crop rotation. This local wisdom system is frequently used by local farmers. While it is widely used, this method is not scientifically tested yet. Based on this condition, it is necessary to research and test the accuration of “Pinanggal Dewasa Ayu” method. Goals of this research is to prescribe the accuration and precision of “Pinanggal Dewasa Ayu” method to determine crop rotation in Bali Province. Expectation is made that this method could help local farmers decide the most effective crop rotation which increase the agriculture productivity in Bali. This research is using Cropwat 8.0 software as testing ware. Cropwat 8.0 is a software which process agroclimate data from FAO (Food and Agriculture Organization). As much as 11 testing is conducted, resulting in 100% accuration and 86.8% of crop planting effectivity. The accuration and effectivity result indicates that “Pinanggal Dewasa Ayu” Method relevance is high and can be used as reference in Bali Province.

**Keywords:** “*Pinanggal Dewasa Ayu*”, *Crop rotation*, *Cropwat*, *Agriculture*

### **Introduction**

Agriculture is one of the main sectors of Indonesian economy Central Bureau of Statistics show that the agricultural sector accounted on average for 14% of revenue in Gross Domestic Product figures, placing agriculture in second position after the industry sector (Central Berau of Statistic, 2017 ) . This condition supported by Indonesia's geographical location at a latitude of 0<sup>0</sup> and located in the area of Ring Of Fire makes Indonesia fit to be agrarian country. Not only get Benefit from this physical condition, Indonesia also has the social potential in developing agriculture. Indonesia is the country peaked at # 4 as the country with the greatest population density. A large quantity of the population, can be used to build the agricultural sector..

The most planted commodity in Indonesia is rice The majority of Indonesian people consume rice as a staple food. Seeing the importance of the role of rice in Indonesia, the productivity of rice plants must continue to keep savings national rice stock. Bali is one of the provinces which acts as the national granary owned by Indonesia. Although, agricultural land in Bali thinning, but Bali is able to maintain rice production to maintain good cropping system. Aranging crop pattern can be done by looking at environmental factors. The environmental factors eg precipitation or rainfall. Rain factor that may affect plant growth is the amount /

volume of rain, deployment / distribution of the rainfall and rain effectiveness. The amount and distribution of rainfall affects the kinds / types of plants that can be cultivated on an area (Krisnawati, 2011). In addition, in his book entitled *Whiteman Manuaal in Tropical Pasture Science* said precipitation is a linear function of evaporation, transpiration, run-off (stream surface), and infiltration (the water that goes into the ground). Infiltration is a linear function of percolation, seepage and soil moisture. Knowing these facts, then peyesuaian planting time is important, particularly in Indonesia, which has the advantage of the tropical climate with abundant rainfall. Adjustment rainfall patterns with the cropping pattern can be done through agro-climatic studies. Agroclimate is Agroclimatology is climate science that studies the relationship between climate elements by processes of plant life. Studied in Agroclimatology is how climate elements that play a role in the life of the plant (Bargumono, 2012). Agroclimate known by theories of climate division that divides Oldenman altitude zones with precipitation character and describe plant species that live in it.

The importance of this agro-climatic analysis, make agroclimate analysis methods still growing until now. Since ancient era, Bali has introduced a system of agro-climatic analysis. This was stated in the determination of good doctrine called pawukon system. Basically pawukon use combination of moon cycle and sun to see the best time in starting the planting cycle (Gorgol, 2013). Using pawukon calculations, farmers in the province of Bali can determine planting cycles prior to the development of agro-climate-related science. Pawukon calculation is still believed by local farmers, and now included in the calendar in the province of Bali (Suwintana, 2014). However, this system still has not been tested scientifically accurate. So it needs related research about pawukon system accuracy test in determining the crop pattern in the province of Bali.

On the other hand, with the development of technology, integration of multiple data sources become easier. Now, the Food and Agriculture Organization of the United Nations launched CropWat 8.0 software. CropWat 8.0 for Windows is a computer program for the calculation of crop water requirements and irrigation requirements based on soil, climate and crop data. In addition, the program Allows the development of irrigation schedules for different management conditions and the calculation of scheme water supply for varying crop patterns. CropWat 8.0 can also be used to Evaluate farmers' irrigation practices and to estimate crop performance under both rainfed and Irrigated conditions (fao.org, 2017). This software analyzes the cropping pattern by integrating climate-related data and the determinants of plant characteristics. Several previous studies have made use of this software to determine the cropping pattern of a particular plant. Considering the frequent use of this software in the research, this software can be used for assessing accuracy of Pinanggal Ayu System.

### **Materials and methods**

This research study method used literature and comparative studies. Literature study was conducted to determine the working system of *Pinanggal Ayu* calculation, and find the appropriate cropping patterns according to this *Pinanggal Ayu*. Final calculation result, will be compared with the calculation of cropping patterns in CropWat 8.0. The method of *Pinanggal Ayu* obtained from the study from related research journal about *Pinanggal Ayu* appropriate calculation methods. The calculation method will be adjusted to the calendar in 2016. Some journals are collected, so the authors came to the conclusion about and match it with other 2016.. Calendar which has been obtained from *Pinanggal Ayu* method, calculated in the application CropWat 8.0 to test accuracy. Accuracy test conducted by contingency tables. From the contingency table, you will get a percentage of a match which reflect the accuracy of the method pawukon.

### Results and Discussion

Ayu pinanggal calculation or determination of the system either include many activities, such as marriage, home building and other funeral. Crop pattern analysis is one of them. Indeed, the crop pattern is described in detail based on the classification of plants. However, in this study, the pattern of the selected plants limited to rice, peanuts, tobacco consider all four of these commodities which plays a major role in Indonesian agriculture. Calculation of pinanggal ayu consists of a combination from *pawukon* and *wewaran*. *Wewaran* is the plural form of the word Wara meaning Today (weekdays), amounting to one to ten, namely: Eka Wara, Dwi Wara, Tri Wara, Chess Wara, Panca Wara, Sad Wara, Sapta Wara, Asta Wara, Sanga Wara, and Dasa Wara. Said numbers in the *wewaran* name indicates the number of days with the name of each, but not entirely fixed cycle, such as Eka Wara, Dwi Wara Wara Chess, Asta Wara Wara and Dasa Wara (Darmayasa, 2016). *Wewaran Sanga* has Urip or Neptu and numbers or numbers, which is refer to direction of the wind, as well as the name of his gods (Swarsi, 2003: 87).

The calculation to obtain a good day in the cropping cycle is composed of Saptawara, pancawara contained the formula below. After put all the components in the formula, it will obtain a number. The last digit of calculation result represent the prediction result. Number one represent good time to starting crop pattern

$$\text{Pinanggal ayu} = \text{last digit of (Urip Saptawara + pancawaraBirth) + (Urip Saptawara + pancawara start businesses / events)}$$

Umanis	Urip 5
Paing	Urip 9
Pon	Urip 7
Wage	Urip 4
Kliwon	Urip 8

Redite	0
Soma	1
Anggara	2
Buda	3
Wrespati	4
Sukra	5
Saniscara	6

Table 1. pancawara

Table 2. Saptawara

After entering this equation, the following is obtained either as a date

Rice	4-Jan	12-Jan	18-Jan	27-Jan	2-jun	10-jun	16-jun
Peanut	18-Jan	17-jun	14-Oct				
Tobacco	9-Jan	8-May	6-Aug				

These dates and then inserted into the software CropWat 8.0 dan produced the following results:

CropWat \ Pinanggal (Rice)	4-Jan	12-Jan	18-Jan	27-Jan	2-jun	10-jun	16-jun	17-jun
Schedule Efficiency	100%	100%	100%	100%	100%	100%	100%	100%
irrigation Efficiency	88%	92%	92.50%	96.80%	100%	100%	100%	100%
CropWat \ Pinanggal (Peanut)	18-Jan	17-jun	14-Oct					
Schedule Efficiency	100%	100%	100%					
irrigation Efficiency	54.5%	98.1%	64.1%					

CropWat \ Pinanggal (tobacco)	9-Jan	8-May	6-Aug
Schedule Efficiency	100%	100%	100%
irrigation Efficiency	52.4%	94.5%	96.80%

Comparative test results showed that the determination of the cropping pattern good for rice, peanuts, tobacco when viewed from rainfall that include in greatly category according to the type of plants. This is because the comparison test of the schedule efficiency has already reached 100% .While the efficiency of irrigation water for the greatest number obtained from rice plants that achieve of 96% in accuracy. The second sequence is occupied by the tobacco plants that have irrigation efficiency of 81.23% and the latter has an efficiency of 72.23% is peanuts.

If we look at the scientific side of the calculations associated with the ayu pinanggal system can be seen by the results for the month. Sapta wara consists of seven phases, which represent the seven phases of different weather. The essence of the meaning sapta wara, lies in the element of the moon and sun. In Saptawara redite represent climate phase transition from dry season to the rainy season. In this phase, the effect of moon or sun is not too strong.The second one is soma symbolizing dominance phase of the moon, while the sun is not yet showing its rays. anggara symbolizing the sun scorching conditions, while wrespati symbolizes the potential storm and lightning conditions tha always identical with bad decition to start crop pattern.Pancawara symbolize the daily cycle of the sun, or mean time in a day that can be used for planting. The cycle begins from sunrise to sunset.

### Conclusion

Comparative test results showed that the determination of the cropping pattern good for rice, peanuts, tobacco when viewed from rainfall that has suffered greatly according to the type of plants. This is because the comparison test of the efficiency of the schedule has already reached 100% .While the efficiency of irrigation water for the greatest number obtained from rice plants that achieve an accuracy of 96%. The second sequence is occupied by the tobacco plants that have a presentation irrigation efficiency of 81.23% and the latter has an efficiency of 72.23% is peanuts.

### References

- Bargumono. 2012. Cassava Planting. Yogyakarta:UniversitY OF National Development Yogyakarta
- Central Berau of Statistic.2017. Quarterly Distribution Of GDP At Current Market Prices By Industrial Origin (Percent), 2014-2017 .Accessed from [www.bps.go.id](http://www.bps.go.id) at 10 August 2017 by outhor.
- Central Berau of Statistic.2017. Population 15 Years of Age and Over Who Worked During the Previous Week by Main Industry and Educational Attainment, 2008 - 2017.Accessed from [www.bps.go.id](http://www.bps.go.id) at 10 August 2017 by outhor.
- Darmayasa, Jero Budi.2016.Jurnal Proceeding Seminar Nasional 2016: Eksplorasi Ethnomathematics Dalam Ajaran Asta Kosala-Kosali Untuk Memperkaya Khasanah Pendidikan Matematika.Universitas Pendidikan Ganesha
- Gorgol, Mircea.2013.International Journals of Multidiciplinary Educational Research.Voume 2,Issue 12.Sucharita Publication
- Krisnawati, H, E. Varis, M. Kallio, dan M. Kanninen. 2011b. Paraserianthes falcataria (L.) Nielsen: Ekologi, Silvikultur, dan Produktivitas. Center for International Forestry Research. Bogor.

- Maharani, Enita.2016. Fungsi Tari Rejang Adat Klasik Dalam Upacara Piodalan Di Pura Sanggar Agung Desa Bebandem Kabupaten Karangasem Bali.Yogyakarta:Universitas Negeri Yogyakarta
- Suwintana,I Ketut.2014.Jurnal Lontar Komputer : Penentuan Hari Baik Perkawinan Di Bali Berbasis Logika Fuzzy.Politeknik Negeri Bali. VOL. 5, NO.1.

## EFFECTS OF SEED PRIMING WITH GIBBERELIC AND SALICYLIC ACIDS AND MYCORRHIZAL INOCULATION ON YIELD AND YIELD COMPONENTS OF LENTIL (*Lens culinaris* L.)

Abbas BIABANI<sup>1\*</sup>, Mohsen AZARNIA<sup>2</sup>, Hamid Reza EISVAND<sup>3</sup>, Ebrahim Gholamalipour ALAMDARI<sup>1</sup>, Latif GHOLIZADEH<sup>1</sup>

<sup>1</sup>Faculty of Agriculture, GonbadeKavoos University, GonbadeKavoos, Golestan Province, Iran

<sup>2</sup>Crop Physiology, Plant Production Department, College of Agriculture and Natural Resources, GonbadeKavoos University, GonbadeKavoos, Golestan Province, Iran

<sup>3</sup>Department of Agronomy and Plant breeding, Lorestan University, Khorrm Abad, Lorestan Province, Iran

\*Corresponding author: abs346@yahoo.com; abbas.biabani@wsu.edu

### Abstract

Poor germination and weak plant establishment are lentil (*Lens culinaris* L.) production problems in arid and semi-arid areas. Seed priming may provide a solution to these problems by improving the rate and percentage of seedling emergence, establishment of more optimum plant densities and ultimately improving seed yield. A study was carried out to investigate mycorrhizal inoculation with *Glomus mosseae* and *Glomus intraradices* in combination with seed priming. The five treatments included Hydropriming, treatment with GA3100 ppm, salicylic acid 100 ppm, and GA3 100 ppm + salicylic acid 100 ppm as well as non-primed seeds as a control in a factorial experiment using a randomized complete block design with four replications. The experiment was conducted at GonbadeKavoos University in 2013-2014 winter seasons. Mycorrhizal inoculation increased pod number, harvest index, grain yield and the total biological yield. Also, mycorrhiza reduced the number of days to flowering and pod development, and frequency of empty pods. Priming treatments and combination treatment (seed priming + mycorrhizal inoculation) improved seed yield and components of yield. Hydropriming increased seed yield with and without mycorrhiza inoculation; however, hydroprimed seed increased yield when also inoculated with *Glomus intraradices*.

**Keywords:** *gibberellic acid, salicylic acid, seed priming, seed yield, seed yield components.*

### Introduction

As previously reported (Anon, 2009), lentil (*Lens culinaris* L.) contains 24-28% protein, 30-40% minerals and 22% vitamins and is an important component in the diets of people in semi-arid regions of the world. Yields of lentil average is 1077 kg/ha worldwide and 560 kg/ha in Iran (FAO 2012). In developing countries lentil is a good source of protein and amino acids in the diet of the people. Due to its ability in nitrogen fixation, lentil helps to maintain soil fertility and tends to improve yields of other crops in rotations (Parsa and Bagheri, 2008). However, FAO (2012) reports average lentil yields in Iran are much lower than the world average. The poor yields appear to be related to poor germination, weak seedling emergence, weak seedlings, biotic and abiotic stresses and generally undesirable plant establishment. This situation has forced us to look for ways to overcome early plant establishment problems.

One of methods for increasing germination and seedling quality is through seed priming. Priming is a process in which seeds absorb water and initiate the seed germination process prior to planting (McDonald, 2000). Different priming methods included osmopriming, hydropriming, matric priming, hormonal priming and biopriming. Priming can lead to faster growth of seedlings (Eisvand *et al.*, 2011a), improved germination percentage (Eisvand *et al.*,

2011b), hardier seedlings against unfavorable conditions (Eisvand *et al.*, 2011a), and increased yield and quality (Azarnia and Eisvand, 2013).

Germination percentage is important for crop establishment yield. Priming is a simple and effective technique to cope with environmental stresses and improve germination percentage (Bradford, 1986; Taylor and Harman, 1990). Some phyto-hormones such as salicylic acid and gibberellic acid can be used in priming (Zaki and Radwan, 2011). Pretreatment of salicylic acid depending on the desired concentration, species, and environmental conditions during growth plays an important role in regulating various physiological processes such as seed germination, plant development and photosynthesis (Iqbal and Ashraf, 2006). It is also an important signal molecule in plants and fluctuates in response to environmental stresses (Senaratna *et al.*, 2000).

Gibberellic acid is involved in many physiological processes such as cell division, increase in cell length (Khoshkhouy *et al.*, 1999), germination and seedling growth (Eisvand *et al.*, 2011a; Eisvand *et al.*, 2011b), earliness, flowering and yield (Kaur *et al.*, 2005; Azarnia and Eisvand, 2013). Therefore, this study was designed to investigate the effects of mycorrhiza inoculation and seed priming with plant growth regulators (GA3 and SA) on yield and yield components of lentil.

### Material and Methods

Seeds of Kimiya a well-known lentil cultivar grown by farmers in GonbadeKavoos were prepared at GonbadeKavoos Agricultural Research Centre. A field experiment was conducted during 2013 -2014 at the research farm of GonbadeKavoos University, Iran. The experiment was arranged using a factorial design in a randomized complete block with four replications. The first factor was the application of mycorrhiza at three levels (control, inoculation of soil by *Glomus intraradices* and inoculation of soil by *Glomus mosseae*) and the second factor was priming treatments at five levels (hydropriming with distilled water, priming with GA3 100 ppm, priming with SA 100 ppm, priming with GA3 100 ppm + SA 100 ppm and non-primed seed as control). Soil was inoculated by propagol (Mixed fungal spores, external mycelium and root colonization). Both mycorrhizal fungi (*G. intraradices* and *G. mosseae*) were obtained from Zist Fannavar Company, Iran.

Priming: seeds were disinfected with sodium hypochlorite (2%) then washed with distilled water and transferred to priming solutions (GA3 100 ppm, SA 100 ppm, GA3 100 ppm+ SA 100 ppm) for 8 h. For aeration during the priming process, an air pump was used. Seeds were then dried at 24 °C. These seeds are called primed seeds. Mycorrhizal inoculation 5g mycorrhiza ( $2 \times 10^3$  spore per gram) per gram of seeds was applied at the time of sowing in the soil. Lentil seeds were sown as R×R=25 cm (interval of between rows) and P×P=4 cm (interval between plants on the rows) in plots with 1.25×7 m. Distance between plots was 50 cm. The Field visited daily after seedling emergence and establishment, and characteristics such as days to 50% flowering, days to 50% podding, number of pods, number of grains per pod, the ratio of filled pods to empty pods, empty pod percentage, grain yield and harvest index were recorded. The ratio of filled pods to empty pods was calculated according to the following equation:

ratio of filled pods to empty pods

$$\text{ratio of filled pods to empty pods} = \frac{\text{filled pods}}{\text{empty pods}} \times 100$$

Days to 50% flowering and podding were also calculated based on the days to flowering and podding when half of plants in a plot had one opened flower or had one pod respectively (Anwar, 2003).

## Results and Discussion

### Grain weight and grain number per pod

All treatments significantly affected 100 grain weight (table 1). Results showed that priming and combined application of priming and mycorrhiza increased 100 grain weight and the highest grain weight was achieved by priming and mycorrhiza inoculation. There was no difference between the single application of gibberellic acid and combined applications of hydropriming and salicylic acid. It should be mentioned that there were no significant differences between other treatments in bio-fertilizers treatments (table 2). Results showed that effects of priming and combined applications of priming and mycorrhiza were significant on grain number per pod (table 1). Mycorrhiza inoculation did not significantly increase grain number per pod while the maximum grain number per pod was achieved with hydropriming and the lowest number of grains per pod was related to the combined application of 100 ppm salicylic acid + 100 ppm gibberellic acid (table 2). Previously it has been reported that priming increases grain number per pod and per plant (Kaur *et al.*, 2005; Azarnia and Eisvand, 2013).

### Pod number and filled pods to empty pods ratio (FP /EP)

The effect of all of the treatments on pod number was significant (table 1). Mycorrhizal inoculation increased pod number up to 21%. Priming treatment at all mycorrhiza inoculation treatments increased pod number where maximum pod number was observed with hydropriming + *Glomus intraradices* inoculation and minimum pod number was related to 100 ppm gibberellic acid (table 2). Main effects of mycorrhiza inoculation and priming treatments and interaction of them had meaningful effects on the filled pod to empty pod ratio (table 1). Combined effects of priming and mycorrhiza inoculation increased the filled pod to empty pod ratio. The highest ratio was at single mycorrhiza inoculation by *Glomus mosseae* combined with *Glomus intraradices* and 100 ppm salicylic acid (10.3 and 5.43 respectively) and the lowest ratio was related to *Glomus mosseae* and 100 ppm salicylic acid and 100 ppm gibberellic acid + priming by 100 ppm salicylic acid (table 2). Number of pods, number of grains per pod and grain weight is important components in the formation of lentil yield. Numbers of seeds per pod and seed weight is mostly influenced by genetics and are less affected by environmental factors. It seems that the number of pods, is the most important variable in the formation of seed yield of lentil. In the present study, each treatment also increased the number of filled pods and ultimately directly increased grain yield which was obvious with mycorrhizal fungi and priming treatments. On the other hand, it seems that plants have mechanisms that regulate the size of the sink based on the amount of available assimilate, thus in seasons with drought stress and closing of stomata and reduced photosynthesis and subsequently reduction of assimilate, plants respond by dropping of flowers and pods to decreased the sink resulting in reduced yields (Kumudini, 2002). Mohammadi *et al.* (2011) indicated that drought stress reduced lentil pod number; however, applications of bio-fertilizers increased pod number even under drought stress. Azarnia and Eisvand (2013) reported that priming of chickpea grains under rainfed condition increased pod number compared to the control treatment which is in agreement with results of Mohammadi *et al.* (2011) and Azarnia and Eisvand (2013).

### Biomass and grain yield

All treatments significantly ( $P \leq 0.01$ ) affected biomass yield (table 1). Priming in combination with mycorrhiza inoculation improved biomass yield and maximum biomass was achieved from the combination of *Glomus intraradices* and 100ppm salicylic acid and there was no difference when compared to the *Glomus mosseae* and hydropriming treatment. Minimum



biomass also was achieved from the 100 ppm gibberellic acid treatment without mycorrhizal inoculation (table 2). All treatments significantly ( $P \leq 0.01$ ) affected grain yield (table 1). Increased lentil grain yields were obtained from applications of bio-fertilizers and inoculation

Table 1. ANOVA (mean square) for some studied traits in lentil affected by mycorrhiza inoculation and seed priming

S.O.V	df	Number of pods	Ratio of fill pod
Replication	3	932854.02 <sup>ns</sup>	1.19 <sup>ns</sup>
Mycorrhiza(A)	2	26301621.43 <sup>**</sup>	14.43 <sup>**</sup>
Priming(B)	4	22059549.16 <sup>**</sup>	24.16 <sup>**</sup>
A*B	8	1375284.54 <sup>*</sup>	9.83 <sup>**</sup>
Error	42	600482.78	1.2
C.V (%)	-	13.6	13.81

ns :Non-significant, \*and \*\*: Significant at  $\alpha = 0.05$  &  $\alpha = 0.01$ , respectively.

Table 1. Continued

S.O.V	Df	mean square				
		number of seed in pod	Weigh of 100 grain	Seed yield	Biomass	harvest index
Replication	3	0.013 <sup>ns</sup>	7.43 <sup>ns</sup>	210513.66 <sup>ns</sup>	8285432.2 <sup>**</sup>	67.79 <sup>*</sup>
Mycorrhiza (A)	2	0.031 <sup>ns</sup>	25.45 <sup>*</sup>	1748766.7 <sup>**</sup>	8308285.3 <sup>**</sup>	141.94 <sup>**</sup>
Priming(B)	4	0.065 <sup>*</sup>	32.14 <sup>**</sup>	924008.36 <sup>**</sup>	3400992.85 <sup>**</sup>	75.44 <sup>*</sup>
A*B	8	0.065 <sup>**</sup>	57.83 <sup>**</sup>	343565.1 <sup>**</sup>	3764932.01 <sup>**</sup>	80.32 <sup>**</sup>
Error	42	0.019	7.67	83075.68	680322.03	23.83
C.V (%)	-	11.42	5.80	12.94	11.70	15.23

ns :Non-significant, \*and \*\*: Significant at  $\alpha = 0.05$  &  $\alpha = 0.01$ , respectively.

Table 2. Mean comparison for effects of priming and mycorrhizal inoculation on the yield and yield components of lentil

Mycorrhiza inoculation	Priming treatments	Number of pods	Ratio of fill pod	number of seed in pod	Weigh of 100 grains	Seed yield	Biomass	harvest index
Non-Mycorrhiza	Control	4303 <sup>bc</sup>	8.79 <sup>bc</sup>	1.23 <sup>bc</sup>	46.45 <sup>c</sup>	2051 <sup>bcd</sup>	6700 <sup>bcde</sup>	31.03 <sup>bc</sup>
	GA <sub>100</sub> ppm	2835 <sup>c</sup>	9.84 <sup>ab</sup>	1.12 <sup>c</sup>	53.55 <sup>a</sup>	1780 <sup>d</sup>	5878 <sup>e</sup>	30.58 <sup>bc</sup>
	SA <sub>100</sub> ppm	4794 <sup>bc</sup>	6.02 <sup>ef</sup>	1.18 <sup>bc</sup>	47.33 <sup>bc</sup>	1849 <sup>d</sup>	6406 <sup>cde</sup>	29.44 <sup>c</sup>
	Hydropriming	6372 <sup>ab</sup>	9.53 <sup>ab</sup>	1.58 <sup>a</sup>	43.83 <sup>c</sup>	1923 <sup>cd</sup>	6233 <sup>de</sup>	30.64 <sup>bc</sup>
	SA + GA	4313 <sup>bc</sup>	5.56 <sup>ef</sup>	1.07 <sup>c</sup>	53.38 <sup>a</sup>	1892 <sup>cd</sup>	6494 <sup>bcde</sup>	29.67 <sup>bc</sup>
<i>Glomus intraradices</i>	Control	5937 <sup>bc</sup>	9.92 <sup>ab</sup>	1.15 <sup>bc</sup>	45.75 <sup>c</sup>	1910 <sup>cd</sup>	6622 <sup>bcde</sup>	29.45 <sup>c</sup>
	GA <sub>100</sub> ppm	5643 <sup>bc</sup>	7.68 <sup>cd</sup>	1.2 <sup>bc</sup>	45.78 <sup>c</sup>	2222 <sup>bc</sup>	6850 <sup>bcde</sup>	32.45 <sup>bc</sup>
	SA <sub>100</sub> ppm	7341 <sup>ab</sup>	6.06 <sup>ef</sup>	1.15 <sup>bc</sup>	46.15 <sup>c</sup>	2817 <sup>a</sup>	9329 <sup>a</sup>	30.22 <sup>bc</sup>
	Hydropriming	9576 <sup>a</sup>	10.05 <sup>ab</sup>	1.12 <sup>c</sup>	54.08 <sup>a</sup>	3184 <sup>a</sup>	6800 <sup>bcde</sup>	47.61 <sup>a</sup>
	SA + GA	5567 <sup>bc</sup>	10.24 <sup>a</sup>	1.17 <sup>bc</sup>	46.42 <sup>c</sup>	2227 <sup>bc</sup>	6378 <sup>cde</sup>	35.85 <sup>b</sup>
<i>Glomus mosseae</i>	Control	6248 <sup>abc</sup>	10.30 <sup>a</sup>	1.32 <sup>b</sup>	45.80 <sup>c</sup>	1919 <sup>cd</sup>	6961 <sup>bcd</sup>	27.82 <sup>c</sup>
	GA <sub>100</sub> ppm	4695 <sup>bc</sup>	6.41 <sup>def</sup>	1.1 <sup>c</sup>	50.63 <sup>ab</sup>	2334 <sup>b</sup>	7400 <sup>bc</sup>	31.65 <sup>bc</sup>
	SA <sub>100</sub> ppm	6065 <sup>bc</sup>	5.43 <sup>f</sup>	1.22 <sup>bc</sup>	45.45 <sup>c</sup>	2416 <sup>b</sup>	7461 <sup>b</sup>	32.62 <sup>bc</sup>
	Hydropriming	7511 <sup>ab</sup>	6.40 <sup>def</sup>	1.2 <sup>bc</sup>	45.67 <sup>c</sup>	2838 <sup>a</sup>	9472 <sup>a</sup>	30b <sup>c</sup>
	SA + GA	4253 <sup>bc</sup>	6.89 <sup>d</sup>	1.1 <sup>c</sup>	45.72 <sup>c</sup>	2059 <sup>bcd</sup>	6733 <sup>bcde</sup>	31.78 <sup>bc</sup>
LSD		3497	1.4	0.175	3.53	367.9	1053	6.23

Means within each column with at least a letter in common are not significantly different at  $\alpha = 0.05$ .

with *Glomus intraradices* and *Glomus mosseae* when compared to the control (30.8 and 22.4% respectively). These results are in agreement with Mohammadi et al. (2011); Badr et al., (2013) and Kurle and Pflieger (2005). The combined effects of priming and mycorrhiza inoculation also improved grain yield and maximum grain yield was obtained from the *Glomus intraradices* and hydropriming treatment and was not significantly different from the *Glomus mosseae* and hydropriming treatment. The lowest grain yield was obtained from 100 ppm gibberellic acid combined with priming by 100

ppm salicylic acid and without applications of bio-fertilizers. Without bio-fertilizer application, maximum and minimum grain yields were obtained from the control as well as the 100 ppm gibberellic acid treatment. There were no significant differences between treatments where both *Glomus intraradices* and *Glomus mosseae* were inoculated and bio-fertilizers were applied. The highest and lowest of grain yield was related to hydropriming and control treatments, respectively (table 2). Researchers reported that priming increased yield and yield components of chickpea (Kaya et al., 2010; Azarnia and Eisvand, 2013), lentil (Ghassemi-Golezani et al., 2013) and soybean (Ghassemi-Golezani et al., 2011; Arif et al., 2014). Some researchers have reported that mycorrhiza inoculation improved yield of lentil (Mohammadi et al., 2011) pea (Badr et al., 2013) and soybean (Kurlle and Pflieger, 2005) that are compatible with our results.

#### Harvest index

All treatments significantly ( $P \leq 0.01$ ) affected harvest index (table 1). *Glomus intraradices* increased harvest index 16% when compared to the control and *Glomus mosseae* increased of harvest index by 2 % when compared to the control. Priming treatments and the combined effects of priming and Mycorrhiza inoculation improved the harvest index with the maximum being observed from the combination of *Glomus intraradices* and hydropriming. The least effect on harvest index was obtained from inoculation with *Glomus mosseae* (table 2). These results are compatible with Azarnia and Eisvand (2013) results.

#### Conclusion

In many areas of dryland farming, unfavorable conditions can inhibit germination, emergence, plant establishment and density, growth and ultimately grain yield. Priming of seeds prior to planting was shown to reduce risks in a wide range of environmental conditions. In the present study, gibberellin treatments and hydropriming at different levels of biological treatments that caused early flowering can result in a lower percentage of empty pods and higher yields. The overall beneficial effects of priming are rapid seedling emergence enabling escape from drought stress later in the growing season. Mycorrhiza inoculation reduced the days to flowering and increased podding to produce increased individual grain weight, more seeds and ultimately improved lentil yields. The results also showed that priming is a simple and useful method to enhance the yield and quality of lentils. The beneficial effects of priming can help establish better plants, create an ideal and uniform density, and improve and enhance yield of whole grains. *Glomus intraradices* was the most effective fungus used in this research. Results of this study indicated that mycorrhizas in combination with seed priming were ideal for increasing plant emergence, plant growth and seed yields.

#### References

- Anon (2009). Agricultural Statistics of Pakistan, 2008-09. Ministry of Food, Agric. and Livestock, Agri. and Livestock Division (Economic Wing), Govt. of Pakistan, Islamabad.
- Anwar MR, McKenzie BA, Hill GD (2003) Water-use efficiency and the effect of water deficits on crop growth and yield of kabuli chickpea in a cool-temperate sub humid climate. *J. Agric. Sci.*, 141: 285-301.
- Arif M, Tariq Jan M, Mian IA, Khan SA, Philip H, Harris D (2014) Evaluating the Impact of Osmopriming Varying with Polyethylene Glycol Concentrations and Durations on Soybean. *International journal of agriculture and biology*. 16(2):359–364.
- Azarnia M., Eisvand H.R. (2013). Effects of Hydro and Hormonal Priming on Yield and Yield Components of Chickpea in irrigated and rain-fed conditions. 6 (4): 1-18. (In Persian).

- Badr E.A., Wali A.M., Gehan A.A. (2013). Effect of Sowing Dates and Biofertilizer on Growth Attributes, Yield and its Components of Two Faba Bean (*Vicia faba* L.) Cultivars. *World Applied Sciences Journal* 28 (4): 494-498.
- Bradford K.J. (1986). Manipulation of seed water relations via osmotic priming to improve germination under stress conditions. *Hort. Sci.* 21: 1105–1112.
- Eisvand H.R., Azarnia M., Nazarian Firozabadi F., Sharafi R. (2011a). Effect of Priming by gibberellin and abscisic acid on emergence and some seedling physiological characters of Chickpea (*Cicer arietinum* L.) under dry and irrigated conditions. *Iranian Journal of Field Crop Science*. 42(4): 789-797. (In Persian).
- Eisvand H.R., Shahrosvand S., Zahedi B., Heidari S., Afroughe S.H. (2011b). 'Effects of hydro-priming and hormonal priming by gibberellin and salicylic acid on seed and seedling quality of carrot (*Daucus carota* var. *sativus*)'. *Iranian Journal of Plant Physiology* 1 (4): 233-239.
- FAO (2012). *FAO Year Book*. FAO Publication, (<http://faostat.fao.org/site/>).
- Iqbal M., Ashraf M. (2006). Wheat seed priming in relation to salt tolerance, growth, yield and level of free salicylic acid and polyamines. *Annals of Botany* 43(4): 250-259.
- Ghassemi-Golezani K, Farshbaf-Jafari S, Shafagh-Kolvanagh J. (2011) Seed Priming and Field Performance of Soybean (*Glycine max* L.) in Response to Water Limitation. (Available online at [www.notulaebotanicae.ro](http://www.notulaebotanicae.ro)). *Notulae Botanicae Horti Agrobotanici Cluj-Napoca*. 39(2):186-189.
- Ghassemi-Golezani K, Jabbarpour-Bonyadi Z, Shafagh-Kolvanagh J, Nikpour-Rashidabad N (2013) Effects of Water Stress and hydro-priming duration on field performance of lentil. *International Journal of Farming and Allied Sciences*. 2(21):922-925.
- Kaur S., Gupta A.K., Kaur N. (2005). Seed priming Increases Crop yield possibly by Modulating enzymes of Sucrose metabolism in chickpea. *Journal. Agronomy and Crop Science* 191: 81-87.
- Kaya M, Arif A, Tonguc M (2010) Effect of sowing dates and seed treatments on yield, some yield parameters and protein content of chickpea (*Cicer arietinum* L.). *African Journal of Biotechnology* Vol. 9(25): 3833-3839.
- Khoshkhouy M., Sheibani B., Roohani Tafazzoli A. (1999). *Gardening Principles (Principles of Garden Supplies)*. Shiraz University Press. 566 pages. (In Persian).
- Kumudini S (2002) Trials and tribulations. A review of the role of assimilate supply in soybean genetics yield improvement. *Field Crop Research*. 75, 211-222.
- Kurle J.E., Pflieger E.I. (2005). Arbuscular- mycorrhizal fungus spore population responded to conversions between low-input and conventional management practices in a corn-soybean rotation. *Agron. J.*, 56(3): 467-476.
- McDonald M.B. (2000). Seed priming, Black, M., J. D. Bewley, (Eds.), *Seed Technology and Its Biological Basis*, Sheffield Academic Press, Sheffield, UK, 287–325.
- Mohammadi M., Moghadam H., Majnon Hossini N., Ahmadi A., Khavazi K. (2011). The effect of phosphorus bio-fertilizer and chemical fertilizer on yield and yield components of two cultivar of lentil in different irrigation. *Iranian Journal of Field Crop Science*. 42 (4): 845-855. (In Persian).
- Parsa M., Bagheri A. (2008). *Pulses*. Jihad-e Daneshgahi Mashhad Publisher. (In Persian).
- Senaratna T., Touchell D., Bunn E., Dixon K. (2000). Acetyl salicylic acid (Aspirin) and salicylic acid induce multiple stress tolerance in bean and tomato plants. *Plant Growth Regulate*. 30: 157-161.
- Taylor A.G., Harman G.E. (1990). Concepts and technologies of selected seed treatments. *Ann. Rev. Phytopathol.* 28: 321–339.

Zaki R.N., Radwan T.E. (2011). Improving wheat grain yield and its quality under salinity conditions at a newly reclaimed soil by using different organic sources as soil or foliar applications. *Journal. Appl. Sciences. Res.* 7: 42-55.

## DIRECT REGENERATION POTENTIAL OF GUS TRANSFORMED ROSE (*ROSA HYBRIDA* L.)

Fataneh YARI\*

Department of Agriculture, Iranian Research Organization for Science and Technology (IROST), P.O. Box 33535111, Tehran, Iran

\* Corresponding author: fataneh.yari@gmail.com

### Abstract

Effective and successful regeneration is the critical stage of plant genetic transformation methods. Success in transgenic is paving the way to prepare novel and new desirable genotype especially in cut flowers. In order to investigate regeneration potential of GUS transformed rose plants, direct regeneration from four lines of transgenic plantlet was performed. In our study were used leaf and petiole explants from transgenic rose (*Rosa hybrida* L.), using adventitious organogenesis pathways for plant regeneration. Transgenic lines were obtained by *Agrobacterium tumefaciens*-mediated transformation of embryogenic calli. Explants were cultured on MS medium containing different concentration of (0.5, 1, 1.5 mg/L) TDZ in combination with (0, 0.05, 0.1 mg/L) IBA. Regeneration percentage, time to shoot regeneration, number of adventitious buds per explants and adventitious shoot length were noted. Shoot regeneration was observed after 35 days in most treatments. The result showed that the highest regeneration rate (87%) was obtained by leaf explants in media containing (1.5 mg/L) thidiazuron (TDZ) + (0.05 mg/L) indole-3-butyric acid (IBA) in third line. Combination of TDZ with IBA was more effective for direct regeneration. Increasing Concentration of TDZ from 0.5 to 1.5 mg/l, promotes shoots length. Present results indicate that rose genotype (different transgenic lines) and explants had significant effect on regeneration rate.

**Key words:** *Rosa hybrid*, leaf segments, direct regeneration, TDZ.

### Introduction

In recent years, cut roses are believed to be the most important decorative fresh cut flowers. They has more than 20,000 commercial cultivars, which concertedly are based on just eight wild species (Gudin, 2000). Plant biotechnology, together with conventional breeding methods, could facilitate rose improvement since resistance or tolerance to fungi pathogens, flowers shape and color, vase life and odor (Rout *et al.*, 1999; Nybom *et al.*, 2004). Nevertheless, a reliable and efficient *in vitro* culture method that results in efficient shoot development and regeneration is an essential requirement for improvement of new varieties through genetic transformation or mutagenesis (Fanourakis *et al.*, 2010; Gudin, 2000).

Although several protocols have been described in the literature for rose regeneration, development of an optimal *in vitro* culture system still remains a major challenge since it seems that genotype dependent (Bimal and Kiran, 2014; Ibrahim and Debergh, 2001; Kumar Pati *et al.*, 2004; Ozel and Arslan, 2006; Pati *et al.*, 2006). Different plant growth regulators exhibit significant roles in direct or indirect *in vitro* regeneration process. Thidiazuron (TDZ) and benzyladenine (BA) are the most frequently used cytokinins to induce regeneration, although their efficiency entirely depends on genotype, explant type and media composition (Magyar-Tábori *et al.*, 2010; Kumar Pati *et al.*, 2004; Pati *et al.*, 2006). TDZ roles have been reviewed in the regulation of morphogenetic potential, which is related to the metabolism and

action of purine-based cytokinins and auxins (Murthy *et al.*, 1998; Kou *et al.*, 2016). TDZ has been found to be more effective to stimulate shoot organogenesis and somatic embryogenesis in the most plant species including roses (Pati *et al.*, 2004; Pourhosseini *et al.*, 2013; Davies, 2013). In the other hand, different type of auxins, such as IBA, NAA, 2,4-dichlorophenoxyacetic acid (2,4-D) and newly 2,4,5-trichlorophenoxyacetic acid (2,4,5-T), have been employed in induction of direct regeneration or somatic embryogenesis in various plant species in combination with cytokinins (Pati *et al.*, 2006; Pourhosseini *et al.*, 2013; Davies, 2013).

Many review were published the regeneration pathways in roses and gave an account on *in vitro* propagation of roses, but no single method or explant type have been proved convenient to all rose varieties. Since, direct shoot regeneration in rose is highly dependent on genotype; therefore, the objective of the present study was to evaluate an *in vitro* plant regeneration system for four GUS transformed lines by studying the influence of TDZ and IBA, as a prerequisite for regeneration of roses after genetic transformation.

### Material and Methods

*Rosa hybrid* L. transgenic lines were obtained by *Agrobacterium tumefaciens*-mediated transformation of embryogenic calli (Yari, 2011). Full strength MS medium supplemented with 2% (w/v) sucrose, 0.7% (w/v) agar and different concentrations and combinations of TDZ and IBA were used for direct regeneration. The leaves and petioles of Gus Transformed explants from four different lines were transferred into glass vial containing 25 ml MS medium supplemented with different concentration of (0.5, 1, 1.5 mg/L) TDZ in combination with (0, 0.05, 0.1 mg/L) IBA (Table 1). After 35 days; regeneration percentage, time to shoot regeneration, number of adventitious buds per explants and adventitious shoot length were noted. All cultures were incubated at  $23 \pm 2^\circ\text{C}$  in a growth room on a 16/8 hour light/dark and 3,000 lux light intensity provided by cool-white fluorescent light. Noted Values represent the measuring traits per lines in 3 glass vial with 5 explants and three replicates. The statistical analysis was performed using one-way ANOVA and the significance of differences among treatment means were contrasted with Duncan at  $P < 0.05$ . The program SAS version 9.1 was used.

### Results and Discussion

Shoot regeneration began with the swelling of explants (leaves or petioles), after 35 days of culture. The shoots were multiplied by culturing them in the regeneration medium every 3 weeks intervals until shoots were developed. The Table 1 show the effect of lines on the regeneration percentage of shoots induced from leaf/ petioles of transformed roses regarding of the TDZ and IBA concentration. The shoots regeneration differed significantly among the lines evaluated. The higher percentage of shoot formation was obtained using (1.5 mg/L) thidiazuron (TDZ) + (0.05 mg/L) indole-3-butyric acid (IBA) on line 3 > line 2 > line 1 = line 4 by leaves explants. Moreover, the higher average of shoots length was obtained using line 3 > line 2 > line 4 > line 1 (Table 2). On the other hand, no significant differences were observed in the number of days to form shoots from explants (data not shown).

Table 1. Regeneration percentage of different lines

Line No.	Explants type	(0.5 mg/L) TDZ + (0 mg/L) IBA	(1 mg/L) TDZ + (0.05 mg/L) IBA	(1.5 mg/L) TDZ + (0.05 mg/L) IBA	(1.5 mg/L) TDZ + (0.1 mg/L) IBA
1	leaf	32± 0.2 <sup>f</sup>	37± 0.3 <sup>e</sup>	56± 0.6 <sup>c</sup>	48± 0.5 <sup>d</sup>
	petiole	10± 0.1 <sup>h</sup>	14± 0.2 <sup>h</sup>	24± 0.1 <sup>g</sup>	21± 0.2 <sup>h</sup>
2	leaf	37± 0.2 <sup>e</sup>	45± 0.5 <sup>d</sup>	63± 0.6 <sup>bc</sup>	54± 0.5 <sup>c</sup>
	petiole	9± 0.1 <sup>h</sup>	10± 0.1 <sup>h</sup>	21± 0.1 <sup>h</sup>	11± 0.1 <sup>h</sup>
3	leaf	46± 0.5 <sup>d</sup>	57± 0.6 <sup>c</sup>	87± 0.8 <sup>a</sup>	69± 0.7 <sup>b</sup>
	petiole	10± 0.1 <sup>h</sup>	11± 0.1 <sup>h</sup>	43± 0.4 <sup>d</sup>	23± 0.2 <sup>g</sup>
4	leaf	31± 0.2 <sup>f</sup>	37± 0.3 <sup>e</sup>	65± 0.6 <sup>bc</sup>	46± 0.5 <sup>d</sup>
	petiole	9± 0.1 <sup>h</sup>	10± 0.1 <sup>h</sup>	27± 0.2 <sup>f</sup>	14± 0.2 <sup>h</sup>

Mean ± SE Same letters within columns denote statistically equal means with the Duncan test (P < 0.05).

Independently of lines, significant differences were observed in the number of regenerated shoots among the treatments evaluated. Increasing Concentration of TDZ from 0.5 to 1.5 mg/l promotes shoots length (Table 2). In this study, TDZ and IBA played an important role in the induction of organogenic regeneration in the transgenic roses evaluated. Further, discussions on direct organogenesis in the genus *Rosa* demonstrate the preference of TDZ application in inducing shoot morphogenesis on leaf explants (Pati *et al.*, 2006; Rout *et al.*, 2006). It is well known that cytokinins stimulate plant cell division, adventitious bud formation, lateral buds growth and participate in the cell cycle (Basra, 2000; McGaw and Burch, 2013). It has been demonstrated that Adding TDZ to the medium containing BAP promoted accessory and axillary bud formation in *Rosa damascene*, due to cytokinin activity; TDZ added to the culture medium in order to improve growth attributed to the affect on the level of endogenous auxins and cytokinins, (Mamaghani *et al.*, 2010; Kou *et al.*, 2016). TDZ can be used as a substitute for both auxin and CK to promotes adventitious shoot formation indirectly from calli or directly from explants (Kou *et al.*, 2016). TDZ is an artificial plant growth regulator, which is displaying primarily CK-like activity for inducing shoots and somatic embryos, protoplasts, and flower *in vitro* (McGaw and Burch, 2013; Kou *et al.*, 2016).

Table 2. Average length of lines shoots (mm)

Line No.	Explants type	(0.5 mg/L) TDZ + (0 mg/L) IBA	(1 mg/L) TDZ + (0.05 mg/L) IBA	(1.5 mg/L) TDZ + (0.05 mg/L) IBA	(1.5 mg/L) TDZ + (0.1 mg/L) IBA
1	leaf	15± 0.02 <sup>c</sup>	15± 0.0 <sup>c</sup>	16± 0.03 <sup>b</sup>	17± 0.03 <sup>a</sup>
	petiole	10± 0.01 <sup>h</sup>	11± 0.01 <sup>g</sup>	14± 0.01 <sup>d</sup>	14± 0.02 <sup>d</sup>
2	leaf	13± 0.02 <sup>e</sup>	14± 0.02 <sup>d</sup>	17± 0.03 <sup>a</sup>	17± 0.03 <sup>a</sup>
	petiole	9± 0.01 <sup>h</sup>	10± 0.01 <sup>h</sup>	11± 0.01 <sup>g</sup>	11± 0.01 <sup>g</sup>
3	leaf	14± 0.03 <sup>d</sup>	15± 0.02 <sup>c</sup>	16± 0.03 <sup>b</sup>	17± 0.03 <sup>a</sup>
	petiole	10± 0.01 <sup>h</sup>	11± 0.01 <sup>g</sup>	12± 0.01 <sup>f</sup>	13± 0.02 <sup>e</sup>
4	leaf	13± 0.02 <sup>e</sup>	14± 0.02 <sup>d</sup>	14± 0.02 <sup>d</sup>	15± 0.02 <sup>c</sup>
	petiole	9± 0.01 <sup>h</sup>	11± 0.01 <sup>g</sup>	12± 0.01 <sup>f</sup>	12± 0.01 <sup>f</sup>

Mean ± SE Same letters within columns denote statistically equal means with the Duncan test (P < 0.05).

In this sense, there are few reports about the biochemical or genetic mechanisms underlying how cells acquire regeneration competence following induction by TDZ. TDZ shows CK<sup>1</sup>

<sup>1</sup> Cytokinins

activity in bioassays that is a highly stable compound. Previous researches have suggested that TDZ can modify the metabolism of endogenous CK, or mimic an auxin response. Recently Kou *et al.* (2016) reported that the application of TDZ promoted the accumulation of IAA and a Z-type CK, ZR<sup>2</sup> but reduced the level of an iP-type CK, iPA<sup>3</sup> in *Rosa canina* L.

Our results suggest that TDZ, in combination with IBA, improves the process of direct organogenesis. Some explanations for this are possible. One possibility is that TDZ acts as a precursor for natural cytokinin synthesis or enhances natural cytokinin biosynthesis; another possibility is that TDZ acts as a synergist of cytokinins.

In contrast to our results, (Canli, 2003) reported that the application of TDZ at different concentrations did not produce shoot regeneration from leaf explants of chimera *Rosa multiflora*. Such contrasting results could be due to differences in cultivars, physiological state of explants and the type of explants. Regeneration protocols using different explants of *Rosa hybrid* L. have been reported; which infer regeneration and multiplication through organogenesis or somatic embryogenesis (Pati *et al.*, 2006). Although a few reports have been noted on direct regeneration of adventitious buds in *Rosa*. These reports indicate that shoot regeneration response in the genus *Rosa* has been obtained from roots, leaves, leaflets and petioles (Bimal and Kiran, 2014; Mamaghani *et al.*, 2010; Pati *et al.*, 2006; Debener and Hibrand-Saint Oyant, 2009; Ginova *et al.*, 2012). Many factors induce forming new bud/shoots via organogenesis, but it has been demonstrated that regenerative capacity and response to growth conditions is species and genotype dependent as reported in genus *Rosa* (Ozel and Arslan, 2006; Pati *et al.*, 2006; Rout *et al.*, 2006; Bimal and Kiran, 2014).

### Conclusions

Our results confirmed earlier observations that the genotype influences the regeneration process via organogenesis in the roses (Yari, 2011). The genotype effects suggest that genetic factors are important in the response to *in vitro* tissue culture. In this sense, due to the increasing genetic variability in modern rose cultivars, the composition of the shoot induction medium is important in the regeneration process through organogenesis. Therefore, understanding the genotype effect and how these can be minimized is critical for successful *in vitro* culture. This *in vitro* protocol reported could be used for direct regeneration to obtain competent target tissue for genetic modification or for proliferation of transgenic plantlets

### References

- Basra, A. (2000). Plant growth regulators in agriculture and horticulture: their role and commercial uses. CRC Press.
- Bimal, R. & Kiran, N. (2014). In Vitro Flower Bud Formation, Plant Regeneration and Morphogenetic Studies in Local Scented Cultivar of *Rosa indica*. *Journal of Ornamental & Horticultural Plants* 4(1): 9-18.
- Canli, F. A. (2003). Effects of dark and TDZ on callus formation of rose leaf explants. *Pakistan Journal of Biological Sciences* 6(19): 1672-1674.
- Davies, P. (2013). Plant hormones: physiology, biochemistry and molecular biology. Springer Science & Business Media, 98-117.
- Debener, T. & Hibrand-Saint Oyant, L. (2009). Genetic engineering and tissue culture of roses. In *Genetics and Genomics of Rosaceae*, 393-409: Springer.

---

<sup>2</sup> zeatin riboside (ZR)

<sup>3</sup> Ribosides isopentenyladenosine (iPA)



- Fanourakis, D., Carvalho, D., Gitonga, V., Van Heusden, A., Almeida, D., Heuvelink, E. & Carvalho, S. M. (2010). Breeding cut roses for better keeping quality: first steps. In XXVIII International Horticultural Congress on Science and Horticulture for People (IHC2010): International Symposium on 937, 875-882.
- Ginova, A., AgroBioInstitute, S. B., Tsvetkov, I. & Kondakova, V. (2012). *Rosa damascena* Mill.-an overview for evaluation of propagation methods. *Bulgarian Journal of Agricultural Science (Bulgaria)* 18(4): 545-556.
- Gudin, S. (2000). Rose: genetics and breeding. *Plant breeding reviews* 17: 159-190.
- Ibrahim, R. & Debergh, P. C. (2001). Factors controlling high efficiency adventitious bud formation and plant regeneration from in vitro leaf explants of roses (*Rosa hybrida* L.). *Scientia Horticulturae* 88(1): 41-57.
- Kou, Y., Yuan, C., Zhao, Q., Liu, G., Nie, J., Ma, Z., Cheng, C., da Silva, J. A. T. & Zhao, L. (2016). Thidiazuron Triggers Morphogenesis in *Rosa canina* L. Protocorm-Like Bodies by Changing Incipient Cell Fate. *Frontiers in plant science* 7(557): 1-13.
- Kumar Pati, P., Sharma, M., Sood, A. & Ahuja, P. S. (2004). Direct shoot regeneration from leaf explants of *Rosa damascena* Mill. *In Vitro Cellular and Developmental Biology-Plant* 40(2): 192-195.
- Magyar-Tábori, K., Dobránszki, J., da Silva, J. A. T., Bulley, S. M. & Hudák, I. (2010). The role of cytokinins in shoot organogenesis in apple. *Plant Cell, Tissue and Organ Culture (PCTOC)* 101(3): 251-267.
- Mamaghani, B. A., Ghorbanli, M., Assareh, M. H. & Zare, A. G. (2010). In vitro propagation of three Damask Roses accessions. *Iranian Journal of Plant Physiology* 1(2): 85-94.
- McGaw, B. A. & Burch, L. R. (2013). *Plant hormones: physiology, biochemistry and molecular biology*. Springer Science & Business Media.
- Murthy, B., Murch, S. & Saxena, P. K. (1998). Thidiazuron: A potent regulator of in vitro plant morphogenesis. *In Vitro Cellular & Developmental Biology-Plant*, 34(4): 267.
- Nybom, H., Werlemark, G., Esselink, D. G. & Vosman, B. (2004). Sexual preferences linked to rose taxonomy and cytology. In I International Rose Hip Conference 690, 21-28.
- Ozel, C. A. & Arslan, O. (2006). Efficient micropropagation of English shrub rose “Heritage” under in vitro condition. *International Journal of Agricultural and Biological Engineering* 8(5): 626-629.
- Pati, P., Sharma, M., Sood, A. & Ahuja, P. (2004). Direct regeneration from leaf in *Rosa damascena* Mill 40(2), 192-195.
- Pati, P. K., Rath, S. P., Sharma, M., Sood, A. & Ahuja, P. S. (2006). In vitro propagation of rose—a review. *Biotechnology advances* 24(1): 94-114.
- Pourhosseini, L., Kermani, M. J., Habashi, A. A. & Khalighi, A. (2013). Efficiency of direct and indirect shoot organogenesis in different genotypes of *Rosa hybrida*. *Plant Cell, Tissue and Organ Culture (PCTOC)* 112(1): 101-108.
- Rout, G., Mohapatra, A. & Jain, S. M. (2006). Tissue culture of ornamental pot plant: A critical review on present scenario and future prospects. *Biotechnology advances* 24(6): 531-560.
- Rout, G., Samantaray, S., Mottley, J. & Das, P. (1999). Biotechnology of the rose: a review of recent progress. *Scientia Horticulturae* 81(3): 201-228.
- Yari, F. (2011). Optimization of transformation, regeneration and gene transfer to delay senescence in cut flower roses. In Department of Horticultural Science, Vol. PhD Thesis, 141, Karaj, Iran: University of Tehran.

## **EFFECT OF PLANT GROWTH REGULATORS AND PLANTS DENSITY ON YIELD AND YIELD COMPONENTS OF TWO POTATO CULTIVARS**

Hashem ASGHARI\*, Mohammadali ABOUTALEBIAN

Department of Agronomy and Plant Breeding , Faculty of Agriculture Bu-Ali Sina University of Hamedan , Iran

\*Corresponding author: hashemasghari.savin@gmail.com

### **Abstract**

In order to study the effect of plant growth regulators IAA, GA3 and PLANTS density on yield and yield components of two potato varieties was done. This experiment was carried out in Savin tissue culture laboratory and greenhouse in 2014 seasons. The experiment was factorial based on randomized complete bloke design with the replication separately. In this experiment variety in two stages (Jelly, Banba), effect of density in three stages (100, 150, 200) plants per square meter and growth regulators in four levels (IAA, GA3, IAA+GA3 and control). The results showed that hormone therapy increased the plant height. Combination therapy (IAA+GA3) had the greatest height. Banba cultivar of this treatment have shown greater response. Plants treated with combination therapy regulators with a density of 200 plants per square meter had the highest leaf area. There was no significant difference. Characteristic traits were identified for stolon and sub-stolones. The highest number of tuber was related to combination therapy regulators. There was no significant difference between IAA and GA3. The results showed the maximum length for stolen the type Banba 100 plants per square meter. Combination therapy with regulator & minimum length is for jelly (150-200 ps). No significant difference was between hormone consumed. Plants treated with regulators, respectively shows 30-55-35% increase in plant height, leaf area index for length of stolen compared to the control sample in addition, an increase of 44-66-38 per cent of the number of stolen and sub-stolen and number of tuber per plant can be seen. So consumption regulator of with influence on morphological traits and yield components that affect performance running effective economic performance.

**Keywords:** *Potato, Growth Regulator, IAA, GA3, Greenhouse.*

### **Introduction**

Potato is the fourth biggest crop of the world after Asia, especially in the developing countries like wheat, rice and maize (Nipa, 2013). Potato originated in the Andes of South America ( Hawkes, 1992) where it was cultivated mostly at altitudes between 2000, and 4000 m in a region characterized by short daylength, high light intensity, cool temperatures and relatively high humidity. From there, the potato was introduced to Europe, where the long photoperiod inhibited tuber formation. The most significant change that subsequently allowed higher tuber yields in Europe was selection against the obligatory demand of short photoperiod for tuber initiation and growth. The long days and moderate temperatures of the temperate regions of Europe allowed longer periods of photosynthesis, efficient translocation of assimilates from haulm to tubers and low transpiration rates during the cool nights. By 1800, the potato was widely grown in Europe and became an important staple due to its high yielding capacity and highly nutritious qualities (Salaman, 1949). From Europe, the potato spread to much of the rest of the world during the 18th and 19th centuries over the last few decades (Simmonds, 1971; International potato Center, 1984). Potato is now a worldwide crop grown under many

climatic conditions. The highest average yields are obtained in regions with moderate climate, such as northern United States and northwestern Europe, where potato is grown under long days, moderate temperatures and modern cultivation methods. Tuber productivity of good seed tubers in potatoes relies on factors like; day length, temperature, physiological age of seed tubers, plant density, nitrogen, water supplying, and finally growth regulating materials or plant growth regulators (PGR) (Gregory, 1965). Plant growth regulators (PGR) have considerable effects on tuber fertility and it is highly related to hormonal balance (Stuart and Cathey, 1961; Vreugdenhil and Struik, 2006). Auxins are shown many characteristics features such as polar translocation, root and shoot growth, root induction, delay in abscission and differentiation of xylem elements (Ahmed et al 2011). PGRs are involved in initial hormone binding and activating the genes of meristematic cells by altering the secondary and tertiary messengers of a cellular cascade. Several PGRs can influence the growth and development; a particular response probably results from a changing ratio of hormones rather than from the presence or absence of an individual hormone (Suri et al., 1995). Perhaps, PGRs may indirectly control gene expression through biosynthetic pathway enzymes and messengers by acting during transcription, mRNA processing, mRNA stability, and at translational and post-translational modifications (George et al., 2007). The regulator of the Group of auxin IAA in plants causes high increases stem height and leaf area (Evans, 2003). Xu et al. (1998) indicated that GA is a dominant regulator in tuber formation and promoted stolon elongation and inhibited tuber formation. Timm et al. (1962) treated dormant or sprouted seed potatoes with various concentrations of gibberellic acid and indicated that emergence of plants from treated seed was more rapid than from untreated seed. Wareing and Jennings (1980) proved that the growth of secondary buds in potato stolons, has been intrigued and this phenomenon should predominate final dominance. Racca and Tizio (1968) found that before tuberization the shoots contained large quantities of gibberellin-like substances which decreased after tuberization and it is suggested that these substances are of importance in the control of tuberization. Also, GA3 leads to smaller tubers resulting in increased bud numbers and stolons by removing of apical dominance. Foliar application of GA3 (5 and 10 ppm) increased the length of stems and stolons, and decreased the tuber fertility, but causes elongation of the stolons (Burton 1989; Chapman, 2006). GA3 is the regulator of Gibberellin groups that can break through the apical dominance in potato tubers, to increase the number of stolons in plants. In this study, density and plant growth regulators indole acetic acid and gibberellic acid were studied on yield and yield components of two cultivars of potato cultivars Jelly and Banba under greenhouse conditions.

### **Material and methods**

The study was conducted in the fall of 2014 at Savin tissue culture center located in Hamedan for triple factorial randomized complete block design with three replications factor. The first factor involves the use of growth regulators in four levels (indole acetic acid, the use of gibberellic acid, the use of combined growth regulator and the lack of them), the second factor density at three levels, including 150, 100 and 200 plants per square meter and the third factor involves two stages (Jelly, Banba). That their initial plantlets were prepared from Isfahan biotechnology Institute And with using MS medium, single node cuttings were propagated in the center of the tissue culture medium plants (Murashige & Skoog, 1962). Each test includes a piece, with a width of 130 cm and a length of 80 cm. substrates of sand was used and for the disinfection of hydrogen peroxide H<sub>2</sub>O<sub>2</sub>. Nutrition of testing units was carried out in the form of hydroponics that include all of macro and micro elements according to the CIP recommendation and after the cultivation were treated in the same way. The plantlets were in a growth chamber for 30 days with 60 mol m<sup>-2</sup> s<sup>-1</sup> light intensity and temperature 22± 1 ° C. For

ambient light from fluorescent lamps to 16 hours of light and 8 hours of darkness were used. transfer operation was performed after reproduce and prepare the conditions for growing plantlets in the greenhouse,. Then for the desired density, distances between plants and rows planted to a density of just under 100, 150 and 200 plants per square meter were taken into consideration. To do this 10 x 10 cm (distance between plants and rows) for a density of 100 plants per square meter and are 6.6 x 10 cm to 150 plant square meters and a distance of 5 x 10 cm Density 200 plants per square meter was considered. After the transfer operations and cultivate seedlings to adapt to greenhouse conditions for 8 to 10 days of clear plastic stretched over the row, and then was removed from the mentioned period (Haghtalab, 2006). Growth regulators for foliar treatment was performed. Spraying indole acetic acid( IAA) was done at a concentration of 50 ppm for 20 and 30 days after planting and spraying gibberellic acid( GA3) at a concentration of 50 ppm for 60 and 70 days after planting. For plots to use a hand sprayer and spray it on other plots to prevent a protective spray was used at the time. To determine the trend of leaf area index and seedling establishment after the first sampling interval was 14 days. Plant height was measured 60 days after planting. The following regression equation for charting changes during the growth period and calculates the maximum leaf area index (LAI) was used. Greenhouse ambient temperature range of  $20 \pm 5$  ° C during the period of the experiment, light intensity was of ,650 -1,300mol m per second between sodium lamps canopy for just 8 hours of light and 16 hours darkness was applied. Shoots were removed during 100 days and were harvested two weeks later. Desired traits such as number of stolons, stolon length, number of branches and number of tubers per plant was measured. Software SAS was used for data analysis and for comparison of the least significant difference test was used at the 5% level.

### **Results and Discussion**

Based on analysis of variance, plant height were compared by one percentage point by the main effects and interactions and growth regulators. Banba cultivar is higher than the Jelly genetically and both varieties showed significant response to indole acetic acid and combined application of plant growth regulators and showed an increase of 31% compared with control samples. These results correspond with the results of Aksenova (2001). It seems that the probability of no response to GA3 is related to the time of use of both varieties. Bodlaender (1989), used different concentrations of gibberellic acid in different growth stages of potato on the foliage and concluded that the usage of GA3 increased the length of the stem and stolom, and reduced the glandularity. But the usege of the regulator during the growth of stolons, increased the formation of the first growths and tubers with a diameter of 45-28 mm. According to the results of the analysis of variance of plant height were affected by a percent density, so that the plant height increased with increasing density. In this study, the maximum height is related to the density of 200 plants per square meter. It seems the reason is the increasing in intra-specific competition . Also Sarkar et al,( 1997) examined the effect of seedling planting density in the micropropagation of two potato cultivars and seedling reported that the highest density were highest during the shoot, there were significant differences between the varieties of potato. Most LAI maximum is related to the jelly and Banba with 200 plants per square meter and in combination IAA and GA3, which increased by 55% compared with control samples and no significant difference between two cultivars in this density. There is a significant difference between the jelly and the Banba at 150 plant per square meter and has more leaf area index (LAI) lowest ( LAI) related to the jelly on with a density of 100 plants per square meter in control samples and there was no significant between the control and use of GA3. The result of findings (2000 Boozina,) announced that IAA increased leaf area to be coordinated. The trend of leaf area index showed that plant growth regulators treated with combination therapy earlier than other treatments reached the

maximum leaf area index. Comparisons between plants treated with GA3 and control samples show no significant difference in maximum leaf area index between them, but it has been reported that the use of GA3 delay the aging leaves (Evans, 2003). The trend of (LAI) plants treated with IAA also shows speed increased leaf area index was higher in ranged from 40 to 60 days after planting compared to the control (no growth regulator). IAA has been reported to slow the decline leaves (Evans, 2003). The number of stolons treated plants was evaluated. Studies show heads the largest number of stolons in both cultivars were obtained with combination therapy indole acetic acid and GA3 and compared with control samples increased 44 percent and the lowest was observed cv Jelly and in terms of consumption growth regulators. . There was no significant difference between taking two hormone GA3 and IAA individually about the number of stolons but significant differences were observed between consumption and avoiding the use of a percent. The combination of these two regulators growth-boosting effect on the 24 percent increase in the number of stolons per plant compared to the separate use of each of the two regulators IAA and GA3. These results are consistent with the findings of Kumar et al (1979) which had announced combination, IAA, GA3 and cytokinin on growth stolons, tuber formation and yield of potatoes is effective and enhances them and corresponded with the results Dehitall (2004) report the application of auxin increased the number of stolons and leads to an increase in the number of tubers. The largest number of stolons branch of the Banba with concomitant administration of IAA and GA3, but no significant difference in the situation with the Jelly compared to control 66 per cent is the lowest number of stolons branch of the Banba in the control sample. Haghtalab (2006) declared regulators BAP and GA3 increases the number of stolons radiating the stage stolons formation, the findings of this study are consistent. Also Biemelt et al (2000) reported the use of GA3 at the stage of tuber formation the number of branching stolons very impressive and confirms these results. Analysis of variance showed that the number of tubers per plant was affected by the main effects and interaction between cultivar, regulator and density. Banba with combined consumption figure is the highest number of tubers per plant regulators, which is a 38% increase compared to the control sample. The results show significant differences between the figures can be seen in terms of production potential. Between the growth regulators also showed a significant difference in their combination with other treatments. Among the different densities the density of 100 plants per square meter has the largest number of tubers per plant. The results of this study with the results Shaterian & Niamanesh (2003) that reported consumption regulators to increase number of tuber per plant and the number of tubers production per plant gradually decreases with increasing plant density is consistent. Due to the low rate of reproduction at high density. Also Karafyllidis et al , (2006) reported an increase in the density of the resulting tubers and increased yield per unit area, but tuber size and yield per plant is reduced.

### **Conclusions**

According to the results Banba has the height and leaf area index is greater than furtive. Increasing plant density and mixed use growth regulators led to an increase in both the number and height of leaf area index. Simultaneous use of growth regulators to increase the number of stolons of both varieties, but the number of branching stolons with IAA consumption increased only in the Banba cultivar. The total number of tubers for seed production as well as the number of tuber size combined with the use of growth regulators increased significantly for both varieties. Therefore, in general, can be recommended to increase the number of tubers with 150 plant growth regulators, particularly in the Banba used per square meter.

## References

- A. B. A. Ahmed, R. Pallela, A. S. Rao, M. V. Rao, R. M. Taha, *Spanish J Agricult Res.* 9 (2011) 1262-1270.
- Aksenova, N. P. (2001). Effect of IAA and kinetin on tuberization parameters of different cultivars and transgenic lines of potato in vitro. Institute of Plant Physiology. Russian Academy. pp184-191.
- Biemelt, S. & Sonnewald, U. (2000). Manipulation of gibberellic biosynthesis in potato plant. *Plant Biology Journal*, 22: 144-145.
- Burton WG (1989). *The potato*. Third edition, John Wiley and Sons, Inc New York, NY. P. 742.
- Bodlaender, K. BA. & Waderzag, V. M. (1989). Influence of gibberellic acid (GA<sub>3</sub>) applied to the crop on growth yield and tuber size distribution of seed potatoes. *Netherlands Journal of Agricultural Science*, 37:3,185-196
- Boozina, S.A. (2000). Carrier mediated auxin transport. *Planta*, 118:101-
- Chapman HW (2006) Tuberization in the potato plant. *Physiologia Plantarum* 11(2):215-224. 1.
- Dehital, G. J. (2004). Action of abscisic acid on guard cell. In *Stomatal Function* eds., E Zeiger, G. D. Farquhar & I. R. Cowan, Stanford University Press, Stanford, CA, 253-270.
- Evans, M. R. (2003). *Plant Growth Regulators*. Greenhouse Management. Prentice Hall, P:437.
- Gregory LE (1965) Physiology of tuberization in potato plants. *Plant Physiol.* 15:1328-1354.
- Haghtalab, Z. (2006). The effect of concentration and application time of GA<sub>3</sub>, BAP and CCC on some growth characteristics and yield of potato mini-tuber under greenhouse conditions. M.Sc. Thesis. Faculty of Agriculture Azad university of Arak. (In Farsi)
- Karafyllidis, D. I., Georgakis, D. N., Stavropoulos, N. I., Nianiou, E. X. & Vezyroglou, I. A. (2006). Effect of planting density and size of potato seed mini tubers on their yielding capacity. *ISHS Acta Horticulturae*, 462, 253-254.
- Kumar, P., Bajjal, B. D. (1979). Combined effects of seed tuber and growth regulators on stolon development and tuberization of the potato. *Seed Research*, 7(2), 107-113.
- M. M. George, A. Thomas, M. M. Mathew, *Plant Cell Biotechnol Mol Biol.* 8 (2007) 187-192.
- Murashige, T. & Skoog, F. (1962). A revised medium for rapid growth and bioassays with tobacco tissue cultures. *Physiologia Plantarum*, 15, 473-497.
- Nipa J, Roy T, Amin A and Hasanuzzaman M. 2013. Effect of Lifting Time and Tuber Size on Ambient Storage Performance of Potato Derived from True Potato Seed. *International Journal of Sustainable Agriculture* 5(1):1-9.
- Racca RW, Tizio R (1968). A preliminary study of changes in the content of gibberellins-like substances in the potato plant in relation to the tuberization mechanism. *Potato Res.* 11(4):213-220.
- S. S. Suri, K. G. Ramawat, *Ann Bot.* 75 (1995) 477-480
- Salaman RN. 1949. *The History and Social Influence of the potato*. Cambridge University Press, London.
- Sarkar, D. P. S, Naik and R. Chandrand. (1997). Effect of inoculation density on potato micropropagation. *Plant cell, tissue and organ culture*, 48, 63-66.
- Simmonds NW. 1971. The potential of potatoes in the tropics. *Trop Agric* 48:291-299
- Shaterian, J. and Niamanesh, H. (2003). *Seed Potato Technology* (1th ed.). University of Tehran. (In Farsi).

- Stuart NW, Cathey HM (1961). Applied aspect of Gibberellins in potato. *Plant Physiol.* 12:369-378.
- Timm H, Rappaport L, Bishop JC, Hoyle BJ (1962). Sprouting, plant growth, and tuber production as affected by chemical treatment of white potato seed pieces. *Am. J. Potato Res.* 39(3):107-115.
- Vreugdenhil D, Struik PC (2006). An integrated view of the hormonal regulation of tuber formation in potato (*Solanum tuberosum* L.). *Physiologia Plantarum* 75(4):525-531
- Xu X, Vreugdenhil D, van Lammeren AAM (1998). Cell division and cell enlargement during potato tuber formation: a comparison of in vitro and in vivo tuber development. *J. Exp. Bot.* 49:573–582.

## ESTIMATION OF COMBINING ABILITY AND GENE ACTION FOR GRAIN AND OIL YIELD IN RAPESEED (*BRASSICA NAPUS* L.) USING THE LINE BY TESTER METHOD

Mahdieh ARSHADI<sup>1</sup>, Mohammad Hossein FOTOKIAN<sup>1,\*</sup>, Hassan AMIRI OGHAN<sup>2</sup>,  
Bahram ALIZADEH<sup>2</sup>

<sup>1</sup>College of Agriculture, Shahed University, Tehran, Iran

<sup>2</sup>Seed and Plant Improvement Institute, Karaj, Iran

\*Corresponding Author: fotokian@shahed.ac.ir

### Abstract

In order to estimate the combining ability, genetic variance components and heritability of traits related to rapeseed (*Brassica napus* L.) grain oil yield, an experiment was designed using the line×tester method. Fifteen hybrids derived from crosses of three spring and high yielding testers (SPN34, RGS003, SPN1), with five lines specific to a hot climate (SPN3, SPN9, SPN36, SPN30, DH4) were tested using a randomized complete blocks design with two replications at the Seed and Plant Improvement Institute in Karaj (Iran) during 2014-2015. The traits under study included: grain yield, biological yield, harvest index, 1000-grain weight, the percentage of oil, and oil yield. The difference among hybrids was significant for all traits, which was a reason for the presence of high genetic diversity among hybrids. The value of additive variance was higher than the dominant type for all traits. The additive variance was important in controlling the 1000-grain weight and biological yield, but for the rest of the traits, two components of variance were included with different values. Referring to high broad-sense heritability (89.84%-98.26%) and low differences between phenotypic and genotypic coefficients of variation, it was concluded that the role of genetical variance was more important than the phenotypic one. The values of narrow-sense heritability were different, from 55.77% of oil yield to 88.67% for 1000-grain weight. Among the tester and the lines, SPN1 as a tester and DH4 and SPN30 as lines were most combinatorial for grain yield and oil yield. In addition, DH4×SPN1, SPN36×RGS003 hybrids were distinguished as the best hybrids and, so it was advised to use their parents in the production of hybrid varieties by using the male sterility system.

**Keywords:** rapeseed, yield components, heritability, combining ability, variation, yield.

### Introduction

Yield as a complex trait with polygene inheritance is influenced by various quantitative traits. By being aware of the mode of genetics control and heritability of yield components, we are able to choose the best breeding methods to improve yield. Breeders estimate trait controlling genetic components in plant populations using different crossing designs. In order to evaluate combining abilities and also to estimate phenotypic variance components, line×tester method has been used especially in the cultivation of plants like rapeseed (Ashraf and Neilly, 2004). In most cases, the additive effect of genes was more important, but the dominant effect of genes was also intervened in the controlling of traits (Roy and Basu, 2009). Amiri-Oghan (2000), by studying F<sub>2</sub> genotypes in rapeseed, showed that the role of the additive and non-additive effect of genes are equal in the genetic control of grain yield. Whereas, for oil yield, the non-additive effect of genes was highly important in the controlling of this trait. The non-additive gene action for grain yield in rapeseed controlling was reported by Thukral and Singh



(1987). In a report by Thakur and Sagwal (1997), traits like yield and its components and the percent of oil were under control of both additive and non-additive genes. Low narrow-sense heritability of grain yield and the percent of grain oil was reported in a study on F1 and F2 populations of rapeseed trials conducted at different locations and years (Brown *et al.*, 1996). In addition, Malik *et al.* (1995) studied the inheritance of grain yield, and they understood that the heritability for grain yield is low. The high estimation of narrow-sense heritability of grain oil in winter rapeseed was reported by Wu *et al.* (2006) as well as Malik *et al.* (1995). Jeromela *et al.* (2007) investigated the general combining ability (GCA) and specific combining ability (SCA) in diallel crosses with five rapeseed. The effect of GCA was statistically significant for all traits, with exception of grain yield.

The aim of this research was to obtain information pertaining to genetic diversity, effect/mode of actions of genes, heritability, and combining ability for grain yield and oil yield in rapeseed.

### **Materials and Methods**

This experiment was performed in Karaj Seed and Plant Cultivation and Registration Institute of Iran. In this research, 15 spring hybrids derived from the crosses between 5 lines adopted for Iran warm climate (SPN3, SPN9, SPN36, SPN30, DH4) and 3 testers (SPN34, RGS003, SPN1) were evaluated through randomized complete block design with two replications. The traits included grain yield, biological yield, harvest index, 1000-grain weight, percent of oil and oil yield were measured by a random sample of 5 competition plants. The percent of the oil was measured by Nuclear Magnetic Resonance Spectrometry (NMR) is used for determining the percent of oil.

For statistical analysis, line×tester method was used (Kempthorne, 1957). In order to calculate genetic variance components, refer to the homogeneity of genotypes and use of F1 generation, inbreeding coefficient equal to one was used. The mode of gene action was determined by the ratio of GCA mean of the square ( $S^2_{GCA}$ ) to SCA mean of the square ( $S^2_{SCA}$ ). The mean of dominant degree is obtained from the square root of double dominance variance divide to additive variance.

### **Results and Discussion**

The differences among lines were statistically significant for all traits, as well as among tester with exception of the percent of grain oil and harvest index. This finding indicated that diversity among lines is more than among testers for the percent of grain oil and harvest index. The significant difference among the tester as well as lines for different traits is an indicator for controlling traits by additive effects of genes. In plant breeding, selection for traits under control of additive genetic effects is confidential and consequently, transfer of such traits to next generation is more feasible. The line×tester effects were significant for all traits, with exception of the 1000-grain weight seeds, showing the varied reaction of different lines in combination with different testers. This is a reason for the superiority of non-additive genetic effects in controlling the mentioned traits (tab. 1).

Table 1: Variance analysis of studied traits for 15 spring hybrids derived from the crosses between 5 lines of Iranian rapeseed for line×tester analysis.

S.O.V	df	Mean Squares (MS)					
		1000-grain weight	Oil Percent	Biologic Yield	Harvest index	Grain Yield	Oil Yield
Block	1	0.03 <sup>ns</sup>	0.01 <sup>ns</sup>	5740.83 <sup>ns</sup>	112.74 <sup>**</sup>	7363.33 <sup>*</sup>	13.51 <sup>ns</sup>
Line	4	0.30 <sup>**</sup>	2.32 <sup>**</sup>	39041.67 <sup>**</sup>	204.37 <sup>**</sup>	6695.00 <sup>*</sup>	12.29 <sup>*</sup>
Tester	2	0.87 <sup>**</sup>	0.44 <sup>ns</sup>	57857.50 <sup>**</sup>	13.01 <sup>ns</sup>	17203.33 <sup>**</sup>	29.82 <sup>**</sup>
Line×Tester	8	0.11 <sup>ns</sup>	1.74 <sup>*</sup>	25874.17 <sup>**</sup>	182.84 <sup>**</sup>	12707.50 <sup>**</sup>	24.09 <sup>**</sup>
Error	14	0.05	0.44	5458.69	7.81	1577.62	2.95

ns, \* and \*\*: Non-significant and significant at 0.05 and 0.01 probability.

Genetic variance was separated into additive and dominance variances for all traits (tab. 2). The value of additive variance was higher than the dominant one for studied traits. Broad-sense heritability of traits was relatively high, varied from 89.48% for oil percent to 98.26% for harvest index. In this regard, it can be stated that environmental variance was extremely low and the importance of genetic variance was higher than environmental variance. However, due to conducting the test in one year, some part of the genetic variance probably is due to the variance from the interaction between the genotypes with the environment. The percent of narrow-sense heritability was higher than average for all traits, being between 55.77% for oil yield and 88.76% for the 1000-grain weight (tab. 3). Amiri-Oghan *et al.* (2010) reported high broad-sense heritability for yield-related traits by line×tester analysis, while the value of narrow-sense heritability for most traits was intermediate.

Table 2: Estimation of genetic variance, the average degree of dominance, heritability, and coefficients of variation for 15 spring hybrids derived from the crosses between 5 lines of Iranian rapeseed.

Genetic statistic	1000-grain weight	Oil Percent	Biologic Yield	Harvest index	Grain Yield	Oil Yield
V <sub>A</sub>	0.44	1.25	3985.92	132.78	8620.16	15.18
V <sub>D</sub>	0.03	0.65	10207.74	87.52	5564.94	10.57
(2V <sub>D</sub> /V <sub>A</sub> ) <sup>0.5</sup>	0.37	1.02	0.71	1.15	1.14	1.18
h <sup>2</sup> <sub>B</sub>	94.92	89.48	94.93	98.26	94.73	94.58
h <sup>2</sup> <sub>N</sub>	88.76	58.86	75.49	59.22	57.57	55.77
V <sub>G</sub>	0.47	1.89	50062.66	220.29	14185.10	25.75
V <sub>P</sub>	0.49	2.12	52791.66	224.20	14973.91	27.23
GCV	18.82	3.23	54.24	28.24	55.74	55.66
PCV	19.32	3.42	55.70	28.49	57.27	57.23
S <sup>2</sup> <sub>GCA</sub>	0.22	0.62	19927.46	66.39	4310.08	7.59
S <sup>2</sup> <sub>SCA</sub>	0.03	0.65	10207.74	87.52	5564.94	10.57
S <sup>2</sup> <sub>GCA</sub> /S <sup>2</sup> <sub>SCA</sub>	7.21	0.96	1.95	0.76	0.77	0.72

V<sub>A</sub>: additive variance, V<sub>D</sub>: dominance variance, (2V<sub>D</sub>/V<sub>A</sub>)<sup>0.5</sup>: average degree of dominance, h<sup>2</sup><sub>B</sub>: broad sense heritability, h<sup>2</sup><sub>N</sub>: narrow sense heritability, V<sub>G</sub>: genotypic variance, V<sub>P</sub>: phenotypic variance, GCV: genotypic coefficient of variation, PCV: phenotypic coefficient of variation, S<sup>2</sup><sub>GCA</sub>/S<sup>2</sup><sub>SCA</sub>: The ratio of GCA variance to SCA variance.

The phenotypic coefficient of variation (PCV) was higher than the genotypic coefficient of variation (GCV) for all investigated traits, although the differences between them were relatively low, an indication of slight effects of the environment. The higher value of GCV was pertained to grain yield and oil yield, while the percent of oil had the lowest GCV (Table

2). Esmaeili *et al.* (2015) regarded the higher value of GCV to oil yield and then to grain yield, conforming to the results of this research.

In the estimation of gene action, if the rate of  $S^2_{GCA} / S^2_{SCA}$  is higher than one, it shows the important role of additive genetic variance in controlling of the trait, and if it is lower than one, it reveals non-additive genetic variance. In this experiment, the role of additive genetic variance was more significant than the non-additive genetic variance in order to estimate the 1000-grain weight and biologic yield (tab. 2). The results of this experiment is conformed to the results of Gholami and Moghaddam (2006), Tekelwold and Becker (2005), Qureshi *et al.* (2017) in concerning the 1000-grain weight, Gholami and Moghaddam (2006), Satwinder *et al.* (2000) and Ahmadi and Sameezadeh (2006) on the percent of oil, as well as Ahmadi and Sameezadeh (2006), Satwinder *et al.*, (2000), Singh *et al.*, (2002), Varsha *et al.*, (1999) for grain yield.

The average degree of dominance for traits was varied from 0.37 for the 1000-grain weight to 1.18 for oil yield (tab. 2). The higher and lower average degree of dominance to one, shows over-dominance and relative dominance of genes action, respectively. The average degree of dominance higher than one in traits including oil percent, harvest index, grain yield and oil yield, emphasizing the dominance action of genes controlling these traits. But given that dominance genetic variance is lower than additive genetic variance, the over-dominance action of genes can be false and due to the accumulation of incomplete dominance and/or linkage of genes (Amiri-Oghan, 2000). In a research on rapeseed by Gholami *et al.* (2008) using line×tester analysis, the average degree of dominance for grain yield was estimated more than one, which represents the over-dominance gene action and also the important role of non-additive action of genes in the genetic control of this trait. This finding was consistent with the result of our research.

Table 3: Estimation of general combining ability (GCA) for lines and testers of Rapeseed.

	Rapeseed genotypes	1000-grain weight(g)	Oil Percent (%)	Biologic Yield (g)	Harvest index (%)	Grain Yield (g)	Oil Yield (g.plot <sup>-1</sup> )
Line	SPN3	-0.49**	-0.01 <sup>ns</sup>	138.33**	-10.32**	36.00**	1.48 <sup>ns</sup>
	SPN9	0.16 <sup>ns</sup>	0.75*	-91.67**	5.35*	-30.67 <sup>ns</sup>	-1.26 <sup>ns</sup>
	SPN36	0.64**	-1.68**	-218.33**	7.89**	-100.67**	-4.04**
	SPN30	0.04 <sup>ns</sup>	1.55**	170.00**	-14.56**	26.00 <sup>ns</sup>	1.43 <sup>ns</sup>
	DH4	-0.347**	-0.62*	1.67 <sup>ns</sup>	11.64**	69.33**	2.75**
Tester	SPN34	1.32**	-0.10 <sup>ns</sup>	-338.00**	5.24**	-182.67**	-7.67**
	RGS003	-0.35**	0.88**	86.00**	-2.12*	41.33**	1.95**
	SPN1	-0.96*	-0.78**	252.00**	-3.12**	141.33**	5.73**

ns, \* and \*\*: Non-significant and significant at 0.05 and 0.01 probability.

Among the studied genotypes in this research, some of them had the highest positive and significant general combining ability (tab. 3). These are included: line DH4 for harvest index, oil yield, and grain yield, SPN30 for the percent of oil and biologic yield, line SPN36 for the 1000-grain weight, tester SPN34 for the 1000-grain weight and harvest index, tester RGS003 for percent of oil, and tester SPN1 for biologic yield, grain yield and oil yield. These genotypes have the ability to transfer their genetic superiority for yield potential to their progeny. Therefore, these genotypes can be used in breeding programs to produce rapeseed hybrid varieties with high performance. In the breeding process of rapeseed, the target is not only to find the best pure line, but also to find the best hybrid combination with suitable

characteristics in genotype and phenotype, since it was observed that the best lines for general combining ability cannot always produce the best hybrid.

In plants such as rapeseed, which the ultimate aim is grain yield, the emphasis is on grain yield-related traits. Refer to values of specific combining ability, the best combinations included SPN36×RGS003 for percent of oil, biologic yield, grain yield and oil yield, as well as DH4×SPN1 for harvest index and grain yield, and DH4×SPN34 for the 1000-grain weight (tab. 4). The experiments on different types of Brassica like rapeseed emphasized that the effect of general combining ability (GCA) in F1 population was significant for the components of yield and the effects of specific combining ability (SCA) were slightly significant, conforming to the results of this research (Chopra and Prakash, 1996).

Table 4: Estimation of specific combining ability (SCA) for crosses of Rapeseed.

Line×Tester	1000-grain weight(g)	Oil Percent (%)	Biologic Yield (g)	Harvest index (%)	Grain Yield (g)	Oil Yield (g.plot <sup>-1</sup> )
SPN3×SPN34	0.01 <sup>ns</sup>	0.72 <sup>ns</sup>	100.67 <sup>ns</sup>	-17.02 <sup>**</sup>	-12.00 <sup>ns</sup>	-0.47 <sup>ns</sup>
SPN3×RGS003	0.23 <sup>ns</sup>	-1.05 <sup>*</sup>	-111.33 <sup>ns</sup>	-2.07 <sup>ns</sup>	-74.00 <sup>*</sup>	-3.36 <sup>*</sup>
SPN3×SPN1	-0.90 <sup>**</sup>	0.32 <sup>ns</sup>	10.67 <sup>ns</sup>	19.09 <sup>*</sup>	86.00 <sup>**</sup>	3.83 <sup>**</sup>
SPN9×SPN34	0.03 <sup>ns</sup>	1.75 <sup>ns</sup>	-69.33 <sup>ns</sup>	-4.00 <sup>ns</sup>	-35.33 <sup>ns</sup>	-1.34 <sup>ns</sup>
SPN9×RGS003	0.03 <sup>ns</sup>	-0.38 <sup>ns</sup>	111.33 <sup>ns</sup>	19.32 <sup>ns</sup>	-12.67 <sup>ns</sup>	0.53 <sup>ns</sup>
SPN9×SPN1	-0.06 <sup>ns</sup>	-1.37 <sup>*</sup>	180.67 <sup>**</sup>	-15.32 <sup>**</sup>	22.67 <sup>ns</sup>	0.81 <sup>ns</sup>
SPN36×SPN34	-0.33 <sup>ns</sup>	-3.23 <sup>ns</sup>	-232.67 <sup>ns</sup>	2.57 <sup>ns</sup>	-105.33 <sup>**</sup>	-4.77 <sup>**</sup>
SPN36×RGS003	0.43 <sup>*</sup>	2.89 <sup>**</sup>	355.33 <sup>**</sup>	-9.09 <sup>**</sup>	172.67 <sup>**</sup>	7.73 <sup>**</sup>
SPN36×SPN1	-0.10 <sup>ns</sup>	0.33 <sup>ns</sup>	-122.67 <sup>**</sup>	-3.48 <sup>ns</sup>	-67.33 <sup>*</sup>	-2.96 <sup>*</sup>
SPN30×SPN34	-0.26 <sup>ns</sup>	0.60 <sup>ns</sup>	129.00 <sup>*</sup>	7.27 <sup>**</sup>	118.00 <sup>**</sup>	5.13 <sup>**</sup>
SPN30×RGS003	0.21 <sup>ns</sup>	-0.54 <sup>ns</sup>	87.00 <sup>ns</sup>	12.38 <sup>**</sup>	96.00 <sup>**</sup>	4.04 <sup>**</sup>
SPN30×SPN1	0.05 <sup>ns</sup>	-0.06 <sup>ns</sup>	-216.00 <sup>**</sup>	-19.65 <sup>**</sup>	-214.00 <sup>**</sup>	-9.18 <sup>**</sup>
DH4×SPN34	0.54 <sup>**</sup>	0.15 <sup>ns</sup>	72.33 <sup>ns</sup>	1.17 <sup>ns</sup>	34.67 <sup>ns</sup>	1.45 <sup>ns</sup>
DH4×RGS003	-0.90 <sup>**</sup>	-0.92 <sup>ns</sup>	-219.67 <sup>**</sup>	-20.53 <sup>**</sup>	-207.33 <sup>**</sup>	-8.94 <sup>**</sup>
DH4×SPN1	0.36 <sup>*</sup>	0.78 <sup>ns</sup>	147.33 <sup>*</sup>	19.36 <sup>**</sup>	172.67 <sup>**</sup>	7.49 <sup>**</sup>

ns, \* and \*\*: Non-significant and significant at 0.05 and 0.01 probability.

### Conclusion

In this study, there was sufficient genetic diversity in traits related to grain and oil yields, so that it can be used to enhance yield and create new varieties. The results showed that the impact of additive variance was more significant than non-additive variance for the 1000-grain weight and biologic yield. Hence, it is suggested to breed these traits with the selection-based methods. The degree of dominance was more than one in traits including percentage of oil, harvest index, grain and oil yields, which represents the over-dominant effects of genes control these traits. Consequently, the dominance gene effects of these traits can be used for hybrid seed production. The tester SPN1 and the lines DH4, and SPN30 were extremely nice genotypes for the combination of grain and oil yield-related traits. Furthermore, DH4×SPN1 and SPN36×RGS003 were as superior hybrids combinations among hybrids for grain and oil yield-related traits. Hence, the parents of these hybrids can be used in the program for hybrid seed production using male sterility system. Broad-sense heritability was very high for investigated traits. The difference between the coefficient of the phenotypic variation and the coefficient of genotypic variation was very low, and it can be concluded that the genetic variance is important than the environmental variance in the control of traits studied in this research. It is necessary to mention that the results of this research cannot be extrapolated to

other rapeseed genotypes which are not included in this study because the effect of genotypes is assumed to be fixed. As if, some of the differences in the findings of this study with others is due to plant materials. Thus, employment of genotypes with a wide range of diversity may result to a comprehensive conclusion on partitioning genetic variation. Regardless of the accuracy of results derived this experiment, it is necessary to perform the study in more year and place to estimate the interactive effects of genotype with the environment to estimate the heritability of traits by high reliability.

### References

- Ahmadi M. R., Samiezadeh H. (2006). Combining ability and genetic analysis of some quantitative traits in rapeseed. *Iranian Journal of Agricultural Sciences*, Vol. 37(1), pp. 435-443. (In Persian).
- Ashraf M., Neilly T.Mc. (2004). Salinity tolerance in Brassica oilseeds. *Journal of Plant Science*, Vol. 23, pp. 157-174.
- Amiri-Oghan H. (2000). Heritability indices of drought tolerance in rapeseed, Master's Thesis of Plant Breeding, Islamic Azad University of Ardabil. (In Persian).
- Amiri-Oghan H., Dehghani H., Haideri M. (2010). Inheritance of yield and its related traits in canola varieties of winter conditions and having stress-free. *Iranian Journal of Agricultural Sciences*. Vol. 20(1), pp. 48-33. (In Persian).
- Brown J., Erickson D.A., Davis J.B., Brown A.P., Seip L. (1996). Efficiency of early generation selection in spring canola. *Cruciferae Newsletter*, Vol. 18, pp. 19-20.
- Chopra V.L., Prakash S. (1996). Oilseed and vegetable brassicas, Indian perspective. Oxford and IBH Pub. Pvt. Ltd, New Delhi, Calcutta.
- Esmaili A., Norozi-asl A., zebar-jedi A., Derikvand R., Azizi KH. (2015). Study of heritability and the causal relationships of different traits, seed and rapeseed oil in Khorramabad weather conditions. *Journal of Agricultural Research and Development*, vol. 106, pp. 170-162. (In Persian).
- Gholami H., Moghadam M., Rameah V. (2008). Estimation of combining ability effects in rapeseed (*Brassica napus* L.) using line  $\times$  tester analysis. *Seed and Plant Improvement Journal*, vol. 24(3), pp. 399-411 (In Persian).
- Gholami H., Moghadam M. (2006). Estimated combined effects of canola (*Brassica napus* L.) crosses line $\times$ tester method. *Proceedings of the 9th Congress of Crop Sciences*, December 9-11, 2006, Tehran (in Persian).
- Jeromela A.M., Marinkovic R., Miladinovic D. (2007). Combining abilities of rapeseed (*Brassica napus* L.) varieties. *Journal of Genetica*, vol. 39, pp. 53-62.
- Kemphorne O. (1957). *An introduction to genetic statistics*. John Wiley, New York.
- Malik V., Singh H., Singh D. (1995). Gene action of seed yield and other desirable characters in rapeseed (*Brassica napus* L.). *Journal of annals of biology*, vol. 11, pp. 94-97.
- Qureshi S.H., Noorka I.R., Saeed M., Javed M., Murtaza G., Ali Shah M.K., Hussain A., and Shahzad F. (2017). Physio-genetic studies for economic traits in canola (*Brassica napus*). *International Journal of Agriculture and Applied Sciences*, vol. 9, no. 1, pp. 75-78.
- Roy B., Basu A.K. (2009). *Abiotic stress tolerance in crop plants: breeding and biotechnology*. New India Publishing Agency (NIPA), Pitam Pura, New Delhi.
- Satwinder K., Paramjit S., Gupta V. P., Kaur S., Singh P. (2000). Combining ability analysis for oil yield and its components in *Brassica napus*. *Cruciferae Newsletter*, vol. 22, pp. 67-68.
- Singh M., Lallu R.L., Srivastava R.K., Singh M. (2002). Combining ability studies for seed yield its component characters and oil content in Indian mustard (*Brassica juncea* L.). *Journal of Progressive Agriculture*, vol. 2, pp. 125-128.

- Thakur H.L., Sagwal J.C. (1997). Heterosis and combining ability in rapeseed (*Brassica napus* L.). *Indian Journal of Genetics and Plant Breeding*, vol. 57, pp. 163-167.
- Teklewold A., Becker H.C. (2005). Heterosis and combining ability in a diallel cross of Ethiopian mustard inbred lines. *Journal of Crop Science Society of America*, 45: 2629-2635.
- Thukral S.K., Singh H. (1987). Genetic analysis of seed yield, flowering, and maturity in rapeseed. *Indian Journal of Agricultural Sciences*, vol. 57, pp. 298-302.
- Varsha I., Satija D.R., Singh P. (1999). Gene effects for seed yield and its components in crosses involving exotic parents in *Brassica napus*. *Journal of Crop Improvement*, vol. 26(2), pp. 188-192.
- Wu J.G., Shi C.H., Zhang H.Z. (2006). Partitioning genetic effects due to embryo, cytoplasm and maternal parent for oil content in oilseed rape (*Brassica napus* L.). *Journal of Genetics and Molecular Biology*, vol. 29, pp. 533-538.

## **EFFECT NANO-TiO<sub>2</sub> AND NANO-SILICA ON SOME TRAITS OF SUNFLOWER**

Naser SABAGHNIA, Mohsen JANMOHAMMADI

Department of Agronomy and Plant Breeding, Faculty of Architecture, University of Maragheh, Iran

\*Corresponding author: sabaghnia@maragheh.ac.ir

### **Abstract**

The most of the cultivated crops are often facing with drought stress and application of some nanoparticles and growth regulators alleviate the adverse effects of stress. Present study is performed to evaluate the effects of foliar application of salicylic acid (S-A), glycine betaine (G-B), ascorbic acid (A-A), nano-silica (nano-SiO<sub>2</sub>) and nano titanium dioxide (nano-TiO<sub>2</sub>) on yield and yield component of sunflower. Chlorophyll content, leaf length, leaf width, days to 50% flowering, day to maturity, plant height, husk percentage, number of seeds per head, head number per plant, percentage of empty achenes, 1000-seed weight, kernel weight, grain length, straw yield, harvest index, grain yield and oil percent were measured. Results showed that the first two principal components were used to create a two-dimensional treatment by trait biplot that accounted percentages of 49% and 19% respectively of sums of squares of the TT interaction. The vertex treatments were A-A, G-B, Nano-TiO<sub>2</sub> and control which Nano-Ti<sub>2</sub> treatment indicated high performance in chlorophyll content, day to maturity, number of seeds per head, head number per plant, kernel weight, grain length, straw yield, harvest index, grain yield and oil percent. Treatments suitable for obtaining of high seed yield were identified in the vector-view function of TT biplot and displayed nano-silica and nano titanium dioxide as the best treatments suitable for obtaining of high seed yield. In short, nano-fertilizer could increase crop yields and improve the fertilizer efficiency.

**Keywords:** *nano-silicon dioxide, oil content, drought stress, TiO<sub>2</sub> nanoparticles*

### **Introduction**

Sunflower annual production in Iran is about one million tones which achieved from 700 thousand hectares while the average yield is relatively low and it has been recorded about 1050 kg ha<sup>-1</sup>. In semiarid areas, where the proportion of less fertile soils is high, it may be difficult to fulfill the nutritional needs of crops and fertilizer application represents a suitable tool to compensate nutrient deficiencies and to replace elements removed in the products harvested. Utilization of exogenous compatible solutes and growth regulators in semi-arid regions can be an effective practice for improving crop performance which is generally applied to mitigate the adverse effect of environmental stress (Senaratna et al., 2003). Compatible solutes are molecules that protects cells from desiccation by maintaining a high intracellular osmolality and among different materials, glycine betaine (GB) has been further investigated and suggested that GB has very imperative role in crops protection under extreme environmental conditions (Farooq et al., 2008).

Salicylic acid (SA) is naturally occurring plant hormone, influences various physiological and biochemical functions in plants because it can play role as a regulatory signal mediating plant response to abiotic stresses such as drought. Ascorbic acid (AA) has been used to as a cofactor for enzymes involved in regulating photosynthesis, hormone biosynthesis, and regenerating other antioxidants; and it is essential to many aspects of plant growth and responses.

Nano-titanium dioxide particles are promising as efficient nutrient source for plants to improve biomass production by enhancing metabolic activities and conversion of light energy (Gao et al., 2008), and also, it increase the activity of the enzymatic antioxidant factors such as superoxide dismutase peroxidase (Hong et al., 2005). According to Raliya et al. (2015), foliar application of nano-titanium dioxide particles on mung bean could significantly improve morphological traits, chlorophyll content and soluble leaf protein and according to Siddiqui et al. (2015), foliar application of nano-silica has gained greater consideration during growth period. Also, foliar spray of nano-silica on plants improve the plant growth and performance by enhancing the accumulation of antioxidant enzymes and increase the efficiency of photosynthetic apparatus (Kalteh et al., 2014). Therefore, the aim of the this investigation was to determine the possible role of glycine betaine, salicylic acid and ascorbic acid growth regulators and nano-silica (nSiO<sub>2</sub>) and nano-titanium dioxide (TiO<sub>2</sub>) particles on morphological traits, yield components, seed yield and oil content of sunflower.

### **Material and methods**

The experiment was performed based on randomised complete block design in four replicates with Azargol sunflower seeds at 28 March. Each experimental plot was consisting of 8 rows, 4.5 m length, and at 60×20 cm inter-plant and inter-row, respectively. Weeds were controlled by hand-hoeing. Treatments were Control: water spray, Nano-Si: foliar application of nano-silica suspension (2 mM), G-B: foliar spray of glycine betaine (100 mM), S-A: foliar spray of salicylic acid (1 mM), A-A: foliar application of ascorbic acid (1 mM), and Nano-Ti: spray of nano-titanium dioxide suspension (2 mM).

Chlorophyll content (CHL) was measured with a hand-held dual wavelength meter (SPAD 502, Chlorophyll meter, Japan) in fully expanded upper leaves at the flowering stage. Leaf length (LL) and leaf width (LW) were measured at the end of flowering stage on ten randomly selected plants. Also, traits days to 50% flowering (DF) and day to maturity (DM) were recorded. The morphological traits plant height (PH), husk percentage (HP), number of seeds per head (NSH), head number per plant (HNP), percentage of empty achenes (PEA), 1000-seed weight (TSW), kernel weight (KW), grain length (GL), straw yield (STY), harvest index (HI), grain yield (GY). Oil percent (OIL) of seed were measured using a Near-infrared seed analyzers analyzer (Zeltex). Treatment by trait (TT) analysis using biplot analysis (Yan and Kang, 2003) was used to determine which treatment was best and for what trait which were generated using the standardized values of the traits means. All analyses reported in this study were conducted by using the GGEbiplot software (Yan, 2001).

### **Results and discussion**

The first two principal components explained 68% of total variation (Fig. 1). In order to distinguish meaningful groups of tester (traits), repeatable patterns among traits have to be demonstrated through treatment by trait interaction biplot analysis. Fig. 1 shows the “which-won-where” view of biplot and the outmost treatments (four in this case) formed a four-side polygon and the biplot was divided into four sectors delimited by the lines perpendicular to each side of the polygon. The measured traits fell into all of the four sectors. For traits within a sector, the nominal “winner” is at the vertex and so, Control and A-A (ascorbic acid) were the wining treatments only for a single trait, percentage of empty achenes (PEA) and plant height (PH), respectively (Fig. 1). However, G-B (glycine betaine) was the winning treatments in the sector containing the husk percentage (HP), days to 50% flowering (DF), leaf length (LL), 1000-seed weight (TSW) and leaf width (LW) traits. Finally, Nano-Ti was the winning treatments in the sector containing the other 10 traits including chlorophyll



content (CHL), day to maturity (DM), number of seeds per head (NSH), head number per plant (HNP), kernel weight (KW), grain length (GL), straw yield (STY), harvest index (HI), grain yield (GY) and oil percent (OIL).

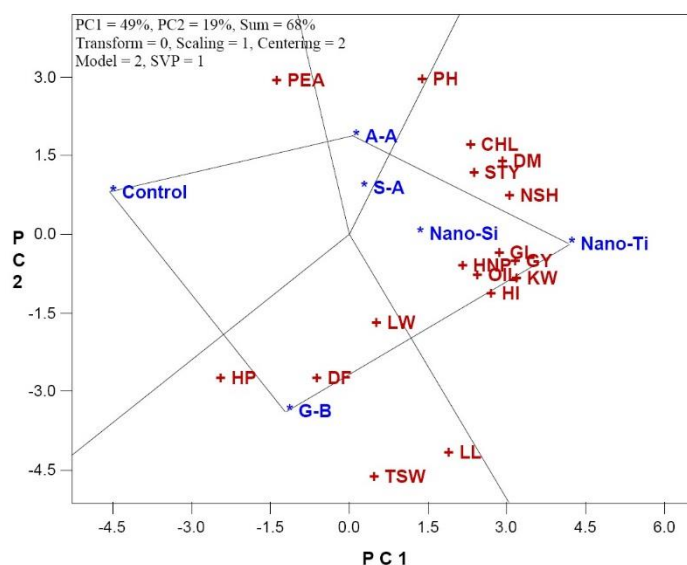


Fig. 1. Polygon-view of treatment by trait (TT) biplot showing which treatment had the highest values for which traits.

The results shown in Fig. 1 suggested that there might be distinct groups of traits (four in this case) in compliance with the large magnitude of treatment by trait interaction and the high value of PC1 and PC2 contributions to the total sum of squares in TT biplot. Summary of the interrelationships among the treatments for different traits provides Fig. 2. The lines connecting the biplot origin with the markers for the traits are called trait vectors and the angle between the vectors of two traits is related to the correlation coefficient between them. The cosine of the angle between the vectors of two traits approximates the correlation coefficient between them (Yan and Rajcan, 2002). Based on the cosine of angles of traits vectors, there were positive correlation among CHL, STY, DM and NSH as well as among GY, GL, KW, HNP, OIL and HI (Fig. 2). Also, there was near zero correlation between LL with PH, between LL with HP, between PEA with PH, and between TSW with CHL, STY, DM and NSH traits (Fig. 2). The presence of wide obtuse angles i.e. strong negative correlations among the traits (between PEA with LL, between PH with DF and between HP with CHL, STY, DM and NSH) is indication of strong cross-over TT interactions (Yan and Tinker, 2006). According to literature, such results have also been reported for positive correlation between seed with 1000-seed weight (Singh et al., 1990) and oil content (Jhagirdhar, 1986).

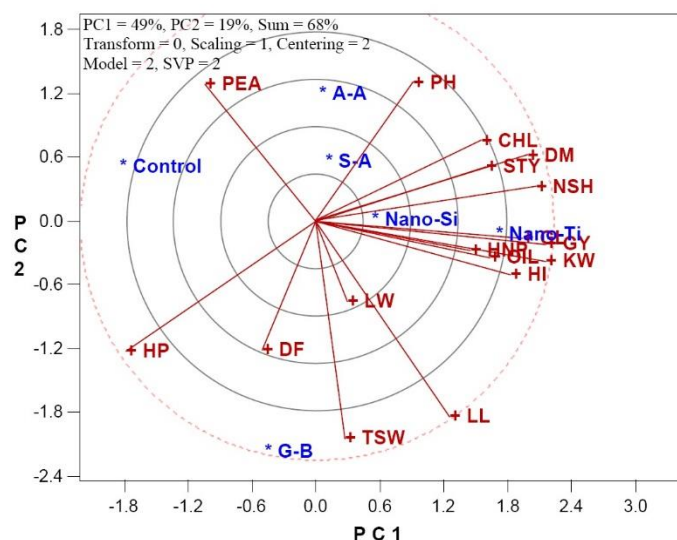


Fig. 2. Vector view of treatment by trait (TT) biplot showing the interrelationship among measured traits under different treatments.

The best treatment for obtaining of high grain yield (GY) and high oil content (OIL) could be find in the special vector-view of TT biplot (Fig. 3) which shows treatments that have close association with a target trait among other traits. According to these biplots of Fig. 3, Nano-Ti following to Nano-Si treatments were the best treatments suitable for obtaining of high performance of grain yield as well as high oil content. Thus, application of this treatment combination is expected to lead to improve the target trait under rainfed growing conditions in semi-arid region. This suggests that using nano-titanium dioxide suspension (2 mM) or nano-silica suspension (2 mM) will not only result in the development of high grain yield but also cause to obtain the other desirable agronomic traits which are associated to grain yield such as oil content. Therefore, it seems that application of Ti and Si nanoparticles had good effect on sunflower yield performance, yield components and morphological traits in comparison to application of glycine betaine (100 mM), salicylic acid (1 mM), ascorbic acid (1 mM) compounds of water spray (Control). Nano-titanium dioxide has been studied as photocatalysts (Ullah and Datta, 2008). In another experiment, Zheng et al. (2005), considered, germination rate and vigor index of spinach old seeds that treated with the nano-titanium dioxide and observed that most traits increased in seeds treated while Lu et al. (2002) reported that evaluations for super oxide dismutase and catalase increased in soybean that had been treated with nano-titanium dioxide. Also, Owolade et al. (2008), reported that nano-titanium dioxide application on some traits of cowpea such as number of seeds per pod, number of pod per plant, 1000 seed weight and grain yield performance were better than of these traits increased compared to the control. Some treatments like as nano-titanium dioxide and nano-silica increased the plant growth characteristics and partly expanded the source size, thus, it revealed that nanoparticles improved the both vegetative and reproductive traits. These findings further support the idea of Jaberzadeh et al. (2013) who reported that application of nano-titanium dioxide increased wheat growth and significantly improved grain yield under drought stress condition. Our finding about increment of oil percentage in yield performance by application of beneficial nanoparticles corroborates these earlier findings. Davar-Zareii et al. (2014) found that foliar application of nanoparticles during reproductive growth stage significantly improved the oil percentage in safflower. Therefore, results of present study suggested that foliar application of nano-titanium dioxide in proper concentrations under semi-arid highland region can be suitable option for improving sunflower production.

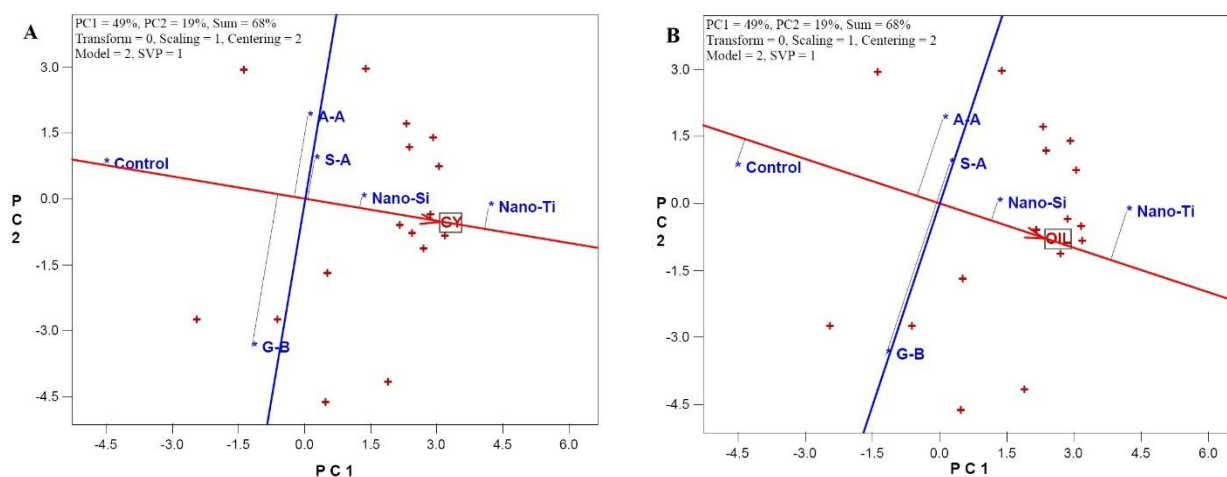


Fig. 3. Vector view of treatment by trait (TT) biplot, showing the relationships of different treatments with grain yield (GY) and oil content (OIL) traits.

Our study results indicate that nano-titanium dioxide and nano-silica play a significant role on increasing of sunflower yield and other traits, so that higher amounts of traits obtained with spraying of nanoparticles in compared with spraying distilled water (Control), A-S, A-A and G-B. The studies on improving photosynthesis suggested that nano-TiO<sub>2</sub> could increase this process and protect chloroplasts (Yang et al., 2006). Nano-TiO<sub>2</sub> particles enhanced seed germination and growth of canola seedlings (Mahmoodzadeh et al., 2013), as well as improving plant growth and yielded components of wheat under drought stress conditions (Jaberzadeh et al., 2013). Application of nano-SiO<sub>2</sub> and nano-TiO<sub>2</sub> particles improved seed germination of soybean by increasing nitrate reductase (Lu et al., 2002) and also by enhancing seeds ability to absorb and utilize water as well as nutrients (Zheng et al., 2005). The lower concentrations of nano-SiO<sub>2</sub> improved seed germination of tomato (Siddiqui and Al-Wahaibi 2014), and seedling growth of Changbai larch while nano-SiO<sub>2</sub> enhances the plant growth and development by increasing chlorophyll parameters, such as net photosynthetic rate, transpiration rate and photochemical quench (Siddiqui et al., 2014).

### Conclusions

Foliar spray of nano-titanium dioxide following nano-silica nanoparticles considerably enhanced the yield and yield components of sunflower performance in semi-arid region. In contrast application of glycine betaine, salicylic acid and ascorbic acid had not any positive effect on sunflower. The biplot analysis could help to visualize the interrelationships among treatments, traits and interaction between them and so was an efficient statistical tool for interpreting such dataset.

### Acknowledgement

We wish to thank kindly Professor Dr. Weikai Yan (Eastern Cereal Oilseed Research Center of Agriculture and Agri-Food Canada) for making available a time-limited version of GGEbiplot software as “Test Biplot.xlsx.”

### References

Davar-Zareii, F., Roozbahani, A., Hosnamidi, A. (2014). Evaluation the effect of water stress and foliar application of Fe nanoparticles on yield, yield components and oil percentage

- of safflower (*Carthamus tinctorious* L.). *International Journal of Advanced Biological and Biomedical Research*, 2, 1150–1159.
- Hong, F., You, W., Liu, C., Gao, F., Wu, C., Yang, P. (2006). Influence of nano-anatase TiO<sub>2</sub> on the nitrogen metabolism of growing spinach. *Biol. Biological Trace Element Research*, 110, 179–190.
- Farooq, M., Aziz, T., Hussain, M., Rehman, H., Jabran, K., Khan, M. B. (2008). Glycinebetaine improves chilling tolerance in hybrid maize. *Journal of Agronomy and Crop Science*, 194, 152–160.
- Hong, F., Yang, F., Liu, C., Gao, Q., Wan, Z., Gu, F., Wu, C., Ma, Z., Zhou, J., Yang, P. (2005). Influences of nano-TiO<sub>2</sub> on the chloroplast aging of spinach under light. *Biological Trace Element Research*, 104, 249–260.
- Jaberzadeh, A., Moaveni, P., Moghadam, H. R. T., Zahedi, H. (2013). Influence of bulk and nanoparticles titanium foliar application on some agronomic traits, seed gluten and starch contents of wheat subjected to water deficit stress. *Notulae Botanicae Horti Agrobotanici Cluj-Napoca*, 41, 201–207
- Jhagirdhar, N. L. (1986). Genetic analysis of some quantitative traits in sunflower (*Helianthus annuus* L.) hybrids. M.Sc. (Agri.) Thesis, Univ. Agric. Sci. Bangalore, pp. 124.
- Kalteh, M., Alipour, Z. T., Ashraf, S., Aliabadi, M., M. Nosratabadi, A. F. (2014). Effect of silica nanoparticles on basil (*Ocimum basilicum*) under salinity stress. *Journal of Chemical Health Risks*, 4, 49–55.
- Lu, C. M., Zhang, C. Y., Wen, J. Q., Wu, G. R., Tao, M. X. (2002). Research on the effect of nanometer materials on germination and growth enhancement of Glycine max and its mechanism. *Soybean Science*, 21, 68–172
- Mahmoodzadeh, H., Nabavi, M., Kashefi, H. (2013). Effect of nanoscale titanium dioxide particles on the germination and growth of canola (*Brassica napus*). *Journal of Ornamental and Horticultural Plants*, 3, 25–32.
- Morteza, E., Moaveni, P., Farahani, H.A., Kiyani, M. (2013). Study of photosynthetic pigments changes of maize (*Zea mays* L.) under nano TiO<sub>2</sub> spraying at various growth stages. *Springer Plus*, 2(1), 1.
- Owolade, O.F., Ogunleti, D.O., Adenekan, M.O. (2008). Titanium dioxide affects diseases, development and yield of edible cowpea. *EJEAF Chemistry*, 7, 2942–2947.
- Raliya, R., Biswas, P., Tarafdar, J. C. (2015). TiO<sub>2</sub> nanoparticle biosynthesis and its physiological effect on mung bean (*Vigna radiata* L.). *Rep-Biotech*, 5, 22–26.
- Senaratna, T., Merritt, D., Dixon, K., Bunn, E., Touchell, D., Sivasithamparam, K. (2003). Benzoic acid may act as the functional group in salicylic acid and derivatives in the induction of multiple stress tolerance in plants. *Plant Growth Regulation*, 39, 77–81.
- Siddiqui, M.H., Al-Whaibi M.H. (2014). Role of nano-SiO<sub>2</sub> in germination of tomato (*Lycopersicon esculentum* seeds Mill.). *Saudi Journal of Biological Sciences*, 21, 13–17.
- Siddiqui, M. H., Al-Whaibi, M. H., Firoz, M., Al-Khaishany, M. Y. (2015). Role of Nanoparticles in Plants. In *Nanotechnology and Plant Sciences* (pp. 19–35). Springer International Publishing.
- Singh, S.B., Labana, K.S. (1990). Correlation and path analysis in sunflower. *Crop Improvement*, 17, 49–53.
- Ullah, R., Dutta, J. (2008). Photocatalytic degradation of organic dyes with manganese-doped ZnO nanoparticles. *Journal of Hazardous Materials*, 156, 194–198.
- Yan, W., Rajcan, I. (2002). Biplot analysis of test sites and trait relations of soyabean in Ontario. *Crop Science*, 42, 11–20.
- Yan, W., Kang, M.S. (2003). GGE biplot analysis: a graphical tool for breeders, Geneticists and Agronomists. 1st Ed., CRC Press LLC., Boca Raton, Florida, pp: 271.

- Yan, W., Tinker, N.A. (2006). Biplot analysis of multi-environment trial data: Principles and applications. *Canadian Journal of Plant Science*, 86, 623–645.
- Yan, W. (2001). GGE biplot a windows application for graphical analysis of multi-environment trial data and other types of two way data. *Agronomy Journal*, 93, 1111–1118.
- Yang, F., Hong, F., You, W., Liu, C., Gao, F, Wu, C., Yang, P. (2006). Influences of nanoanatase TiO<sub>2</sub> on the nitrogen metabolism o growing spinach. *Biological Trace Element Research*, 110, 179–190
- Zheng, L., Hong, F., Lu, S., Liu, C. (2005). Effect of nano-TiO<sub>2</sub> on strength of naturally aged seeds and growth of spinach. *Biological Trace Element Research*, 104, 83–91.

## BIPLOT ANALYSIS OF PRE-SOWING TREATMENTS OF DRAGONHEAD (*DRACOCEPHALUM MOLDAVICA* L.) WITH SOME NANO- PARTICLES

Reyhaneh Hamedi ESFAHLAN\*, Naser SABAGHNIA

Department of Plant Production and Genetics, Faculty of Agriculture, University of Maragheh, Maragheh, Iran.

\*Corresponding author: reyhane.hamedi@yahoo.com

### Abstract

In this research, two types of nano-particles including nano-iron and nano-silicon particles have been investigated in seed priming of dragonhead processing. The pre-hydration treatments were nano-silicon dioxide levels consist on (Si1) 0 mM or distilled water, (Si2) 1 mM and (Si3) 2 mM and nano-iron oxide levels consist on (Fe1) 0 Mm or distilled water, (Fe2) 1 mM and (Fe3) 2 mM. Some seed germination characteristics including germination percent, root fresh weight, shoot fresh weight, root length, shoot length, dry weight of the seed residue, root dry weight and shoot dry weight were measured in each experimental unit. The treatment by trait biplot technique was used to data and showed that the first two principal components, explained 80% of variation. Traits germination percent, root fresh weight, shoot fresh weight, root length, shoot length and root dry weight were in the same sector, with Si2-Fe3 treatment (1 mM nano-silicon dioxide and 2 Mm nano-iron oxide) as the best treatment. The best treatment combination suitable for obtaining of high values of germination properties was determined as S2-F3 (1 mM nano-silicon dioxide plus 2 mM nano-iron dioxide) based on ideal entry biplot tool.

**Keywords:** *nanoparticle, Dracocephalum moldavica L. seed germination*

### Introduction

Dragonhead is originated from south Siberia and is native to central Asia and naturalized in eastern and central Europe (Omidbaigi et al., 2010). Its essential oil is used widely in medicine, food, cosmetic and health industries. Dragonhead is used in folk medicine as a painkiller and is distributed in high altitudes in central and northern regions and it has been used as analgesic agent and a part of the remedy against many diseases. In stress condition, early sowing can hasten plant growth and may avoid the facing of critical stages of development with terminal stresses (Janmohammadi et al., 2013.) Pre-sowing seed treatments are applied by various methods for enhancing pre-germination and post-germination activities of seed.

Nanoparticles can easily enter into plant by overcoming the cell wall barrier and have achieved greater consideration because of their highly reactive surface-to-volume ratio property (Lyons et al., 2011). The study of Janmohammadi and Sabaghnia (2015) indicated that controlled imbibition of sunflower achene in nano-silicon solution followed by dehydration could significantly enhance seed germination. These positive effects of nano-silicon in primed seeds may suggest that they would exhibit more acceptable agronomic and physiological performance in sunflower. Using of nano-particles has given a lot of interesting by different investigators especially by those studying seed properties and some useful nano-particles were reported to have a useful effect in plants such as by nano-silicon dioxide and nano-iron oxide. The purpose of present study was to investigate the effect of seed priming

with nano-silicon dioxide and nano-iron oxide particle treatments on seed germination of dragonhead to find out the most promising concentration by using biplot method.

### Materials and methods

Primary germination rate of seeds was greater than 90%. Seeds were subjected to pre-hydration treatments by soaking in three levels of nano-silicon dioxide as; (Si1) 0 mM nano-silicon dioxide or distilled water, (Si2) 1 mM nano-silicon dioxide concentration and (Si3) 2 mM nano-silicon dioxide concentration and three levels of nano-iron oxide as; (Fe1) 0 Mm nano-iron oxide or distilled water, (Fe2) 1 mM nano-iron oxide concentration and (Fe3) 2 mM nano-iron oxide concentration. One piece of filter paper was put into each 100 mm × 15 mm Petri dish, and 10 mL of each test solution was added to each experimental sample. Forty-five seeds were selected and placed in each Petri dishes and then were covered and sealed with tape, placed in an incubator. Germination percent (GP) was calculated. All measurements were executed as described in Seedling Evaluation Handbook (AOSA, 1991). RFW, root fresh weight (g); SFW, shoot fresh weight (g); RL, root length (cm); SL, shoot length (cm); DWS, dry weight of the seed residue; RDW, root dry weight (g); and SDW, shoot dry weight (g) were recorded. Each treatment combination (Si-Fe: nano-silicon dioxide × nano-iron oxide) was conducted with five replications. The two-way treatment × trait (TT) biplot model is used based on Yan and Rajcan (2002). Visual analysis of TT biplot was performed using figures which were generated via the GGEbiplot software (Yan, 2001), using scores of first two principle components analysis (PC1 and PC2). The statistical properties of biplot interpretation have been described in detail by some researchers (Yan et al., 2007; Sabaghnia et al., 2015).

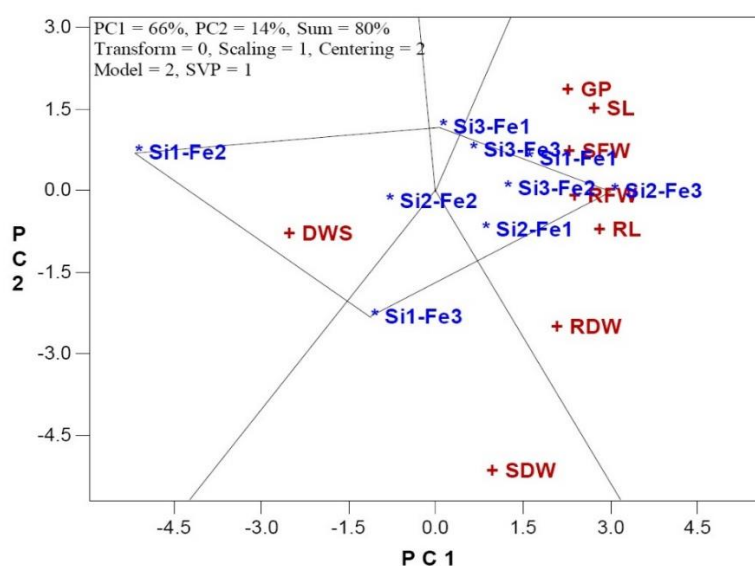


Fig. 1. Polygon-view of TT biplot showing which treatment had the highest values for which traits. Fore abbreviations, refer to the text.

### Results and discussion

The first two PCs (PC1 and PC2) based on TT biplot method together explained 80% (66 and 14% for the PC1 and PC2, respectively) of the observed variation for the measured traits of dragonhead under priming treatments (Fig. 1). Biplots could effectively identify TT interaction and which-won-where information (Yan et al., 2000) and using this method, seed priming treatments can be evaluated for their performance in individual traits and across

traits. Figure 2 indicates which seed priming treatment won where for dragonhead germination properties. Most of the measured traits including germination percent (GP), root fresh weight (RFW), shoot fresh weight (SFW), root length (RL), shoot length (SL) and root dry weight (RDW) were in the same sector, with Si2-Fe3 treatment (1 mM nano-silicon dioxide and 2 Mm nano-iron oxide) as the best treatment (Fig. 1). Dry weight of the seed residue (DWS) was in the other sector, with Si1-Fe2 treatment (0 mM nano-silicon dioxide and 1 Mm nano-iron oxide) as the best fertilizer treatment while shoot dry weight (SDW) was in the another sector, with Si1-Fe3 treatment (0 mM nano-silicon dioxide and 2 Mm nano-iron oxide) as the best fertilizer treatment (Fig. 1). The other vertex fertilizer treatment Si3-Fe1 treatment (2 mM nano-silicon dioxide and 0 Mm nano-iron oxide) was not the best in any of the measured traits (Fig. 1). Therefore, it seems that for obtaining the best performance in most of the measured traits, application of Si2-Fe3 treatment would be useful for good seed germination of dragonhead, following to Si1-Fe1, Si2-Fe1, Si3-Fe2 and Si3-Fe3 treatments. The present findings seem to be consistent with other researches, which found that the significant beneficial influences of the nano-silicon particles on seed germination properties of lentil and sunflower (Sabaghnia and Janmohammadi, 2014; Janmohammadi and Sabaghnia, 2015).

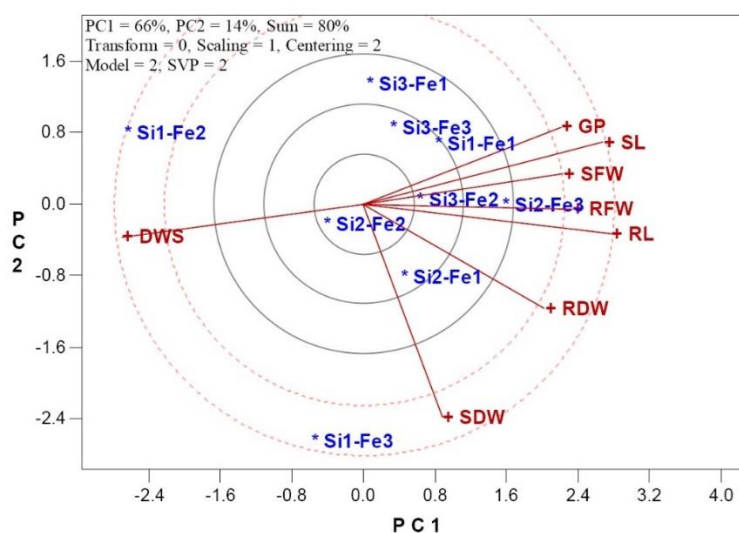


Fig. 2. Vector view of TT biplot showing the interrelationship among measured traits of dragonhead under different priming (Nano-Si and Nano-Fe) treatments. Fore traits' abbreviations, refer to the text.

Figure 3 is showing the interrelationship among the measured traits using the lines connecting each trait marker to the origin of the biplot, the length of each trait vector approximates the standard deviation of each trait and the cosine of the angle between the vectors of any two traits approximates the correlation coefficient between the traits. From Fig. 2, GP, SL, SFW, RFW and RL were highly positively correlated and it shows they all gave similar information about variability among the treatments. These results were in agreement with those reported by Bhagowati and Saikia (2003) and Tuncturk and Çiftçi (2005). Also, dry weight of the seed residue (DWS) had approximately negative correlation with GP, SL, SFW, RFW and RL. A near zero correlation between SDW with DWS, and between SDW with GP, SL, SFW, RFW and RL traits as indicated by the near perpendicular vectors (Fig. 2).



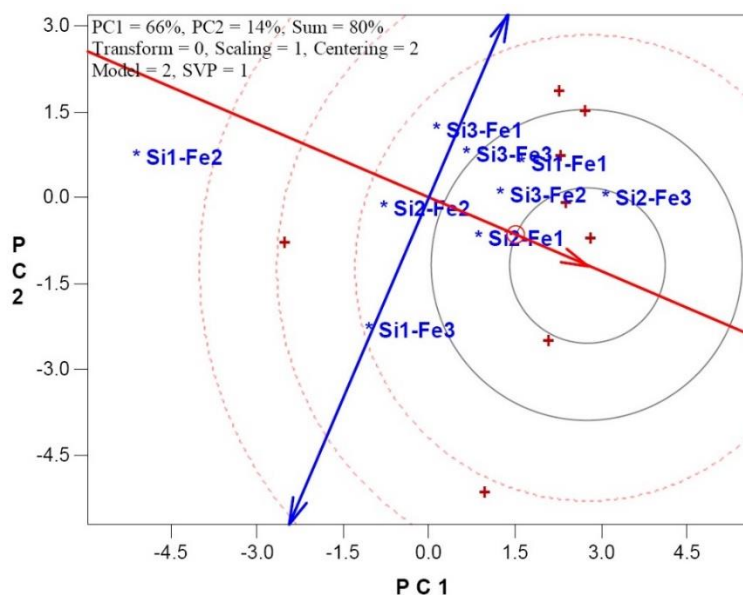


Fig. 3. Ideal entry view of TT biplot, showing the relationships of different priming (Nano-Si and Nano-Fe) treatments with ideal entry (treatment) in dragonhead. Fore traits' abbreviations, refer to the text.

An ideal entry or treatment has been defined as the treatment that combines several good traits in its performance and it should possess the highest mean performance across traits (average tester coordinate) abscissa and shortest entry-vector, thus, it should be close to the ideal entry represented by the innermost concentric circle with an arrow pointing to it (Sabaghnia, 2015). It can be used as a reference check in subsequent trials where the set of traits will be measured. In the biplot of Fig. 3, the single-arrow line that passes through the biplot origin is referred to as average tester coordinate and on this line is ranked the cultivars in terms of their morphological performance. The double-arrow line (average tester coordinate ordinate) divides the average tester coordinate abscissa into two at the middle and the portion of the average tester coordinate towards the right displays the above average cultivars and towards the left shows those treatments below average. Based on this biplot, the treatments that performed above average were Si1-Fe1, Si2-Fe1, Si2-Fe3, Si3-Fe2 and Si3-Fe3; while Si1-Fe2, Si1-Fe3 and Si2-Fe2 performed below average in terms of germination properties (Fig. 3). Si2-Fe3 treatment (1 mM nano-silicon dioxide and 2 Mm nano-iron oxide) is closest to the position of an ideal treatment and it is ranked the highest in term of germination performance because it is desirable in terms of most of the germination properties. This treatment could serve as a priming treatment from the other treatments. However, priming at high concentration of nano-silicon as well as nano-iron particles could improve seed germination percentage.

Seed priming with nano-silicon dioxide broke the seed dormancy for tall wheatgrass, hence it seems that nanoparticles could be an alternative potential for breaking of seed dormancy (Azimi et al., 2014). We believe that high concentration of nano-silicon dioxide (2 mM) could be toxic for dragonhead seed, therefore high concentration adversely affected on seed performance. Also, our results suggested that response of dragonhead germination to pre-hydration at various concentrations of nano-silicon and nano-iron solution were very different which indicates the influences of the nanoparticles on early seedling growth of plants are almost unpredictable. Exogenous application of bulk silicon at high concentration considerably improved germination characteristics of borage seeds (Torabi et al., 2012), our

findings emphasized that the best result could be obtained at low concentration of nano-silicon.

### **Conclusions**

In conclusion, obtained results revealed that the application of nanoparticles enhanced seed germination potential in dragonhead. The most important traits were germination percentage, energy of germination, promptness index and germination rate which are reflect the rate and power of seed germination and seedling growth in dragonhead.

### **Acknowledgement**

We wish to thank kindly Professor Dr. W. Yan (Eastern Cereal Oilseed Research Center of Agriculture and Agri-Food Canada) for making available a time-limited version of GGEbiplot software as “Test Biplotxlsx.”

### **References**

- AOSA (ASSOCIATION OF OFFICIAL SEED ANALYSIS) (1991). Rules for testing seeds. *Seed Science Technology*, 12: 18–9.
- Azimi R., Borzelabad M.J., Feizi H., Azimi A. (2014). Interaction of SiO<sub>2</sub> nanoparticles with seed prechilling on germination and early seedling growth of tall wheatgrass (*Agropyron elongatum* L.). *Polish Journal of Chemistry Technology*, 16: 25–29.
- Bhagowati, R.R., Saikia M. (2003). Character association and path coefficient analysis for yield attributes in open pollinated and hybrid true potato seed populations. *Crop Research*, 26: 286–290
- Janmohammadi M., Bashiri A., Asghari-Shirghan R., Sabaghnia N. (2013). Impact of pre-sowing seed treatments and fertilizers on growth and yield of chickpea (*Cicer arietinum* L.) under rainfed conditions. *Natura Montenegro*, 12: 217–229.
- Janmohammadi M., Sabaghnia N. (2015). Effect of pre-sowing seed treatments with silicon nanoparticles on germinability of sunflower (*Helianthus annuus*). *Botanica Lithuanica*, 21: 13–21
- Lyons K., Scrinis G., Whelan J. (2011). Nanotechnology, agriculture, and food. *Nanotech. Global Sustain*, 117.
- Ma J.F. (2004). Role of silicon in enhancing the resistance of plants to biotic and abiotic stresses. *Soil Science and Plant Nutrition*, 50: 11–18.
- Omidbaigi R., Yavari S., Hassani M.E., Yavari S. (2010). Induction of autotetraploidy in dragonhead (*Dracocephalum moldavica* L.) by colchicine treatment. *Journal of Fruit and Ornamental Plant Research*, 18: 2010: 23–35.
- Sabaghnia N., Janmohammadi M. (2014). Graphic analysis of nano-silicon by salinity stress interaction on germination properties of lentil using the biplot method. *Agriculture and Forestry*, 60: 29–40.
- Sabaghnia N. (2015). Investigation of some morphological traits in studied lentil (*Lens culinaris* Medik.) genotypes grown with foliar application of nanosized ferric oxide. *Annales UMCS, Biologia*, 69: 29–38.
- Sabaghnia N., Behtash F., Janmohammadi M. (2015). Graphic Analysis of Trait Relations of Spinach (*Spinacia oleracea* L.) Landraces Using the Biplot Method. *Acta Universitatis Agriculturae et Silviculturae Mendelianae Brunensis*, 63: 1187–1194.

- Torabi F., Majd A., Enteshari S. (2012). Effect of exogenous silicon on germination and seedling establishment in *Borago officinalis* L. *Journal of Medicinal Plants Research*, 6: 1896–1901.
- Torabi F., Majd A., Enteshari S. (2012). Effect of exogenous silicon on germination and seedling establishment in *Borago officinalis* L. *Journal of Medicinal Plants Research*, 6: 1896–1901.
- Tuncur M., Çiftçi, V. (2005). Selection criteria for potato Breeding. *Asian Journal of Plant Sciences*, 4: 27–30.
- Yan W., Kang M. S., Ma B., Wood S., Cornelius P.L. (2007). GGE biplot vs. AMMI analysis of genotype-by-environment data. *Crop Science*, 47: 643–655.
- Yan W. (2001). GGEbiplot: A windows application for graphical analysis of multi-environment trial data and other types of two-way data. *Agronomy Journal*, 93: 1111–1118.
- Yan W., Hunt L. A., Sheng Q., Szlavnic Z. (2000). Cultivar evaluation and mega-environment investigation based on the GGE biplot. *Crop Science*, 40: 597–605.
- Yan W., Rajcan I. (2002). Biplot analysis of test sites and trait relations of soybean in Ontario. *Crop Science*, 42: 11–20.

## PROTEOMIC AND MOLECULAR ANALYSIS OF TOMATO PLANTS GROWN IN SOIL WITH BIOCHAR

Maria TARTAGLIA, Mauro MARRA, Mariapina ROCCO\*

Department of Science and Technology, University of Sannio, Benevento, Italy

Department of Biology, University of Tor Vergata, Rome, Italy

\*Corresponding author: rocco@unisannio.it

### Abstract

A contribution to the solution of environmental problems, like accumulation of greenhouse gases in the atmosphere inducing global warming, as well as soil pollution and reduced fertility, could come from the past and be enclosed in a known material: charcoal or “biochar”. Biochar is a rich-carbon charcoal obtained by pyrolysis of different biomasses, which is used since ancient times as soil amendment. It can be used for long-term storage of carbon in the soil thus reducing the amount of CO<sub>2</sub> released in the atmosphere, but also to improve the chemical and physical characteristics of the soil. In fact, biochar reduces leaching of nutrients and water, increases the pH of the soil, favours nitrogen-fixation and retains heavy metals and toxic substances. Despite a renewed interest in this sustainable practice, there is still a lack of knowledge about biochar effects and mechanisms of action on plants. In the literature for instance, there is conflicting evidence about biochar effects on plant’s ability to respond to stress. In this study, molecular data are presented concerning the administration of biochar to tomato cultivations. The starting material used for the production of our biochar was a mixture of beech, chestnut and acacia wood. We choose tomato cultivations, variety San Marzano, because of their great economic relevance and their large diffusion in the Mediterranean area, especially in South Italy. As the result of the administration to the tomato cultivations of small amounts of biochar we observed a positive effect on plant growth. The effect of biochar administration was analyzed regarding gene and protein expression profiles. The data obtained allowed to ascertain that different enzymes of carbon metabolism and photosynthesis were up-regulated by biochar, whereas some stress responsive and defense genes were down-regulated. Hence, in conclusion, proteomic and RT-PCR analysis of tomato plants, confirmed at the molecular level the growth-promoting effect of biochar and showed a significative detrimental effect on the expression of genes involved in the response to environmental and biotic stress.

**Keywords:** *proteome, tomato, biochar, climate change.*

### Introduction

The exponential development of the industrial sector since the mid-twentieth century, the massive use of fossil fuels, anthropogenic effects such as deforestation, breeding and intensive agriculture, have greatly influenced the environment. The amount of greenhouse gas emissions, resulting from human activities, has increased 41% since 1990 (Samimi *et al.*, 2012). Climate change affects all levels of biodiversity, from the single organism to the full bioma. The alterations of these parameters are both able to reduce genetic diversity by strong selective pressure, leading to the migration of entire populations (Botkin *et al.*, 2007). However, our knowledge about the effects of global warming on biodiversity is still insufficient and requires the use and integration of multiple approaches to plan a conservation strategy for species and ecosystems (Dawson *et al.*, 2011). In agriculture, stress can be

defined as "any environmental pressure that can reduce the potential productivity of a crop" (Lichtenthaler, 1998). Environmental stresses are the main limiting factors for agricultural productivity and therefore have a huge impact on the economy. Temperature, light intensity, availability of water and nutritional values deviating from the optimum levels may cause a strong culture wound leading, in extreme cases, to a total crop loss (Vernieri *et al.*, 2006). Carbon, naturally seized by the plants and transformed into organic molecules, can be converted through the pyrolysis in molecules that can be stored in the soil for millennia, so reducing CO<sub>2</sub> in the atmosphere and mitigating climate change. Biochar is a fine grain carbon, obtained from pyrolysis of various types of vegetable biomass, like corn, rice, figs or wheat waste. When added to the soil, this can improve its characteristics and simultaneously reduce carbon emissions. Most studies on effects of biochar on plants focused on high economic relevance in cultivations. These have shown several beneficial effects of biochar especially in terms of plant yield and productivity. Plant effects are a consequence of the beneficial effects that biochar has on soils and which obviously affect resident flora and fauna. In a recent work (Viger *et al.*, 2014), biochar was shown to have a regulatory effect on genes involved in growth such as auxin, brassinosteroids, expansin, sucrose and nutrient carriers. At the same time, a down-regulation of genes involved in secondary metabolism and in biosynthetic pathways of jasmonic acid and salicylic acid that play key roles in plant defense against pathogenic agents (Abe *et al.*, 2008) was observed. These latter data are in contrast to previous studies showing a positive effect of biochar in inducing systemic acquired resistance (SAR) and induced systemic resistance (ISR) (Elad *et al.*, 2011; Harel *et al.*, 2012). In this work we analyzed by a proteomic and RT-PCR approach the molecular effect of biochar administration to tomato cultivations of tomato, of the South Italy, high value San Marzano.

### Materials and methods

Tomato plants were grown in a greenhouse, under controlled conditions in two kind of soils; a control using normal soil and soil with 65g/kg of a biochar, made of corn waste with a pyrolysis temperature of 550 °C, and 81.1% of carbon and 1.19% of nitrogen. Fully-ripen tomato fruits and leaves were collected and placed in liquid nitrogen, lyophilized and finely-powdered in liquid nitrogen. Proteins were extracted using the method of phenolic extraction (Rocco *et al.*, 2006). Protein pellets were washed with ice-cold methanol and ice-cold acetone, dried and dissolved in IEF buffer. Protein concentration was quantified using the BioRad protein assay. IPG strips (17 cm, pH 4–7, BioRad) were rehydrated and proteins were focused using a Protean IEF Cell (BioRad) at 127°C, applying 250 V (90 min), 500 V (90 min), 1000 V (180 min) and 8000 V for a total of 52 KVh. After focusing, proteins were reduced by incubating the IPG strips with 1% w/v DTT for 15 min and alkylated with 2.5% w/v iodoacetamide. Electrophoresis in the second dimension was carried out using a Protean apparatus (BioRad) and 12% polyacrylamide gels with 120 V applied for 12 h. Each sample was run in triplicate. 2-DE gels were stained with colloidal Coomassie G-250 and scanned using a GS-800 calibrated densitometer (BioRad). Image analysis was performed using the PDQuest software. Spot detection and matching between gels were performed automatically, followed by manual verification. After normalization of the spot densities against the whole-gel densities, the percentage volume of each spot was averaged for six gels for fruits sample (three replicates for control and three for biochar fruits) and six gels for leaves sample (three replicates for control and three for biochar leaves). Student's t-test analysis ( $p < 0.05$ ) was performed to determine significant protein proportional changes associated with the presence of biochar in soil. Spots from 2-DE were excised from gels and digested with trypsin (Rocco *et al.*, 2006). Samples were desalted using mZipTipC18 tips (Millipore) before MALDI-TOF-MS analysis (Rocco *et al.*, 2006).

For molecular analysis of fruit and leaf samples, RNA was extracted using the "Spectrum Plant Total RNA Kit", Sigma. The extracted RNA was readily retroscripted to cDNA which, having a double filament structure, is more stable. cDNA synthesis was performed using the "EasyScript Plus cDNA Synthesis Supermix". After bibliographic research we prepared primers for AOS and PR1 genes using the PRIMER BLAST (NCBI) program. PCR reaction was performed using DNA Polymerase Master Mix Taq (for the protocol: si.vwr.com) and a temperature gradient for the AOS gene was fixed at 57 to 61 ° C, and for the PR1 gene from 47 at 50 ° C. The thermocycler program was adapted to the amplification length and annealing temperatures of the primers. PCR products were loaded (12µl template + 5µ Quick-Load® PCR Marker | NEB) on an agarose gel (2%), A 100 bp DNA Ladder was used as a marker. After the staining the gel was acquired using ChemiDoc.

## Results and discussion

The molecular effects of biochar on tomato plants were first evaluated through the analysis of protein expression profiles in tomato berries and leaves by a comparative proteomic approach, based on 2D gel electrophoresis and mass-spectrometry. Representative 2D gels of berries and leaves from control and biochar-treated samples are shown in Figures 1 and 2, respectively average proteomic maps for fruits grown in control soil and biochar-treated showed 607 spots and 626, respectively; similarity between samples was 68% (control/biochar). As far as tomato leaves, the average proteomic maps showed 320 spots in control sample and 293 spots in leaves grown in biochar-treated soil; similarity between samples was 61% (control/biochar). The statistical analysis ( $p \leq 0.05$ ) revealed 35 (berries) and 21 protein spots (leaves) as differentially expressed between control and biochar. 13 (berries sample) and 9 (leaves sample) of these proteins have currently been identified and functional classification according to literature data allowed to group them into two main functional classes: energy and carbon metabolism and stress and defense (Table 1).

### Down-regulated proteins

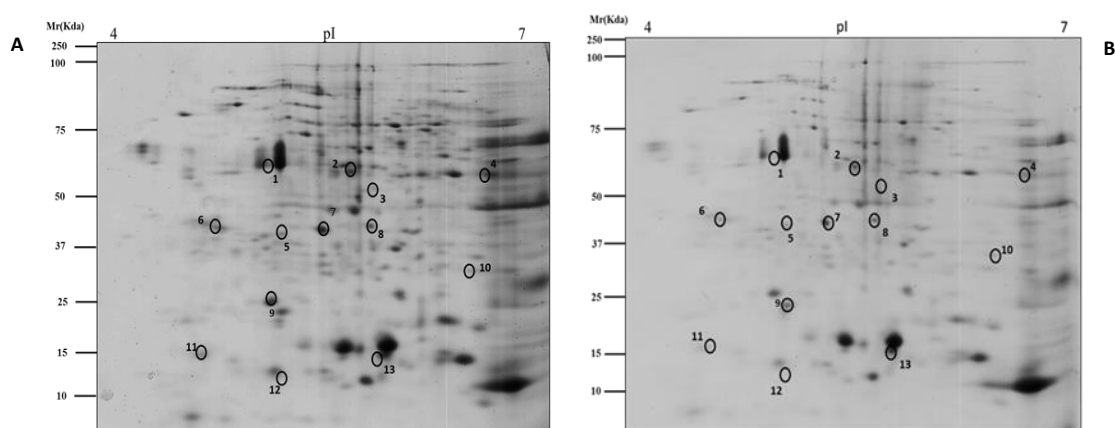
Both in berry and leaf tissues most of polypeptides which were down-regulated by biochar amendment belonged to the functional class of stress and defense. In fact, four proteins in tomato berries, namely: Ascorbic peroxidase, (APX); Gluthathione-S-Transferase jclass; 17.6 kDa class 1 Small heat shock protein; Chaperonin 21 and two in leaves, namely: 17.6 kDa class 1 Small heat shock protein, and Disulfide isomerase-like 1-1 were identified. Shsp1 and chaperonin 21 are molecular chaperones whose up-regulation by different abiotic stress is well-documented. In particular Shsps (Haslback, 2002) are the most prevalent heat shock proteins in plants, they are divided into six multigene families and are expressed in different cell compartments in response to a wide spectrum of environmental stresses, including oxidative stress (Wang *et al.*, 2004; Sunet *et al.*, 2002). Shsp1 in our study was identified as a strongly down-regulated protein both in tomato berries and leaves. Two proteins involved in protection from oxidative damage were found down-regulated in tomato berries after biochar treatment: APX and Gluthathione-S-transferase. APX is the main enzyme responsible for H<sub>2</sub>O<sub>2</sub> removal in the plant cell through the ascorbate-glutathione cycle, while Gluthathione-S-transferase is involved in the reduction of organic hydroperoxides to limit oxidative damage (Caverzan *et al.*, 2012). In tomato leaves, Protein disulfide isomerase levels were down-regulated after biochar treatment. This protein, catalyzing reduction of -S-S- bridges of proteins is involved in both protein folding and control of cell redox homeostasis (Gruber *et al.*, 2006) Among other identified proteins not belonging to the stress and defense class, a PP2C resulted down-regulated. Information concerning PP2C functions in plants is very scarce but it has been shown in Arabidopsis that the PP2C ABI 1 is involved in the signaling

pathway of the stress responding hormone abscisic acid (Rocco *et al.* 2006). On the overall, our data indicates that biochar treatment induces a marked reduction of the expression levels of proteins related to stress response and particularly to protein folding and protection from oxidative damage.

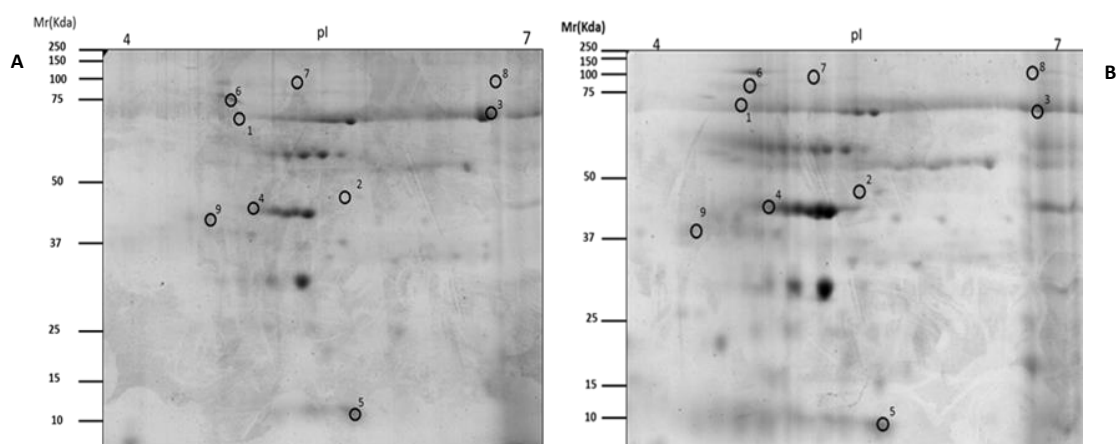
### Up-regulated proteins

Both in berry and leaf tissues most of polypeptides which were up-regulated by biochar amendment classified in the energy production and carbon metabolism class. In fact, five different polypeptides were identified in tomato berries, namely: Malate dehydrogenase Oxygen-evolving enhancer protein 1; Ribulose biphosphate carboxylase/oxygenase activase; Ribulose biphosphate carboxylase/oxygenase large chain; Ribulose biphosphate carboxylase/oxygenase small chain 2A and five in leaves, namely: Ribulose biphosphate carboxylase/oxygenase large chain; Ribulose biphosphate carboxylase/oxygenase activase; Oxygen-evolving enhancer protein 2; Oxygen-evolving enhancer protein 2-1; ATP synthase CF1 alpha subunit. On the overall these data, which show a marked increase in both tissues of main components of the carbon reduction cycle, appear to be well correlated with the plant growth-promoting effect of biochar treatment already reported (Roberts *et al.*, 2015). Interestingly, up-regulation of Malate dehydrogenase occurred only in berries, a fact that could be linked to accelerated ripening of biochar-treated berries. In fact, malate dehydrogenase determines malate oxidation during ripening (Rocco *et al.* 2006).

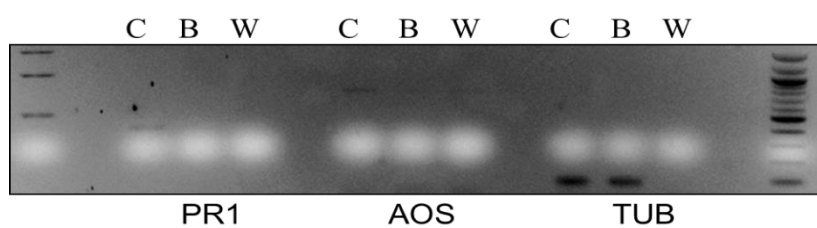
To further analyse possible differences in the capability to respond to stresses of biochar-treated tomato plants as compared to control ones. The transcriptional levels of two genes involved in two different biotic stress response pathways were evaluated in tomato leaves: the ...*nome*....(AOS) gene, the key gene in the jasmonic acid biosynthetic pathway and the Pathogenesis Related protein 1 (PR1) gene, whose transcription is induced by salicylic acid. RT-PCR results (Fig. 3) showed that the AOS and PR1 genes were expressed only in control samples. These data are in good accordance with what observed by Viger *et al.*(2014) . In fact, they demonstrated that biochar induces a clear down-regulation of different genes involved in defense against pathogens, and inactivation of both SAR and ISR pathways.



**Figure1.** Tomato (*L. esculentum*) 2-DE proteomic maps of fruits grown on control soil (A) and on biochar added soil (B). Protein extracts were analysed in first dimension (pH 4–7 linear IPG, 17 cm); second dimension was performed on a vertical slab gel (12% T). Protein detection was achieved using colloidal CBB G-250 staining.



**Figure 2.** Tomato leaves (*L. esculentum*) 2-DE proteomic maps, sample grown on control soil (A) and on biochar added soil (B). Protein extracts were analysed in first dimension (pH 4–7 linear IPG, 17 cm); second dimension was performed on a vertical slab gel (12% T). Protein detection was achieved using colloidal CBB G-250 staining.



**Figure 3.** RT-PCR on leaves samples grown on control soil and biochar soil in which primers for PR1, AOS and housekeeping TUB (coding for  $\alpha$ -tubulin protein) were used. C = control, B = biochar, W = white



BERRIES					
DOWN-REGULATED PROTEINS					
Spot	Name	Accession/EST	ID Method	Sequence cover (%p)	Fold change (biochar/ctrl)
6	APX	Q8LSK6	PMF	28(12)	0.4
7	Embryo-abundant EMB	Q8S271	MS/MS	31(4)	0.5
8	PP2C	Q6QLU0	MS/MS	52(7)	0.7
9	Chaperonin 21	U215407	MS/MS	41(8)	0.4
10	Gluthathione-S-transferase j class	U215144	MS/MS	64(15)	0.5
13	17.6 kDa class 1 Shsp 1	Q9SYU8	MS/MS	46(7)	0.2
UP-REGULATED PROTEINS					
1	Ribulose biphosphate carboxylase/oxygenase activase	O49074	PMF	12(5)	2.9
2	Malate dehydrogenase cytosolic	U212714	GM	31(14)	4.2
3	Malate dehydrogenase cytosolic	U212714	PMF	30(14)	2.4
4	Ribulose biphosphate carboxylase large chain	P48698	PMF	36(18)	3.5
5	Oxygen_evolving_enhancer_protein 1	P23322	PMF	46(10)	3.4
11	Malate dehydrogenase cytosolic (fragment)	U212714	PMF	33(15)	2.6
12	Ribulose biphosphate carboxylase small chain 2A	PO7179	PMF	34(7)	3.2
LEAVES					
DOWN-REGULATED PROTEINS					
10	17.6 kDa class I Shsp1	Q9SYU8	PMF	55.2(17)	0.4
12	Disulfide isomerase-like-1-1	K4C6L0	PMF	12.4(5)	0.6
UP-REGULATED PROTEINS					
1	ATP Synthase CF1 alpha subunit	A0A0C5CHA6	PMF	10.1(4)	2.9
2	RAB GTPase homolog E1b	K4BK69	PMF	24.9(11)	3.1
3	Ribulose biphosphate carboxylase large chain	A0A0C5CHE6	PMF	24.7(16)	3.4
4	Oxygen evolving enhancer protein 1-2	Q9S841	PMF	33.5(14)	2.3
14	Ribulose biphosphate carboxylase oxygenase activase	K4D489	PMF	51.8(188)	2.8
15	Ribulose biphosphate carboxylase oxygenase activase	K4D489	PMF	50.3(69)	3.3
23	Oxygen_evolving_enhancer_protein 2 chloroplastic	P29795	PMF	43.3(42)	4.8

**Table1.** Spots identified by peptide mass MALDI-TOF fingerprint (PMF), mLC-ESI-IT-MS-MS (MS/MS) or gel matching (GM) analysis from 2-DE gels are reported. Spot number, protein name, accession/EST number, method of identification, number of peptides identified, and fold change for biochar versus control sample are listed. Proteins were considered as differentially expressed when a relative fold change > 2.0 or < 0.5 was measured.

## Conclusion

Sustainable development is not one of the possible choices, but it is the only model that can be implemented over the next twenty years to fight climate change (Directive 2009/28 / EC). Only green energy policies and environmental protection can do an appreciable climate mitigation and reverse the negative effects of global warming. In this perspective, soil amendment with biochar can be a valuable practice to reduce the amount of CO<sub>2</sub> in atmosphere while at the same time improving soil quality and productivity. Despite renewed interest in the use of this sustainable resource, scientific information about its effects on plant growth and physiology are still very scarce. Our work was aimed to shed light at molecular level on the effect of biochar treatments on tomato plants of the high-quality variety San Marzano, from South Italy. Results obtained by proteomic and RT-PCR approaches allowed to ascertain that biochar is able to induce in tomato berries and leaves a significant increase of enzymes deputed to carbon metabolism, an effect that is fairly correlated with the well-documented growth-promoting effect of biochar. At the same time, a marked decrease in the expression of genes involved in the response to abiotic and biotic stress was observed. This latter finding, suggesting that also basal levels of expression of defense genes are costly in plants (Corrado *et al* 2011) thus limiting plant growth, is intriguing and prompts further work to shed light on the molecular relationship between plant growth and environmental fitness.

## Reference

- Abe H., J. Onnishi, M. Narusaka, S. Seo, Y. Narusaka, S. Tsuda, M. Kobayashi. (2008) Arabidopsis-thrips system for analysis of plant response to insect feeding. *Plant Signal Behav* 3 (7), 446-447
- Botkin DB, Saxe H, Araujo MB, Betts R, Bradshaw RHW, Cedhagen T, Chesson P, Dawson TP, Etterson JR, Faith DP, Ferrier S, Guisan A, Hansen AS, Hilbert DW, Loehle C, Margules C, New M, Sobel MJ, Stockwell DRB. (2007) Forecasting the effects of global warming on biodiversity. *Bioscience.*, Volume 57, Issue 3, 227–236
- Caverzan A, Passaia G, Barcellos Rosa S, Werner Ribeiro C, Lazzarotto F and Margis-Pinheiro M. Plant responses to stresses: Role of ascorbate peroxidase in the antioxidant protection. (2012) *Genet Mol Biol.* 35(4 suppl): 1011-1019.
- Corrado G, Agrelli D, Rocco M, Basile B, Marra M and Rao R (2011). Systemin-inducible defence against pests is costly in tomato. *BIOLOGIA PLANTARUM*, vol. 55, p. 305-311
- Dawson TP Jackson ST, House JI, Prentice IC, Mace GM. Beyond Predictions. (2011) *Biodiversity Conservation in a Changing Climate.* Science. 2011; 332:53–58.
- Elad Yigal, Eddie Cytrin, Yael Meller Harel, Beni LEW and Ellen R. Graber. (2011) The Biochar Effect: plant resistance to biotic stresses. *Phytopathol. Mediterr.* 50, 335–349.
- Farmer EE. Alméras, V. Krishnamurthy. (2003) Jasmonates and related oxylipins in plant responses to pathogenesis and herbivory. *Current Opinion in Plant Biology*, Volume 6, Issue 4, Pages 372-378
- Graber E. R, Y. M. Harel, M. Kolton, E. Cytryn, A. Silber, D. R. David, L. Tsechansky, M. Borenshtein, Y. Elad.. (2010) Biochar impact on development and productivity of pepper and tomato grown in fertigated soilless media. *Plant and Soil*, Volume 337, Issue 1–2, pp 481–496. Gruber CW, Cemazar M, Heras B, Martin JL and Craik DJ. Protein disulfide isomerase: the structure of oxidative folding. (2006). *Trends in Bioch Scien.* 31(8): 455-464.
- Harel Y. MY. Elad, D. Rav, D. Menachem, R. Shulchani, B. Lew, E. R. Graber. (2012) Biochar mediates systemic response of strawberry to foliar fungal pathogens. *Plant and Soil*, Volume 357, Issue 1–2, 245–257.
- Haslback M (2002). sHsps and their role in the chaperone network. *Cell Mol Life Sci*, 2002; 59(10):1649-57.

- Lichtenthaler HK (1998). The stress concept in plants: an introduction. *Ann N Y Acad Sci*, 851: 187-98
- Rao M.VH. Lee, R. A. Creelman, J. E. Mullet, K. R. Davis. (2000) Jasmonic Acid Signaling Modulates Ozone-Induced Hypersensitive Cell Death. *The Plant Cell*, Vol. 12, 1633–1646.
- Rocco M, D’Ambrosio C, Arena S, Faurobert M, Scaloni A and Marra M. (2006) Proteomic analysis of tomato fruits from two ecotypes during ripening. *Proteomics Volume 6, Issue 13* 3781–3791
- Roberts DA, Paul NA, Dworjany SA, Bird MI and de Nys R. Biochar from commercially cultivated seaweed for soil amelioration (2015). *Sci Rep.* 9;5:9665.
- Samimi A, Zarinabadi S (2012) *Journal of American Science*. Reduction of Greenhouse gases emission and effect on environment *J Am Sci* ; 8(8):1011-1015
- Sun W, Montagu M.V, Verbruggen N (2002) Small heat shock proteins and stress tolerance in plants. *Biochimica et Biophysica Acta* 1577 1 – 9
- Vernieri, A Ferrante, S Mugnai e A Pardossi, (2006) Stress abiotici e bilancio ormonale nelle piante coltivate *Italus Hortus* 13 19-31.
- Viger M, Robert D. Hancock, Miglietta F, Taylor G (2014) More plant growth but less plant defence? First global gene expression data for plants grown in soil amended with biochar. *GCB Bioenergy* 7, 658–672.
- Wang W, Vinocur B, Shoseyov O, Altman A Wang et al., (2004) Role of plant heat-shock proteins and molecular chaperones in the abiotic stress response. *Trends Plant Sci*; 9(5): 244-52 3 missing
- Wasternack C, Hause B, (2013) Jasmonates: biosynthesis, perception, signal transduction and action in plant stress response, growth and development. *Annals of Botany*. Volume 111(6):1021-1058

## IMPACT OF SLAVOL MICROBIOLOGICAL FERTILIZER ON SOIL MICROORGANISMS DURING CAULIFLOWER (*BRASSICA OLERACEA* L.VAR. *BOTRYTIS*) GROWTH

Daniela DIMOVSKA<sup>1\*</sup>, Zvezda BOGEVSKA<sup>1</sup>, Igor ILJOVSKI<sup>1</sup>, Maria ZDRAVKOVSKA<sup>1</sup>, Dzoko KUNGULOVSKI<sup>2</sup>, Natalia ATANASOVA- PANCHEVSKA<sup>2</sup>

<sup>1</sup> Faculty of Agriculture Sciences and Food – Skopje, Ss Cyril and Methodius University in Skopje, Republic of Macedonia

<sup>2</sup> Faculty of Natural Sciences and Mathematics – Skopje, Ss Cyril and Methodius University in Skopje, Republic of Macedonia

\*Corresponding author: ddimovska1@gmail.com

### Abstract

The experiment was conducted in order to determine the influence of the microbiological fertilizer Slavol on the number of microorganisms in the soil where cauliflower was grown in open field.

It was used the variety Barsezona F1 which was grown in Skopje region during three years (2011, 2012, 2013). The treatments were as follows: Ø control - without use of microbiological fertilizer, V-1 - foliar treatment every 7 days with 0.1% solution of Slavol and V-2 - drip irrigation treatment every 2 days with 0,1% solution of Slavol. The total number of bacteria and the number of examined physiological groups of microorganisms in the rhizosphere (nitrogen fixing bacteria  $10^{-4}$ , cellulolytic microorganisms  $10^{-4}$ , yeasts  $10^{-4}$ , nitrifying microorganisms  $10^{-4}$  and molds  $10^{-3}$ ) were counted.

According to the results during three years examination highest average number of total bacteria was determined in the variant V-1 and V-2 in comparison to control and the soil before planting. The number of nitrogen fixing bacteria was from 4863519 in V-1 to 4923807 in V-2. The number of cellulolytic microorganisms was from 3288588 in V-1 to 3312114 in V-2. The number of yeasts was lower than control (3813208) and was from 3681506 in V-1 to 2585089 in V-2. The number of nitrifying microorganisms was very high in V-1 (7502534) and V-2 (7323212) in comparison to control (1331717) and fallow land. The number of molds was higher in V-1 (422192) and V-2 (352608) in comparison to control (340149) but lower in comparison to fallow land (474851).

**Keywords:** *cauliflower, microbiological fertilizer, groups of microorganisms, rhizosphere*

### Introduction

The activity of microorganisms in agro-ecological systems is influenced by the physical-chemical properties of soil, climatic conditions, agro-technical measures, plant species, pesticide and heavy metals content (Milosevic et al., 1997; Jarak et al., 2003).

In the production of some vegetable crops which produce relatively high yields, intensive soil cultivation, different agro-technical measures, large amounts of mineral fertilizers and pesticides are used which contributes to disturbance of balance between microorganisms and soil, soil degradation and overall disruption of the course of natural processes.

In our study, cauliflower (*Brassica oleracea* var. *botrytis*) was used which belongs to *Brassicaceae* L. family. It is characterized by high nutritional value and medicinal properties due to its chemical composition. Cauliflower is rich in many vitamins, minerals, proteins, carbohydrates and fats. The cauliflower is characterized by a pleasant and refreshing taste and it can be consumed freshly prepared in a different way or processed. Thus it is appreciated in households and industry throughout the year.

For high and qualitative yields in the cauliflower, it is necessary to fertilize with a combination of organic and mineral fertilizers Simonov and Aladzajkov (1985).

In order to improve the microbiological activity in the rhizosphere, today by improving the isolation method and obtaining pure cultures of microorganisms there are microbiological fertilizers – bio-fertilizers that treat crops with different methods of application (with a sprinkler or drip system). In order to improve growing conditions and obtain greater and better yields of cauliflower, microbiological fertilizer Slavol (combination of 6 bacteria, natural vitamins, enzymes and bio stimulators) was used. The objective of the research was to count the number of microorganisms in the soil treated with the microbiological fertilizer Slavol in cauliflower.

### Materials and methods

The experiment was conducted in the vicinity of Skopsko, the Jurumleri settlement with GPS coordinates 41 ° 58'20.84" north and 21 ° 33'24.44" east of 276m altitude, on the soil type alluvium, during 2011, 2012 and 2013.

The subject of the trial was cauliflower (*Brassica oleracea L. var. botrytis*), hybrid Barcelona F<sub>1</sub>, which was grown by seedlings in cold beds, and planted in the open field.

During 2011 and 2012, the sowing was carried out on May 20, and the planting was on July 16, while in 2013 the sowing was on May 25, and the planting was on July 17.

The trial was designed according to randomized complete block design according to the Fisher Method in three treatments, with four repetitions.

The treatments were based on the time and method of treatment with the microbiological fertilizer, Slavol, which is a combination of 6 bacteria belonging to the group of free nitrogen fixing bacteria *Azotobacter chroococcum* (108 cfu / ml) *Azotobacter vinelandii* (108 cfu / ml), *Derxia sp.* (109 cfu / mL), and phosphorous decomposing bacteria *Bacillus licheniformis* (109 cfu / mL), *Bacillus subtilis* (109 cfu / mL), *Bacillus megaterium* (109 cfu / mL). It also contains natural vitamins, enzymes and bio-stimulators.

The treatments were according following order:

1. Ø control - without the use of microbiological fertilizer;
2. Variant 1 (V-1) – treating the seedlings by immersion in a solution of 5 L water and 50 mL Slavol for 5 minutes and treating during vegetation through leaves with portable sprayer every 7 days with a solution of 2 mL Slavol dissolved in 2 L water and
3. Variant 2 (V-2) - treating the seedlings by immersion in a solution of 5 L water and 50 mL Slavol for 5 minutes and treating during vegetation through drip system (spaghetti type) with a solution of 150 mL Slavol dissolved in 150 L water with irrigation rate per emitter of 2 L per hour, every two days.

Also, at the end of the vegetation before harvest, three samples from the rhizosphere of the soil with cauliflower were taken for microbiological analyzes (Ø, V-1, V-2).

The following groups of microorganisms were examined before the beginning and the end of the vegetation: total number of bacteria in soil (Sarić, 1992), nitrogen fixing bacteria (Jarak, 2004), nitrifying microorganisms (Jarak, 2004), cellulolytic microorganisms (Sarić, 1992), yeasts (Govedarica et al.,1997) and molds (Govedarica et al.,1997).

Table 1 shows the composition of the growth medium for the examined groups of microorganisms.

**Table 1.** Examined groups of microorganisms, growth medium and incubation period

	Growth medium	Composition of growth medium	Incubation period
Total number of bacteria	Agar plus nutrients	agar 15 grL <sup>-1</sup> , peptone 15 grL <sup>-1</sup> , beef extract 3 grL <sup>-1</sup> , NaCl 5 grL <sup>-1</sup> , K <sub>2</sub> HPO <sub>4</sub> 0,3 grL <sup>-1</sup>	5 days on 28 °C
<b>Groups of microorganisms</b>			
Nitrogen fixing bacteria	esbi agar	sucrose 20 grL <sup>-1</sup> , K <sub>2</sub> HPO <sub>4</sub> 0,2 grL <sup>-1</sup> , MgSO <sub>4</sub> x 7H <sub>2</sub> O 0,2 grL <sup>-1</sup> , K <sub>2</sub> SO <sub>4</sub> 0,1 grL <sup>-1</sup> , CaCO <sub>3</sub> 5 grL <sup>-1</sup> , agar 15 grL <sup>-1</sup>	7 days on 28 °C
Nitrifying bacteria	Mineral medium	(NH <sub>4</sub> ) <sub>2</sub> SO <sub>4</sub> 2 grL <sup>-1</sup> , K <sub>2</sub> HPO <sub>4</sub> 1grL <sup>-1</sup> , MgSO <sub>4</sub> 0,5 grL <sup>-1</sup> , Fe SO <sub>4</sub> 0,4 grL <sup>-1</sup> , NaCl 0,4 grL <sup>-1</sup> , CaCO <sub>3</sub> 1grL <sup>-1</sup> , Mg CO <sub>3</sub> 1grL <sup>-1</sup> , agar 15grL <sup>-1</sup> , distilled water 1 L	5-7 days on 22 °C
Cellulolytic bacteria	Waxman –Garey	(NH <sub>4</sub> ) <sub>2</sub> HPO <sub>4</sub> 2.5 grL <sup>-1</sup> , MgSO <sub>4</sub> 0,5 grL <sup>-1</sup> , FeSO <sub>4</sub> 0,01 grL <sup>-1</sup> , KCl 0.5 grL <sup>-1</sup> , CaCl <sub>2</sub> 0.02 grL <sup>-1</sup> , MnSO <sub>4</sub> 0.001 grL <sup>-1</sup> , agar 15 grL <sup>-1</sup> , Na-carboxy methyl cellulose 2grL <sup>-1</sup>	7-14 days on 28 °C
Yeasts	Czapek-Dox Agar	NaNO <sub>3</sub> 2 g/L, KH <sub>2</sub> PO <sub>4</sub> 1grL <sup>-1</sup> , MgSO <sub>4</sub> 0,5 grL <sup>-1</sup> , KCl 0,5 grL <sup>-1</sup> , FeSO <sub>4</sub> 0,01 grL <sup>-1</sup> , sucrose 30 grL <sup>-1</sup> , agar 20 grL <sup>-1</sup>	7 days on 25 °C
Molds	Czapek-Dox Agar	NaNO <sub>3</sub> 2 grL <sup>-1</sup> , KH <sub>2</sub> PO <sub>4</sub> 1 grL <sup>-1</sup> , MgSO <sub>4</sub> 0,5grL <sup>-1</sup> , KCl 0,5 grL <sup>-1</sup> , FeSO <sub>4</sub> 0,01 grL <sup>-1</sup> , sucrose 30 grL <sup>-1</sup> , agar 20 grL <sup>-1</sup>	7 days on 25 °C

After the incubation, the number of microorganisms brought up in the petri plates was determined. The total number of bacteria for all physiological groups of microorganisms on gram absolutely dry soil is calculated empirically according to the formula (Sarić, 1992; Govedarica et al., 1997):

$x = \frac{a \times b \times c}{d}$	a= average number of grown colonies; b= amount of inoculum; c= dilution; d= mass of one g absolutely dry soil.
-------------------------------------	---

The obtained results were the subject of further analysis through the arithmetic mean, the ratio for calculating and representing the number of bacteria by variants compared to the number in fallow land and control.

### Results and discussion

Table 2 shows the number of all examined groups of microorganisms in order to be perceived the influence of the applied microbiological fertilizers.

**Table 2.** Impact of the microbiological fertilizer on soil microorganisms status

	Number of microorganisms (thousands)							
	Treatment				Treatment			
	Fallow land	Control	V-1	V-2	Fallow land	Control	V-1	V-2
	<b>Total number of bacteria</b>				<b>N-fixing bacteria</b>			
2011	2 047.6	2 341.5	7 364.7	12 452.4	602.38	209.76	131.65	3 561.90
2012	2 295.4	7 090.9	8 439.0	6 3230.0	3 529.55	2 241.56	3 665.85	3 595.06
2013	2 795.1	35 853.7	25 011.8	26 891.6	1 397.56	10731.71	9 607.06	7 614.46
Average	2 379.4	15 095.3	13 605.2	15 221.6	1 843.16	4 394 .34	4 863.52	4 923.81
IFL	100	634,4	571.7	639.7	100	238.4	263.8	267.1
IC		100	90.1	100.8		100	110.6	112.0
	<b>Cellulolytic bacteria</b>				<b>Yeasts</b>			
2011	595.24	763.41	3 065.88	3 014.29	809.52	600.00	2 423.53	1 157.14
2012	3 763.64	812.99	2 463.41	3 365.43	1 802.27	1 929.87	2 748 05	2 222.22
2013	682.93	5 860.98	4 336.47	3 556.63	107.50	8 909.76	5 872.94	4 375.90
Average	1 680.60	2 479.13	3 288.9	3 312.1	906.43	813.21	3 681.51	2 585.09
IFL	100	147.5	195.6	197.0	100	420.6	406.1	285.1
IC		100	132.6	133.6		100	96.5	67.7
	<b>Nitrifying bacteria</b>				<b>Molds</b>			
2011	38.10	397.6	2 305.88	1 292.86	809.52	156.10	829.65	607.14
2012	533.18	1 280.52	2 648.78	3 086.42	604.54	3.38	6.34	36.05
2013	782.50	2 317.07	17552.94	17590.36	10.49	860.98	430.59	414.63
Average	451.26	1 331.72	7 502.53	7 323.21	474.85	340.15	422.19	352.61
IFL	100	295.1	1662.5	1622.8	100	71.6	88.9	74.2
IC		100	563.3	549.9		100	124.1	103.6

\* IFL = index of fallow land; IC = Index of the control

The total number of soil bacteria is considered the main indicator of its liveliness. The total number of microorganisms is the total number of bacteria that grow on soil agar (Govedarica et al., 1999). Depending on the type of soil, the total number of bacteria ranges from several hundred thousand to hundreds million in gram-soil (Govedarica and Jarak, 1995). In the three years of examination, the total number of bacteria has increased significantly in all variants at the end of vegetation in relation to fallow land. Regarding the index control, it can be concluded that bacteria have only slightly increased in V-2 by 0.8% in terms of control, while the number of bacteria in V-1 decreased by 9.9% in comparison to control. Trials on the total number of bacteria in different species showed that in sugar beet (Govedarica et al., 1999), potato (Najdenovska et al., 2004), soybean and corn (Jarak et al., 2004), the largest number of bacteria was at the end of vegetation. For the life and activity of the free aerobic nitrogen fixing bacteria, as well as for the nitrogen fixation of great importance are some of environmental factors and influences. Thus, if the aeration of the soil is greater, the faster the development of nitrogen fixing bacteria is, and the nitrogen elevation is also higher. Soil moisture also plays a significant role, and it has been established that nitrogen fixation occurs in soils with a moisture of 3 to 25% and more. The reaction of soil and soil temperature also influence the process of nitrogen fixation, where nitrogen fixation occurs in acid soils poorly or not at all, while in soils with neutral to weak alkaline reaction, or pH from 7 to 8, nitrogen fixation takes place more intensively. The temperature range in which nitrogen fixation takes place is from 7 to 35 ° C (Micev et al., 1988). Nitrogen fixing bacteria are an important component of rhizosphere microorganisms (Malik et al., 2005), for which Mrkovač et al. (2006) indicate that they are entering into community with non-leguminous crops, which is important for sustainable agricultural production. Nitrogen fixation is of great importance in the process of maintaining the nitrogen balance in the soil, and in general the fertility of the soil. In our study, the soil has neutral to

moderate alkaline reaction. It is structural with a good ratio of capillary and non-capillary pores, which is a convenient environment for the development of nitrogen fixing bacteria. On average for the three years of examination, nitrogen fixing bacteria have increased in all variants during vegetation in relation to fallow land. The highest increase was obtained in V-2 (167.1%), then in V-1 (163.8%), while in the control the increase was 138.4%. Regarding the index to control between variants at the end of vegetation, a greater presence of nitrogen fixing bacteria was found for 10, 6% in V-1 and 12% in V-2. From the foregoing we can conclude that the variants treated with microbiological fertilizer have a higher presence of nitrogen fixing bacteria in comparison to untreated variant - control. From previous investigations regarding the presence of nitrogen fixing bacteria, Govedarica (1986) found that in the corn the nitrogen fixing bacteria were most present in the rhizosphere at the end of the vegetation. Najdenovska et al. (2004) also found the greatest presence of azotobacter in the application of pure culture *Azotobacter chroococcum* at the end of vegetation in all three years studied in potato varieties latona and lizeta. Aerobic cellulose bacteria represent a separate physiological group that has adapted to using cellulose as a source of carbon and energy. In the three years of the study, the number of cellulolytic bacteria increased in all variants in relation to fallow land. The highest increase was recorded in V-2 (97.0%). Regarding the control index at the end of the vegetation, it was found that in V-1 the number of cellulolytic bacteria increased by 32.6%, while in V-2 it increased by 33.6% (Table 2). Yeasts in soil are present in smaller numbers and are important because they decompose monosaccharaides under anaerobic conditions. Yeasts are more common in soils with acid pH and high humidity such as peat soils. Table 2 gives data on the average number of yeasts per year in relation to the index of fallow land before vegetation and at the end of vegetation in control, V-1 and V-2. In the three years of the study, the number of yeasts increased in all variants in comparison to fallow land. The highest increase was obtained in the control variant (320.6%). The average number of yeasts for three years of testing in terms of control at the end of vegetation has been reduced in variants treated with microbiological fertilizer. The presence of nitrifying bacteria in the soil depends on the presence of free oxygen and the reaction of the soil. In soils with a pH below 5 the number of nitrifying bacteria is low. Nitrifying bacteria are widely represented in nature. They are found in soils with sufficient humidity and aeration, favorable pH and nutritional conditions. The optimum temperature for their activity is 30-35°C. According to the data presented in Table 2, in the three years of the study nitrifying bacteria have increased only in the first and second variants in vegetation depending on the prevalence before vegetation. Regarding the index at the end of vegetation, between control and variants, a significant increase in the number of nitrifying bacteria was observed in the variants treated with microbiological fertilizers in comparison to control. The molds are multinuclear, filamentous, bonded, aerobic fungi, built of hyphae. The optimal conditions for the development of the mold are a temperature of about 30°C, moisture, pH 6 and free access to oxygen (Sarić, 1991). In the three years of examination in relation to the soil that is not sown (fallow land), the mold decreased in control, V-1 and V-2. Regarding the index control at the end of vegetation, between control and variants, it was determined that V-1 and V-2 had a higher number of mold compared to control (24,1% and 3,6% respectively).

### Conclusion

In our study the highest values of total number of bacteria and nitrogen fixing bacteria were found in the V-2 treatment, the presence of the yeast is the highest in control, while under fallow land conditions were found the highest presence of molds. The average number of cellulolytic bacteria is highest in V-2, and the insignificant difference in relation to V-2 is also obtained in V-1. The average number of nitrifying bacteria is greatest in variants treated with microbiological fertilizer V-1 and V-2.



## References

- Govedarica M., Jarak M. (1997). Praktikum iz mikrobiologije – treće izdanje. Univerzitet u Novom Sadu, Poljoprivredni fakultet, Institut za ratarstvo i povrtarstvo, Novi Sad. (Workbook in Microbiology - third edition, University of Novi Sad, Faculty of Agriculture, Institute of Field and Vegetable Crops, Novi Sad.)
- Govedarica M., Jarak M. (1995). Mikrobiologija zemljišta. Poljoprivredni fakultet, Novi Sad. (Microbiology of soil, Agricultural faculty, Novi Sad)
- Jarak M., Govedarica M., Đurić S. (2003). The effect of bacterization and liming in the production of red clover in acid soils. I FEMS Congress of European microbiologists, 29 jun.-3 july, Ljubljana, Slovenia, Abstract book, 392-393.
- Jarak M., Đurić S. (2004). Praktikum iz mikrobiologije. Novi Sad. (Workbook in Microbiology, Novi Sad)
- Malik B.S., Paul S., Sharma R.K., Sethi A.P. and Verma O.P. (2005). Effect of *Azotobacter chroococcum* of wheat (*Triticum aestivum*). Indian Journal of Agriculture Sciences 75:600-602.
- Micev N., Bupalov M. (1988). Zemjodelska mikrobiologija (Agricultural microbiology)
- Mrkovač N., Mezei S., Cacić N., Kovačević L.(2006). Effect inokulacije na biogenost rizosfere šećerne repe, Letopis naučnih radova, Godina 30 (2006), broj 1, strana 48–52 (Effect of the inoculation on the biogenicity of the sugar beet risotype, Yearbook of Scientific Works, Volume 30 (2006), Number 1, pp. 48-52)
- Најденовска О., Јарак М. (2004), Улога на азотобактерот во производството на еколошки високо вреден компир, Зборник на трудови од 2-от Конгрес на еколози во Македонија, 25-29.10.2003, Охрид. (Najdenovska O., Jarak M. (2004), The role of azotobacter in the production of environmentally friendly high-value potatoes. Proceedings of the 2nd Congress of Ecologists in Macedonia. 25-29.10.2003. Ohrid.)
- Sarić Z. (1992). Praktikum iz Mikrobiologija, Beograd. (Workbook for Microbiology, Belgrade)
- Симонов Д., Алаџајков Л., (1985) Специјално градинарство, Наша книга, Скопје. (Simonov D., Aladzajkov L., (1985), Particular vegetable crop production, Nasha kniga, Skopje).

## THE IMPACT OF THE VEGETATION STAGES OF WHEAT AND BARLEY ON THE DYNAMICS OF THE RHIZOSPHERE MICROFLORA

Olga NAJDENOVSKA<sup>1</sup>, Jovana NAJDENOVSKA<sup>2</sup>, Monika STOJANOVA<sup>1</sup>, Dejan TANESKI<sup>2</sup>

<sup>1</sup>Faculty of Agricultural Sciences and Food, Ss. Cyril and Methodius University, Skopje, Macedonia

<sup>2</sup>Medical faculty, Ss. Cyril and Methodius University, Skopje, Macedonia

\*Corresponding author: olganajdenovska@gmail.com

### Abstract

This paper is about the research made to determine the number of different groups of microorganisms in soil, rhizosphere and root area of wheat and barley in two different agricultural regions (Bitola and Skopje in the Republic of Macedonia). Surveys were carried out over two year period, under laboratory and field conditions. The microorganisms in the soil have direct influence on the soil's fertility the availability on the assimilatives for wheat and barley. The main objective of these studies was to determine the dynamics (number) of rhizosphere microflora in different stages of vegetation in wheat and barley. Soil samples were taken during the vegetation phases: four petals, blooming stage and physiological maturity stage of wheat and barley. This research confirms that the dynamics of the rhizosphere microflora increases when compared to the dynamics of the vegetation period, reaching their peak during the period of intense development and flowering of both cultures. Compared to the rhizosphere zone, the number of test organisms in the root zone is greater in both cultures. In the third phase of the wheat and the barley, compared to the second stage, the rhizosphere microflora is greater. The number of molds, in both regions, decreases during the vegetation in the rhizosphere, and increases in the soil more widely. The number of investigated groups of microorganisms is the largest in the rhizosphere and in the soil more widely in the maturation phase. This increase in numbers of microorganisms, is probably influenced by the root exudates of the cultures and applied agro-techniques. Exudates make selection and improve the profiling of bacteria that affect their needs the most.

**Keywords:** *Microorganisms, Soil, Rhizosphere, Wheat, Barley.*

### Introduction

The growth, development and yield of the wheat (*Triticum aestivum*, L) and barley (*Hordeum vulgare*, L), beside other factors, depend on the presence of assimilatives during the vegetation.

The microorganisms in the soil have direct influence on the soil's fertility the availability on the assimilatives for wheat and barley (Najdenovska et al., 2004).

In the soil live different types of microorganisms that constitute large part of the genetics of the soil's biodiversity. The number of the microorganisms in the soil, the mass and the activity depend on the biotic and the abiotic factors such as: the type on the microorganisms, the type on the soil, the depth and the type on the plant vegetation (Najdenovska, 2001; Govedarica and Jarak., 1995). In the soil with a well formed profile, the microorganisms sustain the structure, the level of organic material and the fertility. The dynamics of the microorganisms in the soil is the biggest in the rhizosphere, but smaller in the soil a part from the root (Najdenovska, 2013; Usman et al., 2016). The most active relations between plants and the microorganisms in the soil are established in the rhizosphere (Kennedy, 2005).

The purpose of this research was to establish the impact of the vegetation stages of wheat and barley grown in Skopje and Bitola region (Macedonia) on the dynamics of the rhizosphere microflora.

## **Materials and Methods**

This paper examined the dynamics of microorganisms in the soil wider and the rhizosphere of wheat from the Altana variety and barley of the variety rex grown in the Bitola and Skopje region (Macedonia). Microorganisms are isolated from depths of 0 cm to 30 cm on agricultural land under wheat crop (*Triticum aestivum*, L) and barley (*Hordeum vulgare*, L) in the Bitola and Skopje region. The research in this paper covered agrochemical and microbiological analysis of the land. The agrochemical analysis of soil included the pH value; Content of easily available nitrogen, phosphorus and potassium; Content of carbonates (Bogdanovic et al., 1996).

Soil samples from the (rhizosphere and the soil wider) for microbiological examinations were taken three times during the vegetation of the crops: firstly in the phase of 4 petals (autumn); secondly (May); third time at the stage of physiological maturity of wheat and barley (end of June); In this paper we examined: total number of bacteria, ammonifiers, actinomycetes, fungi and molds according to the dilution method and seeding of selective nutrients, while the examination of the physiological groups of microorganisms (nitrogen bacteria, nitrificators and aerobic cellulolytic microorganisms) was done according to the method of fertile grains Soil (Govedarica and Jarak, 1997).

## **Results and discussion**

According to the obtained results from the agrochemical analysis of the soil, it was found that the pH value of the soil solution in the two examined regions is neutral (6.80 in the Bitola region and 6.85 in the Skopje). The tested soil in both regions is well secured with nitrogen (8,20 mg / 100gr soil in the Bitola region) and 7,35 mg / 100gr soil in Skopje. Also, it is intermediately secured with phosphorus (9.50 mg / 100gr soil) in the Bitola and 13,55 mg / 100gr soil in the Skopje region. Soil in the Skopje region is well secured with potassium (25.70 mg / 100gr soil), in contrast to the soil in the Bitola region that is intermediately secured (15.70 mg / 100gr soil). In the Skopje region, the soil has a very low presence of CaCO<sub>3</sub>, (0.002%) and in the Bitola the presence of CaCO<sub>3</sub> in the soil has not been established. The results of the study of the number of microorganisms in the soil under wheat are presented in Table 1. According to Morgan et al ., (2005) and Solano et al . (2006), the number of bacteria is 2-20 times higher in the rhizosphere compared to wider soil, primarily because plants excrete 20 to 50% of photosynthetic products. In our studies (Table 1), it was found that in the wheat in the Skopje region, the number of all investigated groups of microorganisms is twice as large in the rhizosphere than in the soil more widely in the three phenological phases of the culture. The results of the examination of the dynamics of microorganisms in the land under wheat and barley in the Skopje and Bitola region are presented in Table 1. In the Bitola region the total number of bacteria, ammonifiers, actinomycetes and yeasts, as well as nitrifiers, azotobacter and aerobic cellulolytic microorganisms is greatest in the flowering stage in the rhizosphere, and the smallest (56,79) in the phase of four petals in the soil wider (Bever et al., 2012). The highest representation of the mold is in the stage of blooming of wheat in the soil wider (56, 56), and the lowest in the phase of physiological maturation in the rhizosphere (24). The greatest dynamics of the total number of bacteria, ammonifiers, actinomycetes and yeasts is in the barley rhizosphere of the blooming phase (5590, 2650, 228, 97), the smallest in the soil in the phase of 4 petals (2100 , 1100, 123.35). The highest prevalence of azotobacteria and nitrification was observed in the blooming stage in the rhizosphere (84, 63), and the smallest in the soil in the pheno-phase of four petals (49, 37). The number of investigated groups of microorganisms is the largest in the rhizosphere and in the soil more widely in the maturation phase (Table 4). Exudates make selection and improve the profiling of bacteria that affect their needs the most. (Saharan i Nehra, 2011).

Table 1. Dynamics of microorganisms in the soil and rhizosphere in wheat

Variants	Pheno Phases	Total bacteres	Amonifcators	Actinomices	Yeasts	Fungi	Azotobacter	Nitrificators	Celulolitic mo
		10 <sup>4</sup>		10 <sup>3</sup>	10 <sup>4</sup>			%	
WHEAT: Skopje region									
Soil	A	2100	1100	123	35	63	49	37	78
Soil	B	3250	1290	154	40	72	68	42	84
Soil	C	3220	1210	154	41	71	66	43	84
Rhizosphere	A	5220	1310	154	51	52	58	53	80
Rhizosphere	B	6650	3210	215	88	41	86	69	91
Rhizosphere	C	5330	2360	186	69	34	80	60	81
WHEAT: Bitola region									
Soil	A	3500	1230	144	52	34	49	37	78
Soil	B	4230	1980	188	102	56	68	43	81
Soil	C	4150	1870	187	111	56	66	44	80
Rhizosphere	A	6300	2020	231	69	30	56	49	79
Rhizosphere	B	9600	3410	445	199	25	84	63	86
Rhizosphere	C	6770	2340	346	121	24	79	58	78
BARLEY: Skopje region									
Soil	A	2100	1100	123	35	68	49	37	78
Soil	B	2995	1320	228	77	74	68	43	81
Soil	C	2916	1350	251	73	72	66	44	80
Rhizosphere	A	2860	1310	169	64	44	56	49	79
Rhizosphere	B	5590	2650	258	97	32	84	63	84
Rhizosphere	C	4600	2290	198	73	29	79	58	78
BARLEY: Bitola region									
Soil	A	2860	1230	144	52	34	62	43	91
Soil	B	3500	1966	286	103	52	80	48	95
Soil	C	4150	1882	283	101	50	81	49	96
Rhizosphere	A	4900	1980	192	70	28	63	55	66
Rhizosphere	B	6220	2880	420	212	23	86	63	86
Rhizosphere	C	4650	2010	314	226	22	83	79	71
Phenophase: A = 4 livestock, B = flowering, C = physiological germination									

### Conclusion

Based on the results obtained in these investigations, it can be concluded that the dynamics of microorganisms, except for the wheat and barley rhizosphere rips, increase in the two regions during the vegetation of the culture in relation to microorganisms in the soil more widely, which is conditioned by the increase of the concentration of exudates on and around the root system and their composition. The number of molds, in both regions, decreases during the vegetation in the rhizosphere, and increases in the soil more widely.

The number of investigated groups of microorganisms is the largest in the rhizosphere and in the soil more widely in the maturation phase (Table 4). Exudates make selection and improve the profiling of bacteria that affect their needs the most. (Saharan i Nehra, 2011).

## References

- Bogdanovic M., Velkonija N., Rasz Z. (1966): Chemical methods of soil analysis. Book I, sine loco, 44, 162, 184, 189
- Bever, J. D., Platt, T. G. & Morton, E. R. (2012): Microbial population and community dynamics on plant roots and their feedbacks on plant communities. *Annu. Rev. Microbiol.* 66, 265–283
- Govedarica, M., Jarak, M. (1995): Soil Microbiology. Agriculture faculty, Novi Sad, University in Novi Sad, 45 -124, Novi Sad
- Govedarica M., Jarak M. (1997): Practical book of microbiology, University in Novi Sad, Serbia
- Kennedy A.C., (2005) : Rhizosphere, in: Principles and Applications of Soil Microbiology, D.M., Sylvia, J.J., Fuhrmann, P.G., Hartel, and D.A., Zuberer, eds., 2<sup>nd</sup> ed. Pearson, Prentice Hall, New Jersey, pp. 242-262;
- Morgan, J. A. W., Bending, G. D., White, P. J. (2005): Biological costs and benefits to plant–microbe interactions in the rhizosphere. *Journal of Experimental Botany* 56: 1729-1739.
- Najdenovska O., Jarak M., Colo J. (2013): Microbiology. Faculty of agriculture science and food, Skopje, University St. Cyril and Methodius, Skopje
- Najdenovska O. (2001) – Azotobacter and her activity from the potatoe, disertation paper, faculty of agriculture, Novi Sad, University in Novi Sad,
- Najdenovska O., Govedarica M., Mitkova T., Djordjevic S. (2004): The possibility of nitrogen Bacter Chroococum use in the soil sown with potatoes. Original scientific paper UDC 631.461.5:635.21 – Soil and Plant, Vol. 53, No. 2, 137-146, Beograd
- Saharan B. S., Nehra V. (2011): Plant Growth Promoting Rhizobacteria: A Critical Review. *Life Sciences and Medicine Research* 2011: 1-30
- Solano R. B., Iglesia P. M. T., Probanza A., Lucas Garcia J. A., Megias M., Gutierrez Manero F. J. (2006): Screening for PGPR to improve growth of Cistus ladanifer seedlings for reforestation of degraded mediterranean ecosystems. *Plant and Soil* 287: 59-68.
- Usman S., Muhammad Y., Chiroman M. A. (2016): Roles of soil biota and biodiversity in soil environment. A concise communication. *Eurasian Journal of Soil Science* 5, 255-265

## THE IMPACT OF DIFFERENT TECHNOLOGIES ON THE PRODUCTION AND QUALITY OF TOBACCO SEEDLINGS

Romina KABRANOVA<sup>1\*</sup>, Karolina KOCHOSKA<sup>2</sup>, V. TANASKOVICH<sup>1</sup>, Robin MAVROSKI<sup>2</sup>

<sup>1</sup>Faculty of Agricultural Sciences and Food Ss.Cyril and Methodius, Skopje, Macedonia

<sup>2</sup>St.Kliment Ohridski University of Bitola, Scientific Tobacco Institute-Prilep, Macedonia

\*Corresponding author: rkabranova@yahoo.co.uk

### Abstract

Tobacco has widespread areal of distribution and great adaptation towards outdoor conditions. During the production, the time of acceptance of seedlings, and the number of accepted plants per unit area are different and primarily depend on: biological potential of the varieties, technical measures and agro-environmental factors at the time of transplanting, but mostly from the quality of seedlings. The experiment was conducted in random block system, in four replications on two varieties of oriental tobacco (*prilep NS 72*, *yaka JV 125/3*) in three variants: variant 1-control; variant 2 Float Tray -N (TERRA STAR/22:11:22+2Mg) and variant 3 Float Tray -P (CHELAN/11:49:12+2Mg). The results show a statistically significant difference between numbers of accepted plants in the studied years. The results show that a high level of acceptance of tobacco after transplantation is greatly conditioned the result of seedling production technology. Therefore it is necessary, putting into practice appropriate, modern and profitable technologies for the production of tobacco seedlings, for successful and productive tobacco production.

**Keywords:** oriental tobacco, tobacco seedlings, quality, acceptance.

### Introduction

The production of tobacco (*Nicotiana tabacum* L.) in Macedonia has a very long tradition. Tobacco is one of the most economically important agricultural crops in the country. To produce high-quality tobacco, growers must begin with healthy seedlings. The ideal seedling is disease free, resistant enough to survive transplanting shock, and available for transplanting on time. In general, earlier transplanted seedlings give better yield than late-transplanted tobacco (Smith et al., 2003). During the vegetation, a large number of factors have an impact on the tobacco that allow or interfere on the tobacco plant to express its biological and production potentials. Except the biological potential of the varieties, the largest influences have taken scientific farming methods and agro ecological conditions during the growing season. Each type of tobacco, variety of each individual area requires separate intervention, depending on the intensity of biotic agents, soil and climatic conditions, as well as cultural, traditional practices. Tobacco as an industrial crop can be grown on different soil type; therefore amounts and quality received are highly dependent on the type of soil and its physical and chemical properties. The influence of soil conditions is correlated with a complex of other environmental factors. Thus, the same soil type but with different climatic conditions, we get the raw tobacco material with different yield and quality. The production of oriental tobacco in Macedonia is located almost in all regions, mostly soils with weaker productivity. Usually, for growing oriental tobacco loamy-sandy soil with weaker productivity are preferred (Georgievski, 1990), where rarely other agricultural plant cultivation would be cost-effective. On the other hand, for successful tobacco production good quality seedlings are needed, to obtain uniformity according to morphological and biological characteristics of tobacco at field. Traditionally, seedlings in Macedonia are produced at the open field, in *cold beds*, covered with polyethylene. The most critical period in the development of tobacco occurs immediately after transplanting in the field. The plants are torn away from the previous, favorably living environment and immediately underwent to a radically different and many times unfavorable external conditions, resulting in stress in young plants. This change is significant in terms of seedlings produced by

classical mode of production, where there is an extremely large imbalance between the root system and the new conditions that often result in extended periods of stress, poor reception and slow plant growth (post transplanted shock). This shock is caused by the loss of most of the root system in the process of uprooting the seedlings from the beds (Hoyert,1979). Climatic conditions also cause the severity while transplanting (from cold and wet spring, into a rapid shift to hot and dry summer). Applied practice and scientific research in the production of tobacco seedlings indicate that on the Balkans; the production technology is quite conservative and it is very demanding to implement a new one. According to Chaluhov (1987), in spite of great importance of changing the traditional production technology, there is a lack of interest by the majority of tobacco growers to introduce new technologies for the production of oriental tobacco seedlings. The seed quality is also an important factor in production of tobacco seedlings. Karajankov (1982) concluded that seed which is large has a higher energy of germination and final germination, which is a guarantee of getting healthy and quality plants per unit area ( $m^2$ ), with well-developed root system, which remains in production in the field and provides precondition for higher yield and quality of tobacco. The production of healthy seedlings, with certain length and thickness of the stalk, is the first step in the process of excellence tobacco production. The last decade has resulted in increased awareness of tobacco producers about the importance of quality tobacco seeds. Although the seeds with a declaration of minimum 90% germination, seedling producers fail to get 90% germination during nursery stage according to Clarke et al. (2001). It is believed that there is no method that guarantees the safe production of seedlings, although today there are many computer programs for the establishment and management of parameters and analysis of the results of the process. For this reason, education and human responsibility at work are decisive factors. Improving tobacco production requires good agricultural practice which among other things involves implementation of new production technologies. The goal of the research was to contribute to the improvement of the process of tobacco seedling production in Macedonia, and whether and how the container mode - FTS production reflects first of the quality of the tobacco seedling, but continues to transplanted tobacco on the field in terms of biological and morphological properties of tobacco plants, compared to the traditional way of producing tobacco seedling. The introduction of new varieties of tobacco in the structure of production of tobacco in the country, with higher yield and quality is of great importance as well, considered Kabranova and Arsov (2009).

### Material and Methods

The experiment was placed in the region of Veles in Macedonia in the period of three years experiment (2007/2008/2009). It was conducted in random block system, in four replications on two varieties of oriental tobacco *Prilep NS 72* and *Yaka JV 125/3*, in three variants: Variant 1- Control (traditional production - means the formation of the so-called *cold improved beds* with length 10 m and width 1 m. The surface of the beds was treated with the herbicide Devrinol WP-50 (am. Napropamid). The first half dose was applied before sowing the seeds in an amount of 2 L / ha (2 ml /  $10 m^2$ ). The sowing of the tobacco was carried out with natural tobacco seeds (as a organ of reproduction), intended for the production of tobacco seedling, manually, in the amount of 0.5 g /  $m^2$ . For easier sowing and good distribution, the seeds were mixed with sand. After, the seeds were covered with a thin layer (0.5 cm) of well-sown and burnt manure, as a cover. Then the surface of the seedbeds was narrowing in order to establish a better capillary between soil and the seed. The application of the second half of herbicide Devrinol WP-50, 2 g /  $10 m^2$ , was immediately after. Follow watering (60 L /  $10 m^2$ ) and placing metal bows along the beds, at a distance of 0.7 m. The beds are covered with a transparent polyethylene. Thus formed a tunnel that opened on both sides for easier thermoregulation and ventilation. During nursery stage the seedlings were regularly watered. A week before transplanting, we stopped the watering, and the beds were completely open (to prepare the seedlings for the new conditions at the open field). Floating tray technology was applied on Variant 2 -Float Tray (TERRA STAR 22:11:22+2Mg with microelements: Fe-0,0335 %, Cu-0,017 %, Mg-0,1 %, B-0,01 %, Mn-0,017 %, Mo in traces, Zn-0,01 %, Co in traces, +EDTA

and Auxin) and Variant 3 -Float Tray (CHELAN 11:49:12+2Mg with microelements: Fe-0,0335 %, Cu-0,017 %, Mg-0,1 %, B-0,01 %, Mn-0,017 %, Mo in traces, Zn-0,01 %, Co in traces). The total quantity of fertilizer was added in water beds (0,001 % solution). The required quantity of certificated tobacco seed (granulated tobacco seed for FT variants) was sown in polystyrene trays (589 alveolus per tray) filled with peat 50% and perlite 50%); polyethylene for covering water beds; agril (as a protector towards condensation) and adequate protection against diseases, insects' damage. Conductivity of water into the pool was followed regularly for keeping the concentration of fertilizer. Thermoregulation above the pool was conducted with uncovering of the tunnel. For traditional technology of seedlings production (control) additional fertilizers were needed (1% solution is applied to seedlings), followed with application of fungicides and insecticides in order to get vigorous seedlings. All agro-technical measures for proper development of plants were made for both technologies of seedlings production, in order to obtain maximum healthy, usable seedlings per unit area. Common agro-technical measures for successful production experiment were conducted (Pearce & Palmer, 2005). Transplantation of tobacco was done manually. Transplanting time was in close connection with the meteorological conditions during the test period. After transplantation of tobacco seedlings, the number of accepted plants (%), and the crisis period (from transplanting to acceptance) were analyzed. The results were processed by SPSS for Windows, procedure Sum of squares, Model III.

### **Results and Discussion**

The period after transplanting is considered crucial for the overall production at the end of vegetation. Therefore, after transplanting, the plants should have enough available moisture well to embrace and develop the first strip of leaves. Thus, precipitation in this period should be in amount of 60 mm. In case of insufficient moisture and high temperature, however, the growth and development of plant are reduced and the plant suffers from drought. The temperature regime for oriental tobacco, together with precipitation in the initial stages of growth and development of tobacco should give a stimulating effect. As optimal, preferred temperatures throughout the vegetation period are from 22 to 25 °C. In the period from 2007<sup>th</sup> to 2009<sup>th</sup>, the climate conditions had the great importance for the development of tobacco. Distribution of rainfall was not appropriate for the plant during the growing season, while the air temperature values were relatively high. There is statistically significant difference ( $p \leq 0.01$ ) between percentage of accepted plants between 2007<sup>th</sup> compared to 2008<sup>th</sup> and 2007<sup>th</sup> compared to 2009<sup>th</sup> ( $p \leq 0.05$ ), shown below, in Table 1. The plants requirements at the field differ from those of tobacco seedlings. Therefore, plants experiencing a biological stress as result of the drastically negative changes in the environment and manifested by the reduced growth and development of plants with altered biological functions. Depending on the intensity changes of permanent damage caused by low or high temperature, drought, etc. may occur. If this stress is lower, the plants will begin with normal growth and development faster (Vukadinović, 1999). Production of tobacco continues with the transplantation of tobacco seedlings in the field, depending on the seedlings and weather conditions at the time of the year. The level of acceptance of tobacco seedlings depends on agro-environmental conditions at the time of transplanting, agrotechnical measures, but mostly from the quality of seedlings. Plants are often competitive in terms of external factors: light, CO<sub>2</sub>, H<sub>2</sub>O, oxygen, minerals, substrate (in the area where the roots develop). Competition does not always bring negative consequences, because according Vukadinović (1999), it affects the formation of the size of the habitus of plants. During the pulling-out seedlings, part of the root system is damaged, great part is reduced, and most of the roots parts are disconnected from the soil particles. In the early days after the transplant plants implement certain degree of physiological deadlock and are unable to satisfy their need for water. Therefore, wilted leaves are leading to reduction of surface assimilation of plants. In this part of the stage, the processes of degradation exceed synthesis processes. It should be pointed out the special role of stem which actually is the main reservoir of food that supports the life of the plant. Plants that have a thicker stem, are easier to accept than those who have a thin stem that often, if not die giving underdeveloped plants with weak productive opportunities. In this phase, the elevated parts



of the plant almost do not grow. After successful acceptance of plants in the field, a strong root system is developing and the plant is ready for further rapid increase (Uzunovski, 1989). The seedlings derived from the classical mode of production (variant 1 - control), have a critical period after transplantation in the average range of 7 to 10 days in both examined varieties (*Prilep NS 72* and *Yaka JV 125/3*). In that period, many of the plants suffer due to poorly developed root that after transplantation, it adapts to the new, often less favorable conditions for growth and development. Therefore it is necessary to add, replace with new plants between. Table 1 shows the variations in % of acceptance after transplanting.

Table 1. Acceptance of tobacco seedlings after transplanting (%)

Year	Variant						Year, average
	Variant 1 - control		variant 2-FT, N		variant 3-FT, P		
	<i>prilep</i> NS 72	<i>yaka JV</i> 125/3	<i>prilep</i> NS 72	<i>yaka JV</i> 125/3	<i>prilep</i> NS 72	<i>yaka JV</i> 125/3	
2007	68.5	72.5	94.8	90.8	90.0	88.0	84.1
2008	79.3	80.5	95.0	93.8	89.8	89.3	87.9
2009	77.9	75.8	94.2	91.9	91.5	89.7	86.8
Variety, average	75.2	76.3	94.7	92.1	90.4	89.0	
Technology average	75.7		93.4		89.7		

Acceptance of tobacco seedlings (Table 1) is different during the three-years trials and presented as an average of all tested varieties is: 84.1% for the 2007<sup>th</sup>, 87.9% for 2008<sup>th</sup> and 86.8% for 2009<sup>th</sup>. The three-year results show the highest average of accepted plants in variant 2-FT –N (93,4%), while 89.7% in the variant 3-FT- P. The lowest acceptance shows variant 1-control (75.7%). In the same technology of production (FT). variant 2-FT –N showed greater acceptance of tobacco seedlings which is certainly the result of the tested fertilizers. Choice of the appropriate combination of macro-and micronutrients is an additional factor that contributes to the normal development of seedlings. The seedling, because of good care and support with the necessary ingredients (nutrition, water, air, etc.) and not existence of mutual competition, were equal, with balanced growth and development of plants (strong roots, well-developed stem and number of leaves) giving the higher acceptance of plants in the field. Increased percentage of acceptance of the FT seedling was as a result of the short period of time needed for their acceptance after transplantation. Accepted plants in the field, did not respond to altering conditions, means that tobacco seedlings are completely healthy and strong enough to resist the shock of transplantation. Acceptance in the field depends on tobacco seedlings quality, expressed above all with a well developed root system and morphological uniformity in terms of its dimensions (Pearce ve Palmer, 2005). As for the differences due to the variety, the results showed that percentage of accepted plants variant 2-FT, N was 94.7% in the variety *prilep* NS 72, or 92.1% of the variety *yaka* JV 125/3. The average of accepted plants in variant 3-FT, P was 90.4% in the variety *prilep* NS 72, or 89.0% of the variety *yaka* JV 125/3. The results show greater acceptance and minimal crisis period indicate that seedling of this quality have no need of additional transplantation in rows, so the plants continue their rapid development equally. These plants are morphologically identical during growth and development in terms of height, number of leaves, the size of the leaves that are almost identical (Turshic, 2000). Statistical analysis of the values of factors: interaction between year and technology tested with F-test shows statistically significant difference at the level  $P = 0.01$  (Table 2).

Table 2. Interaction between year and technology

Dependent variant	Year		Difference of mean values between years	Standard error	Significance
	2007	2008			
% accepted plants	2007	2008	-3,8333**	0,99121	0,004
	2007	2009	-2,7400*	0,99121	0,022
	2009	2008	-1,0933	0,99121	0,299
Dependent variant	Technology		Difference of mean values between variants	Standard error	Significance
	1	2			
% accepted plants	1	2	-22,6600***	0,99121	0,000
	1	3	-18,9633***	0,99121	0,000
	3	2	-3,6967**	0,99121	0,005

\*\*\* The difference between the mean values is significant at level of 0.001

\*\* The difference between the mean values is significant at level of 0.01

\* The difference between the mean values is significant at level of 0.05

Data presented in Table 2, showed statistically significant difference between percentage of accepted plants in 2007<sup>th</sup> compared to 2008<sup>th</sup> and 2007<sup>th</sup> compared to 2009<sup>th</sup>. Also, in terms of production technology can be seen that there is a statistically significant difference between the percentage of accepted plants in variant 1-control and variant 2-FT -N, the variant 1-control and variant 3-FT -P as well as variant 3-FT, P and variant 2-FT -N.

### Conclusion

Accepting tobacco in the field depends on its quality, expressed above all with a well developed root system and morphological uniformity in terms of its dimensions; As primary limiting factor for successful transplanting, and thus better accepting, the quality of seedlings should be emphasized, or the way how tobacco seedlings are produced. Selecting the right technology for tobacco seedling production along with the selection of varieties, are key factors for getting high yield and quality of tobacco raw material, with respect to the impact of agro-environmental conditions and agro-technical measures implemented during the vegetation of tobacco; Agro ecological conditions have strong influence on its biological, morphological and technological characteristics. We believe that the future will do its own and that the data obtained from many experimental years will push tobacco producers to accept the technology of FTS (floating containers for the production of transplants), and in that way to contribute to the quality tobacco production.

### References

- Clarke J. J., Reed T.D, C. A. Wilkinson C.A. (2001). Development of a Greenhouse Tobacco Seedling Performance Index. Tobacco Science Journal, 45: 49-55.
- Georgievski K., 1990. Tutun I tutunski prerabotki – so poseben osvrt vrz ekologijata na tutunot. Stopanski pecat, Skopje, 556.
- Kabranova R, Arsov Z. 2009. Territorial and natural priorities of Macedonia important factor for tobacco production development. 113th EAAE Seminar Institute of Agricultural Economics – Belgrade (IAE), December 9th-11th 2009, Belgrade, Serbia.
- Karajankov S., 1982. Qualitative and quantitative characteristics of the tobacco seed depending on the flower cluster (master thesis); University of Sv. Kiril i Metodij - Skopje, Faculty of Agriculture - Skopje.
- Pearce B., Palmer G., 2005. Water Quality Guidelines for Tobacco Float Systems, Using Conductivity Meters for Nitrogen Management in Float Systems. Cooperative Extension Service – University of Kentucky- College of Agriculture, AGR-164.

- Smith, W. D., Fisher, L. R., Spears, J. F., 2003. Transplant production in the float system. In Flue-Cured Tobacco Information. North Carolina Cooperative Extension Service, Raleigh.
- Turshic I., 2000. UNIDO project MP/CRO/98/058, Tobacco Institute Zagreb.
- Hoyert J.H., 1979. Growing and transplanting tobacco seedlings with intact root systems. Md. Agric. Exp. Stn. Coll. Park. Misc. Public. N° 944, 29.
- Uzunoski M., 1989. Production of tobacco, Stopanski vesnik-Skopje, Faculty of agriculture Skopje, 447.
- Vukadinovic V., 1999. Ecophysiology. University of Josip Juraj Strossmayer in Osijek - internal script, Faculty of Agriculture-Osijek, 74.
- Chaluhov H., 1987. New moments in the production of tobacco seedlings. Bulgarian Tobacco, Sofia, Year. XXXII, N° 1, 21-25.

## MORPHOLOGICAL CHARACTERISTICS OF FRUITS OF SOME BIFEROUS FIG (*FICUS CARICA* L.) VARIETIES GROWN IN MONTENEGRO

Miroslav ČIZMOVIĆ\*, Tatjana PEROVIĆ

Biotechnical Faculty Podgorica, Montenegro  
Center for subtropical cultures Bar, Montenegro

\*Corresponding author: miroslaw@t-com.me

### Abstract

The results of a two-year study (2015-2016) on main morphological characteristics of eight biforous varieties of fig are presented in this paper. The research was carried out on three „white“ skin varieties ('Sultanija Bijela', 'Petrovača Bijela' and 'Skadranka'), and five „black“ skin varieties ('Crna Sušilica', 'Crna Rapka', 'Petrovača Crna', 'Crna Sultanija' and 'Krutaska Crna'). The highest weight of fruit (111.27 g) was registered in first crop of variety 'Sultanija bijela', statistically significantly higher compared with other varieties, except 'Crna Petrovača'. First crop of 'Crna Sušilica' variety had the lowest mass of fruits (21.87 g), lower than second crop of this variety, what is rarity, and also registered in 'Crna Rapka' variety. 'Crna Petrovača' (85.32 g) and 'Sultanija Bijela' (80.21 g) had the highest weight of flesh, statistically significantly higher than other varieties. 'Sultanija Bijela' has the elongated-pyriform shape of fruit (width/length ratio 0.53), while the variety 'Crna Sušilica' has flat-pyriform shape (1.14). There was a highly significant correlation between weight of fruits and weight of flesh ( $r=0.9813^{**}$ ), and weight of fruits in relation to width of fruit ( $r=0.8341^{**}$ ). Morphological characterization can be a useful tool in distinguishing varieties and the first step in their evaluation.

**Keywords:** *morphological characteristic, fig, Ficus carica L.*

### Introduction

Fig is the deciduous subtropical fruit species from the *Moraceae* family. It has  $2n = 26$  chromosomes and belongs to genus *Ficus* that includes about 800 species. The species name is related to the Caria area in Turkey, where they used to produce excellent dry figs belonging to Smyrna type (Condit, 1947). It is considered to be the first domesticated fruit species (Kislev et al., 2006), 11,000 years ago, which has been growing since ancient times in the Mediterranean region. Although, the area of former Persia is considered as a gene-center of figs, favorable agro-ecological conditions have enabled the spreading of wild and edible figs, and improved the richness of their diversity. Turkey is the largest world producer with 274.535 tons, followed by Egypt (171.062 t), Algeria 110.058 t, Morocco (102.694 t), etc. (FAO, 2016).

There is no reliable data when the fig tree was introduced into production in Montenegro. The earliest written record of the growing of fig in the Adriatic area is the Diocletian's Edict from 301. According to foreign literature sources (Zohary and Spiegel-Roy, 1975) figs were being cultivated in the Mediterranean region since the end of the Bronze Age. In our country, figs are traditionally grown on the edges of the fields or in the gardens, without the use of any cultural practices. Areas in which this species could be grown are in the coastal region up to 600 m altitudes, and in its hinterland up to the high mountains in the north. According to official agricultural census, Montenegro has 215.910 fig trees, of which 201.740 are bearing trees, with an average yield of 18 kg / tree (MONSTAT, 2011). The unifera and bifera types of varieties are represented, with black and yellow skin color. All of our fig varieties belong to common type, and produce parthenocarpic fruits (Stover et al., 2007).

The new plantation orchards were established in the last decade, and one of them nearby the Podgorica city produce organic fig. Most of the fruits are sold as a fresh fruit, the smaller part is dried, and only a small amount is processed into sweet, marmalade or other products.

Figs are easily propagated, which allows the spreading of this species. This features created two types of problem. The first is linked to spreading of viral diseases caused by cuttings propagation (Perović et al., 2016), which lead to a poorer quality of fruit and lower yields. Another type of problem is a large number of homonyms and synonyms throughout the whole fig tree growing area (Bellini et al., 2007), which creates a problem in nursery production and agronomic evaluation of varieties. According to the report of previous researchers in Montenegro, 72 genotypes of figs were registered, of which Redžić (1968) described 58. By urbanization and restitution to previous owners, this material is permanently lost. A similar problem has been described in Slovenia (Podgornik et al., 2010) and other countries (Giraldo et al., 2010). The main objective of this study is to examine and evaluate the agronomic value of some biferous fig varieties according to the current descriptor. Also, this creates the basis for solving the problems of synonyms and homonyms, which is of great importance for nursery production.

### **Materials and methods**

The research included 8 different autochthonous biferous fig varieties during two consecutive years (2015-2016). Three "white" varieties of figs were examined: 'Sultanija Bijela' (SB), 'Petrovača Bijela' (BP) and 'Skadranka' (SC). The skin color of these varieties is green with a yellowish strips in full maturity. Varieties 'Crna Sušilica' (CC), 'Crna Rapka' (CR), 'Petrovača Crna' (CP), 'Crna Sultanija' (CS) and 'Krutaska Crna' (KC) were analyzed from "black skin varieties" groups. Number 1 joined to the abbreviation of each variety indicates the first crop, which is most often referred to as "breba" in the literature (Bellini et al., 2007), and the number two is the mark for the main crop (second crop).

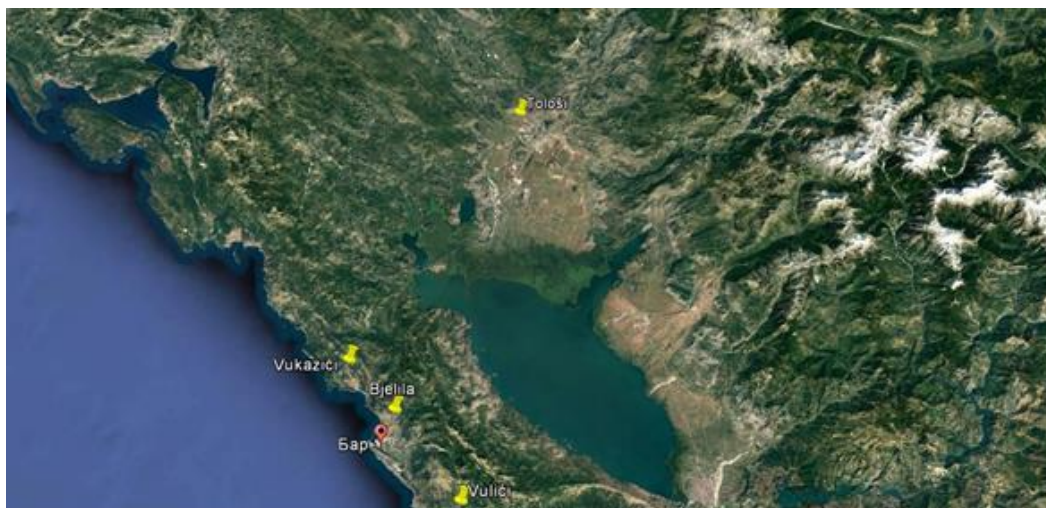


Figure 1. Sites where figs are found

All examined trees were in full bearing maturity, 14-18 years old. Varieties 'Crna Rapka' and 'Crna Petrovača' were found in the village of Vulići, Gornji Mrkojevići (252 m altitude), and the varieties 'Black Sušilica', 'Black Sultanija' and 'Krutaska Crna' were located in Bjelila, Bar (29 m altitude). Varieties 'Petrovača Bijela' and 'Skadranka' are located in the village Vukazići, Sutomore (102 m altitude), while 'Sultanija Bijela' was found in Tološi, Podgorica (37 m altitude)(Figure 1). The following parameters were tested for morphological analysis: Fruit weight (FM), pulp weight (PW), skin weight (SW, data not shown), fruit length (FL), maximum width (FW1), smallest width (FW2, DW), fruit shape (IN), stalk (penduncle) length (ST), ostiole size (OS), percentage of pulp in relation to total fruit weight (PP) and percentage of skin (PS, data not shown). The data was tested

by analysis of variance as a two factorial trials ( tested parameters and years), and the significance of differences between means was tested by the LSD test for the levels of significance 0.05 and 0.01). The correlation dependency is calculated according to Pearson's correlation matrix for all parameters. Coefficient of determination was calculated as a square of correlation (Hadživuković, 1991). Variation of morphological characteristics was calculated by Principal Component Analysis (PCA) with eigenvectors 2. Coefficients of discrimination were determined for values greater than 0.71 or smaller than -0.71 (Skinner et al., 1999). All studied parameters are evaluated by the descriptive list (Bellini et al., 2007), except FW1, FW2 and DW. These parameters should show differences in fruit shape at the horizontal axis (level) which can be useful data for distinguishing varieties.

### Results and discussion

The results of the examination of the most important morphological characteristics of the biforous fig varieties are given in Table 1. The first crop of the biforous varieties of figs is formed from

Table 1. Comparison of means (LSD) and analysis of variance for studied characteristics

Factors	FM	PW	FL	FW1	FW2	DW	IN	ST	OS	PP
Varieties	(g)	(g)	(mm)	(mm)	(mm)	(mm)		(mm)	(mm)	(%)
SB1	111.27 a	85.32 a	97.55 a	53.50 bcd	52.20 abc	1.30 e	0.53 f	2.5 efgh	3.50 g	53.70 e
BP1	94.12 b	67.76 b	60.84 cdef	58.08 ab	51.09 abc	7.06 abcd	0.95 abc	3.8 cdef	7.20 cdef	71.74 d
SC1	63.16 cd	46.76 de	61.11 cdef	54.40 bc	51.08 abc	3.32 cde	0.89 bcd	4.7 bcd	6.57 cdefg	74.88 bcd
CC1	21.87 i	13.12 i	49.27 efgh	40.93 g	36.34 f	4.59 bcde	0.83 cde	8.7 a	4.41 fg	60.11 e
CR1	41.91 fg	31.33 gh	55.96 defg	44.08 efg	40.82 ef	3.26 de	0.84 cde	3.6 cdefg	5.56 cdefg	73.90 cd
CP1	100.72 ab	85.32 a	62.40 bcde	64.26 a	56.07 a	8.19 ab	1.03 abc	1.9 fgh	10.81 a	84.72 a
CS1	58.26 de	46.21 de	62.58 bcde	45.61 defg	42.42 def	3.19 de	0.73 def	5.3 bc	5.01 efg	79.19 abcd
KC1	89.34 b	64.54 bc	71.39 bc	63.49 a	54.99 ab	8.50 a	0.89 bcd	2.8 defgh	7.55 cde	72.17 d
SB2	75.24 c	55.62 cd	75.23 b	51.69 bcde	48.74 bcd	2.94 e	0.69ef	4.5 cde	5.05 efg	73.52 cd
BP2	53.22 def	42.72 ef	44.25 gh	49.30 cdef	46.45 cde	2.85 e	1.11 a	1.7 gh	5.20 defg	80.01 abcd
SC2	58.22 de	45.35 de	46.88 gh	49.78 cdef	45.35 cde	4.43 bcde	1.07 ab	4.4 cde	8.25 abc	77.88 abcd
CC2	35.88 g	27.28 h	38.78 h	44.27 efg	41.47 ef	2.80 e	1.45 a	3.9 cdef	4.86 efg	75.93 abcd
CR2	58.88 de	45.74 de	64.86 bcd	47.01 cdefg	42.25 def	4.75 abcde	0.72 def	5.24 bc	6.62 cdef	76.93 abcd
CP2	48.51efg	40.30 efg	44.51 gh	46.44 cdefg	42.30 def	4.14 cde	1.04 ab	1.6 h	8.58 ab	83.01 ab
CS2	40.90 fg	33.24 fgh	43.14 gh	42.46 fg	39.86 ef	2.60 e	0.98 abc	6.8 ab	5.26 defg	81.56 abc
KC2	60.80 de	48.49 de	47.72 fgh	53.63 bcd	46.45 cde	7.18 abc	1.25 a	2.1 fgh	7.32 cdef	79.65 abcd
p	0.0000**	0.0000**	0.0000**	0.0003**	0.0004**	0.0253*	0.0001**	0.0002**	0.0125*	0.0002
LSD <sub>0,05</sub>	13.09	10.643	13.849	8.1741	6.9426	3.8855	0.1962	2.1604	3.1074	9.0116
LSD <sub>0,01</sub>	18.04	14.664	19.08	11.262	9.5654	5.3534	0.2703.	2.9766	4.2814	10.5623
p < 0.05 * statistically significant, p < 0.01 ** statistically highly significant										

the inflorescence of the previous year (Stover et al., 2007) and is considered to have the greatest economic impact (Redžić, 1968). The variety 'Sultanija Bijela' has the largest fruit weight in both crops, but the percentage of skin comparing to the weight of the fruit is statistically significantly higher than in other varieties (46.3% for skin). The most popular variety is 'Crna Sultanija', which has balanced fruit of both generations and excellent fruit quality. Although the quality and taste are factors that are more difficult to determine (Crisosto et al., 2010), the market favors this attribute in the varieties 'Crna Petrovača' and 'Bijela Petrovača'. CP has a large breba crop, with the thinnest skin (skin percentage in relation to the pulp is 15.27%), and this is economically the most important crop in this variety. The only imperfection of this variety is the significant cracking in ostiole region, especially in the rainy spring.

Similar descriptions of these varieties are given by researchers from Slovenia (Bandelj-Mavsar et al., 2008), which shows that these varieties are spread all over the Adriatic coast. The breba usually have the highest fruit mass comparing to main crop, although the variety 'Black Sušilica' has the larger fruits mass in the main crop, which mature when there are no other figs. That could be its

advantage. All varieties, except CC, have a short stalk (peduncle) of the fruit, which greatly complicates harvesting. Fruits harvested without a stalk are prone to deterioration (Salunkhe and Desai, 1984). The tested varieties have different shapes of fruit, from completely elongated-pyriform shaped (SB1, index of shape 0.53), asimetrical (KC1) to flat-pyriform (CC2, 1.45).

The highest fruit widths have varieties CP1 and KC1, but the difference between the largest and the lowest widths in these varieties is greatest (Table 1, columns FW1 and FW2). Due to the marked difference between these two values, it can be concluded that these varieties at the cross-section are asymmetric and have an ellipsoidal form. This feature is the specificity of these varieties, and can be crucial in their recognition. The studied characteristics of morphological traits have shown certain statistically significant correlation dependencies. The results of all correlations are given in Table 2.

Table 2 - Correlation matrix between studied characteristics

Factor	FM	PW	FL	FW1	FW2	DW	IN	ST	OS	PP	PS
FM											
PW	<b>0.9813</b> 0.0000**										
FL	<b>0.7401</b> 0.0000**	<b>0.6510</b> 0.0001**									
FW1	<b>0.8341</b> 0.0000**	<b>0.8342</b> 0.0000**	<b>0.4648</b> 0.0074**								
FW2	<b>0.8847</b> 0.0000**	<b>0.8787</b> 0.0000**	<b>0.5678</b> 0.0007**	<b>0.9504</b> 0.0000**							
DW	0.3143 0.0798 <sup>ns</sup>	0.3285 0.0665	<b>0.8342</b> 0.0000**	<b>0.6435</b> 0.0001**	0.3736 0.0352*						
IN	-0.301 <sup>ns</sup> 0.0940	-0.2017 0.2684	<b>-0.8264</b> 0.0000**	0.0608 0.7409	-0.0558 0.7617	0.3180 0.0761					
ST	-0.4485 0.0100*	<b>-0.4985</b> 0.0037**	-0.1140 0.5345	-0.4151 0.0182*	-0.4361 0.0126*	-0.0112 0.9515	-0.2191 0.2283				
OS	0.2439 0.1785	0.3312 0.0641	-0.1880 0.3029	0.4435 0.0110*	0.3487 0.0504	-0.1681 0.3576	0.3979 0.0241	-0.3417 0.0556			
PP	-0.1815 0.3202	-0.0202 0.9127	<b>-0.6063</b> 0.0002**	0.0287 0.8760	-0.0321 0.8614	0.1635 0.3713	<b>0.6479</b> 0.0001**	-0.2340 0.1974	<b>0.4834</b> 0.0051**		
PS	0.1815 0.3202	0.0202 0.9127	<b>0.6063</b> 0.0002**	-0.0287 0.8760	0.0321 0.8614	-0.1635 0.3576	-0.6479 0.3713	0.2340 0.1974	<b>-0.4834</b> 0.0051**	1.0000 0.0000**	p

p < 0.05 \* statistically significant

p < 0.01 \* statistically highly significant (values are indicated in bold)

According to the obtained results, the weight of the fruit depends largely on the weight of the flesh (0.9813), which means that the weight of the fruit depends on 96.29% of the pulp mass. Also, the greater mass of the fruit is significantly affected by the length and width of the fruit in particular less (FW2), which is the result that most of the tested varieties have a small difference of these values, so that in cross-section they are almost regular round. Also, the larger mass of the fruit are significantly influenced by fruit's length, and especially with the smaller fruit width (FW2), which is a consequence that most of the examined varieties have a small difference in these sizes, so they are almost circular at the cross-section. The index of fruit's shape is in negative correlation in accordance to the length of the fruits ( $r = -0.8264$ ), because the fruits with smaller length have a higher value of the fruit index, since it is expressed as a fruit width / length.

Table 3 – Principal Component Analysis (PCA) of morphological characteristics

Parameters	PC1	PC2
<b>FW</b>	<b>0.961276</b>	0.197404
<b>MF</b>	<b>0.961309</b>	0.061758
<b>SK</b>	<b>0.806714</b>	0.529234
<b>FL</b>	0.648935	<b>0.702312</b>
<b>FW1</b>	<b>0.95438</b>	-0.17501
<b>FW2</b>	<b>0.961951</b>	-0.02781
<b>DW</b>	0.539942	-0.49396
<b>IN</b>	-0.16002	<b>-0.85162</b>
<b>ST</b>	-0.61062	0.363316
<b>OS</b>	0.481377	<b>-0.75788</b>
<b>PF</b>	-0.06489	<b>-0.9096</b>
<b>PS</b>	0.06489	<b>0.90960</b>
Explained variation	5.686404	4.17789
Eigenval	5.759079	4.105215
Total variance %	47.99232	34.21012
Cumulative variance	47.99232	82.20244

The results of the PCA analysis explains the larger part of the morphological variability between the tested varieties (82.20%). PC1 explains almost 48 % variability, and the highest correlation dependence is between the parameters of the weight of the fruits, the weight of the pulp, the mass of the skin and the largest and the lowest fruit width.

### Conclusions

The investigated biferous fig varieties showed significant differences in morphological characteristics. Some of the examined traits significantly contribute to easier identification of varieties. Further studies should be continued in the collection planted from vegetatively propagated trees of these varieties, in order to obtain more precise data on their agronomic value.

### Acknowledgement

The results presented in this paper were obtained through the scientific project financed by the academy of science and Arts of Montenegro (CANU) and Bilateral project in cooperation between Montenegro and Slovenia. Special thanks to Mrs. Joanne Cerić for English proof read.

### References

- Bandelj-Mavsar, D., Bohanec, B., Bučar-Miklavčič, M., Butinar, B., Javornik, B., Jakše, J., Podgornik, M., Prgomet, Ž., Skrt, A., Tomažič, I., Vrhovnik, I., Valenčič, V. (2008): The common fig (*Ficus carica* L.) in Istria: morphological, molecular and some chemical characteristics. Publishing house Annales, Koper.
- Bellini, E., Giordani, E., Giannelli G., Picardi, E. (2007): The fruit woddy species. Descriptor list. University of Florence, Florence.
- Condit, I.J., (1947): The Fig. Chronica Botanica Co., Waltham, Mass., USA.
- Crisosto, H.C., Bremer, V., Ferguson, L., Crisosto, M.G. (2010): Evaluating quality attributes of four fresh fig (*Ficus carica* L.) cultivars harvested at two maturity stages. Hort Science, 45 (4), 707-7107.
- Giraldo, E., Lopez-Corrales, M., Hormaza, J.I. (2010): Selection of the most discriminating morphological qualitative variables for characterization of fig germplasm. Journal of the American Society for Horticultural Science, 135(3): 240-249.



- Hadživuković, S. (1991): Statistički metodi. Poljoprivredni fakultet. Novi Sad.
- FAO (2016): <http://faostat3.fao.org>. Accessed on 12.02.2017.
- Kislev, M.E., Hartmann, A., Bar-Yosef, O. (2006): Early domesticated fig in the Jordan Valley. *Science*, 312, 1372-1374.
- MONSTAT (2011): <http://www.monstat.org/>. Accessed on 14.09.2015.
- Perović, T., Hrnčić, S., Čizmović, M., Lolić, B., Đurić, G., Delić, D. (2016): First report of Fig mosaic virus, Fig leaf mottle-associated virus 1 and Fig mild mottle-associated virus infecting Fig (*Ficus carica*) in Montenegro. *Journal of Plant Pathology*, 98 (3), 677-697.
- Podgornik, M., Vuk, I., Vrhovnik, I., Bandelj-Mavsar, D. (2010): A survey and morphological evaluation of fig (*Ficus carica* L.) genetic resources from Slovenija. *Scientia Horticulture*, 125, 380-389.
- Redžić, M. (1968): Kultura smokve u subtropskoj zoni CR Crne Gore s posebnim osvrtom na mogućnost i značaj proizvodnje stonih sorti. *Agriculture and Forestry*. 14 (3), 1-14. Podgorica.
- Skinner, D.Z., Bauchan, G.R., Auricht, G., Hughes, S. (1999): A method for the efficient management and utilization of large germplasm collections. *Crop Science*, 39, 1237-1242.
- Salunkhe, D.K., Desai, B.B. (1984): *Postharvest Biotechnology of Fruits, Volume II*. CRC Press, Boca Raton, Florida.
- Stover, E.M., Aradhya, L., Ferguson, L., Crisosto, H.C.(2007): The Fig, Overview of an ancient fruit. *Hort Science*, 42, 1083-1087.
- Zohary, D., Spiegel-Roy, P. (1975): Beginnings of fruit growing in old world. *Science*, 187, 319-327.

## ALLELIC DIVERSITY OF GLUTENINS SUBUNITS IN MOROCCAN DURUM AND BREAD WHEAT AND THEIR RELATIONSHIPS WITH GLUTEN STRENGTH

Mona TAGHOUTI<sup>1\*</sup>, Fatima GABOUN<sup>1</sup>, Aicha CHICAR<sup>2</sup>, Mustapha KANDIL<sup>2</sup>, Athmane ROCHDI<sup>3</sup>

<sup>1</sup> Plant breeding research unit, National Institute of agronomic Research, Rabat Morocco

<sup>2</sup> Department of biology, Chouaib Doukkali University, El Jadida, Morocco

<sup>3</sup> Department of biology, Ibn Tofail University, Kenitra

\*Corresponding author: taghoutimouna@yahoo.fr

### Abstract

Wheat endosperm storage proteins, particularly glutenins, are the major components of gluten that determine wheat dough processing qualities. The genetic variability of high (HMW) and low (LMW) molecular weight glutenins using Sodium Dodecyl Sulfate Polyacrylamid Gel Electrophoresis (SDS-PAGE) was analyzed for forty-three Moroccan wheat varieties including twenty three durum wheat (*Triticum durum*) varieties and twenty of bread wheat (*Triticum aestivum*) varieties. Gluten strength was assessed by SDS sedimentation test and Zeleny volume for durum and bread wheat respectively. The analysis of the glutenin composition for durum wheat revealed the presence of six alleles: silent "c" allele for the Glu-A1 locus noted in all durum wheat varieties and five alleles for the Glu-B1 locus: Glu-B1b, Glu-B1e, Glu-B1d, Glu-B1a and Glu-B1c alleles. For bread wheat varieties, electrophoretic analysis showed the presence of ten alleles: three alleles for the Glu-A1 locus; Glu-A1c, Glu-A1a, and Glu-A1b, five alleles at Glu-B1 locus; Glu-B1b, Glu-B1c and GluB1i and two alleles (a), (b) at Glu-D1 locus. Furthermore, results showed significant differences between the durum and bread wheat varieties for gluten strength. Significant association has been found between HMW and LMW glutenins subunits composition and gluten strength. Proteins HMW subunits Glu-A1b, Glu-B1c, Glu-B1i, and LMW-Type 2 subunits were found positively correlated with gluten strength. The allelic identification of glutenins subunits and their association with gluten strength constitute an important tool in wheat breeding program for the improvement of bread and pasta making quality of bread and durum wheat.

**Keywords:** *Wheat, Glutenins, Allelic diversity, Gluten strength.*

### Introduction

Wheat is a major component of most diets of the world because of its agronomic adaptability, ease of storage, nutritional goodness, and the ability of its flour to produce a variety of foods. The unique viscoelastic property of dough produced from wheat flour is responsible for the universal use of wheat for a wide range of products such as bread, cakes, biscuits/cookies, pizza, noodles, pasta, couscous and many of traditional products. The quality traits are mainly determined by the quantity and quality of gluten proteins. Wheat storage proteins are the major protein components of gluten. The high molecular weight glutenin subunits (HMW-GS) are storage proteins synthesized in the seeds of wheat, they are encoded by the Glu-1 gene located on the long arms of the homoeologous group one chromosomes, with each locus comprising two linked genes encoding x and y-types subunits (Payne, 1987). Consequently, two loci (Glu-A1, GluB1) encoding four HMW-GS are present in tetraploid wheat (*Triticum durum*, 2n=4x=28, AABB) and three loci (Glu-A1, GluB1 and Glu-D1) encoding six HMW-GS are present in hexaploid wheat (*Triticum aestivum*, 2n=6x=42, AABBDD).

Electrophoretic studies have revealed appreciable polymorphism in the number and mobility of HMW-GS in both bread wheat (Branlard et al., 2001; Oury et al., 2010) and durum wheat (Brites et al., 2001; Gregová et al., 2012). Consequently, the Glu-1 loci present multiple alleles. Payne and

Lawrence (1983) summarized the range of the alleles at the Glu-1 loci as three allelic forms at the Glu-1A, 11 alleles at the Glu-1B, and six alleles at the Glu-1D. Since the publication of this catalog of alleles at Glu-1 loci, more have been identified. Furthermore, the main low molecular weight glutenin subunits (LMW-GS) are controlled by genes called Glu-3 located on the short arms of group 1 chromosomes. The allelic diversity of LMW-GS in durum and bread wheat has been largely studied (Carillo et al., 1990; Nieto-Taladrez et al., 1997).

The resulting multi-allelism of glutenins influences the rheological property of gluten. Indeed, the correlation between end-use quality of wheat and specific composition of seed storage prolamin proteins has been recognized (Payne, 1987; Martinez et al., 2005). Consequently, breeders have taken advantage of these protein-based markers to select for dough properties. Therefore, glutenins subunits composition could serve as indicators of quality in wheat breeding program when only small amounts of the material are available and fast quality prediction is necessary. Then, appropriate germplasm with favorable glutenins variants could be introgressed through breeding.

The aim of the present investigation is to analyze high (HMW) and low (LMW) molecular weight glutenins composition of Moroccan durum and bread wheat varieties. In addition, the correlation of prolamins alleles with gluten quality among genotypes is studied.

## Materials and methods

### Plant material

20 hexaploid (*Triticum aestivum*) cultivars and 23 tetraploid (*Triticum durum*) cultivars registered in the Moroccan catalogue were used to analyze the allelic diversity of glutenins subunits. All these cultivars were released by INRA wheat breeders. International cultivars standards have been used for allelic identification of HMW-GS (Table 2).

### Electrophoresis

Polyacrylimide gel electrophoresis in the presence of Sodium Dodecyl Sulfate (SDS-PAGE) was carried out using the procedure of Singh *et al.* (1991). Ten seeds were used for each genotype; the seeds were crushed into fine powder mortar and pestle. Ten milligrams of each accession were weighed and taken in a microtube. A cleaning step with 50% *n*-propanol with intermittent vortexing was used to remove the gliadins. Glutenins were extracted and reduced from the residue in extraction buffer containing dithiothreitol DTT 1%, 2% SDS, 40% Glycerol, 0.08M Tris pH 6.8 and 0.002% bromophenol blue. The extract was incubated at 65°C for 15 min and centrifuged at 10,000 rpm for five minutes. Proteins were fractionated by electrophoresis in a vertical SDS-PAGE gel of 14% acrylamide concentration in a discontinuous Tris-HCl-SDS buffer system (pH 6.8/8.8) at 18 mA for 18 h following the method of Laemmli (1970). The gels were stained overnight with 12% (w/v) Trichloro-acetic acid solution containing 5% (v/v) ethanol and 0.05% (w/v) Coomassie Brilliant Blue R-250. De-staining was carried out with tap water. The HMW glutenin subunits were identified using the numbering system of Payne and Lawrence (1983) and compared with the patterns of known genotypes (standards).

### Gluten strength assessment

Wheat varieties were analyzed for humid gluten content by near-infrared reflectance spectrophotometry analysis using Infraneo Choppin equipment. Gluten strength appreciation was estimated by Zeleny values obtained by near-infrared reflectance spectrophotometry for bread wheat cultivars and by SDS sedimentation test following a standard method (NM, 1989) for durum wheat cultivars. Two replicate analyses were made for each genotype.

### Statistical analysis

Statistical analysis was carried out using the SAS program (Statistical Analysis System version 9.1) for descriptive statistical parameters and analysis of variance. Associations between gluten strength and glutenins alleles were investigated using Power Marker Version 3.25 software.

## Results and Discussion

### Allelic diversity of glutenins for Moroccan wheat varieties

The frequencies of 10 alleles identified at the 3 loci Encoding HMWGs are shown in Table 1. Three alleles were identified at Glu-A1, five at the Glu-B1 and two at the Glu-D1 locus. At the Glu-A1 locus, three alleles were detected in bread wheat cultivars and only one in the durum wheat cultivars; among bread wheat varieties, Glu-A1 (b) was the most common allele with a frequency of 55%. The frequency of Glu-A1 (a) and Glu-A1 (c) was 25% and 20% respectively. On the other hand, all durum wheat cultivars contain the allele Glu-A1(c).

In Bread wheat, The Glu-B1 (i) showed the highest frequency (60%) followed by Glu-B1(b) and Glu-B1(c) representing 25% and 15% of cultivars, respectively. The subunit type (20) Glu-B1 (e) was the most present in durum wheat cultivars (43%) followed by the subunits type (7+8) Glu-B1 (b) and subunits (6+8) Glu-B1 (d) with 30% and 22% respectively.

At the Glu-D1 locus, two alleles were detected with Glu-D1 (d) being the preponderant allele in the bread wheat cultivars (80%) whereas Glu-D1 (a) was present only in four bread wheat cultivars (20%). At Glu-B3 loci encoding for LMW subunits glutenins, LMW-2 was the most common type with a frequency of 78% among durum wheat genotypes.

Table 1. Frequencies (%) of high molecular weight glutenin subunits in bread wheat and durum wheat at different loci Glu-A1, Glu-B1, Glu-D1

Glu-A1			Glu-B1			Glu-D1	
Subunit (alleles)	Bread wheat	Durum wheat	Subunit (alleles)	Bread wheat	Durum wheat	Subunit (alleles)	Bread wheat
1 (a)	25	0	6+8 (d)	0	22	5+10 (d)	80
2*(b)	55	0	7+8 (b)	15	30	2+12 (a)	20
Null (c)	20	100%	7+9 (c)	25	4		
			17+18 (i)	60	0		
			20 (e)	0	43		

The pattern of glutenins allele distribution found in wheat genotypes are summarized in table 2. Six and seven different banding patterns were observed for bread and durum wheat respectively. The combination (2\*, 17+18, 5+10) subunits being the most common (55%) for bread wheat whereas, the combinations (Null, 7+8, LMW-2) and (Null, 20, LMW-2) were more frequent (26% and 30%) in durum wheat varieties.

Table 2. Plant material and allelic composition of HMW-GS and LMW-GS glutenins

Wheat species	Subunits combination	Alleles at Glu-A1, GluB1, GluD1	Varieties
Bread wheat	1, 7+8, 5+10	a, b, d	Sais, Aguilal
	1, 7+9, 5+10	a, c, d	Tilila, Saada, Saba
	Null, 7+8, 2+12	a, b, a	Teggey/32
	2*, 7+9, 5+10	b, c, d	Amal, Potam
	2*, 17+18, 5+10	b, i, d	Achtar, Arrihane, Merchouch, Rajae, Mehdiya, Kenz, Khadija, Kharrouba, Sebara
	Null, 17+18, 2+12	c, i, a	Massira, Siete/Cerros, Baraka
Durum wheat	Null, 7+9, LMW-2	c, c	Nassira
	Null, 6+8, LMW-1	c, d	Faraj
	Null, 7+8, LMW-2	c, b	Anouar, Yasmine, Louiza, Marjana,

			Ourgh, Marouane
	Null, 7+8, LMW-1	c, b	Karim
	Null, 6+8, LMW-2	c, d	Marzak, Tarek, Isly, cocorit
	Null, 20, LMW-1	c, e	Chaoui, Irden ,Amria
	Null, 20, LMW-2	c, e	Oued Zenati, Kyperounda, Zeramek Tomouh, Amjad, Jawhar, DW165

### Gluten strength assessment of Moroccan wheat varieties and relationship with glutenins composition

Statistical analysis showed significant differences among durum and bread genotypes for gluten content and gluten strength. Gluten content, with a mean value of 30%, varied from 19% in “Chaoui” durum wheat to 39% in “Massira” bread wheat variety. Whereas, gluten strength appreciated by SDS volume for durum varied from 24 ml noted in “Faraj” cultivar to 42 ml observed in “Cocorit” cultivar with a mean value of 32 ml. For bread wheat, Zeleny volume average was 23 ml varying from 12 ml in “Potam” cultivar to 40 ml in “Sebara”.

The association gluten quality–allelic composition is summarized in Table 3. Results showed significant association between low molecular weight glutenins and gluten content and gluten strength ( $P = 1\%$ ). Indeed, low molecular weight glutenin subunits play an important role in determining the quality of durum wheat (Porceddu et al., 1998). Thus confirming previous results obtained by Masci et al. (2000). Furthermore, the effects of the Glu-B1 (c) subunit are significant on gluten content; this allele contributes positively to strength and toughness of pasta according to Branlard (1999). For bread wheat, the effects of the Glu-A1 (b), Glu-B1 (b), Glu-B1 (i) and Glu-D1 subunits were significant on gluten content. The same findings were reported by Branlard et al. (2001).

Table 3a. Glutenin subunits effect on gluten quality for durum wheat

Glutenin alleles	Gluten content	Gluten strength
	F-statistic- P-value	F-statistic- P-value
Glu-A1 c	0,5277- 0,4755	0,0059- 0,9392
Glu-B1 b	0,3730- 0,5479	0,0005- 0,9820
Glu-B1 c	3,7037- <b>0,0679</b>	2,3593- 0,1394
Glu-B1 d	0,0093- 0,9240	2,0270- 0,1692
Glu-B1 e	0,3315- 0,5708	1,2967- 0,2676
LMW1	2,9874- <b>0,0985</b>	16,2025- <b>0,0006</b>
LMW2	2,9874- <b>0,0985</b>	16,2025- <b>0,0006</b>

Non Significatif :  $P > 10\%$ , Significatif:  $P < 0,01\%$

Table 3b. Glutenin subunits effect on gluten quality for bread wheat

Glutenin alleles	Gluten content	Gluten strength
	F-statistic- P-value	F-statistic- P-value
Glu-A1 a	0,6934-0,4158	1,4762- 0,2419
Glu-A1 b	3,9724- <b>0,0616</b>	0,0036- 0,9523
Glu-A1 c	1,6716- 0,2123	0,6493- 0,4321
Glu-B1 b	4,3985- <b>0,0503</b>	0,9819-0,3364
Glu-B1 c	0,2676 -0,6112	2,8588-0,1102

<b>Glu-B1 i</b>	8,0309- <b>0,0110</b>	0,6480-0,4325
<b>Glu-D1 a</b>	2,9799- <b>0,1010</b>	0,2647-0,6139
<b>Glu-D1 d</b>	2,9799- <b>0,1010</b>	0,2647-0,6139

Non Significatif : P>10%, Significatif: P<0,01

### Conclusion

The analysis of the glutenin composition for Moroccan wheat varieties revealed an important polymorphism. A total of ten alleles were detected in Glu loci. Six and seven different banding patterns were observed for bread and durum wheat respectively. The combination (2\*, 17+18, 5+10) subunits is being the most common for bread wheat. The combinations (Null, 7+8, LMW-2) and (Null, 20, LMW-2) were more frequent in durum wheat varieties. Significant associations were found between some HMW and LMW glutenins subunits and gluten strength. The allelic identification of glutenins subunits and their association with gluten strength constitute an important tool in wheat breeding program for the improvement of bread and pasta making quality of bread and durum wheat.

### References

- Branlard G. (1999). Des protéines sélectionnées pour améliorer la valeur d'utilisation des blés. (Selected proteins of wheat to improve the use value.) In Protéines végétales et alimentation humaine. Oléagineux, Corps Gras, Lipides. (ed) John Libbey Vol. 6. N°6. 513-7.
- Branlard G., Dardevet M., Saccomano R., Lagoutte F., Gourdon J. (2001). Genetic diversity of wheat storage proteins and bread wheat quality. *Euphytica* 119: 59-67.
- Brites C., Carrillo J.M. (2001). Influence of high molecular weight (HMW) and low molecular weight (LMW) glutenin subunits controlled by Glu-1 and Glu-3 loci on durum wheat quality. *Cereal Chem.* 78: 59-63.
- Carrillo J.M., Vazquez J.F., Orellana J. (1990). Relationship between gluten strength and glutenin proteins in durum wheat cultivars. *Plant Breeding* 104, 325-333.
- Gregová E., Medvecká E., Jómová K., Šliková S. (2012). Characterization of durum wheat (*Triticum durum* Desf.) quality from gliadin and glutenin protein composition. *J. Microbiol. Biotechn. Food Sci.* 1: 610-615.
- Laemmli U.K. (1970). Cleavage of structural proteins during the assembly of the head of bacteriophage T4 *Nature.* 227: 680-685.
- Martinez M.C., Ruiz M. Carrillo J.M. (2005). Effects of different prolamin alleles on durum wheat quality properties. *J. Cereal Sci.* 41: 123-131.
- Masci S., D'Ovidio R., Lafiandra D., Kasarda D. (2000). 1B-coded low-molecular-weight glutenin subunit associated with quality in durum wheats shows strong similarity to a subunit present in some bread wheat cultivars. *Theor. and App Genetics.* 100: 396-400.
- Nieto-Taladriz M.T., Ruiz M., Martinez M.C., Vazquez J.F., Carrillo J.M. (1997). Variation and classification of B low-molecular-weight glutenin subunit alleles in durum wheat. *Theor. Appl. Genet.* 95: 1155-1160.
- Norme Marocaine NM 08.1.217. (1999). Blé dur Indice de sédimentation au dodecyl sulfate de sodium (Durum wheat Sodium dodecyl sulphate sedimentation test). (ed) Service de Normalisation Industrielle Marocaine (SNIMA).
- Oury F.X., Chiron H., Faye A., Gardet O., Giraud A., Heumez E., Rolland B., Rousset M., Trottet M., Charmet G., et Branlard G. (2010). The prediction of bread wheat quality: joint use of the phenotypic information brought by technological tests and the genetic information brought by HMW and LMW glutenin subunits. *Euphytica* 171: 87-109.
- Payne P.I. (1987) Genetics of wheat storage protein and the effect of allelic variation on bread making quality. *Ann. Rev. Plant Physiol.* 38: 141-53.

- Payne P.I., Lawrence G.J. (1983). Catalogue of alleles for the complex gene loci, Glu-A1, Glu-B1 and Glu-D1 which code for the high molecular-weight subunits of glutenin in hexaploid wheat. *Cereal Res. Commun.* 11:29-35.
- Payne P.I. (1987). Genetics of wheat storage protein and the effect of allelic variation on bread making quality. *Ann. Rev. Plant Physiol.* 38: 141-53.
- Porceddu E., Turchette T., Masci S, D'Ovidio R., Lafiandra D., Kasarda D., Impilgia A., Nachit M. (1998). Variation in endosperm protein composition and technology quality properties in durum wheat. *Euphytica.* 100: 197-205.
- Singh N.K., Shepherd K.W., Cornish G.B. (1991). A simplified SDS-PAGE procedure for separating LMW subunits of glutenin. *J. Cereal Sci.* 14: 203-208.

## ASSESSMENT OF GENETIC VARIABILITY AMONG HOT PEPPER LANDRACE OF MALEH VALLEY ACCESSIONS IN MOROCCO

Nadia BENBRAHIM<sup>1\*</sup>, Mona TAGHOUTI<sup>1</sup>, Youssef ELGHZAOU<sup>2</sup>, Safae EL OUASSY<sup>2</sup>, Zine Abidine TRIQUI<sup>2</sup>, Rachida HASSIKOU<sup>2</sup>, Rachid MENTAG<sup>1</sup>, Fatima GABOUN<sup>1</sup>

<sup>1</sup>National Institute for Agricultural Research (INRA), Regional Center for Agricultural Research in Rabat, Morocco;

<sup>2</sup>Sciences Faculty of Rabat, Morocco

\*Corresponding author: nadiabenbrahim@gmail.com

### Abstract

The on-farm conservation of hot pepper in Maleh valley in Morocco has been strengthened thanks to seeds exchange between farmers in relation to its notoriety linked to morphologic and organoleptic quality. The objective of this study was to optimize the genetic resources management and to make better use in plant selection according to consumers' criteria. Thus, genetic polymorphism among and within eighteen farmers' accessions of hot pepper meta-population was assessed using fifteen quantitative and eight qualitative traits of agro-morphological characters, seed storage proteins electrophoresis (SDS-PAGE) and the random amplified polymorphic DNA (RAPD) marker. Biometrical analyses of recorded data were performed to evaluate genetic variability and genetic structure of the meta-population of hot pepper from Maleh valley according to genetic parameters. The result showed high significant differences among genotypes, accessions and among sites for almost all agro-morphological characters. The result of biochemical and molecular analysis showed a large pool genetic according to alleles frequency ( $N_a=1.480$ ), Shannon-Weaver's Index ( $I=0.285$ ), and expected heterozygosity ( $H_e=0.199$ ). The hierarchical analysis of molecular variance shows that 30% of total genetic diversity was assessed among sites, while 44% was assessed within accessions and 26% was assessed among accessions. Moreover, the genetic differentiation between pairwise accessions ( $\Phi_{PT}=0.559^{**}$ ) was exhibited among sites ( $\Phi_{RT}=0.299^{**}$ ) and among accessions ( $\Phi_{PR}=0.370^{**}$ ). Otherwise, Nei genetic distance (NeiGD) approves a strong seed or seedling exchange within or among sites according to requested criteria.

**Keywords:** hot pepper, genetic variability, agro-morphological traits, seed storage proteins electrophoresis (SDS-PAGE), random amplified polymorphic DNA (RAPD) marker.

### Introduction

Pepper (*Capsicum spp.*) is one of the most important fruit crops primarily produced in the tropical and subtropical countries. The genus of *Capsicum spp.* was introduced in Morocco through Europe during the protectorate about 1924 in context of adaptation trials of tropical crops repatriated from the conquest of the new world in the 16<sup>th</sup> century. Some of adapted varieties were spread in some geographical areas delimited by their adaptation potential such as in Maleh river valley. In Morocco, pepper is produced from two cultivated species as *Capsicum annum* L. and *Capsicum frutescens* L. Its fruits are mainly consumed as a fresh or cooked vegetable, condiment or as culinary supplement. Furthermore, hot pepper is also used in traditional medicine as anti-inflammatory and antidiabetic, in food industry as food coloring or spicy taste, in phytosanitary industry as antiseptic, or as traditional insecticide agent, and as an ornamental plant (Berke et al, (2001); Bhadragoudar et al, (2011)).

The genus of hot pepper is diploid ( $2n=24$ ), annual or perennial with an allogamic plant (15%). The average of allogamy can vary from 2 to 90% depending on the activity of pollinators (bees and trips) and synchronization of pollen and stigma maturity. The landrace of hot pepper produced in Maleh river valley is especially well adapted to salty soil. It is characterize by phenotypical variability particularly with regards to fruits. Hence, genetic diversity has to be described and



measured in order to set a genetic resources management strategy towards strengthening the on-farm conservation of a valuable local genetic base. Nowadays, several genetic tools are used to assess genetic variability such as agro-phenotypical traits, denatured proteins and DNA restriction fragment markers. The agro-morphological characterization requires a large collection of samples, a large number of traits measured at maturity stage of the plant (Aniel kumar O. et al, (2010); Peeraullee et al, (2013); Nsabiyera et al, (2013)). Moreover, most of them are under polygenic control and therefore their expression depends on environmental factors as indicated by Geleta et al, (2005) and Bhadragoudar et al, (2011)). That's why the investigations on crop diversity were turned to biochemical markers methods based on seed storage proteins electrophoresis (SDS-PAGE) (Odeigah et al, (1999); Aniel kumar O. et al, (2010)) and to molecular markers methods such as the random amplified polymorphic DNA (RAPD) marker (Bhadragoudar et al, (2011); Troconis-torres et al. (2012); Peeraullee et al, (2013)). Indeed, molecular markers are more rapid and reproducible with the ability to generate large numbers of polymorphic genetic loci. Furthermore, their expressions are not influenced by the environment (Geleta et al, (2005)). DNA markers have been well used in plant genetic resources management mainly to assess genetic diversity *ex situ* and/or *in situ* conserved, to identify the valuable genes or genotypes that could be used in plant breeding. The molecular markers, as an additional tool of phenotypical traits, seems to be useful to assess the valuable genetic diversity of landraces on-farm conserved in increasing efficiency breeding efforts to improve crop productivity.

Thus, current study is based on an assessment of genetic diversity among and within farmers' accessions and the relationship between accessions of hot pepper meta-population on-farm conserved in Maleh river valley using morphological traits, biochemical (SDS-PAGE) and molecular markers (RAPD). This characterization might be useful approach in breeding for selecting performed lines or parents for hybridization.

### **Material and methods**

Eighteen farmers' field accessions were randomly selected during 2014/15 growing season across three target localities of hot pepper production area in Maleh river valley. It concern Sidi Moussa Ben Ali (Site<sub>1</sub>) (O 7° 22', 33° 35' N), Ech-challalate (Site<sub>2</sub>) (O 7° 24', 33° 38') and Sidi Moussa El Majdoub (Site<sub>3</sub>) (O 7° 23', 33° 37' N). At field level, six plants were randomly selected along field diagonal at regular intervals according to the standards reference in the practice guide of Marchenal (1994). Data of fifteen quantitative (Table 1) and eight qualitative (Table 2) agro-morphological traits was recorded from eight ripe fruits per plant of the six collected plants per field at first harvest according to UPOV Guideline TG/76/8 (2010). The polymorphism of twelve fruits collected from each farmer's field was assessed using sodium dodecyl sulfate polyacrylamide gel electrophoresis (SDS-PAGE) as described by Laemmli (1970). Proteins bands were scored 1 or 0 depending on their presence or absence in the electrophoretic profile in the high-protein variation area between 80 KDa and 15 KDa. In addition, genetic diversity and genetic relationships between farmers' accessions was evaluated using random amplified polymorphic DNA (RAPD) marker. Total genomic DNA was extracted from young leaves using a modified CTAB method based on the protocol of Saghai-Marouf (1984). Sixty-two primers are used to evaluate genetic diversity and RAPD electrophoresis profiles of different farmer's accessions were converted into a matrix of binary data (1/0) depending on the presence or the absence of the band. Recorded phenotypical data were statically analyzed (ANOVA) using General Linear Model (GLM) ( $\alpha = 0.05$ ) (SAS software (version 9.1), while matrix of binary data from both biochemical and molecular markers were subjected to variance analysis (AMOVA) using Gen Alex software version 6.1.

**Table 1:** Descriptors of quantitative morphological traits

N°	Quantitative morphological characters	Code	unit
1	Plant height recorded at first harvest	PHT	cm
2	Number of vegetative nodes	VNT	unit
3	Number of fertile nodes	FNT	unit
4	Stem length to first bifurcation	STL	cm
5	Length between first and second fertile nodes on the primary branches	INT	cm
6	Leaf length from the base of the petiole to the end of the spin	LLT	cm
7	Leaf width recorded in the first third of the leaf	LW	cm
8	Length of the peduncle	PLT	cm
9	Fruit length in the first harvest at mature stage (red color)	FLT	cm
10	Fruit width recorded in the first harvest at mature stage (red color)	FW	cm
11	Fruit circumference measured in the upper part of mature fruit (red color) at the first harvest	FC	cm
12	Thickness of fruit wall measured in the first harvest at mature stage (red color)	TFW	mm
13	Number of fruit locules measured in the first harvest at mature stage (red color)	NFC	unit
14	Number of fruit per plant at the first harvest	NFP	unit
15	Number of seeds per fruit	NSF	unit

**Table 2:** Descriptors of qualitative morphological traits

N°	Qualitative morphological traits	Notation
1	Anthocyanin coloration of nodes	0: Absent, 3: Slight, 5: Medium, 7: Strong
2	Fruit attitude	1: Erect, 2: Horizontal, 3: Drooping
3	Fruit shape in longitudinal section	6: Trapezoidal, 7: Moderately triangular, 8: Narrowly triangular, 9: Horn shaped
4	Texture of surface	3: Smooth, 5: Slightly wrinkled, 7: Strongly wrinkled,
5	Sinuation of pericarp	0: Absent or very weak, 3: Weak, 5: Medium, 7: Strong, 9: Very strong
6	Intensity of fruit color	1: Light, 5: Medium, 7: Dark
7	Brightness of fruit color	3: Low shine, 5: Medium, 7: Strong shine
8	Shape of Fruit Apex	1: Very acute, 2: Moderately acute, 3: Rounded, 4: Moderately depressed, 5: Very depressed

## Results and discussion

### Quantitative and qualitative agro-morphological traits

Quantitative characters include plant and fruit features. Variance analysis showed a high significant variability of most of measured morphological characters within the meta-population which is structured within sites and within accessions. On account of coefficients of variation, high variability was observed for plant growth traits such as plant height (20.6%), number of vegetative nodes per plant (28.3%), stem length to first bifurcation (32.4%) and leaf size (24.4%); of yield components such as number of fertile nodes per plant (26.4%), number of fruit per plant (25.7%) and number of seeds per fruit (23.9%), and also of fruit characters such as fruit length (12.5), weight (18.2%) and thickness (15.6%), and number of locules per fruit (21.4%) (Table 3). High coefficients of variation for agro-morphological traits were also reported among pepper genotypes elsewhere by Adetula et al. (2006); Rodríguez et al. (2008); Sharma et al. (2010). Moreover, most performed traits related to plant vigor, plant productivity and fruit size were observed primarily within Site<sub>1</sub> and Site<sub>2</sub> accessions. Correlated analysis showed that fruits per plant were positively correlated with plant height ( $R=0.199^*$ ), number of vegetative nodes ( $R=0.224^*$ ) and number of fertile nodes ( $R=0.883^{***}$ ). According to variance analysis, most performed traits were observed within B<sub>1</sub> (Site<sub>1</sub>); E<sub>6</sub> and E<sub>7</sub> (Site<sub>2</sub>) and M<sub>7</sub> (Site<sub>3</sub>) accessions for plant vigor; for plant productivity, and for fruit size. Rodríguez et al. (2008) have reported that fruit length, fruit weight and number of fruits per plant are the major yield component. Thus, B<sub>1</sub>, E<sub>6</sub>, E<sub>7</sub> and M<sub>7</sub> accessions might include genotypes with farmers and consumers' desirable traits concerning plant vigor, productivity and fruit characteristics. Furthermore, low morphological traits variability was revealed within E<sub>6</sub> and M<sub>9</sub> as a consequence of farmer's selection. Indeed, genetic diversity among farmers' accessions is, in one hand, related to their genetic composition of genotypes add to the degree of field hybridization, and in other hand, a consequence of genotype x environment constraints interaction

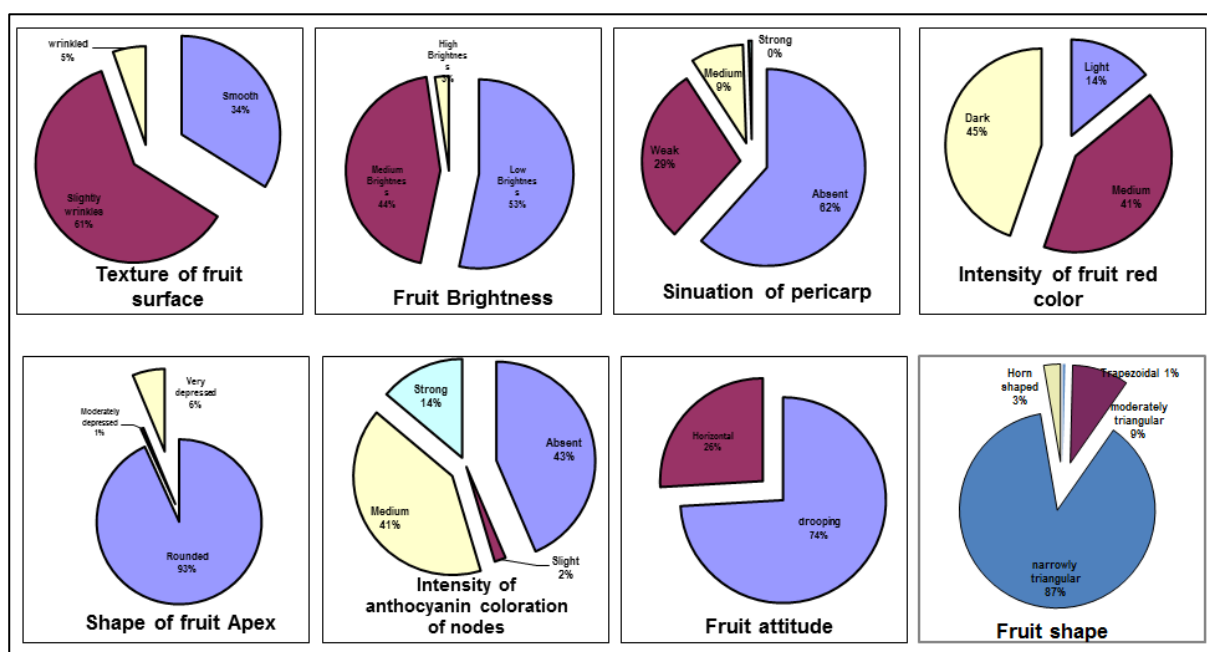
and of genotype x farmers' selection impact interaction based mainly on fruit morphology (size, shape and color), sanitary and on fruit piquancy. Otherwise, natural hybridization concerns only 40-50% of the flowers which gives mature fruit. Thus, the Maleh hot pepper meta-population might be a useful source of candidate genes associated with desirable traits related to plant vigor, plant yielding and fruit size and shape.

Furthermore, most of qualitative fruit traits listed in table 4 showed a significant variation. Fruit color of unripe fruit was green, with a different level of color ranging from light to dark green. Red color of ripe fruit is related to capsanthin accumulation level; it varied from light to dark among accessions. According to farmers and consumers, the main selected criteria are related to dark (44.7%) and medium (41.3%) red color of ripe fruit produced mainly in Site<sub>2</sub> (67.9%<sup>\*\*\*</sup>) and in Site<sub>3</sub> (55.7%<sup>\*\*\*</sup>) respectively; high fruit brightness which concern 80.4%<sup>\*\*\*</sup> and 70.8%<sup>\*\*\*</sup> of measured hot pepper produced respectively in Site<sub>1</sub> and Site<sub>2</sub>; narrowly triangular fruit shape (87.5%) with rounded apex (93.2%) and right pericarp (61.6%) (Table 4, Figure 1).

**Table 3:** Quantitative characters variation between hot pepper meta-population of Maleh river valley

Variables	Site <sub>1</sub>	Site <sub>2</sub>	Site <sub>3</sub>	Mean	Range	Mean Squares	LSD (0.05)	CV (%)
PHT	56.3 <sup>b</sup>	60.9 <sup>a</sup>	56.0 <sup>b</sup>	57.4 ± 1.14	32.0 - 84.0	565.3 <sup>***</sup>	4.05	20.6
VNT	8.54 <sup>a</sup>	8.37 <sup>a</sup>	8.43 <sup>a</sup>	8.44 ± 0.23	3.0 - 16.0	14.8 <sup>***</sup>	1.03	28.3
FNT	38.3 <sup>a</sup>	35.9 <sup>a</sup>	31.9 <sup>a</sup>	34.5 ± 0.87	16.0 - 51.0	304.5 <sup>***</sup>	3.10	26.4
STL	10.7 <sup>a</sup>	8.76 <sup>b</sup>	8.10 <sup>b</sup>	8.86 ± 0.28	2.8 - 16.0	27.1 <sup>***</sup>	0.99	32.4
INT	6.85 <sup>a</sup>	6.88 <sup>a</sup>	6.99 <sup>a</sup>	6.93 ± 0.15	3.0 - 12.0	8.39 <sup>***</sup>	0.63	23.0
LLT	7.67 <sup>b</sup>	9.51 <sup>a</sup>	7.47 <sup>b</sup>	8.08 ± 0.19	5.0 - 16.0	9.66 <sup>***</sup>	0.71	24.4
LW	4.42 <sup>a</sup>	4.51 <sup>a</sup>	4.21 <sup>a</sup>	4.34 ± 0.08	3.0 - 6.70	1.87 <sup>***</sup>	0.31	18.1
PLT	4.16 <sup>b</sup>	5.18 <sup>a</sup>	4.35 <sup>b</sup>	4.54 ± 0.09	3.10 - 8.0	1.66 <sup>***</sup>	0.39	21.0
FLT	14.1 <sup>a</sup>	13.9 <sup>ab</sup>	13.7 <sup>b</sup>	13.8 ± 0.06	8.0 - 19.4	29.9 <sup>***</sup>	0.29	12.5
FW	2.51 <sup>a</sup>	2.33 <sup>b</sup>	2.56 <sup>a</sup>	2.49 ± 0.02	1.3 - 4.6	3.09 <sup>***</sup>	0.07	18.2
FC	8.38 <sup>b</sup>	8.24 <sup>b</sup>	9.05 <sup>a</sup>	8.68 ± 0.05	5.2 - 15.0	29.6 <sup>***</sup>	0.20	15.6
NFC	2.61 <sup>a</sup>	2.52 <sup>a</sup>	2.61 <sup>a</sup>	2.59 ± 0.02	2.0 - 5.0	1.09 <sup>***</sup>	0.10	21.4
NFP	33.6 <sup>a</sup>	32.0 <sup>ab</sup>	29.6 <sup>b</sup>	31.2 ± 0.77	15.0 - 48.0	234.4 <sup>***</sup>	2.89	25.7
NSF	211.1 <sup>b</sup>	173.8 <sup>c</sup>	218.8 <sup>a</sup>	204.6 ± 1.78	60.0 - 354.0	27748.9 <sup>***</sup>	7.22	23.9

Significant at probability level of  $\alpha=0.05$  (\*),  $\alpha=0.10$  (\*\*) and  $\alpha=0.01$  (\*\*\*)



**Figures 1:** Frequency of qualitative characters within the meta-population of Maleh valley hot pepper

**Table 4:** Qualitative characters variation among hot pepper meta-populations per site

Characters		Site <sub>1</sub>	Site <sub>2</sub>	Site <sub>3</sub>	Total	$\chi^2$	Test $\chi^2$
<b>Intensity of nodes anthocyanin coloration</b>	Absent	20.8 <sup>**</sup>	20.0 <sup>***</sup>	66.7 <sup>***</sup>	43.5	32.7	***
	Slight	0.0 <sup>ns</sup>	6.67 <sup>ns</sup>	0.0 <sup>ns</sup>	1.85		
	Medium	70.8 <sup>***</sup>	46.7 <sup>ns</sup>	24.1 <sup>***</sup>	40.7		
	Strong	8.33 <sup>ns</sup>	26.7 <sup>**</sup>	9.26 <sup>ns</sup>	13.9		
<b>Fruit attitude</b>	Horizontal	66.7 <sup>ns</sup>	83.3 <sup>ns</sup>	72.2 <sup>ns</sup>	74.1	2.12	ns
	drooping	33.3 <sup>ns</sup>	16.7 <sup>ns</sup>	27.8 <sup>ns</sup>	25.9		
<b>Fruit Shape</b>	Trapezoidal	0.00 <sup>ns</sup>	0.94 <sup>ns</sup>	0.26 <sup>ns</sup>	0,39	34.7	***
	Moderately triangular	1.23 <sup>***</sup>	8.96 <sup>ns</sup>	12.9 <sup>***</sup>	9,33		
	Narrowly triangular	92.0 <sup>*</sup>	88.7 <sup>ns</sup>	85.0 <sup>ns</sup>	87,5		
	Horn shaped	6.75 <sup>***</sup>	1.42 <sup>ns</sup>	1.81 <sup>ns</sup>	2,76		
<b>Texture of fruit surface</b>	Smooth	20.3 <sup>***</sup>	32.6 <sup>ns</sup>	40.4 <sup>***</sup>	33.9	62.4	***
	Slightly wrinkled	65.6 <sup>ns</sup>	59.0 <sup>ns</sup>	59.6 <sup>ns</sup>	60.7		
	Strongly wrinkled	14.1 <sup>**</sup>	8.49 <sup>**</sup>	0.0 <sup>***</sup>	5.39		
<b>Intensity of fruit red color</b>	Light	30.7 <sup>***</sup>	2.83 <sup>***</sup>	13.2 <sup>ns</sup>	14.1	133.5	**
	Medium	22.7 <sup>***</sup>	29.3 <sup>***</sup>	55.7 <sup>***</sup>	41.3		
	Dark	46.6 <sup>ns</sup>	67.9 <sup>***</sup>	31.1 <sup>***</sup>	44.7		
<b>Fruit Brightness</b>	High	80.4 <sup>***</sup>	70.8 <sup>***</sup>	32.4 <sup>***</sup>	53.4	148.2	**
	Medium	17.2 <sup>***</sup>	26.4 <sup>***</sup>	65.5 <sup>***</sup>	44.3		
	Low	2.45 <sup>ns</sup>	2.83 <sup>ns</sup>	2.07 <sup>ns</sup>	2.37		
<b>Sinuation of pericarp</b>	Absent	58.3 <sup>ns</sup>	73.1 <sup>***</sup>	56.7 <sup>**</sup>	61.6	27.8	***
	Weak	28.8 <sup>ns</sup>	23.1 <sup>**</sup>	32.6 <sup>**</sup>	29.2		
	Medium	11.0 <sup>ns</sup>	3.30 <sup>***</sup>	10.6 <sup>*</sup>	8.67		
	Strong	1.84 <sup>**</sup>	0.47 <sup>ns</sup>	0.0 <sup>ns</sup>	0.53		
<b>Shape of fruit Apex</b>	Rounded	92.0 <sup>ns</sup>	90.5 <sup>ns</sup>	95.1 <sup>**</sup>	93.2	19.7	***
	Moderately depressed	2.45 <sup>***</sup>	0.0 <sup>ns</sup>	0.0 <sup>ns</sup>	0.53		
	Very depressed	5.52 <sup>ns</sup>	9.48 <sup>**</sup>	4.92 <sup>ns</sup>	6.32		

Test du  $\chi^2$  significant at probability level of  $\alpha=0.05$  (\*),  $\alpha=0.10$  (\*\*) and  $\alpha=0.01$  (\*\*\*)

### Biochemical markers (SDS-PAGE)

In addition to phenotypic information, biochemical markers were efficient to assess the average of polymorphism among the hot pepper meta-population (53%) which is ranged from 32% (Site<sub>1</sub>) to 88% (Site<sub>2</sub>) (Table 5). The highest rate of genetic variability was recorded for Site<sub>2</sub>'s accessions with high percentage of polymorphic loci (88%) supported by high allele frequency (Na=1,880), high level of heterozygosity (He=0.334) and high Shannon genetic diversity index (SWI=0.492) (Table 5). However, lower genetic variability among Site<sub>1</sub> and Site<sub>3</sub> farmers' accessions might be related either to farmer's selection impact according to phenotypic preferences, or to genetic population size which is correlated to size of field production, or to seed/seedling exchange impact between farmers of the two sites. Indeed, the mean size of hot pepper production plot varied from 0.05 ha at Site<sub>3</sub> to 4.13 ha at Site<sub>2</sub> and genetic parameters as the importance of genetic diversity within sites (92%) than among site (8%), the short genetic distance between Site<sub>1</sub>-Site<sub>3</sub> (0.061) and between Site<sub>2</sub>-Site<sub>3</sub> (0.079) add to their low genetic differentiation (PhiPT) respectively (0.056<sup>ns</sup>) and (0.046<sup>ns</sup>) (Table 6) support seed/seedling exchange within or among sites.

**Table 5:** Genetic diversity parameters of hot pepper meta-population per Site

SDS-PAGE	P (%)	Na	Ne	He	UHe	SWI
Site <sub>1</sub>	32	1,240	1.214	0,121	0.134	0,178
Site <sub>2</sub>	88	1,880	1.582	0,334	0.350	0,492
Site <sub>3</sub>	40	1,320	1.242	0,143	0.149	0,213
<b>Mean</b>	53,3±17,5	1,480±0.07	1.346±0.04	0,199±0.024	0.211±0.025	0,295±0.034

Na = Number of different Alleles, Ne = Number of Effective Alleles, SWI = Shannon's Index, He = Expected Heterozygosity, UHe = Unbiased Expected Heterozygosity where for Diploid Binary data and assuming Hardy-Weinberg Equilibrium ( $p = 1 - q$ ).

**Table 6:** Genetic structure of hot pepper meta-population

Population	PhiPT	Nei Genetic Distance	Nei Genetic Identity
Site <sub>1</sub> -Site <sub>2</sub>	0,144 <sup>*</sup>	0,181	0,835
Site <sub>2</sub> -Site <sub>3</sub>	0,046 <sup>ns</sup>	0,079	0,924
Site <sub>1</sub> -Site <sub>3</sub>	0,056 <sup>ns</sup>	0,061	0,941

### Molecular markers (RAPD)

Nine random primers were performed to assess genetic variability among and between accessions with an observed polymorphism ranged from 16.7 (OPL-08) to 62.5% (OPX-14) (Table 7). The mean polymorphism among hot pepper meta-population is 52% in accordance with biochemical markers which varied from 24% (Site<sub>1</sub>) to 92% (Site<sub>2</sub>) and among accessions from 7.1% (M<sub>9</sub>) to 20.0% (E<sub>6</sub>) as predicted by morphological traits analysis. The hierarchical analysis of molecular variance (AMOVA) shows that 30% of total genetic diversity was assessed among sites, while 44% was assessed within accessions and 26% was assessed among accessions.

The AMOVA derived diversity measurement SSWP/(n-1) was ranged from 0.67 (M<sub>9</sub>) to 5.67 (E<sub>6</sub>) with a mean of 2.9. The mean polymorphism observed within the meta-population (WP 52%) was supported by Nei's genetic diversity (SWI=0.287) which varied within accessions from 0.014 (M<sub>9</sub>) to 0.124 (E<sub>6</sub>), and between sites from 0.139 (Site<sub>1</sub>) to 0.519 (Site<sub>2</sub>) (Table 8). Otherwise, genetic diversity was greater within sites (89%) than among site (11%). In addition, Nei's genetic distance between Site<sub>2</sub>-Site<sub>3</sub> and between Site<sub>3</sub>-Site<sub>1</sub> was lower respectively 0.093 and 0.098 supporting farmers' seed/seedling exchange network in concordance with SDS-PAGE results. Otherwise, genetic differentiation within accessions (PhiPT=0.559<sup>\*\*</sup>) was exhibited among sites (PhiRT=0.299<sup>\*\*</sup>) in all Site<sub>2</sub> accessions and among accessions (PhiPR=0.370<sup>\*\*</sup>) (Table 9).

**Table 7:** RAPD markers used to assess genetic diversity among hot pepper meta-population

Primer	Sequence (3'-5')	Polymorphism rate (%)
OPL-07	AGGCGGGAAC	42,9
OPL-08	AGCAGGTGGA	16,7
OPL-10	TGGGAGATGG	44,4
OPL-12	GGGCGGTACT	55,6
OPL-14	GTGACAGGCT	54,5
OPP-09	GTGGTCCGCA	60,0
<b>OPX-14</b>	<b>ACAGGTGCTG</b>	<b>62,5</b>
OPX-17	GACACGGACC	40,0
OPX-20	CCCAGCTAGA	22,2
<b>Mean</b>	-	<b>43,5</b>

**Table 8:** Genetic diversity parameters of Maleh hot pepper meta-population

RAPD	P (%)	Na	Ne	He	UHe	SWI
Site <sub>1</sub>	24	1,160	1.170	0,095	0.105	0,139
Site <sub>2</sub>	92	1,920	1.620	0,354	0.370	0,519
Site <sub>3</sub>	40	1,320	1.214	0,133	0.139	0,202
<b>Mean</b>	<b>52,0±20.5</b>	<b>1,467±0.07</b>	<b>1.335±0.04</b>	<b>0,194±0.02</b>	<b>0.205±0.03</b>	<b>0,287±0.03</b>

Na = Number of different Alleles, Ne = Number of Effective Alleles, SWI = Shannon's Index, He = Expected Heterozygosity, UHe = Unbiased Expected Heterozygosity where for Diploid Binary data and assuming Hardy-Weinberg Equilibrium ( $p = 1 - q$ ).

**Table 9:** Genetic diversification among hot pepper meta-population of Maleh valley

RAPD	df	SS	MS	Est. Var.	%	Value	P ( $\alpha \leq 0.05$ )
PhiRT	2	112.11	56.06	1.927	30%	0.299	**
PhiPR	16	145.00	9.063	1.672	26%	0.370	**
PhiPT	53	150.75	2.844	2.844	44%	0.559	**

### Conclusion

Genetic diversity provides farmers crop security in constraints environments. However, farmer's genetic diversity management is based on agro-morphological traits that are highly influenced by environmental factors, socio-economical and farmers' indigenous knowledge.

The agro-morphological variability observed among hot pepper accessions of Maleh valley was supported by biochemical (SDS-PAGE) and molecular markers (RAPD). Most of analyzed phenotypical traits related to plant vigor, yield components and fruit size and shape were found significantly variable among hot pepper meta-population. Variability within accessions might be useful to discriminate among genotypes according to farmers (productivity) and consumers

(phenotype trait) criteria. Moreover, the study revealed a considerable genetic variability among accessions, among sites and within sites particularly within Site<sub>2</sub> and among B<sub>1</sub>, E<sub>6</sub>, E<sub>7</sub> and M<sub>7</sub> accessions that might include genotypes with both productive traits and fruit size and feature. Thus, the availability of genetic variability within hot pepper meta-population might provide breeders with genotypes or allelic variants of candidate gene(s) associated with desirable traits.

### References

- Adetula AO and Olakojo SA (2006): Genetic characterization and evaluation of some pepper accessions *Capsicum frutescens* (L): the Nigerian ‘Shombo collection’ collections. *American-Eurasian Journal of Agricultural and environmental Science* 1 (3): 273-281.
- Aniel Kumar O. and Subratata S. (2010). SDS-PAGE seed storage protein profiles in Chili pepper (*Capsicum* L.), *Nat Sci Biol* 2 (3): 86-90.
- Berke TG and Shieh SC (2001). *Capsicum*, chilies, paprika, bird’s eye chili in Peter KV (Ed.) *Handbook of Herbs and Spices*. Wood head publishing limited, Cambridge, 111-122.
- Bhadragoudar M. R. and Chandrashekhar G. P. (2011). Assessment of genetic diversity among *Capsicum annum* L. genotypes using RAPD markers. *African Journal of biotechnology*. Vol. 10 (76), 17477-17433.
- Geleta L.F., Labuschagne M.T. and Viljoen C.D. (2005). Genetic variability in pepper (*Capsicum annum* L.) estimated by morphological data and amplified fragment length polymorphism markers. *Biodiversity and Conservation* 14: 2361-2375.
- Laemmli, U. K. (1970). Cleavage of structural proteins during the assembly of the head of bacteriophage T4. *s.l. Nature* 227(5259), 680-685.
- Marchenal P. et Lagarde M.F. (1994). *Conservatoire Botanique de Porquerolles des variétés locales de plantes cultivées*. Guide pratique.
- Nsabiyaera V, Lagose M, Ochwo-Ssemakula M, Sseruwagi P, Gibson P, Ojiewo C, (2013): Morphological characterization of local and Exotic Hot pepper (*Capsicum annum* L.) collection in Uganda. *Bioremediation, Biodiversity and Bioavailability*, global Science Books. 7 (1): 22-32.
- Odeigah P.G.C., Oboh B. and Aghalokpe (1999). The characterization of Nigerian varieties of pepper, *Capsicum annum* and *Capsicum frutescens* by SDS-polyacrylamide gel electrophoresis of seed proteins. *Genetic Resources and Crop Evolution* 46: 127-131.
- Peeraullee N. and Ranghoo-Sanmukhiya V.M. (2013). Assessment of genetic diversity in local chili (*apsicum annum*) varieties in Mauritius. *Int. J. Agric. Biol.*, 15:891-896.
- Rodriguez Y, Depestre T, Gomez O. (2008): Efficiency of selection in pepper lines (*Capsicum annum*), from four sub-populations, in characters of productive interest. *Ciencia e Investigación Agraria*. 35 (1): 29-40.
- Saghai-Maroo M.; Soliman K.; Jorgensen RA and Allard R. (1984). Ribosomal DNA spacer-length polymorphisms in barley: Mendelian inheritance, chromosomal location and population dynamics. *Proceeding of the National Academy of Sciences*. 81 (21): 8014-8018.
- Sharma VK, Semwal CS, Uniyal SP (2010): Genetic variability and character association analysis in bell pepper (*Capsicum annum* L.), *Journal of Horticulture and Forestry* 2 (3): 58-65.
- Troconis-Torres I.G. et al (2012). Biochemical and molecular analysis of some commercial samples of chili peppers from Mexico. *Journal of Biomedicine and Biotechnology*. 11p.

## PERFORMANCES OF NEW INDUSTRIAL TOMATO CULTIVARS (*LYCOPERSICUM ESCULENTUM*) IN THE GHARB REGION OF MOROCCO

Abdelkrim KRIRA<sup>1</sup>, Nouredine ES-SAFI<sup>2\*</sup>, Fatima GABONNE<sup>1</sup>, Mohammed IBRIZ<sup>3</sup>, Abdellatif OUBERRI<sup>4</sup>

<sup>1</sup>National Institute of Agronomic Research, kenitra. Morocco

<sup>2</sup>Ministry of Agriculture and Fisheries, MAPM, Morocco

<sup>3</sup>Faculty of Science, Ibn Toufail University. Kenitra. Morocco

<sup>4</sup>The Conserves of Meknes (Les Conserves de Meknes LCM-Aicha). Morocco

\*Corresponding author: [essafi\\_n@yahoo.fr](mailto:essafi_n@yahoo.fr)

### Abstract

Considering the importance of the cultivars performance in improving productivity, comparative study of ten new industrial tomato cultivars was conducted at the experimental field of Sidi Alla Tazi in the Gharb region of Morocco, for their phenological and production parameters. The objective of this experiment is to study the agronomic performance of 10 Tomato cultivars in order to seek the most adapted and high yield potential in the Gharb agro-climatic conditions. The cultivars trial was transplanted with dual lines and led by fertigation. The tested plant material consisted of cultivars with fixed growth. The adopted trial is a randomized block with four replications. Obtained results have statistically identified four cultivars; Num 0058 (120 t/ha), Artix (118 t/ha), Mariflor (117 t/ha) and Riotinto (116 t/ha), which differ by the best morphological, agronomic and technological criteria as: height, vegetative part, Leaf Area Index (LAI), yield, synchronized maturity, precocity and Brix. These cultivars expressing the highest yields and the best brix have shown the best performance of growth and development. The lowest yield was obtained by Heinz 2710 control (100 t/ha). In viewpoint of precocity, cultivars Num 0058 and NPT 63 are the earliest.

**Keywords:** *Performance, Cultivars, Brix, Industrial Tomato, Morocco*

### Introduction

Two main types of tomatoes (*Lycopersicum esculentum*) exist, composed by indeterminate growth tomato and the growth fixed which is "dwarf" or so-called industrial tomato. Globally, the major producers of industrial tomatoes according to the International Association Mediterranean Tomato (AMITOM, 2010<sup>1</sup>) are; USA (12.6 million tonnes), China (6.2 million t.) and Italy (5 million t.). In Morocco, tomato area has experienced a constant evolution in the various regions where irrigation is possible (Oukabli, 1983; Atherton, 1986 quoted by Chleyah 2001). The production is currently concentrated in the Gharb and Loukkos regions on an area of about 5,000 ha and over 75% of the sowings exists in the Gharb region (ORMVAG, 2008). These crops present only 13% of sown areas, but they contribute to 54% of the total value of crop production (Green Morocco Plan 2008). Tomato sector provides 120 working days per hectare and ensures the continued operation of an emerging processing industry. The main part of production is converted into concentrated and derivatives by one of the important aggregator companies; Les Conserves de Meknes (LCM-Aicha) that convert more than 110,000 t/year (Anonymous, 2008; DPVCTRF, 2010). This study aims to contribute to the improvement of productivity by comparing ten new cultivars in order to propose the best ones to the farmers. This study was conducted in collaboration between INRA and LCM-Aicha.

(1) AMITOM: Mediterranean International Association of the Tomato.

## **Material and methods**

### **1. Plant Material**

The plant material used is composed of ten cultivars with determinate growth. All these cultivars namely; Num 0058, NPT 63, Num 0001, Num0051, Mariflor, Riotinto, Artix, NPT 65 and NPT 64, are produced by Syngenta and Nunhems companies. Cultivars of this experiment are sown in a peat substrate in trays cells. Heinz 2710 variety is used as control.

### **2. Soil Characteristics**

The experiment was installed on a heavy soil in the experimental area. Results of physicochemical analysis show that the superficial horizons consist of alluvium depositing are rich of silt. Soil texture is clayey loam moderately provided organic matter (2.98%) and very rich in K (546 ppm). The pH (7.7) is slightly alkaline. Trial was conducted in fertigation for a yield of 100 t/ha. Fertilizers used are; 130U NO<sub>2</sub>, 97U P<sub>2</sub>O<sub>5</sub>, 264U K<sub>2</sub>O and 12U Mg.

### **3. Experimental setup**

The experimental model is a randomized complete block with four replications. The basic plot with an area of 36 m<sup>2</sup> consists of three twinned lines spaced of 2 m. The plants stand is made of about 25,396 plants per hectare. Three plants are selected at random on the middle line of each plot. 120 plants were analyzed for vegetative characters such as: height; LAI; vegetative part; yield and its components; precocity score 1 to 6; number of clusters, number of flowers and number of fruits per plant. At harvest, the products were weighed and characters qualitative have been noted as caliber, weight, fruit shape; length; number of lodges; brix, pH and NaCl content were analyzed.

### **4. Statistical analysis**

For each measured character as agronomic, technological and morphological, we have proceeded to the analysis of variance (ANOVA) by a single classification criterion. When a significant difference is found between cultivars for one character, the ANOVA is completed by Dunnett test.

## **Results and discussion**

### **1. Phenological parameters**

The variance analysis (Table 1) revealed a high significant HS difference for the height character and the LAI character respectively ( $P \leq 0.0044^{**}$ ) and ( $P \leq 0.0043^{**}$ ), but very HS for the vegetative shape character ( $P \leq 0.0005^{***}$ ). While the other characters are not significant, indicating existence of morphological diversity among the cultivars tested, with a low variation coefficient for all characters. So, the morphological characters are less variables.



**Table 1. ANOVA of observed parameters**

Variation sources (parameters)	Height (cm)	Leaf Area Index ( LAI)	Vegetative shape (cm)	Yield (T/ha)	Fruit weight (g)	
Cultivars (average-type-plant)	Num 0058	72.91 ± 2.9ba	5.24±0.68ed	2.24± 0.31a	119.98 ±21.73a	85.08±9.14
	NPT 63	67.08±6.43bc	5.69±1.20becd	1.92±0.23 cb	114.44±34.59ba	91.47±5.25
	Num 0001	65.41±4.16c	5.17±1.12e	1.96 ±0.13b	104.75±27.89ba	107.01±9.70
	Num0051	65.41±5.16c	6.42±0.51ba	1.76±0.14 c	101.31 ±39.36b	104.80±12.65
	Mariflor	66.24±4.78c	5.66±0.80ecd	1.83±0.22 cb	117.47±25.98 a	77.38±8.63
	Riotinto	72.91±10.66ba	6.80±0.88a	1.84± 0.26cb	115.56±31.5 ba	88.75±5.96
	Artix	76.66±3.60a	6.01±1.02bc	1.90±0.13 cb	118.35. ±29.75a	94.44±6.59
	NPT 65	67.49± 5.18bc	5.91±1.04becd	1.80± 0.25cb	111.69±33.71b	103.66±10.43
	NPT 64	65.41± 2.09c	6.00 ±0.87bc	1.76± 0.21c	101.93 ±31.08b	89.42±7.47
	Heinz (Control)	69.58±4.16bc	5.98±0.75bcd	1.90±0.24cb	100.76±32.30b	99.90±9.46
Statistics	Fobs	3.64	3.65	5.00	2.08	1.19
	P	<0.0044(HS)	0.0043(HS)	0.0005(THS)	0.0686(NS)	0.3140(NS)
	CV%	6.03%	8.73%	6.70%	9.60%	29.51%

(NB: For each character, values with the same letter are statistically equal according to Dunnett's test)

Comparison of heights average showed that cultivars such as Artix (76.66 cm), Num 0058 (72.91 cm) and Riotinto (72.91cm) give a remarkable growth in height greater than the control (69.58 cm), with a variation coefficient of 8.78% (Table 1). Indeed, this result justifies their adaptation to agro-ecological conditions of the region. The LSD test (6.03) at threshold  $\alpha = 0.05$  allowed to classify cultivars in 3 homogeneous groups. The first one consists of Artix cultivar with an average height of 76.66 cm followed by Num0058 and Riotinto cultivars having an average of 72.91 cm and a last group including the control, not exceeding 70 cm. The comparison of leaf area index (LAI) was leading to estimate the biomass directly dependent on the photosynthesis that takes place in the plants stand. The density of leaf system has consequences on the health status of the culture and the reduction in evapotranspiration. This comparison shows that cultivars: Riotinto, Num0051, Artix and NPT 64 have shown greater leaf area index (>6) in comparison to control (<6) and therefore these cultivars have a denser biomass (Table 4). LSD test (0.74) at threshold  $\alpha = 0.05$  has shown the existence of more homogeneous groups. The first consists of the Riotinto cultivar that comes out on top with a mean of 6.80 followed by Num 0051, Artix, NPT64 and other cultivars that overlap each other between 5.17 and 6. Comparison of vegetative shapes shows that cultivars Num 0058 (2.24), Num 0001 (1.96) and NPT63 (1.92) have a vegetative volume significantly higher than other cultivars including the control. LSD test (0.18) at threshold  $\alpha = 0.05$  allowed to classify all cultivars in 4 homogeneous groups. The first one consists of the Num 0058 that ranks first with an average of 2.24 cm followed by the second group of the Num 0001 (1.96 cm). These genotypes tend to better display their vegetative part. An intermediate group of NPT63, Heinz 2710, Artix, Riotinto, Mariflor and NPT 65 cultivars whose averages overlap between 1.80 and 1.92 cm. The last group is composed by NPT 64, Num 0051 cultivars having a vegetative volume of about 1.76 cm only, and an erect vegetative port type.

## 2. Yield Components

Data on yield components (number of flower clusters/plant, number of flowers/plant, number of fruits/plant and yield) were submitted to principal component analysis (PCA) for discriminating and looking for correlations that might exist between components (Table 2).

**Table 2: Counting data yield components**

Cultivars* status:											Mean	Type-Ecart
number of flower cluster (a), flowers (b), fruits (c) and yield in t/ha (d)												
	C1	C2	C3	C4	C5	C6	C7	C8	C9	C10		
<b>a</b>	43	31	34	24	36	47	42	55	22	31	36	10.32
<b>b</b>	295	109	103	103	190	220	167	149	124	140	159.5	61.18
<b>c</b>	140	50	85	41	71	117	65	125	44	68	76.6	36.76
<b>d</b>	120	114	105	101	117	116	118	112	102	100	111	7.72
Cultivars : Num 0058 (C1),NPT 63 (C2),Num 0001 (C3), Num 0051 (C4), Mariflor (C5), Riotinto (C6), Artix (C7),NPT (C8), NPT 64 (C9) and Heinz 2710 control (C10)												

According to the above analyze, cultivars have been classified on three homogeneous groups, the first one consists of the following cultivars as Num 0058, Mariflor, Riotinto and Artix. The best positive correlation is mentioned between Yield and the Flowers number ( $r^2=0.75$ ), which constitute a good illustration for the best performance.

### 2.1 - Number of flower clusters

The number of flower clusters per plant varies widely between cultivars, of about 22 to 55. The best performances were recorded by the following cultivars: NPT 65, Riotinto, Num 0058 and Artix. The PCA for all yields components measured reveals a positive correlation between the number of flower clusters and other yield components like number of flowers, fruit number and yield. This relationship is confirmed between fruit number and yield, which establishes a significant correlation ( $r^2= 0.62$ ). Therefore, this component explains strongly the performance of cultivars. Indeed, Num 0058, Riotinto, Mariflor and Artix cultivars have confirmed an abundant flowering compared to the rest of genotypes.

### 2.2 - Number of flowers per plant

The number of flowers per plant varies between cultivars; it changes from 103 to 295. The best performances were recorded by the cultivars: Num 0058, Riotinto, Mariflor, Artix and that showed superiority of flowering over the rest of the cultivars. The correlation between the number of flowers and the yield is significant ( $r > 0.74$ ). The significance test of the correlation coefficient explained that the number of flowers determines greatly the yield parameter.

### 2.3 - Number of fruits per plant

The number of fruits per plant varies from 44 to 140 for the following genotypes NPT 65, Num 0058, Riotinto and Artix. Cultivars are shown remarkable regarding to the number of flowers clusters per plant, which ranged from 22 to 55 depending on the genotype. The correlation between the number of fruits and yield was significant ( $r^2 > 0.62$ ) and therefore this component explains very well the cultivars performance. According to the control, the Num 0058, NPT65, Riotinto, Mariflor, Num0001 and Artix cultivars have given the best number of fruits. The highest fruits number was obtained by the Num0058, NPT65 and Rotinto cultivars.

### 2.4- Yields

At threshold  $\alpha=0.05$ , ANOVA revealed no significant difference. LSD test has revealed three potentially interesting cultivars that are specially Num 0058, Artix and Mariflor. The highest yield was obtained by the followed cultivars Num 0058 (120 t/ha), Artix (118 t/ha), Mariflor (117 t/ha) and Riotinto (116 t/ha). The average yield of all other cultivars is of about 110.6 t/ha with a variation coefficient of 9.6%.

Note that the recorded performance levels (Table 2) range from 100 to 120 tonnes per hectare. These yields are very satisfactory compared to other similar experiments carried out in the region with other cultivars. The control gives only 90 t/ha. Moreover, cultivars Petoseed, Sun 6200, and Heinz 9661 have given yields comprise between 70 to 80 t/ha, while Boss, Sun 6235 and Heinz 8704 have given yields from 55 to 70 t/ha (El Atir et al, 2001). We thought that it is useful to make a classification for these cultivars in 3 homogeneous groups. The first and the best one consists of cultivars Num 0058, Artix, and Mariflor who gives the best yields.

### 3. Precocity, inter-cultivars maturity, size and technological quality

Monitoring flowering rate has determined the flowering period of the different cultivars. This period has a duration of 17 days. The evolution of flowering percentage allowed to a classification according to a gradient in the number of flowers, which gives an idea on the inter-cultivars precocity (Table 3). Thus, cultivars like NPT 63, Num 0058, Num 0001 and Mariflor are in advanced phase of nearly 15 days compared to other cultivars.

**Table 3: Rating of flowering percentage according to studied cultivars**

Obser./dates/cultivars	jours	C1	C2	C3	C4	C5	C6	C7	C8	C9	C10
pré-flowering (%)	0	3	4	1	-	2	1	1	1	-	1
Start-flowering (%)	3	30	30	20	5	10	5	3	2	2	1
Flowering (%)	7	40	45	30	10	25	10	10	8	8	10
Extend flowering %	10	45	50	35	10	40	15	12	12	12	15
Flow-blooming %	17	70	70	65	45	60	50	40	40	40	45
Total	17	188	199	151	70	132	81	66	63	62	72
Scale rating		2	1	3	6	4	5	6	6	6	6

Two harvests were conducted to observe if the cultivars expressing a grouped maturity. The first harvest was performed by 98 days after sow and the second after 15 days. Thus, compared to control, the others cultivars like Mariflor, Num 0058 and Num 0001 tend to have a grouped maturity and expressed more than 85% of their products in the first harvest (Table 4).

**Table 4: Proportion of harvest in the parcelar global production.**

Cultivars	C1	C2	C3	C4	C5	C6	C7	C8	C9	C10
1 <sup>st</sup> . harvest (%)	87,8	86,8	87,2	80,9	90,1	82,9	81,2	86,9	86,4	88,4
2 <sup>nd</sup> . harvest (%)	12,1	13,1	12,7	19	9,8	17	18,7	13	13,5	11,5
pH	4,18	4,02	4,09	4,06	4,24	4,22	4,22	4,2	4,2	4,08
degree of Brix	5	5	5	5,4	5,2	5	5,2	4,8	5	5
NaCl content	0,08	0,08	0,08	0,08	0,09	0,08	0,07	0,08	0,06	0,08

The percentage of the first harvest in the overall production ranged from 80.9 to 90.1% depending on the genotypes like Mariflor, Heinz, Num 0058 and Num 0001 tend to have a grouped maturity compared to other cultivars and expressed almost 85% of their products in the first harvest (Table 4). However, Num 0051, Riotinto and Artix cultivars presented 20% of their products 15 days after the first harvest. These cultivars have a relatively grouped maturity than other cultivars. The ANOVA of fruit weight showed no significant difference ( $P > 5\%$ ) between cultivars. The assessment of the form by the combination of the length and diameter of each fruit showed the existence of the rounded shape for the Num 0001 cultivar, the long rounded, and flattened for Num 0051 cultivar and Heinz 2710. The rest of the cultivars have a long flat shape. Moreover, the lodges' number has been 3 for genotypes such as Num 0058, Num 0001, Mariflor, Riotinto F1, NPT 63 and Heinz 2710. However, the average of fruit weight is of around 92 g/fruit.

Brix is the most important criterion of the quality in tomato industry. It denotes the degree of dry matter, which determines the performance for processing. All cultivars have shown a brix above 5 except one genotype such as NPT 65 (4.8). Cultivars like Num 0051, Mariflor and Artix expressed the best brix between 5.2 and 5.4. The pH (4.18) and NaCl content (0.07) is relatively the same for all cultivars (Table 4).

### 4. Agronomic and morphological characteristics of cultivars

According to the results of these parameters (Table 5), it appears the existence of 3 cultivars that seem most appropriate and present the best performance. These cultivars are Num 0058, Artix and Mariflor, which expressed the best yields and the best brix. Also, they expressed the best growth and development performance. Concerning precocity, Num 0058 and NPT 63 cultivars are the best ones, while Num 0001, Riotinto F1 and Artix cultivars are later. In viewpoint of disease resistance, the Num 0058 and NPT 63 cultivars were free of diseases and physiological mosaic unlike Mariflor and Artix cultivars, which presented slight mosaic branches. We also observed that the Num 0058

cultivar presented a less dense foliage than other cultivars. Skiredj et al 2002 and El Alami, 1982, showed the same interpretation.

**Table 5: Agricultural Features of the studied cultivars**

Cultivars	Height (cm)	Veget. shape (m)	LAI	Precocity	Yield (t/ha)	Nbr. lodges	Brix	Diseases physio.	Mosaique	Foliar density
Num 0058	72,9	2,2	5,2	2	120	3	5	-	-	clair
NPT 63	67,0	1,9	5,6	1	114	3	5	-	-	very dense
Num 0001	65,4	1,9	5,1	3	105	3	5	+	-	dense
Num0051	65,4	1,7	6,4	5	101	2	5,4	+	2	very dense
Mariflor	66,2	1,8	5,6	4	117	3	5,2	+	1	dense
Riotinto F1	72,9	1,8	6,8	5	116	3	5	+	-	dense
Artix	76,6	1,9	6,0	6	118	2	5,2	+	-	dense
NPT 65	67,4	1,8	5,9	4	112	2	4,8	-	-	dense
NPT 64	65,4	1,7	6,0	6	102	2	5	+	2	very dense
Heinz 2710	69,5	1,9	5,9	5	101	3	5	-	-	very dense

(Precocity score= 1: very early, 2: early, 3: medium early, 4: fairly late, 5 late, 6: very late)

### Conclusions and recommendations

Gharb region is currently the first local production of tomato industry in Morocco. Obtained results have identified four cultivars statistically distinguished by the best morphological and agronomic technology criteria such as height, vegetative shape, LAI, yield, early maturity and brix. These cultivars are specially Num 0058 (120 t/ha), Artix (118 t/ha), Mariflor (117 t/ha) and Riotinto (116 t/ha). They expressed the highest yields and the best brix. They also expressed the best growth and the good development performance. In viewpoint of precocity, cultivars like Num 0058 and NPT 63 are the earliest. Concerning diseases resistance Num 0058 and NPT 63 cultivars were free of diseases and physiological mosaic. Num 0058 cultivar was observed with a less dense foliage than other cultivars has given the high level of yield. Adoption of these identified cultivars remains a promising project that could have a positive effect on increasing productivity in the irrigated perimeter. Although, industrial tomato becomes an opportunity for diversification of incomes for small farmers in this region. Therefore, it is recommended better sowing early culture when the agro-ecological conditions do not present significant risks.

### Acknowledgements

Firstly, I would like to thank the General Director of the National Institute of Agricultural Research and the Manager of the Regional Center of Agricultural Research of Kenitra, for their assistance. In addition, we should be grateful for the financial support given by The “Les Conserves Meknes (LCM-Aicha)” group, in order to success all field trials.

### References

- Atherton J. (1986). The tomato crop department of agriculture and Horticulture University of Nottingham School of agriculture.
- Chleyah A. (2001). Tomate industrielle: endurcissement des plants en pépinière. Mémoire de troisième cycle en Agronomie option Horticulture. IAV Hassan II, Rabat.
- DPVCTRF. (2010). Catalogue Officiel (liste des variétés industrielles inscrites).
- El Atir H, Chtaina N, et Skiredj A. (2001). Rapport de synthèse de la convention « tomate industrielle » entre l’IAV Hassan II et les industriels CIL et LCM.
- El Alami M’B. (1982). Comparaison variétale de tomate sous abri-serre dans la région de Chtouka –Eloulja. Diplôme d’ingénieur en horticulture. IAV II. Complexe Horticole d’Agadir.
- Oukabli A et Taibi A. (1983). Essai comparatif multi locaux de 12 variétés de tomate d’hiver et 7 variétés de tomate de printemps en culture de plein champ mémoire de fin d’étude. Complexe horticole d’Agadir.

- ORMVAG (2008). Rapport : données statistiques sur le secteur maraîchage au Maroc.
- Skiredj A., El Attir H., Chtaina N. et Chliyeh A. (2002). Endurcissement des plantules de tomate industrielle au Loukkos. Actes de l'IAV Hassan II, Vol 22 (3) 2002: 169-176.

## EFFECT OF MAGNETICALLY TREATED WATER ON STRAWBERRY PLANTS (*FRAGARIA* × *ANANASSA* DUCH.) IN THE NORTHWEST OF MOROCCO

Houda TAIMOURYA<sup>1\*</sup>, Mohamed OUSSIBLE<sup>1</sup>, Lahoussaine BAAMAL<sup>1</sup>, El Hassane BOURARACH<sup>1</sup>, Najem HASSANAIN<sup>2</sup>, Lhoussaine MASMOUDI<sup>2</sup>, Abderrahmane EL HARIF<sup>2</sup>

<sup>1</sup> Agronomic and Veterinary Institute Hassan II, Rabat, Morocco

<sup>2</sup> Faculty of Science, Mohamed V University, Rabat, Morocco

\*Corresponding author: houdatamourya@yahoo.com

### Abstract

Utilization of Magnetically treated water has been investigated and applied in many countries such as Russia, Australia, Israel, China and Japan. Studies have shown that the magnetic field is used as a safe alternative choice to improve plant growth and development. Although the properties of magnetically treated water have received a great deal of interest in recent years, there are no studies conducted in Moroccan agricultural conditions. The present study aims at gaining more insight on the effect of magnetically treated irrigation water in the northwest region of Morocco, on the yield of strawberry plants (*Fragaria* × *ananassa* Duch. cv. *Camarosa*) and its components. The experiments were conducted in situ, during two crop seasons (2011-2012 and 2013-2014). The results confirm that physical treatment of irrigation water by a static magnetic field improve the yield of strawberry fruits. The percentage of increase in number of flowers, number of fruits and fruit yield per 100 plants were 27.4%, 30.9%, 34.8%, respectively compared with normal irrigation water (average over both crop seasons). These results suggest that irrigation with magnetically treated irrigation water improves the production of the strawberry plant, thus water use efficiency was enhanced. Therefore, the magnetically treated irrigation water can be considered as a promising technique for improvement strawberry production, but extensive research is still required.

**Keywords:** *Magnetic field, Irrigation water, Strawberry, yield components*

### Introduction

Strawberries are one of the most popular cash crops from a commercial and economic point of view. Morocco ranks as the world's fifth largest strawberry exporter, with a total production of 145 233 tons (FAO, 2013). Appropriate strategies are to be developed to increase crop productivity while conserving water supply. One of the new strategies is physical magnetic treatment technology. This technique is safe, simple, and environmentally friendly without harmful effects. Besides that, it has low operating costs. The literature reports have shown an improvement of irrigation water quality and water use efficiency, crop yields and quality, soil improvement, scale prevention/elimination in water using systems, and water savings by using magnetic treatment (Eşitken & Turan, 2004; Grewal & Maheshwari, 2011; Mostafazadeh-Fard et al., 2011). In fact, it was reported that the magnetic treatment changes water properties due to displacement and polarization of water atoms (Dhawi et al., 2009). These changes result in a better assimilation of nutrients and fertilizers in plants during the vegetative growth period (Moon & Chung, 2000; Nawroz & Hero, 2010). It was found that the mobility of nutrient elements in root zone of citrus was improved greatly when using magnetic treatment (Hilal & Hilal, 2000; Eşitken & Turan, 2004). However, there are hardly any studies conducted in Moroccan agricultural conditions. The objective of our study is to investigate the effects of magnetically treated irrigation water in the northwest region of Morocco, on strawberry plant's (*Fragaria* × *ananassa* Duch. cv. *Camarosa*) yield and its components.

## **Material and Methods**

This study was conducted in a farm named "DIRAFROST" located in the region of Laaouamra, 20 km south of Larache, Morocco<sup>4</sup>. A 2 ha field experiment was conducted, in situ, during two crop seasons (2012 and 2014).

The soil was classified as a frank sandy with a clay content of 5%; silt loam content of 15% and a sand rate of 80%. The amount of organic matter was 1.55% and a basic pH of 7.2. The electrical conductivity is 314 $\mu$ S cm<sup>-1</sup>.

Camarosa bare root plants were planted on November 4th and 10th of the years 2011 and 2013 respectively, at the rate of 70000 plants per hectare. Strawberries were grown under low plastic tunnels. Water from a well was used for drip irrigation. In October, 3.2 litre of irrigation water was given daily, thereafter, watering was continued daily (30 m<sup>3</sup>.h<sup>-1</sup> per hectare). Considerably, higher rates are required during prolonged hot and dry periods. The plants were fertilized weekly through the drip irrigation system. First and final harvests were performed between 1<sup>st</sup> of February and 30<sup>th</sup> of June for the two crop seasons.

Irrigation water was treated magnetically by passing once through a magnetic treatment device that was designed especially for field conditions. We have called the aforementioned treated water as magnetically treated irrigation water (MTIW).

The experimental field was formed by two adjacent plots. In each plot, there are three valves. Three sub-units were fixed in each plot (450 m<sup>2</sup>), they coincide with the inter valve distance. Each sub-unit had 8 beds of 100 strawberry plants. The magnetic treatment device was installed in the front of the secondary pipe line in the plot irrigated with MTIW. Thus, water flowing downstream in the three valves has already treated by the static magnetic field. Statistically, the experimental system was performed as a completely randomized design with treatment (MTIW) at two levels and 3 replications (sub-units).

Quantitative traits such as the number of flowers and fruits per 100 plants, and fruit yield (kg/100 plants) were investigated for each treatment.

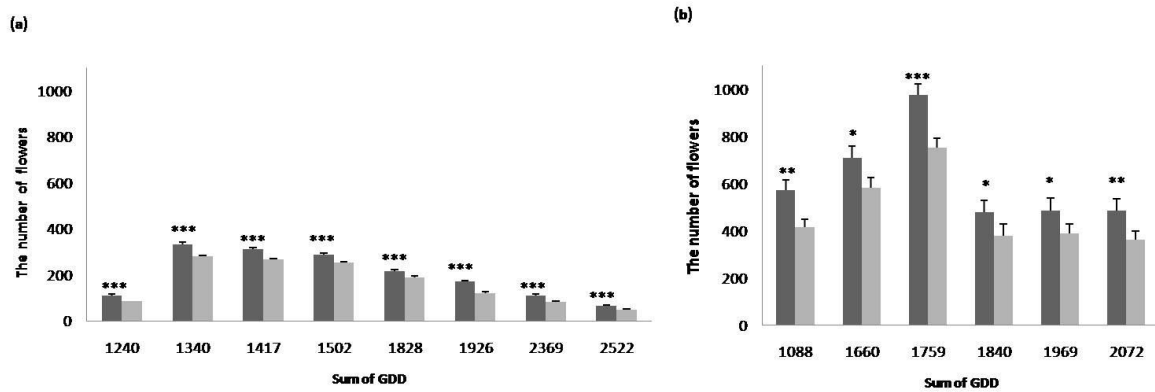
All data in the present study was subjected to the one-way analysis of variance (ANOVA) to test the main effects of the magnetic field and find the differences between the plants irrigated with MTIW and the control.

## **Results and Discussion**

**The number of flowers:** the comparison of the number of flowers in the 2012 and 2014 crop seasons of strawberry plants, as affected by normal and magnetically treated irrigation water, are presented in Figure 1. The results show that the irrigation of strawberry plants with MTIW resulted in significant increases in the number of flowers compared with the plants irrigated with normal irrigation water. The results are highly significant for the plants corresponding with the 2012 crop season. On average, the increments were 25.6% in 2012 and 29.2% in 2014 (Figure 1).

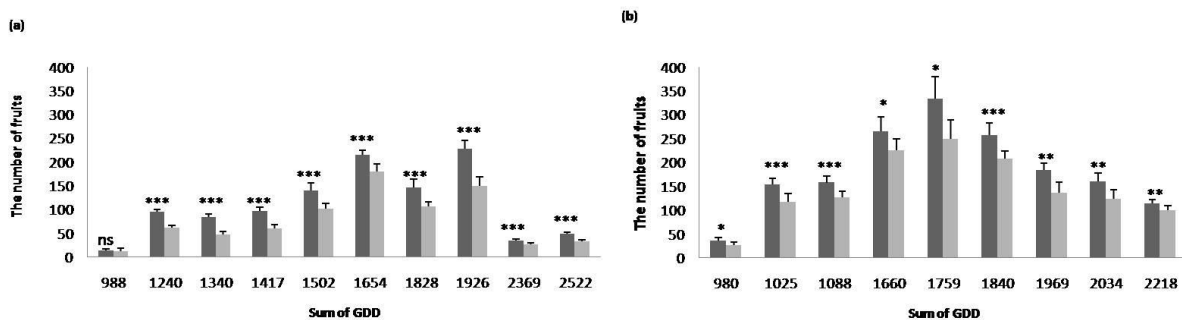
---

<sup>4</sup> Coordinates: 35°1'16"N and 6°9'47"W in MSD (minutes and seconds degrees), latitude of: 35.0212059397254 and longitude of: 6.16293206440213 (in decimal degrees).



**Figure 1:** The number of flowers of 100 strawberry plants irrigated with normal (light grey) and magnetically treated irrigation water (dark grey) for 2012 (a) and 2014 (b) cropping seasons. The data were presented as function of the sum of GDD (Growing degree days). \*, \*\*, \*\*\* showed that the difference is significant at the 0.05 ; 0.01 and 0.001 levels, respectively. The vertical bars represent standard error of the means.

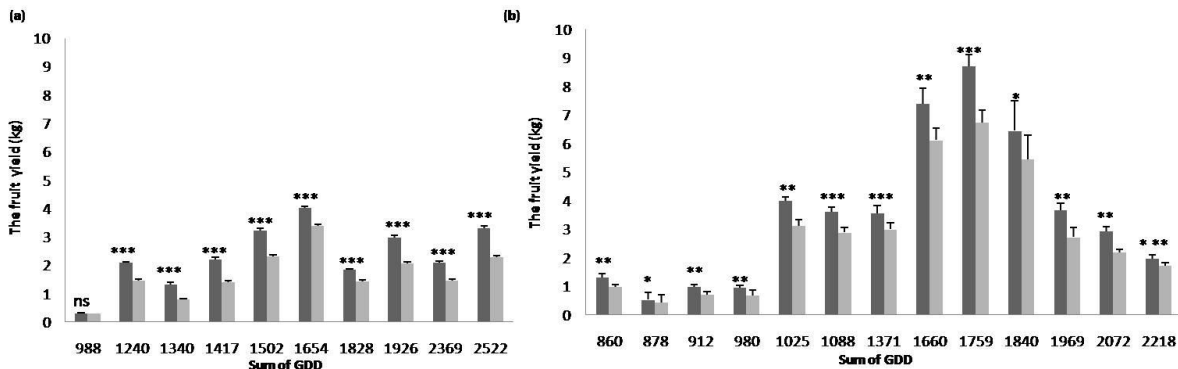
**The number of fruits:** the mean number of fruits of strawberry plants irrigated with normal and MTIW observed during the two crop seasons 2012 and 2014 are shown in Figure 2. The mean number of fruits of strawberry plants is strongly affected by the magnetic treatment. The percentages increase in the number of fruits was 43.5% (2012) and 27.4% (2014) when irrigated with MTIW.



**Figure 2:** The number of fruits of 100 strawberry plants irrigated with normal (light grey) and magnetically treated irrigation water (dark grey) for 2012 (a) and 2014 (b) cropping seasons. The data were presented as function of the sum of GDD (Growing degree days). \*, \*\*, \*\*\* showed that the difference is significant at the 0.05; 0.01 and 0.001 levels, respectively. ns: not significant. The vertical bars represent standard error of the means.

**The fruit yield:** the mean fruit yield of strawberry plants irrigated with normal water and MTIW measured during the two crop seasons (2012 & 2014) are shown in Figure 3. The results show that irrigating strawberry plants with MTIW increased the fruit yield significantly, indeed extremely, over the control in 2012 and 2014 crop seasons. On average, in the different mentioned harvests, the increase reached 42% in the 2012 crop season and 27.7% in 2014 crop season. The stimulatory effect of irrigation with MTIW is evident, as represented in Figure 3. On the other hand, summing the fruit yield of all harvests recorded and then converted this sum to a production by hectare, we obtained, in 2012 and 2014 crop seasons, for the plot irrigated with MTIW, a production of 28.3 tons and 56.2 tons, respectively, over 20.2 tons and 44.6 tons, respectively, for the controls. So, these results indicate that we achieved an increase of 8.1 tons and 11.6 tons per hectare in 2012 and 2014 crop seasons, respectively.





**Figure 3:** The fruit yield (kg) of 100 strawberry plants irrigated with normal (light grey) and magnetically treated irrigation water (dark grey) for 2012 (a) and 2014 (b) cropping seasons. The data were presented as function of the sum of GDD (Growing degree days). \*, \*\*, \*\*\* showed that the difference is significant at the 0.05; 0.01 and 0.001 levels, respectively. ns: not significant. The vertical bars represent standard error of the means

The results of this study confirm that physical treatment of irrigation water by a static magnetic field improved strawberry yield. These results were in line with those of Eşitken & Turan (2004), who found an enhancement of flowers number and total fruit yield of strawberry plants. The results value obtained from this study, corroborated with previous studies on cabbage and potato where magnetically treated irrigation water improved the quality of crops and gave a higher yield compared to the control (Taimourya et al., 2015; Taimourya et al., 2016). Similar enhancing effects of magnetically treated irrigation water have been reported abroad on other crops like pepper, groundnut, soybean, potato, canola and lettuce. In these studies the crop yield and quality were increased (Atak et al., 2000; Reina et al., 2001; Crnobarac et al., 2002; Marinkovic et al., 2002; Sevil & Günhan, 2002; Takac et al., 2002; Abdel-Ghany et al., 2005; Hozayn et al., 2016). The stimulatory impact of magnetic treatment was attributed to the increase of the availability of minerals in soil through boosting the solubility of salts and minerals (Kronenberg, 2005). The magnetically treated irrigation water has a high solubility (Mohamed et al., 2013; Todeshki et al., 2015); therefore, nutrients are more soluble in water. In fact, magnetic treatment of water restructures the water molecules into very small clusters, each made up of six symmetrically organized molecules (Ali et al., 2014). The size of molecule groups gets reduced below the diameter of capillaries in the roots of plants thus it can easily enter the passageways in plant cell membranes (Ajitkumar, 2014). Various studies have demonstrated higher absorption of nutrients in crops irrigated with magnetically treated water (Eşitken & Turan, 2004; Grewal & Maheshwari, 2011; Mohamed & Ebead, 2013; Kamorudeen & Ayodele, 2015).

### Conclusion

The current study has shown that using magnetically treated irrigation water could be applied as one of the most valuable physical growth stimulation approaches that can assist in improving yield and quality of strawberry crops. Magnetic technologies are ecologically friendly and non-polluting to the soil. In addition, the utilisation of magnetic treatment in agricultural production will enable intense and increased production in terms of both quantity and quality. It can also be used for conserving irrigation water and increasing the efficiency of added fertilizers. In conclusion, magnetic technology is a promising physical growth stimulation approach. However, further field and laboratory experiments are needed to overcome the field challenges and to gain knowledge about the working mechanism of the magnetically treated water.

### **Acknowledgement**

The authors would like to thank Atlas-Innov company, for providing help in magnetic treatment equipments. In addition, we acknowledge Dirafrast company, for organising access to the study site.

### **References**

- Abdel-Ghany SE., Müller-Moulé P., Niyogi KK., Pilon M., Shikanai T. (2005). Two P-type ATPases are required for copper delivery in Arabidopsis thaliana chloroplasts. *Plant Cell*. Vol 17(4), pp. 1233–1251.
- Ajitkumar GP. (2014). Device for magnetic treatment of irrigation water and its effects on quality and yield of banana plants. pp. 152–156.
- Ali Y., Samaneh R., Kavakebian F. (2014). Applications of Magnetic Water Technology in Farming and Agriculture Development: A Review of Recent Advances. *Curr. World Environ.* vol 9(3), pp. 695.
- Atak C., Danilov V., Yurttash B. (2000). Effects of magnetic field on soybean.(*Glycine max. L. Merrill*) seeds. *Препринт*.
- Crnobarac J., Marinkovic B., Tatic M., Malesevic M. (2002). The effect of REIS on startup growth and seed yield of sunflower and soybean. *Biophys. Agric. Prod. Univ. Novi Sad Tampograf*.
- Dhawi F., Al-Khayri JM., Hassan E. (2009). Static Magnetic Field Influence on Elements Composition in Date Palm (*Phoenix dactylifera L.*). *ResearchGate*. vol 5(2), pp. 161–166.
- Eşitken A., Turan M. (2004). Alternating magnetic field effects on yield and plant nutrient element composition of strawberry (*Fragaria x ananassa cv. camarosa*). *Acta Agric. Scand. Sect. B — Soil Plant Sci.* vol 54(3), pp. 135–139.
- Grewal HS., Maheshwari BL. (2011). Magnetic treatment of irrigation water and snow pea and chickpea seeds enhances early growth and nutrient contents of seedlings. *Bioelectromagnetics*. vol 32(1), pp. 58–65.
- Hilal MH., Hilal MM. (2000). Application of magnetic technologies in desert agriculture. II- Effect of magnetic treatments of irrigation water on salt distribution in olive and citrus fields and induced changes of ionic balance in soil and plant. *Egypt. J. Soil Sci.* vol 40(3), pp. 423–435.
- Hozayn M., Abdallah M., El-Saady A., Darwish M. (2016). Applications of magnetic technology in agriculture: A novel tool for improving crop productivity (1): Canola. *Afr. J. Agric. Res.* vol 11(5), pp. 441–449.
- Kamorudeen OY., Ayodele OO. (2015). Impact of Magnetic Treatment of Irrigation Water on the Growth and Yield of Tomato. pp. 345–348.
- Kronenberg K. (2005). Magneto hydrodynamics: The effect of magnets on fluids *GMX international*.
- Marinkovic B., Ilin Z., Marinkovic J., Culibrk M., Jacimovic G. (2002). Potato yield in function variable electromagnetic field. *Biophys. Agric. Prod. Univ. Novi Sad Tomograf*.
- Mohamed AI., Ebead BM. (2013). Effect of magnetic treated irrigation water on salt removal from a sandy soil and on the availability of certain nutrients. *Int. J. Eng.* vol 2(2), pp. 2305–8269.
- Moon JD., Chung HS. (2000). Acceleration of germination of tomato seed by applying AC electric and magnetic fields. *J. Electrostat.* vol 48(2), pp. 103–114.
- Mostafazadeh-Fard B., Khoshravesh M., Mousavi SF., Kiani AR. (2011). Effects of Magnetized Water and Irrigation Water Salinity on Soil Moisture Distribution in Trickle Irrigation. *J. Irrig. Drain. Eng.* vol 137(6), pp. 398–402.
- Nawroz A., Hero F. (2010). Impact of magnetic application on the parameters related to growth of chickpea (*Cicer arietinum L.*). *ResearchGate*. vol 3, pp. 175–184.
- Reina FG., Pascual LA., Fundora IA. (2001). Influence of a stationary magnetic field on water relations in lettuce seeds. Part II: Experimental results. *Bioelectromagnetics*. vol 22(8), pp. 596–602.

- Sevil O., Günhan E. (2002). Evaluation of chlorophyll contents and peroxides activities in I (*Helianthus annuus* L.) genotypes exposed to radiation and magnetic field. pp. 934–937.
- Taimourya H., Bourarach EH., El Harif A., Hassanain N., Masmoudi L., Baamal L., Oussible M. (2015). Évaluation de la productivité du chou pommé (*Brassica oleracea*), sous l'effet de l'irrigation avec une eau traitée magnétiquement, dans la région de Casablanca (Maroc) (Productivity of cabbage (*Brassica oleracea*), under the effect of irrigation with magnetically treated water in the region of Casablanca (Morocco)). *Rev. Marocaine Sci. Agron. Vét.* vol 3(2), pp. 27–36.
- Taimourya H., Oussible M., Bourarach E., El Harif A., Hassanain N., Masmoudi L., Baamal L. (2016). Évaluation de la productivité de la pomme de terre (*Solanum Tuberosum* L.), sous l'effet de l'irrigation avec une eau traitée magnétiquement, dans la région de Chaouia (Maroc) (Productivity of potatoes (*Solanum Tuberosum* L.), under the effect of irrigation with magnetically treated water in the region of Casablanca (Morocco)). *Rev. Marocaine Sci. Agron. Vét.* vol 3(3), pp. 30–36.
- Takac A., Gvozdenovic G., Marinkovic B. (2002). Effect of resonant impulse electromagnetic stimulation on yield of tomato and pepper. *Biophys. Agric. Prod. Univ. Novi Sad Tampograf.*
- Todeshki ARS., Vanani HR., Shayannejad M., Askari KOA. (2015). Effects of magnetized municipal effluent on some chemical properties of soil in furrow irrigation. *Int. J. Agric. Crop Sci.* vol 8(3), pp. 482.

## MEASURING THE IMPACT OF SLCAL PROJECT INTERVENTION ON TARGET FIELD CROPS IN GAZA STRIP, PALESTINE

Mohammed HUSSEIN<sup>1</sup>, Mohamed ALRAEE<sup>2</sup>, Fadi DWAIK<sup>3</sup>

<sup>1</sup>Department of Agronomy, Earth & Human Centre for Research and Study (EHCRS), Gaza, Palestine

<sup>2</sup>Earth & Human Centre for Research and Study (EHCRS), Gaza, Palestine

<sup>3</sup>The Applied Research Institute – Jerusalem (ARIJ), Bethlehem, Palestine

\*Corresponding author: mahkh101@yahoo.com

### Abstract

The experiment consisted of five varieties of field crops: wheat, barley, lentils, chickpeas and vetch. It was conducted in three different areas of the Gaza Strip (Palestine). The main idea of the experiment was to study the best varieties in terms of productivity in each target area according to the analysis of a number of different factors including climate and soil. The experiment was also aimed at determining the extent to which the Strengthening Livelihoods through Community Adaptation and Learning (SLCAL) project contributes to the productivity of field crops by comparing the productivity rates associated with the project interventions with control groups that were implemented without intervention.

The experiment relied on the experimental approach in the implementation process, which included zoning of experimental units and control units where the areas were divided according to the complete randomized sectors design. The eight target crops were planted in each experimental unit with one type of field crop per each preview unit. This mechanism was applied to all of the experimental areas. The project interventions included spraying of the Germination Inhibition Herbicide before starting the cultivation of the various crops. In addition, the compound fertilizer (NPK 13.13.13), herbicides were distributed to combat thin and broad herbs. Data was collected from primary sources including various control sites and readings were recorded for the various crop varieties in terms of seed weight, straw weight, total weight, length of the ears, numbers of branches, lengths of crops and weights of a thousand seeds. The same data was collected from the project intervention areas and soil samples were collected at a depth of 30 cm from all areas. The comparative quantitative method was used to analyze the results of the project and the experiment in another word the control without any intervention. The results showed positive effects of the project interventions at the level of productivity for all field crop varieties.

**Keywords:** *field crops, cultivation, productivity, interventions, agricultural pesticides.*

### Introduction

According to the earth and human center for researches and studies (EHCRS) vision and objectives to enhance the role of scientific research in solving the problems of society through finding practical solutions using research tools, the center promotes these trends by translating field crop programs activities into research work based on experimental methodology to choose best options to cultivate the field crops, based on the opinions of experts and specialists in the technical committee, which recommended the needs to cultivate a specific area of agricultural land within targeted areas with the same crops that the project targeted but without intervention to identify best crops to cultivate in suitable areas. The Center conducted an integrated research experiment within the field crops program during the 2015-2016 agricultural season in order to determine the general agricultural policies for field crops in Gaza Strip to improve the productivity of agricultural sector in general and economic empowerment for field crop farmers in particular, through the use of various agricultural techniques, and these agricultural techniques have been tested during the project implementation period, which extended from the end of 2012 till now. These techniques

proved their ability to increase the efficiency of agriculture production and in improving the abilities of farmers in facing climate changes.

This paper shows the most important results of the field crops program for the 2015-2016 agricultural crop season compared to the results of the experiment regions that carried out as a research work to test the feasibility of the SLCAL interventions in field crops.

## **Material and Methods**

### **Methodology**

Meanwhile, Oteng-Darko et al., (2013) reported in their study that most of agriculture experiments which concentrate on combine the soil, plant, and climatic systems to more accurately predict crop yield are very limited, the novelty of the present study relied on an experimental methodology through implementing a research experience in different regions by considering the soil texture and characteristics to judge the result of the experiment. Accordingly, standard comparison method has been adopted between the results of various interventions of SLCAL project and the result of research experiment for the same crops, which were cultivated without intervention to measure the impact of project interventions on the productivity of the targeted field crops compared with the experiment regions without intervention. The experimental methodology has been used to implement the experiment, which includes areas division into experimental units. These areas have been divided according to the design of complete random sectors by using R program (R software), and each experimental unit was divided into forty preview module with one square meter per each unit, then the eight targeted crops were grown in each experimental unit, and each crop has been cultivated in one preview module. This mechanism has been applied in all experimental regions which include Al-Qarara, Khozaa, Abasan, Al-Fokhary, Al-Shoka. About the project interventions; they included spraying of germination inhibition herbicide of type oxygal (Oxyflurufen 240gr/L) before starting cultivation of the different crops, in addition, there was fertilizers compound distribution of type NPK (13.13.13), and spraying agricultural pesticide to combat the herbs in different fields, finally, implementation of different trainings and awareness workshops about field crops management (Koba et al.,2015) .

### **Data collection methodology**

The researchers depended on primary sources to collect the data, which included data collection from different experiment areas (control groups) (Dagher, 2007)., and recording the data for the different crops as seed weight, straw weight (hay), total weight, length of ears, number of branches, length of crop, weight of 1000 seed. And the same data has been collected from the areas of the project interventions in addition to collect soil samples at depth 30 cm from all regions (Al-Qarara, Khozaa, Abasan, Al-Fokhary, Al-Shoka).

### **Data analysis methodology**

We used comparative quantitative method for analyzing the results of the project and the experiment, we used SPSS and Microsoft Excel program to extract the different results, and we used different statistical methods which included: repetition, graphs, One Way ANOVA, Post Hoc tests, and Pearson correlation coefficient between the components and the elements of the soil and the productivity rate (Almohamadi, 2011).

## **Results and Discussion**

### ***Average productivity of field crop seeds for the season 2015-2016***

The results of field crops program indicate that there is a positive impact of the project interventions on the productivity of different field crops compared with the same crops which were grown without intervention from the project (experiments region). Depending on the calculation of the productivity rate of these crops, we showed that, the highest productivity rates of field crops was in

wheat with its different types, where the average of productivity per acre in all intervention areas, which include the southern governorates of the Gaza strip (Rafah and Khanuonis), was 279.3 kg, while 97 kg for non-intervention areas (experiment), which indicates that there is an increase in wheat productivity rate with a ratio of 65.3% compared with non-intervention areas. VETCH was the second crop in productivity rates per acre in all intervention areas which reached 246.67 kg compared with 137.65 kg for areas with non-intervention (experiment), which indicates that there is an increase in VETCH productivity with ratio 44.2% in intervention areas compared with non-intervention (experiment). BARLEY was the third with general average equals to 243.8 kg per acre compared with 85.5 kg for non-intervention areas (experiment), which indicates that there is an increase in BARLEY productivity with ratio 64.9% in intervention areas compared with non-intervention. Finally, lentils and CHICKPEAS, 169.5 & 161.11 kg per acre respectively, compared with 60.85 & 90.65 for non-intervention area (experiment), which indicates that there is increase in LENTILS productivity with ratio 64.1%, and the productivity of CHICKPEAS with ratio 43.7% because of project interventions compared with different experiments areas.

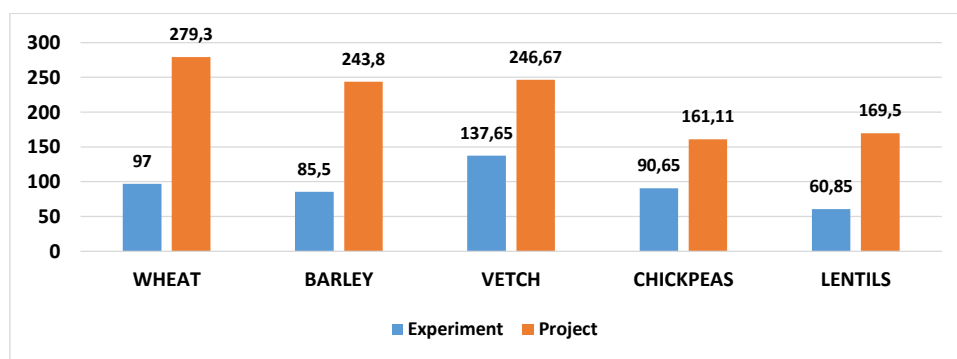


Figure 1. General average of seed weight for different crops and result of project and experiment.

#### Average productivity of seeds in intervention and experiment regions for barley

The figure below shows that the productivity rate for the intervention regions was high compared with experiment regions which implemented no interventions from the project. The highest productivity for BARLEY was in Al-Fokhary region with rate 328.33 kg per acre compared with 83 kg per acre in experiment region of Al-Fokhay region, which indicates that the productivity rate of BARLEY has been improved because of project interventions with ratio 74.7 % compared with non-intervention region. The BARLEY productivity rates between Al-Fokhay and Al-Qarara was convergent with difference of 10 kg, while the lowest productivity rate was in Al-Shoka and Khozaz regions with rate 108.33 & 185 kg per acre respectively.

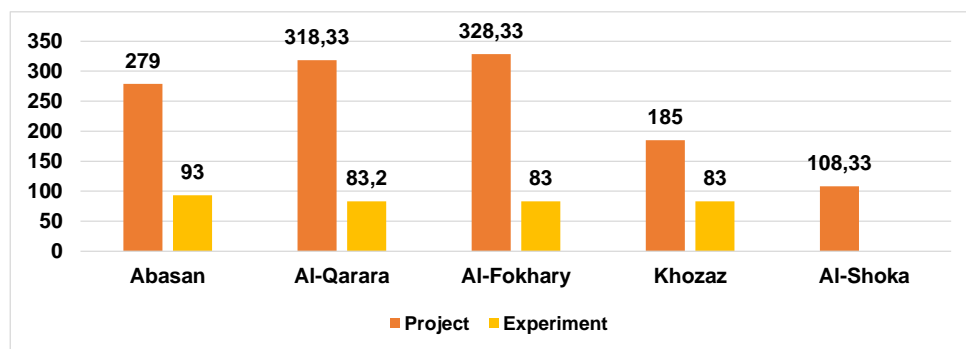


Figure 2. Productivity average for BARLEY in intervention and experiment regions.

#### Average productivity of seeds in intervention and experiment regions for chickpeas

The analysis results showed that the project interventions had a clear effect on productivity rates in different regions compared with experiment regions. The highest productivity rates for CHICKPEAS was in Abasan region with rate 211.67 kg per acre compared with 131.6 kg per acre in experiment region of Abasan region, which indicates that the productivity rate of CHICKPEAS has been improved because of project interventions with ratio 37.8 % compared with non-intervention region (experiment). The lowest productivity rate was in Al-Shoka region with rate 103.33 kg per acre.

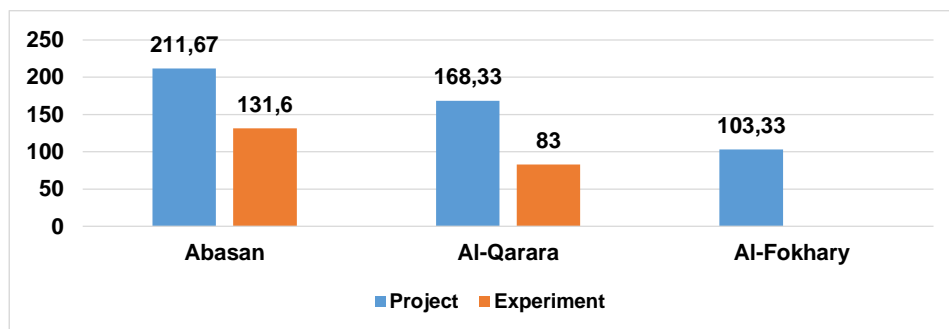


Figure 3. Productivity average for CHICKPEAS in intervention and experiment regions.

#### Average productivity of seeds in intervention and experiment regions for LENTILS

The analysis results showed that the project interventions had a clear effect on productivity rates in the different regions compared with experiment regions. The highest productivity rate for LENTILS was in Abasan region with rate 308 kg per acre compared with 54.4 kg per acre in experiment region of Abasan region, which indicates that the productivity rate of CHICKPEAS has been improved because of project interventions with ratio 82.3 % compared with non-intervention region (experiment). The LENTILS productivity rates between Al-Fokhay and Al-Qarara was convergent with difference 3.34 kg. The lowest productivity rate was in Al-Shoka region with a rate of 1110 kg per one acre.

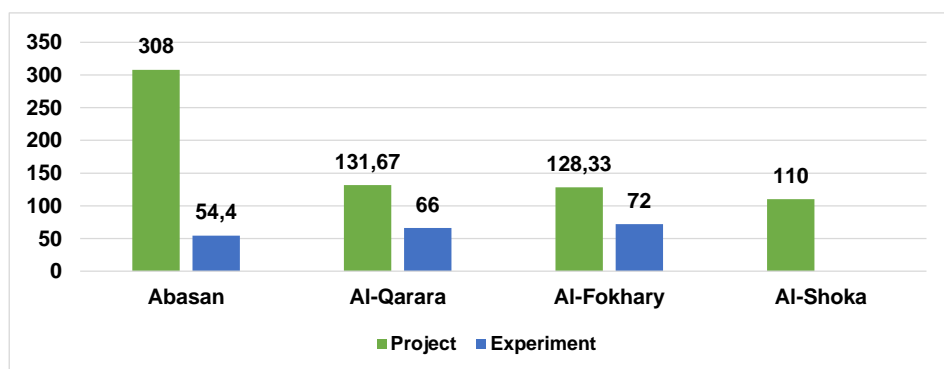


Figure 4. Productivity average for LENTILS in intervention and experiment regions.

#### Average productivity of seeds in intervention and experiment regions for vetch

The result showed that the productivity rate of VETCH seed was 246.67 kg per one acre in Al-Qarara compared with 108 kg per one acre in experiment region with non-intervention, which indicates that the productivity rate of VETCH has been improved because of project interventions with ratio 56.2% compared with non-intervention region (experiment). VETCH has been cultivated only in Al-Qarara region.

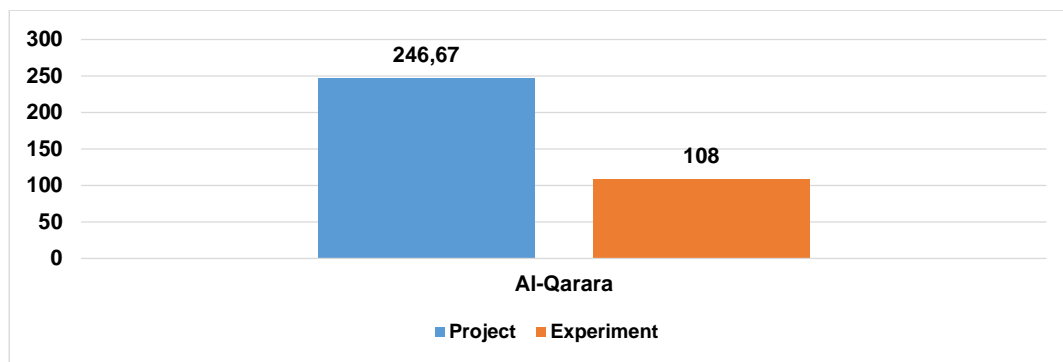


Figure 5. Productivity average for VETCH in intervention and experiment regions.

It is important to confirm here that Al-Shoka region has been targeted to implement an experiment to cultivate the field crops without any intervention, but because of external factors which damaged the experiment region represented in spraying germination inhibition herbicide of type OXYGAL by Israel planes the experiment failed, hence, we couldn't make a comparison between the intervention regions for the project and the other regions without any interventions by the project.

### **The results of seed weight differences tests for the various crops according to the region**

As shown in the table below, there is no difference of statistical significance between the different experiments regions (non-intervention) for Ariel wheat, the level of calculated significance is 0.373 which is more than significance level .05. The productivity average of Ariel wheat was between 140 kg per acre in Al-Qarara region and 67 kg per acre in Al-Fokhary region, which means that there is no differences in productivity average which has statistical significance if this crop has been cultivated in any targeted region with non-intervention. Regarding AMIT wheat, the tests results showed that there is difference of statistical significance between different experiment regions (non-intervention), the level of calculated significance is 0.0, which is less than significance level .05. And to identify the nature of differences, we used PostHoc "LSD", which showed a difference between Al-Qarara region and Abasan, Al-Fokhay, Khozaa with differences of 156, 181, 166 kg per acre respectively, which means that Al-Qarara region is the best region for cultivation of AMIT wheat. As shown in the table below, there is no difference of statistical significance between the different experiments regions (non-intervention) for BLOND DEBYA wheat, the level of calculated significance is 0.244 which is more than significance level .05. The productivity average of BLOND DEBYA wheat was between 117 kg per acre in Al-Qarara region and 68 kg per acre in Khozaa region, which indicates that there is no difference in productivity average volume if this crop has been cultivated in any region with non-intervention. About YUVAL wheat, the tests results showed that there is difference of statistical significance between different experiment regions (non-intervention); the level of calculated significance is 0.004, which is less than significance level .05. And to identify the nature of differences, we used PostHoc "LSD", which showed a difference between Al-Qarara region and Abasan, Al-Fokhay, Khozaa with differences of 83, 91, 93 kg per acre respectively, which means that Al-Qarara region is the best region for cultivation of YUVAL wheat. Also the tests result showed that there is no difference of statistical significance between different experiment regions (non-intervention) for BARLEY; the level of calculated significance is 0.877, which is more than significance level .05. The productivity average of BARLEY was between 93 kg per acre in Al-Qarara region and 83 kg per acre in Khozaa and Al-Fokhary region. Also the tests result showed that there is no difference of statistical significance between different experiment regions (non-intervention) for VETCH; the level of calculated significance is 0.413, which is more than significance level .05. The productivity average of vetch was between 93 kg per acre in Abasan region and 108 kg per acre in Al-Qarara region.

About CHICKPEAS, the tests results showed that there is difference of statistical significance between different experiment regions (non-intervention); the level of calculated significance is 0.001, which is less than significance level .05. And as shown in the PostHoc "LSD" results, there



are differences between Al-Qarara and Abasan with a difference of 111 kg per acre for Abasan region. Also there are differences between Al-Qarara and Al-Fokhary region which differs 63 kg per acre for Al-Fokhary region. There are also differences between Al-Qarara and Khozaa region which differs 108 kg per acre for Khozaa region, which means that Abasan region is the best region for cultivation CHICKPEAS.

Also the tests result showed that there is no difference of statistical significance between different experiment regions (non-intervention) for LENTILS; the level of calculated significance is 0.627, which is more than significance level .05. The productivity average of lentils was between 72 kg per acre in Al-Fokhay region and 51 kg per acre in Khozaa region.

Table 1. The results of seed weight tests for different crops in the experiment for each region.

Crop	Region	Mean	Standard deviation	F-Test	Sig.	Comment
ARIEL Wheat	Abasan	101	55.95	1.113	0.373	No significant differences between the regions
	Al-Qarara	140	96.37			
	Al-Fokhay	67	32.33			
	Khozaa	91	55.95			
AMIT Wheat	Abasan	77	2.74	20.331	0	Significant differences between the regions
	Al-Qarara	233	81.36			
	Al-Fokhay	52	19.56			
	Khozaa	67	2.74			
BLOND DEBYA Wheat	Abasan	78	18.91	1.535	0.244	No significant differences between the regions
	Al-Qarara	117	62.31			
	Al-Fokhay	84	35.6			
	Khozaa	68	18.91			
YUVAL Wheat	Abasan	78	6.71	6.739	0.004	Significant differences between the regions
	Al-Qarara	161	71.1			
	Al-Fokhay	70	28.06			
	Khozaa	68	6.71			
BARLEY	Abasan	93	19.24	0.226	0.877	No significant differences between the regions
	Al-Qarara	83.2	17.92			
	Al-Fokhay	83	33.47			
	Khozaa	83	19.24			
VETCH	Abasan	160.6	36.64	1.012	0.413	No significant differences between the regions
	Al-Qarara	108	59.43			
	Al-Fokhay	133	68.25			
	Khozaa	149	26.84			
CHICKPEAS	Abasan	131	23.29	9.809	0.001	Significant differences between the regions
	Al-Qarara	20	6.12			
	Al-Fokhay	83	66.58			
	Khozaa	128	22.53			
LENTILS	Abasan	54.4	14.17	0.595	0.627	No significant differences between the regions
	Al-Qarara	66	27.02			
	Al-Fokhay	72	46.72			
	Khozaa	51	11.4			

**The relationship between the productivity and the soil elements**

According to the analysis results about the content of elements in the soil in all project regions, the results showed a positive relationship between the pH and productivity for all the crops except lentils, which means that the increasing of pH in the soil will increase the productivity for all the field crops except LENTILS. The productivity average of LENTILS decreases with pH increase because the productivity of LENTILS decreases with increase in the salts in the soil. LENTILS is sensitive to high load of salts in the soil and it gives the best productivity rate when pH ranges from 6 to 9. Also the results showed a positive relationship between the phosphorus element and the productivity average for all the crops except BLOND DEBYA wheat and BARLEY, which means that the increasing of phosphorus element in the soil will decrease the productivity for these two crops because the suitable pH for these two crops is from 6.5 to 7 as if pH in the soil is more than 8, the absorption of phosphorus by these two crops is not easy, hence, the total productivity average of BLOND DEBYA wheat and BARLEY seeds has been decreased. In addition to the increase of salts in the soil in the regions that has been cultivated of these two crops, the regions that have been cultivated with BLOND DEBYA wheat have the highest percentage of dissolving salts (Al-Fokhary, Al-Shoka and Al-Qarara). There is an inverse relationship between the soil conductivity (EC) and the productivity average volume and there is the same relationship between the productivity and total dissolved solids (TDS) for all field crops, which means that the increase of EC and TDS in the soil cause decreasing in the productivity for all the crops except BARLEY, because BARLEY has the highest ability to bear the soil salinity compared with the other field crops that the project has grown. And we can notice that there is an inverse relationship between the productivity average and different elements in soil like NO<sub>3</sub>, PO<sub>4</sub> and K, which means that the increase of these elements in the soil cause decreasing in the productivity. From practical side, the increase of these elements in the soil will cause increase in productivity average, but the decrease of productivity in this status maybe refer to existence of other effects which were not studied, caused the inability to absorb and get the benefits from these elements and these results contradict with the results of ( Koba et al., 2015) which revealed positive relationship between the productivity average and different elements in soil like NO<sub>3</sub>, PO<sub>4</sub> and K. The researchers justified that the soil characteristics in Gaza strip-Palestine is different in its pH, EC which effects on the absorption of NO<sub>3</sub>, PO<sub>4</sub> and K, and this lead to hinder the level of absorption to these elements by plants which decreasing the crops productivity.

Table 3. Pearson correlation coefficient between soil nutrients and average productivity.

Soil Elements	Pearson correlation coefficient						
	ARIEL Wheat	AMIT Wheat	BLOND DEBYA Wheat	BARLEY	CHICKPEAS	LENTILS	Crops as a whole
pH	0.811	0.796	1	4	0.362	-0.111	0.434
EC	-0.562	-0.512	-0.363	0.501	-0.191	-0.674	-0.22
TDS	-0.613	-0.561	-0.45	0.475	-0.191	-0.656	-0.247
NO <sub>3</sub>	-0.929	-0.902	-0.43	0.557	0.243	-0.238	-0.167
P	0.157	0.149	-0.597	-0.211	0.693	0.953	0.186
PO <sub>4</sub>	-0.959	-0.985	-0.922	-0.133	-0.42	-0.565	-0.478
K	-0.789	-0.834	-0.738	-0.642	-0.982	-0.768	-0.542

**Conclusions**

The main conclusions of the field trial emphasized that there was variation in the productivity rate according to region, where the productivity average for wheat per acre was the highest productivity rate in all cultivated field crops. Al-Qarara was the best region for cultivation the ARIEL wheat; it has the highest productivity rate, while Al-Fokhay region has the lowest productivity for this crop.

Also, Al-Qarara region was the best region for cultivation the AMIT wheat; it has the highest productivity rates, while Al-Fokhay region has the lowest productivity for this crop. Al-Qarara region was the best region for cultivation of the Blond Depya wheat; it has the highest productivity rate, then Al-Shoka region. While, Al-Fokhay region has the lowest productivity in this crop. Al-Shoka region was the best region for cultivation of YUVAL wheat; it has the highest productivity rate, while Khozaa region has the lowest productivity for this crop. Regarding chickpeas, Abasan region was the best region for cultivation the chickpeas; it has the highest productivity rate, then Al-Fokhay region, while Al-Shoka region has the lowest productivity for this crop. Abasan region was the best region for cultivation of lentil; it has the highest productivity rate, while Al-Shoka region has the lowest productivity for this crop.

What interesting in the result that, there is positive relationship between pH and productivity for all field crops except BARLEY. As well, there is a positive relationship between phosphorus (P) and productivity for all field crops except BLOND DEBYA wheat and BARLEY. However, there is inverse relationship between soil conductivity (EC) and productivity, and the same relationship between total dissolved solids (TDS) and the productivity for all field crop except BARLEY. Also, there is inverse relationship between  $\text{NO}_3$ ,  $\text{PO}_4$ , K and the productivity of field crops. Accordingly, the researchers recommended to continue the interventions of the project activities because it showed big differences in productivity rates between the interventions regions from the project, and non-intervention regions, for all various field crops without exception. To continue growing wheat of all cultivars (ARIEL, AMIT, BLOND DEBYA and YUVAL) because it gave highest productivity rates in all regions. To cultivate wheat of types AMIT, ARIEL and BLOND DEBYA because these types have the best productivity in Al-Qarara region respectively. To cultivate YUVAL wheat in Al-Shoka region, because it gave the highest productivity rate in this region. To cultivate BARLEY in Al-Fokhary region, because it gave the highest productivity rate in this region. To cultivate LENTILS and CHICKPEAS in Abasan region because they gave the highest productivity rate in this region. Finally, to conduct a large study on the factors that make difficult for the crops to get benefits from the soil elements and prevent crops to absorb and get benefits from nutrients, in spite of existence of these elements in the soil, like  $\text{NO}_3$ ,  $\text{PO}_4$  and K so, there was an inverse relationship between these elements and the productivity for the various field crop.

### References

- Al grad K.M (2009). Analysis of variance and its use in the study of the agricultural sector in Syria (Wheat - barley - sheep). University of Damascus, Syria.
- Almohamadi, S. M. (2011). Statistics and design experiments. Osama for Publishing and Distribution, publication place.
- Dagher, A. L. (2007). Design and analysis of agricultural experiments. Al Qadesia University, publication place.
- Koba, R. Arsalan, O. Saadon, M. Mohammed, N. Hammo, M. and Shirzad, Y. (2015). The effect of Azot and phosphorous fertilizers on wheat productivity and soil characteristics under conservative agriculture in Syria. Syrian Journal of agriculture researches, 2 (1): 2015 (Arabic copy).
- Oteng-Darko, P. Yeboah, S. Addy, S. Amponsah, S. and Owusu Danquah, E. (2013). Crop modeling: A tool for agricultural research – A review. E3 Journal of Agricultural Research and Development Vol. 2(1). pp. 001-006, March, 2013.

## RELATIVE FEED VALUE (RFV) OF ALFALFA-GRASS MIXTURES AFFECTED BY SPENT MUSHROOM SUBSTRATE AND SLURRY APPLICATION

Kazimierz JANKOWSKI\*, Elżbieta MALINOWSKA, Milena TRUBA, Jacek SOSNOWSKI,  
Beata WIŚNIEWSKA-KADŻAJAN, Janina SKRZYCZYŃSKA

Siedlce University of Natural Sciences and Humanities, Department of Grassland and Green Areas Creation, Siedlce,  
Poland

\*Corresponding author: laki@uph.edu.pl

### Abstract

The study was conducted on experimental plots between 2012 and 2015, in a completely randomized arrangement and with three replications. The aim of the experiment was to evaluate the effect of spent mushroom substrate and slurry on productivity and nutritional value of dry matter of hybrid alfalfa-grass mixtures. In the experiment three plant species were used: hybrid alfalfa, orchard grass, and perennial ryegrass. These species were sown as three legume-grass mixtures. Organic fertilizers, i.e. spent mushroom substrate and liquid manure, or slurry, were used in different combinations. In this paper, dry matter digestibility was estimated. Based on the fraction of neutral detergent fibre, acid detergent fibre, and dry matter intake (% body weight) were calculated. Additionally, relative nutritional value, which is an indication of relative feed value, was estimated. In comparison with mushroom substrate, slurry application resulted in higher digestibility of the legume-grass mixtures, higher dry matter intake, dry matter content, and relative food value. Forage of the ryegrass and alfalfa mixture had the most favourable dry matter intake and relative food value.

**Keywords:** *spent mushroom substrate, slurry, mixtures, relative feed value, dry matter intake*

### Introduction

In crop rotation, growing grass after other crops repeatedly on the same field affects crop yields and soil quality in a positive way. In farming of this type the quality of the yield is also important; cultivation of legume-grass mixtures brings about a well-balanced fodder. Those mixtures play a large role in both integrated and organic production systems (Duer 1999). Thus, legume-grass mixtures are a source of very valuable fodder of balanced chemical composition (Krzywiecki *et al.*, 1997 and Gawel, 2008), with components absolutely necessary in animal nutrition. According to Gawel and Ścibior (2000) such crops are one of the cheapest fodder sources, and they have beneficial effects on follow-up crops, leaving the soil in good condition (Kryszak, 2003). In organic farming, it is also important to use organic fertiliser that will be safe for the environment, but at the same time, it should favourably affect the yield and quality of crops. Slurry and mushroom substrate can be used as such fertiliser. Poland is a leading producer of mushrooms, which leads to the creation of large amounts of mushroom substrate, an organic waste material which is a problem for the producers. At the same time it is an extremely valuable organic fertilizer which can be used in agriculture. The substrate removed from the mushrooms house as mushroom waste is a potentially a good fertilizer. It is an organic mass that is converted into humus in the soil. Wiśniewska-Kadżajan (2012) states that the content of macronutrients after mushroom cultivation in g kg<sup>-1</sup> d.m. amounted to: nitrogen 13.0-26.0; phosphorus 1.0-10.0; potassium 5.0-25.0; magnesium 2.0-5.20; calcium 60.0-150.0; sodium 0.5-2.9. Mushroom substrate is also characterized by high contents of microelements and low heavy metals (Hackmann *et al.*, 2008). In the opinion of Wiśniewska-Kadżajan (2012, 2013) the used mushroom substrate is a valuable source of organic matter with a low C:N ratio. Many researchers have reported high variability and imbalance of the chemical composition of the mushroom substrate, which is an unquestionable drawback, which should

require their chemical composition to be continually controlled and the missing elements to be replenished to improve the fertilizer's properties (Polat *et al.*, 2009). Another valuable fertilizer is slurry, which is completely different from manure both in terms of physical characteristics and effects on plants. Łabętowicz (2002) showed that the nutrients in slurry are present in forms more easily available to plants than in manure. That is why slurry is a fast-acting fertiliser.

The aim of the experiment was to evaluate the effect of spent mushroom substrate and slurry on the productivity and nutritional value of dry matter of hybrid alfalfa-grass mixtures.

### Material and Methods

Set up in the autumn of 2012 and lasting from 2012 to 2015, the three-year research was conducted in the experimental field of the Department of Grasslands and Landscape Architecture Development, the University of Humanities and Natural Sciences in Siedlce. The experiment was replicated three times each year, with a split-plot arrangement and plots of 3 m<sup>3</sup> as experimental units. In the experiment, the main research factors were legume-grass mixtures and organic fertilizers with high organic matter content (mushroom substrate and cow slurry, used separately and in various combinations). The experiment consisted of the following units: control (no fertilization) (C); mushroom substrate (30 t · ha<sup>-1</sup>) (MS); slurry (60 m<sup>3</sup> · ha<sup>-1</sup>) (S); mushroom substrate (10 t · ha<sup>-1</sup>) + slurry (60 m<sup>3</sup> · ha<sup>-1</sup>) (MS10 + S60); mushroom substrate (20 t · ha<sup>-1</sup>) + slurry (40 m<sup>3</sup> · ha<sup>-1</sup>) (MS20 + S40); mushroom substrate (30 t · ha<sup>-1</sup>) + slurry (20 m<sup>3</sup> · ha<sup>-1</sup>) (MS30 + S20). These species were grown as three legume-grass mixtures: M1 - *Dactylis glomerata* cv. 'Bora' + *Lolium perenne* cv. 'Info' + *Medicago x varia* T. Martyn cv. 'Tula'; M2 - *Dactylis glomerata* cv. 'Bora' + *Medicago x varia* T. Martyn cv. 'Tula'; M3 - *Lolium perenne* cv. 'Info' + *Medicago x varia* T. Martyn cv. 'Tula'. In the above mixtures the proportion of each component was the same.

In the experiment, organic fertilizer was used in the form of slurry and mushroom substrate. Mushroom substrate was applied once at the start of the experiment, before the growing season, in different doses mixed with the soil. Slurry was used every year throughout the experiment, in equal doses after each harvest. Table 1 presents the chemical composition of slurry and mushroom substrate.

Table 1. Concentration of selected macro-elements (g · kg<sup>-1</sup> DM) in mushroom substrate and slurry

Nutrient	Mushroom substrate	Slurry
N	24.50	48.00
P	9.50	12.64
K	13.20	43.16
Ca	58.20	30.75

The experiment was set up on soil with a granulometric composition of loamy sand, of the order of anthropogenic, the type of culture earth soil, and the subtype of horticole. Chemical analysis of the soil showed high contents of absorbable forms of phosphorus and magnesium. However, absorbable forms of potassium were within the limits of the average content. Sielianinov's hydrothermal coefficient was calculated to determine temporal variation of meteorological elements and their effects on vegetation.

Optimal temperature and moisture conditions occurred only in April 2014 and in September 2015. In the remaining months of the growing periods, the weather conditions were not as favourable, varying from extremely dry in August 2015 to extremely wet in May 2013. Throughout the experiment the best conditions occurred at the beginning of each growing period. It can be concluded that the most difficult situation for plants occurred in 2015, when, apart from May and the end of the growing period, the weather ranged from moderately dry to extremely dry.

Table 2. The value of Sielianinov's hydrothermal coefficient (K) in the growing season

Year	Month						
	April	May	June	July	August	September	October
2013	2.56 (sw)	3.07 (ew)	2.11 (w)	0.84 (d)	0.78 (d)	2.53 (sw)	0.60 (sd)
2014	1.36 (o)	1.87(mw)	1.64(mw)	0.59 (sd)	1.92(mw)	0.64 (sd)	0.12 (ed)
2015	1.22 (md)	2.63 (sw)	0.87 (d)	1.08 (md)	0.18 (ed)	1.46 (o)	1.94 (mw)

$K \leq 0.4$  extreme drought (ed).  $0.4 < K \leq 0.7$  severe drought (sd).  $0.7 < K \leq 1.0$  drought (d1.0).  $< K \leq 1.3$  moderate drought (md).  $1.3 < K \leq 1.6$  optimal (o).  $1.6 < K \leq 2.0$  moderately wet (mw).  $2.0 < K \leq 2.5$  wet (w).  $2.5 < K \leq 3.0$  severely wet (sw).  $K > 3.0$  extremely wet (ew)

During each growing season all the mixtures were harvested three times. The fresh matter from each plot was weighed and a sample of 0.6 kg was taken. This was used to determine dry matter content and to perform chemical analysis. Dry matter digestibility was estimated. Based on the fraction of neutral detergent fiber (NDF) and acid detergent fiber (ADF), dry matter intake (DMI) (% body weight) was calculated and relative nutritional value (RFV), an indication of the relative feed values of the feed, was estimated – all the parameters were determined using the method of Linn and Martin (1989). The chemical composition of the plants was determined with near-infrared spectroscopy (NIRS) using the NIRFlex N-500 spectrometer. Data were analysed using analysis of variance. The Fisher-Snedecor test was used to determine the significance of effects of experimental factors on the parameters tested in the study. Tukey's test was used to compare means at the least significant difference -  $LSD_{0.05}$  significance level. All the calculations were made with the Statistica 6.0 – 2001 program.

## Results and Discussion

Digestibility is the percentage of feedstuff absorbed from the gastrointestinal tract into the body (Pawlak, 1990). According to Stachowicz (2010) roughage intended for ruminant feeding should be digestible at around 65%. Considering the relationship between dry matter digestibility and the fertilizer applied, organic fertilizers both in the form of mushroom substrate and slurry significantly improve digestibility. Forage from the plots where 20 t ha<sup>-1</sup> of mushroom substrate and 40 m<sup>3</sup> ha<sup>-1</sup> of slurry were applied had the highest digestibility (55.13%), while the lowest (50.91%) was for the forage from the plot without fertilizers. The mixture of hybrid alfalfa with orchard grass (M2) had the highest digestibility (56.39%) on the plot where only mushroom substrate was used (Table 3). The lowest (47.68%) was for the mixture of perennial ryegrass with alfalfa (M3) on the control plot. The mixture of hybrid alfalfa with orchard grass (M2) had higher digestibility if mushroom substrate was applied and it was lower when slurry was used. It was the other way round in the case of perennial ryegrass with alfalfa, the digestibility of which was higher on the plot with slurry than on the plot with substrate. However, the differences between the mixtures concerning dry matter digestibility were statistically insignificant.

Small differences in digestibility between mixtures of alfalfa with grasses and with other legumes were also observed by Gawel (2008), but this was at a much higher level of digestibility (approximately 64%) than in the present experiment. It turned out that the addition of other legume plants (*Onobrychis viciifolia* Scop. or *Lotus corniculatus* L) to a mixture of alfalfa with grass increased fodder digestibility. A mixture of alfalfa with *Festulolium* in the experiment of Sosnowski (2012a) had a slightly higher digestibility (about 60.3%) than the mixtures in the present experiment. Borowiecki (1997) found that the presence of alfalfa in a mixture affected forage digestibility.

**Table 3.** The effect of different forms of fertilizers on dry matter digestibility (%) (average of all harvests)

Mixture (B)	Fertilizer (A)						Mean
	C	MS	S	MS10+S60	MS20+S40	MS30+S20	
M1	50.29	51.10	55.33	54.23	56.17	50.82	52.99
M2	54.75	56.39	53.48	50.92	53.86	51.53	53.49
M3	47.68	49.69	55.31	56.32	55.34	50.89	52.54
Mean	50.91	52.39	54.71	53.82	55.13	51.08	53.01
LSD <sub>0.05</sub> for: A= 3.020; B= n.s; B/A= 3.030; A/B=3.698;							

Legume-grass mixtures: M1 - *Dactylis glomerata*+ *Lolium perenne*+ *Medicago x varia* T. Martyn; M2 - *Dactylis glomerata*+ *Medicago x varia* T. Martyn; M3 - *Lolium perenne*+ *Medicago x varia* T. Martyn. The experiment consisted of the following units: control (C), mushroom substrate (MS), slurry (S). LSD - Least Significant Difference.

Forage quality largely depends on the plant development stage at the time when it is harvested. The older a plant is the lower its feed value. This is caused by an increase in fibrous fraction content in the biomass, and in consequence dry matter intake (DMI) also increases (Hintz and Albrecht, 1991). Studying the effect of different fertilizer combinations on dry matter intake calculated on the basis of the content of NDF (neutral detergent fiber) fibre fractions showed that ryegrass grown together with alfalfa generally had a higher NDF than the two other mixtures. Forage of the mixture with three plant species had the highest dry matter intake on the control plot, while orchard grass grown together with alfalfa had the highest dry matter intake on the plot with mushroom substrate. Sosnowski (2012a) demonstrated that ryegrass had a higher intake than orchard grass. Additionally, compared to the present experiment, Sosnowski and Jankowski (2013) and Sosnowski (2012b) observed somewhat lower values of DMI, about 2.5%, in a mixture of *Festulolium* with alfalfa. In another experiment Sosnowski (2012b) found that mixtures with red clover had a higher dry matter intake, and he also showed that increased doses of nitrogen reduced dry matter intake. In the present experiment the forage on the plot where 30 t ha<sup>-1</sup> of mushroom substrate with 20 m<sup>3</sup> of slurry was used had the lowest DMI. It was highest for the mixture of ryegrass with alfalfa (Table 4) on the plot where 10 t ha<sup>-1</sup> of mushroom substrate and 60 m<sup>3</sup> ha<sup>-1</sup> of liquid manure were applied (3.30% of body weight) and on the plot with 20 t ha<sup>-1</sup> of mushroom substrate with 40 m<sup>3</sup> ha<sup>-1</sup> of liquid manure (3.27% of body weight). In the case of orchard grass with alfalfa the highest DMI was for forage from the plot with slurry (3.16% of body weight), while the three-plant mixture of orchard grass with perennial ryegrass and alfalfa had the highest value of dry matter intake (3.25% of body weight) on the control plot. The smallest DMI was found in the ryegrass and alfalfa mixture and in the three-plant mixture with orchard grass, perennial ryegrass, and alfalfa on the plot when only mushroom substrate was used (3.02% of body weight). Concerning the mixture of orchard ryegrass and alfalfa, the lowest DMI (3.01-3.03% of body weight) was in plants from the plots with both mushroom substrate and slurry applied.

The quality of roughage should satisfy the animals' requirements, which in turn depend on their species and performance. Based on the content of ADF and NDF fibre fractions, it is possible to calculate relative feed value (RFV), combining digestibility and feed intake in one parameter (Linn and Martin 1989; Jankowska-Huflejt and Wróbel, 2008).

The results show that only the following mixtures can be assessed as Class 2 perennial ryegrass with alfalfa on the plot where mushroom substrate was used (RFV of 147.96), orchard grass with alfalfa on all the plots where mushroom substrate was used together with slurry (RFV of 147.92, 148.59, 148.76), and the mixture of orchard grass, perennial ryegrass, and alfalfa from plots with mushroom substrate used both on its own (RFV of 148.34) and on the plots with 30 t of substrate with 20 m<sup>3</sup> of slurry (RFV of 148.63). Class 2 forage is adequate for high-producing dairy cows and young heifers selected for breeding.

**Table 4.** The effect of different forms of fertilizers on dry matter intake - DMI (% of body weight) and Relative Feed Value - RFV (average of all harvests)

Mixture (B)	Fertilizer (A)						Mean
	C	MS	S	MS10+S60	MS20+S40	MS30+S20	
DMI [% of body weight]							
M1	3.25	3.02	3.09	3.17	3.13	3.06	3.12
M2	3.12	3.12	3.16	3.02	3.03	3.01	3.08
M3	3.14	3.02	3.17	3.30	3.27	3.07	3.16
Mean	3.17	3.05	3.14	3.16	3.14	3.05	
LSD <sub>0,05</sub> for: A= 0.11; B=n.s. ; B/A= 0.10; A/B=0.13;							
RFV (Relative Feed Value)							
M1	164.08	148.34	154.24	157.74	156.47	148.63	154.92
M2	157.70	157.40	157.59	147.92	148.59	148.76	152.99
M3	156.51	147.96	157.92	165.34	163.86	150.68	157.05
Mean	159.43	151.23	156.58	157.00	156.3	149.36	
LSD <sub>0,05</sub> for: A= n.s. B= 9.99; B/A= 7.69; A/B=8.97;							

Legume-grass mixtures: M1 - *Dactylis glomerata*+ *Lolium perenne*+ *Medicago x varia* T. Martyn; M2 - *Dactylis glomerata*+ *Medicago x varia* T. Martyn; M3 - *Lolium perenne*+ *Medicago x varia* T. Martyn. The experiment consisted of the following units: control (C), mushroom substrate (MS), slurry (S). LSD - Least Significant Difference.

Forage from the other plots was assessed as Class 1, which means that it can be used for feeding the best milking cows with very high productivity. Comparing relative feed value of the legume-grass mixtures used in the experiment with relative feed value of Class 3 and 4 grass from meadows and pastures, it can be concluded that the former is much better for ruminants than the latter (Jankowska, 2013; Jankowska-Huflejt and Wróbel 2008).

### Conclusions

Forage from the plot with 20 t ha<sup>-1</sup> of mushroom substrate together with 40 m<sup>3</sup> ha<sup>-1</sup> of slurry applied had the highest % digestibility. The highest dry matter intake (DMI) and the highest relative feed value (RFV) were obtained by applying 10 t ha<sup>-1</sup> of mushroom substrate with 60 m<sup>3</sup> ha<sup>-1</sup> of slurry. Higher doses of mushroom substrate and lower doses of liquid manure resulted in a lower digestibility and relative feed value (RFV) of ryegrass with alfalfa forage. Generally, in comparison with mushroom substrate, slurry application resulted in higher digestibility of the legume-grass mixtures, higher dry matter intake (DMI), dry matter content, and relative food value (RFV). Forage of the ryegrass and alfalfa mixture (M3) had the most favourable dry matter intake (DMI) and relative food value (RFV).

### References

- Borowiecki J. (1997). Usefulness of *Festulolium* for cultivation in mixtures with hybrid alfalfa. Puławsk's diary, 109: 35-44.
- Duer I. (1999). Dry matter yield of several varieties of clover cultivated in ecological and integrated production system and nitrogen accumulation in soil. Bulletin Sciences. AR Kraków, Scientific Session, 62: 69-77.
- Gaweł E. (2008). The effect of the way and frequency of utilization of lucerne grass mixtures (*Medicago sativa* L. x *varia* T. Martyn) on their yield, botanical composition and quality. Water-Environment-Rural Areas, 24: 5-18.
- Gaweł E., Ścibior H. (2000). Mixture of legumes plants with grasses in sustainable agriculture. Puławski's diary, 120: 127-132.



- Hackmann, J. D. Sampson, and J. N. Spain J. (2008). Comparing relative feed value with degradation parameters of grass and legume forages. *T. J. Anim. Sci.* 86(23): 2344–2356 doi:10.2527/jas.2007-0545.
- Hintz R.W., Albrecht K.A. (1991). Predictions of alfalfa chemical composition from maturity and plant morphology. *Crop Sci.* 31: 1561-1565.
- Jankowska, J. (2013). Impact of methods control of common dandelion (*Taraxacum officinale*) on the relative nutritional quality of meadow hay. *Folia Pomeranae Universitatis Technologiae Stetinensis. Agricultura, Alimentaria, Piscaria et Zootechnica*, 25: 51-58.
- Jankowska-Huflejt, H., Wróbel, B. (2008). Evaluation of usefulness of forages from grasslands in livestock production in examined organic farms. *Journal of Research and Applications in Agricultural Engineering*, 53(3): 103-108.
- Kryszak J. (2003). Economic value of legumes-grass mixtures in field cultivation. *Annual. AR Poznań, Sciences*, 338: 108.
- Krzywiecki, S., Gospodarczyk, F., Szyszkowska, A., Sowinski, J., Nowak, W. (1997). Yield and nutritional value of white clover in mixtures with grasses of tetraploid varieties in the year of sowing. *Scientific Papers of Agriculture University in Wrocław. Animal husbandry*, 42: 83-93.
- Linn J.G., Martin N.P. (1989). Forage quality test and interpretation. Minnesota Extension Service, University of Minnesota: 1-5.
- Łabętowicz J. (2002). Organic fertilizers. Agricultural chemistry-theoretical and practical basis. Ed. Warsaw Agricultural University. Warsaw. ISBN: 83-7244-285-1: 65.
- Pawlak T. (1990). Nutritional value of grassland fodder based on the evaluation (analysis) of the quality of organic and mineral substances. *Mat. KUR PAN, Section of Grassland*: 8-65.
- Polat E., Uzan I.H., Topcuoglu B., Önal K., Onus A.N., Karaca M. (2009). Effects of spent mushroom compost on quality and productivity of cucumber (*Cucumis sativus* L.) grown in greenhouses. *African J. of Biotechnology*, 8 (2): 176-180.
- Sosnowski J. (2012a). Effect of soil's fertilizer used in cultivation *Lolium perenne* L., *Dactylis glomerata* L. and *Festuca pratensis* Huds. on relative food value (RFV) *Fragm. Agron.* 29(3): 136-143.
- Sosnowski J. (2012b.) RFV value of *Festulolium* mixtures with red clover and alfalfa supplied with soil's medium amendment. *Grassland Science in Poland*, 15: 167-176.
- Sosnowski J., Jankowski K. (2013). Evolution of the feed quality of *festulolium braunii* mixtures with microbiologically supplied red clover and alfalfa. *Journal of Ecological Engineering*, 14(3): 63-68.
- Stachowicz T. (2010). Rational use of grassland in an ecological farm. Center of Agricultural Advisory in Brwinow. Radom.
- Wiśniewska-Kadzajjan B. (2012). Assessment of usefulness of the substrate after mushrooms growing to plant fertilization. *Environmental Protection and Natural Resources*, 54: 165-176.
- Wiśniewska-Kadzajjan B. (2013). Fertilization effect of mineral NPK, organic farmyard manure and mushroom's compost on the content and uptaking of potassium and magnesium by the meadow sward. *Folia Pomeranae Universitatis Technologiae Stetinensis Agricultura Alimentaria Piscaria et Zootechnica*, 304 (26): 107-116.

## THE EFFECTIVENESS OF DIFFERENT OVERDRILLING TECHNOLOGIES OF THE DRY MEADOWS IN CENTRAL POLAND

Maria JANICKA

Department of Agronomy, Warsaw University of Life Sciences – SGGW, Poland

\*Corresponding author: maria\_janicka@sggw.pl

### Abstract

The nutritive value of bulk fodder produced from grassland is dependent on the botanical composition of sward and the proportion of valuable grass and legumes species. The aim of the study was to evaluate the effects of overdrilling of dry meadows depending on the treatment of the sward existing before renovation. The study was carried out in central Poland, in the valley of the river Pisia Tuczna (37 km west of Warsaw), on degraded permanent grassland, which had been extensively managed and fertilized. The competitiveness of the original sward before overdrilling (performed by a Vredo slot seeder) was reduced by: (1) low cutting without herbicides, (2) selective herbicides, (3) non-selective herbicide, (4) rototilling. The effectiveness of those treatments was compared with the control object which was not subjected to any treatment and was not fertilized. Dry matter yields, botanical composition of each cut and contents of the mineral macronutrients were measured according to Polish Norms or research procedures. The applied renovation technologies resulted in an increase in yields (in average from 86% to 125%) compared to the yield of the control original sward. The highest yields and the share of the sown species were obtained in the case of overdrilling preceded by rototilling (in average 6.62 Mg·ha<sup>-1</sup> and 58.2% respectively) or spraying by non-selective herbicide (in average 7.09 Mg·ha<sup>-1</sup> and 55% respectively). *Dactylis glomerata* L. was the most useful species to overdrilling of dry meadows, irrespective of technology (average 41-50% of sown species). The differences in the contents of macronutrients in the meadow sward were determined primarily by changes in species composition, which occurred to stay under the influence of the applied oversowing technologies and fertilization. The contents of phosphorus (0.36-0.40% P), potassium (1.44-1.68% K), magnesium (0.23-0.26% Mg), calcium (0.85-0.97% Ca) and sodium (0.20-0.23% Na) in the swards' dry matter fully covered the animals' feeding requirements.

**Keywords:** *Grassland renovation, yields, botanical composition, content of mineral macronutrients: N, P, K, Mg, Ca, Na, Poland*

### Introduction

Grassland plant communities formed by sowing are unstable and become degraded relatively quickly. The causes of this phenomenon are unfavorable weather conditions, deteriorating soil conditions, and to a large extent improper management (Rutkowska *et al.*, 1999; Kryszak *et al.*, 2005; Warda and Kozłowski, 2012). In Poland as a result of twice-lower stocking density and reduced demand for animal forage (compared to the 1980-1990) the perennial grassland in many farms shows a low agricultural value. Their production capacity is often not even half-used (Jankowska-Huflejt and Domański, 2008; Stypiński *et al.*, 2009). Depending on the degree of sward degradation and habitat conditions, the grasslands are renovated by various methods. Currently, overdrilling is the most recommended method to improve the economic value of both permanent and temporary meadows and pastures (Goliński, 2003; Baryła and Kulik, 2011; Janicka, 2012; Barszczewski *et al.*, 2016). This method is appreciated primarily by farmers of large farms, in which simplified cultivation technologies are widely used on arable land (Hermenean *et al.*, 2006; Mocanu *et al.*, 2008). Strong interests in improving the methods of grassland restoration are shown

by both farmers specializing in milk and in beef production. Regarding modern methods of oversowing with improved cultivars, mainly leguminous plants are of great importance for organic farms (Wolski, 2002; Komárek *et al.*, 2007). The aim of the study was to evaluate the effects of overdrilling of dry meadows depending on the treatment of the sward existing previously.

### Material and Methods

The study was carried out at the Jaktorów Experimental Station (central Poland), in the valley of the river Pisia Tuczna (37 km west of Warsaw). The experiment was established in moderately wet meadow habitat (water table between 50 and 80 cm), located at a distance of approximately 180-200 m from the river bed (geographical coordinates: 52°05' N; 20°32' E). It was carried out on degraded permanent grassland, situated on mineral soil (black earth) poor in potassium and with a high phosphorus and magnesium concentration, which had been extensively managed and fertilized. The reason for its renovation was low yielding, resulting from a very low proportion of valuable tall grass species (less than 10%), a lack of legumes and a high proportion of dicotyledonous herbs and weeds (more than 30%) in the sward (*Taraxacum officinale*, *Plantago lanceolata* and *Ranunculus repens* had the highest proportions). In addition, this area was characterized by the presence of a large number of empty places.

The experiment was designed as a randomized complete block with four replications. Each plot was 15 m<sup>2</sup> (2 m x 7.5 m). The mixture consisted of high grasses: *Festuca pratensis* cv. Pasja (20%), *Phleum pratense* cv. Kaba (25%), *Dactylis glomerata* cv. Astera (10%) and *Trifolium pratense* cv. Parada (15%) – 24.2 kg ha<sup>-1</sup> was sown. Overdrilling was performed by a Vredo slot seeder (Type 120.10), the distance between rows was 10 cm and a sowing depth of 1-2 cm. Competitiveness of the original sward before overdrilling was reduced by: 1) low cutting without herbicides (cutting height about 3 cm) – PM, 2) selective herbicides: Starane 250 EC (11 ha<sup>-1</sup>; active substance: fluroxypyr) + Aminopielik D 450 SL (31 ha<sup>-1</sup>; active substance: 2,4 D + dikamba) – H+PM, 3) non-selective herbicide, and total sward destruction: Roundup 360 SL (51 ha<sup>-1</sup>; active substance: glyphosate) – R+PM, 4) rototilling, one time, depth about 8-10 cm (without herbicides) – G+PM. The effectiveness of those treatments was compared with the control – old sward (SD), which was not subjected to any treatment and was not fertilized. In the sowing year two cultivation and two production cuts were made and in the subsequent years – three cuts per year. The following doses in kg·ha<sup>-1</sup> of mineral fertilizer were applied: 180 N (in three equal doses for each cutting), 30 P (in spring) and 100 K (in two equal doses – in spring and after the first cut). Dry matter yields and botanical composition of each cut were measured. The species used in mixtures, other species of grasses, legumes and dicotyledonous herbs and weeds were separated. The sward samples taken from each re-growth were used to determine the content of mineral macronutrients: N, P, K, Mg, Ca and Na. These analyzes were done at the National Agrochemical Station in Warsaw according to Polish Norms or the accepted research procedures. The data was analyzed statistically by variance analysis (ANOVA). Verification of the significant differences was based on Tukey's test ( $p \geq 0.05$ ).

## Results and Discussion

The weather conditions during the vegetation periods were not favorable for growth and development of sown grass species and *Trifolium pratense*. This is supported by very low values of hydrothermal index of Vinczeff (1984) calculated as the quotient of total precipitation to the sum of temperature. The values of this ratio ranged from 0.098 (second year) to 0.119 (first year) and were classified as extremely dry and very dry, respectively, while the optimal conditions for the growth and development of meadow vegetation occur when the index is 0.2 - 0.25 mm·°C<sup>-1</sup>.

In the first year, the sown grass species developed quite poorly and constituted a low share in the yield (Tab.1), which was a result of weather conditions (lack of rainfall) and high competition of the primary meadow sward species, especially *Lolium perenne*. Similar results have been obtained in earlier studies (Janicka, 2004). In the following years, the development of the sown grass species significantly increased their share in yield to 51.6% (on average) in the last year of the studies (Tab.1). Irrespective of the year, they have the highest share in yields which were obtained in the treatments of overdrilling preceded by Roundup spraying or rototilling (45 and 51.5% respectively); the significantly lower ones were obtained in the others treatments (H+PM and PM).

Tab. 1. The average share (%) of the plant groups in the yields.

Specification	Overdrilling		Original sward	
	Grasses	<i>Trifolium pratense</i>	Grasses	Dicotyledonous herbs and weeds
<b>Treatment</b>				
PM	21.0 a*	6.7 ab	56.5 b	15.7 b
H + PM	26.2 a	4.8 a	63.1 b	5.9 a
R + PM	45.0 b	10.0 b	27.5 a	17.4 b
G + PM	51.5 b	6.7 ab	26.0 a	15.7 b
LSD <sub>0.05</sub>	10.2	3.8	9.6	4.1
SD	10.5	3.2	54.1	32.2
<b>Year</b>				
first	13.8 X	13.3 Z	53.6 Z	19.2 Z
second	42.2 Y	7.3 Y	41.8 Y	8.7 X
third	51.6 Z	0.7 X	34.5 X	13.2 Y
LSD <sub>0.05</sub>	8.5	3.1	7.1	3.4

\* Figures indicated by the same letters are not significantly different

*Dactylis glomerata* L. was the most useful species to overdrilling of dry meadows, irrespective of technology (average 41-50% of sown species). It was characterized by increasing competitive ability and resistance to changing weather conditions. The usefulness of this species for overdrilling in Poland has been confirmed in numerous experiments (inter alia Grabowski *et al.*, 1996; Baryła and Kulik, 2008; Janicka, 2012). *Festuca pratensis* Huds. was not good enough, despite the rapid rate of development during the early period after sowing (in the first year 23% of sown species). In the following years it showed a high sensitivity to water deficiency and a declining ability to compete. *Phleum pratense* L. was the least useful species for overdrilling of dry meadows (Janicka, 2012). It was characterized by low competitiveness and sensitivity to drought (in the third year 9.5% of sown species). *Trifolium pratense* L. was well developed in the sowing year (47% of sown species) and limited the development of the old sward. This points to the usefulness of this species for overdrilling, regardless of technology.

The yielding was dependent on presence of the sown species in the sward. The highest yields on average for the studied period were obtained in the treatments where the primary sward was destroyed by non-selective herbicide (R+PM) or by rototilling (G+PM) and where the share of the sown species was highest (Tab.2). Lower productivity was obtained by the treatment with overdrilling carried out directly into sward (PM), and significantly lowest yield was taken from the

treatments with the use of selective herbicides (H+PM). This confirms the opinion that sufficient damage to the original sward is one of the most important conditions for the success of overdrilling (Tiley and Frame, 1991; Grabowski, 1992; Janicka, 2007). The yields of the meadow sward from the particular treatments were in average from 86% (H+PM) to 125% (R+PM) higher than the yields of the control sward (SD). The sown grasses influenced mostly the sward productivity. The results of yielding indicate that in moderately wet habitats positive effects of overdrilling may be obtained by mechanical limiting of the original sward competitiveness (G+PM), while in the moderately dry habitats the risk of significant drying out of the topsoil is relatively high (Baryła, 1996; Janicka, 2012).

Tab. 2. The meadow sward yields (in Mg of dry matter per ha) in the following years of utilization.

Treatment	Year of utilization			Average
	first*	second	third	
PM	3.47 ab**	7.62 ab	7.38 ab	6.15 ab
H + PM	3.58 b	7.14 a	6.85 a	5.86 a
R + PM	3.79 b	9.15 b	8.34 b	7.09 c
G + PM	3.07 a	8.98 b	7.81 ab	6.62 bc
LSD <sub>0.05</sub>	0.45	1.83	1.41	0.73
SD	2.62	3.38	3.44	3.15
<b>Year</b>				
in average	3.48 X	8.22 Z	7.59 Y	
LSD <sub>0.05</sub>		0.58		

\* Total yields of II and III cuts;

\*\* Figures indicated by the same letters are not significantly different

The total nitrogen content in the plant dry matter from the peculiar treatment amounted (on average) from 1.78% (G+PM) to 1.88% (H+PM). Lower content of nitrogen was found in the dry matter from the treatment G+PM and R+PM (Tab.3), what was probably linked to higher share of *Phleum pratense* in the sward from that treatment (the later species). The results of the other authors showed that the late species and varieties are characterized by lower protein content compared to the earlier ones (Dębska-Kalinowska, 1994, Kochanowska-Bukowska, 2001). Moreover, it is worth pointing out that the Astera cultivar of *Dactylis glomerata*, according to Łyszczarz and Dembek (2003), belongs to the later cultivars of that species and, according to the results of Kochanowska-Bukowska (2001) is characterized by a lower protein concentration in comparison to the earlier cultivars of that species. The significantly lower concentration of that component was found in the dry matter of the first re-growths in comparison to the others (the large share of the generative shoots) and in the second year (extremely dry). The high air temperature and lack of rainfall in that year limited use of nitrogen and gathering of that element in plants, which was found by many authors (i.a. Dębska-Kalinowska, 1994; Falkowski *et al.*, 2000; Borawska-Jarmułowicz, 2003; Łyszczarz and Dembek, 2003).

The average phosphorus concentration in the dry matter was a little higher than the value considered as optimum in animal feeding (0,3%, Brzóska, 2008), what was the result of high phosphorus content in the soil. The significantly higher amount of phosphorus was stated for the sward with PM treatment, in comparison to R+PM and G+PM (Tab.3). The significant differentiation in that element content was found depending on regrowth and the year of the study. The higher phosphorus concentration was stated in the summer re-growths (II, and the highest in III), probably due to the higher share of dicotyledonous in the yield in comparison with the first regrowth. Moreover, significantly higher content of phosphorus was stated in the sward from the first year – the year of the highest share of *Trifolium pratense*, being characterized by the high concentration of that element, in the yields.

Tab. 3. The contents of macronutrients in dry matter of meadow sward (%)

Treatment	N	P	K	Mg	Ca	Na
PM	1.87 b*	0.40 c	1.68 c	0.25 b	0.97 b	0.21 ab
H + PM	1.88 b	0.39 bc	1.59 b	0.23 a	0.85 a	0.20 a
R + PM	1.80 ab	0.37 ab	1.49 a	0.26 b	0.94 b	0.22 ab
G + PM	1.78 a	0.36 a	1.44 a	0.26 b	0.93 ab	0.23 b
LSD <sub>0.05</sub>	0.078	0.014	0.089	0.012	0.081	0.024
SD	1.63	0.40	1.32	0.26	1.22	0.23
<b>Regrowth</b>						
I	1.58 p	0.32 p	1.59 s	0.19 p	0.73 p	0.14 p
II	1.92 s	0.40 s	1.45 p	0.28 s	1.07 s	0.22 s
III	1.88 s	0.43 t	1.48 p	0.28 s	1.15 t	0.29 t
LSD <sub>0.05</sub>	0.052	0.009	0.059	0.008	0.054	0.016
<b>Year</b>						
first	1.82 Y	0.42 Z	1.42 X	0.29 Y	1.13 Z	0.27 Z
second	1.77 X	0.35 X	1.55 Y	0.23 X	1.02 Y	0.18 X
third	1.79 XY	0.37 Y	1.55 Y	0.23 X	0.80 X	0.21 Y
LSD <sub>0.05</sub>	0.052	0.009	0.059	0.008	0.054	0.016

\* Figures indicated by the same letters are not significantly different

The average amount of potassium differentiated from 1.44% K in DM to 1.68%, so it was absolutely sufficient to the animals' requirements for that component (Brzóska, 2008). The excessive concentration of potassium (more than 2%) was not stated during the whole study period. The significantly lower content of potassium was typical for the swards from G+PM and R+PM treatments, what probably was the effect of higher dicotyledonous share in the yields. The significantly higher content of that element was found in the sward of the first regrowth. The lower potassium concentration – in the comparison to following years – was stated in the first year, as well as a higher share of dicotyledonous, especially *Trifolium pratense*.

The magnesium content in the sward dry matter differentiated in average from 0.23% to 0.26%. The differentiation of the magnesium content was relatively low, the highest concentration of that element was stated in the sward from the G+PM and R+PM treatments, and significantly lowest – in the sward from H+PM treatment (Tab. 3). It was determined by the differences in the dicotyledonous, which showed a higher magnesium concentration than grasses (Grzegorzczak *et al.*, 2013), as well as higher shares in the yields. The magnesium content in the dry matter was differentiated depending on the regrowth and the year of the study. In the sward of the later regrowths (II and III) the significantly higher concentration of the component was found, compared with the first regrowth. That fact was the result of the positive effect of higher temperature for magnesium input, as well as the higher share of dicotyledonous (herbs and weeds) in the yields (Kulik, 2009). The significantly higher share of that element was typical for the vegetation of the first year, with the highest proportion of dicotyledonous, especially *Trifolium pratense*.

The differentiation in the calcium content depending on the treatment was relatively low, the highest concentration of that element was found for the sward from PM and R+PM treatments, but the lowest – from the H+PM treatment (Tab. 3). That differentiation resulted from the differences in the share of dicotyledonous (*Trifolium pratense*, herbs and weeds) in the yields. Moreover the significantly higher content of that element was stated for the summer regrowths (II and III), with higher share of the dicotyledonous herbs and weeds, and in the first years of the study with the highest share of *Trifolium pratense*. Sometimes the calcium content exceeded 1% in dry matter, especially in the first year after overdrilling. This is a non-advantageous phenomenon, as a too high level of that component in the forage may limit the microelements' absorption, mainly the iodine and zinc (Falkowski *et al.*, 2000). It is worth stressing that often, extensive concentration of that element is found in the dry matter from the control treatment (SD).

The sodium concentration in the swards' dry matter was at the optimum level from 0.20% (H+PM) to 0.23% (G+PM) and covered the animals' feeding requirements for that element (Brzóška, 2008). That fact might be due to the effect of significant *Lolium perenne* (the species of primary sward, showing a large sodium concentration) share in the yields. The differentiation in that element content among the treatments was low; the highest sodium concentration was found for the G+PM treatment, and significantly lower – for the H+PM treatment (Tab. 3). This was the effect of the varied share of *Dactylis glomerata* in the yields (higher for G+PM treatment than for H+PM one). The highest sodium concentration was stated for the sward of the third regrowths, and significantly lower – for the first regrowths, which might be the result of the negative influence of potassium, lowering the sodium level (Falkowski *et al.*, 2000). The peculiarly high content of that element was stated for the III regrowth in the last year (0.32%), what was due to advantageous weather conditions in that period (rainfalls and optimal temperature), which determined the sodium intake by plants (Falkowski *et al.*, 2000). The significantly highest content of sodium was characteristic for the sward in the first year of the study, due to high *Trifolium pratense* (of higher concentration of that element in the comparison with grasses) share in the yields.

The reciprocal relations of macronutrients contents are of great importance from the animals' feeding point of view (Brzóška, 2008). Therefore, evaluating the nutritional value of sward after renovation should be taken into account. The relation of the potassium/sodium content was only in technology with the use of selective herbicides (H+PM) slightly exceeded the acceptable value equal to 10 (Brzóška, 2008). The proportion of calcium/magnesium content was lowly differentiated (3.6-3.9). Also the relation of calcium and phosphorus was advantageous. The values of that proportion were very lowly differentiated (2.2-2.5) and similar to the optimal one (Brzóška, 2008).

### Conclusions

The applied renovation technologies resulted in an increase in yield from 86% to 125% when compared to the yield of the original sward. The highest yield and the highest share of the species introduced by overdrilling were obtained in the case of overdrilling preceded by Roundup spraying (in average 7.09 Mg·ha<sup>-1</sup> and 55% respectively) and rototilling (in average 6.62 Mg·ha<sup>-1</sup> and 58.2% respectively). *Dactylis glomerata* L. was the most useful species to overdrilling of dry meadows, irrespective of technology (average 41-50% of sown species).

Taking into account the animals' requirements for mineral nutrients, the best forage nutritional value was characterized by the treatments with overdrilling after either rototilling or Roundup spraying. The contents of phosphorus (0.36-0.40% P), magnesium (0.23-0.26% Mg), calcium (0.85-0.97% Ca) and sodium (0.20-0.23% Na) in the swards' dry matter fully covered the animals' feeding requirements. Due to the higher dicotyledonous' share in the yields, the higher concentrations of those elements occurred in the summer regrowths.

### Acknowledgements

The study was supported by the Ministry of Science and Higher Education: project No. 3 P06R 108 24

### References

- Barszczewski J., Terlikowski J., Wróbel B. (2016). Efekty podsiewu łąk grądowych w różnicowanych warunkach siedliskowych [The effect of overdrilling of dry meadows in different habitat conditions]. Woda-Środowisko-Obszary Wiejskie. 16, 3 (55), 5–22 [In Polish with English summary].
- Baryła R. (1996). Renowacja trwałych łąk i pastwisk w siedliskach grądowych ze szczególnym uwzględnieniem podsiewu [Renovation of permanent meadows and pastures in dry ground habitats with particular emphasis on seeding]. Zeszyty Problemowe Postępów Nauk Rolniczych. 442, 23-30 [In Polish with English summary].

- Baryła R., Kulik M. (2008). Ocena przydatności różnych mieszanek do podsiewu zdegradowanej runi łąkowej [Effect of different mixtures utility to overdrilling of degraded meadow sward]. *Łąkarstwo w Polsce/Grassland Science in Poland*, 11, 17-24 [In Polish with English summary].
- Baryła R., Kulik M. (2011). Podsiew zdegradowanych zbiorowisk trawiastych metodą ich regeneracji przyjazną [The overdrilling of degraded grass communities as an environmentally friendly method of their regeneration]. *Zeszyty Naukowe WSA w Łomży. 47*, 7-17 [In Polish with English summary].
- Borawska-Jarmułowicz B. (2003). Wartość pokarmowa mieszanek traw w użytkowaniu kośnym – pierwszy pokos i pastwiskowym – drugi pokos [Nutritive value of grass mixtures in a combined utilization for meadow (first cut) and pasture (second harvest)]. *Biul. IHAR*, 225, 183-191 [In Polish with English summary].
- Brzóska F. (2008). Pasze objętościowe z użytków zielonych i ich wykorzystanie w żywieniu zwierząt [Bulk fodders from grassland and their use in animal nutrition]. *Więś Jutra* 3, 28–33 [In Polish].
- Dębska-Kalinowska Z. (1994). Wartość pokarmowa wybranych odmian 12 gatunków traw pastewnych w zależności od fazy fenologicznej, struktury masy nadziemnej i warunków siedliskowych. [The nutritional value of some varieties of 12 forage grass species depending on phenological stage, aboveground mass structure and site conditions]. University Publisher Warsaw University of Life Sciences-SGGW, *Treatises and Monographs*, 187, pp. 60 [In Polish with English summary].
- Falkowski M., Kukułka I., Kozłowski S. (2000). Właściwości chemiczne roślin łąkowych [Chemical properties of meadow plants]. University Publisher Poznan University of Life Sciences Wyd. UP Poznań, pp. 132 [In Polish].
- Goliński P. (2003). Effectiveness of pasture overdrilling with *Lolium perenne* using different methods of sod preparation. *Grassland Science in Europe*, 8, 134-137.
- Grabowski K. (1992). Renowacja łąk trwałych różnymi sposobami [The renovation of permanent meadows by different methods]. *Acta Acad. Agricult. Tech. Olst., Agricultura*, 53, Suppl. B, pp. 50 [In Polish with English summary].
- Grabowski K., Grzegorzczak S., Benedycki S., Marks E. (1996). Przydatność niektórych gatunków traw do podsiewu łąki trwałej [Usefulness of some grass species to reseeding permanent meadows]. *Zesz. Probl. Post. Nauk Rol.*, 442, 89-96 [In Polish with English summary].
- Grzegorzczak S., Alberski J., Olszewska M. (2013). Accumulation of potassium, calcium and magnesium by selected species of grassland legumes and herbs. *Journal of Elementology*, 18(1), 69–78.
- Hermenean I., Mocanu V., Marușca T. (2006). The improvement of the degraded grasslands with the new machine for oversowing MSPD 2.5. *Grassland Science in Europe* 11, 793-795.
- Janicka M. (2004). Seedling growth, development and their survival ability after meadow renovation by overdrilling. *Grassland Science in Europe*, 9, 547-549.
- Janicka M. (2007). Renovation of meadow swards dominated by short grasses by overdrilling. *Grassland Science in Europe*, 12, 98-101.
- Janicka M. (2012). Uwarunkowania wzrostu i rozwoju ważnych gospodarczo gatunków traw pastewnych i *Trifolium pratense* L. po renowacji łąk gładowych metodą podsiewu [Determination of growth and development of economically important species of forage grasses and *Trifolium pratense* L. after renovation of the drymeadows by overdrilling]. University Publisher Warsaw University of Life Sciences-SGGW, *Treatises and Monographs*, 394, pp. 204 [In Polish with English summary].
- Jankowska-Huflejt H., Domański P. (2008). Aktualne i możliwe kierunki wykorzystania trwałych użytków zielonych w Polsce [Present and possible directions of utilizing permanent



- grasslands in Poland]. *Woda-Środowisko-Obszary Wiejskie*, 8, 2b (24), 31-49 [In Polish with English summary].
- Kochanowska-Bukowska Z. 2001. Reaction of selected orchard grass (*Dactylis glomerata* L.) cultivars to soil moisture. *Electronic Journal of Polish Agricultural Universities (EJPAU)*, 4(2), #03.
- Komárek P., Nerušil P., Kohoutek A., Odstrčilová V. (2007). The effect of repeated direct sowing of grass-legume seed mixtures into grasslands on forage production and quality. *Grassland Science in Europe*, 12, 39-42.
- Kryszak A., Kryszak J., Czemko M. (2005). Degradacja zbiorowisk łąkowych w dolinie rzeki Samicy [Degradation of meadow communities in the Samica river valley]. *Zesz. Probl. Post. Nauk Rol.*, 507, 307-313 [In Polish with English summary].
- Kulik M. (2009). Effect of different factors on chemical composition of grass-legumes sward. *Journal of Elementology*, 14 (1), 91–100.
- Łyszczarz R., Dembek R. (2003). Wieloletnie badania nad oceną wczesności, plonowania i wartości pokarmowej polskich odmian kupkówki pospolitej [Long-term studies on earliness, yields and nutritional value of polish common orchard grass varieties]. *Biul. IHAR*, 225, 29-42 [In Polish with English summary].
- Mocanu V., Hermenean I., Marușca T. (2008). Ecological and economical technology for mechanization of grassland improvement works. *Grassland Science in Europe*, 13, 144-146.
- Rutkowska B., Janicka M., Szymczak R., Ślusarek A., (1999). Wpływ warunków siedliskowych i zaniedbania pratotechniki na zmiany florystyczne runi łąkowej [The influence of habitat conditions and neglecting in the management on changes in the floristic composition of meadow sward]. *Folia Universitatis Agriculturae Stetinensis* 197, *Agricultura*, 75: 271-278 [In Polish with English summary].
- Stypiński P., Hejduk S., Svobodová M., Hakl J., Rataj D. (2009). Development, current state and changes in grassland in the past year. *Grassland Science in Europe*, 14, 1-10.
- Tiley G.E.D., Frame J. (1991) Improvement of upland permanent pastures and lowland swards by surface sowing methods. In: Buchgraber K. et al. (eds) *Grassland renovation and weed control in Europe. A Conference of European Grassland Federation held at Graz, Austria*, 89-94.
- Vinczeffy I. (1984). The effects of some ecological factors on grass yield. In: *Proceedings of the 10th General Meeting of European Grassland Federation held at Ås, Norway*, 76-79.
- Warda M., Kozłowski S. (2012). Grassland – a Polish resource. *Grassland Science in Europe* 17, 3-16.
- Wolski K. (2002). Wpływ uproszczonych metod renowacji runi łąkowej na jej produktywność [The influence of simplified methods of meadow sward renovation on its productivity]. *Zesz. Nauk. AR we Wrocławiu*, 441, *Rozpr., CXCI*, (191), 1-65 [In Polish with English summary].

## CONTRIBUTIONS FOR ENRICHMENT OF BELL PEPPER ASSORTMENT IN ROMANIA

Elena BARCANU-TUDOR<sup>1\*</sup>, Costel VÎNĂTORU<sup>1</sup>, Bianca ZAMFIR<sup>1</sup>, Camelia BRATU<sup>1</sup>, Elena Maria DRĂGHICI<sup>2</sup>

<sup>1</sup>Vegetable Research-Development Station Buzău, Romania

<sup>2</sup>University of Agronomic Sciences and Veterinary Medicine Bucuresti, Romania

\*Corresponding author: barcanuelena@yahoo.com

### Abstract

Bell pepper is grown in Romania as an annual plant, cultivated both for fresh consumption and processed products. To aid Romania in enriching its assortment of bell peppers, new cultivars are being developed for local climatic conditions and for supporting the industry demands. Any breeding process can only be initiated if there is available a valuable biological material, which means that there is a sufficiently large variability of the characters and attributes that characterize the material in order to choose the genotypes in accordance with the objectives pursued. That is why research begun with the evaluation of the biological material held in the germplasm collection. Based on that evaluation, it was found that from the total of 214 *Capsicum spp.* genotypes, a number of 42 genotypes demonstrated genetic stability in the descendant, a number of 54 genotypes were included in genetically advanced accessions group and a number of 118 genotypes had been proved to be segregant. During the breeding work a number of 42 genetically stable genotypes were used as initial material for achieving new cultivars. The research undertaken within the breeding program was completed with two new crops that had been tested for 3 years in open field and cold greenhouses. The control variant used in this experiment was a well known Romanian bell pepper variety, Galben Superior. Two new varieties, Ideal (A3) and Carmin (A70) which have shown valuable characteristics and are in conformity with the international standards imposed by the DUS test are currently in the process of being patented.

**Keywords:** *Capsicum annuum* L., Carmin, Ideal, Breeding, Variety.

### Introduction

Bell pepper is cultivated worldwide for vegetable, spice and processed products (Crosby, 2008) and is grown in a wide range of climate as an annual and/or perennial crop (Bosland and Votava, 2012). Bell pepper is a good source of vitamin C and E, provitamin A, ascorbic acid and carotenoids, like 5.8 µgm/gm of fresh green wt. (Materska and Perucka, 2005). The nutritional and health value of ascorbic acid (AsA) is of great importance in the human diet, in order to "fight" diseases such as scurvy, to maintain collagen, to reduce stress damage, and as an antioxidant. Ascorbic acid is important in the biosynthesis of amino acids, formation of adrenaline, and detoxication in the liver (Smirno,1996). Total ascorbic acid was higher in bell pepper than in tomato fruit. In pepper fruit, the level of ascorbic acid increased rapidly during its development, reaching a maximum of 136.1 mg/100 g at 51 days from fruit set and then decreased suddenly, reaching a minimum of 65.5 mg/100 g at 64 days. (Yahia et al., 2001). In Plant Variety Catalogue there are numerous cultivars achieved by breeders in different parts of the world. Because there is a lack of competitive peppers varieties in Romania, farmers tend to buy the seeds from foreign companies. But, the attempt to introduce foreign origin varieties into Romanian crop proved to be a solution for the moment, since parameters of production from the country of origin are not always attained, due to ecological plasticity. Vegetable Research and Development Station was found in 1957 and has always been producing and selecting vegetable seeds, also obtaining new cultivars and hybrids. Since 1996 has begun the increasing of germplasm collection of peppers and not only. During the evaluation of

germplasm collection, a number of eight valuable genotypes of chilli peppers, having a different measurement of pungency (SHUs) and a dwarf port, suitable for pots and jardinière were selected (Barcanu Elena et.al., 2017). In order to meet the requirements of a biological material with high breeding value, one of the main features of germplasm collection is variability (Leonte C., 2011). Huge variability of characters from germplasm collection and also the *Capsicum spp.* genus variability has allowed the extraction of new genotypes of bell peppers. And the germplasm collection still has plenty of valuables genotypes. In order to increase horticultural crop and improve its quality, it is recommended to introduce new cultivars and replace the existing one, with better aspects as quantity and qualitative yield, resistance to the environmental factors and tolerance to pathogens. That is why our aim is to achieve new assortment varieties created under the specific climatic conditions of our crop area and also for supporting the demands of the industry.

### Material and Methods

Any breeding process can only be initiated if there is available a valuable biological material, which means that there is a sufficiently large variability of the characters and attributes that characterize the material in order to make possible choosing genotypes in accordance with the objectives pursued. That is why research begun with the evaluation of the biological material held in the germplasm collection. Based on this evaluation, it was found that from the total of 214 *Capsicum spp.* genotypes, a number of 42 genotypes demonstrated genetic stability in the descendant, a number of 54 genotypes were included in genetically advanced accessions group and a number of 118 genotypes had been proved to be segregant. During the breeding process, a number of 42 genetically stable genotypes were used as initial material for achieving new cultivars. The breeding methods used have been: repeated individual selection in local populations, bulk method, hybridization and segregation. The control variant used in this experiment was a well known Romanian bell pepper variety, Galben Superior. This control variant was chosen because there is a need for improving quantity and quality of yield. Over the growing season, phenological and biometric observations have been made on plant and fruits, and also an analysis of variance (ANOVA) for the determination of the agronomic value for the perspective genotypes in comparative cultures. Valuable genotypes have been studied for 3 years, during 2014-2016, under two conditions: in open field and greenhouse. Peppers were grown under the same technological conditions used for bell pepper production.

### Results and Discussion

The researches undertaken within the breeding program, having the main objective the achievement of new bell pepper varieties suitable for current climatic conditions and also for growers demands, processors and consumers, had been completed with two new cultivars that were tested for 3 years in open field and greenhouses. In order to highlight the results, in both crop systems has been used Galben Superior as control variant. Main plant characteristics can be found in table 1.

Table 1. Main plant characteristics

Varieties	UM	A3 (Ideal)	A70 (Carmin)	Galben Superior (CV)
Plant height	cm	85	105	95
Number of main shoots	no	3	4	3
Plant diameter	cm	73	67	74
Fruit length	cm	12,3	10,5	9,6
Fruit diameter Base-middle-top	cm	5,3 – 4,8 – 1,2	7,9 – 6,2 – 4,4	7,2-6,1-4,2
Fruit weight	(g)	130,5	105,6	102,3
Total number of fruits/plant	no	20	11	9

Accession 3 has shown three important features: earliness, productivity and a very good flavour, which is the reason for patenting under the name of „Ideal“. Early variety, with slightly conical, pendulum fruits, can be eaten both in green as in red. The average fruit weight is of 130.5 g with a 0.6 mm thick pericarp.

Accession 70 is a medium earliness variety, characterized by a medium-sized bushy plant, with erect fruit having 3-4 fleshy lobes. The fruit color turns from yellow-green to red carmine at physiological maturity. Fruits can also be eaten at the green stage. Fruit length is of 10 cm and 4.4 cm in diameter, and the thickness of the pericarp is of 0.7 mm. Due to the positive results achieved at this accession in 2016, it has been patented under the name of „Carmin“.

According to Table 2 and Table 3, the average yield potential for the studied genotypes showed a significantly growth compared to the control variant, both in the open field and in greenhouse.

Table 2. Average yield potential of bell pepper varieties in field, years 2014-2016

Varieties	Yield		Differences t/ha	Level of significance	
	Absolute t/ha	Relative %		Compared to S <sup>2</sup> E error	Compared to S <sup>2</sup> VxA interaction
<b>Accession 3 (Ideal)</b>	48,57	153,8	17	xxx	Xxx
<b>Accession 70 (Carmin)</b>	41,8	132,4	10,23	xxx	Xx
<b>Galben Superior (control variant)</b>	31,51	100	-		

For S<sup>2</sup>E

LSD 5% = 2,76

LSD 1% = 3,69

LSD 0,1% = 4,82

For S<sup>2</sup>VxA

LSD 5% = 4,79

LSD 1% = 6,49

LSD 0,1% = 8,47

Table 3. Average yield potential of bell pepper varieties in greenhouse, years 2014-2016

Varieties	Yield		Differences t/ha	Level of significance	
	Absolute t/ha	Relative %		Compared to S <sup>2</sup> E error	Compared to S <sup>2</sup> VxA interaction
<b>Asscession 3 (Ideal)</b>	58,8	154,7	+20,8	xxx	Xxx
<b>Asscession 70 (Carmin)</b>	52,0	136,8	+14	xxx	Xx
<b>Galben Superior (control variant )</b>	38,0	100	-	-	-

For S<sup>2</sup>E

LSD 5% = 1,74

LSD 1% = 2,39

LSD 0,1% = 2,58

For S<sup>2</sup>VxA

LSD 5% = 5,47

LSD 1% = 9,06

LSD 0,1% = 16,9

## Conclusions

Diversity is one of the most valuable resource of plant genetic. If is better perceived and evaluated the genetic diversity germplasm can offer more chance of getting new cultivars. Starting from these premises, researches have been completed so far with the improving and evaluation of the biological material held in the germplasm collection consisting of 214 genotypes. Two new varieties, Ideal (A3) and Carmin (A70) which have shown valuable characteristics and are in conformity with the international standards imposed by the DUS (Distinctness, Uniformity and Stability) test are currently in the process of patenting.

The yields obtained during 2014-2016, both in open field and greenhouses were clearly superior to the control variant, Galben Superior.

### References

- Barcanu Elena, Vînătoru C., Zamfir Bianca, Bratu Camelia, Drăghici Elena, (2011). Characterization of new ornamental chilli genotypes created at V.R.D.S. Buzău. Scientific papers, series B, Horticulture, vol. LVI, Bucharest.
- Bosland, P.W., and Votava, E.J. (2012). Peppers: Vegetables and Spice Capsicums (Wallingford, UK: CAB International).
- Crosby, K. (2008). Pepper. In Vegetables II, J. Prohens, and F. Nuez, eds. (New York, NY, USA: Springer), p.221–248.
- Leonte C. N., (2011). Tratat de ameliorarea plantelor. Editura Academiei Române, București.(p.227)
- Materska, M. and I. Perucka. (2005). Antioxidant activity of the main phenolic compounds isolated from hot pepper fruit (*Capsicum annum* L.). *Journal of Agriculture and Food Chemistry* 53: 1750–1756.
- Smirnoff, N. (1996). The function and metabolism of abscisic acid in plants. *Annals of Botany*, 78, 661-669
- Yahia Elhadi M., Contreras-Padilla Margarita, Gustavo Gonzalez-Aguilar (2001). Ascorbic Acid Content in Relation to Ascorbic Acid Oxidase Activity and Polyamine Content in Tomato and Bell Pepper Fruits During Development, Maturation and Senescence. *LWT - Food Science and Technology*. Elsevier. Pages 452-457.

## EFFECT OF A SIMPLE VERTICAL TILLAGE TOOL OVER DRAG RESISTANCE AND SOIL MOBILIZATION

Lucian Viorel FECHETE TUTUNARU<sup>1\*</sup>, Marius GHERES<sup>1</sup>, Ioana RAD<sup>2</sup>, Ferenc GASPAR<sup>1</sup>, Zoltan GYORGY<sup>3</sup>

<sup>1</sup>Department of Automotive Engineering and Transports, Technical University of Cluj-Napoca, Romania

<sup>2</sup>Department of Mechanical Engineering, Technical University of Cluj-Napoca, Cluj-Napoca, Romania

<sup>3</sup>National Research-Development Institute for Machines and Installations designed to Agriculture and Food Industry – INMA, Bucharest, Romania

\*Corresponding author: lucian.fechete@auto.utcluj.ro

### Abstract

The paper aims to provide analysis of interaction between a simple rectangular tillage tool moved with constant speed in a soil model without cohesion (coarse sand). For simulation, the LS-DYNA finite element method (FEM) analysis was used. For the geometric model with length 400 mm, width 300 mm and depth 500 mm, the soil material model 147 was chosen. The element grid has 9305 nodes and a network of 8010 solid rectangular elements. For base surface and lateral surfaces appropriate boundary conditions were imposed. The tillage tool is a rectangular prism with length 322 mm, width 20 mm, in vertical position at a depth of 222 mm. The tool speed was imposed to 1.5 m/s alike experimental test rig tool. The experimental test rig allows the movement of 4 tools on circular trajectory with diameter 1700-2000 mm, at maximum depth 900 mm. The interface contacts between the tool and the soil material was modeled automatically by the application software. Tension wave propagation in the soil, speed and accelerations of soil and tool nodes can be obtained and visualized. Soil displacement in three directions shows good similarity with experimental results. Natural tool vibration and soil acceleration was also investigated to reduce the drag force. The simulation shows a lower drag force than experimental result, thus further investigation is needed on FEM modelling. The reduction of the drag force will decrease the required energy in the tillage process, thus reducing the fuel consumption and the environmental pollution.

**Keywords:** *tillage tool, FEM model, soil resistance, soil disturbance, soil-tool interaction.*

### Introduction

Study of soil-tool interaction starts with understanding of the soil break fundamentals and the factors which influence that. Tool geometry and soil properties must be considered together when study soil-tool interaction. When finite element methods FEM is used to evaluate the process, several disadvantages or lacks of analytic models can be overpass. The FEM method can estimate drag resistance without preliminary simplification of soil rupture model and can calculate fields of displacements, tensions, speeds and accelerations. Several investigations with 3D models related to soil-tool interaction have been made (Kushwaha, 1993 and Liu, 1985). The key to understand this includes soil material constitutive relation and a model of interface between soil and tool. Among the most used constitutive relations are the one established by Duncan and Chang, 1970, Kushwaha and Shen, 1993, cap model of Drucker at all, 1955 etc. Mouazen and Nemeny, 1999, are between the first who have studied the interaction of a real tool with the soil from FEM analysis perspective. Another important element in understanding the soil-tool interaction is tied by the ratio between working depth and working depth of tillage tools. For a given soil material, the ratio value allows to obtain the desired effect in the soil. For that, the present investigation is trying to obtain the correlation between a simple vertical tillage tool model and the corresponding drag and soil

disturbance and to compare with similar test rig experiment in order to understand the soil tool interaction and to be able through simulation to obtain efficient tillage tools.

### Materials and methods

One of the most difficult tasks associated to FEM modelling is represented by appropriate selection of properties of the materials used, in order to represent as accurate as possible their physical behavior. It is desirable that the materials input parameters to be determined through physical tests and more than that, the selection and proper use of input parameters or variables to be based on profound understanding of those.

Taking into consideration the implications of designing a soil constitutive model, in order to obtain appropriate results through FEM analysis, a constitutive model developed and evaluated with the LS-DYNA solver by the Federal Highway Administration, US Department of Transportation, has been chosen to be used, respectively the soil material model 147. This material model has been chosen for, in order of priority, accuracy, robustness, high computational speed and very important its ease of use.

The not null values of the input parameters used to define the material used, a coarse sand, with the LS-DYNA solver, version 970, can be found in the table below. The complete theoretical fundamentals and the evaluation of the constitutive model based on standard soil tests (i.e. triaxial shear test and uniaxial strain tests) can be found in the manual respectively the evaluation of LS-DYNA Soil Material Model 147.

Soil parameters used for FEM model

Table 1

Symbol	Unit	Value	Description
<b>Elastic and Soil Characteristics</b>			
K	N/mm <sup>2</sup>	3.25	Nonporous bulk modulus
G	N/mm <sup>2</sup>	6.22	Shear modulus
$\gamma_{sp} - Sp_{grav}$	-	2.65	Specific gravity
$m_c - M_{cont}$	%	0.034	Moisture content
$\rho - \rho_o$	Kg/mm <sup>3</sup>	0.02082	Density of soil
<b>Plasticity</b>			
$\phi - \phi_{max}$	rad	1.1	Friction angle
c - coh	N/mm <sup>2</sup>	0.0062	Cohesion
ahyp	-	0.0001	Coefficient for modified Drucker-Prager surface
e - eccen	-	0.7	Eccentricity parameter for third invariant effects
<b>Strain Softening</b>			
$\xi_0 - \xi_{int}$	-	0.01	Volumetric strain at initial damage threshold
$G_f - V_{dfm}$	Nmm	0.00006	Void formation energy
$\phi_{res} - \phi_{ires}$	rad	0.001	Minimum internal friction angle used for residual strength
<b>Strength Enhancement Caused by Strain-rate Effects</b>			
n - vn	-	1.1	Viscoplasticity parameter, strain-rate enhanced strength
<b>Element deletion</b>			
Damlev	%	0.99	Level of damage that will cause element deletion
Epsmax	-	0.8	Maximum principal failure strain
<b>Miscellaneous</b>			
Nplot	-	1	Element plotting variable to put into effective plastic strain variable
Rhowat	Kg/mm <sup>3</sup>	0.01	Density of water in model units, used to determine air void strain (saturation)
Itermax	-	10	Maximum number of iterations used in plasticity iterations

The material model 147, based on modified Mohr-Coulomb surface, corresponds to an isotropic material, well graded and not stratified. It also allows elements deletion and it's available for solid elements in LS-DYNA.

The geometric model is a rectangular volume with defined dimensions respectively 400 mm length, 300 mm width and 500 mm depth. The element grid is using 9305 nodes, formed by a network of 8010 solid rectangular elements. The base surface and all the lateral surfaces have imposed appropriate boundary conditions.

The simulated tillage tool is a rectangular prism with a length of 322 mm, a width of 20 mm working in vertical position at a depth of 222 mm. The speed of the tool is imposed to be 1.5 m/s as on the real tool on experimental test rig. The interface contact between the tool and the soil material was modeled automatically by the application software for the two parts, surface to surface type.



The experimental test rig design used to confirm the results from the simulation is presented in fig. 1. It allows to mount up to 4 tools, with multiple adjustments, which can move on circular trajectory with a diameter between 1700 mm and 2000 mm, a maximum depth of 900 mm and was equipped with a data acquisition system based on HBM Spider 8 amplifier.

Fig. 1 Experimental test rig

## Results and discussion

Part of the results from the numerical analysis can be found below, a deeper analysis being possible based on LS-DYNA model simulation. For all the images obtained, the representation scale is the same in order to process the visual information in a more intuitive manner.

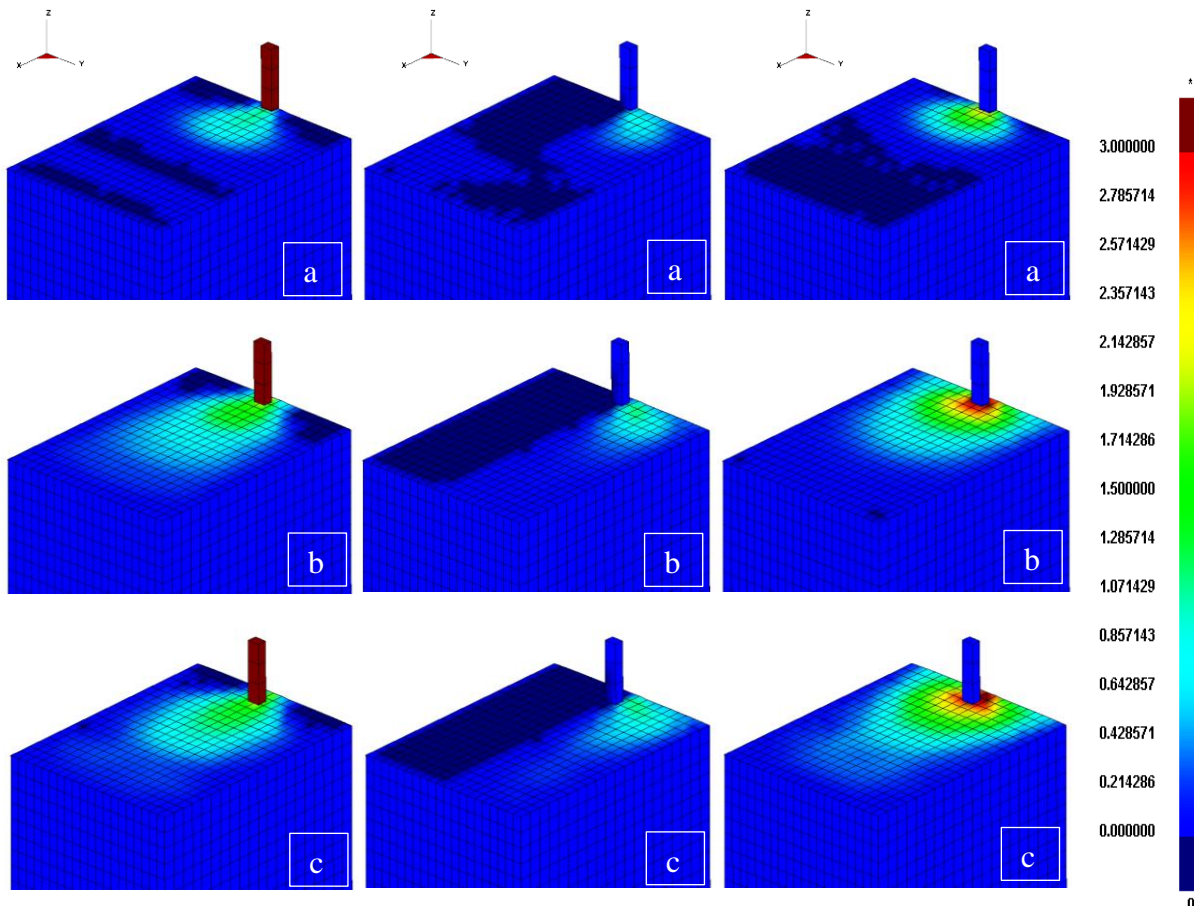


Fig. 2 Elements displacement in top plane along x direction after a) 10 ms, b) 20 ms and c) 30 ms

Fig. 3 Elements displacement in top plane along y direction after a) 10 ms, b) 20 ms and c) 30 ms

Fig. 4 Elements displacement in top plane along z direction after a) 10 ms, b) 20 ms and c) 30 ms

For the representation along Y direction, the images must be perceived as mirrored. Regarding the influence of tillage tool over the soil, respectively the soil disturbance, the results can be graphically visualized in figures 2, 3 and 4. Considering the top soil layer in three different



position in time, at 10ms, 20ms and 30ms, after the start of the tillage tool movement in the soil at the specified speed the results show a high disturbance of the soil in vertical direction, an effect desired as it's loosening the soil. Another effect of tool movement into soil can be seen in fig. 3, the soil disturbance in y direction. Based on this values the optimum distance between the tools in a row can be established.

Analyzing the soil elements displacement in the other two planes, as can be seen in fig. 5 and 6, the critical angle  $\beta_x$ ,  $\beta_z$  and the critical depth  $h_{crit}$  of the soil-tool interaction can be visualized and determined. As stated by other authors (Godwin,1977; Payne, 1956 and Spoor, 1978) the soil disturbance profile is determined by the ratio between working depth and width and also by the tillage tool angle of attack. For the chosen tool the effect is as the one observed in laboratory experiment in which the lateral effect and the loosening of the soil of the narrow vertical tool is significant in the upper part of the soil.

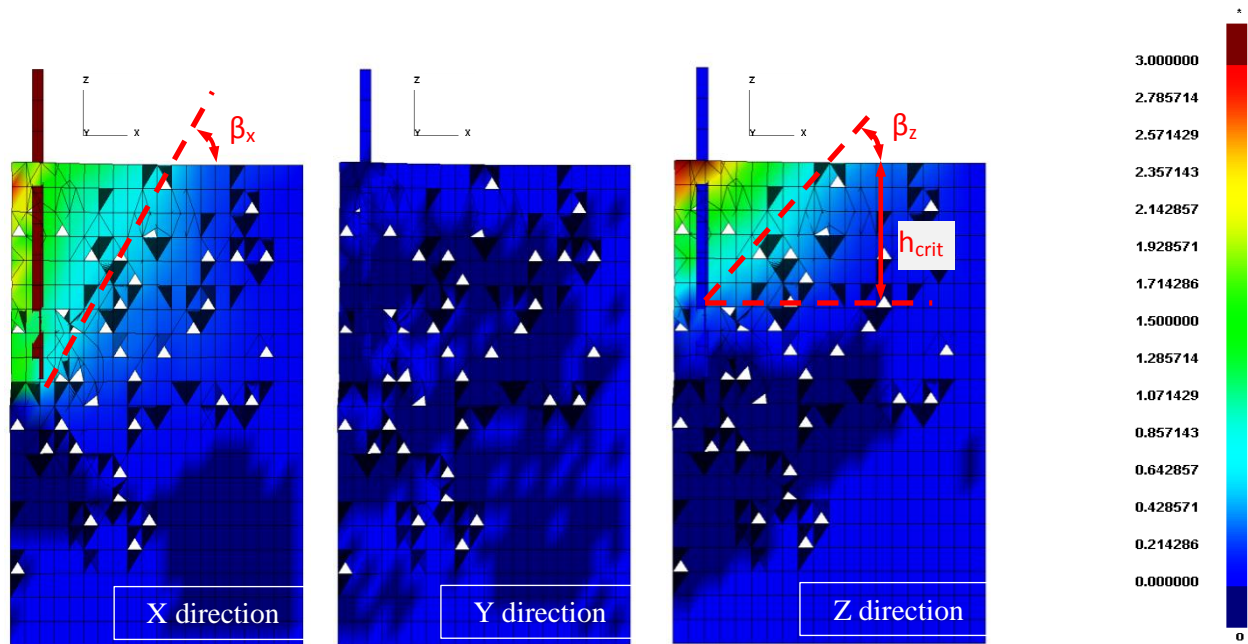


Fig. 5 Elements displacement in symmetry longitudinal plane along X, Y and Z direction after 30 ms.

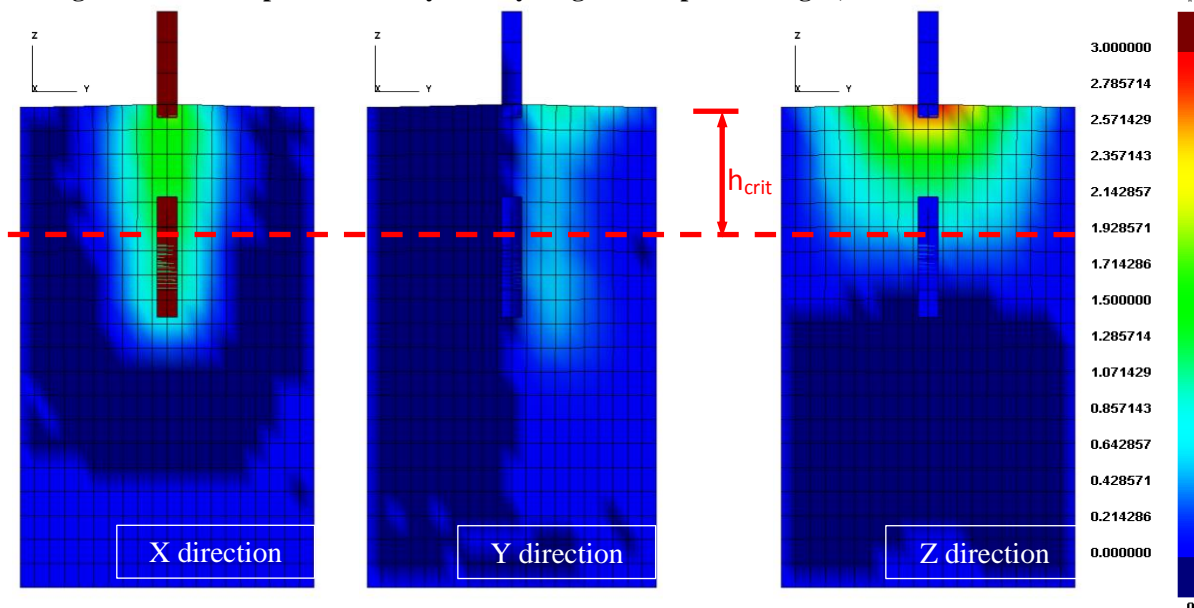


Fig. 6 Elements displacement in tool active surface plane along X, Y and Z direction after 30 ms

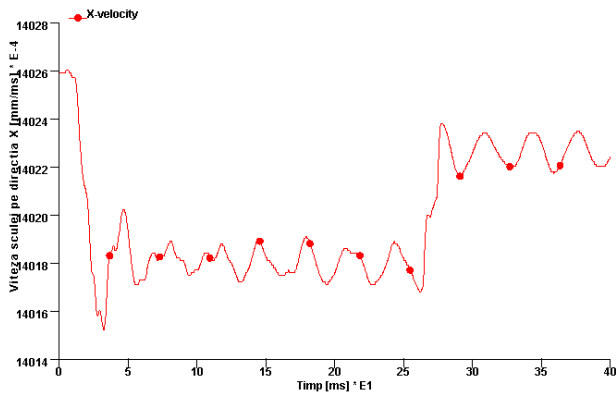


Fig. 7 Tillage tool speed variation in FEM model

In a similar way, the speed and accelerations of the nodes, for either the soil or the tool, can be obtained and visualized for all three directions. For that, fig 7 shows a speed variation of the tool, in which the oscillations are due to the load and the elastic behavior of the tool material as in real conditions. At the soil level, for the top layer, the total acceleration of the soil nodes was represented (fig. 8) and the results show the manifestation of a shock wave due to speed variation of the tool similar to vibration tool. The effect can be use in an advantageous way by lowering drag resistance if fine tuning is made regarding the tool parameters, working speed and real soil characteristics. Related to the results presented above, figure 9 shows the propagation of a tension wave in the soil whose existence was validated by Hendrick and Gill, 1973. Due to reflective properties of the boundary conditions, for a longer simulation, the results obtained are unreliable. In order to eliminate that, a solution can be the selection of a higher soil volume which increase the computation resources and time or inserting impedance at the boundary limits.

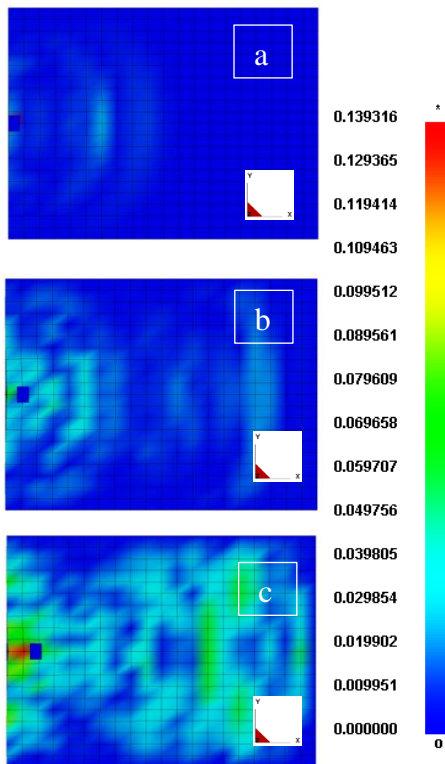


Fig. 8 Total acceleration at soil surface :  
a) 10 ms, b) 20 ms, c) 30 ms

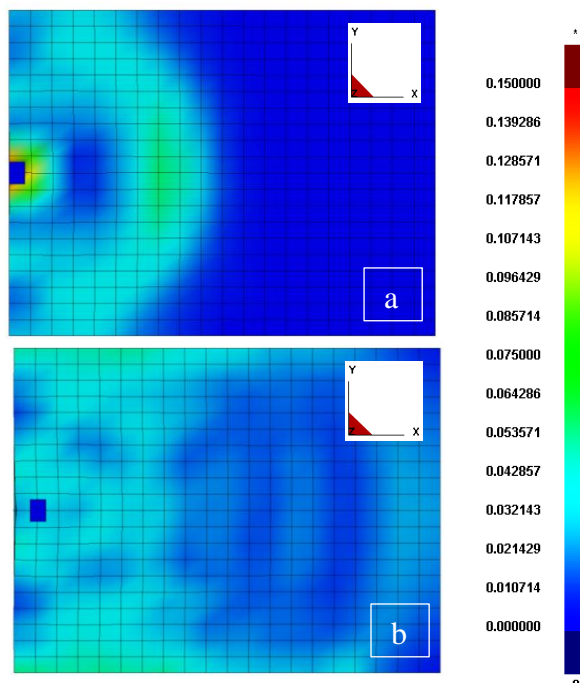


Fig. 9 Tension wave propagation in soil:  
a) 10 ms, b) 20 ms

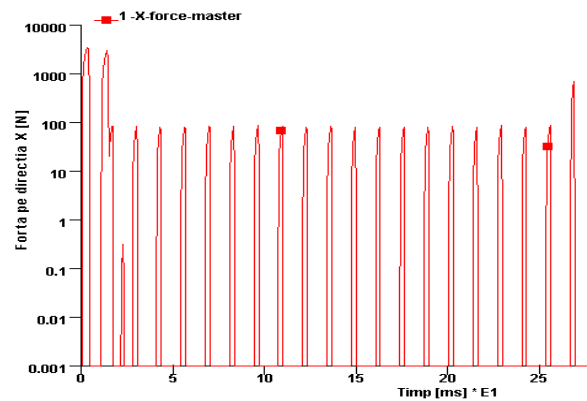


Fig. 10 Simulated drag resistance

Regarding the drag resistance, the force the moving tool needs to overcome the soil resistance, the values obtained are around 100 N according to the simulation with a spike of 1500 N that can be seen in fig. 10. Comparing the results obtained in the numerical simulation with the experimental results from the test rig, it can be stated that a similarity can be observed between the two analyses.

### Conclusion

The influence of a simple rectangular vertical tillage tool moved with constant speed through soil – coarse sand – was simulated using the finite element method in dynamic transient process. The result: soil displacement in the three direction can be used to determine the soil disturbed by the tool with good approximation compared to the results obtained on an experimental test rig. Natural tool vibration and soil acceleration was also investigated in order to reduce the drag force. The reduction of the drag force will decrease the required energy in the tillage process, by thus lowering the fuel consumption and the environmental pollution.

The force obtained numerically was lower than the one obtained in the experiments, for that further investigation are needed from the perspective of FEM modeling.

The purpose of the investigation made in this paper is to enhance the information-needed to obtain a tillage tool which can respond to the needs of the user from an engineering point of view regarding agro-technical and efficiency parameters.

### Acknowledgement

This work was supported by Grant of the Romanian National Authority for Scientific Research, CNCS, UEFISCDI, PN-III-P2-2.1-BG-2016, Project number: 78BG/2016, SC Artecom SRL upgraded competences through deep soil tillage machinery optimization.

### References

- Godwin, R.J., Spoor, G. Soil failure with narrow tines. *Journal of Agricultural Engineering Research* 22(4) p:213-228, 1977
- Hendrick, J.G., Gill, W.R. Soil reaction to high speed cutting. *Transactions of ASAE* 16(3) p:401-403, 1973
- Kushwaha, R.L., Shen, J. Three-dimensional finite element analysis of high speed tillage. In *Proceedings of 14th Canadian Congress of Applied Mechanics* (2) p:691-692, 1993
- Liu, Y., Hou, Zhi-Min Three dimensional nonlinear finite element analysis of soil cutting by narrow blades. *Proceedings of International Conference on Soil Dynamics Related to Tillage Machinery Systems* (2) p:322-337, 1985
- Mouazen, A.M., Neményi, M. Tillage Tool Design by the Finite Element Method: Part 1. Finite Element Modelling of soil Plastic Behaviour. *Journal of Agricultural Engineering Research*, Volume 72, No. 1, p:37-51, 1999

- Payne, P.C.J. The relationship between the mechanical properties of soil and the performance of simple cultivation implements. *Journal of Agricultural Engineering Research* 1(1) p: 23-50, 1956
- Spoor, G., Godwin, R.J. Experimental investigation into the deep loosening of soil by rigid tines. *JAER* 23(3), p:243-258, 1978
- \*\*\* Manual for LS-DYNA Soil Material Model 147. US Department of Transportation, Federal Highway Administration, nr. FHWA-HRT-04-095, 2004
- \*\*\* Evaluation of LS-DYNA Soil Material Model 147. US Department of Transportation, Federal Highway Administration, nr. FHWA-HRT-04-094, 2004
- \*\*\* Manual LS-DYNA

## EFFECT OF PROPAGATION METHOD ON SWEET CORN QUALITATIVE PROPERTIES

Ferenc OROSZ

Sapientia University, Department of Horticulture, 540485 Targu Mureş, Şoseaua Sighişoarei 1C, Romania

\*Corresponding author: oroszferenc67@gmail.com

### Abstract

Experiment set up in 2014 aims to investigate shortening of sweet corn growing period with application of some technological elements: propagation time, propagation method, floating row cover. The chosen variety was a conventional sweet corn hybrid, very early ripening 'Spirit'. The following growing technologies were compared: 1. Plants transplantation with floating row cover, 2. Direct sowing of plants with floating row cover, 3. Direct sowing of plants with no row cover (regarded as control). The transplanted plants had shorter growing period 19 days, compared to direct sowed covered treatment and were 21 days earlier harvested than control. Interaction of growing technology and plants covering had also a favourable effect on some important morphological properties of ears such as weight of husked and unhusked ears, ear length, ear diameter, length of kernel.

**Key words:** *earliness, sweet corn, transplantation, fleece covering.*

### Introduction

Based on its present growing area, the sweet corn is the vegetable which is grown on the greatest area in Hungary. After dates of Hungarian Fruit & Vegetable Interprofessional Organization in 2016 the growing area was about 32,000 hectares. After 2003, greatest cultivated area about 38,000 ha, followed a sudden and sharp decline. After diminishing, the plant returned in rise, in 2006 against over 30,000 hectares, excepted 2010, 18,000 ha. The recession mentioned above affected not only Hungary but also the holdings of the USA and Western Europe. In the case of the former, however, the increase in fresh consumption partly counterbalanced the rate of decrease. Near 50% of world sweet corn production came from US (Slezák *et al.*, 2012). In 2013 the growing area was 34,000 hectares, less with 1,000 ha, compared to 2012 (Avar, 2013).

In order to promote fresh consumption, as well as to maintain and increase the sweet corn exports, it is necessary to promote investigations so as to be able to ensure a further increase in the growing area and yields of sweet corn with the help of the experiences. The literature mainly is concerned with maize growing technology, but a lot of dates could be used by sweet corn. Of the production technology elements, a number of researchers studied are currently studying the sowing time of sweet corn.

As early as at the ending of 19<sup>th</sup>- and the beginning of the 20<sup>th</sup> century some researchers (Cserhádi, 1901) highlighted the importance of the sowing date. Ripening can occur earlier when sowing earlier and using high quality seeds as compared to normal or late sowing.

Several techniques are known in the art for the purpose of early fresh market shipments: seedling growing or direct seeding with temporary plant cover (Hodossi, 2004).

About the covered early sowing as a technological variation, Aylswirth (1986) mentioned, that from an early sowed crop, made in first week of April, arranged in twin rows (42 cm) and covered by plastic, we could harvested marketable cobs by the fourth of July.

According to Takácsné-Hájos and Gyökös (2011) sown on 14<sup>th</sup> April under movable plastic tent some super sweet varieties, Dessert 70 F1 and Signet F1, could be harvested as early as the 1<sup>st</sup> of July. In this way the adverse effect of considerable precipitation quantity and decrease in

temperature in the year 2010 could be prevented and in the same time harvest occurred 7–10 days earlier than in the covered field production.

The most widespread method of seedling production is the use of soil blocks (Pereczes, 1999) which can also significantly increase earliness. The combined application of seedling growing and floating row cover can advance harvest by three weeks as compared to the traditional technology and can give farmers a three to four times greater income (Kurucz, 1998). Rattin et al., (2006) compared direct sowed and transplanted sweet corn varieties, without covering and concluded no difference, in ear weight and ear length, between transplanted treatments plant's, in comparison to direct sowing treatments plant's.

### Materials and methods

The experiment was set up in 2014 on an area equipped for irrigation at Tg-Mures, Mures County, situated in Central part of Romania. Conventional, reliable and sufficiently known among growers sweet corn variety, Spirit, was used as a reference variety in the variety comparison trials of the Central Agricultural Office. Hybrid has short growing period of 85 days and yellow kernels. Average height of plants is 159 cm, average ear height is 37 cm, ear length 19.6 cm and average ear weight is 245 g. The variety was granted official recognitions in 1988 and has been the dominant variety of the early ripening category till now. In the year prior to the experiment the area was under wheat.

The following treatments, each with four replications, were applied during the experiment:

P1 = plants transplantation with floating row cover, normal period (25<sup>th</sup> April)

P2 = direct sowing of plants with floating row cover, normal period (25<sup>th</sup> April)

P3 = direct sowing of plants without row cover, normal period, regarded as control (25<sup>th</sup> April)

For the frame structure of the treatments with cover we used  $\varnothing$  4.2 mm zinc coated wire coils. The fleece, 60 cm in width, was stretched over a small tunnel of 40 cm in height and then its edges (25-25 cm, respectively) were covered with soil using a hoe and the its ends were tied to the stakes hammered down. The construction of the frame structure and the setting out of the fleece cover were carried out at the same day as direct seeding and out planting.

For the purpose of seedling growing, the seeds were sown on 4<sup>th</sup> April 2014, in trays with rigid walls having 3.7x4x5.4 cm size. For growing the seedlings, commercial mix made of white peat 10-20 mm, PG Mix 1 kg/m<sup>3</sup> + micro nutrients, bentonite 40 kg/m<sup>3</sup>, pH 5.5-6.5 was used. The seedlings were planted out at the 3 to 4 leaf phenological stage. At the two propagation times the treatments P1 and P3 were covered with Novagryl floating row cover, having a weight of 19 g/m<sup>2</sup>, (using the small tunnel technique) in order to enhance earliness. The stand was created to contain 60,607 plants per hectare, according to the recommendations of the owner of the variety, at a spacing of 110+40x22 cm in twin rows. Each plot had an area of 6x3.5m (8 parallel rows and 16 seeds sown in each row). Sowing depth was 3 cm. The edge was the respective outer rows of the 4 twin rows of the plot.

In October 2013, 35 t/ha of farmyard manure was worked into the soil with ploughing on area. Nitrogen fertilizer (120 kg/ha) was applied at the 6-7 leaf stage, the form of top dressing. The fertilizer application was worked into the soil with a rotary hoe.

Ears were harvested together with the husks, from the two central twin rows. Twenty ears were selected from each row and the following measurements were carried out:

weight of unhusked and husked ears (g);

total ear length (cm);

length of seeds (mm);

ear diameter (mm).

The statistical analysis of the results was carried out by using the programme *RopStat 1.1*. When the standard deviations were identical the mean values were compared by pairs using the *Tukey-Kramer* test, while in the case of the non identical standard deviations the means were compared using the *Games-Howell* test (Vargha, 2007).

### Results and discussion

According to obtained results, harvesting time (measured in days) was the shortest in the treatment P1 and P2, merely 64 (VI. 28.), respectively 83 (VII. 17.) days, i.e. the corns became ready for harvest 21, respectively 19 days earlier compared to P3 (control) (VII. 19.). In case of P2 treatment, harvesting began 2 days earlier compared to P3 (control).

Results of the one of the major characteristics in connection with yield rating, unhusked and husked ear weight, are summarised in Figure 1.

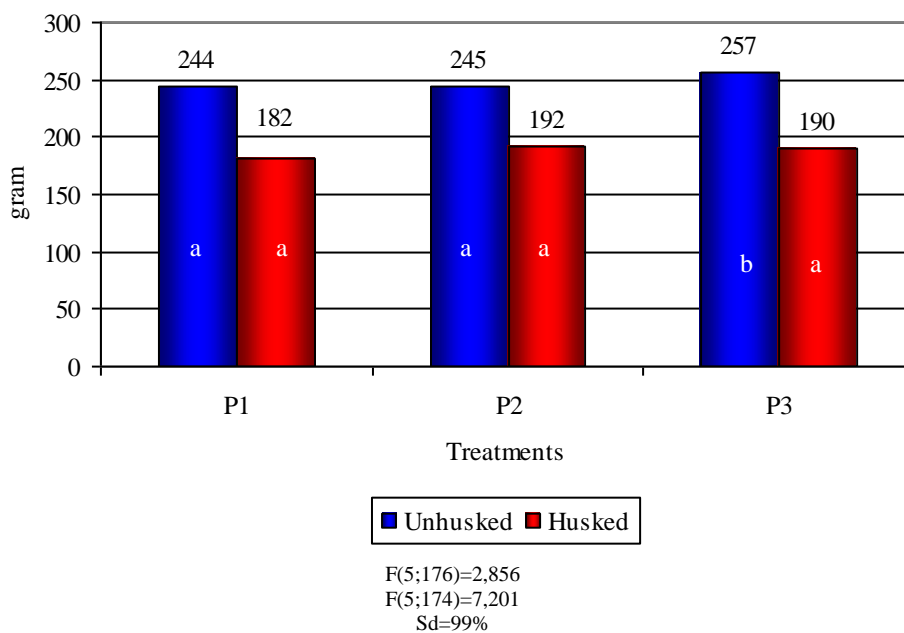


Figure 1. Unhusked and husked ear weight (g)

Analysing the data measured for unhusked ear yield, it is noticeable the average weight of the ears of transplanted covered P1 and direct sowed covered P2 treatments was significantly (at  $p<0.01$  level) lower as compared to direct sowed, uncovered P3 (control) treatment. Covered treatments P1 and P2 unhusked ear weight compared to each other presented no difference. Measured highest value of husked ear weight, but not significant statistically was observed by ears of covered, direct sowed (P2) treatment.

The data concerning an important characteristics for market appeal (total ear length) are contained in Figure 2.

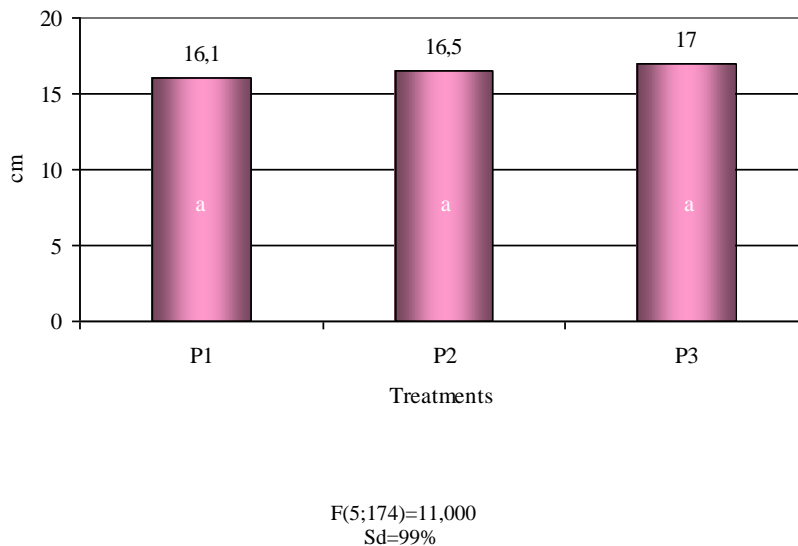
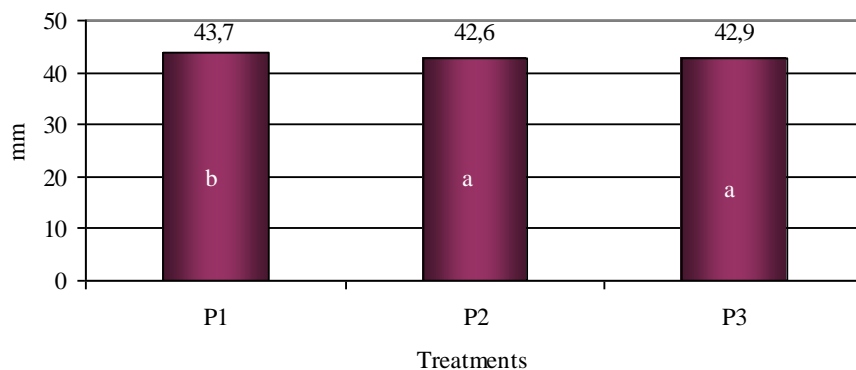


Figure 2. Total ear length (cm)

The length of the covered, transplanted treatment P1 shorter compared to the ear length of direct sowed, covered (P2) and direct sowed, uncovered (P3, control) treatments. No statistically demonstrable difference was found between ear lengths of covered, direct sowed P2, uncovered direct sowed P3 (control) treatments.

Total ear length, average ear length 19.6 cm as measured in the variety comparison trials, had been not achieved by the above mentioned treatments.

Other important characteristics for market appeal (total ear diameter) is presented in Figure 3.

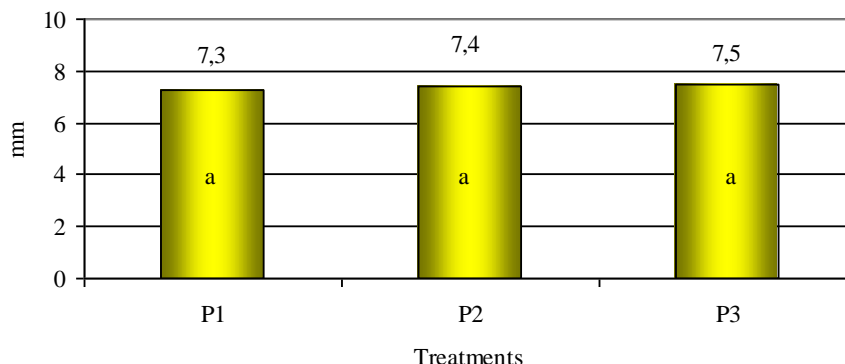


F(5;174)=4,440  
Sd=99%

Figure 3. Total ear diameter (mm)

The measured values were significantly (at  $p < 0.01$  level) higher in case of transplanted, covered treatment P1 compared to covered, sowed treatment P2 and uncovered, sowed treatment P3 (control) treatments. Total ear diameter of covered, sowed treatment P2 and uncovered, sowed (P3, control) treatment presented no significantly differences.

Length of seeds is an important characteristic for yield quantity is presented on Figure 4.



F(5;174)=1,248  
Sd=99%

Figure 4. Length of seeds (mm).



The measured length of seeds values were higher in case of covered and uncovered, sowed treatments P2 and P3 (control) compared to covered, sowed P1 treatment. Length of seeds of transplanted, covered treatment P1 and covered, sowed P2, uncovered, sowed P3 (control) treatments no significantly differences were found.

### **Conclusions**

Based on the results of the 2014 year experiment, the following conclusions can be made:

The growing period was significantly shortened with transplantation of sweet corn plants compared to direct seeded.

Harvest time occurred 21 days earlier in the case of normal time, transplanted and floating row covered (P1) application compared to normal time, direct sowed, uncovered, control (P3) treatment, and 19 days earlier compared to normal time, direct sowed, covered P2 treatment.

At the same time the floating row cover produce 2 days shortening in the growing season between P1 (transplanted plants with floating row cover) and P2 (direct sowing of plants with row cover) treatments.

The fleece covering had favourable effect on studied morphological characteristics of plants that are transplanted and floated with row cover.

In case of direct sowed treatment (P2) the effect of covering had positive effect on unhusked and husked ear weight, length of ears and length of seeds.

### **References**

- Aylswirth J. D. (1986). Harvest sweet corn by the fourth. *American Vegetable Grower*, 34 (2) 37-38. p.
- Avar L. (2013). Sárgán csillogó édes szemek (Yellow sweetness). *Magyar Mezőgazdaság*. 2013. 68 (36) 10-11. p.
- Cserhádi S. (1901). Általános és különleges növénytermelés (Generally and specially plant production). II. kötet, Magyaróvár, s.n. 527 p.
- FRUITVEB (Hungarian Fruit & Vegetable Interprofessional Organization): A zöldség és gyümölcs ágazat helyzete Magyarországon (Situation of vegetable and fruit growing in Hungary) 2016.
- Hodossi S. (2004). Csemegekukorica (Sweet corn). In: Hodossi S.– Kovács A.–Terbe I. (ed.): Zöldségtermesztés szabadföldön (Open field vegetable growing). Mezőgazda Kiadó, Budapest, 340-348.
- Kurucz M. (1998). Palántázott és takart csemegekukorica (Planted and covered sweet corn). *Kertészet és szőlészet*, 47 (11), 7.
- Pereczes J. (1999). Csemegekukorica. In: Nagymagvú zöldségfélék (Big seeded vegetables). (Ed. Mártonffy B., Rimóczi I.). Mezőgazda Kiadó. Budapest, 50-72.
- Rattin J., Benedetto A., di, Gornatti T. (2006). The effects of transplant in sweet maize (*Zea mays* L.). I. Growth and yield. *International Journal of Agricultural Research*, 1(1), 58-67 p.
- Slezák K., Papp Z., Csathó P., Árendás T., Németh T., Fodor N. (2012). Csemegekukorica (Sweet corn). In: Radics L. (Ed.): Fenntartható szemléletű szántóföldi növénytermesztés II. (Sustainable open field plant production II.), Budapest, Agroinform Kiadó, 101-123 p.
- Takácsné-Hájos M., Gyökös E. (2011). Csemegekukorica fajták vizsgálata korai termesztésben vándorfólia alatt (Evaluation of sweet corn varieties in early production under movable plastic tent), *Kertgazdaság*, 43(3), 15-23 p.
- Vargha A. (2007). Matematikai statisztika pszichológiai, nyelvészeti és biológiai alkalmazásokkal (Mathematical statistics with psychological, linguistic and biological applications). Pólya Kiadó. Budapest, 213-237 p.

## CONTENT OF VITAMIN C, BETA-CAROTENE, POTASSIUM AND PHOSPHORUS IN THE LOCAL PEPPER POPULATIONS

Pandia OLIMPIA<sup>1\*</sup>, Saracin ION<sup>2</sup>, Paraschiv GIGEL<sup>3</sup>, Tanasie STEFANIA ELIZA<sup>1</sup>

<sup>1</sup>University of Agricultural Sciences and Veterinary Medicine Bucharest, Romania

<sup>2</sup>University of Craiova, Faculty of Agriculture, Romania

<sup>3</sup>Polytechnic Institute of Bucharest, Romania

\*Corresponding author: olimpia\_pandia@yahoo.com

### Abstract

The purpose of research is to highlight the content of vitamin C, beta-carotene, potassium and phosphorus in the eight local pepper populations in southern Oltenia, Nettle and Ianca localities Romania on two different soils as a structure. Because the soil plays a decisive role in the cultivation, development and production of significant crops in the pepper crops studied, the agrochemical determinations carried out on the soil confirm the importance of knowing its composition and especially the accessibility of the nutrients from the organic soil reserve.

The actuality of this research results from the need to fully know the nutritional value potential of pepper in the areas studied. Acquiring these results will help future vegetable and nutritionists, develop a broad range of organic products for food, cosmetics, pharmacy and health.

In this way, the knowledge of the biochemical composition of the peppermint fruit comes in addition to the vitamin requirements required by our body but also used as a biostimulator of blood circulation in treating various colds, sore throats, relieves rhinitis, treats gingivitis, regulates Blood pressure, intensifies poor peripheral circulation, prevents gastric ulcer and especially in rheumatic treatment. The naturist remedies as well as the culinary ones recommend the pepper to be enumerated as one of the main vegetables from Romania which are very sought and consumed.

The purpose of the paper is to develop the theoretical and practical bases for highlighting the role of chilli pepper in the development of the food industry, the pharmaceutical industry, cosmetics and health, the use of the biochemical composition of chilli peppers, the determination of the growth potential of these industrial branches and the argumentation of some proposals for efficiency Use of chilli pepper properties for multiple purposes.

**Keywords:** *Pepper, Beta-carotene, Potassium, Phosphorus.*

### Introduction

*Capsicum annuum L* is an annual plant of the solanaceous family. Being a plant known to many of us, but not knowing how beneficial it is that the herb or pepper can be used even as an ornament plant. Hot pepper is perhaps the plant with the most health benefits, and its consumption prevents certain diseases.

There are many vegetables with real therapeutic properties, but hot pepper is a real drug, and the what do you mean with quicker it is, the richer it is in substances beneficial to the body.

Beta-carotene from chilli pepper is not only a powerful antioxidant but can be converted into vitamin A, a vital nutrient for the health of all epithelial tissues. Beta-carotene may be useful in reducing the symptoms of asthma, osteoarthritis and rheumatoid arthritis.

Amongst the known vegetables, pepper has a multitude of benefits for human healthy (Ciofu R., et al., 2002). Pepper takes part of the genus *Capsicum* and is known as *Capsicum annuum L*. It is a source rich in vitamin C, the most known vitamin, which is an antioxidant being important in infections prevention and treat. Vitamin C treats colds, removes the fatigue and anxiety sensation and strengthens the immune system. The vitamin C necessary for an adult varies between 60-80 mg/day. A particular importance for the organism is also represented by beta-carotene which is

taken from fruits and vegetables and when it reaches inside the organism is transformed in vitamin A, being acknowledged for improving the immune system and the sight. There is not a daily quantity recommended by specialists until now (Bosland P.W., 1999; Enăchescu G., 1984).

Because the proteins are part of every cell from the organism, being implicated in all its functioning processes, the knowledge of vegetal protein quantities existent in every aliment is important, because the daily necessary is 1g/kg of body depending on gender and age, and the pepper fruits have also in their composition small quantities of protein (Sărăcin I., et al., 2010; Somoş C., 1967).

The consumption of pepper combats cancer, stimulate the pancreas and helps at lungs function. Last, but not least, the pepper is used with success in diet, helpful at weight loss. It helps to the stimulation of our metabolism, through the action on vein structure (Lazăr V., 2006). Pepper is one of the most adequate remedies for high blood pressure, cleans arteries and has contribution in decrease of bad cholesterol or triglycerides (Ulrich A., 1996).

Given that the cardiovascular diseases are the first cause of death on globe, the proprieties of pepper are particularly important. Pepper is beneficial both for stomach and gastrointestinal tract, because it stimulates the peristaltic movement, helps to eliminate feces and contributes at the construction of stomach tissue, easing the heal of stomach injuries and intestinal ulcers (Sărăcin I., et al., 2010).

When pepper is consumed, it triggers a heat sensation in the whole body and for this reason it was recommended in case of frostbites. Sharply and spicy, pepper is added in different types of tasty food from all over the world.

Depending on the nutritional values peppers can be recommended for consumption fresh, canned or dried, for pharmaceuticals and herbal medicine or both, knowing that natural medicine is making giant steps in improving or curing serious diseases or diseases for people's health, where chemically prepared preparations are successfully replaced with herbal preparations or medicinal, aromatic or spontaneous plants.

### **Material and Methods**

The carried out by placing chilli peppers from the local communities of the two communes in southern Oltenia, namely Urzica and Ianca, where we monitored the contents of vitamin C, beta-carotene, potassium and phosphorus of pepper harvested in technical maturity. Because soil has an important role in crop technology, we also performed soil analyzes before the cultivation began, namely April 12, 2015.

The chemical composition of the plant is a synthetic indicator that reflects the plant's biological peculiarities, and the correct interpretation of plant analysis results can only be made taking into account agrochemical soil indicators.

Methods of work used for physiological determinations of plants targeting the production of hot chilli peppers from the eight popular cultivation will be subjected to biochemical analyzes for the determination of vitamin C, beta carotene, phosphorus and potassium.

The nutrition conditions in the soil, determined both at the level of natural fertility and applied technologies, are another important factor of variability of the chemical composition of chilli plants, which requires soil agrochemical analysis prior to the establishment of crops experimental.

The soil samples were harvested using an agrochemical probe at depths of 0-10 cm and packed in plastic bags until they were brought into the laboratory. The sampling took place on 17.07. 2015 for the two communes of Urzica and Ianca.

Samples of hot chilli peppers harvested in the technical maturity phase are packed in perforated plastic bags and taken during the same day in the laboratory.

The P-content in the extract obtained by the mineralization is colorimetric with ammonium vanadate and the P content of the vegetal material is expressed in% P from the dry matter and is calculated by the relationship (Bergman et al., 1976):

$$P\% = C \times Vt \times 100 / Va \times m \times 1\ 000\ 000$$

in which:

C - The content of P in micrograms of the aliquot used for colorimetry

M - The amount of vegetal material used for mineralization in grams

Vt - Total volume of the extract obtained from the mineralization in ml

Va - Volume of the aliquot part used for colorimetry

100 - Percentage reporting factor

1 000 000 - Transformation factor of micrograms in grams

The determinations for K was carried out by flame emission photometry and the results obtained from the K-dosing of the plant material are expressed as a percentage of the dry matter as follows:

$$K\% \text{ of SU} = C \times V \times r \times 100 / m \times 1000 \ 000$$

$$K\% \text{ of SU} = C \times V \times r / m \times 10 \ 000$$

where:

C - Concentration in micrograms K / ml, found on the calibration curve

V - Volume of the diluted solution used for dosing in ml

R - The dilution ratio used

M - Amount of vegetal material used in mineralization expressed in grams

For the determination of the vitamin C content of the pepper, the titration method was used and the titration result multiplied by the coefficient 8,8 being expressed in mg of ascorbic acid per 100 g of fresh substance (mg%). Beta-carotene was obtained using the photolorimetry method.

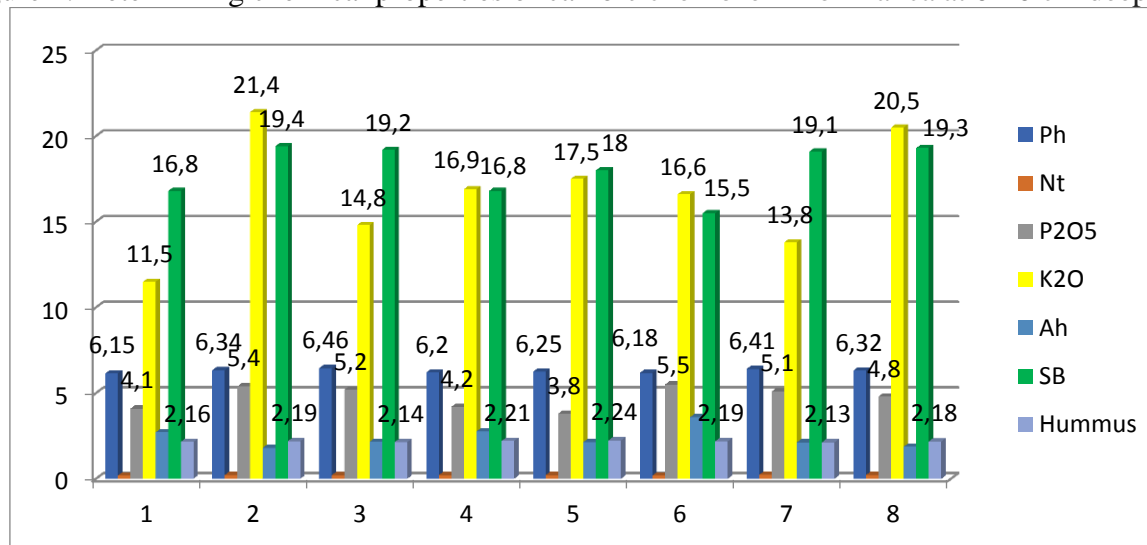
Chemical and hydrophysical analyzes were performed on the soil, so pH determination was performed by potentiometric methods, Ah - the soil was treated with the solution of an alkaline hydrolyzate state and 0.1 N sodium hydroxide in the presence of phenolphthalein.

Sb was determined by Kappen method, phosphorus and potassium by the Enger-Riehm-Domingo method, Walkle and Black humus and Nt by the Kjeldahl method.

## Results and Discussion

Analyzes and results are presented in the tables below, with soil samples being collected from eight different sites. The soil of the Ianca commune is a cambic faeoziom (cambic cernoziomoid soil), and the Urzica commune is an argil faeoziom, ie an argiloiluvium chernozem.

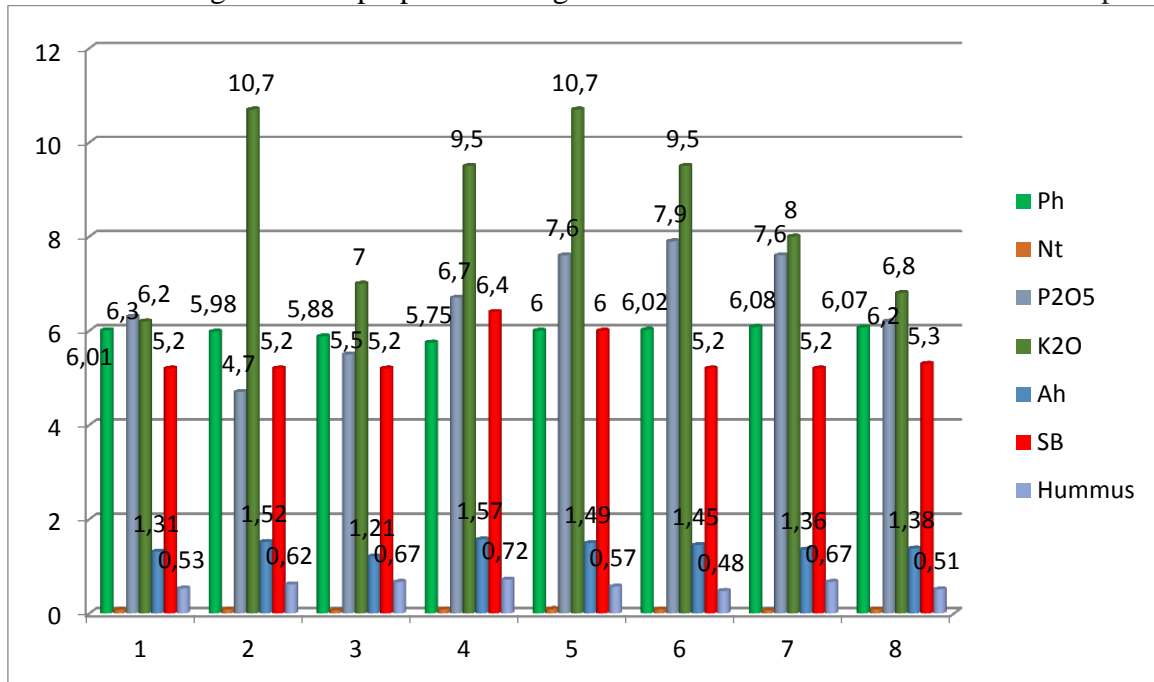
Figure 1. Determining chemical properties of cambic chernozem from Ianca at 0-10 cm deep



\*Source: Elaboration by the author

Soil from Ianca village, Olt, has a good pH, accessible to vegetable crops, and the humus content gives a high profitability by producing increased yields.

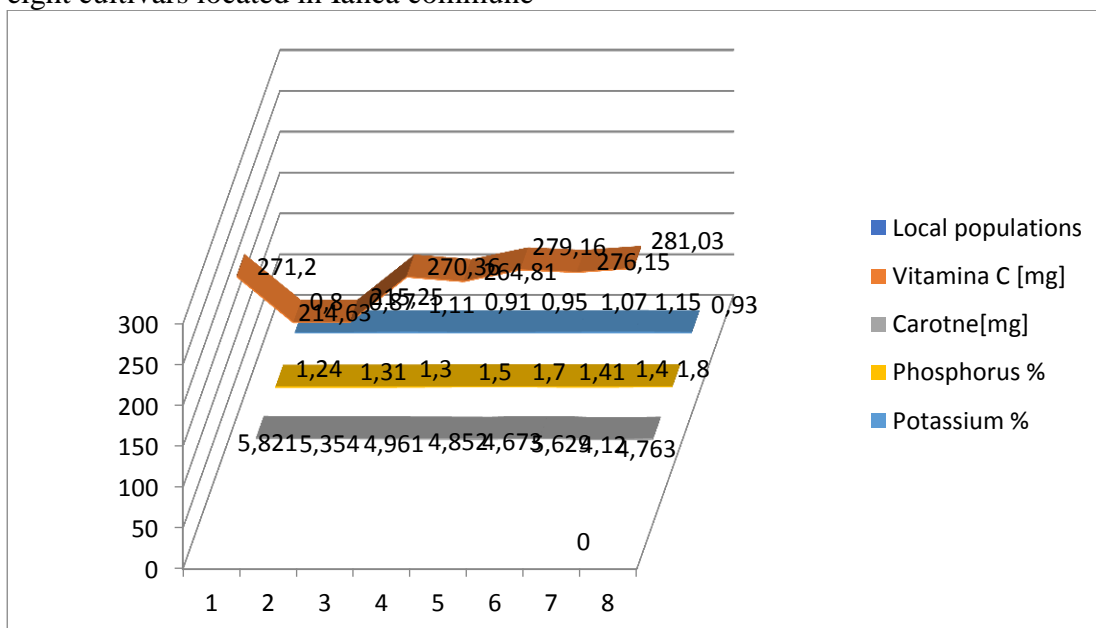
Figure 2. Determining chemical properties of argic chernozem from Urzica at 0-10 cm deep



\*Source: Elaboration by the author

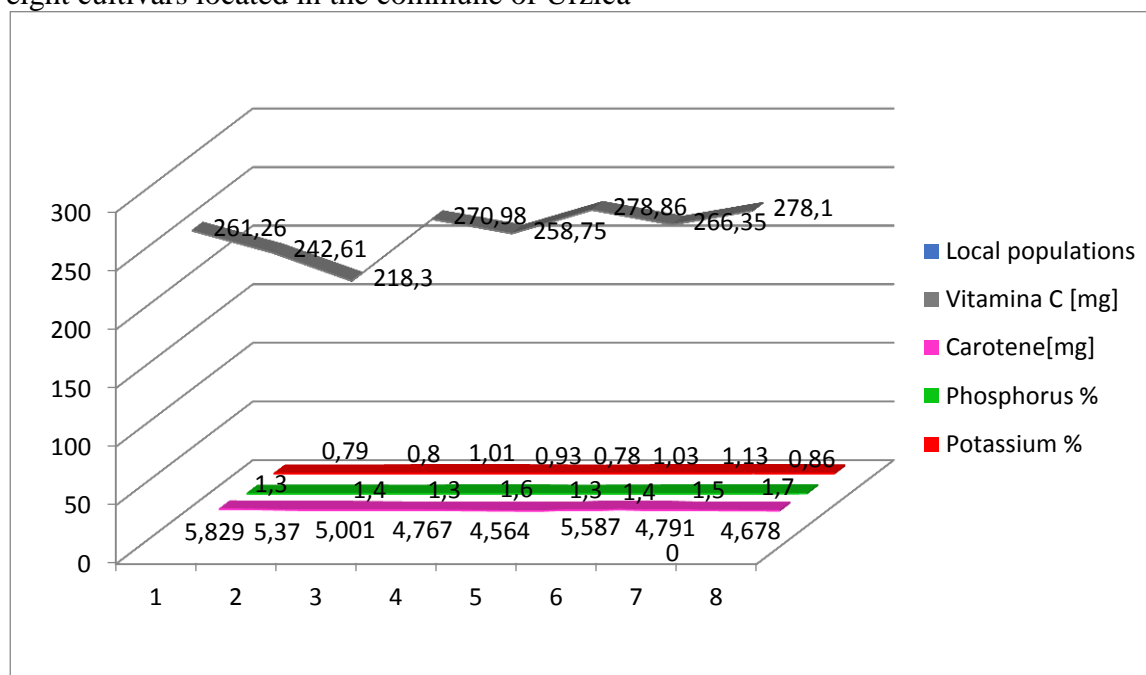
The differences between the two soil types are relatively small and difficult to identify on the ground but are highlighted by laboratory analytical data. In terms of chemical properties, the two soils studied have high phosphorus and potassium content, which gives them a good natural fertility. When determining the four active principles obtained from the biochemical analyzes of the hot pepper, it can be ascertained that the best results were obtained for vitamin C, cultivar number 8 from Ianca commune, and for carotene was evidenced the cultivar numărul 1, for the phosphorus cultivar number 8 and for the potassium cultivar number 7.

Figure 3. Determination of the vitamin C, beta-carotene, phosphorus and potassium content of the eight cultivars located in Ianca commune



\*Source: Elaboration by the author

Figure 4. Determination of the vitamin C, beta-carotene, phosphorus and potassium content of the eight cultivars located in the commune of Urzica



\*Source: Elaboration by the author

The results obtained from the cultivars located in Urzica commune, vitamin C is found to be higher at cultivar number 6, carotene in cultivar number 1, phosphorus at cultivar number 8 and potassium at cultivar number 7. bFollowing the obtained, the active principles determined from the eight cultivars in both communes, behaved almost similarly in both communes. These results obtained by biochemical determinations are necessary materials which will represent the study object for obtaining pharmaceutical products which have components obtained from pepper as active substance, knowing that the replacement of chemical-obtained products with naturist products is tried with success. The modern agriculture from nowadays, along with all the sectors related to it in Romania, make the scientists to do different studies and put into practice the obtained results for promoting naturists products in alimentation as well as in naturist and beauty medicine.

### Conclusions

The local cultures studied have succeeded in achieving the proposed goal. Nutritional values are influenced by soil, climate, color, and harvesting. Following the analysis for the determination of vitamin C from the eight cultivars located in the two communes, the best results were obtained by cultivars number 8 and number 6. Determination of carotene from the chilli pepper to the eight cultivars, the most significant results for carotene belonged to cultivar number 1 for both communes. Determinations of phosphorus and potassium content in cultivars number 8 and number 7 for both communes yielded the best results. As a result of the results, it was found that the majority of the local poppy cultivations behaved very well in the described locations, so we recommend their acceptance as varieties with a local name in the vegetable culture, for the diversification of the peppermint varieties in our country, for the enlargement food, natural and pharmaceutical, and the benefits of certain active principles underlying the composition of hot pepper.

### **References**

- Bosland P.W., (1999).Capsicum: Innovative uses of ancient crop. In: J. Janick (ed) Progress in new crops; ASHS Press; Arlington.
- Ciofu R., Stan N., Popescu V., Chilom P., Apahidean S., Horgoș A., Berar V., Lauer K. F., Atanasiu N., (2003).Vegetable treaty;Ceres Publishing House Bucharest.
- Enăchescu G., (1998). The chemical composition of the main crops. Vegetables in plant biochemistry Treaty of C. Bodea; vol.V; Academy Publishing House; Bucharest RSR.
- Lazăr V., (2006). Effect of the culture system on the quality of the pepper; Cluj Napoca.
- Sărăcin I., et al., (2010).Sowing for small seeds; Annals of the University of Craiova – Agriculture; Montanology; Cadastre Series vol. XL /2. pg. 561-565.
- Somoș C., (1967). Fertilization of vegetables in family farms; Agricultural Technical Publishing House; Bucharest.
- Ulrich A., (1996). Potasium in diagnostic criteris for plants and soils; University of California; Berkley.

## CHANGING THE CLIMATE IN THE CONTEXT OF SUSTAINABLE AGRICULTURE

Radulescu DIANA LOREDANA<sup>\*1</sup>, Găgeanu IULIANA<sup>2</sup>, Rosu MIHAELA<sup>2</sup>, Pruteanu AUGUSTINA<sup>2</sup>

<sup>1</sup>University of Agricultural Sciences and Veterinary Medicine Bucharest, Romania

<sup>2</sup>National Institute of Research-Development for Machines and Installations designed to Agriculture and Food Industry, Bucharest, Romania

\*Corresponding author: radulescudiana15@gmail.com

### Abstract

The research is circumscribed to the latest global concerns. We note that the field research has evolved a lot, due to several reasons:

the importance of ensuring sustainable development;

the role that agriculture has in the economy and society;

growth of risks in agriculture due to climate change;

high volatility of outputs, costs, prices and incomes on farms.

In this respect, in order to carry out this research, a significant role belongs to the identification of the different types of severe meteorological phenomena and the agro-climatic risk aspects. Thus, first of all, the phenomenon of agricultural drought will be described, starting from a general look at the definitions, concluding that at the conceptual level in the literature the definitions of drought are numerous and are based on the meteorological parameters, singular And/or in combination, but in direct correlation with the moisture requirements of the plants during the main phases and specific interfaces of vegetation. A drought-related damage dimensioning is also carried out according to the intensity and duration of disturbing factors (winter drought, spring drought, summer drought, autumn drought). Also, the characterization of the above-mentioned phenomenon is made, starting from agrometeorological/agro-climatic parameters of risk/thermal, atmospheric and hydric stress, defining, characterizing and identifying the singular and/or complex production of the agricultural drought phenomenon. The following result, the selection of the agro-climatic risk types according to the main characteristics of production and effects (materialized in a risk taxonomy), was obtained on the assumption that an overview of some definitions of the agro-climatic risk types defined by the indices Agrometeorological and agro-climatic shows that the risk/thermal stress or water stress can be classified according to the basic criterion used in the analysis and assessment of the effects on each agricultural species. It was also considered that agrometeorological/agroclimatological literature specifies the agro-climatic risk types based on agrometeorological/agro-climatic parameters singly or in combination and in direct correlation with the requirements for plant vegetation conditions by phases and Specific interfaces, as well as the active season as a whole. Thus, the types of thermal and hydric risk, respectively the heat, rainfall and atmospheric, pedological and agricultural drought, defined and characterized according to the specific criteria of analysis, the taxonomy of the risks was made. For each type of agro-climatic risk, three levels of risk characterizing vulnerability to thermal and hydrological risk have been identified - excessive, strong and moderate risk.

**Keywords:** *Biodiversity, Climate Change, Desertification, Sustainable Development.*

### Introduction

Recent research by ANM researchers, which we are grateful for the research made available as well as for the data we later used in the construction of the Seleanynov indices.

The scenarios on the impact of climate change in the Caracal micro-zone on wheat and maize crops have taken into account the models CERES-Wheat (DC Godwin et al., 1989) and CERES-Maize



(JT Ritchie et al., 1989). Daily basic biophysical processes occurring at the soil-plant-atmosphere interface in response to the variability of environmental factors.

The impact assessment of climate change on autumn wheat and maize crops was based on climatic scenarios derived from regional climatic models (RegCM) for two distinct periods, namely: 2021-2050 and 2071-2100.

These scenarios predict future climate change by modifying monthly averages of monthly air temperature, rainfall, and solar radiation values that have been applied to the current climate adjustment. The simulated results under conditions of climate change were compared with those simulated under the current climate and the changes in the production levels and the length of the vegetation period were thus quantified.

As a secondary objective, we intend to analyze the evolution of the areas, production and average production during the period 2004 - 2012, at the Caracal micro-zone and the localities of this micro-zone, for wheat, corn and sunflower crops and to see to what extent they were affected by changes in climatic factors. Research on the impact of climate change on sustainable development is achieved through a complex and integrated approach to information in a comparative system of analysis and identification of risk situations in the agricultural field. As far as the impact of climate variability on growth, development and training of agricultural crops is concerned, it is quantified by the potential of meteorological parameters to ensure optimal vegetation conditions or unfavorable effects, depending on the degree of intensity of the disturbing factor, the mode and duration of action, the vulnerability of plant species to extreme weather events. In Oltenia, in general, there were no studies of physiological processes determined under different environmental conditions, respectively water year (2002) and climatic normal (2003), for corn culture "presented in his paper By Pandia Olimpia (2006). Thus, Barrett (1999) puts the issue of environmental regeneration as an objective and major necessity that arises from the irrational exploitation of resources (which becomes anthropogenic risk, which is a potential risk factor for other risks, with a direct impact on development Durable), a problem that must be thought globally, at the level of spatial and temporal dimensions that satisfy, for at least a long time, the human collectivity.

Sorocovschi (2003) highlights the functional complexity of risks and catastrophes resulting from a large number of factors, components and impacts, reflecting their multidisciplinary and interdisciplinary character. An interesting contribution is the dual risk approach, meaning both the losses and the earnings they produce (Denmead 1960). Another interesting contribution is presented by Berbecel (1980) and Iagăru (2001), which highlights the extent of human risks related to climatic and environmental risks. At present, atmospheric pollution is increasingly "incriminated" by the global climate change, which, if produced, would be the most dangerous natural hazard possible for mankind. In the year (2013), Sărăcin Ion and his colleagues report "The result of poor agricultural practices regarding the quality of sandy soil in southern Oltenia", due to all the climate changes and the mistakes of applied agricultural technologies.

## **Material and Methods**

The studies and researches were carried out in the Caracal micro-region of Olt, Romania, which includes 8 communes (Brastanovatu, Bucinișu, Deveselu, Obârșia, Redea, Rotunda, Traian and Vlădila) besides the city of Caracal. Agriculture in the localities of this micro zone is well represented, the data presented being eloquent.

The year 2012, reported at the level of Olt county, with a total area of 549,828 ha, the area of the micro-region was about 47,696, or about 9%. A similar share also holds in terms of the agricultural area, Caracal microzone, with about 41,416 ha, accounting for 9.5% of the agricultural area of Olt County. As for the arable land, the Caracal microzone with the 40,532 ha had, at the level of 2012, a share in the county of over 10% of the total arable area.

A first category is represented by qualitative research methods such as: analysis, synthesis, comparison, use of induction and deduction analysis couple, and comparative analysis.

Another set of tools are the quantitative models: statistical processing, accompanied by specific research tools, such as: sorting, structural analysis and dynamics, then statistical and economic analysis, econometric models.

Thus, we have identified the statistical links, links and interdependencies that are formed between different phenomena and processes and the degree of correlation as a method by which we studied the relation and the interdependence between two phenomena or characteristics of a phenomenon expressed numerically.

When increasing the values of a characteristic is accompanied by an increase in the value of the other characteristic, the correlation is direct. When increasing the value of a characteristic corresponds to a decrease in the value of the other characteristic, the correlation is inverse.

We have also identified the degree of functional dependence, that is the correspondence that can be established between two variable sizes, so that, given an arbitrary value of one of the two sizes, it uniquely determines the value of the other magnitude. The two functionally dependent variables can be qualitative or quantitative characteristics.

The most commonly used climate change indicators (temperature, precipitation, and mixed) were selected, among which we chose Seleanynov, which are considered to be representative of our research.

We compute the Seleanynov agro-climatic indices using the formula:

$$SHR = \frac{\sum \text{rainfall}}{0.1x \sum \text{temperature/medium}} \quad (1)$$

The index is one of seasonality, measuring variations in phenomena in different periods of the year. These are phenomena that normally have seasonal oscillations (temperature and precipitation).

The average index was calculated as the average of the individual indices showing the variation of the same characteristics across the different groups of units.

These were determined for three important crops for the analyzed micro-zone: wheat, maize and sunflower.

We used the calculation of agro-climatic indexes of Seleanynov type in regression functions, which analytically describe the dependence between a resolving characteristic and a factorial characteristic. With this help we synthetically expressed the character and the direction of the connection between the phenomena.

The regression function mirrored the way in which the resolving characteristic changed under the incidence of the change in the factorial characteristic, leaving out the influence of other characteristics considered random and consequently not included in the analysis.

In our analysis, the regression function was a linear one, the resolving characteristic changing evenly under the influence of the change in the factorial characteristic, the linear function we used with the formula:

$$Y = a + b x. \quad (2)$$

Where the values of the resolving characteristic  $y$  depend only on the values of the factor  $x$ . All other factors are considered constant.

Geometric, the regression coefficient  $b$  represents the straight line slope. In the theory of correlation, he shows how large the change of  $y$  is, as a result of changing the variable  $x$ , by a unit. Therefore, if  $x$  increases with a unit, the value of  $y$  changes exactly to the size of  $b$ .

The regression coefficient  $b$  was calculated by applying the smallest squares method.

Between the linear regression coefficient  $b$  and the correlation coefficient  $r$  was the relation:

$$b = \frac{\sigma_y}{\sigma_x} r \quad (3)$$

Where  $\sigma_y$  and  $\sigma_x$  are the quadratic mean deviations of the  $y$ , respectively  $x$ ,  $\sigma_y$  and  $\sigma_x$  concrete characteristics, expressed by a certain unit of measure.

From their report, the linear regression coefficient shows how many units of the variable y return to a unit of the variable x. In our case the coefficient has an inverse correlation. The correlation coefficient used to determine the correlation intensity was calculated according to the formula:

$$r = \frac{\sum(x-\bar{x})(y-\bar{y})}{n\sigma_x\sigma_y} \quad (4)$$

in which:

X - the values of the factorial characteristic;

Y - the values of the resolving characteristic;

$\Sigma x$  - the average square deviation of the x characteristic;

$\Sigma y$  - the mean square deviation of the y characteristic;

N - the number of observed values pairs of the x and y characteristics;

or

$$R = xy - x - y \sigma_x\sigma_y \quad (5)$$

in which:

Xy - mean of products xy ( $xy = xyn$ )

X and y - the x and y attribute averages. For the calculation of the correlation coefficient the following formula was used:

$$R = nxy - x(y) [nx^2 - (x^2)] [ny^2 - (y^2)] \quad (6)$$

We then determined the adjustment curve, which was useful, and had to be done taking into account the character of the data to be adjusted. For this, a continuous function, adjustment function, was used with a number of three parameters: temperature, precipitation, production.

The methodology for determining the tendencies and anomalies of the thermal and pluviometric extremes in the Oltenia region aimed to determine and analyze the trends and thermal anomalies of the maximum and minimum monthly temperatures as well as the tendencies of the maximum precipitations within 24 hours in the Oltenia region. For this, we took into account the homogeneous data series for the period 1961-2000 at the meteorological stations in the analyzed region.

**Methodology:** The monthly average monthly temperature (TXL), monthly minimum temperature (TNL) averages and monthly monthly precipitations in 24 hours (CPT) were determined and analyzed.

The simulation models used to develop climate change scenarios and influence on agricultural crops were those used in NMA research and are CERES (Crop-Environment Resource Synthesis), developed under the auspices of the IBSNAT (International Benchmark Sites Network For Agrotechnology Transfer).

## Results and Discussion

Annual fluctuation of climatic factors leads to significant variations in agricultural output from one year to another, and knowledge of the impact of climate variability on vegetation and yields is one of the direct applications of agro-meteorological scientific research in agriculture.

The use of plant protection measures in order to reduce the limiting effect of climatic conditions, especially temperature and precipitation, is clearly reflected in the level and quality of the yields obtained in any area of culture, especially the drought, both irrigated and irrigated.

The analysis of the fluctuation of agro-climatic resources through the dynamic evolution of agro-meteorological/agro-climatic factors is the basic criterion in quantifying the impact of agricultural drought on the state of vegetation and the productivity of agricultural crops.

This way of characterizing and assessing the influence of climate variability on cultivated species/species requires the monitoring of meteorological/climatic factors in terms of evolution of vegetation accumulations (duration and passage of phenological phases) corroborated with

agricultural practice, and differentiated cultivation technology differentiated according to specific agropedoclimatic conditions.

The Caracal Plain, which is the area of interest of this paper, is an agricultural area with a generally dry climate, especially the autumn and summer season, the frequency and severity of droughts produced in these seasons being increasing.

In the agrometeorological research activity, the impact studies in the agricultural field are based on meteorological/climatic data from agro-meteorological programs and the archive of climatology (INMH archive), as well as on the basis of specialty, phenology, biometrics and production measurements carried out Both in the standard platforms of meteorological stations and agrometeorological programs, as well as in production fields located near the weather stations.

For the agricultural area of the Caracal Plain, the Caracal Meteorological Station with agrometeorological program is considered representative and meteorological and agrometeorological meteorological and meteorological observations are monitored for a minimum 30-year reference climate according to the WMO guidelines and norms.

Therefore, in order to assess the influence of climate variability on the vegetation state and yields on the main cereal crops in this area, namely autumn wheat and maize, with a significant weight in the structure of the field crops in the south of the country, meteorological data were used And agrometeorological data from 2004-2012.

From the Meteorological Station Caracal and specialized/technological data, respectively average production/ha, from the Caracal Agricultural Research Station and OLT County Department of Agriculture.

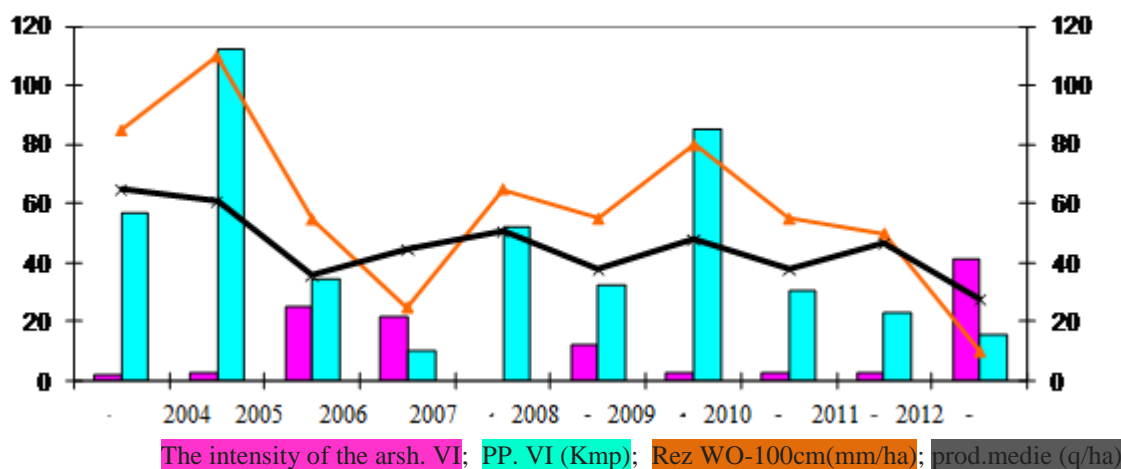
Combined action of agro-meteorological parameters of thermal and hydric stress, respectively days with maximum temperatures in air that exceed the biological critical threshold of 32 ° C of wheat plants associated with absent or insufficient rainfall (<10 l/mp/month) determines the significant decrease Of the soil water reserves up to values that characterize the occurrence of pedological drought with varying degrees of intensity, the annual variability and the decrease of crops being in evident correlation with the evolution of the climate (fig.1).

Reference data/figure 1: Extreme/drought-free agricultural years are highlighted:

2004-2012:

- the intensity of "heat": VI = 25,3 units of heat;
- Precipitations: VI = 34.3 (l/mp);
- Soil water reserve/0-100 cm: VI = 54.8 mm/ha;
- Medium production: 85: 36.0 q/ha

Figure 1. Influence of thermal and hydro stress conditions on wheat yields.



\*Source: Author

The combined and sustained action of agrometeorological stress and corrosion parameters in maize, respectively, the days with maximum air temperatures exceeding the critical biological threshold

associated with insufficient rainfall (<10l/mp/month) caused a significant decrease of the reserves Water from soil to values that characterize the occurrence of pedological drought with varying degrees of intensity, the level of crops thus being in evident correlation with their evolution and duration (figure 2). Reference data/figure 2, which highlights agricultural years of excessive drought:

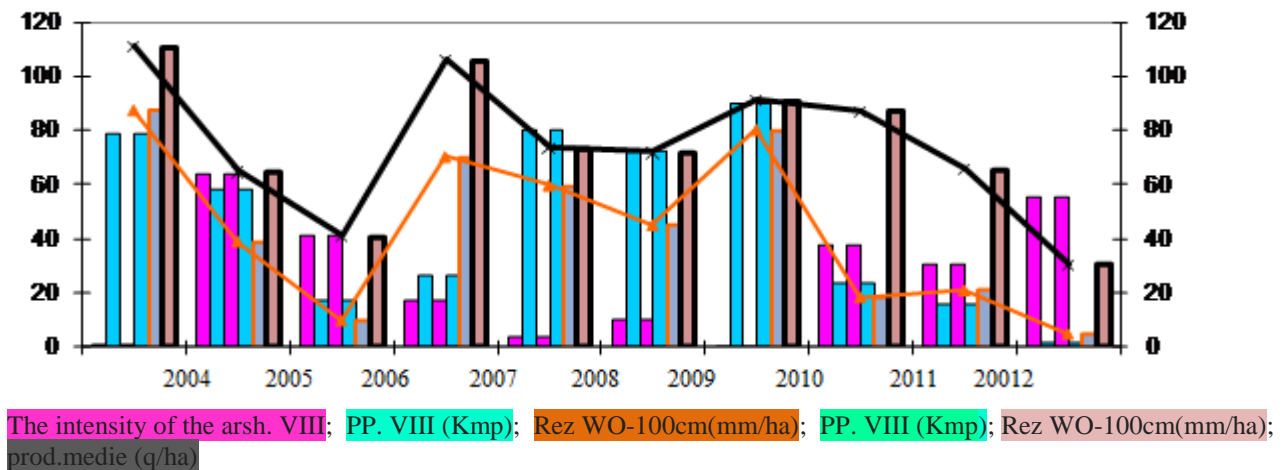
2006:

- the intensity of the "heat": VII = 46.1 units of heat; VIII = 41.2 units of heat
- precipitation: VII = 6.7 l/mp; VIII = 16.8 l/mp;
- soil water reserve/0-100 cm: VII = 25.0 mm/ha; VIII = 10.0 mm/ha;
- average yield/F 376: 40.8 q/ha

2012:

- intensity of "heat": VII = 78,4 units of heat; VIII = 55.4 units of heat;
- precipitation: VII = 26.1 l/ mp; VII = 1.3 l/mp;
- soil water reserve/0-100 cm: VII = 10.0 mm/ha; VIII = 5.0 mm/ha;
- average yield/F 376: 30.3 q/ha.

Figure 2. Influence of thermal and water stress conditions on maize yields



\*Source: Author

## Conclusions

The amount of precipitation and its distribution on months and critical vegetation intervals varies from year to year compared to the optimum limits specific to each month, season or agricultural year as a whole, significant negative deviations from them leading to unfavorable conditions for growth and development Plants during vegetation;

The frequency of droughts, giving the agricultural area a dry climate, which requires an increased attention in the choice of autumn wheat varieties, and in the crop technology, the adaptation of the agro-technical measures specific to these conditions, namely the sowing, density, cropping, fertilization, and so on

In the period with maximum requirements of maize plants relative to the temperature factor (july-august), the production of the thermal stress quantified by the phenomenon of "heat" varies in intensity and duration, being differentiated from one year to the next, these cases being considered Extreme thermal risk situations with complex consequences on the state of vegetation and the productivity of crop plants;

The combined action of the heat stress factors ("arsita") and hydric (moisture deficiencies) in july-august, with maximum requirements of maize plants relative to the temperature and humidity resources, respectively the intensity and duration of the phenomenon of "heat" , The amount and distribution of precipitation and the degree of water supply of soils is reflected significantly in vegetation and production levels, depending on the extreme characteristics and prevalence of

intensity, duration, mode of action and persistence of limiting stress factors, drought-specific indicators agricultural;

The results of the research in the Caracal area can be considered significant for the entire southern area of the Romanian Plain through both the approach of the agricultural drought phenomenon and the adaptation of agricultural measures and practices to the risk situations due to this dangerous phenomenon for agriculture.

### **References**

- Barrett M.E., (1999). Complying with the Edwards Aquifer rules: technical guidance on best management practices / prepared for Field Operations Division; Austin; TX. Texas Natural Resource Conservation Commission 1: RG-348 (variously paged).
- Berbecel O., Ciovică N., Eftimescu M., Mihoc, C., (1980). Considerations on the Use of Climate Resources in Agriculture; Terra Magazine; no. 1.
- Denmead O.T., Shaw, R.H. (1960). The effects of soil moisture stress on different stages of corn growth on the development and yield of corn; Agron J. 52; p. 272-274.
- Iagăru Gh. V., Mateescu E., (2001). The climatic conditions of the agricultural year 1999-2000 with repercussions on field crop production in Olt County; Annual Scientific Session - ICCPT Fundulea; Bucharest; May 10; 2001.
- Ionescu Sisești Gh., (1947). Agrotehnica; Cartea Românească Publishing House; Bucharest.
- Pandia Olimpia., (2006). Research on the effect of fertilizers on production and quality in liver; Thesis; USAMVB Timișoara.
- Ion Sărăcin, Olimpia Pandia, Marin Gheorghe (2013). The result of unsuitable farming practices on the quality of sandy soil on South Oltenia; ProEnvironment / ProMedium 6, BioFlux, pp. 459-462, Cluj Napoca, ISSN 2066-1363.
- \*CERES (Crop-Environment Resource Synthesis).
- \*IBSNAT (International Benchmark Sites Network For Agrotechnology Transfer).

## **MECHANICAL SOWING OF SMALL AND VERY SMALL SEEDS (IN ALVEOLI)**

Sărăcin ION<sup>\*1</sup>, Pandia OLIMPIA<sup>2</sup>, Sărăcin IOAN ALEXANDRU<sup>3</sup>

<sup>1</sup> University of Craiova Romania

<sup>2</sup> University of Agricultural Sciences and Veterinary Medicine Bucharest Romania

<sup>3</sup> Polytechnic University of Bucharest Romania

\*Corresponding author: ion\_saracin@yahoo.com

### **Abstract**

The paper presents how to make an equipment for sowing small seed drill, how to use it and the advantages of using it. The equipment consists of the following: cylinder with pressure chamber and piston, vacuum generator, nozzle distribution ramp and other auxiliary components. The small and very small dimensions of some seeds require a small sowing depth and a distance between seeds to ensure germination and vegetative space after emergence. Typically, these seeds are sown in hand-drawn gutters through scattering. Thus the depth of sowing and the distance between the seeds could not be ensured, and after sunrise it is necessary to replace the work, also by doing that it increases the quantity of seeds per unit area, increases the seed expenses and at the same time it requires a high consumption of labor. To ensure very low seed sowing and seed spacing to minimize seed consumption and minimize labor costs to increase productivity to ensure maximum seed growth and seed growth after emergence, small and very small seed equipment have been developed to ensure that the seeds are placed at the depth technologically set and also at the technological distance, safe and fast. With its simple construction, the equipment has a low price, is easy to make and use, does not require the user's training and even adapts to automate the sowing process.

**Keywords:** *sowing, equipment, seeds, depth, distance*

### **Introduction**

The sowing of the small seeds in the seedlings requires the amount of manual force required to carry out the work, the amount of seed used on the surface unit is high, the expenditure is very high, the growing space of the plums is not ensured, the unevenness of sowing and emergence is also high.

The use of the equipment proposed for sowing small seeds in seedlings reduces the amount of manual force required to carry out the work, decreases the amount of seed per unit area, eliminates the performance of works, thus reducing the costs of obtaining the seedlings [Oprean A., 1982; Saracin I., 2009].

The depth of sowing and uniformity of plant growth is also ensured. Equipment is made using plastic materials or components of existing installations and appliances that can be reused.

Experimental studies and trials on production indices, consumption norms, degree of emergence and percentage of plants suitable for planting will continue. On the basis of the rules on influence factors to achieve optimal density, it is possible to determine by crop species, by crop schemes, production implications that ultimately express productivity [Hulea A., 1962; Navid, H., 2011].

The observance of the quality indices of the sowing works contributes to the increase of the agricultural productions both qualitatively and quantitatively. To ensure seed quality, the following requirements must be met:

- compliance with sowing rules;
- Incorporation of seeds at the established depth;
- Ensure optimal sowing density by observing uniform line spacing and seed distribution uniformity.

With the aim of making the sowing density as rigorous and easier as possible, it is proposed to establish a new method of assessing the uniformity of sowing, which can also be used for small seed sown in frequent rows.

### **Material and Methods**

The studies carried out in order to develop equipment that could be used to set up specific crops from small seeds, forestry, floriculture and vegetable species started and takes place in the mechanization laboratories of the Faculty of Horticulture and Agriculture Craiova [Saracin I., 2002 -2004; Scripnic V., Babiciu P., 1979].

To this end, some of the methods used for the sowing of small seeds, whether manual or mechanized, have been studied in the country and abroad (Figure 1); [Valentin D.C., 2012].



Figure 1. Sowing in gutters by hand



Figure 2. First equipment for seed drilling with seed

For the beginning, some characteristics of the seeds of the forest, floricultural and vegetable species have been studied, shown in the figure below.

The documentation and studies also took into account the following:

- Possibility of sowing directly in the alveoli;
- Successive sowing in several alveoli at the same time;
- Possibilities of adjusting the depth of sowing; [Saracin I., Olimpia Pandia., 2010];
- Possibilities to automate the process of sowing small seeds in the alveoli [Valentin D.C., 2012].

On the basis of the rules on influence factors in achieving optimal densities, production indices which ultimately express productivity can be established by species, by crop type, by crop schemes. Research and experimentation on production indices, consumption standards, will continue. [Saracin I., Olimpia Pandia., 2010; Saracin I., 2002 -2004].

As a result of recent research results, seed consumption norms for seedlings must be established in relation to the average soil emergence index, germination determined in the laboratory, plant maintenance index and percentage Of suitable plants.

The sowing rule can be calculated as follows:

A) Sowing standard in number of seeds per linear gauge, after relation (1):



$$N = i * \frac{100}{R} * \frac{100}{M} * \frac{100}{A} = I * \frac{1.000.000}{R * M * A} \quad \text{seeds/m} \quad (1)$$

or:

$$N = \frac{I}{L} * \frac{1.000.000}{R * M * A} \quad / \text{ seeds / m} \quad (2)$$

in which:

N = sowing standard, number of seeds or number of seeds to be sown per meter / m<sup>3</sup> / m;

I = production index per gully meter, / buc / m;

R = the index of emergence; %

G = the technical germination or germination potency indicated in the analysis bulletin %;

M = plant maintenance index;

A = percentage of plants fit for planting. %

b) Sowing standard in grams of grain per meter, after the relationship (2):

$$q = n * \frac{G1000}{1000} * \frac{100}{P} = n * \frac{G1000}{10 * P} \quad / \text{ g/m} \quad (3)$$

and / or

$$q = \frac{I}{L} * \frac{1.000.000}{R * M * A} * \frac{G1000}{10 * P} = I * \frac{1.000.000 * G1000}{R * M * A * P} \quad / \text{ g/m} \quad (4)$$

in which:

q = consumption standard (sowing rule) in grams of grain or grain quantity to be sown on the linear meter;

G 1000 = the weight of 1000 seeds, indicated in the analysis bulletins, also indicating the average number of seeds per kilogram - NK;

P = seed purity [%], in the analysis bulletins.

### Method of research

The computer application developed in Mathcad determines the number of seeds on a surface converting that image into a binary number system by means of specific mathematical formulas. [Valentin D.C., 2012].

To achieve the uniformity of distribution of a surface sown under laboratory conditions, three distinct steps will be taken:

- calibration of the measuring system;
- collecting experimental data;
- data processing using the computing technique.

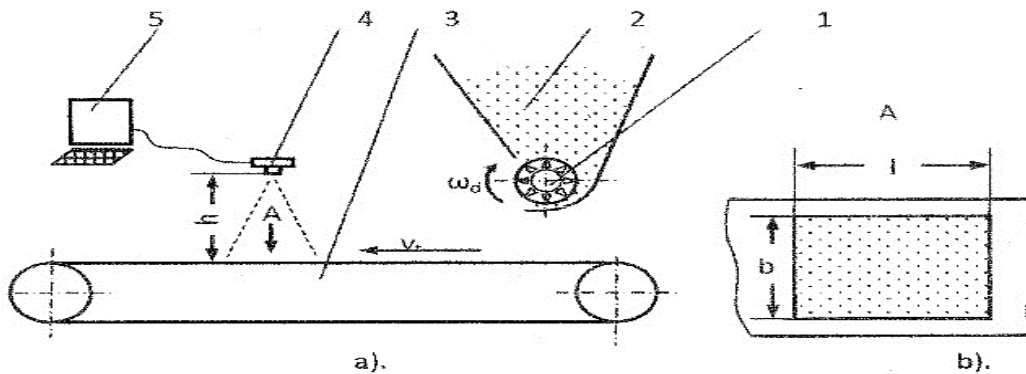


Figure 3. Stand for determining seed distribution uniformity:  
a-side view; b-front view

The test stand of the distribution apparatus (Figure 3) consists of:

- A. The seed box (1) and the dispensing device (2) driven in rotation with an electric motor ( $\omega$ -adjustable);
  - B. The seed collection system materialized by the belt conveyor (3), simulating the linear movement of the seed drill ( $v_t$  - adjustable). The adherent surface of the conveyor belt secures seeding to its surface;
  - C. The WEB camera (4) captures the images at a predetermined frequency according to the speed  $v_t$  and the angular velocity of the distribution device  $\omega$  to avoid overlapping the images. The computing system (5) is used for image storage and experimental data processing.
- Calibration of the measurement system consists in determining the position of the WEB camera relative to the conveyor belt through tests. The height  $h$  is set so that the width  $b$  of the image is equal to the distance between the seed rows  $b$ .

### Results and Discussion

Made of a 35mm diameter cylinder, fitted with a rod-shaped piston that seals the cylinder and pa that divides it into two chambers. The upper chamber called the atmospheric pressure chamber and the lower chamber called the depression chamber. The atmospheric chamber is connected to the atmosphere through a hole which can be closed or opened by the piston that moves inside the cylinder. The depression chamber is in relation to A vacuum generator and can be closed or opened by the same piston, but also with the distribution ramp of the apparatus.

The distribution ramp is the part of the apparatus provided with nozzles of different diameters depending on the smallest size of the seed to be sown. The nozzle diameter of the nozzle is about 0.7 of the smallest seed size.

The number of nozzles on the ramp is equal to the number of alveoli on the sowing tray. The nozzles may be provided with one or more apertures depending on the need of the culture to be set up. Also, the nozzle support rod allows movement of the nozzles to Adjusting the distance between them, depending on the size of the alveole.

In the lower part of the cylinder is mounted a plastic limiter that serves the user to adjust the depth of sowing.

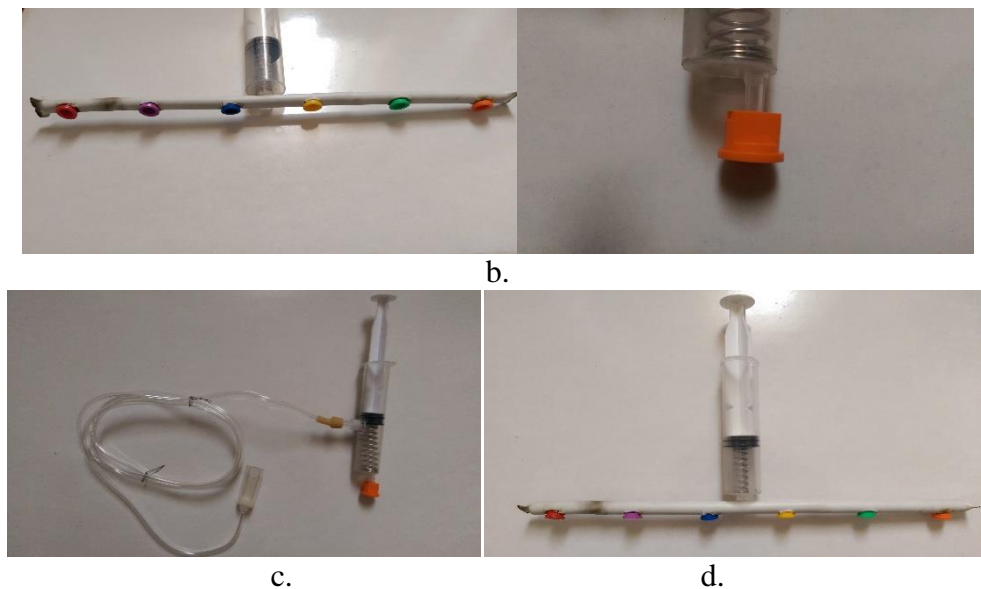
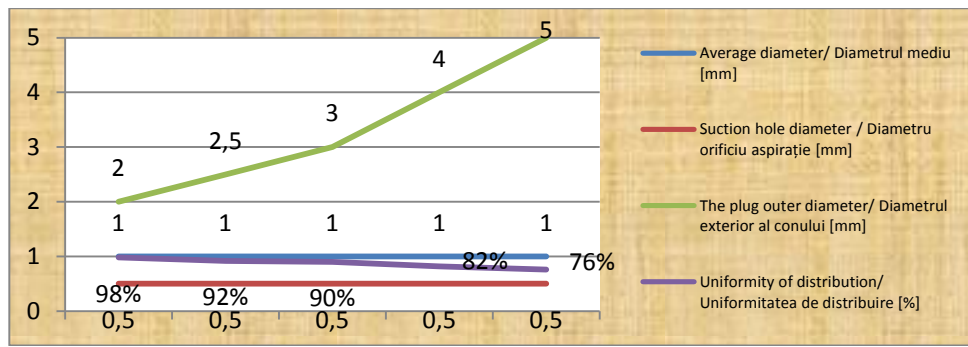


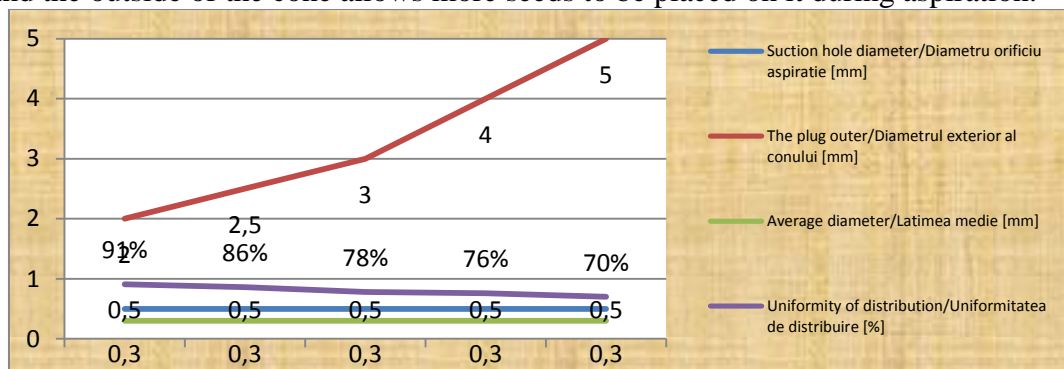
Figure 4. Sowing equipment in alveoli, a and d with multiple distributor, b and c mono distributor. The results obtained in the laboratory regarding the distribution uniformity for the saplings of eggplant, eggplant and tobacco are presented in the graphs of figures 5, 6 and 7:



\*Source: Elaboration by the author

Figure 5. Uniformity of distribution for small sprouts with 1 mm diameter diameter and 0.5 mm suction hole diameter

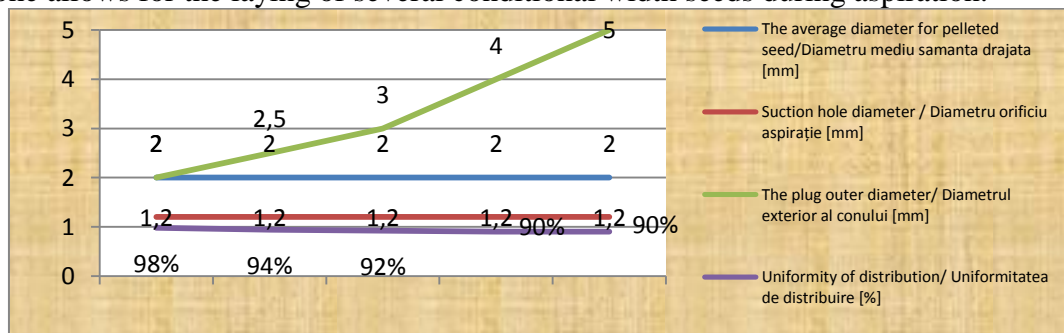
From the graph shown in Figure 5, it is noted that the seed distribution uniformity decreases with the increase in the outer diameter of the cone. Probably due to the fact that the surface between the orifice and the outside of the cone allows more seeds to be placed on it during aspiration.



\*Source: Elaboration by the author

Figure 6. Distribution uniformity for small eggplants with an average diameter of 1 mm and a suction hole diameter of 0,5 mm

From the graph shown in figure 6, it is noted that the seed distribution uniformity decreases as the cone's outer diameter increases. Probably the resulting surface between the orifice and the outside of the cone allows for the laying of several conditional width seeds during aspiration.



\*Source: Elaboration by the author

Figure 7. Distribution uniformity for small-sized tobacco seeds with average diameter of 1 mm and inlet diameter of 0.5 mm

From the graph shown in figure 7, it is noted that the seed distribution uniformity decreases with the increase in the outer diameter of the cone. Perhaps by dragging, the outer diameter of the seeds increases, and the surface between the cone and the orifice does not allow the seed to settle more during the aspiration.

## Conclusions

In order to achieve production clues, it is necessary to carry out the following technical instructions on the minimum required works to be executed in the pavements:

- In seed preparation: seed quality verification; Establishing sowing rules; Specifying the sowing mode; Seed preparation according to the specificity of each species;
- When sowing: the soil temperature at sowing time must be between + 9 ° C ... + 15 ° C;
- In the seed coating: seed cover with the humus and sandpot mixture; Easy application of humus after soil cover;
- The equipment can be used in small spaces, making it easy to handle and use;
- The vacuum generator can be operated either electrically or with a thermal motor;
- Depression in the plant does not require high values because of the small seed mass;
- The proposed method is recommended primarily for research under laboratory conditions;
- This can be generalized for the comparative study of the performance of different types of distribution apparatuses and for the study of the influence of functional seed parameters on the uniformity of distribution;
- The use of modern digital imaging systems and computational techniques for processing results reduces the time needed to test sowing machines;
- The method of determining the distribution uniformity developed in the paper presents the advantage of appreciating the uniformity of sowing density compared to current methods that take into account the uniformity of seed mass flow.

### **References**

- Hulea A., (1962). Contributions on art culture in nurseries of some species of exotic; Forest resinous; Magazine, nr. 9.
- Navid, H., Ebrahimian, S., Gassemzadeh, H.R., Mousavinia, M.J., (2011). Laboratory evaluation of seed metering device using image processing method; AJAE 2(1); p. 1-4.
- Oprean A., Fl. Ionescu, Al. Dorin., (1982). Hydraulic Drives, Elements and Systems; Technical Publishing House; Bucharest; pp. 205-207.
- Saracin I., Marin G., Olimpia P., Florea G. (2009). Energy base for agriculture, horticulture, forestry; Aius Printed Publishing House; Craiova.
- Saracin I., Olimpia Pandia., Netoiu Constantin., (2010). Theoretical study of achieving seeders for forestry nurseries of resinous; Annals of the University of Craiova - Agriculture, Montanology, Cadastre Series; Vol. XL / 2, p. -560.
- Saracin I., Olimpia Pandia., (2010). Sowing for Small Seeds; Annals of the University of Craiova - Agriculture, Montanology, Cadastre; Series Vol. XL / 2; pp. 561-565.
- Saracin I., (2002 -2004). Universal light seed drill for sandy soil; Contract CNCSIS, NR. 33451; Contract Director; University of Craiova.
- Scripnic V., Babiciu P., (1979). Agricultural machines; Publishing Ceres; Bucharest.
- Valentin Dan Crişan, Victor Roş, Marius Ghereş., (2012). A method for evaluation of the distribution uniformity of tribal seed; Sebeş.

## TARRAGON CULTIVARS (*ARTEMISIA DRACUNCULUS* L.) OF THE NIKITA BOTANICAL GARDENS BREEDING

Nadezhda BAKOVA, Lidiya LOGVINENKO, Oksana SHEVCHUK

Federal State Funded Institution of Sciences “The Labour Red Order Banner Order Nikita Botanical Gardens - National Scientific Centre of RAS”,

Yalta, the Crimea

\*Corresponding author: oksaana\_shevchuk1970@mail.ru

### Abstract

Tarragon or estragon (*Artemisia dracunculus* L.) is a promising food, a spicy, aromatic and medicinal crop for an industrial cultivation in the Crimea. Long-term breeding tests of the samples of a different geographical origin in the Nikita Botanical Gardens have made it possible to study the special features of development, a plant morphology, productivity, a mass fraction and a component composition of essential oils. Estragon selection was aimed at determination of high productive and high essential oil yield forms with a valuable component composition of essential oil and compact bush shape. It has been found out that raw biomass yield of the studied samples was 110-116 cwt/ha, a mass fraction of essential oil is 0.22–0.61% of fresh biomass and essential oil yield was 24.2-57.2 kg/ha. The main components of essential oil is sabinene - up to 41%, elemicin - up to 30.3%, trans- isoelemicin - up to 32.7%. The valuable components of estragon essential oil are methyl chavicol (C<sub>10</sub>H<sub>12</sub>O) and its derivatives such as methyl eugenol, elemicin, isoelemicin. Two highly efficient cultivars - “Smaragd” with a high content of essential oil promising for use in medicine as a restorative remedy and “Travneviy” that could be used in the food industry as spice, have been created. During the mass blossom the cultivar “Smaragd” plants accumulated a maximum amount of essential oil (up to 0.61% of raw biomass), the main component of essential oil is methyl chavicol mass fraction of which was up to 91%. Mass fraction of essential oil in heads was 0.8%, in leaves - 0.6%, in stems - 0.03% of raw biomass. The raw biomass productivity for “Travneviy” cultivar was 123.4 hw/hectare, mass fraction of essential oil - 0.08% of fresh biomass, essential oil yield - 10.7 kg/hectare. The main components of essential oil are sabinene (40.0%), trans-iso-elemicin - 26.1%.

**Keywords:** *Artemisia dracunculus* L., spice, essential oil, methyl chavicol, sabinene

### Introduction

Tarragon or estragon (*Artemisia dracunculus* L.) is a perennial herbaceous plant from Asteraceae family. It is native for Western Europe (except its northern part), the Caucasus, Asia Minor, Central Asia, Northern China, Mongolia and the west of North America, mostly in the floodplain meadows, virgin and saline lands in the steppe and forest steppe zones (Vulph, Nilov, 1937). It is cultivated everywhere in Europe, India, USA, Brazil (Libus et al., 2004).

Tarragon is a promising spicy-aromatic crop (Bakova, Rabotyagov, Marko, 2010). Its tender aboveground green parts can be used fresh and after some maturing for canning and pickling vegetables. It is a component of the flavoring composition for processed cheese production; water-alcohol extract of tarragon is the main component of a soft drink "Tarhun" which is a tonic drink of a high quality (Bakova, Logvinenko, 1995).

Tarragon is widely used as a carotene-containing and antiscorbutic agent in dietary nutrition. Tarragon herb stimulates secretion of a gastric juice, improves appetite, and normalizes the functions of endocrine glands. Consumed young herbaceous shoots with leaves containing up to 190 mg /% vitamin C, 15 mg /%, carotene, 170 mg /% rutin, as well as macro- and microelements:

1.9 mg /% calcium, 2.11 Mg /% magnesium, 1.32 mg /% iron, 226.5 mg /% phosphorus (Vulph, Nilov, 1937; Botanico-pharmacognostic ..., 1990; Libus et al., 2004).

In ethnoscience medicine, tarragon is considered as an effective diuretic and it is used against worms, with swelling. In Tibetan medicine estragon is recommended for the treatment of pulmonary tuberculosis, pneumonia, bronchitis. In the official medicine, the herb is used as a stimulant for the secretion of a gastric juice and bile, remedy for diuresis increasing and cure with a general strengthening effect (Logvinenko, Rabotyagov, Bakova, 1995; Bakova, Logvinenko, 1995). Estragon essential oil has an anti-inflammatory, choleric, diuretic, spasmolytic, antiparasitic, sedative, wound-healing, antiseptic, restorative, antiallergic effect (Libus and oth., 2004). It can be used in the development of phytopreparations of preventive and sanitary-hygienic trends, as well as an odor in perfume and cosmetics industry.

## Material and Methods

The objective of our research was to study development features as well as the content and component composition of the essential oil in *Artemisia dracunculus* samples of a different geographical origin under the conditions of the Southern Coast of the Crimea, either to create new cultivars.

The original plant material had been obtained from the botanical gardens of France, Germany, Austria, Czech Republic, Italy, Switzerland, Hungary, Poland, Belarus, Armenia, England, and also collected during the scientific expeditions in the Crimea and the Caucasus. The subjects of the study were 13 samples; each of them was represented by at least 10 plants.

Introductory and breeding studies were carried out on the experimental plots of aromatic and medicinal plants collection in the Nikita Botanical Gardens using common methods and methodological developments (Introduction .., 2009). An organoleptic testing of the essential oil was carried out on 5-point scale (Introduction .., 2009). The mass fraction of the essential oil was determined by a hydrodistillation method from a fresh raw biomass. (Ermakov, 1962). The essential oil composition was tested on Agilent Technology 6890N chromatograph with 5973N mass spectroscopy detector (Jennings, Shibamoto, 1980).

The promising varieties were isolated by the method of a positive individual selection. Breeding was aimed at creation a high-yield cultivars with high quality of the essential oil and suitability for harvesting machine.

The Southern Coast of the Crimea is a region with a dry subtropical climate and well-preserved elements of the Mediterranean landscape. Average annual temperature is 12-15°C, the absolute minimum in winter is 7-10°C, the maximum in summer is 36-38°C. Average daily temperature transition of 5°C occurs in the first-second decade of March, and temperature transition below 5°C – is in early December. Periods with stable average daily air temperatures below 0°C are rare. Precipitation amount is up to 560 mm (Fursa, Fursa, 1992). The soil type is brown carbonate, medium-humus, powerful, light-clay (Soils .., 1963).

## Results and Discussion

Under the conditions of the Southern Coast of the Crimea, tarragon is a perennial herbaceous plant up to 120 cm height, with a lignified, well-developed rhizome located in the upper soil layers. Stems are erect, pubescent, ribbed, lignified at their lower part, highly branching. Branches are of medium length, pinned to the stem, the average number of the first order branches is 8-10 ones. Leaves are slightly pubescent, linear-lanceolate: in the middle and upper parts of the stem they are whole, in a lower part - two-threelfold. Flowers are yellow combined in numerous small spherical heads organized in narrow-clustered inflorescences, the length of which is up to 6 cm, the number of heads per the inflorescence is up to 50 ones, the number of inflorescences of a single plant is 2-3 ones. Fruit is an oblong seed. Seeds are small, compact, obovate, light brown in color. In contrast to the other wormwood species, tarragon is completely devoid of bitterness. This low temperature-

resistant plant is characterized by resistance to diseases and pests (Mashanov, Logvinenko, 1991). The studied samples form bushes of various shapes: a spread bush (diameter 80-90 cm), compressed (diameter 25-30 cm) and pyramidal ones (diameter 60-70 cm) (Bakova, 1997). Beginning of vegetation in plants of all the studied samples occurs during the first decade of March. The period of flower budding is short - from 12<sup>th</sup> to 26<sup>th</sup> June. The phase of a mass blossom is observed from July 9<sup>th</sup> to August 21<sup>st</sup>. A large range in the terms of the mass blossom phase start in different tarragon forms is associated with their individual characteristics. The longest flowering period is 45 days, the shortest - 36 days. An average period of vegetation of estragon was 164 days, the maximum - 169 days, the minimum - 147 days. The terms of seed ripening did not differ significantly. The weight of 1,000 seeds was 0.18-0.22 g. The seeds retain their germination capacity for 1-2 years. The essential oil is produced in the aboveground parts of estragon plants. The aboveground parts of the plants are used as the raw biomass and harvested during the period of a mass blossom. The yield of a plant raw biomass in the studied samples varied within 39.6-166.6 hw/hectare. In the most productive samples, the raw biomass yield was 110-166 hw/hectare (table). A produced essential oil is a colorless or yellow-green liquid with a peculiar aroma. The density  $d_{15}^{\circ}$  is 0.900-0.945, the refractive index is 1.504-1.526, the acid number is up to 1; ether number is 1-9; ether number after acetylation 15-22; soluble in 6-11 volumes of 80% alcohol with a slight turbidity, as well as in 0.6-1.5 volumes of 90% alcohol. The mass fraction of essential oil in the aboveground biomass of the studied samples varies from 0.12 to 0.61% of a fresh biomass. The smell of the essential oil is fragrant and it is determined by its main ingredients. Organoleptic evaluation allowed identifying the following flavor trends: sagebrush, carrot, cineol borneol, ginseng, eugenol, methyl eugenol, methyl chavicol (estragole) and bitter grapefruit. The taste is burning. The main components of the estragon essential oil were methyl havicol (estragole), elemicin, trans-isoelemicin, sabinene, myrcene, octanone-3, linalool, caryophyllene. Cis-ocimene, trans-ocimene, phellandrene, nerol, 1,8-cineole, myrcene, eugenol and other compounds were also presented in the oil (Grebennikova and oth., 2014). Tarragon essential oils differ in combination of methoxylated forms of methyl chavicol - methyl eugenol, elemicin, sabinene, etc. There are several basic tarragon varieties, which differ in chemical composition of essential oil and its yield - Russian (Caucasian), German, French, English, Japanese (Wormwood tarragon). The original tarragon contains 80-90% methyl chavicol (1-methoxy-4-allylbenzene) and some of its forms accumulate methyl eugenol (1,2-dimethoxy-4-allylbenzene) or its methyl iso-eugenol isomer. The other forms of original tarragon contain elemicin (1,2,6-trimethoxy-4-allylbenzene) and isomer isoelemicin. There is a known tarragon chemotype containing a significant amount (up to 35%) of the methyl chavicol isomer anethole (1-methoxy-4-propenylbenzene) (Wormwood tarragon). In the essential oil of the tested samples, the content of the main components has a wide range of variability. Thus, concentration of methyl chavicol ranges from 0.23 to 90.98%, elemicin - from 4.43 to 30.35%, methyl eugenol - from 0.49 to 70.53, isoelemicin - from 17.45 to 29.26%, sabinene - from 6 to 40%, which suggests that all variants of metaxylated forms of methyl chavicol are presented (table). The following chemotypes have been determined: methyl chavicol, methyl eugenol, elemicin and sabinene. The criteria for breeding improvement of tarragon are the raw biomass yield, the essential oil yield, essential oil component composition and possibility for its industrial cultivation (Rabotyagov et al., 2007; Logvinenko, Logvinenko, Bakova, 2008). The suitability for industrial cultivation is determined by the compact bush shape and shoots attachment to the main stem high above ground. Based on the analysis of all the studied samples according to these criteria two promising samples have been selected: № 98086 – cultivar "Smaragd" is characterized by a high yield of methyl chavicol essential oil, and № 33188 - "Travneviy" - with high aerial biomass yield, essential oil of sabinene chemotype and clove-muscat aroma (Rabotyagov et al., 2007; Rabotyagov et al., 2011). Their full description is presented.

Table. Morphological and economically valuable features of *Artemisia dracunculus* L. samples

The introductory number and origin of the sample	Morphological features	Productivity, (hw/hectare)	Mass fraction of essential oil, % of fresh weight	Essential oil yield, kg/ha	Aroma, organoleptic evaluation (points)	The main components of essential oil,%
<b>Methyl chavicol chemotype</b>						
98086 Armenia	height 72±6,5 cm, compact bush, diam. 27±3 cm, scions attached to the stem high above ground	94.9	0.61	57.2	mint-chavicol, 5	<b>methy chavicol – 90.98;</b> trans- ocimene – 8.87; cis-ocimene - 7.78; linalool – 0.29; methyl eugenol – 0.49; limonene - 4.3
<b>Methyl eugenol chemotype</b>						
131187 France	height 100±7,8 cm, spread bush, diam. 78±9 cm, scions attached to the stem low	126.6	0.23	28.5	methyl eugenol, 5	<b>methy eugenol – 70.53;</b> methyl chavicol – 16.48; linalool - 0.36; isoelemicin - 17.45
45992 Austria	height 90±4,8 cm, compact bush, diam. 23±2,3 cm, scions attached to the stem high above ground	110.6	0.25	27.7	methyl eugenol, 5	<b>methy eugenol – 57.51;</b> elemicin – 17.45; linalool – 0.27; methyl chavicol – 0.77; sabinene – 1.43
<b>Sabinene chemotype</b>						
33188 Caucasus	height - 105±10 cm, pyramidal bush, diam. 84.5±2 cm; scions attached to the stem high above ground	166.6	0.25	41.65	eugenol, 5	<b>sabinen – 40.09; trans-iso-elemicin – 26.1;</b> methyleugenol – 1.34; linalool – 0.91; methyl-havicol – 0.23; elemicin – 4.43;
90888 France	height - 87±10 cm, compact bush, diam. 25±6.3 cm; scions attached to the stem high above ground	54.1	0,55	29,75	cineol-borneol, 4	<b>sabinene – 41.1; elemicin – 30.3;</b> methyl chavicol – 0.44; methyl eugenol – 2.54; linalool- 1.32
<b>Elemicin chemotype</b>						
33288 Crimea	height - 112±6,3 cm, compact bush diam. 46.4+2.3 cm, scions attached to the stem high above ground	166.6	0.05	8.33	bitter grapefruit, 5	<b>elemicin – 32.8;</b> sabinene – 16.9; linalool – 0.57; methyl chavicol – 0.64; methyl eugenol -7.6
80588 England	height - 93±6.3 cm, pyramidal bush, diam. 69.5±1.3 cm, scions are attached to the stem low	83.3	0.12	9.99	eugenol, 5	<b>elemicin – 47.23;</b> methyl eugenol – 16.78; isoelemicin – 13.76; sabinene – 6.45



**Cultivar 'Smaragd'** – the bush 70-78 cm height, compressed in a shape, the bush diameter is 50-56 cm. The straight stems are densely leafy. The lower leaves are mainly tripartite, the upper are linear-lanceolate, bare, up to the flower budding stage soft and tender, at the beginning of blossom become stiff. Yellowish flowers collected in spherical small heads in their turn organized in narrow-clustered inflorescences. Seeds are small, brown, flat. The mass of 1000 seeds is 0.2 g. Vegetation is 150-160 days. Mass blossom occurs in the second decade of July, the harvest period is 20 days. The cultivar is propagated vegetative (bush fragmentation) and with seeds. It grows well on flat, open areas with loose, fertile soils.

During the period of a mass blossom, the plants of this cultivar accumulate the maximum amount of essential oil (up to 0.61% of fresh biomass), the main component of the essential oil is methyl chavicol, its content is up to 91%. A mass fraction of the essential oil in flower heads is 0.8%, in leaves – 0.6%, in stems 0.03% of fresh weight. Accordingly, the raw biomass for producing essential oil is the aboveground parts (stems, leaves and inflorescences) cut at 15-20 cm height above the ground. This cultivar is promising as an essential oil crop for use in the pharmaceutical and perfumery-cosmetic industries.

**Cultivar 'Travnevy'** is 110-115 cm height, the bush is pyramidal erect, 84-86 cm in diameter. The stems are densely leafy, the stem thickness is 0.9 cm. The leaves are slightly pubescent, linear-lanceolate: in the middle and upper stem parts are entire, in the basal stem part - 2-3-parted. The flowers are yellow in numerous small spherical heads collected in narrow-clustered inflorescences, the inflorescence length is 5.7 cm, the number of heads in the inflorescence is 49-50 ones. The beginning of blossom was noted in the second decade of July, mass blossom - in the first decade of August. Fruiting is in September - October. The seeds are small, flat, ovate, brown. Vegetation is 169 days. It grows well on flat, open areas with loose, fertile soils, drought-resistant.

The raw biomass yield is 123.4 hw/hectare, the mass fraction of essential oil is 0.08% of fresh biomass. Raw biomass is harvested at the beginning of blossom. The main component of the essential oil is sabinene - 40.0% and trans-iso-elemicin - 26.1%. The cultivar is promising for use as food and canning spice with nutmeg aroma (Patent, 1998).

For preservation of the special cultivar characteristics, a vegetative propagation (bush fragmentation) from the third life's year, in early spring or in autumn, after the harvesting, is suggested. Essential oil and raw biomass of the created tarragon cultivars conforms to the requirements of international standards (ISO 7926: 1991).

### **Conclusions**

The complex studies of estragon samples from the collection of aromatic and medicinal plants of the Nikita Botanical Gardens demonstrated that in the conditions of the Southern coast of the Crimea productivity of the studied samples raw biomass was 39.6-166.6 hw/hectare and the mass fraction of essential oil in the aerial parts was 0, 12-0.61% of fresh biomass.

The Samples of methyl chavicol, methyl eugenol, elemicin, and sabinene chemotypes are presented in the collection. Two new cultivars have been created: cultivar 'Smaragd' characterized with a high content of methyl chavicol chemotype essential oil for use in the pharmaceutical and cosmetic industries, and cultivar 'Travnevy' - a high-yield, drought-resistant, of spicy-aromatic trend with essential oil of the sabinene chemotype.

## References

- Bakova N.N., Logvinenko I.E. (1995). Introduction of spicy-aromatic plants in the south of Ukraine, promising for beverages flavoring. Conference 'Acclimatization Features of perennial introducents accumulating biologically active substances'. Krasnodar. Russia.
- Bakova N.N., Logvinenko I.E. (1995). Studies of spicy-aromatic plants as therapeutic and prophylactic remedies. Conference «Scientific achievements and problems of medicines production», 20-22th September, Kharhov, Ukraine.
- Bakova N.N. (1997). Ontogenesis features and characteristics of morphological features in various tarragon forms under conditions of introduction. Fourth International Conference on Medical Botany. Kiev. Ukraine.
- Bakova N.N., Rabotyagov V.D. Marko N.V. (2010). Spicy-aromatic plants from the collection of Nikita Botanical Gardens for the market of natural spices in Ukraine. International scientific conference to the 75th anniversary of National Botanical Garden named after M.M. Grishko Nat. Acad. Sci. of Ukraine foundation "The introduction of plants, conservation and enrichment of biodiversity in botanical gardens and dendroparks". 15-17th September. Kiev. Ukraine.
- Botany-pharmacognostic dictionary (1990). Vyshaya shkola. Moscow.
- Ermakov A.I. (1962). Methods of biochemical plants researches. Moscow - Leningrad.
- Fursa D.I., Fursa V.P. (1992). Agroclimatic characteristics of the district of Nikita Botanical Gardens agrometeorostation. Minsk. Belarussia.
- Introduction and breeding of aromatic and medicinal crops. Methods and methodological aspects (2009). Yalta. Ukraine.
- ISO 7926:1991 Dehydrated tarragon (*Artemisia dracunculus* Linnaeus. Specification.
- Jennings W., Shibamoto T. (1980). Qualitative analysis of Flavor and Volatiles by Glass Capillary Gas Chromatography. Academic Press rapid Manuscript Reproduction.
- Grebennikova O.A., Paliy A.E., Logvinenko L.A., Rabotyagov V.D. (2014). The content of volatile substances in water-ethanol extracts of *Artemisia dracunculus* L. Bulletin of Nikita Botanical Gardens. Vol. 110. pp. 50-54.
- Libus O.K., Rabotyagov V.D., Kutko S.P., Hlupenko L.A. (2004). Essential oil and spicy-aromatic plants. Aylant, Kherson, Ukraine.
- Logvinenko I.E., Rabotyagov V.D., Bakova N.N. (1995). New medicinal plants for medicine. Conference «Scientific achievements and problems of medicines production». 20-22th September, Kharhov. Ukraine.
- Logvinenko I.E., Logvinenko L.A., Bakova N.N. (2008). *Artemisia dracunculus* L. breeding in Nikita Botanical Gardens. II Open Congress of Phytobiologists of Kherson region. 15th May, Kherson. Ukraine.
- Mashanov V.I., Logvinenko I.E. (1991). Biological base of the lemon wormwood culture. Guidelines. Simpheropol. Ukraine.
- Rabotyagov V.D., Logvinenko I.E., Hlupenko L.A., Logvinenko L.O. (2007). New cultivars of aromatic and medicinal plants bred in Nikita Botanical Gardens. Tavria Scientific Bulletin. Vol.52 (1). pp. 60-63.
- Rabotyagov V.D., Hlupenko L.A., Bakova N.N., Mashanov V.I. (2007). Annotated catalog of species and cultivars of essential oil, spicy-aromatic and food plants from Nikita Botanical Garden collection. Nikita Botanical Garden, Yalta. Ukraine.
- Rabotyagov V.D., Hlupenko L.A., Svidenko L.V., Logvinenko I.E., Logvinenko L.A. (2011). New cultivars of aromatic and medicinal plants bred in Nikita Botanical Gardens. Proceedings of Nikita Botanical Gardens. Vol. 133. pp. 5-17.
- Soils of Nikita Botanical Gardens and activities for their rational use (1963). Yalta, Crimea.
- Tarragon (*Artemisia dracunculus* L.) // [http://viness.narod.ru/art\\_drac.htm](http://viness.narod.ru/art_drac.htm)

Patent UA 20272 A 04.03.97 (1998). Spices composition for meat products. Vojcekhovskaya L.U., Eresko G.A., Bakova N.N., Rabotyagov V.D., Starchevoj A.M., Zemlyakova V.G. Vulph E.V., Nilov V.I. (1937). Essential oil plants, their culture and essential oils. Vol.3. Leningrad.

## BIOTECHNOLOGICAL APPROACHES FOR BREEDING PROGRAMS IN VEGETABLE CROPS

Elena DOMBLIDES\*, Nataliya SHMYKOVA, Daria SHUMILINA, Tatiayana ZAYACHKOVSKAYA, Tatiayana VJURTTs, Elena V. KOZAR, Ljudmila KAN, Valeriy ROMANOV, Arthur DOMBLIDES\*, Victor PIVOVAROV, Alexey SOLDATENKO

All-Russian Research Institute of Vegetable Breeding and Seed Production (FGBNU VNISSOK), Federal Agency of Scientific Organizations, Moscow region, Russia

\*Corresponding author: arthurdom@inbox.ru, edomblides@mail.ru

### Abstract

The plant cell and tissue culture *in vitro* is the one of promising approaches for modern breeding programs in vegetable crops. The double haploid lines (DH-lines) were produced thought isolated microspores in species of Brassicaceae, namely in Chinese cabbage, broccoli, white head cabbage, red head cabbage and kohlrabi, where the yield of embryoids was up to 40 per a flower bud. Moreover, DH-plants were produced in such species as *B. alboglabra* and *B. purpuraria* with the yield of embryoids up to 200 per a flower bud. DH-lines in different varieties and interspecific hybrids of pepper were obtained through the culture of isolated anthers and microspores with the yield of 54.5 embryoids per 100 anthers cultured. The technology of the DH-line production was optimized for different carrot breeding accessions and totally 84 embryoids per one Petri dish were obtained in culture of isolated microspores. The regenerated plants of carrot showed game to clonal variation confirmed by morphological and DNA analyses. The technology of DH-plant production from isolated unpollinated ovules and ovaries have been developed in plants of Cucurbitaceae family such as cucumber, marrow, pumpkin with the yield up to 20, 55 and 9 embryoids per an ovary respectively. Additionally, plants originated from unpollinated ovule culture were obtained in carrot, onion and red beet. As a result of breeding program realized with the use of DH-lines, hybrid F1 of kohlrabi 'Dobryniya', sweet pepper 'Nataly' and 'Gusar', and a carrot variety 'Sonata' have been released. Meristem plant culture was used to produce polyploid virus-free breeding accessions in garlic. Clonal micropropagation technique was developed to multiply plants in large quantity with male sterility in cabbage. Furthermore, the technologies of micropropagation in eggplant and sweet pepper served as basis to develop the method for embryo rescue used for production of their interspecific hybrids.

**Keywords:** *DH-plants, microspore culture, unpollinated ovary culture, micropropagation.*

### Introduction

Currently biotechnological methods of *in vitro* plant cell culture process are of applied significance in agriculture rather than just play an important role in basic research in genetics, physiology, molecular biology and plant cytology. Vegetables are important component of the population nutrition patterns. Selection charged with the task of creation of new varieties and hybrids is essential for improvement of vegetable production efficacy. The following approaches may be used for incorporation of biotechnological methods into selection process of vegetable crops: 1. Biotechnological methods accelerating production of parent material for heterotic breeding of the vegetable crops with the use of andro - or gynogenesis; 2. Clonal micropropagation to maintain sterile or self-incompatible lines and unique samples of vegetable crops and also to obtain virus-free planting material; 3. *In vitro* use of embryo

culture methods to overcome postgametic incompatibility during the processes of cross-species hybridization and induced apomixis. In this article we report our results achieved due to the use of biotechnological methods in vegetable crop breeding.

### Materials and methods

The study was carried out with breeding accessions taken from collection of All-Russian Research Institute of Vegetable Breeding and Seed Production (VNISSOK), Moscow region, Russia. The accessions of *Brassica oleracea* L. var. *alboglabra* (L. H. Bailey) Musil and *Brassica rapa* L. subsp. *chinensis* (L.) Hanelt var. *purpuraria* (L. H. Bailey) Kitam. were kindly provided from the N. I. Vavilov Institute of Plant Genetic Resources (VIR), Saint-Petersburg, Russia. Donor plants were grown in a climate chamber at 18°C around the clock, 16L8D, where L is light time and D is dark, and light intensity was 9000 lx. Plants of white head cabbage, red head cabbage, carrot and red beet were vernalized in cold room, maintained at 4-6°C under a 16h photoperiod with 5000 lx for 9 weeks. After floral differentiation and the start of generative development, plants were transferred to a climate chamber.

Bud and plant explants were sterilized for 60s in 96% ethanol, then for 5 min in a 50% aqueous solution of the “Belizna” (Russia) commercial preparation with the addition of Tween 20 (Panreac, Spain), followed by washing three times with sterile distilled water.

Anther and ovule culture: for induction of gynogenesis the sterilized carrot buds used as explants were pre-cultured on MSM medium (Masuda et al., 1981) with 0.2 mg L<sup>-1</sup> 2,4D and 0.2 mg L<sup>-1</sup> kinetin for 2-3 weeks at 25°C in darkness. Then ovules were taken out of ovaries and placed on fresh MSM medium of the same composition under light until the gynogenic calluses or/and embryoids appeared. Embryoids and parts of callus were then transferred to new tubes with MSM medium with 0.1 mg L<sup>-1</sup> kinetin for process of organogenesis. The experimental procedure for carrot anther culture, onion and red beet ovule culture was generally similar to ovule culture in carrot and Cucurbitaceae family, and performed according to the protocol previously described (Tyukavin et al., 1999; Domblides, 2016).

Microspore culture: sterile buds were placed ½ NLN medium, pH 5.8 (Lichter, 1982), with 13% sucrose and homogenized using a magnetic stirrer. The microspore suspension was filtered through a nylon filter with a mesh size of 40 microns and pelleted for 5 min using an Eppendorf 5804R centrifuge (Germany) at 125g. The pellet with microspores was resuspended in NLN medium and then centrifugation was repeated. Microspore washing was performed twice. After isolation and washing, microspores from 5 buds were placed in a Petri dish (6 cm in diameter) with 5 mL medium as mentioned above and incubated at 32°C in the dark for 1-2-3 days. Further incubation was at 25°C in the dark until embryos were formed.

The detailed protocols for the research performed were published in our articles, as cited below in the result and discussion.

### Results and discussion

Laboratory of Biotechnology was established in VNISSOK in 1987 and contributes to creation and maintenance of valuable vegetable breeding material through the use of various biotechnological methods (Fig. 1) (Shmykova, 2015). Production of DH-plants in one of the main fields of activity of our laboratory. The first double haploid plants were produced by VNISSOK laboratory of biotechnology in the anther culture of carrot (Fig. 2A) and white cabbage (Taganov, 1991; Semova, 1992). Cytology of embryogenesis in the culture of carrot anther revealed the patterns of embryoid formation from microspores; we showed that the ploidy change starts at early stages of primary embryoid formation (Tyukavin *et al.*, 1999). With the use of our method the number of embryoids formed in the carrot anther culture in

MSM medium containing 2,4D in amount of 0.2 mg/L may reach 544/100 anthers (Tyukavin, 2007). Obtained plant-regenerants demonstrated clonal gamete variability, which was verified by morphological, cytological (Fig. 2E) and molecular-genetic assays (Tyukavin, 2007; Domblides, 2017). Carrot variety Sonata was created with the use of produced DH-lines. Despite numerous studies throughout the world, which was aimed on creation of double haploids in a carrot anther culture (Andersen, 1985; Adamus, Michalik, 2003), the success in development of microspore culture technology for this important vegetable crop was achieved only during the recent years (Gorecka *et al.*, 2010; Li *et al.*, 2013).

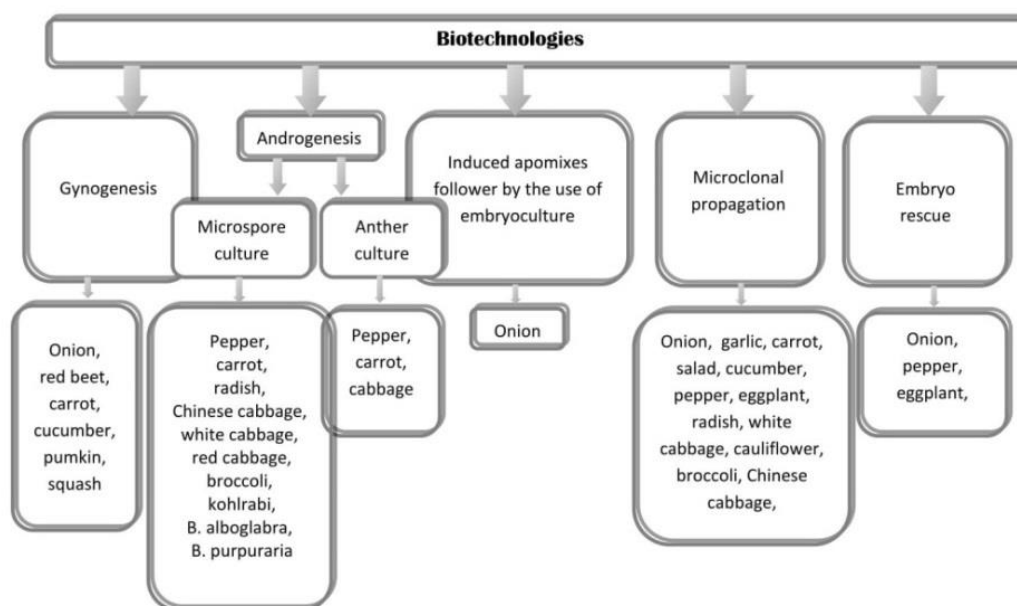


Figure 1. Biotechnological methods used in the creation of agricultural varieties in the All-Russian Research Institute of Vegetable Breeding and Seed Production (VNISSOK)

Production of DH-plants in carrot through microspore culture is also developed at our institute (Fig. 2C), and the plants-regenerants from the varieties 'Nantskaya' and 'Shantane' have been already created (Vjurts *et al.*, 2016). As a result, 84 embryoids per one Petri dish were obtained in culture of isolated microspores. The main challenge we have faced is the production of large amount of albino regenerants (Fig. 2D).

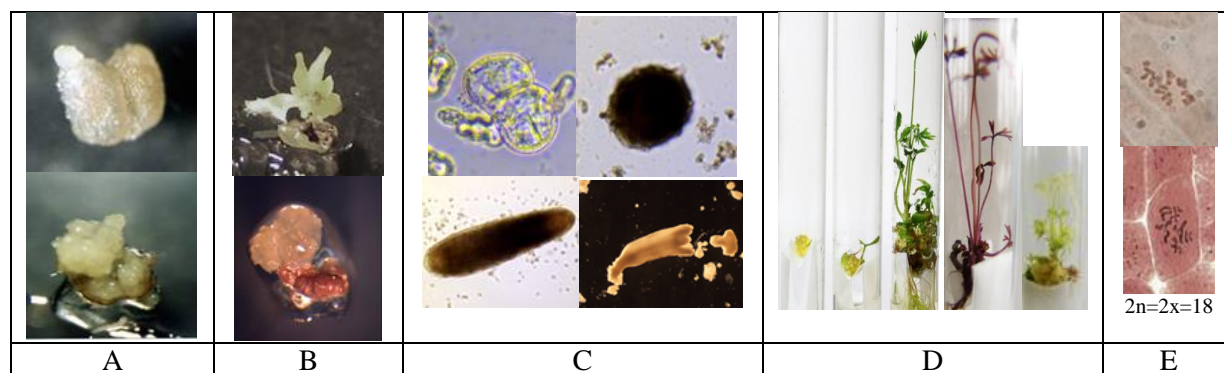


Figure 2. Obtaining carrot (*Daucus carota* L.) DH-plants in anther culture (A), unpollinated ovules (B) and microspore culture (C); regeneration plants (D); cromosomes in a root apex cell of a diploid planlet (E)

The species of Brassicaceae family are of great importance among vegetable crops, and the work aimed on optimization of production technology of double haploids in microspore culture is ongoing throughout the world (Takahata, Keller, 1991; Bhatia et al., 2016). Laboratory of Biotechnology optimized a basic protocol of rape microspore culture (Custers J.B.M. (2003), and this led to creation of double haploid lines of Chinese cabbage (Shumilina et al., 2015), broccoli, white head cabbage (Pivovarov, 2017), red head cabbage and kohlrabi, which are included into breeding process of heterosis hybrids. After the method was optimized for some genotypes the yield reached 40 embryoids per one cultivated flower bud. Hybrid kohlrabi 'Dobryniya F1' was created with the use of double haploid lines. DH-plants were produced in such species as *B. alboglabra* and *B. purpuraria* with the yield of embryoids up to 200 per a flower bud (Fig. 3).

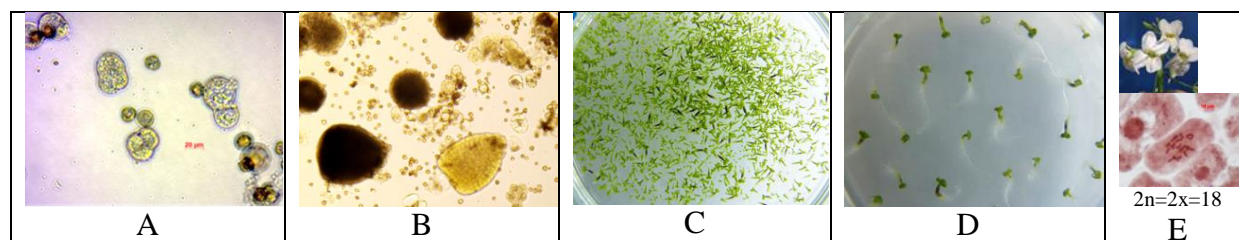


Figure 3. *Brassica oleracea* L. var. *alboglabra* (L. H. Bailey) Musil microspore culture. First division of microspore (A); embryoids after 14 days of culture (B); torpedo and cotyledonary embryoids after 21 days of culture (C); embryos after 5 days on regeneration medium (D); cromosomes in a root apex cell of a diploid plantlet (E)

Radish is considered to be one of most recalcitrant species for microspore culture among Brassicaceae crops. However, we succeed in selection of optimum nutrition medium M1 and obtained DH-lines originating from 4 varieties (Rodos, Teplichny Gribovsky, RBK, and Sonata). The yield comprised from 0.2 to 2 embryoids per 1 flower bud (Fig.4).

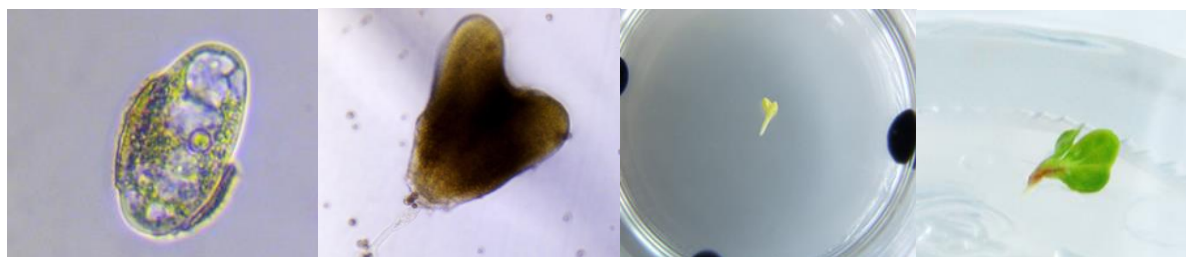


Figure 4. Microspore culture of radish (*Raphanus sativus* L.)

We developed the technology of pepper double haploid line through the anther/microspore culture by cultivation of double-layer medium (Shmykova *et al.*, 2012; Shumilina *et al.*, 2013), and created the double haploids of various pepper varieties and pepper inter-species hybrids based on this technology. This technology is up to the best foreign analogues for hot pepper (Supena, 2006; Kim, 2008). The losses in amount of haploid and double haploid pepper plants often take place at the stage of embryoid development into the seedling. For pepper species the formation of radiciform embryoid is typical, which does not develop into normal plants-regenerants. We managed to solve this problem partially through the use of gibberelic acid, which allowed to avoid rosette formation in regenerants, and through the use of benzylaminopurine for stimulation of secondary embryogenesis (Shmykova *et al.*, 2012). The hybrids of sweet pepper 'Natali F1' and 'Gusar F1' were created with the use of DH-lines. Female gametophyte can be also used for production of DH-plants. In vitro cultivation of unpollinated ovaries and ovules allows producing haploids from the plants with cytoplasmic male sterility, and when anther or microspore culture does not result in satisfactory yield (Chen *et al.*, 2011). At present haploid plants in the culture of unpollinated ovaries have been produced in vitro for more than twenty plant species and used in breeding programs of sugar beet, rice, gerbera, onion, and other plants (Mukhambetzhano, 1997). It is known that DH-plants have been produced through cultivation of unpollinated ovaries in such vegetables as onion (Bohanec *et al.*, 2002), cucumber (Gemes-Juhasz *et al.*, 2002), pumpkin (Mohamed, Refaei, 2004), marrow (Shalaby, 2007), carrot (Kielkowska, Adamus, 2010), red beet (Michalik, Baranski, 1992). VNISSOK has also participated in investigation in this field for the last 20 years. Double haploids production in the culture of unpollinated ovaries of carrot *Daucus carota* L. was one of the first developed technologies in this field (Fig 2B). Cytological study of embryo sac development under in vitro cultivation was carried out, and optimal stage for gynogenesis induction was detected (Tyukavin, Shmykova, 1996; Domblides, 2001; Tyukavin, 2007). At present this work is ongoing, and this method is successfully used on new carrot genotypes (Vjurts *et al.*, 2016). Double haploids were obtained in the culture of unpollinated ovaries of red beet, onion (Stuttgarter Riesen variety) and interspecies hybrids of *Allium* genus (Shmykova, 2006). Technology of *in vitro* production of the cucumber DH-lines in the culture of unpollinated ovaries has been developed (Shmykova, Suprunova, 2009). The use of 0.2 mg/L TDZ together with  $10^{-7}$ M epibrassinolid for gynogenesis induction allowed to enhance regeneration capacity of the ovaries. This technology was upgraded and successfully used for Cucurbita genus plants – pumpkin (Shmykova *et al.*, 2015) and marrow (Domblides, 2016) (Fig. 5). The greatest number of embryoids per an ovary comprised 55, 20, and 9 embryoids for marrow, cucumber, and pumpkin, respectively. All produced plants have been included into selection process aimed on creation of the hybrids.





Figure 5. Obtaining summer squash (*Cucurbitata pepo* L.) DH-plants in unpollinated ovules

To achieve uniformity of segregating populations in the process of new selection form creation the method of induced apomixis can be used as well. We used this method for vegetable crops of *Allium* genus. The plants *A. odorum* L. were employed as apomixis inducers. Maternal plants were pretreated with gibberellin solution (0.1%) and 2.4-D solution (0.5 mg/L). *In vitro* embryoculture method was successfully used for creation of onion BC1 (F5(*A. cepa* × *A. fistulosum*) × *A. cepa*) interspecies hybrids and varieties of 'Odintsovets' and 'Danilovsky 301' of bulb onion (Romanov, 2008).

Clonal propagation helps to maintain and preserve valuable material to the plant breeders. Biotechnological task is to achieve the high propagation index *in vitro* without compromising of genetic stability. For some species of the vegetable crops this task was solved many years ago (carrot, eggplant, cucumber), while for some scarcely responsive species (for instance, pepper, cabbages) effective protocols were developed just recently (Yang et al., 2005). In VNISSOK Laboratory of Biotechnology developed the technology of clonal micro-propagation of cauliflower with the use of perfloral meristem (Ibragimov, 1991). Later an effective technology of clonal micro-propagation of white cabbage with male sterility was developed, which allows producing the plants in infinite amount. This technology comprises four stages (sprout formation induction, sprout formation, sprout growing, and sprout rooting). The whole cycle lasts for 8-11 weeks. The sprout development begins from the stage II; propagation index may range from 10 to 30 depending on an explant. After stage III propagation index increases 2-3-fold, while stage III may be repeated several times (Bunin, Shmykova, 2004). The F1 hybrid of Chinese cabbage 'Pamyati Popovoy' was created with the use of microclonal propagation technology.

The elements of microclonal propagation technology of the plants *Raphanus sativus* L. have been tried and tested. MSM medium with 0.2 mg/L of growth regulators such as naphthyl acetic acid (NAA) plus thidiazuron (TDZ) or NAA plus BAP was used to initiate radish shoot regeneration processes. To increase the number of the plants-regenerants per explant hypocotyls were pretreated with 0.1% of silver nitrate for 1 hour that resulted in 1.2-5 fold increase of propagation index (Zayachkovskaya, 2005).

Clonal micro-propagation method can be used for production of virus-free plant material rather than just for replication of difficult-to-propagate plants. For instance, we use clonal micro-propagation to obtain revitalized garlic plant material (Fig. 6). Garlic is a sterile plant that propagates slowly in the field, and most of the plants are infected by viruses. Viruses can be eliminated through meristem-tip culture and the resultant virus-free plants give 10 to 70% higher yield (Nagakubo *et al.*, 1997). We also used *in vitro* polyploidization method treating the callus with 0.05% and 0.1% colchicines solution to improve genetic diversity of garlic intended for breeding process. Our work resulted in inclusion of 12 produced lines into breeding program.



Figure 6. Micropropagation of *Allium sativum* L. (Garlic)

Technology of clonal micro-propagation in eggplant, which was developed in our laboratory (Verba *et al.*, 2010a), provided the basis of embryo culture enabling embryo rescue in the process of inter-species hybridization. VNISSOK performs the studies aimed on involvement of eggplant wild species into breeding program in order to transfer the resistance abilities to abiotic stressors. Inter-species hybrids of *Solanum melongena* L., *S. integrifolium* L. and *S.aethiopicum* L. are already available, where interspecies barriers were overcome with the use of *in vitro* embryo culture method (Verba *et al.*, 2010b). The method of *in vitro* cultivation of immature embryos of the pepper inter-species hybrids enabled to obtain the following inter-species hybrids: *C. baccatum* x *C. chinense*, *C. annuum* x *C. chinense*, *C. baccatum* x *C. annuum*, *C. frutescens* x *C. chinense*, *C. frutescens* x *C. annuum*, *C. annuum* x *C. frutescens*. Produced interspecies hybrid combinations were used in creation of pepper breeding material, which is resistant to viral diseases (Bunin *et al.*, 2008).

### Conclusion

Wide application of biotechnological methods in current breeding programs allows breeders to develop very competitive and marketable varieties and hybrids of vegetable crops. Such biological features of plants as development from gametic haploids cells and as well as regeneration from somatic cells have served as valuable source of genetic variation, which can be used both for breeding program and genetic studies. As it has been shown in the study the process of DH-plant production can be launched in many plant species by optimizing only the standard protocol invented previously. Consequently, the involvement of biotechnological methods into breeding process will result in 2-3 fold reduction of time and labor expenses required for creation of new competitive hybrids and varieties of vegetable crops, thus enabling the plant breeder to respond promptly to changing and growing market demands. As a result of breeding program realized with the use of DH-lines, hybrid F1 of kohlrabi 'Dobryniya', sweet pepper 'Nataly' and 'Gusar', and a carrot variety 'Sonata' have been released. The F1 hybrid of Chinese cabbage 'Pamyati Popovoy' was created with the use of microclonal propagation technology.

### References

- Adamus A., Michalik B. (2003) Anther culture in carrot (*Daucus carota* L.). *Folia Horticulturae Suppl.*, 2003, 1: 47-49.
- Andersen S.B. (1985) Anther culture in carrot. *Hereditas Suppl.*, 1985, 3(12): 132.
- Bhatia, R., Dey, S.S., Sood, S. et al. (2016) Optimizing protocol for efficient microspore embryogenesis and doubled haploid development in different maturity groups of cauliflower (*B. oleracea* var. *botrytis* L.) in India (2016) *Euphytica* 212: 439.
- Bohanec B. (2002) Double-haploid onions. In: *Allium Crop Science — Recent Advances* /H.D. Rabinowich, L. Currah (eds.). London, CABI.

- Bunin M.S., Shmykova N.A. (2004) Biotechnological methods of production parental plants' pool in cole breeding (in Russian). Moscow, 2004.
- Bunin M.S., Mamedov M.I., Pyshnaya O.N., Shmykova N.A., Suprunova T.P., Engalycheva I.A., Dzhos E.A. (2008) Interspecial hybridization among *Capsicum* L. plants in breeding: methods (in Russian). Moscow, 2008.
- Chen J.F., Cui L., Malik A.A., Mbira K.G. (2011) In vitro haploid and dihaploid production via unfertilized ovule culture. *Plant Cell Tiss. Organ Cult.*, 2011, 104: 311-319.
- Custers J.B.M. (2003) Microspore culture in rapeseed (*Brassica napus* L.) In: Maluszynski M, Kasha KJ, Forster BP, Szarejko I (eds) Doubled haploid production in crop plants, a manual. Kluwer Academic Publishers, Dordrecht, pp 185–193
- Domblides A. (2001) Development of laboratory technology for in vitro production of gynogenic carrot plants. PhD Thesis (in Russian). Moscow
- Domblides E.A., Shmykova N.A., Zayachkovskaya T.V., Khimich G.A., Korotseva I.B., Kan L.Y., Domblides A.S. (2016) Doubled haploid plant production from in vitro culture of unpollinated ovules of summer squash (*Cucurbita pepo* L.). Proc. of the 7 International scientific and practical conference “ Biotechnology as an Instrument for plant biodiversity conservation” Yalta, Crimea, Russia, September, 25 – October 01, 2016., P 29
- Domblides A. (2017) Anther and ovule in vitro culture in carrot (*Daucus carota* L.) *Acta Hortic.* 1153, 55-60. doi: 10.17666/ActaHortic.2017.1153.9
- Gemes - Juhasz A., Balogh P., Ferenczy A., Kristof Z. (2002) Effect of optimal stage of female gametophyte and heat treatment on in vitro gynogenesis induction in cucumber (*Cucumis sativus* L.). *Plant Cell Rep.*, 21: 105-111
- Gorecka K., Kowalska U., Krzyzanowska D., Kiszczak W. (2010) Obtaining carrot (*Daucus carota* L.) plants in isolated microspore cultures. *J. Appl. Genet.*, 2010, 51: 141-147
- Ibragimov I.A. (1991) Development of clone micropropagation protocol for cauliflower (in Russian). Moscow, 1991.
- Kim M, Jang I-C, Kim J-A, Park E-J, Yoon M, Lee Y (2008) Embryogenesis and plant regeneration of hot pepper (*Capsicum annuum* L.) through isolated microspore culture. *Plant Cell Rep* 27:425–434
- Kielkowska, Adamus (2010) In vitro culture of unfertilized ovules in carrot (*Daucus carota* L.).//*Plant Cell Tissue and Organ Culture*, N 102. P. 309-319.
- Masuda K., Kikuta Y., Okazawa Y. (1981) A revision of the medium for somatic embryogenesis in carrot suspension culture. *Fac. Agric. Hokkaido Univ.* 60, P. 183-193
- Michalik B., Baranski R. (1992) In vitro induction of haploid plants from unpollinated ovules of red beet. Proc. XIII Eucarpia Congr. «Reproductive Biology and Plant Breeding». France, 1992: 193-194.
- Mohamed M.F., Refaei E.F.S. (2004) Enhanced haploid regeneration in anther culture of summer squash *Cucurbita pepo* L. *Cucurbit Genetics Cooperative Report*, 27, P. 57-60.
- Mukhambetzhonov S. K. 1997. Culture of nonfertilized female gametophytes in vitro. *Plant Cell, Tissue and Organ Culture*. Vol. 48.P. 111-119.
- Nagakubo T., Takaichi M., Oeda K. (1997) Micropropagation of *Allium sativum* L. (garlic). In: *Biotechnology in agriculture and forestry*. V. 39. High-tech and micropropagation V /Y.P.S. Bajaj (ed.). Berlin-Heidelberg: Springer-Verlag, P. 4-19.
- Pivovarov V. F., Shmykova N.A., Suprunova T.P. (2011) Biotechnological approaches to vegetable crop breeding *Ovoshchi Rossii*, 2011, 3 (11): 28-31
- Pivovarov V. F., L.L. Bondareva, N.A. Shmykova, D.V. Shumilina, A.I. Mineikina (2017) New generation hybrids of white cabbage (*Brassica oleracea* L. convar. capitata var. alba DC) based on doubled haploids. *Agricultural Biology*, Vol. 52, № 1, p. 143-151.

- Romanov V.S. (2008) Breeding and genetic features of interspecific onion hybrid accessions: their development and assessment. PhD Thesis (in Russian). Moscow
- Semova N.Yu. (1992) Laboratory method for white cabbage androgenic plants production using anther in vitro culture. PhD Thesis. Moscow, 1992.
- Shalaby T.A. (2007) Factors affecting haploid induction through in vitro gynogenesis in summer squash (*Cucurbita pepo* L.). *Sci. Hort.*, 2007, 115: 1-5
- Shumilina D.V., Suprunova T.P., Dzhos E.A., Pyshnaya O.N., Shmykova N.A. (2013) Plant regeneration from isolated anther/microspore culture of sweet pepper (*Capsicum annuum* L.cv.'Zdorovie'): Proceedings of the XV EUCARPIA Meeting on Genetics and Breeding of *Capsicum* and Eggplant. P. 555-558.
- Shumilina D.V., Shmykova N.A., Bondareva L.L., Suprunova T.P. Effect of Genotype and Medium Culture Content on Microspore Derived Embryo Formation in Chinese Cabbage (*Brassica rapa* ssp. *chinensis*) cv. Lastochka . *Izvestiya Akademii Nauk, Seriya Biologicheskaya*, 2015, No. 4, pp. 368–375. DOI: 10.1134/S1062359015040135
- Shmykova N.A. Interspecific hybridization among *Capsicum* L. plants in breeding: techniques]. Moscow, 2006.
- Shmykova N.A., Suprunova T.P. (2009) An induction gynogenesis in culture in vitro not-pollinated seedbuds of *Cucumis sativus* L. *Gavrish*, 2009, 4: 40-44.
- Shmykov a N.A., Pyshnaya O.N., Shumilina D.V., Suprunova T.P., Dzhos E.A., Mamedov M.I. (2012) Protocol for production of doubled haploid pepper (*Capsicum annuum* L.) lines derived from anther/microspore in vitro culture: manual. Moscow, 2012.
- Shmykova N.A., T.P. Suprunova, V.F. Pivovarov (2015) Biotechnologies and molecular methods in vegetable crop breeding (to 95th Anniversary of VNISSOK) *Agricultural biology* V. 50, №5, pp. 561-570 doi:10.15389/agrobiology.2015.5.561eng
- Shmykova N.A., Khimich G.A., Korottseva I.B., Domblides E.A. (2015) Prospective of development of DH-plants of Cucurbitaceae family. *Ovoshchi Rossii*, 2015, 3-4: 28-31.
- Supena EDJ, Suharsono S, Jacobsen E, Custers JBM (2006) Successful development of a shed-microspore culture protocol for doubled haploid production in Indonesian hot pepper (*Capsicum annuum* L.). *Plant Cell Rep* 25:1–10
- Takahata Y., Keller W.A. (1991) High frequency embryogenesis and plant regeneration in isolated microspore of *Brassica oleracea* L. *Plant Sci*,74:235-242
- Taganov B.O. (1991) Razrabotka laboratornoi tekhnologii polucheniya androgennykh rastenii morkovi in vitro. Avtoreferat kandidatskoi dissertatsii [Laboratory method for androgenic carrot plants in vitro production. PhD Thesis]. Moscow, 1991.
- Tyukavin G.B., Shmykova N.A., Monakhova M.A. (1999) Cytological study of embryogenesis in cultured carrot anthers. *Fiziologiya rastenii*, 1999, 46(6): 876-883.
- Tyukavin G.B. Basic carrot plant biotechnologies. Moscow, 2007.
- Verba V.M., Mamedov M.I., Pyshnaya O.N., Suprunova T.P., Shmykova N.A.(2010a) Sel'skokhozyaistvennaya biologiya [Agricultural Biology], 5: 66-71.
- Verba V.M., Mamedov M.I., Pyshnaya O.N., Shmykova N.A (2010b) Clone micromultiplication in egg plant by organogenesis *Vestnik RASHN*, №6, p 57-59
- Vjurts T., Shmykova N., Fedorova M., Zayachkovskaya T., Domblides E. (2016) Development of doubled haploid lines (DHs) in carrot (*Daucus carrot* L.) with the use of biotechnological methods . *Plant protection news*, 3 (89), p. 43-44
- Zayachkovskaya T. (2005). Easrimation of breeding accessions of *Raphanus Sativus* L. using methods of reproductive biology for heterosis breeding program. PhD Thesis. Moscow

## FALENSKAYA 4 WINTER RYE RESPONSE TO LONG TERM FERTILIZER APPLICATIONS

Antonina KOSOLAPOVA<sup>1</sup>, Konstantin KORLYAKOV<sup>1\*</sup>, Valery VOZZHAEV<sup>2</sup>

<sup>1</sup>Perm Agricultural Research Institute 614532. Lobanovo. Perm region. Russia

<sup>2</sup>Perm State Agricultural Academy named after D.N. Pryanishnikov 614990. Petropavlovskaya St.. 23. Perm. Russia

\*Corresponding author: korlyakovkn@rambler.ru

### Abstract

The impact of increasing rates of mineral fertilizers on Falenskaia 4 winter rye yield, agrophysical and agrochemical properties of the ploughed soil layer was determined in 2011-2013 as part of long-term field test trials, founded in 1972-1974. The field experiment was carried out on heavy loamy sod-podzolic soil with humus content 1.54%,  $\text{pH}_{\text{KCl}} = 5.4$ , high  $\text{P}_2\text{O}_5$  and  $\text{K}_2\text{O}$  content. Long-term (over 40 years) fertilizers application ( $\text{N}_{60}\text{P}_{60}\text{K}_{60} \text{ ha}^{-1}$  and more) caused the humus level to rise from 1.54 to 2.18 %, labile phosphorus - from 296 to 399, soluble potassium - from 187 to 324 mg/kg with slight soil acidification ( $\text{pH}_{\text{KCl}}$  varied from 4.82 to 5.12) and improvement of soil agrophysical properties, including the valuable silt fraction and an increase in water-stable particles. Mineral fertilizer applications had no direct effect on soil density, which was more influenced by phase of the vegetation period: increasing from  $1.18 \div 1.23$  during the tillering stage to  $1.54 \div 1.61 \text{ g/cm}^3$  during the grain milk-ripe stage.

Improved nutritional conditions due to the joint impact of mineral fertilizers and organic matter from the root remains and crop residues promoted raised the yield of winter rye by  $1.15 - 1.47 \text{ t ha}^{-1}$  compared with the control (no fertilizers). Maximum yield and crop return in the field trial found in the treatment  $\text{N}_{60}\text{P}_{60}\text{K}_{60} \text{ ha}^{-1} - 4.48 \text{ t ha}^{-1}$  and  $8.2 \text{ kg}$  of grain - respectively for 1 kg of mineral fertilizers active substance. Further increment of mineral fertilizers rates to winter rye caused plant lodging. and losses while harvesting and yields decreased as a result.

**Key words:** *winter rye, mineral fertilizers, agrophysical, agrochemical soil properties. yield.*

### Introduction

Winter rye provides the most stable yields among cereal crops in the Perm Region as well as in the Non-Chernozemic zone of Russia and other countries. (Arseniuk and Oleksiak, 2003; Bragin and Yumashev, 2012; Raun and Solie, 2005). Winter rye is widely used and possesses an extremely high food value. Its wide application is due to its high content of valuable proteins, carbohydrates and vitamins in the grain (Ismagilov, et al, 2001; Kedrova 2000). The amino-acid content of winter rye protein is more balanced compared with other cereal crops [Kobylyansky and Solodukhina, 2012; Sherstnyov. 1980; Sysuyev and Kedrova, 2000].

Winter rye is one of the best preceding crop as it is harvested earlier than other cereals, that making it possible to carry out skimming for better weed control. This crop is the most adaptive and stress-tolerant of the small-grained cereals. Winter rye efficiently uses water during autumn and winter, reduces the growth machinery work load during the spring and summer. It is also better-adapted to poor sod-podzolic soils- than other cereals, and has a high nutrient uptake capacity. It is a reliable crop insuring a steady yield of food grain, regardless of weather conditions (Frank, 1992; Panasiewicz, et al, 2016; Sysuyev et al, 2007].

Therefore, the extension of winter rye crops is conditioned by economic, agricultural, and environmental reasons. Many new cultivars of winter rye have now been introduced into arable farming, including those highly responsive to mineral fertilizer applications, such as Falenskaya 4, and others. Therefore, the elaboration of a rational and profitable fertilizer system for winter rye - is very relevant.

The aim of this research was- to determine optimum fertilizer rates for Falenskaya 4 to provide steady harvests and stable soil fertility.

### Materials and methods

Fertilizer utilisation efficiency on winter rye was studied during 2011-2013 as part of a long-term, stationary experiment founded in 1972-1974. The experimental plots located on shallow- sod podzolic heavy loam soil with humus content 2.01 %,  $pH_{KCl} = 5.4$ ,  $H_A = 2.2$  mmol/100 g soil,  $S = 20.3$  mmol/100 g soil, high content of labile phosphorus ( $P_2O_5$ ), soluble potassium ( $K_2O$ ), respectively 182 and 190 mg/kg (before starting the experiment).

Experimental Design:

1. Control (no fertilizers)

2.  $N_{30}P_{30}K_{30}$

3.  $N_{60}P_{60}K_{60}$

4.  $N_{90}P_{90}K_{90}$

5.  $N_{120}P_{120}K_{120}$

6.  $N_{150}P_{150}K_{150}$

Treatments were located systematically, with each treatment having four replications for each of three replicate years. The total area of each plot was 100 m<sup>2</sup>. calculated area 63 m<sup>2</sup>. Field trials were carried out using a crop rotation as follows: bare fallow, winter rye, potato, spring wheat as a shelter crop for meadow clover, first year clover, second year clover, spring barley, oat. Certified seeds were used for sowing. The studied culture – winter rye ( *Secale sereale*. Z. var. vulgare ), cultivar - Falenskaya 4 ( selected in North-East Zonal Agricultural Research Institute after N.V. Rudnitskiy ).

The forms of fertilizers used were ammonium nitrate, single superphosphate, potassium chloride. PK fertilizers were applied in the autumn before pre-sowing cultivation, nitrogen fertilizers: fractionally  $N_{30}$  in the autumn,  $N_{30-120}$  in the spring. as a top dressing.

Soil and plant chemical analyses were carried out in an analytical laboratory of the Perm Agricultural Research Institute according to national standards: humus content - GOST 26213-84;  $pH_{KCl}$  - GOST 26483-85; hydrolytic acidity - GOST 26212-91; sum of exchange bases - GOST 27821-88; labile phosphorus and soluble potassium - GOST 26207-91. Data processing included analysis of variance and determining correlation coefficients. Crop return parameter was determined as a difference between yield in the control treatment and the one with fertilizer applications per 1 kg of mineral fertilizers active substance:

$(Y_{NPK} - Y_{Control}) / NPK \text{ rate}$

Weather conditions during the experiment were typical for the Ural Region and suitable for winter rye.

### Results and discussion

Balanced mineral nutrition of winter rye plants is the most important factor for stable yields. Unlike other cereals. winter rye has a well-developed root system and high nutrient uptake capacity. This crop needs phosphorus and potassium in the autumn, and moderate nitrogen rates in the spring.

Well-balanced plant nutrition allows the crop to provide high crop yields with good quality characteristics of the grain and straw and indirect improvement of soil agrophysical

parameters due to winter rye's strong root development (Sysuyev et al, 2007). Soil agrophysical parameters are very important in the context of extreme climate changes as they control edaphic processes and have a directive effect on winter rye yield. Water, thermal conditions and nutritional status depend significantly on the soil texture expressed by volume weight or soil density. During the three years of the experiment no significant compacting was noted in autumn or in winter as the soil was frozen deeply enough and therefore did not shrink. Soil density at the tillering stage of winter rye varied from 1.22 to 1.26 g/cm<sup>3</sup> over the three years, which is close to optimum values for cereals. Mineral fertilizer applications had no direct effect on soil agrophysics. A vigorous increase in vegetative and root masses was caused by a complete (NPK) fertilizer at rates of 60 kg and more of active substance, that reduced soil density significantly compared with the control as a result (least significant difference 0.02 g/cm<sup>3</sup>). Abnormal climatic events (air temperature fluctuations, droughts during the winter rye vegetation period) resulted in puddling from the tillering stage (1.35 to 1.40 g/m<sup>3</sup>) to harvesting (1.52 to 1.63 g/m<sup>3</sup>). However, a well-balanced soil dressing using a complete mineral fertilizer (60 kg FAS or more) provided a friable topsoil texture, due to powerful root system growth. Soil structure is one of the important fertility parameters. The process of soil aggregation is influenced by many factors, first of all connected with climate. Mineral fertilization in our experiment increased the proportion of valuable fractions, especially the silt fraction. The formation of soil structure was due to microbiota activity as influenced by the nutrition provided. The most important structure parameter is the quantity of water-stable particles, which depends on climatic factors, microbiological activity and organic matter input with crop and root residues (Fig 1).

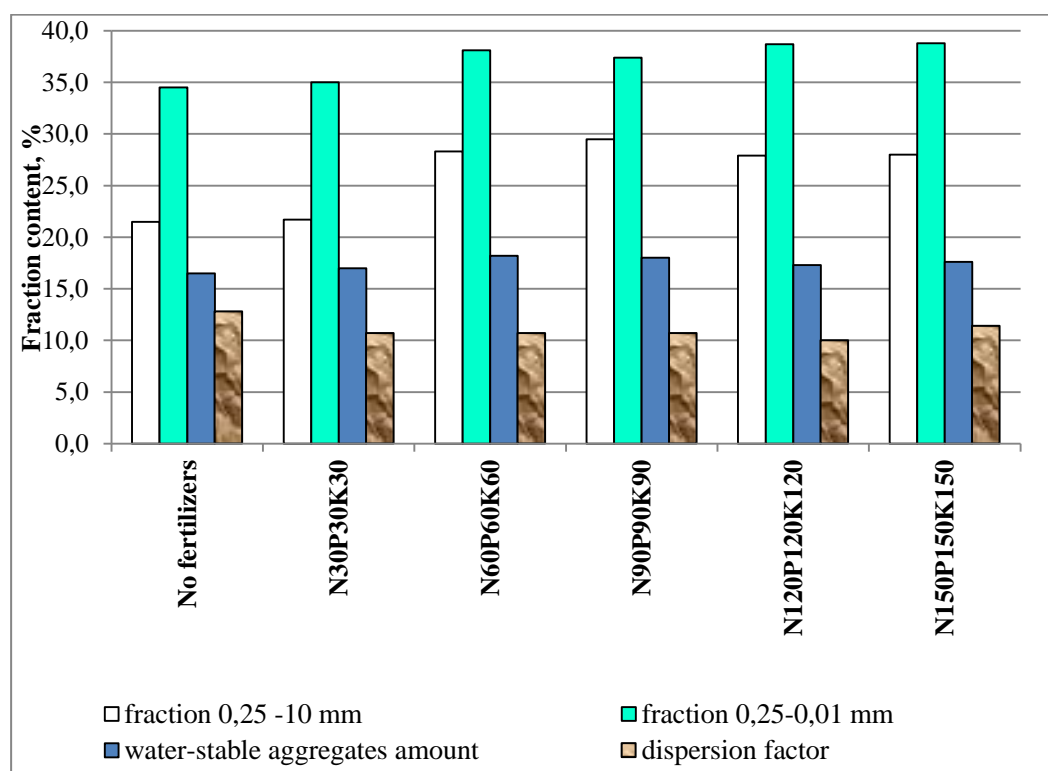


Fig. 1. The structure of sod-podzolic- soil in 0-20 cm layer. average for 2011-2013.

Long-term mineral fertilization promoted an increase in soil humus from 1.54 to 2.18%, labile phosphorus from 296 to 399 mg/kg of soil, soluble potassium from 171 to 324 mg/kg of soil

(Table 1). High rates of mineral fertilizers (N<sub>90</sub>P<sub>90</sub>K<sub>90</sub> and more) caused soil acidity to increase: pH decreased, hydrolytic acidity (H<sub>A</sub>) increased.

Table 1. Effect of mineral fertilizers rates on soil fertility parameters (0 - 20 cm layer).

Treatments	Humus. %	pH <sub>KCl</sub>	mmol/100 g soil		Content. mg/kg	
			H <sub>A</sub>	S	P <sub>2</sub> O <sub>5</sub>	K <sub>2</sub> O
No fertilizers	1.54	5.01	2.20	19.8	296	187
N <sub>30</sub> P <sub>30</sub> K <sub>30</sub>	1.66	5.12	2.18	20.3	303	171
N <sub>60</sub> P <sub>60</sub> K <sub>60</sub>	2.08	5.00	2.30	21.7	330	213
N <sub>90</sub> P <sub>90</sub> K <sub>90</sub>	2.12	4.94	2.67	21.3	385	293
N <sub>120</sub> P <sub>120</sub> K <sub>120</sub>	2.18	4.91	3.01	20.7	391	305
N <sub>150</sub> P <sub>150</sub> K <sub>150</sub>	2.17	4.82	3.05	20.5	399	324
LSD <sub>05</sub>	0.41	F <sub>a</sub> < F <sub>t</sub>	0.10	F <sub>a</sub> < F <sub>t</sub>	56	60

Thus, increases in soil humus, labile phosphorus and soluble potassium and better soil agrophysical properties promoted winter rye yield to more than 3.5 t ha<sup>-1</sup> (Table 2) in spite of water-deficient during certain vegetation periods. Increases of winter rye grain yield varied from 0.31 to 1.47 t ha<sup>-1</sup> compared with the control (LSD<sub>0.05</sub> = 0.53 t ha<sup>-1</sup>).

Table 2. The influence of mineral fertilizers rates on winter rye yields. t ha<sup>-1</sup>

Treatments	Years			Average	Deviations		Crop returns 1 kg NPK/kg
	2011	2012	2013		t ha <sup>-1</sup>	%	
Control	3.67	3.05	2.31	3.01	-	-	
N <sub>30</sub> P <sub>30</sub> K <sub>30</sub>	3.87	3.22	2.87	3.32	0.31	10.3	3.4
N <sub>60</sub> P <sub>60</sub> K <sub>60</sub>	5.10	3.94	4.39	4.48	1.47	48.8	8.2
N <sub>90</sub> P <sub>90</sub> K <sub>90</sub>	4.84	3.87	4.03	4.25	1.24	41.2	4.6
N <sub>120</sub> P <sub>120</sub> K <sub>120</sub>	4.92	3.92	3.65	4.16	1.15	38.2	3.2
N <sub>150</sub> P <sub>150</sub> K <sub>150</sub>	4.97	3.95	3.61	4.18	1.17	38.9	3.2
LSD <sub>05</sub>	0.51	0.34	0.42	0.53			

In the treatment with N<sub>30</sub>P<sub>30</sub>K<sub>30</sub> applied in the spring as a top dressing, growth retardation of winter rye plants was noted, as well as poor tillering compared with NPK addition at higher rates. That may be explained by the early resumption of vegetative growth in winter rye, when soil microbial activity is weak. Nitrogen release is slow and plants are stressed from nitrogen deficiency.

Moderate (N<sub>60</sub>P<sub>60</sub>K<sub>60</sub>) and high fertilizer rates increased grain filling and 1000 grain mass. Maximum winter rye yield 4.48 t ha<sup>-1</sup> was achieved in the treatment N<sub>60</sub>P<sub>60</sub>K<sub>60</sub>. Crop return reached 8.2 kg (Table 2). Higher fertilizer rates caused crop lodging and losses while harvesting and yields decreased as a result.

### Conclusion

Non-uniform distribution of warmth and rainfalls during vegetation periods in 2011-2013 caused degeneration of the soil agrophysic properties. Topsoil density increased from 1.18-1.23 during the tillering stage to 1.54-1.61 g/cm<sup>3</sup> during the grain milk-ripe stage.

Long-term mineral fertilization (N<sub>60</sub>P<sub>60</sub>K<sub>60</sub> and more) caused soil humus content to increase from 1.54 to 2.18 %, mobile phosphorus and soluble potassium to accumulate and soil acidity



dimensions and soil agrophysical properties to improve, including the silt fraction and water-stable particles to increase.

A maximum winter rye yield of 4.48 t ha<sup>-1</sup> was obtained using N<sub>60</sub>P<sub>60</sub>K<sub>60</sub>. The highest crop return 8.2 kg was also noted in this treatment. The higher fertilizers rates caused crops to lodge and losses occurred while harvesting and yields decreased as a result.

### References

- Bragin V.N., Yumashev V.N., 2012. Nitrogen fertilizer efficiency on winter rye grown in forest-steppe landscapes. In: Winter rye. Selection, seed growing. Technology and processing. Proceeding of Russian scientific conference– Yekaterinburg. p 160-163.
- Arseniuk E., Oleksiak T., 2003. Rye production and breeding in Poland. Plant breeding and seed science. Volume 47. №. 1/2. p.7 -16.
- Chmielewski F., 1992. Impact of climate changes on crop yields of winter rye in Halle (southeastern Germany), 1901 to 1980. CLIMATE RESEARCH. Vol. 2: p.23-33,.
- Ismagilov R.R., Nurlygayanov R.B., Vanyushina T.N., 2001. Quality and production technology of winter rye food grain. Moscow: Agro-Press.
- Kedrova L.I. 2000. Winter rye in Northeast Russia. Kirov: Northeast ARI.
- Kobylyansky V.D. Solodukhina O.V. 2012. Selection technology elements of with low water-soluble pentosan level in grain. In: Winter rye: selection, seed growing, technology and processing. Proceeding of Russian scientific conference Yekaterinburg, p 20-24.
- Panasiewicz K., et. al.,2016. Yielding and energy value of winter rye depending on sprinkling irrigation and nitrogen fertilization. *Fragm. Agron.* 33(3) p.57–64.
- Raun W.R., Solie J.B., Stone M.L., 2005. Optical sensor based algorithm for crop nitrogen fertilization. *Comm. Soil Sci. Plant Anal.* Vol. 36 (19-20). P. 2759-2781.
- Sherstnyov N.V. 1980. Winter rye in Siberia and in the Urals. M.:Rosselkhozizdat.
- Sysuyev V.A., Kedrova L.I. 2000. Energy of rye for human health. Kirov: Northeast ARI.
- Sysuyev V.A., Kedrova L.I., Lapteva N.K., 2007. Winter rye. Cultivation, application in food, fodder and manufacture. Problems and solutions. Moscow: Rosinformagrotekh, FSSI.

## **SEED LIFE CYCLE MANAGEMENT**

Sergej V. GONCHAROV

Crop breeding Department, Voronezh State Agricultural University, 1 Michurin Str., 394087, Russian Federation  
Corresponding author: slogan1960@mail.ru

### **Abstract**

Seed lifecycle management of corn, sunflower and sugar beet is discussed from marketing standpoint; and includes the market introduction phase, growth, maturity, and decline one. The market needs pipeline of varieties with higher added value, i.e., with competitive advantage compared to existing ones. The breeder has to be aware about value chain needs and pain points, and processing industry ones as well. Improve the return of investment to the breeding program based on improved turnover of seeds, royalty collection harmonization for certified seeds, and for the farm-saved seeds too. Knowledge of seeds life cycle characteristics allows to be more efficient in portfolio management, i.e. to adjust product pipeline to value chain needs. Variability of life cycle stages is one of its strategy implementation disadvantages. Recommended for specific stage strategy does not always aligned with expected result due to some uncertainties related with them.

**Keywords:** *Seed lifecycle, royalties, return of investment, breeding.*

### **Introduction**

The seeds business is possible to explore from the standpoint of marketing, i.e. as the life cycle length of a product. The actual length of a variety availability at the market is considered as duration of its commercial use, or period of charging from the product market introduction till its withdrawal. Also, it is considered as an average period of the variety listing.

The shorter is life cycle of the product, the faster market growth is in the conditions of high competition on the seeds market, high-input technologies, and goals of profitable crop production. New generation of cultivars with better adding value (greater yield potential, better goods quality and proper adaptation) is able to increase the profitability of whole value chain from breeder till processor.

Fairness of the variety registration, patent protection and complicated certification are reducing varieties flow at the National register and enlarge their life cycle. Russia and the EU have common approach to the protection of intellectual property of seeds, and National registers populating by cultivars. Comparison of life cycle duration between field crops explains some details of crop competitiveness, attractiveness of markets for seed and other commercial products.

### **Materials and Methods**

Lists of registered corn, sugar beet, and sunflower varieties were used as testing subject. Updated data of the National Register of Belorussia, Kazakhstan, Russia, and Ukraine in 2016 [National Register of Varieties and Ornamental Crops, 2016; National Register of Breeding Achievements (2016)], have been interpreted with the author's method of variety life cycle

duration assessment [Goncharov S.,2017]. The marketing approach was applied to identify stages of seed life cycle.

### Results and discussion

Seed life cycle is the set of processes from identification of the consumer needs in food / feed products till their satisfaction. It is unique for every variety, and generalizes income in process of seed commercialization. It helps decision-making for identification of needs in the variety promotion support, or vice versa, if it makes sense to make solution about its withdrawal.

The seed life cycle describes the dynamics of the processes associated with the commercialization of varieties: investments, seed sales, profit generalization from trading and the royalties transfer. It consists of the phases of the market introduction (start of sales), growth, maturity and decline (Figure 1). The variety commercialization precedes breeding program (which takes 10-12 years). Although the breeding goals seemed to be common (yield, quality, resistance to stress, etc.), the market needs products with added value, and better return of investments (ROI) i.a. innovation [Goncharov S., 2017].

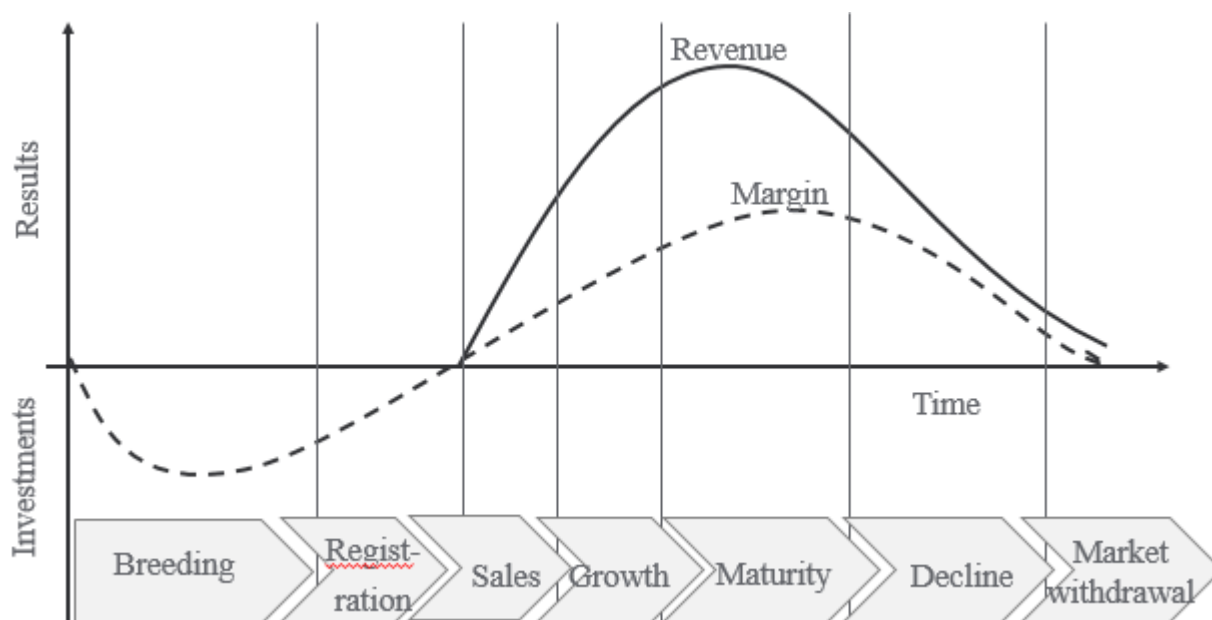


Figure 1. Seed life cycle stages

Every variety as a product has its own life cycle and it will pass through the stage of decline someday. But through effective product line decisions and other strategies its profitability period may be extended for the breeder benefit. Planning of seed sales volume, anticipated profits, pricing, etc. in 15-20 years (including the duration of selection 10-12 years with registration 2-5 years) is hardly possible. Availability of prototypes from other crops (for example, IMI- herbicides tolerance of sunflower) may be helpful for development of innovation

Seed life cycles of corn, sunflower, and sugar beet were comparatively short in Ukraine (9, 10 and 11 years). They last longer in Russia (11, 11 and 14 years correspondingly), and were the longest in Kazakhstan (20, 10, 19 years) (Figure 2). Genotype role is less important in Kazakhstan, then weather and climate conditions, with higher input on crops yield volatility.

Sunflower seed market is niche one in Belorussia, and therefore, seed life cycle is quite long there (19 years) with limited interest from breeders there. Cereals are losing their

attractiveness for farmers in competition with higher margin crops sunflower, corn, sugar beet, rape seed etc.)

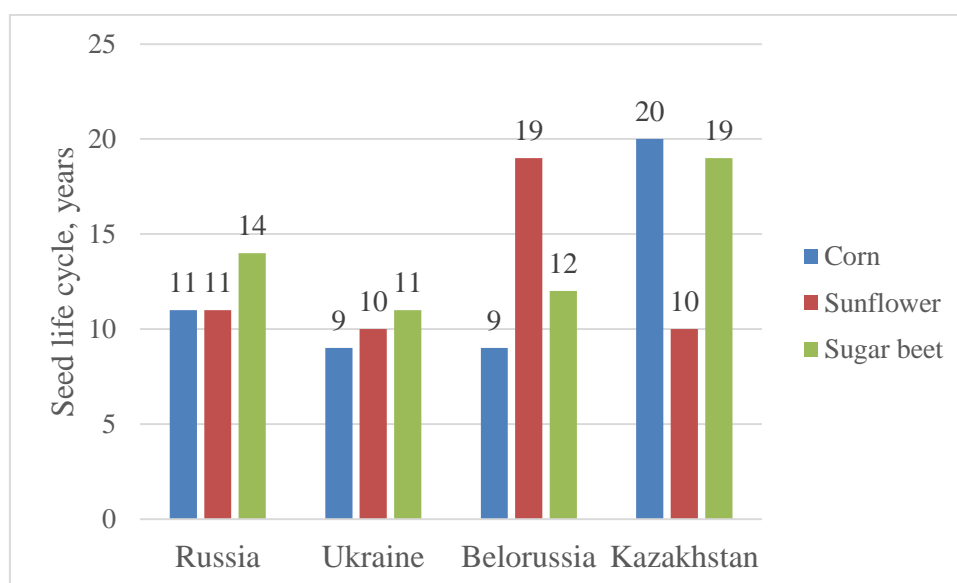


Figure 2. Seed life cycle duration in Commonwealth of Independent States countries, years

Seed companies prefer to multiply the new variety in advance to offer seeds to the market simultaneously with its registration decision, and be ready to conclude licensing contracts as well. Return of investment in breeding may be improved by harmonization of royalty collection for the sold certified seeds, and also for the farm-saved seeds.

The market introduction of the new variety is normally aligned with risks of the failure, costs of breeding, and registration fees. Seed companies invest in promotion, i.e., on the farmer awareness about the new products through demo-fields, co-promotion by potential partners in multiplication, advertising, branding, etc. Volumes of seeds are slow growing, as the new variety competes with the already available in the market. Different strategies are applied to the certain stages of seed life cycles for return of investment improvement (Table 1).

Table 1. Stage management of seed life cycle

Characteristics	Stages of seed life cycle			
	Introduction	Growth	Maturity	Decline
Seed sales	low	rising	Peak	decline
Profit	negative	rising	High	decline
Market objectives	product awareness	maximize market share	maximize profit	reduce expenditures
Customers	innovator	early adoptor	Magority	lagard
Product (variety)	market offer	services, quaranties, solutions	brand diversification	stop seed production
Price	premium	to win market	competitive varities	reduced

Distribution	selective	Intensive	support of intensive distribution	common
Seed sales promotion	seed strategy	partners choise	brand development	reduced
Advertising goals	variety awareness	mass interest	underline brand	minimized

### Conclusions

Range of strategies targeting return of investment, are recommended for every stage of the seed life cycle.

Corn seed life cycle lasts from 9 years in Ukraine and Belorussia till 20 ones in Kazakhstan; sunflower one - from 10 years in Ukraine and Kazakhstan till 19 ones in Belorussia; sugar beet one - from 11 years in Ukraine till 14 ones in Kazakhstan.

The higher input in crop production (and, the better yields, and the bigger margin), the shorter seed life cycle is in CIS countries.

### References

- National Register of Varieties and Ornamental Crops (2016) Belorussia // [www.sorttest.by](http://www.sorttest.by)
- National Register of Breeding Achievements (2016) Kazakhstan // [www.goscomsort.kz/index.php/izdaniya/reestr-selektsionnykh-dostizhenij](http://www.goscomsort.kz/index.php/izdaniya/reestr-selektsionnykh-dostizhenij)
- National Register of Breeding Achievements approved to be used in Russian Federation (2016) [www.gosort.com](http://www.gosort.com)
- National Register of Breeding Achievements (2016) Ukraine // [www.sops.gov.ua](http://www.sops.gov.ua)
- Goncharov S. (2017) Cereals Seed Lifecycle // Agrofor. Vol.2. № 1. URL: <http://www.agrofor.rs.ba/paper.php?id=112>

## EFFECTS OF METALLURGICAL SLAG AND ORGANIC FERTILIZER AMENDMENTS ON CHEMICAL COMPOSITION OF CHARD (*BETA VULGARIS* VAR. *CICLA*)

Aleksandra STANOJKOVIĆ-SEBIĆ<sup>1\*</sup>, Zoran DINIĆ<sup>1</sup>, Stevan ČANAK<sup>3</sup>, Dragana JOŠIĆ<sup>1</sup>, Radmila PIVIĆ<sup>1</sup>

<sup>1\*</sup>Institute of Soil Science, Teodora Drajzera 7, 11000 Belgrade, Serbia

<sup>2</sup>Institute for Animal Husbandry, Belgrade – Zemun, 11080 Zemun, Serbia

<sup>3</sup>State University of Novi Pazar, Department of Chemical-Technological Sciences, 36300 Novi Pazar, Serbia

\*Corresponding author: astanojkovic@yahoo.com

### Abstract

The aim of this study was to investigate the effects of application of Ca - containing metallurgical slag on chemical composition (macro and trace elements) of chard (*Beta vulgaris* var. *cicla*) aerial parts. The study was performed in semi-controlled glasshouse conditions, and the effects of metallurgical slag was compared to those of other lime materials (ground limestone and hydrated lime) in combination without and with standard mineral and organic (liquid fish) fertilizers. P was determined by spectrophotometer, K - by flame emission photometry and N, C, S - using elemental CNS analyzer Vario EL III. In the determination of Fe, Zn, Cu and Cd, atomic absorption spectrometry was used. The results of the paper indicate that all Ca-materials studied, including metallurgical slag, along with the studied fertilizers, showed positive effects on the content of main and beneficial biogenic macroelements in aerial biomass of the tested vegetable. There is a noticeably and statistically significant tendency of an increase in the content of P, K and S in tested plant in the treatment with liquid fish fertilizer in relation to other treatments. Regarding the concentration of trace metals in tested vegetable, there was not found higher accumulation of Fe in tested plants in the treatments where metallurgical slag was applied in spite of its significant content in this liming material. As for Cd, its concentrations were within the safety limits and allowed concentrations in all the treatments, which is a highly desirable outcome.

**Keywords:** *Metallurgical slag, lime materials, mineral and liquid fish fertilizer, acid soil, chemical composition, chard.*

### Introduction

Liming an acid soils, such as stagnosols, is the first step in creating favorable soil conditions for productive plant growth. Crops vary in their ability to tolerate an acidic (low pH) soil. In general, chard (*Beta vulgaris* var. *cicla*), belongs to those vegetables that grows well in a soil of pH around 6.5-6.8 and acidic conditions will stunt its growth. Thus, a necessary lime should be applied. Acid soils require liming and constant mineral and organic fertilization when used in agricultural production. The application of traditional alkaline liming materials such as limestone, dolomite and burnt lime to acid soils for the amelioration of acidity consequently improving crop production is a common practice (Barber, 1984; Troeh and Thompson, 2005). However, the alkaline nature and the need for sustainable and environmentally acceptable disposal options for metallurgical slag (Lopez *et al.*, 1995) have prompted its use as a liming material on acid agricultural soils.

The liming materials in metallurgical slag comprise water-soluble and less water-soluble Ca and Mg compounds. Free Ca in slag reacts rapidly with water to form  $\text{Ca}(\text{OH})_2$ . The  $\text{Ca}(\text{OH})_2$

will react rapidly with soil acidity. In addition to the liming materials, metallurgical slag contains various concentrations of plant nutrients, such P, S, Mn, Fe, and Mo.

As early as the 1930s, metallurgical slag was being used as an agricultural amendment in Alabama, Illinois, Indiana, Kentucky, Maryland, New York, Ohio, Pennsylvania and West Virginia. White *et al.* (1937) reported on field trials in Pennsylvania that crop yields of corn, wheat, oats, buckwheat and soybeans with metallurgical slag applications were as good or better than an equivalent amount of limestone.

Some slags may contain elevated concentrations of trace metals such as iron, cadmium, chromium, copper, lead, molybdenum, nickel, and zinc. Concentrations of these metals vary in slags from different sources. All of these metals occur naturally in soil, and many are essential plant nutrients. If concentrations in the slag are similar to soil concentrations, they present no problem. If they are present at substantially higher concentrations in the slag than in the soil, repeated application of the slag could significantly increase soil concentrations of the metal in soil. This possibly could lead to plant toxicity, increased plant uptake and transfer of metals to animals or humans, or to other environmental problems. Although metallurgical slags contain varying concentrations of trace elements (e.g., trivalent Cr (III) and Zn), the bioavailability of these metals is very low (National Slag Association, 2001).

As a co-product of an industrial process, metallurgical slag offers considerable cost advantages over commercial limestone. In that manner, along with other lime materials (ground slag stone, saturated slag etc.) present in Serbia, metallurgical slag from Steel factory - Smederevo (Serbia) can be of great importance.

In addition, the aquaculture industry in recent years had to develop various management strategies to reduce the environmental impacts of aquaculture manure waste. In this regard, to evaluate the potential of aquaculture solid waste for use as a fertilizer, the aquaculture industry and regulatory agencies require analytical data regarding the concentrations of various plant nutrients found in the waste (Naylor *et al.*, 1999).

Regarding the aforementioned comments, the aim of this research was to investigate the effect of calcium containing metallurgical slag, a by-product from Steel factory from Smederevo, Republic of Serbia, on chemical composition of the aerial parts of chard. The effects of metallurgical slag was compared to those of other lime materials (ground limestone and hydrated lime) in combination without and with standard mineral and organic (liquid fish) fertilizers.

## Material and Methods

**Greenhouse experiment.** The study was carried out in pot experiments under semi-controlled conditions in the glasshouse of the Institute of Soil Science (Belgrade in Serbia), from the fourth decade of March to the fourth decade of July, in 2015. In the experiments the comparison of the effect of metallurgical slag (MS) with other lime materials (ground limestone and hydrated lime) in combination with and without mineral NPK [composite NPK (15:15:15)] and organic (liquid fish - LF) fertilizers were studied. The ground limestone (calcium carbonate or calcite,  $\text{CaCO}_3$ ) contains 60% of carbonate. Hydrated lime (slaked lime,  $\text{Ca(OH)}_2$ ) reacts very rapidly and has a TNV (Total Neutralizing Value) of 135, thus 740 kg of hydrated lime is equivalent to one ton of ground limestone i.e. the  $\text{TNV} = 135$  (Culleton *et al.*, 1999).

The experiment was undertaken with 1.4 kg per pot of Stagnosol (WRB, 2014), a type of marginal soil from Western Serbia region that has very low pH and poor physical and biological properties. The following nine designed variants were carried out in three replications: control (untreated soil) - V1; NPK mineral fertilizer - V2;  $\text{CaCO}_3$  - V3;  $\text{Ca(OH)}_2$  - V4; MS - V5; LF fertilizer - V6; NPK mineral fertilizer +  $\text{CaCO}_3$  - V7; NPK mineral fertilizer +  $\text{Ca(OH)}_2$  - V8; NPK mineral fertilizer + MS - V9.

Before sowing the chard, the amount of fertilizers and slag was measured according to the experimental design and mixed with soil (calculated as for 1 ha): NPK fertilizer (15:15:15) = 500 kg ha<sup>-1</sup>; LF fertilizer = 170 kg ha<sup>-1</sup>; CaCO<sub>3</sub> = 4 t ha<sup>-1</sup>; Ca(OH)<sub>2</sub> = 2,8 t ha<sup>-1</sup>; MS = 4 t ha<sup>-1</sup> (same as the amount of CaCO<sub>3</sub>, in spite of lower amount of slag). All three Ca-materials with granulation of 0.2 mm were applied in the experiment.

**Chemical properties of the studied soil.** Chemical characteristics and elemental composition of plowed layer of the Stagnosol used in this study were analyzed and determined in our previous studies (Pivić *et al.*, 2011; 2013). Accordingly, in relation to the reference values suggested by Šestić *et al.* (1969), the soil is characterized by very acid soil reaction, with pH in KCl 4.12, then, potential acidity (Y) and significantly low saturation of CEC, low content of soluble phosphorus and it is well supplied with available potassium.

Certain types of soil, including stagnosols, require the periodic application of soil conditioners such as commercial liming materials to provide aeration, increase moisture retention, and promote root permeation and growth. In several experiments in European countries it was determined the ability of metallurgical slag to raise the pH of acid soils (Rodriguez *et al.*, 1994; National Slag Association, 2011).

**Chemical properties of MS.** Chemical composition of MS used (Table 1) was determined in our previous study (Pivić *et al.*, 2011).

Table 1. Chemical composition of MS (Pivić *et al.*, 2011).

Parameter	Average value
pH in H <sub>2</sub> O	12.48
Total Ca (%)	26.20
Total CaO (%)	36.60
Total CaCO <sub>3</sub> (%)	65.80
Available Ca (%)	17.18
Total Mg (%)	0.41
Available Mg (%)	0.07
Total P <sub>2</sub> O <sub>5</sub> (%)	0.61
Total Fe (%)	15.34
Available Fe (mg kg <sup>-1</sup> )	3.38
Total Mn (%)	1.80
Available Mn (mg kg <sup>-1</sup> )	3.12
Total Zn (%)	14.60
Total Cu (%)	228.8

Accordingly, this material has very alkaline reaction (pH = 12.50), with the content of calcium in oxide forms (CaO) from 33-45%, of which about 50% is easily soluble in 1 M ammonium acetate; content of the total magnesium is about 0.40% and it was mainly in forms of MgO (0.70%); total phosphorous contained in the material is about 0.60%, where nearly all the amount is in available forms for plants; content of the total iron is high (about 15%), with noticeable lower amounts of its soluble forms; manganese is present in total amount of about 1.8% , but with noticeable low amounts of soluble forms; zinc is contained in lower amounts (10-20 mg kg<sup>-1</sup>), while the content of copper is a little higher (about 200 mg kg<sup>-1</sup>).

**Origin and chemical analysis of LF fertilizer.** The settleable faecal fish waste, used as liquid fertilizer in this study, was obtained from the farm growing rainbow trout (*Oncorhynchus mykiss*) in village Krupac, municipality of Pirot. Chemical composition of LF



fertilizer included the following analysis: total nitrogen (N), carbon (C) and sulphur (S) were determined on elemental CNS analyzer Vario EL III (Nelson and Sommers, 1996); available phosphorus (P<sub>2</sub>O<sub>5</sub>) was determined by spectrophotometer and potassium (K<sub>2</sub>O) by flame emission photometry, according to Egner-Riehm (Riehm, 1958), after they were heated to boiling with the mixture of concentrated sulfuric and perchloric acids.

**Plant preparation and analysis.** The aerial parts of chard plants were taken and after drying at 105°C the plant biomass was weighed. For all the plant samples from all the treatments the chemical composition of the aerial parts was analyzed. The content of nitrogen (N) was determined on elemental CNS analyzer Vario EL III (Nelson and Sommers, 1996). Phosphorus (P) and potassium (K) concentrations were determined by so called “wet” combustion, i.e. they were heated to boiling with the mixture of concentrated sulfuric and perchloric acids. In the obtained solution, P was determined by spectrophotometer with molybdate, and K – by flame emission photometry (Riehm, 1958). In the determination of investigated trace biogenic elements - iron (Fe), zinc (Zn) and copper (Cu), as well as cadmium (Cd) as the toxic heavy metal, plant material was converted to a solution by the so-called "dry" combustion, i.e., first by heating at 550°C (for several hours) and then by treating the obtained ash with hydrochloric acid. These elements were determined by atomic absorption spectrometry - AAS (Wright and Stuczynski, 1996).

**Data analysis.** The effects of V1-V9 treatments on the studied chemical parameters of the plants were evaluated using the analysis of variance (SPSS 20.0, Chicago, USA), followed by Duncan's Multiple Range Test (DMRT). Significant differences between means were tested by the LSD test at P = 0.05.

## Results and Discussion

**Chemical composition of LF fertilizer.** By screening the content of the main chemical parameters of faecal fish waste in this study, it was determined its moderate to high quality for use as an organic fertilizer (Table 2).

Table 2. Chemical composition of LF fertilizer.

Parameter	Average value
Total N (%)	3.33
Total C (%)	36.5
Total S (%)	0.36
Available P <sub>2</sub> O <sub>5</sub> (mg 100 g <sup>-1</sup> )	10.2
Available K <sub>2</sub> O (mg 100 g <sup>-1</sup> )	0.12

According to the certain previous studies (Olson, 1992; Westerman *et al.*, 1993) fish fertilizers tend to be highly variable in their chemical content, which is also the case with other manures. The various data demonstrate a wide variability in the general chemical composition of fish manure, although its macronutrients composition is of primary interest, given the end use of the manure as an agricultural fertilizer. As stated by Olson (1992), fish manure contains moderate amounts of essential plant nutrients in dry matter (2.83% N; 2.54% P; 0.10% K; 6.99% Ca; 0.53% Mg), which is similar to the results of the current study. Nevertheless, as suggested by Naylor *et al.* (1999), it is difficult to compare the values from the present study with those from others because of the differences in conditions under which the solids were produced, separated, stored, and collected.

**Chemical composition of chard.** The optimum pH range in soil for growth of most crops in soil is between 5.5 and 7.0, within which most plant nutritives are available (Prasad and Power,

1997). Some trace elements may pose a toxicity threat if present at elevated levels as their availability and mobility increases under acidic conditions (Pawłowski, 1997).

Data on the content of main and beneficial biogenic macroelements in aerial parts of the tested vegetable (Table 4) show the statistically significant differences between the treatments at  $P < 0.05$ , that are due to increased crop yield (their dissolution in plants, especially for some elements: N, K), and due to higher accumulation of some elements and their mobilization from natural soil reserves primarily, as influenced by the additional lime materials in combination with mineral and LF fertilizer. There is a noticeably and statistically significant tendency of an increase in the content of P, K and S tested plant material in the treatment with LF fertilizer in relation to other treatments.

The nature of applied treatments and their combinations have an impact on trace metals accumulation, their mobility and storing capacity in plant tissues (Riesen and Feller, 2005). The concentration of trace metals in chard aerial parts shows that there are statistically significant differences between different treatments at  $P < 0.05$  (Table 5). It should be noted that there was not found higher accumulation of Fe in tested plant in the treatments where metallurgical slag was applied in spite of its significant content in this liming material. According to the reference values of Kloke *et al.* (1984), the concentrations of Cd were within the safety limits and allowed concentrations in all the treatments, which is a highly desirable outcome (Table 5).

Table 4. Effect of applied treatments on the content of macroelements in chard.

Variants	Macroelements (% of dry biomass)				
	N	P	K	C	S
V1	3.79±0.21 <sup>c</sup>	0.14±0.02 <sup>b</sup>	2.11±0.17 <sup>d</sup>	37.27±1.69 <sup>abc</sup>	0.65±0.04 <sup>a</sup>
V2	3.86±0.09 <sup>c</sup>	0.31±0.03 <sup>b</sup>	3.53±0.11 <sup>bc</sup>	39.15±0.35 <sup>a</sup>	0.66±0.01 <sup>a</sup>
V3	4.28±0.19 <sup>b</sup>	0.34±0.02 <sup>b</sup>	3.66±0.27 <sup>b</sup>	35.51±2.46 <sup>c</sup>	0.68±0.10 <sup>a</sup>
V4	4.52±0.13 <sup>b</sup>	0.19±0.01 <sup>b</sup>	2.35±0.26 <sup>d</sup>	35.31±0.31 <sup>bc</sup>	0.61±0.03 <sup>a</sup>
V5	3.81±0.15 <sup>c</sup>	0.17±0.02 <sup>b</sup>	2.28±0.11 <sup>d</sup>	38.33±0.67 <sup>ab</sup>	0.45±0.01 <sup>a</sup>
V6	3.75±0.10 <sup>c</sup>	6.76±0.22 <sup>a</sup>	7.85±0.13 <sup>a</sup>	38.33±0.56 <sup>ab</sup>	1.06±0.04 <sup>a</sup>
V7	3.93±0.12 <sup>c</sup>	0.23±0.07 <sup>b</sup>	3.23±0.19 <sup>c</sup>	39.29±0.50 <sup>a</sup>	0.74±0.10 <sup>a</sup>
V8	5.13±0.17 <sup>a</sup>	0.27±0.04 <sup>b</sup>	3.71±0.07 <sup>b</sup>	39.38±0.73 <sup>a</sup>	0.66±0.07 <sup>a</sup>
V9	3.10±0.01 <sup>d</sup>	0.21±0.03 <sup>b</sup>	1.90±0.03 <sup>e</sup>	36.85±2.01 <sup>abc</sup>	0.57±0.01 <sup>a</sup>
<i>P</i> value	***	***	***	**	NSD
LSD (0.05)	0.242	0.376	0.331	2.191	0.457

\* means ± standard deviation; LSD - least significant difference; value followed by the same letter in a column is not significantly different at  $P < 0.05$ .

Table 5. Effect of applied treatments on the content of trace metals in chard.

Variants	Trace metals (% of dry biomass)			
	Fe	Zn	Cu	Cd
V1	854.33±42.72 <sup>c</sup>	450.64±4.86 <sup>a</sup>	35.61±3.22 <sup>ab</sup>	0.63±0.05 <sup>b</sup>
V2	1609.33±82.77 <sup>a</sup>	386.05±15.42 <sup>b</sup>	37.64±0.32 <sup>a</sup>	0.74±0.04 <sup>a</sup>
V3	513.00±31.56 <sup>e</sup>	323.34±10.16 <sup>c</sup>	39.03±0.41 <sup>a</sup>	0.41±0.02 <sup>e</sup>
V4	741.67±120.09 <sup>d</sup>	327.34±2.50 <sup>e</sup>	32.03±0.84 <sup>bc</sup>	0.52±0.04 <sup>c</sup>
V5	323.67±36.75 <sup>f</sup>	369.95±9.32 <sup>c</sup>	31.85±0.13 <sup>bc</sup>	0.62±0.09 <sup>b</sup>
V6	359.00±35.17 <sup>f</sup>	451.41±5.21 <sup>a</sup>	35.15±3.38 <sup>ab</sup>	0.75±0.02 <sup>a</sup>
V7	959.00±45.57 <sup>b</sup>	348.99±12.00 <sup>d</sup>	29.43±0.49 <sup>c</sup>	0.52±0.03 <sup>c</sup>
V8	493.33±5.13 <sup>c</sup>	293.14±6.11 <sup>f</sup>	30.84±2.02 <sup>bc</sup>	0.51±0.01 <sup>c</sup>
V9	324.00±25.12 <sup>f</sup>	291.37±2.30 <sup>f</sup>	28.61±1.22 <sup>d</sup>	0.44±0.01 <sup>d</sup>
<i>P</i> value	***	***	***	***
LSD (0.05)	98.069	14.82	3.959	0.029

\* means ± standard deviation; LSD - least significant difference; value followed by the same letter in a column is not significantly different at  $P < 0.05$ .

## **Conclusions**

The results of the paper indicate that all Ca-materials studied, including metallurgical slag, along with the studied fertilizers, showed positive effects on the content of main and beneficial biogenic macroelements in aerial biomass of the tested vegetable. There is a noticeably and statistically significant tendency of an increase in the content of P, K and S in tested plant in the treatment with liquid fish fertilizer in relation to other treatments. Also, there was not found higher accumulation of Fe in tested plant material in the treatments where metallurgical slag was applied in spite of its significant content in this liming material. As for Cd, its concentrations were within the safety limits and allowed concentrations in all the treatments, which is a highly desirable outcome. Generally, it was estimated that the studied metallurgical slag of the standardized chemical composition can be added to the acid soils toward amelioration the fertility without adverse effects.

## **Acknowledgement**

This research was carried out with the support of Ministry of Education, Science and Technological Development of the Republic of Serbia and was financed by the Project TR-37006.

## **References**

- Barber S.A. (1984). Liming materials and practices. In, Adams F., "Soil acidity and liming, Second Edition, Agronomy Monograph 12", American Society of Agronomy, Crop Science Society of America, Madison, Wisconsin, 171-210.
- Culleton N., Murphy W.E., Coulter B. (1999). Sources of liming materials. [http://www.fertilizer-assoc.ie/publications/lime\\_in\\_ireland/publications\\_lime\\_report5.htm](http://www.fertilizer-assoc.ie/publications/lime_in_ireland/publications_lime_report5.htm), Accessed on 10.02.2010.
- Kloke A., Sauerbeck D.R., Vetter H. (1984). The contamination of plants and soils with heavy metals and the transport of metals in terrestrial food chains. In, Nriagu J.O., "Changing metal cycles and human health: Dahlem Konferenzen", Springer-Verlag, Berlin, Heidelberg, New York, Tokyo, 113-141.
- Lopez F.A., Balcaza, N., Formoso A., Pinto M., Rodriguez M. (1995). The recycling of Linz-Donawitz (LD) converter slag by use as a liming agent on pasture land. *Waste Management and Research*, 13, 555-568.
- National Slag Association (2011). Use of steel slag in agriculture and for reclamation of acidic lands. [http://www.nationalslag.org/tech/ag\\_guide909.pdf](http://www.nationalslag.org/tech/ag_guide909.pdf), Accessed on 10.02.2010.
- Naylor S., Moccia R.D., Durant G.M. (1999). The chemical composition of settleable solid fish waste (manure) from commercial rainbow trout farms in Ontario, Canada. *North American Journal of Aquaculture*, 61, 21-26.
- Nelson D.W., Sommers L.E. (1996). Total carbon, organic carbon, and organic matter. In, Sparks D.L., "Methods of soil analysis, Part 3", SSSA, Madison, Wisconsin, 961-1010.
- Olson G.L. (1992). The use of trout manure as a fertilizer for Idaho crops. National livestock, poultry and aquaculture waste management: proceedings of the national workshop, July 29-31, 1991, Kansas City, Missouri, USA, pp. 198-205
- Pawlowski L. (1997). Acidification: its impact on the environment and mitigation strategies. *Ecological Engineering*, 8, 271-288.
- Pivić R., Stanojković A., Maksimović S., Stevanović D. (2011). Improving the chemical properties of acid soils and chemical composition and yield of spring barley (*Hordeum vulgare* L.) by use of metallurgical slag. *Fresenius Environmental Bulletin*, 20, 875-885.

- Pivić R., Stanojković-Sebić, Jošić D., Dinić Z. (2013). Evaluation of the chemical composition of cabbage (*Brassica oleracea* L.) as influenced by metallurgical slag application. XV Anniversary Balkan Mineral Processing Congress “The Wave of Changes in Processing and Recycling”, Volume II, Sozopol, Bulgaria, June 12-16, 2013, pp. 659-662.
- Prasad R., Power J.F. (1997). Soil fertility management for sustainable agriculture. CRC Press, Lewis Publishers, Florida.
- Riehm H. (1958). Die Ammoniumlaktatessigsäure-Methode zur Bestimmung der leichtlöslichen Phosphorsäure in Karbonathaltigen Böden. *Agrochimica*, 3, 49-65 (in German).
- Riesen O., Feller U. (2005). Redistribution of nickel, cobalt, manganese, zinc and cadmium via the phloem in young and maturing wheat. *Journal of Plant Nutrition*, 28, 421-430.
- Rodriguez M., Lopez F.A., Pinto M., Balcazar N., Besga G. (1994). Basic Linz - Donawitz slag as a liming agent for pastureland. *Agronomy Journal*, 86, 904-909.
- Šestić S., Glintić M., Manojlović S. (1969). Interpretation of the results of soil analysis. In, “Handbook for systematic control of soil fertility and fertilizers use”, Center for the Improvement of Agricultural Production in Serbia - Professional Board for Control of Soil Fertility and the Use of Mineral Fertilizers, Belgrade, Serbia, 67-80 (in Serbian).
- Troeh F.R., Thompson L.M. (2005). Soils and fertility. Sixth Edition. Blackwell Publishing, New Jersey.
- Westerman P.W., Hinshaw J.M., Barker J.C. (1993). Trout manure characterization and nitrogen mineralization rate. In, Wang J-K., “Techniques for modern aquaculture”, American Society of Agricultural Engineers, St. Joseph, Michigan, 35-43.
- White J.W., Holben F.J., Jeffries C.D. (1937). The agricultural value of specially prepared blast-furnace slag. Bulletin No 341, Agricultural Experiment Station, Pennsylvania State College.
- WRB (2014). World reference base for soil resources - international soil classification system for naming soils and creating legends for soil maps. Food and Agriculture Organization of the United Nations, Rome.
- Wright R.J., Stuczynski T. (1996). Atomic absorption and flame emission spectrometry. In, Sparks D.L., “Methods of soil analysis, Part 3”, SSSA, Madison, Wisconsin, 65-90.

## **INFLUENCE OF 24-EPIBRASSINOLIDE AND MANIPULATION OF ROOT STATUS ON PHOTOSYNTHESIS AND GROWTH OF THE MAIZE PLANTS**

Hadi WAISI<sup>1</sup>, Bogdan NIKOLIĆ<sup>2\*</sup>, Vladan JOVANOVIĆ<sup>3</sup>, Sanja ĐUROVIĆ<sup>2</sup>

<sup>1</sup> Institute for the Development of Water Resources "Jaroslav Černi", Belgrade, Serbia

<sup>2</sup> Institute for Plant Protection and Environment, Belgrade, Serbia

<sup>3</sup> Institute of pesticides, Zemun-Belgrade, Serbia

\* Corresponding author: bogdannik@mail2world.com

### **Abstract**

It is known that brassinosteroid phytohormones can influence the redistribution of mass in the plant, i.e. the so-called source-sink relationships that represent the main determinant of yield of crops. These processes have long been investigated, by various methods, for different levels of material of plants (the subcellular biochemical processes, the cell and culture of plant cells, tissues and organs of plants, whole plants, plant communities-phytocoenoses and agrophytocoenoses), but even today, many details of these processes are unexplained. We have considered here the problems in the corn plants (*Z. mays* L; hyb. ZP704), aged 1-2 months during the experiments, grown in vessels of different volumes ( $V = 5$  or  $11$  l, S and L plants), wherein the part of the plant transplanted from vessels less than vessels having a larger volume (RP plants), thus, we manipulate the status of the root. At the beginning of the test plants were treated with  $10^{-8}$  mol of 24-epibrassinolide (24-EBL) or with  $10^{-6}$  mol propiconazole (PZR), an inhibitor of the biosynthesis of brassinosteroids. During the treatment, we have taken samples for morphometric analysis of plant growth, and we measured Chla fluorescence parameters as indicators of photosynthesis. We note that the manipulation of roots in plants grown in S vessel greatly restricts growth of maize plants stems, roots and leaves, where it is visible to this plant for 2 months fail to enter the generative phase of development, which does not apply to RP and L plant. 24-EBL phytohormones and PZR biosynthesis inhibitor of brassinosteroid synthesis generally act slightly stimulating effect on the growth of plants, wherein it is somewhat more pronounced effect of the PZR. Plants growing in small vessels also has lower values of photosynthesis parameters than in L and RP plants, but treatment of a 24-EBL works more on stimulating photosynthesis, than treatment of PZR.

### **Introduction**

Interrelationships between factors that affect crop growth are complex. The redistribution of assimilates from different plant organs is a key factor in the crop yielding and it depends on the plant hormonal status (particularly brassinosteroids: BRs; Clouse and Sasse, 1998) and the stress and other factor presence (Larcher, 2003). From that point, we investigated maize (ZP704) growth and photosynthesis influenced by root manipulation (Poorter and Nagel, 2000; Farrar and Gunn, 1998) and 24-epibrassinolide (24-EBL) phytohormone and propiconazole (PZR; an inhibitor of the brassinosteroids synthesis; Hartwig et al., 2012) during period of optimal temperature ( $\sim 20-25$  °C) for the maize growth, with the goal of finding new opportunities for increasing corn yield.

## Materials and methods

Maize plants (ZP704) were grown in half-shade ( $PAR_{max} \approx 500 \mu\text{mol photon cm}^{-2} \text{ s}^{-1}$ ) one month in the summer of 2016 close to the our Institute (Belgrade, Serbia) in the pots of V=5 l (2/3 so called “S plants”) and V=11 l (1/3 so called “L plants”), when 1/2 of 5 l plants grown were replanted in V=11 l pots (so called “RP plants”). Then samples for analysis of different morphometric parameters (Lambers et al., 1998) were taken, while the remaining plants were transferred to full daylight ( $PAR_{max} 1500 \text{ mmol photon cm}^{-2} \text{ s}^{-1}$ ). After 7 days of light acclimation, 1/3 of plants were treated with 24-EBL ( $\approx 10^{-8} \text{ mol}$ ) solution, other 1/3 with PZR ( $\approx 10^{-6} \text{ mol}$ ) solution and 1/3 were control (K) plants. Treatment was repeated after 7 days. Then parameters of Chla fluorescence (Maxwell and Johnson, 2000; Lichtenthaler and Miehe, 1997) were measured and calculated. After 2 weeks experiment was finished, with the final Chla fluorescence measurements, together with the final analysis of different morphometric parameters (Lambers et al., 1998).

## Results and discussions

We note that the manipulation of roots in plants grown in S wessel greatly restricts growth of maize plants stems, roots and leaves, where it is visible to this plant for 2 months fail to enter the generative phase of development, which does not apply to RP and L plant (Table 1).

Table 1. Morphometric parameters of plants manipulated by their BRs content and root status

Plant age/ type of treatment	ml	FW (g)				cm	cm <sup>2</sup>
	V of root	root	stem	generativ e organs	leaves	Length of stem	estimated total area of leaves of maize plants
RP day; L/ K	6.4± 3.1	8.75± 6.08	20.61± 9.87	-	21.44± 8.86	21.5± 4.4	1248.1± 550.8
RP day; S/ K	2.1± 1.5	3.51± 2.48	7.06± 4.25	-	7.96± 5.00	16.2± 2.7	647.0± 352.5
Treatment day; L/ K	12.6± 8.9	18.09± 13.09	54.93± 37.58	-	39.73± 23.12	46.0± 27.9	1784.1± 907.1
Treatment day; RP/ K	11.8± 8.5	15.08± 10.74	40.73± 31.03	-	33.08± 19.54	32.7± 10.4	1993.7± 1009.8
Treatment day; S/ K	6.0± 2.5	6.02± 2.67	28.65± 17.25	-	24.16± 10.45	30.2± 6.8	991.7± 106.8
L/ K finish	61.1± 58.2	75.33± 61.19	195.77 ± 117.98	3.35± 3.94	103.09± 44.59	87.1± 21.9	7589.1± 2347.0
RP/ K finish	69.9± 33.8	72.08± 34.86	217.62 ± 80.86	4.88± 3.01	121.19± 34.07	91.3± 31.4	9105.7± 2421.5
S/ K finish	6.0± 2.5	6.02± 2.67	28.65± 17.25	-	24.16± 10.45	30.2± 6.8	3074.3± 1585.9
L/ 24-EBL finish	20.0± 8.7	11.91± 5.64	187.93 ± 78.53	3.50± 3.46	105.48± 32.99	82.1± 19.1	7785.2± 2286.1
RP/ 24-EBL finish	16.1± 9.2	17.29± 10.28	224.81 ± 91.81	7.47± 5.39	124.19± 5.39	88.9± 25.4	8724.1± 1021.4
S/ 24-EBL finish	13.1± 13.4	8.34± 9.79	29.87± 17.51	-	28.31± 13.68	32.7± 9.7	3110.6± 1619.3
L/ PZR	17.2±	16.26±	192.55	2.70±	88.2±	88.2±	7811.8±

finish	9.9	7.55	±70.57	2.78	18.7	18.7	913.9
RP/ PZR finish	18.1± 9.6	16.50± 9.31	253.24 ±139.5 5	6.44± 4.42	90.5± 26.8	90.5± 26.8	8992.7± 2337.4
S/ PZR finish	19.5± 10.4	14.55± 9.14	37.22± 21.42	-	36.0± 9.0	36.0± 9.0	3549.9± 1443.3

\*V: volume of root; FW: fresh weight of a plant organ

24-EBL phytohormones and PZR biosynthesis inhibitor of brassinosteroid synthesis generally act slightly stimulating effect on the growth of plants, wherein it is somewhat more pronounced effect of the PZR (Table 1). Plants growing in small vessels also has lower values of photosynthesis parameters then in L and RP plants, but treatment of a 24-EBL works more on stimulating photosynthesis, then treatment of PZR (Table 2).

Table 2. Parameters of fluorescence of Chla and photosynthesis of plants exposed to manipulation of BRs content and root status

Parameters of Chla fluorescence/ plant age – type of treatment	Fv/Fm	Fv/F <sub>0</sub>	ΦPS2	qP	NPQ	ETR (μmol m <sup>-2</sup> s <sup>-1</sup> )	R <sub>FD730</sub>
Treatment day; L/K	0.80±0.01	3.98±0.32	0.32±0.06	0.68±0.06	1.48±0.46	74.12±12.8 7	2.69±0.33
Treatment day; RP/K	0.79±0.01	3.76±0.26	0.35±0.04	0.77±0.06	1.55±0.34	87.34±18.0 2	2.63±0.96
Treatment day; S/K	0.75±0.02	3.02±0.37	0.32±0.05	0.69±0.04	1.26±0.24	99.21±15.8 9	2.39±0.36
L/K finish	0.77±0.02	3.29±0.32	0.21±0.06	0.59±0.07	1.72±0.41	52.46±16.3 8	2.59±0.40
RP/K finish	0.78±0.01	3.60±0.13	0.15±0.10	0.56±0.12	2.16±0.56	34.41±22.9 4	2.83±0.21
S/K finish	0.7780.01	3.44±0.12	0.25±0.08	0.55±0.17	1.49±0.39	48.97±15.6 2	2.39±0.57
L/24-EBL finish	0.76±0.02	3.26±0.31	0.34±0.06	0.67±0.06	1.14±0.58	75.13±13.7 1	2.33±0.67
RP/24-EBL finish	0.79±0.02	3.76±0.42	0.38±0.12	0.81±0.02	1.60±1.32	98.84±31.4 3	3.16±1.16
S/24-EBL finish	0.77±0.01	3.32±0.24	0.28±0.05	0.70±0.02	1.36±0.37	57.95±11.0 7	2.29±0.25
L/PZR finish	0.76±0.01	3.17±0.12	0.29±0.14	0.68±0.14	1.00±0.73	58.63±27.4 9	2.45±0.26
RP/PZR finish	0.78±0.01	3.49±0.13	0.27±0.12	0.70±0.14	1.67±0.65	67.46±30.4 4	2.64±0.33
S/PZR finish	0.76±0.02	3.26±0.09	0.21±0.08	0.59±0.18	1.71±0.81	44.71±16.2 3	2.47±0.72

Chla: chlorophyll a; Abbreviations of parameters of Chla fluorescence and photosynthesis described in references: Maxwell and Johnson (2000) and Lichtenthaler and Miede (1997)

According our previous results (Nikolić et al., 2014; Waisi et al., 2017) and the observed changes in plant mass allocation and photosynthesis (Table 1 nad 2), induced by root manipulation procedures and influence of changes in plant content of brassinosteroid type phytohormones, we hypotetized that these changes are mediated by their impact on plant energetics (see changes of parameters ETR and R<sub>FD730</sub>). As we know that the plant roots is place of synthesis of phytohormones of cytokinine type with with a strong effect on

photosynthesis processes (Nešković et al., 2003), we next hypothesized that on the redistribution of mass, plant growth and photosynthesis are mostly influenced by the interaction of the phytohormones of the cytokinin and brassinosteroid types, which opens up new possibilities for manipulating the yield of corn plants.

### **Acknowledgement**

This work was supported by the Ministry of Education, Science and Technological Development of the Republic of Serbia (Grants no. TR31018 and 31037).

### **References**

- Clouse S.D. and J.M. Sasse (1998) *Ann. Rev. Plant Physiol. Plant Mol. Biol.*, 49: 427–51.
- Larcher W. (2003) *Physiological Plant Ecology. Ecophysiology and Stress Physiology of Functional Groups*. 4th Ed., Springer, Berlin, Heidelberg, Germany, 2003
- Poorter H. and O. Nagel (2000) *Austral. J. Plant Physiol.*, 27: 595-607.
- Hartwig T., C. Corvalan, N.B. Best, J.S. Budka, J.Y. Zhu, S. Choe and B. Schulz (2012) *PLoS ONE*, 7, 5, e36625. <https://www.ncbi.nlm.nih.gov/pubmed/22590578>
- Lambers, H., Poorter, H. and M.M.I. Van Vuuren (1998) Research on variation in plant growth-introduction. in: *INHERENT VARIATION IN PLANT GROWTH. Physiological mechanisms and ecological consequences*. Lambers, H., Poorter, H. и Van Vuuren, M.M.I., eds., pp. 1-4, Backhuys, Leiden, Holland.
- Farrar, J. and S. Gunn (1998) Allocation: allometry, acclimation-and alchemy? in: *INHERENT VARIATION IN PLANT GROWTH. Physiological mechanisms and ecological consequences*. Lambers, H., Poorter, H. и Van Vuuren, M.M.I., eds., pp. 183-198, Backhuys, Leiden, Holland.
- Maxwell K. and G. Johnson (2000) *J. Exp. Bot.*, 51: 659-668.
- Lichtenthaler H.K. and J.A. Miehe (1997) *Trends Plant Sci*, 2: 316-320.
- Nikolić B., V. Dragičević, H. Waisi, S. Đurović, Z. Milićević, I. Spasojević and M. Brankov (2014) *IMPACT OF ROOT MANIPULATION AND BRASSINOSTEROIDS ON GROWTH, PHOTOSYNTHESIS AND THERMODYNAMICS OF MAIZE AT LOWER TEMPERATURES*. in: *PHYSICAL CHEMISTRY 2014, 12th International Conference on Fundamental and Applied Aspects of Physical Chemistry (ISBN 978-86-82475-31-6)*, eds. Ž. Čupić and S. Anić; September 22-26, 2014, Belgrade, Serbia, pp. 477-481.
- Waisi H, Janković B, Janković M, Nikolić B, Dimkić I, Lalević B, et al. (2017) New insights in dehydration stress behavior of two maize hybrids using advanced distributed reactivity model (DRM). Responses to the impact of 24-epibrassinolide. *PLoS ONE*, 12(6): e0179650. <https://doi.org/10.1371/journal.pone.0179650>.
- Nešković M., Konjević R. and Lj. Čulafić (2003) *Plant Physiology (in Serbian)*. NNK International, Belgrade, Serbia, pp. 586.



## WATER PRODUCTIVITY INDICES OF THE SOYBEAN GROWN ON SILTY CLAY SOIL UNDER SPRINKLER IRRIGATION

Branka KRESOVIĆ<sup>1</sup>, Boško GAJIĆ<sup>2\*</sup>, Angelina TAPANAROVA<sup>2</sup>, Ljubomir ŽIVOTIĆ<sup>2</sup>

<sup>1</sup>Maize Research Institute “Zemun Polje”, Slobodana Bajića 1, 11185 Belgrade, Serbia

<sup>2</sup>University of Belgrade, Faculty of Agriculture, Institute of Soils and Melioration, Nemanjina 6, 11080 Belgrade, Serbia

\*Corresponding author: bonna@agrif.bg.ac.rs

### Abstract

The objective of this research was to compare the effects of different irrigation treatments on soybean [*Glycine max* (L.) Merr.] productivity and water use efficiency on experimental fields of the Maize Research Institute of Zemun Polje (Serbia), in 2007 and 2008. Four irrigation levels were investigated: full irrigation ( $I_{100}$ ), 65% and 40% of  $I_{100}$  ( $I_{65}$  and  $I_{40}$ ) and a rain-fed ( $I_0$ ) system. The crop water use efficiency (CWUE, also known as crop water productivity –CWP), irrigation water use efficiency (IWUE) and evapotranspiration water use efficiency (ETWUE) were used to assess the water productivity of each studied treatment. The efficiency of the same treatment differed between the years as it depended on seasonal water availability, weather conditions and their impact on seed yields. Maximum and minimum yields were obtained in the  $I_{65}$  and  $I_0$  treatments, averaging  $3.41 \text{ t ha}^{-1}$  and  $2.26 \text{ t ha}^{-1}$ , respectively. Water use efficiency values were influenced by the irrigation levels. In general, CWUE values increased with the increased level of irrigation. In both growing seasons, IWUE and ETWUE decreased with increasing the seasonal water consumption and irrigation depth. On average, treatments  $I_{40}$  and  $I_{65}$  resulted in similar or higher CWUE and ETWUE than  $I_{100}$ , in both growing seasons.  $I_{65}$  resulted in the highest IWUE, averaged over the two seasons, while  $I_{100}$  had the lowest IWUE.  $I_{65}$  could be proper for the soybean irrigated in Vojvodina when there is no water shortage and  $I_{45}$  could be used as a good basis for reduced sprinkler irrigation strategy development under water shortage.

**Keywords:** *Limited irrigation, Crop water productivity, Crop water use efficiency*

### Introduction

Drought stress affects soya bean growth and productivity in Serbia as it does in many parts of the world. In Vojvodina, northern part of the Republic of Serbia, agriculture depends mainly on rain. However, the amounts and distribution of rainfall vary from year to year and during growing seasons. In the variable climatic conditions of Vojvodina, in which summers are semi-arid to semi-humid (Bošnjak, 2001), high and stable yields of soybean can be obtained only by irrigation.

In this region, as in many similar regions around the world, the availability of freshwater resources for agricultural use has been decreasing due to climate change and increasing consumption. Therefore improving CWUE is vital for meeting the increasing food and fiber demand. Water deficits often inhibit crop growth and the production potential of agroecosystems, given that most crops are sensitive to a short supply of water in different critical stages of growth. On the other hand, excessive soil moisture tends to increase farming costs and pollute the environment (as fertilizers and other agrochemicals are carried away). As such, improving water productivity (WP), also referred to as water use efficiency (WUE),

is very important in agriculture. The widespread opinion is that increasing water productivity in agriculture is key for mitigating water scarcity and addressing environmental challenges. Numerous experiments (Garcia y Garcia *et al.*, 2010; Kirnak *et al.*, 2010; Candogan *et al.*, 2013) have been conducted at different locations to determine soybean responses under different water management conditions. These studies suggest that limited irrigation during the whole growing season or during a specific growth stage can significantly increase WUE and soybean yields, and that the magnitude of the response to irrigation depends upon climate, rainfall during growing season, soil properties, cultivar genetic, soil and crop management practices, experimental procedures, and other factors. Given that water use efficiency of the same crop differs between regions, a local database of water productivity indices (CWUE, IWUE and ETWUE) needs to be developed (Djaman and Irmak, 2012). Information is lacking on the impact of different irrigation levels on soybean yield and water use efficiency in the Vojvodina region. Therefore, the objective of the present research was to determine and compare water productivity indices of soybean under full and deficit sprinkler irrigation and rainfed conditions in a temperate environment of Vojvodina. The results of this study can help better estimate crop yield response to the amount of water added by irrigation in local farming conditions.

## Material and Methods

### Site description

The study carried out in Maize Research Institute of Zemun Polje (Serbia) for two growing seasons (2007, 2008). The soil is classified as a calcaric, silty clay Chernozem and exceeded 1.2 m-depth. The averaged soil water content of the top 0.6 m soil, measured by a pressure plate extractor, is 35% by volume at  $-0.033$  MPa (field capacity – FC), and 15% at  $-1.5$  MPa (permanent wilting point – PWP) (Kresović *et al.*, 2016). The climate is moderate continental influenced by the Mediterranean (Kresović *et al.*, 2016).. Figure 1 shows average monthly temperatures and precipitation levels in 2007 and 2008 growing seasons for the period April-September.

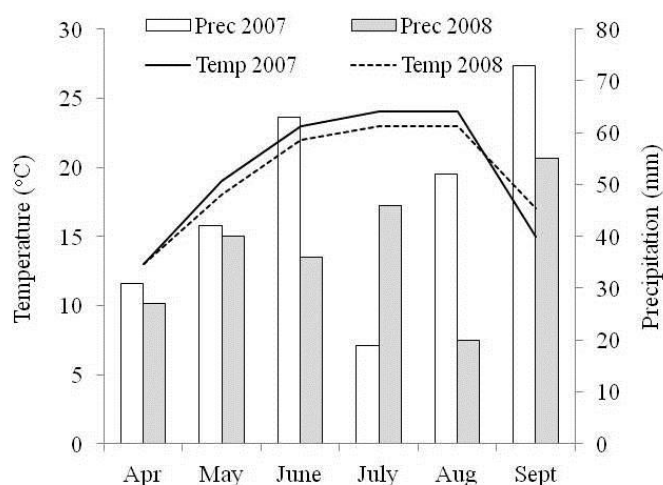


Figure 1. Average monthly temperatures and precipitation during study growing periods.

### Experiment plan

Comparisons were made between four irrigation regimes: full irrigation ( $I_{100}$ ), 65% and 40% of  $I_{100}$  ( $I_{65}$  and  $I_{40}$ ) and no irrigation – rainfed ( $I_0$ ). The setup was of a randomized complete block design, and each treatment was replicated four times. Each experimental plot was designed 7.14 m long and 8.0 m wide ( $57.12$  m<sup>2</sup>). Irrigation amount and time were determined

based on the soil water content in the effective zone of the root system (0–60 cm deep). The amount of water then given to the full  $I_{100}$  treatments was calculated to refill the root zone close to the field capacity. The total water amount applied was 50, 80 and 135 mm in 2007 season, and 95, 160 and 235 mm in 2008 season for  $I_{40}$ ,  $I_{65}$  and  $I_{100}$ , respectively. Irrigation was applied using hand-move sprinkler irrigation systems with sprinkler heads on a 12 m × 12 m square grid. Sprinkler heads (Model RINKA), with two nozzles (4 mm × 3.2 mm), were mounted on 2.8 m higher risers, and the operating mean pressure was 350 kPa with a flow rate of 1.47 m<sup>3</sup> h<sup>-1</sup>.

Soybean cv. Nena (MG II) of Maize Research Institute “Zemun Polje” company was sown on 24 April 2007 and 6 May 2008 with a four-row planter with 0.5 m row and the seeding rate was 4.45 seed m<sup>-2</sup>. Seed yield was measured by harvesting an area of 5.0 m<sup>2</sup> per plot. Hand-harvest took place on 18, and 15 October, respectively for the two seasons. Seed yield was normalized for 13% seed water content.

#### Water use efficiency indices

CWUE, IWUE and ETWUE were used to assess the efficiency and productivity of soybean in different irrigation treatments. CWUE (kg m<sup>-3</sup>) was calculated using the following equation (Boss, 1985):

$$CWU = Y/ETa \quad (1)$$

where  $Y$  - seed yield (kg m<sup>-2</sup>),  $ETa$  - crop water demand, expressed as seasonal actual evapotranspiration under varying irrigation regimes (mm).

$ETa$  was calculated with the soil water balance equation:

$$ETa = P + I \pm \Delta SW \quad (2)$$

where  $P$  - precipitation (mm),  $I$  - amount of irrigation water applied (mm),  $\Delta SW$  - variation in water content (mm) of the soil profile.

To help account for the irrigation component on CWP, Boss (1985) suggested two new indices – irrigation water use efficiency (IWUE) and evapotranspiration water use efficiency (ETWUE):

$$IWUE = (Y_i - Y_r)/I \quad (3)$$

$$ETWUE = (Y_i - Y_r)/(ET_i - ET_r) \quad (4)$$

where IWUE and ETWUE are expressed in kg m<sup>-3</sup>,  $Y$  - yield by treatment (kg m<sup>-2</sup>),  $ETa$  and  $I$  are the seasonal actual evapotranspiration and the amount of water added by irrigation per treatment (mm), and subscripts  $i$  and  $r$  denote the level of irrigation (or lack thereof).

The ANOVA was performed at  $p \leq 0.05$  level of significance to determine whether differences existed among treatments means. Regression analysis was used to evaluate water seed yield–irrigation water and water productivity indices–seed yield and irrigation depth. All the analyses were done using a statistical software package (SPSS windows version).

## Results and Discussion

### Treatment effects on seed yield

There was a highly significant increase in yields as the irrigation level increased from  $I_0$  to  $I_{65}$ , but dropped at full irrigation in both years (Fig. 2). In this research, adding irrigation water for maintaining soil moisture at 65% of full irrigation ( $I_{100}$ ) was enough for soybean water needs, since the further increment of water completed with yield reduction by 2.8% (2007) and 16.2% (2008) as compared to  $I_{65}$ . Therefore, in normal climatic year 80 mm of irrigation application amount is enough to compensate the shortage of rainfall in growing season. Although  $I_{65}$  received about 69% and 47% less irrigation water applied to the  $I_{100}$  plots, seed yield was increased by an average of 2.9% and 19.3%, respectively. In 2007 growing season, there was no statistical difference between  $I_{65}$  and full irrigated treatment at a significance level of 0.05 (data not shown), which supports the finding that limited irrigation can be effectively used to conserve water with minimal to no effect on seed yield. However,  $I_{40}$ ,  $I_{65}$  and  $I_{100}$  were statistically different from rainfed conditions, with mean differences of 0.96, 1.15 and  $0.84 \text{ t ha}^{-1}$ , respectively.

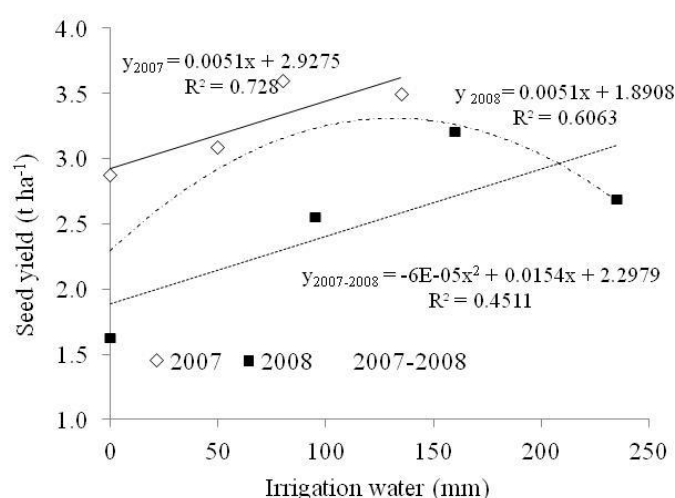


Figure 2. The relationship between soybean seed yield and seasonal irrigation.

Kranz and Benham (2004) reported that irrigation and/or high amounts of rainfall during vegetative growth of soybean are not normally beneficial except during periods when soil water contents are extremely low. Excessive water during the vegetative stage stimulates vegetative growth and increases the potential for water logging and fungal diseases with essentially no increase in seed yield. In some cases, excessive early season precipitation and/or irrigation can lead to seed yield reduction.

A similar effect of water deficit and drought-stress on soybean seed yields was also observed by other researchers (Sincik *et al.*, 2008; Kirnak *et al.*, 2010; Candogan *et al.*, 2013). To determine the effect of irrigation water on soybean yield, regression analysis was utilized and test results indicated statistically significant good linear relationship between seed yield and irrigation treatments with  $R^2 = 0.73$  and  $R^2 = 0.61$  for 2007 and 2008, respectively (Fig. 2). Similar to our results, Dogan *et al.* (2007) reported linear relationship between seed yield and seasonal irrigation water for soybean grown under semi-arid climatic conditions, Quadratic relationships between soybean seed yield and seasonal irrigation water also were observed Gercek *et al.* (2009) in semi-arid climate (Sanliurfa, Turkey).

#### Treatment effects on CWUE

In 2007 growing season, CWUE was higher than in 2008 (28%, 20%, 17%, and 37 % for  $I_0$ ,  $I_{40}$ ,  $I_{65}$ , and  $I_{100}$ , respectively) due to better climatic conditions that were favourable to carbon assimilation and photosynthesis (Fig. 3). The large variations in CWUE and seed yield between growing seasons can be attributed to seasonal differences in air temperature and the

distribution of rain during the grain-filling period. In both growing seasons CWUE increased with irrigation depth, reached maximum values in treatment I<sub>65</sub> and then gradually declined as the amount of water added by irrigation increased. CWUE values of I<sub>65</sub> were higher than the other treatments with the percentage of 4.6–19.4% and 8.4–40.1% for the same years, respectively. In the relatively wet season (2007) no significant difference was found between treatment I<sub>0</sub> and I<sub>40</sub>.

Comparable to our results, Sincik *et al.* (2008) and Demirtas *et al.* (2010) reported significantly lower WUE values of deficit irrigated soybean in a sub-humid environmental conditions of Turkey, which ranged from 0.46 to 0.58 kg m<sup>-3</sup> and from 0.41 to 0.64 kg m<sup>-3</sup>, respectively. Our results are in agreement with those of Katerji and Mastrorilli (2009), who reported WUE values for soybean of 0.73 (clay soil) and 0.81 kg m<sup>-3</sup> (loam soil).

The regression analysis in Fig. 4 shows a linear CWUE increase with seed yield ( $R^2 = 0.06$ ) in 2008 growing season, while the CWUE decreased linearly with seed yield in 2007 ( $R^2 = 0.03$ ) and irrigation in both study seasons ( $R^2 = 0.40$  and  $R^2 = 0.17$ , respectively). The relationship between CWUE and seed yield and seasonal irrigation was poor in both growing seasons. Payero *et al.* (2005) also reported poor the relationship between CWP and seasonal irrigation of deficit irrigated soybean grown in the semi-arid environment of west-central Nebraska. Howell (2001) reported that irrigation can be an effective resource to improve WUE through increasing crop yield especially in arid and semi-arid environments. Even in humid and sub-humid environments, irrigation is particularly effective in overcoming short-duration droughts. However, irrigation by itself may not always produce the highest WUE possible.

#### Treatment effects on IWUE

Results obtained in this experiment indicate that irrigation regimes significantly ( $p < 0.05$ ) affected IWUE in both growing seasons (Fig. 3). Lower IWUE values observed in 2008 (drier season) than in the 2007. Large variation in IWUE values was found as a result of significant differences in applied irrigation water across growing seasons. IWUE is affected not only by the irrigation depth, but also by the amount of rainfall during the growing season. However, IWUE can be inconsistent because of potential out-of-purpose use of irrigation water (e.g. soil water retention, deep percolation, excessive soil water evapotranspiration, runoff, etc.) (Howell *et al.*, 1990). In deficit irrigated treatments, greater IWUE values were obtained as it was determined by different researchers (Sincik *et al.*, 2008; Gercek *et al.*, 2009). Treatment I<sub>65</sub> resulted in the highest IWUE values in both growing seasons. Due to more severe climatic conditions in 2008 growing season, the soybean responded more favorably to irrigation water, resulting in higher IWUE values for I<sub>40</sub> and I<sub>65</sub> than for the fully irrigated treatment. In a relatively dry 2008 no significant difference was found between treatment I<sub>40</sub> and the rainfed. Treatment I<sub>65</sub> is the most efficient in IWUE with the value of 0.90 and 0.98 kg m<sup>-3</sup> for 2007 and 2008 growing season, respectively. IWUE values of I<sub>65</sub> were higher than the other treatments with the percentage of 1–18% (in 2007) and 16–30% (in 2008) for the same growing seasons, respectively.

In general, the IWUE values from this research were higher than many of the values reported in the literature (Evelt *et al.*, 2000; Sinick *et al.*, 2008; Demirtas *et al.*, 2010). Higher values for IWUE in this study were because we applied less irrigation water during growing seasons (50–235 mm), whereas Evelt *et al.* (2000) applied 371–671 mm of water for different irrigation regimes, Sincik *et al.* (2008) applied 160–464 mm for a deficit irrigated treatments and Demirtas *et al.* (2010) applied 428–453 mm for well-watered soybean grown in sub-humid environment (western Turkey) under a drip irrigation system. Our findings are between values for IWUE ranging from 0.07 to 1.04 kg m<sup>-3</sup> (average 0.56 kg m<sup>-3</sup>) for a soybean estimated from results obtained by Pejić *et al.* (2012), where the soil and climate conditions are similar location as our research.

Figure 4 shows a linear increase in IWUE with seed yield, while the IWUE decreased linearly with irrigation in both growing seasons. There was good linear relationship between IWUE and seed yield for 2007, but not for 2008 (Fig. 4). In addition, good linear relationship was observed between IWUE and irrigation water for 2008, but not for 2007 (Fig. 4).

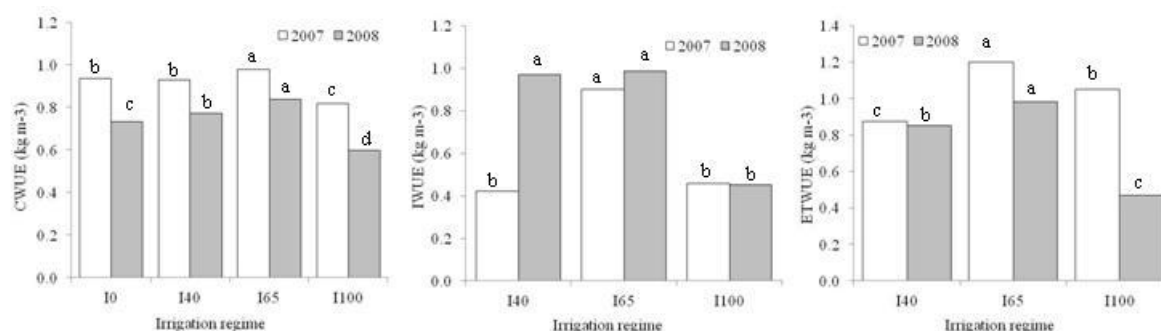


Figure 3. CWUE, IWUE and ETWUE indices of soybean in different irrigation treatments. Histograms with the different letters denote the significant differences between treatments according to LSD test ( $p < 0.05$ ).

#### Treatment effects on ETWUE

Observed soybean crop cumulative  $ETa$  values ranged from 308 to 427 mm in 2007, and from 227 to 450 mm in 2008 season (data not shown). The  $I_{100}$  treatment resulted in the highest seasonal  $I$  and crop  $ETa$ , while the lowest values were obtained for the  $I_0$  treatments for both the years. The irrigation water and crop  $ETa$  values of all deficit irrigated treatments were clearly less than that of the full irrigated ( $I_{100}$ ) treatment for both years.

In these research, ETWUE of soybean varied from  $0.88 \text{ kg m}^{-3}$  at  $I_{40}$  to  $1.05 \text{ kg m}^{-3}$  at  $I_{100}$  in 2007 (Fig. 3). The highest ETWUE values, averaging 1.20 and  $0.98 \text{ kg m}^{-3}$ , was obtained for treatment  $I_{65}$  in both years; while the lowest value was found for treatment  $I_{40}$  ( $0.88 \text{ kg m}^{-3}$ ) in 2007 and  $0.47 \text{ kg m}^{-3}$  in full irrigated treatment in 2008 season. The results of this research are similar to those of Pejić *et al.* (2012).

There was good linear relationship between ETWUE and seed yield for 2007 ( $R^2 = 0.92$ ), but not for 2008 ( $R^2 = 0.29$ ) (Fig. 4). The relationship between ETWUE and irrigation water was not consistent across the two seasons. Figure 4 shows a linear increase in ETWUE with seed yield in both growing seasons and irrigation ( $R^2 = 0.15$ ) in 2007, while the ETWUE decreased linearly with irrigation water ( $R^2 = 0.56$ ) in 2008 growing seasons. Differences in CWUE, IWUE and ETWUE across growing seasons are partially due to weather differences.

### Conclusions

This study indicated that irrigation is necessary for soybean cultivation because rainfall is insufficient to meet the crop water needs. In general, CWUE, IWUE and WUE of the deficit irrigated treatments ( $I_{40}$  and  $I_{65}$ ) were higher than those of the fully irrigated treatments ( $I_{100}$ ). In terms of crop response to irrigation levels, the  $I_{65}$  treatment is viable practice in increasing yield and WUE of soybean with sprinkler irrigation under the conditions experimentation took place. The results show that under limited water situation,  $I_{40}$  is an acceptable irrigation strategy to increase seed yield and WUE. In brief, the overall results indicated that the irrigation water was used effectively in deficit irrigated treatments in comparison to the full irrigated treatment ( $I_{100}$ ).

### Acknowledgement

Angelina Tapanarova undertook this research as a part of her PhD studies under the supervision of Dr. Branka Kresović. This study was carried out as a part of the Maize Institute in Zemun Polje project, entitled “Development of new lines of maize, soya bean and other field crops” and Contract Nos. III 43009 and TR 31037, both supported by the Ministry of Education, Science and Technological Development of the Republic of Serbia.

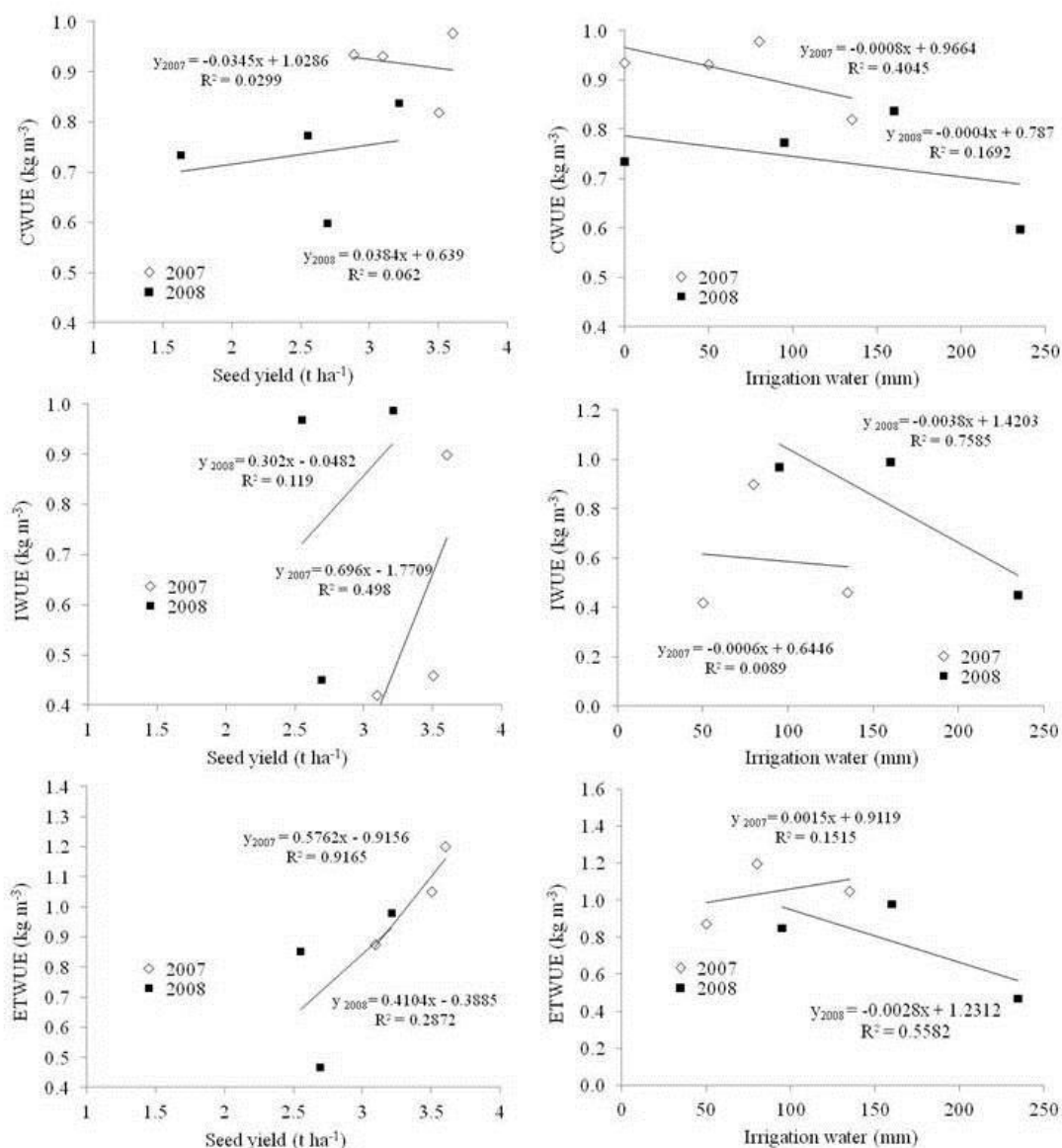


Figure 4. Relationship between seed yield (left) and irrigation water (right) vs. crop water use efficiency (CWUE), irrigation water use efficiency (IWUE), and evapotranspiration water use efficiency (ETWUE).

### References

- Bos, M.G. (1985). Summary of ICID definitions of irrigation efficiency. ICID Bull, Vol. 34(1), pp. 28–31.

- Bošnjak, Đ. (2001). The problems of drought in the Vojvodina Province and drought control measures. *Zbornik radova Naučnog instituta za ratarstvo i povrtarstvo*, Vol 35, pp. 391–402.
- Candogan, B.N., Sincik, M., Buyukcangaz, H., Demirtas, C., Goksoy, A.T., Yazgan, S. (2013). Yield, quality and crop water stress index relationships for deficit-irrigated soybean [*Glycine max (L.) Merr.*] in sub-humid climatic conditions. *Agric. Water Manage.*, Vol. 118, pp. 113–121.
- Demirtas, C., Yazgan, S., Candogan, B.N., Sincik, M., Buyukcangaz, H., Goksoy, A.T. (2010). Quality and yield response of soybean (*Glycine max L. Merrill*) to drought stress in sub-humid environment. *Afr. J. Biotechnol.*, Vol. 9(41), pp. 6873–6881.
- Djaman, K., Irmak, S. (2012). Soil water extraction patterns and crop, irrigation, and evapotranspiration water use efficiency of maize under full and limited irrigation and rainfed settings. *Trans. ASABE*, Vol. 55(4), pp. 1223–1238.
- Dogan, E., Kirnak, H., Copur, O. (2007). Effect of seasonal water stress on soybean and site specific evaluation of CROPGRO-Soybean model under semi-arid climatic conditions. *Agr. Water Manage.*, Vol. 90(1–2), pp. 56–62.
- Evet, S.R., Howell, T.A., Schneider, A.D., Upchurch, D.R., Wanjura, D.F. (2000). Automatic Drip Irrigation of Corn and Soybean. In: *Proceedings of the 4th Decennial National Irrigation Symposium*, 14-16 November, Phoenix, AZ, USA, pp. 401–408
- Garcia y Garcia. A., Persson, T., Guerra, L.C., Hoogenboom, G. (2010). Response of soybean genotypes to different irrigation regimes in a humid region of the southeastern USA. *Agr. Water Manage.*, Vol. 97(7), pp. 981–987.
- Gercek, S., Boydak, E., Okant, M., Dikilitas, M. (2009). Water pillow irrigation compared to furrow irrigation for soybean production in a semi-arid area. *Agr. Water Manage.*, Vol. 96(1), pp. 87–92.
- Howell, T.A. (2001). Enhancing water use efficiency in irrigated agriculture. *Agron. J.*, Vol. 93(2), pp. 281–289.
- Howell, T.A., Cuenca, R.H., Solomon, K.H. (1990). Crop yield response. Management of farm irrigation systems. *ASAE Mono*, St. Joseph, MI, pp. 93–122.
- Katerji, N., Mastrorilli, M. (2009). The effect of soil texture on the water use efficiency of irrigated crops: Results of a multi-year experiment carried out in the Mediterranean region: Review and analysis. *Eur. J. Agron.*, Vol. 30(2), pp. 95–100.
- Kirnak, H., Dogan, E., Turkoglu, H. (2010). Effect of drip irrigation intensity on soybean seed yield and quality in the semi-arid Harran plain, Turkey. *Span. J. Agric. Res.*, Vol. 8, pp. 1208–1217.
- Kranz, B., Benham, B. (2004). Does irrigation improve soybean yields? *Proceedings of the 16th Annual Central Plains Irrigation Conference & Exposition*, pp. 8–17.
- Kresović, B., Tapanarova, A., Tomić, Z., Životić, Lj., Vujović, D., Sredojević, Z., Gajić, B. (2016). Grain yield and water use efficiency of maize as influenced by different irrigation regimes through sprinkler irrigation under temperate climate. *Agric. Water Manage.*, Vol. 169, pp. 34–43.
- Payero, J.O., Melvin, S.R., Irmak, S. (2005). Response of soybean to deficit irrigation in the semi-arid environment of west-central Nebraska. *Trans. ASABE*, Vol. 48(6), pp. 2189–2203.
- Pejić, B., Bošnjak, Đ, Mačkić, K., Rajić, M., Josipović, M., Jug, I., Maksimović, L. (2012). Yield and water use efficiency of irrigated soybean in Vojvodina, Serbia. *Ratarstvo i povrtarstvo*, Vol. 49, pp. 80–85.
- Sincik, M., Candogan, B.N., Demirtas, C., Büyükcangaz, H., Yazgan, S., Göksoy, A.T. (2008). Deficit irrigation of soybean [*Glycine max (L.) Merr.*] in a sub-humid climate. *J. Agron. Crop Sci.*, Vol. 194(3), pp. 200–205.



## PRODUCTIVITY OF BIRDSFOOT TREFOIL ON ACID SOILS

Dalibor TOMIĆ\*, Vladeta STEVOVIĆ, Đorđe LAZAREVIĆ, Dragan ĐUROVIĆ, Pavle MAŠKOVIĆ

University of Kragujevac, Faculty of Agronomy, Cara Dušana 34, Čačak, Serbia

\*Corresponding author: dalibort@kg.ac.rs

### Abstract

The aim of the experiment was to analyze forage yield, seed yield and seed yield components of the cultivars of birdsfoot trefoil (*Lotus corniculatus* L.) grown in combined production for forage and seed on acid soil. The field trial was established in 2012 in Čačak city area (Serbia) in a randomized block design with three replications on the loessivized vertisol with acid reaction (pH in H<sub>2</sub>O 4,8). Trefoil cultivars (K-37 and Rocco) were seeded in a 20 cm row distance with 10 kg ha<sup>-1</sup> of seed. In the year of planting, due to an expressed dry period, there was no yield, and the analyses were done in the second and the third year of cultivation. Forage yield of birdsfoot trefoil in the first cut in the second year of production was low, which was also the result of the long dry period in the previous year. However, the relatively high seed yield in the second growth in the second year of the cultivation and high forage yield in the third year of the cultivation indicated that the trefoil was largely tolerant to condition of acid soils. The cultivars did not differ among themselves significantly in terms of forage yield. Significant differences between the cultivars were recorded in terms of dry matter content in the time of the cutting. The cultivars also differed among themselves in terms of the seed yield, which was the consequence of the differences in the number of stems per unit area and the number of seeds per pod.

**Keywords:** *birdsfoot trefoil, yield, forage, hay.*

### Introduction

Birdsfoot trefoil (*Lotus corniculatus* L.) is a perennial forage legume which is widespread in the world. In Serbia, there are no reliable statistics about the surface where it is grown and yields, but it is considered that among perennial forage legumes it takes the third place according to prevalence, after alfalfa and red clover. It is particularly important plant in the hilly and mountainous regions of Serbia (Petrović et al., 2011), given that is used for establishing of grassland in the conditions bad for alfalfa (Dimitrova, 2010). According to Vučković (2004) the average forage yields of birdsfoot trefoil ranging from 35 to 40 t ha<sup>-1</sup>, and hay 8-10 t ha<sup>-1</sup>. Mijatović (1975) points out that on the basis of the four-year results, production potential of birdsfoot trefoil on eroded land in the hilly area is higher by 25.5 % in comparison to alfalfa.

Soil acidity is one of the factors that limit the cultivation of many cultivated plants. According to Vučković et al. (2005) birdsfoot trefoil is tolerant towards the alkaline reaction, up to pH 9 as well as towards the acid reaction, up to pH 4, but according to Hall (2004) it gives the best yields on the soils which pH is around 7. Đukić et al. (2009) point out that nitrogen fixation and adoption of phosphorus at birdsfoot trefoil plants is highest when the pH value is between 4.8 and 7.4. Stevanović et al. (1995) reported that from 4 700 000 ha of cultivated area in Central Serbia and Kosovo, over 2 800 000 ha are acid soils, which is more than 60%, of which around 30% are extremely acid soils. The aim of the work was to analyze the forage

yield, hay yield and seed yield of birdsfoot trefoil cultivars in the crop grown on the acid soil for combined production of fodder and seed.

### Materials and methods

The experiment was established in Čačak (43°54'39.06" N, 20°19'10.21" E, 246m a.s.l.) in 2012, on the loessivized vertisol type of soil, with the acid reaction (pH in H<sub>2</sub>O 4.8), which contains 3.18% of organic matter, 0% CaCO<sub>3</sub>, 22.08 mg P<sub>2</sub>O<sub>5</sub>, 30.0 mg K<sub>2</sub>O 100 g<sup>-1</sup> of soil, 12 mg kg<sup>-1</sup> Al and 1,111 mg kg<sup>-1</sup> Mn. The main tillage of soil was carried out to a depth of 30 cm. Together with the main tillage and after everyone of the vegetations 300 kg ha<sup>-1</sup> of N<sub>15</sub>P<sub>15</sub>K<sub>15</sub> were incorporated into the soil. Two cultivars of birdsfoot trefoil were used: K-37 (Institut for forage crop Kruševac) and Rocco (Italian variety). The field experiment was set up using a randomized block design with three replications with plot size of 5m<sup>2</sup> (5x1m). Sowing was done at a distance of 20 cm of interrow spacing, with the seeds amount of 10 kg ha<sup>-1</sup>. Weed control was done mechanically on two occasions. The crop was grown without irrigation. Mean annual air temperature and the amount of annual precipitation in the period of performing the experiments are shown in the Table 1.

Table 1. Precipitation and mean monthly temperatures during period of 2012-2014.

Month	1	2	3	4	5	6	7	8	9	10	11	12	$\bar{x}$ i $\Sigma$	
2012	t (°C)	1.8	-2.5	6.8	12.2	17.3	24.1	26.6	25.4	20.9	13.8	9.5	1.4	13.12
	P (L m <sup>-2</sup> )	60.0	70.0	10.0	47.0	68.0	38.0	22.0	0	7.2	30.0	23.7	87.6	463.5
2013	t (°C)	3.5	3.8	6.6	13.2	18.2	20.6	23.3	24.1	17.2	14.5	8.9	2.0	12.99
	P (L m <sup>-2</sup> )	51.0	68.0	65.7	37.0	78.5	61.5	10.0	62.5	87.0	17.0	40.5	4.0	582.7
2014	t (°C)	4.0	6.6	10.2	12.8	16.1	21.1	22.7	22.1	20.1	15.1	8.9	3.1	13.6
	P (L m <sup>-2</sup> )	21.5	6.0	52.5	105	125	103	163	56.0	101	50	19	90	892

In the year of planting, due to expressed dry period, there were no yield, and the analyzes were done in the second and the third year of cultivation. The first growth in the second year and everyone of the three growth in the third year of cultivation were cut in the optimal stage for forage production. Forage yield was determined by measuring the total mass from the plot immediately after cutting and converted to forage yield in t ha<sup>-1</sup>. After drying the sample at the room temperature, hay yield (t ha<sup>-1</sup>) and dry matter content in the forage (the share of hay in the total forage yield) (%) was recalculated.

The second increase in the second year of growing was used for the seed production. Following yield components were determined: stems number m<sup>-2</sup> and inflorescences number m<sup>-2</sup> (by counting on the area of 0.2 m<sup>2</sup> per elementary plot), inflorescences number per stem and the pods number per inflorescence (counting on the ten randomly selected stems from elementary plot). In the laboratory were determined: flowers number per inflorescence and seeds number per pod (in the sample of ten inflorescences per elementary plot), as well as the thousand seeds weight (based on the mass of 5x100 seeds). The potential seed yield was determined on the basis of components of yield (inflorescences number m<sup>-2</sup>, pods number per inflorescence, seeds number per pod, thousand seed weight) and recalculated on the seed yield in kg ha<sup>-1</sup>.

The obtained results were processed with the analysis of variance of one-factorial experiment using SPSS software (1995).

### Results and discussion

Cultivars of birdsfoot trefoil did not significantly differ among themselves in terms of forage and hay yield in the first cut in the second year of cultivation, although the variety Rocco had

a significantly higher content of dry matter in the forage (Tab. 2). Forage yield and hay yield in the first cut in the second year of cultivation were low (forage yield was 12.5 t ha<sup>-1</sup> in the variety K-37 and 13.85 t ha<sup>-1</sup> in the variety Rocco, and hay yield 2.47 t ha<sup>-1</sup> in the variety K-37 and 3.06 t ha<sup>-1</sup> in the variety Rocco). The low yield is the result of a long and expressed dry period in the previous year.

Table 2. Forage yield, hay yield and dry mater content in forage of birdsfoot trefoil cultivars in the first cut in second year of cultivation.

		Forage yield (t ha <sup>-1</sup> )	Hay yield (t ha <sup>-1</sup> )	Dry mater content (%)
Cultivar	K-37	12,5	2,47	19,87b
	Rocco	13,85	3,06	22,16a

The values denoted with different small letters within columns are significantly different (P≤0.05) in accordance with the LSD test

In the third year of cultivation in all of the cuts, there were no significant differences reported between the cultivars in terms of yield of forage and hay (Tab. 4). A significantly higher content of dry matter in the forage was reported in the first and second cut in the variety Rocco. In contrast to the relatively low yield of forage and hay in the second year of cultivation, in the third year was reported a satisfactory yield of forage and hay, due to the favorable weather conditions. The highest yield of forage and hay was reported in the first cut, slightly lower in the third and the lowest in the second cut. The total forage yield in the third year of cultivation was 54.06 t ha<sup>-1</sup> in the variety K-37 and 57.06 t ha<sup>-1</sup> in the cultivar Rocco, respectively hay yield was 10.62 t ha<sup>-1</sup> in the variety K-37 and 12.38 t ha<sup>-1</sup> in the variety Rocco. Similar results also had Radović et al. (2007), who reported the average yield of cultivars of birdsfoot trefoil of 53.85 t ha<sup>-1</sup> in the third year of production on the degraded alluvium. According to Đukić et al. (2007), cultivar K-37 can give the forage yield of 69.4 t ha<sup>-1</sup> and 13.2 t ha<sup>-1</sup> of hay per year.

The total yield of the hay in the third year of production in our experiment was 10.62 t ha<sup>-1</sup> in the variety K-37 and 12.38 t ha<sup>-1</sup> in the variety Rocco. Balan et al. (2002) reported that average yields of dry mater of the examined genotypes of birdsfoot trefoil ranged from 5.4 to 5.8 t ha<sup>-1</sup>. Higher yield of forage and hay in our experiment was the consequence of good supply of nutrients and water in soil, regardless of the acid reaction, as well as favorable weather conditions with sufficient rainfall in 2014.

Table 3. Seed yield and yield components of birdsfoot trefoil cultivars in the second growth in the second year of cultivation

		SNM	INS	INM	FNI	PNI	SNP	TSW	SY
Cultivar	K-37	823	1,77	1427	2,64	2,51	15,04	1,22	655b
	Rocco	949	1,78	1695	3,27	2,59	17,82	1,25	990a

SNM - stem number m<sup>-2</sup>, INS - inflorescence number per stem, INM - inflorescence number m<sup>-2</sup>, FNI - flower number per inflorescence, PNI - pod number per inflorescence, SNP - seed number per pod, TSW - thousand seed weight (g), SY- seed yield (kg ha<sup>-1</sup>). The values denoted with different small letters within columns are significantly different at (P≤0.05) in accordance with the LSD test.

Birdsfoot trefoil cultivars did not significantly differ among themselves in terms of the seed yield components in the second cut in the second year of cultivation (Tab. 3). Potential seed yield (calculated on the basis of yield components) was 655 kg ha<sup>-1</sup> in variety K-37 and 990 kg ha<sup>-1</sup> in the variety Rocco. Differences in seed yield were primarily due to differences in the number of stems per unit area and the seeds number per pod. In full maturity pods easily shatter

an seeds effuse. Shattering problem significantly limits the successful production of seeds (Fairey, 1994). According to Winch et al. (1985) losses in harvesting birdsfoot trefoil seeds are large, ranging up to 85 % of potential yield. In this paper, the birdsfoot trefoil seed yield is presented, recalculated on the basis of yield components, without taking into account the losses at harvest. According to Turkington and Franco (1980) and Gullien (2007) potential seed yield of birdsfoot trefoil is estimated at 1200 kg ha<sup>-1</sup>, while the average harvested yields on the global level are below 200 kg ha<sup>-1</sup>. According to McGraw et al. (1986), the average yield of birdsfoot trefoil seed varies from 50-175 kg ha<sup>-1</sup>, or in average it is about 100 kg ha<sup>-1</sup> of seed. Seaney and Henson (1970) state that seed yields of birdsfoot trefoil range from 50-560 kg ha<sup>-1</sup>. Seed yields of birdsfoot trefoil in USA range from 50 to 170 kg ha<sup>-1</sup> (Fairey and Smith, 1999), in Uruguay between 120 and 150 kg ha<sup>-1</sup> (Garcia et al., 1991; Artola, 2004) and in Argentina between 25 and 150 kg ha<sup>-1</sup> (Mazzanti et al., 1988). According to Vojin et al. (2001), in agro-ecological conditions of Serbian Republic in the area of Banja Luka, there was a birdsfoot trefoil seed yield of 272 kg ha<sup>-1</sup>. In Republic of Serbia, seed yield ranges from 100-280 kg ha<sup>-1</sup> (Vučković et al., 1997). According to Miladinović (1967), with full agrotechniques, seed yields of birdsfoot trefoil in the Republic of Serbia could reach even more than 350 kg ha<sup>-1</sup>.

Table 4. Forage yield (FY) (t ha<sup>-1</sup>), hay yield (HY) (t ha<sup>-1</sup>) and dry mater content in forage (DM) (%) cultivars of birdsfoot trefoil in the third year of cultivation.

	The first cut			The second cut			The third cut		
	FY (t ha <sup>-1</sup> )	HY (t ha <sup>-1</sup> )	DM (%)	FY (t ha <sup>-1</sup> )	HY (t ha <sup>-1</sup> )	DM (%)	FY (t ha <sup>-1</sup> )	HY (t ha <sup>-1</sup> )	DM (%)
Cultivar K-37	21,2	4,21	19,87b	12,95	2,68	20,69b	19,91	3,73	18,79
Rocco	23,3	5,16	22,15a	15,58	3,55	22,79a	18,18	3,67	20,22

The values denoted with different small letters within columns are significantly different (P≤0.05) in accordance with the LSD test

### Conclusion

In the second and the third year of cultivation between the cultivars of birdsfoot trefoil there were no significant differences in terms of forage and hay yield. Significant differences between the cultivars were recorded in terms of the content of dry matter at the time of cutting. The cultivars also differed among themselves in terms of the seed yield, which is the consequence of differences in the number of stems per unit area and number of seeds per pod. Forage and hay yield of birdsfoot trefoil cultivars in the first cut in the second year of cultivation was low. Low yield is the consequence of long and expressed dry period in the previous year. In the third year of growing, due to a favorable weather conditions, the satisfactory forage and hay yield of birdsfoot trefoil was recorded. Relatively high seed yield in the second growth in the second year of cultivation and high forage yield in the third year of cultivation indicate that birdsfoot trefoil is largely tolerant to conditions of acidic soils.

### Acknowledgements

This work is part of the research project Ref. No. TR-31016, funded by the Ministry of Science and Technological Development, Republic of Serbia.

## References

- Artola A. (2004). Lotus corniculatus – Morfología, desarrollo y producción de semillas. [Morphology, development and production of seeds] Ciencia.net. <http://www.ciencia.net/>. [Spanish]
- Balan M., Breazu I., Oprea G., Neagu M. (2002). Genetic diversity among accessions of perennial grasses and Lotus corniculatus varieties. In: 19 th EGF, 7: 400-401.
- Dimitrova T. (2010). On the problem of weeds and their control in seed production of birdsfoot trefoil (Lotus corniculatus L.). *Herbologia*, 11(1), 47-57.
- Đukić D., Lugić Z., Vasiljević S., Radović J., Katić S., Stojanović I. (2007). Domestic cultivars of perennial legumes - the origin and quantitative properties. *Proceedings of the Institute for Field and Vegetable Crops, Novi Sad*, 44, 7-19 .
- Đukić D., Stevović V., Janjić V. (2009). Bird trefoil. Forage production in arable land and lawns, pp. 230.
- Fairey D.T. (1994). Seed production in birdsfoot trefoil, Lotus spp.: A review of some limiting factors. p. 81–85. In P.R. Beuselinck and C.A. Roberts (ed.), *First Int. Lotus Symp.*, St. Louis, MO. 22–24 March 1994. Univ. Exten., Univ. of Missouri, Columbia, MO.
- Fairey D.T., Smith R.R. (1999). Seed production in birdsfoot trefoil, Lotus species. In: *Trefoil: The science and technology in Lotus*. CSSA Special Publication Number 28. USA, 145-166.
- García J., Rebuffo M., Formoso F., Astor D. (1991). Forage seed production: technology in use. *Technical Series N° 2*. INIA, Colonia, Uruguay, pp: 40.
- Guillen R. (2007). Considerations in Lotus spp. seed production. *Lotus Newsletter, Argentina*, 37, 47-51.
- Hall M. (2004). *Role of Forages in Pennsylvania Agriculture*. Available at: <http://www.forages.psu.edu>
- Mazzanti A.E., Montes L., Miñón D.P. (1988). Use of Lotus tenuis in livestock farms in the Depressed Pampa: survey results. *Argentine Journal of Animal Production*, 8, 301-305. [Spanish]
- Mc Graw R.L., Beuselinck P.R., Ingram K.T. (1986). Plant population density effects on seed yield of birdsfoot trefoil. *Crop Science*, 78, 201-205.
- Mijatović M. (1975). Comparative testing of the production value of perennial forage legumes on eroded soil in the hilly region. *2nd Yugoslav Symposium on Fodder Plants, Synopsis*, 24-27.
- Miladinović M. (1967). Seed yield and green mass of birdsfoot trefoil with the use of various seed quantities in sowing. *Contemporary agriculture*, 3, 277-281.
- Petrović R., Milijić S., Mladenović G. (1996). Newspapers in the technology of cultivating the birdsfoot trefoil of the Bokor variety for seed production. *Proceedings of the Institute of Field and Vegetable Crops, Novi Sad*, 26, 265-272.
- Radović J., Lugić Z., Sokolović D., Štrbanović R., Marković J. (2007). Variability of productive traits and quality of feed selected genotypes of birdsfoot trefoil (Lotus corniculatus L.). *Proceedings of the Institute for Field and Vegetable Crops, Novi Sad*, 44, 45-50.
- Seaney R.R., Henson P.R. (1970). *Birdsfoot trefoil*. In N.C. Brady (ed.) *Adv. Agron. Acad. Press Inc.*, New York, 1–30.
- SPSS. Inc. 1995. *STATISTICA for Windows (Computer program manual)*. Tulsa. OK

- Stevanović D., Jakovljević M., Martinović L.J. (1995). Solving the problem of acid soils of Serbia - precondition for increasing food production and land protection. Counseling "Repair of acid soils of Serbia using lime fertilizer" Njival Ca ", Proceedings, Paracin, pp. 7–21.
- Turkington R., Franco G.D. (1980). The biology of Canadian weeds. 41 *Lotus corniculatus*, Canadian Journal of Plant Science, 60, 965-979.
- Vojin S., Gatarić Đ., Lakić Ž., Marković D. (2001). Forage and seed yield of domestic varieties of birdsfoot trefoil. Archives for Agricultural Science, 62, 53-60.
- Vučković S. (2004). Žuti zvezdan. Travnjaci. Poljoprivredni fakultet, Beograd, 201-209.
- Vučković S., Krstanović S., Čupina B., Simić A., Stojanović I., Stanisavljević R., Vučković M. (2005). Tehnologija proizvodnje semena žutog zvezdana. Zbornik naučnih radova instituta PKB Agroekonomik. 11(1-2), 125-13.
- Vučković S., Pavešić-Popović J., Nedić M., Zarić D., Perović D., Prodanović S., Pešić V. (1997). Influence of Row Spacing and Sowing Rate on Birdsfoot Trefoil (*Lotus corniculatus* L.) Seed Yield and Quality., Proceedings of the Agro Annual Meeting China 97, "Seed Industry and Agricultural Development", Beijing, China, 535-539.
- Winch J.E., Robison S.E., Ellis C.R. (1985). Birdsfoot trefoil seed production Factsheet no. 85-111, Ontario Ministry of Agriculture and Food, Toronto, ON, pp: 1-4.

## NS PEPPER VARIETIES IN A MULTIVARIATE FRUIT ANALYSIS

Dario DANOJEVIĆ\*, Slađana MEDIĆ-PAP, Janko ČERVENSKI

Institute of Field and Vegetable Crops, Novi Sad, Serbia

\*Corresponding author: dario.danojevic@ifvcns.ns.ac.rs

### Abstract

Peppers (*Capsicum annuum* L.) have a very diverse use in Balkan cuisines and Serbia is no exception. Different ways of consumption has come as a result of various types, colours and sizes of peppers. The aim of this study was the phenotypic evaluation of 16 pepper varieties. Ten pepper varieties were selected at the Institute of Field and Vegetable Crops in Novi Sad (IFVCNS), and 6 were domesticated pepper varieties from the IFVCNS assortment. The trial was conducted in field conditions on chernozem soil in 2016. The experiment was established in a randomized block design with three replications. Five fruits per replicate were used for a phenotypic evaluation. The varieties were characterized for 7 quantitative and 5 qualitative fruit traits. The principal component analysis (PCA) was used to identify the most significant traits and to show distances between the varieties in a biplot. The cluster analysis was applied to show similarities between the varieties and to create common groups. In the PCA biplot all pepper varieties were grouped into five groups, but in the cluster analysis they made six groups. The biggest group in both analyses consisted of bell peppers. Those multivariate analyses are suitable to represent differences and similarities among pepper varieties visually.

**Key words:** *Capsicum annuum*, Cluster, Fruit evaluation, PCA, Serbia.

### Introduction

In most cultivated species, the loss of genetic variability began with the process of domestication (Tang et al. 2010). In contrast, thousands of years of human selection in different conditions and growing methods bring to the development of new mutations and gene combinations that are of agricultural importance, with low probability to occur under the pressure of natural selection. Pepper (*C. annuum* L.) is one of the major vegetable species in Serbia. Pepper comparing to other vegetable crops (excluding potato) has the first rank in Serbia with 16,977 ha in 2016 (Statistical Office of the Republic of Serbia, 2017). In different regions of Serbia people consume pepper fruits with various shapes, sizes and colors (Danojevic et al., 2016). Fruit characterization is the first step in the description and classification of pepper germplasm for breeding purpose. The application of appropriate statistical methods is a useful tool for the description and genotype classification, since it enables plant breeders to identify and select valuable genetic resources in a breeding programs (Jankulovska et al., 2014). Smith and Basavaraja (2005) and Bharadwaj et al., (2007) found that during selection of peppers a very important traits are: fruit weight, fruit length and fruit diameter because they directly affecting the yield. Significant positive correlation between the morphological traits and AFLP markers indicated that the difference in AFLP distances tend to reflect the morphological differences. Therefore, the genotypes can easily be distinguished using only phenotypic traits (Geleta et al., 2005). Hierarchical cluster analysis is a useful tool for partitioning variability of collections for managing them effectively and provides ground for curators and breeders to enhance the usefulness of their collections (Peeters and Martinelli, 1989). Many scientists around the world have studied variability in pepper

germplasm and have clustered them into genetically related groups in order to select superior genotypes for use in future breeding programs (Cvikić, 2009; Occhiuto *et al.*, 2014, Silva *et al.*, 2015). The aim of this research was to characterize pepper varieties for main fruit traits visually and to found relationship between traits and varieties.

### Materials and Methods

Sixteen pepper genotypes from the Institute of Field and Vegetable Crops assortment were sown in the last week of March in 2016 in a plastic house. The field trial was conducted at the experimental field of the Institute of Field and Vegetable Crops (Rimski Šančevi), Novi Sad (Serbia). Genotypes were transplanted in tree replicates (rows) with 20 plants in each row at last decade of May. Density of plants was 70 x 25 cm. Regular cultural practices were applied throughout the growing season (inter-row cultivation, irrigation). Five fruits per replicates were harvested in October at the physiological maturity. The following quantitative traits were analyzed: fruit weight, fruit length, fruit diameter, fruit index, locule number, number of apexes, and pericarp thickness. Also fruit color before maturity, fruit color at maturity, fruit shape in longitudinal section, fruit attitude and presence of capsaicin in placenta were noted according to UPOV Test Guidelines (2006). Software package Statistica for Windows ver. 12, (StatSoft. Inc. 2013) were used for Principal Component Analysis (PCA) and Cluster Analysis (CA) to evaluate the level of diversity for pepper varieties and to rank the contribution of the variables. Mean values per genotype were standardized (Mean=0, SD=1) and used for analysis. For the construction of dendrogram Complete Linkage with squared Euclidean distances was used. Principal components have been extracted until the Eigen value > 1.

### Results and Discussion

PCA indicated that the first three components explained 84.81% of the total variance (Table 1). Since the first three principal components (PC) were over Eigenvalue 1, only those were interpreted.

Table 1. Eigenvalues and total variance of the first three principal components (PC) in pepper varieties.

PC	Eigenvalue	% Total variance	Cumulative Eigenvalue	Cumulative variance %
1	6.205197	51.70998	6.20520	51.7100
2	2.834814	23.62345	9.04001	75.3334
3	1.138196	9.48497	10.17821	84.8184

The most important positive traits in first PC were: fruit index, fruit shape in longitudinal section, and capsaicin in placenta, while the negative were: fruit diameter, fruit weight, pericarp thickness and number of apexes (Table 2).



Table 2. Correlation between original variables and the first three principal components (PC) in pepper varieties.

Variable	PC 1	PC 2	PC 3
Fruit Length	0.103355	<b>-0.938267</b>	-0.076459
Fruit Diameter	<b>-0.953260</b>	-0.203104	0.144728
Fruit Index	<b>0.948926</b>	0.134171	-0.120185
Fruit Weight	<b>-0.848412</b>	-0.240125	0.161494
Number of Apexes	<b>-0.810313</b>	0.502003	-0.134416
Locule Number	-0.567144	0.531240	-0.381190
Pericarp Thickness	<b>-0.936573</b>	-0.175492	0.076035
Fruit Color before Maturity	0.324726	0.257422	<b>0.877431</b>
Fruit Color at Maturity	-0.642038	-0.440472	-0.020056
Fruit Shape in Longitudinal Section	<b>0.772349</b>	-0.535953	0.102178
Fruit Attitude	0.021784	<b>-0.823186</b>	-0.213464
Capsaicin in Placenta	<b>0.833944</b>	0.217655	-0.274644

Ilić *et al.*, (2013), found that beside the fruit yield per plant, fruit weight and pericarp thickness were the most important variables in the first PC. In the second PC the most important traits were: fruit length and fruit attitude. Bozokalfa *et al.*, (2009) found that in the first two PC, the greatest variation was described with following fruit traits: fruit diameter, fruit weight, fruit volume, fruit wall thickness, pedicel length and fruit length. Based on PCA analysis, pepper varieties have been grouped according to the fruit characteristics (Figure 1).

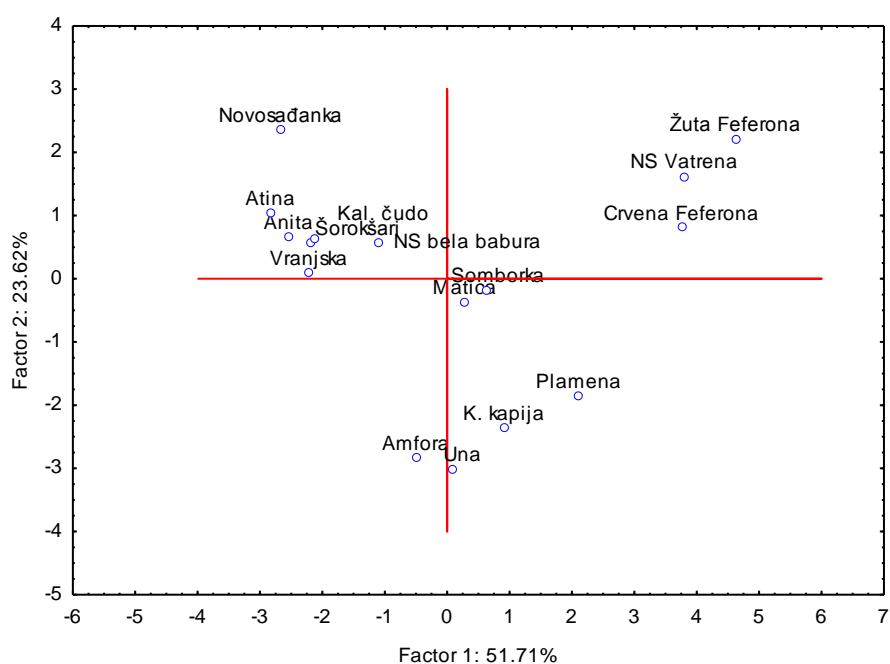


Figure 1. Biplot of the two principal components for the NS pepper varieties based on fruit traits

In the first quadrant were varieties: Crvena feferona, Žuta feferona and the new NS Vatrena. All varieties belonged to small hot peperoni type with erect fruit, while the largest differences were at color maturity. Bell peppers and Novosađanka (tomato shaped pepper) were

represented in the second quadrant. In the lower part of biplot were kapia type varieties (Amfora, Una, and Kurtovska kapia), as well as shipka type (Plamena). Varieties with upright fruit position and conical shape (Matica and Somborka) were located in the center of biplot. Although that relatively small number of varieties were included in this analysis, they showed high variability. Because of high diversity for morphological fruit traits in *Capsicum*, this genus is highly applicable for genetics and breeding in practical classes with students (Prohens *et al.*, 2010). All our varieties could be also presented through a picture of one or two fruits per genotype and grouped according to PCA analysis. That type of visual fruits presentation will be good for students to learn better fruit similarity and divergence between pepper genotypes. A great relationship were established with PCA analysis between the major fruit characteristics: fruit weight, pericarp thickness and fruit diameter (Figure 2). Fruit attitude is in the great dependence on the fruit length (shorter fruits are usually upright). The number of apexes is highly dependent on the locule number, and the pungency is related to the fruit index.

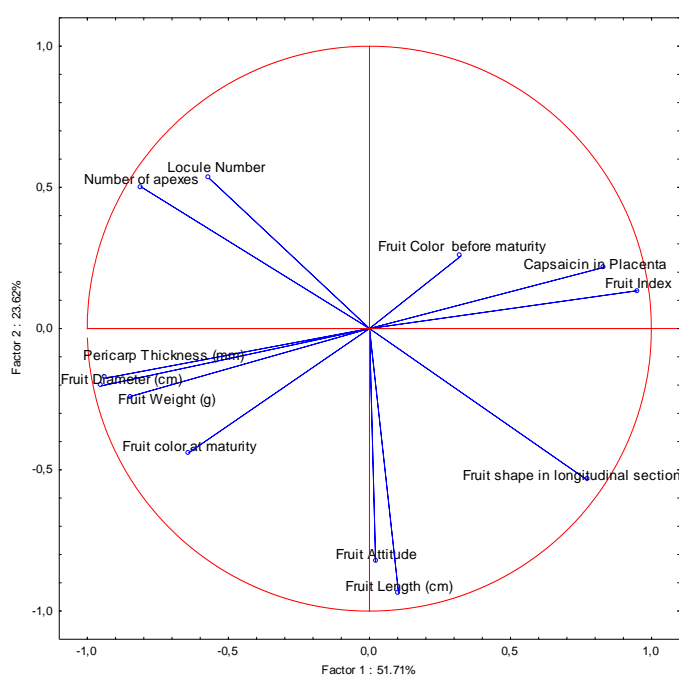


Figure 2. The two principal components for the NS pepper varieties based on fruit traits

Zečević (2001) noted that the fruit diameter, fruit length, pericarp thickness, number of fruits and fruit weight are in a strong correlation. Positive correlation was found between fruit weight and fruit length, fruit diameter, pericarp thickness, and locule number (Danojević *et al.*, 2016). According to Cvikić (2009) the cluster analysis based on the quantitative traits gave results that are much more applicable than grouping of genotypes with morphological markers. Reason of this phenomenon is because the fruit weight has greater variability than any other quantitative trait, and it has the highest contribution in multivariate analysis. Although researchers usually evaluate the germplasm variability separately for quantitative and qualitative traits, a small number of them combines these two trait types in a one multivariate analysis. Based on cluster analysis, varieties included in this research have been grouped into 6 groups (A-F) (Figure 3). In group A (bell pepper type), were the most number of varieties: Vranjska, Anita, Šorokšari (Soroksari), Atina, Kalifornijsko čudo (Cal. Wonder) and Novosadska bela babura. Variety Vranjska is set aside in a separate subgroup primarily due to the hanging fruit position, while other varieties have upright position. Novosađanka is

allocated in a second group (B) as the only tomato variety in that group. Varieties with conical fruit shape and the upright position (Matica and Somborka) were in the group C. The varieties with kapia fruit type (Kurtovska kapija, Amfora, Una) and shipka type (Plamena) have been classified into group D and E. Žuta Feferona, Crvena Feferona and NS Vatrena (small hot peperoni type) were clustered in the group F.

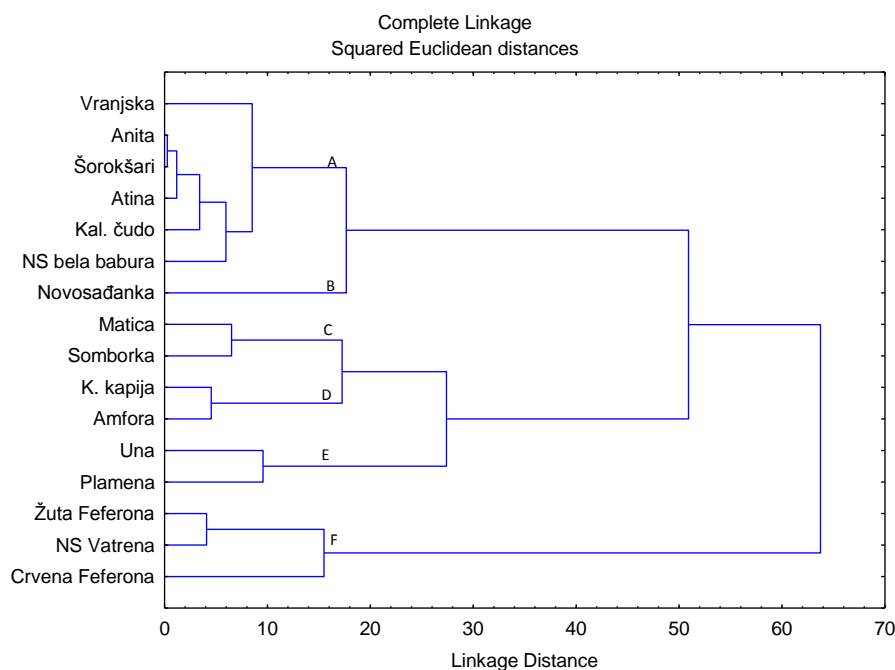


Figure 3. Dendrogram of NS pepper varieties based on evaluated fruit traits

### Conclusions

Evaluated varieties showed significant differences from the Institute of Field and Vegetable Crops assortment. The largest group of varieties consisted of bell peppers but they showed very similar characteristics. Choosing of some important fruit traits and use of Principal Component Analysis and Cluster Analysis is appropriate method for good visual presentation of different pepper varieties. There is still a need for increasing the number of new pepper varieties, because customers want pepper fruits with different sizes, colors, shapes and pungency levels.

### References

- Bharadwaj D.N., Singh H., Yadav R.K. (2007). Genetic variability and association of component characters for yield in chilli (*Capsicum annum* L.). *Progressive Agric*, 7(1-2), 72-74.
- Bozokalfa M.K., Esiyok D., Turhan K. (2009). Patterns of phenotypic variation in a germplasm collection of pepper (*Capsicum annum* L.) from Turkey. *Span. J. of Agric. Res.* 7: 83-95.
- Cvikić D. (2009). The use of morphological and molecular markers in selection of superior lines and hybrids of pepper (*Capsicum annum* L.) Doctoral thesis (in Serbian). University of Belgrade, Faculty of Agriculture.
- Danojević D., Medić-Pap S., Savić A., Červenski J. (2016). Fruit Traits of Pepper Genotypes Originating from Open Pollination. *Ratar. Povrt.* 53 (2): 69-73.

- Geleta L.F., Labuschagne M.T., Viljoen C.D. (2005). Genetic Variability in Pepper (*Capsicum annuum* L.) Estimated by Morphological Data and Amplified Fragment Length Polymorphism Markers. *Biodiversity and Conservation*, 14(10), 2361-2375. doi:10.1007/s10531-004-1669-9
- Ilić Z., Milenković L., Vasić M., Girek Z., Zdravković M., Zdravković J. (2013). Old cultivars and populations from traditional pepper-growing regions of Serbia as breeding potential. *J. Agric. Sci.* 5, 6: 132-140.
- Jankulovska M., Ivanovska S., Marjanovic-Jeromela A., Bolaric S., Jankuloski LJ., Dimov Z., Bosev D., Kuzmanovska B. (2014). Multivariate analysis of quantitative traits can effectively classify rapeseed germplasm. *Genetika*. 46, 2: 545-559.
- Occhiuto P.N., Peralta I.E., Asprelli P.D., Galmarini C.R. (2014). Characterization of *Capsicum* Germplasm Collected in Northwestern Argentina Based on Morphological and Quality Traits. *AgriScientia*, 31, 63-73.
- Peeters J.P., Martinelli J.A. (1989). Hierarchical Cluster Analysis as a Tool to Manage Variation in Germplasm Collections. *Theoretical and Applied Genetics*, 78, 42-48. <http://dx.doi.org/10.1007/BF00299751>
- Prohens J., Rodriguez-Burruezo A., Gisbert C., Soler S., Herraiz F. J., Plazas M., Fita A. (2010). Use of *Capsicum* and eggplant resources for practical classes of Genetics and Plant Breeding courses. *Advances in Genetics and Breeding of Capsicum and Eggplant. Proceedings of the XIV th EUCARPIA Meeting on Genetics and Breeding of Capsicum and Eggplant*, 30 August – 1 September, Valencia, Spain.
- Silva C.Q., Jasmim J. M., Santos J.O., Bento C.S., Sudré C.P., Rodrigues R. (2015). Phenotyping and selecting parents for ornamental purposes in pepper accessions. *Horticultura Brasileira* 33: 066-073. DOI - <http://dx.doi.org/10.1590/S0102-053620150000100011>
- Smith R. P., Basavaraja N. (2005). Variability and correlation studies in chilli (*Capsicum annuum* L.). *Karnataka J Agric Sci*, 19(4), 888-891.
- Statistical Office of the Republic of Serbia (2017). Database. RZS, Belgrade (<http://webrzs.stat.gov.rs/WebSite/public/ReportView.aspx>).
- Tang H., Sezen U., Paterson A.H. (2010). Domestication and plant genomes. *Curr. Opin. Plant Biol.*, 13(2), 160-6.
- UPOV (2006). International Union for the Protection of New Varieties of Plants. Sweet Pepper, Hot Pepper, Paprika, Chili. Guidelines for the conduct of tests for Distinctness, Uniformity and Stability 1–47. [http://www.upov.int/en/publications/tg-rom/tg076/tg\\_76\\_8.pdf](http://www.upov.int/en/publications/tg-rom/tg076/tg_76_8.pdf)
- Zečević B. (2001). Influence of parental germplasma on quantitative traits of pepper (*Capsicum annuum* L.) F1, F2 and F3 generation. Doctoral thesis (in Serbian). University of Belgrade, Faculty of Agriculture.

## HUMUS CONTENTS IN SOILS OF ALEKSINAC MUNICIPALITY IN SERBIA

Dragan GRČAK<sup>1\*</sup>, Miodrag JELIĆ<sup>1</sup>, Milosav GRČAK<sup>1</sup>, Marko AKSIĆ<sup>2</sup>, Dragana GRČAK<sup>1</sup>

<sup>1</sup>University of Priština, Faculty of Agriculture, Kosovska Mitrovica, Lešak, Serbia

<sup>2</sup>Agricultural pharmacy- Agroaksa, Deveti maj, Niš, Serbia

\*Corresponding author: dragangrcak@gmail.com

### Abstract

Humus is a very important soil component, which is a source of nutrients and is a factor in fertility preservation. An analysis of 4.346 soil samples from 743 farms at the location of Aleksinac municipality, whose total area is 1.747,57 ha, has found that 0.2% of the samples belong to the class of very poorly humified soil, containing organic matter up to 1%. It has also been found that 43.3% of the samples belong to the class of poorly humified soil, with the organic matter content ranging from 1% to 3%. Furthermore, 55.2% of the analyzed soil samples belong to the class of well-humified soil, with the humus content ranging from 3% to 5%. The lowest value was found in one of the samples from the village of Rsovac, and it was 0.08%, while 4 out of 5 samples with the highest humus values were found in the village of Aleksinacki Bujmir (9.98% was the highest value that was found). Chemical analysis were performed in 2015, in the Agricultural Advisory and Professional Service - Nis, where the humus content was determined by using the Tyurin method. Soil samples were taken from a depth of 0-30 cm in field crops and vegetable cultures, or 0-60cm in orchards. The results obtained are consequence of insufficient application of organic fertilizers, excessive use of mineral fertilizers, inadequate agricultural technology, irrational removal of crop residues and their burning. The organic matter content in the analyzed plots of Aleksinac municipality, as well as throughout Serbia, is under a strong anthropogenic influence. In accordance with this, the removal of crop residues without prior analysis and determination of organic matter in soil is not recommended and, in particular, the burning of crop residues should be avoided.

**Keywords:** *humus, organic matter, soil.*

### Introduction

The research of the humus content in agricultural soil was performed in the municipality of Aleksinac, which was 26% of the total surface area of the region of Nis, with a surface area of 707 km<sup>2</sup> (1.3% of the territory of Serbia). Arable land is 65% of the total area of the municipality of Aleksinac, and the remaining 35% are hills and mountains. Irrational and intensive land use has resulted in loss of soil fertility (the quality decreases). Humus is a source of nutrients and a factor in soil fertility preservation. Humus is a very important soil matter, due to its ability to bind large amounts of water and nutrients, which are easily available for plants. The humus content decreases in deeper soil. Production of food, especially healthy food, is a global problem, because conventional agriculture creates a great number of negative effects (Pejanović, 2015). In order to preserve the natural fertility of soil, it is necessary to create a minimum of 3-3.5 t/ha of humic substances out of manure or other organic matter microbiologically.

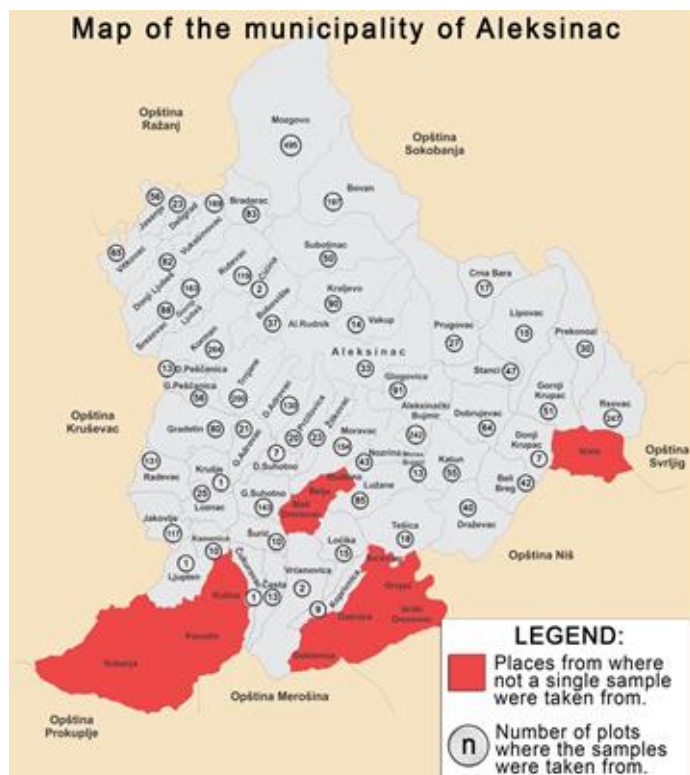
One of the ways of losing humus is removal of or burning biomass of field plants. In this way, not only is organic matter lost, but also biogenic elements, which are fully or partially lost during the burning process (Kastori *et al.*, 2012). In order to stop further land degradation, organic farming is discussed more frequently. Fertilizers are not applied in organic production

and, for this reason, long-term maintenance of soil fertility is important. The application of organic fertilizers introduces microorganisms to the soil, and the entered organic matter is partially mineralized, then high-molecular organic compounds, humic substances, are formed from the degradation product (FAO, 2011). Soils with a higher content of total nitrogen contain more humus, so they are more fertile (Ubavić *et al.*, 1990). Organic substances and mineral fertilizers in the soil contribute to an increase in the mass of roots (Jaćimović *et al.*, 2014). Straw incorporation (SI) by plowing shows similar results to those achieved by the incorporation of fertilizers; it improves soil properties and grain yields. The fertilization of nitrogen (N) fertilizers also increases the quantity of crop residues, which is reflected in an increase in the humus content and the retention of carbon in the soil by the incorporation of crop residues into the soil (Halvorson *et al.*, 1999). Soils rich in humus show a lower volumetric density, from 1.0 - 1.6 g/cm<sup>3</sup>, due to a lower particle density and a higher porosity, which is created between and within structural aggregates under the influence of humus. How to prevent a further humus reduction in the soil? The solution is sought in bacteria, by using bacterial fertilizers. During one year, bacteria leave about 10 tons of organic mass, which comes from their dead bodies, and most of this mass is humified into mature humus (European Commission DG ENV, 2010). A humus decline in the soil is caused by the fact that the quantity of nutrients that leave the soil through the yield is greater than the quantity of nutrients that are returned to the soil. To prevent any further decline of humus in the soil, plowing of crop remains is recommended as one of the measures. In addition to this measure, fertilizing with manure and plant cultivation (mainly legumes) in order to increase the organic matter in the soil are also recommended. There are several methods for humus determination, and a treatment in which strong oxidants affect the organic matter, wherein the oxidation of carbon (C) from humus occurs, is common to all the methods. Carbon is essential for life and the reproduction of microorganisms that favorably affect the biological properties of soil. The most common humus forms are mild (mature) humus and acidic humus. Crops grow better in mild (mature) humus, where the C:N ratio is very similar; mild humus is found in the best soils. Acidic humus is found in poorer soils. Legumes have the greatest effect on the preservation of a stable structure and good-quality humus in the soil (Stošić, 2005). Soil fertility control is a legal obligation of the owner or user of agricultural land under the Agricultural Land Law (Official Gazette of the Republic of Serbia, 2009. No. 62/06, 65/08, 41/09).

### **Material and Methods**

An analysis of 4.346 soil samples from 743 farms (total area is 1.747,57 ha) of Aleksinac municipalit. Humus analyses (Tyurin method) were performed in 2015, in the Agricultural Advisory and Professional Service – Nis in Serbia.

Soil samples were taken from a depth of 0-30 cm (field crops and vegetables), and 0-60 cm (orchards).



**Figure 1.** A map of Aleksinac municipality with the number of samples taken in the villages (Dragan Grcak, 2017)

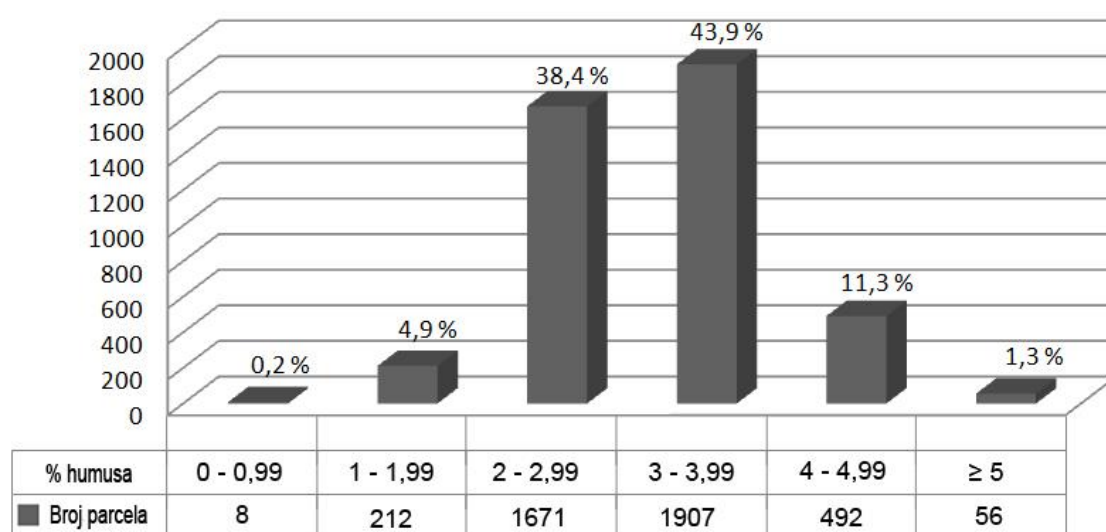
## Results and discussion

The analysis included 59 out of total 71 villages in the municipality of Aleksinac (Figure 1). Figure 1 shows the number of sample plots in the villages. The lowest number of samples (one per village) was taken in the villages Čukurovac, Krušje and Ljupten, and the largest number of samples was taken from the village of Mozgovo (495 plots sampled). In the course of soil fertility control, the content of organic substance, i.e. humus, was analyzed as one of the parameters. Based on the processing of 4.346 data on the farms of Aleksinac municipality, it was found that a large percentage of 43.3% of the samples analyzed belonged to the class of soils with poor humus content, i.e. below 3%. 55.2% of the agricultural lands analyzed belonged to the class of soils with good humus content, from 3 to 5%. Only 1.3% of the samples analyzed belonged to the class of highly humified soils with the humus content higher than 5%. The variability indicator was calculated through standard deviation using the computer, and the standard deviation was  $\pm 0.77$ , which indicated that there were no major differences among the values of humus. Humus increases the water holding capacity in sandy soils, and it causes looseness in clayey soils. The rate of humus disintegration depends on the intensity of land treatment and irrigation (PSSS, 2011). Calcification, as an agro-technical measure, abruptly changes the biological properties of soil, changing the balance of formation and decomposition of humus in the direction of more intense mineralization. This process depletes soil and a drop in productivity occurs. This adverse effect can be reduced by applying organic fertilization (manure). Fertilizing with manure is recommended after calcification for 3-4 weeks (Milanović and Memić). In the past decades, a decline of humus content, 0.38% on average, has been found in the soils of Vojvodina. This situation is due to a

An individual sample consisted of 20 to 25 individual samples (in lots up to 5 ha) from a depth of 0-30 cm) in plots under field or vegetable crops or in plots where field or vegetable crops were planned to be grown, and from a depth of 0-60 cm, in plots under orchards or vineyards or in plots where orchards and vineyards were planned to be located.

Research data processing was performed by using a mathematical-statistical method in the computer program SPSS (Statistical Package for the Social Sciences).

number of factors: an increased use of artificial (inorganic) fertilizers, a reduced use or nonuse of manure (organic fertilizer), burning of the by-products of cultivated plants, etc. (Bogdanović *et al.*, 1993). Livestock capacities have significantly decreased, thus the production of manure is negligible. The number of livestock units per hectare of arable land is 0.33 (Macroeconomics, 2016). One conditional head of livestock is necessary to increase the nutrient content in the soil. In this way, the water-air, thermal, nutritional and microbiological properties of the soil would be improved. Fertilization with organic and mineral fertilizers helps the increase in humus content in the soil (Manojlović, 2008). The results of the humus content in the paper Milivojević *et al.*, 2012, on field crops on the arable land in the town of Kragujevac, show that 59.54% of the samples (average humus content 3.29%) belong to the class of soils with good humus content, while 35.77% of the samples (humus content ranging from 1.01 to 3.00%) belong to the class of soils with poor humus content. In the examination of the humus content in the course of soil fertility control in Central Serbia in 2015, 70.723 samples were analyzed. The mean value of the analyzed samples is 3.73%, which belongs to the class of humified soils (3-5% of humus). The analyzed samples indicate that the soils under orchards, meadows and pastures belong to the class of humified soils (3-5% of humus), while the arable land and vineyards belong to the class of poorly humified soils (1-3% of humus) (Ministry of Agriculture and Environment Serbia, 2017). Based on a detailed classification (Figure 2), the samples with the organic matter content ranging from 2% to 3% are dominant in the class of poorly humified soil, whereas the soils with the humus content ranging from 3% to 4% are dominant in the class of humified soil. In Serbia and in other parts of the world, experiments that have been carried out show that plowing harvest residues increases the yield and its quality, and it also increases the content of total nitrogen (N) and carbon (C) (Powlson *et al.*, 1987).



**Figure 2.** The proportion of samples that belong to certain classes of humus content (%) in the municipality of Aleksinac (number of samples 4.346).



## **Conclusions**

Based on the results of the analyses of soil samples from the municipality of Aleksinac (Serbia), it can be concluded that the humus content in the soil is different, as a result of different soil types and different use of agricultural areas. It was found that:

Less than 1% of the samples belonged to the class of very poorly humified soil

Little less than a half of the samples belonged to the class of poorly humified soil

Little over a half of the analyzed soil samples belonged to the class of well-humified soil

The humus content above 3% was dominant, but it should be maintained and increased by plowing harvest residues and by organic fertilization.

Based on the results of the examination, it can be concluded that organic fertilizers should be used more in the future.

The humus content analysis shows that the majority of the soil analyzed belongs to the class of humified soil and poorly humified soil.

The decrease in the content of humus in the soil is worrisome, especially in the soils where its level is lower than 1%. This tells us that, by cultivating and using land, we have reduced the organic matter, i.e. an imbalance between the entry and exit of the organic matter in the soil has occurred. Dehumification is present in almost all agricultural soils in Serbia. The results obtained are consequence of excessive use of mineral fertilizers, inadequate agricultural technology, insufficient application of organic fertilizers, irrational removal of crop residues and their burning.

The soil analysis serves as a recommendation of the use of a certain quantity and composition of fertilizers in accordance with the demands of different crops and expected yield.

## **References**

- Agricultural Advisory Service Subotica (2011). Analysis of soil. Results of soil fertility control 2011 in the municipality of Subotica. Humus. pp.5. A.D. Subotica.
- Bogdanović D, Ubavić M, Dozet D (1993) Chemical properties of Vojvodina soils and their provision with essential macroelements. In: Heavy metals and pesticides in the soils of the Vojvodina Province, Faculty of Agriculture, Institute of Field and Vegetable Crops, University of Novi Sad, Serbia and Montenegro, pp 197-216, 110-215.
- European Commission Dg ENV. (2010). Soil biodiversity: functions, threats and tools for policy makers. Final report. February 2010.
- FAO (Food and Agriculture Organization) (2011)..Manual for Organic Production. For agricultural producers. Editors Murecki N., Wehinger T., Jaklič M. Biotechnical Faculty od Podgorica. Montenegro.
- Halvorson, D.A., Reule, C.A., Follet, R.F. (1999). Nitrogen fertilization effects on soil carbon and nitrogen in dryland cropping system. *Soil Science Society of America Journal*, 63:912-917.
- Jaćimović, G., Marinković, B., Crnobarac, J., Aćin, V., Latković, D. (2014). Effects of the year and the rate of nitrogen fertilization on wheat production in Serbia. XIIIth Congress of the European Society for Agronomy (13th ESA Congress), University of Debrecen, Debrecen, Hungary, 25-29 August 2014. Book of abstracts, 57-58.
- Kastori, R., Maksimović, I., Putnik-Delić, M. (2012). Environmental Aspects of Burning Field Residues for Use as an Alternative Fuel. *Institute of Field and Vegetable Crops Novi Sad*.49:2, pp.313-319. Serbia.
- Macroeconomics. Cattle breeding of Serbia (2016). Gulin, B. Accessed 22.04.2017. <https://www.makroekonomija.org/0-branislav-gulan/stocarstvo-srbije-2016/>

- Manojlović M. (2008). Monograph. Fertilization in sustainable agriculture. Faculty of Agriculture, Novi Sad. Serbia.
- Milanović P., Memić S. Soil acidity (pH). Accessed 22.04.2017. [http://cms.optimus.ba/Avanti\\_ApplicationFiles/122/Documents/kiselost\\_zemljista.pdf](http://cms.optimus.ba/Avanti_ApplicationFiles/122/Documents/kiselost_zemljista.pdf)
- Milivojević, J., Đekić, V., Jelić, M. (2012). Fertility of privately owned plowland used for field crop production in the city of Kragujevac, Serbia. *Field & Vegetable Crops* Novi Sad. 49:2, pp. 195-201. Serbia. Accessed 16. 04. 2017. <http://scindeks-clanci.ceon.rs/data/pdf/1821-3944/2012/1821-39441202195M.pdf>
- Ministry of Agriculture and Environment. Republic of Serbia. Vidojević, D. (2017). The importance of preserving organic matter for soil Serbia. Environmental Protection Agency. January 23, 2017 . Serbia. Accessed 3.05.2017. [www.sepa.gov.rs](http://www.sepa.gov.rs)
- Pejanović, R. (2015). Unsustainability of the present concept of development and issues regarding food safety. Faculty of Agriculture Novi Sad. Serbia. pp.141-153. Year 39 (2015), No 1 Accessed 16. 04. 2017. <http://polj.uns.ac.rs/wp-content/uploads/2014/10/Letopis-2015-B5.pdf>
- Powlson D. S., Brookes P. C., Christensen B. T. (1987). Measurement of soil microbial biomass provides an early indication of changes in the total soil organic matter due to straw incorporation. *Soil Biol. Biochem.*, 19: 159–164.
- "Official Gazette of the Republic of Serbia ".No. 62/06, 65/08, 41/09. Law on Agricultural Land 2009. Accessed 24.04.2017. [http://www.rapp.gov.rs/Storage/Global/Documents/2014/Zakoni/Zakon\\_o\\_polj.zemljistu.pdf](http://www.rapp.gov.rs/Storage/Global/Documents/2014/Zakoni/Zakon_o_polj.zemljistu.pdf)
- Stošić M. (2005). The suitability of soils for raising permanent crops. Thesis. Josip Juraj Strossmayer University of Osijek . Faculty of Agriculture Osijek. Croatia. Accessed 22.04.2017. <http://www.sa.pfos.hr/~zloncaric/content/pdf/Diplomski%20Stosic.pdf>
- Ubavić, M., Kastori R. Peić A. (1990). Fertilization of orchards and vineyards. Chemical Industry Zorka – Subotica. Serbia

## EVALUATION OF MEDIUM EARLY PLUM CULTIVARS IN THE REGION OF BELGRADE (SERBIA)

Dragan MILATOVIĆ<sup>1\*</sup>, Dejan ĐUROVIĆ<sup>1</sup>, Gordan ZEC<sup>1</sup>, Đorđe BOŠKOV<sup>1</sup>, Mirjana RADOVIĆ<sup>2</sup>

<sup>1</sup>Faculty of Agriculture, University of Belgrade, Serbia

<sup>2</sup>Faculty of Agriculture, University of East Sarajevo, Bosnia and Herzegovina

\*Corresponding author: mdragan@agrif.bg.ac.rs

### Abstract

Phenological traits, yield, and fruit characteristics of seven plum cultivars of medium early maturation time were studied in the region of Belgrade (Serbia) in the four-year period (2013-2016). Control cultivar for comparison was ‘Čačanska lepotica’. The average time of flowering of tested cultivars was in the first half of April, and the average duration of flowering varied from 7.8 to 11.3 days. The average time of maturation ranged from July, 17 (‘Valerija’) to July, 31 (‘Hanita’). The average yield per tree was the lowest in the cultivar ‘Venera’ (8.6 kg) and the highest in the cultivar ‘Valerija’ (28.6 kg). Compared to control, significantly higher yield was achieved in the cultivar ‘Valerija’, while the lower yield was found in cultivars ‘Venera’, ‘Excalibur’, ‘Kišinjvska rana’ and ‘Čaradejka’. The lowest vigor was recorded in the cultivar ‘Valerija’, and the highest in the cultivar ‘Reeves’. The average fruit weight ranged from 36.1 g in the cultivar ‘Hanita’ to 71.1 g in the cultivar ‘Reeves’. Compared to control, fruit weight was significantly higher in cultivars ‘Reeves’, ‘Excalibur’ and ‘Valerija’. High soluble solids content (above 18%) was found in cultivars ‘Venera’ and ‘Kišinjvska rana’. Based on the obtained results, for growing in Belgrade region, cultivars ‘Valerija’ and ‘Hanita’ can be recommended.

**Key words:** *Prunus domestica*, flowering, maturation, yield, fruit characteristics

### Introduction

Plum (*Prunus domestica* L.) is the most important fruit species in Serbia with the average production of 420.000 t per year in the period of 2011-2016 (Statistical Office of the Republic of Serbia, 2017). However, the average yield is low, only 5,4 t/ha. This is because the production is mostly extensive and cultural practices are often at a low level. The largest amount of produced fruits is processed into brandy (more than 60%), while much smaller amounts are dried, frozen, and processed into other product. Fresh consumption of plums is quite small. In recent years, there is a tendency to increase export of fresh fruits, mostly in Russia (Milatović, 2013).

A lot of work has been done on creation of new plum cultivars with improved characteristics, such as better adaptation to different ecological conditions, increased disease resistance, self-fertility, higher yield and better fruit quality. In the last 20 years more than 170 new plum cultivars were released in Europe (Butac et al., 2013). The introduction of new foreign cultivars and their study in Serbian climatic and soil conditions allow better choice of cultivars, and may improve the production of plums.

Plum breeding has been developed at the Fruit Research Institute in Čačak since 1946. The result of this programme are 15 released cultivars (Glišić et al., 2015). Most grown Serbian cultivars in new orchards are: ‘Čačanska rodna’, ‘Čačanska lepotica’ and ‘Čačanska rana’.

The aim of this study was to evaluate phenological traits, yield and fruit characteristics of seven plum cultivars of medium early maturation time. The best performing cultivars will be recommended for growing in the region of Belgrade, as well as in other regions with similar environmental conditions.

### Material and Methods

The study was conducted in the plum collection orchard at the Experimental Station “Radmilovac” of the Faculty of Agriculture in Belgrade during the period of four years (2013–2016). The orchard was planted in 2009. The rootstock is Myrobalan (*Prunus cerasifera* Ehrh.) seedling, training system is central leader, and planting distance is 4.5 x 3 m. All cultivars are represented by five trees. The study included seven plum cultivars: ‘Čaradejka’ (Belarus), ‘Excalibur’ (England), ‘Hanita’ (Germany), ‘Kišinjevska rana’ (Moldavia), ‘Reeves’ (Canada), ‘Valerija’ (Serbia), and ‘Venera’ (Belarus). Control cultivar for comparison was ‘Čačanska leptotica’.

Flowering was recorded by recommendations of the International Working Group for pollination: start of flowering – 10% open flowers, full bloom – 80% open flowers, end of flowering – 90% of the petal fall (Wertheim, 1996). Trunk cross-sectional area (TCSA) was calculated on the basis of trunk circumference measured at the height of 30 cm above the ground level. Cumulative yield efficiency was calculated by dividing the cumulative yield over four years by TCSA in the last year (2016). Fruit characteristics were measured on a sample of 25 fruits per cultivar. Fruit shape index was calculated using the formula: length × length / width × thickness. Soluble solids were determined by refractometer and total acids (expressed as malic acid) by titration with 0.1 N NaOH. Sensory characteristics of the fruit (appearance and taste) were evaluated by a five-member jury, scoring the cultivars using the scale from 1 to 5 points.

The obtained data were statistically analyzed using analysis of variance. The significance of differences between mean values was determined using Duncan’s multiple range test at 0.05 level of probability.

### Results and Discussion

Average time of flowering of tested cultivars was in the first half of April (Table 1). The earliest flowering was recorded in the cultivar ‘Valerija’, and the latest in the cultivar ‘Čaradejka’. The average difference between cultivars with earliest and latest flowering was 4 days.

Table 1. Phenological characteristics of plum cultivars (average, 2013–2016).

Cultivar	Flowering dates			Duration of flowering (days)	Abundance of flowering (0-5 scale)	Harvest date
	Start	Full	End			
Č. leptotica (control)	4 April	7 April	14 April	9.5	4.7	22 July
Čaradejka	6 April	9 April	16 April	10.0	4.1	18 July
Excalibur	5 April	7 April	14 April	9.0	3.7	30 July
Hanita	4 April	6 April	14 April	10.3	3.8	31 July
Kišinjevska rana	6 April	8 April	14 April	7.8	3.5	22 July
Reeves	6 April	8 April	15 April	8.8	3.5	24 July
Valerija	2 April	5 April	14 April	11.3	4.7	17 July
Venera	5 April	7 April	15 April	10.5	2.7	20 July

Among years, the earliest flowering was in 2014, when the average date of the flowering onset for all cultivars was March, 24. The latest flowering was in 2013 when the average date of the flowering onset was April, 17. The difference between years with earliest and latest flowering was 24 days and it was much bigger than the difference between cultivars.

The average duration of flowering ranged from 7.8 days (‘Kišinjvska rana’) to 11.3 days (‘Valerija’). Among years, the average duration of flowering for all cultivars ranged from 7.8 days in 2015 to 11.5 days in 2016. The most abundant flowering was recorded in cultivar ‘Valerija’ (the same as in control cultivar, ‘Čačanska lepotica’). The lowest flowering intensity was recorded in cultivar ‘Venera’.

The range of fruit maturity was from July 17 (‘Valerija’) to July 31 (‘Hanita’). For most cultivars the earliest fruit maturation was in 2016, and the latest in 2014. Difference between years with earliest and latest fruit maturation varied from 7 to 15 days.

Flowering and maturation time of plum cultivars in the region of Belgrade was earlier comparing to Czech Republic (Blažek and Pišteková, 2009), Central Bulgaria (Dragoyski et al., 2010), and Northern Montenegro (Božović and Jaćimović, 2012). These differences can be explained by different environmental conditions between the study regions.

The average yield per tree was the lowest in the cultivar ‘Venera’ (8.6 kg) and the highest in the cultivar ‘Valerija’ (28.6 kg) (Table 2). Compared to control, significantly higher yield was achieved in the cultivar ‘Valerija’, while the lower yield was found in cultivars ‘Venera’, ‘Excalibur’, ‘Kišinjvska rana’ and ‘Čaradejka’.

Table 2. Yield, trunk cross-sectional area, and yield efficiency of plum cultivars.

Cultivar	Yield (kg per tree)					Trunk cross-sectional area (cm <sup>2</sup> )	Cumulative yield efficiency (kg/cm <sup>2</sup> )
	2013	2014	2015	2016	Average		
Č. lepotica (control)	10.3	36.7	5.5	30.5	20.8 b	79.8 cd	1.04
Čaradejka	6.1	3.7	23.2	15.4	12.1 cd	113.0 bc	0.43
Excalibur	6.3	25.4	5.1	6.2	10.7 d	151.4 b	0.28
Hanita	7.9	22.4	6.9	39.5	19.2 bc	97.5 cd	0.79
Kišinjvska rana	8.3	23.5	9.1	5.6	11.6 d	89.9 cd	0.52
Reeves	3.1	36.7	23.4	0.3	15.9 bcd	209.1 a	0.30
Valerija	13.3	32.4	12.1	56.4	28.6 a	68.5 d	1.67
Venera	2.5	5.4	3.0	23.6	8.6 d	109.0 c	0.32

Mean values followed by the same letter within a column do not differ significantly according to Duncan’s multiple range test at  $P \leq 0.05$ .

Among studied cultivars, the lowest vigor was found in the cultivar ‘Valerija’, and the highest in the cultivar ‘Reeves’. Our results of high vigor of cultivars ‘Reeves’ and ‘Excalibur’ confirm previous findings of Meland (2010).

Cumulative yield efficiency ranged from 0.28 to 1.67 kg/cm<sup>2</sup>. The cultivar ‘Valerija’ stands out for high cumulative yield efficiency. On the other side, cultivars ‘Excalibur’, ‘Reeves’ and ‘Venera’ are characterized by low yield efficiency.

All studied cultivars are characterized by large fruit (more than 30 g). Fruit weight ranged from 36.1 g in the cultivar ‘Hanita’ to 71.1 g in the cultivar ‘Reeves’ (Table 3). Compared to control, fruit weight was significantly higher in cultivars ‘Reeves’, ‘Excalibur’ and ‘Valerija’.

Table 3. Fruit characteristics of plum cultivars (average, 2013–2016).

Cultivar	Fruit weight (g)	Stone weight (g)	Stone share (%)	Fruit dimensions (mm)			Shape index	Stalk length (mm)
				Length	Width	Thickness		
Č. leptotica (control)	39.4 cd	1.6 d	4.0	43.7 b	37.9 bc	36.8 cd	1.36	14.4 bc
Čaradejka	42.2 bcd	1.9 c	4.5	44.4 ab	38.0 bc	38.7 cd	1.34	17.0 b
Excalibur	64.0 a	2.3 b	3.5	48.1 a	45.8 a	45.2 ab	1.12	21.7 a
Hanita	36.1 d	2.0 c	5.5	46.0 ab	35.5 c	36.4 d	1.64	16.3 b
Kišinjevska rana	42.9 bcd	1.5 d	3.4	43.6 b	38.4 bc	39.8 bcd	1.24	10.9 c
Reeves	71.1 a	2.8 a	4.0	47.8 a	47.7 a	51.1 a	0.94	15.5 b
Valerija	49.6 b	1.9 c	3.9	43.5 b	42.6 ab	42.8 bc	1.04	16.0 b
Venera	46.1 bc	2.3 b	5.0	44.9 ab	39.6 ab	39.8 bcd	1.28	17.3 ab

Mean values followed by the same letter within a column do not differ significantly according to Duncan's multiple range test at  $P \leq 0.05$ .

Stone weight ranged from 1.5 g ('Kišinjevska rana') to 2.8 g ('Reeves'), and its share in the fruit weight ranged from 3.4% ('Kišinjevska rana') to 5.5% ('Hanita').

Fruit length was highest in the cultivar 'Excalibur', whereas width and thickness were highest in the cultivar 'Reeves'. Significant differences were found between cultivars for fruit dimensions. Based on the fruit dimensions the shape index was calculated, whose values ranged from 0.94 in 'Reeves' (flat round shape) to 1.34 in 'Čaradejka' (ovate shape). Stalk length was the shortest in 'Kišinjevska rana' (10.9 mm), and the longest in 'Excalibur' (21.7 mm).

Results of fruit characteristics are in accordance with the previous findings for some cultivars (Hartmann, 1998; Dragoyski et al., 2010; Milatović et al., 2011; Ionica et al., 2013).

Cultivars 'Kišinjevska rana' and 'Venera' are characterized by high soluble solids content (18.2-18.7%), significantly higher than in the control (Table 4). Cultivars 'Excalibur' and 'Kišinjevska rana' are characterized by low acid content.

Table 4. Indices of fruit quality of plum cultivars (average, 2013–2016).

Cultivar	Soluble solids (%)	Total acids (%)	Soluble solids /Total acids	Sensory evaluation (1-5)	
				Appearance	Taste
Č. leptotica (control)	15.3 bc	1.26 ab	12.1	4.2	4.1
Čaradejka	16.9 ab	1.04 bc	16.2	2.9	3.3
Excalibur	16.3 abc	0.70 d	23.3	3.8	4.1
Hanita	16.3 abc	1.38 a	11.9	4.0	4.1
Kišinjevska rana	18.2 a	0.79 cd	23.0	3.9	4.1
Reeves	15.1 bc	0.92 cd	16.4	4.0	3.4
Valerija	13.8 c	0.99 bcd	13.9	4.2	3.5
Venera	18.7 a	0.94 cd	19.8	4.1	3.9

Mean values followed by the same letter within a column do not differ significantly according to Duncan's multiple range test at  $P \leq 0.05$ .

It is a well-known fact that the ratio between the soluble solids content and total acids (SSC/TA), rather than the very content of soluble solids, represents a reliable indicator of a cultivar's suitability for acceptance by consumers (Crisosto et al., 2004). Cultivars 'Excalibur' and 'Kišinjevska rana' are characterized by high SSC/TA ratio (above 20).

The data on the chemical composition of fruits are in good agreement with most of the previous findings (Hartmann, 1998; Vangdal et al., 2007; Bohačenko et al., 2010; Dragoyski et al., 2010; Milatović et al., 2011; Ionica et al., 2013).

The highest scores for fruit appearance obtained the cultivar ‘Valerija’, and for taste cultivars ‘Hanita’, ‘Excalibur’ and ‘Kišinjvska rana’. Our results for taste for cultivars ‘Excalibur’ and ‘Reeves’ are in accordance with those of Vangdal et al. (2007) and for cultivar ‘Hanita’ with those of Hartmann (1998).

### **Conclusion**

Based on the four-year evaluation of seven plum cultivars of medium early maturation time, for growing in Belgrade area can be recommended cultivars ‘Valerija’ and ‘Hanita’. Both of them are suitable for fresh fruit consumption. Besides, the cultivar ‘Hanita’ is also suitable for fruit processing.

### **Acknowledgements**

This work was realized as a part of the project TR 31063 financed by the Ministry of Education, Science and Technological Development of the Republic of Serbia.

### **References**

- Blažek, J., Pišteková, J. (2009). Preliminary evaluation results of new plum cultivars in a dense planting. *Horticultural Science*, 36(2): 45–54.
- Bohačenko, I., Pinkrová, J., Komárková, J., Paprštejn, F. (2010). Selected processing characteristics of new plum cultivars grown in the Czech Republic. *Horticultural Science*, 37(2): 39–45.
- Božović, Đ., Jaćimović, V. (2012). Phenological properties of plums under the conditions of Northern Montenegro. *Agriculture and Forestry*, 58(4): 153–159.
- Butac, M., Bozhkova, V., Zhivondov, A., Milosevic, N., Bellini, E., Nencetti, V., Blazek, J., Balsemin, E., Lafarque, B., Kaufmane, E., Gravite, I., Vasiljeva, M., Pintea, M., Juraveli, A., Webster, T., Hjalmarsson, I., Trajkovski, V., Hjeltnes, S.H. (2013). Overview of plum breeding in Europe. *Acta Horticulturae*, 981: 91–98.
- Crisosto, C.H., Garner, D., Crisosto, G.M., Bowerman, E. (2004). Increasing ‘Blackamber’ plum (*Prunus salicina* Lindley) consumer acceptance. *Postharvest Biology and Technology*, 34: 237–244.
- Dragoyski, K., Minev, I., Dinkova, H., Stoyanova, T., Minkov, P. (2010). Evaluation of some introduced plum cultivars in RIMSA Troyan. *Acta Horticulturae*, 874: 311–316.
- Glišić, I., Milatović, D., Milošević, N., Lukić, M. (2015). Biological and pomological properties of promising plum hybrids created at the Fruit Research Institute, Čačak. VI International Scientific Agricultural Symposium "Agrosym 2015", Jahorina, Bosnia and Herzegovina, 15-18 October 2015. pp. 424–429.
- Hartmann, W. (1998). New plum cultivars from Hohenheim. *Acta Horticulturae*, 478: 171–174.
- Ionica, M.E., Nour, V., Trandafir, I., Cosmulescu, S., Botu, M. (2013). Physical and chemical properties of some European plum cultivars. *Notulae Botanicae Horti Agrobotanici Cluj-Napoca*, 41(2): 499–503.
- Meland, M. (2010). Performance of six European plum cultivars on four plum rootstocks growing in a northern climate. *Acta Agriculturae Scandinavica Section B–Soil and Plant Science*, 60(4): 381–387.

- Milatović, D. (2013). Pflaumen- und kirschenanbau in Serbien. *Obstbau*, 38(2): 115–119.
- Milatović, D., Đurović, D., Zec, G. (2011). Ispitivanje stonih sorti šljive na području Beograda. (Evaluation of dessert plum cultivars in Belgrade area) *Voćarstvo*, 45: 101–108.
- Statistical Office of the Republic of Serbia (2017). <http://www.stat.gov.rs/>
- Vangdal, E., Flatland, S., Hjeltnes, S.H., Sivertsen, H. (2007). Consumers' preferences for new plum cultivars (*Prunus domestica* L.). *Acta Horticulturae*, 734: 169–172.
- Wertheim, S.J. (1996). Methods for cross pollination and flowering assessment and their interpretation. *Acta Horticulturae*, 423: 237–241.



## THE IMPACT OF THE NATURAL SEED PURITY ON THE FINAL QUANTITY OF SEEDS OF RED CLOVER (*Trifolium pratense* L.) AFTER PROCESSING

Dragoslav ĐOKIĆ<sup>1\*</sup>, Rade STANISAVLJEVIĆ<sup>2</sup>, Dragan TERZIĆ<sup>1</sup>, Jasmina MILENKOVIĆ<sup>1</sup>, Zoran LUGIĆ<sup>1</sup>, Ranko KOPRIVICA<sup>3</sup>, Saša BARAĆ<sup>4</sup>

<sup>1</sup>Institute for Forage Crops, 37251 Globoder-Kruševac, Republic of Serbia

<sup>2</sup>Institute for Plant Protection and Environment, Teodora Drajzera 9, 11000 Belgrade, Republic of Serbia

<sup>3</sup>University of Kragujevac, Faculty of Agronomy, 32000 Čačak, Cara Dušana 9, Republic of Serbia

<sup>4</sup>University of Priština, Faculty of agriculture, Kopaonička bb, 38219 Priština/Lešak, Republic of Serbia

\*Corresponding author: dragoslav.djokic@ikbks.com

### Abstract

This paper presents an analysis of the impact of different natural red clover seeds purity on the quantity of seeds obtained in the processing center of the Institute for forage crops in Kruševac. The purity of eight different natural lots of red clover seeds ranged from the lowest 75% to the highest 85%. The content of inert materials and weeds was different in different seed lots. The content of inert materials was from smallest 7.2% to the highest 21%. The highest weed content in natural red clover seeds was 12%. The purity of the red clover seeds after the processing ranged from at lowest 97% in the case of seed lot II to highest 99.7% in the seed of lot IV. Red clover (*Trifolium pratense* L.) per share in the production of fodder in Serbia is in second place, immediately after the alfalfa. Agrotechnical significance of red clover is very high. Red clover improving the physical characteristics of the soil, significantly increases the nitrogen content and the organic matter in the soil. For the establishment and use of red clover seeds for sowing must be clean, have high germination and genetic values. In the processing the quantities of red clover processed seeds directly depends on the content of impurities of organic and inorganic origin. It also depends on the quantity and type of weed seeds that are being processing. The aim of the study was to identify relevant parameters of red clover seed processing depending on the equipment. The relevant parameters for processing seeds of red clover are: content of pure seeds (%), weed seeds and the seeds of other cultures (%), the inert matter (%), the quantity of processed seeds (kg), the losses of seeds (%) and the processing output (%). Based on the obtained results, it is possible to make an optimal adjustment, and selection of the appropriate equipment for processing seeds of red clover, depending on the amount and type of impurities in natural seeds of red clover in the processing.

**Keywords:** *Seeds, processing, red clover, weed species, impurities.*

### Introduction

Red clover (*Trifolium pratense* L.) is one of the most important perennial legumes in our agroecological conditions. Among the fodder legumes in the Republic of Serbia, red clover occupies the second place, immediately after the alfalfa. It is distinguished by high biomass yield, feed quality, and rapid regeneration after cutting. Leaves are particularly rich in proteins, the content of which is about 25% in the phase of butonization (Vasiljević *et al.*, 2011). In animal feed, red clover can be used as green fodder or processed in the form of hay, shaded, silage, and dehydrated in the form of flour (Vučković, 1999). According to the

content of vitamins and minerals, red clover is one of the best and most important forage species. It contains large amounts of pro-vitamin A, vitamin C, D, E, K, B1, B2, B3 and microelements - molybdenum, cobalt, boron, copper and manganese. The hay collected at the beginning of the butonization is rich in proteins (18 - 24%), phosphorus and calcium (Marković *et al.*, 2007). In the Republic of Serbia in 2015 year the red clover was grown on average to 76.625 ha, whereby 222.596 t of dry matter was obtained with an average yield of 2.9 t ha<sup>-1</sup> (<http://pod2.stat.gov.rs/ObjavljenePublikacije/G2016/pdf/G20162019.pdf>). Red clover can successfully replace alfalfa on soil with increased acidity in plain and mountainous areas. Land for cultivation is medium heavy, wet, medium fertility of the type of plantain, alluvial and smonitza (Lugić *et al.*, 2000; Lakić and Vojin, 2010). Serbia's climate is judged to be moderately favorable for the production of seed legumes. The average yield of alfalfa and red clover seeds is about 250 kg ha<sup>-1</sup> (Karagić *et al.*, 2010). The seeds of red clover separates the pure grain of the basic culture to ensure good sowing, germination and sprouting, as well as storage until the time of sowing (Đokić *et al.*, 2012; 2016). Seed processing is based on the physical characteristics of the seed and therefore it is necessary to carefully analyze all the quantities of seeds and to do the appropriate adjustment of the processing equipment (Babić and Babić, 1998; Black *et al.*, 2006; Copeland *et al.*, 2004; Đokić, 2010; Đokić and Stanisavljević, 2012). In the seed crop of red clover, the most damaging quarantine weeds are dodder (*Cuscuta* spp.) and curly dock (*Rumex* sp.). The dodder belongs to the most dangerous and economically most damaging weeds and can cause enormous damage especially if no suppression is done (Čaturilo and Nikolić, 1986; Đukić *et al.*, 2004). Curly dock can increase the losses during the seed processing. It is very difficult to separate this seeds from the seed of the basic culture due to its shape and size. (Karagić *et al.*, 2007). The Law on Seeds of the Republic of Serbia defines the conditions and manner of production, processing, use, trade, import and testing of the quality of seeds of agricultural plants (Official Gazette of the Republic of Serbia, 45, 2005). The Rulebook on the Quality of Seeds of Agricultural Plants (Official Gazette of the SFRY, 47/1987), which is harmonized with international seed regulations (ISTA, 1999) defined the quality standard for the quality of seeds of red clover. According to this Rule, the quality of seeds of red clover (*Trifolium pratense* L.) must have a minimum seed purity of 95%, with 2% of seeds of other species, weeds not more than 0,5% (including dodder and curly dock), and up to 2,5% inert materials. The aim of the study was to compare the relevant seed quality parameters in the seed processing and determine which initial seed purity yielded optimum results in processing.

### Material and Methods

The experiment was carried out at the processing center of the Institute for Forage Crops in Kruševac-Serbia where (in three replications) the natural red clover seed of eight lots of different purity was processed. The processing equipment (Danish manufactures of Kongskilde and Damas) consisted of the following machines and devices: intake pit with belt conveyor, belt conveyors, bucket elevators, fine cleaning machine type Alfa-4, and magnetic separator type 4 of the German manufacturer Emceka Gompper. In the upper shaker shoe are six screens with round openings of diameter: 2.75 mm; 2.5 mm; 2.25 mm; 2.0 mm; 2.0 mm and 1.9 mm. In the lower shaker shoe there are screens with longitudinal - cut openings of width: 1.4 mm; 1.3 mm; 1.2 mm; 0.6 mm; 0.5 mm and 0.5 mm. In order to analyze the content of foreign matter in the seed, a laboratory lamp with light and precision electronic scale was used. Samples for analysis were weighing 5 g and 50 g. Measurement of the mass of the processed seed was carried out using electronic weighing range of up to 300 kg. In each of the repetitions by laboratory analysis, the following parameters were measured: quantity of pure seed (%), seed of other species (%), inert matter (%), weed (%), and amount of

processed seed (kg). Processing output (%) and seed losses on processing equipment (%) were determined by calculation. The obtained results were analyzed by variance analysis (ANOVA), and the significance of the mean difference was tested with the Tukey test. The statistical program Minitab 16.1.0 (statistics software package) was used for data processing.

### Results and Discussion

The purity of the natural seed of the red clover of all eight seed lots is shown in Table 1. The purity values ranged from the lowest 75% for seeds from seed lot II to 85% for seed lots of I, III and VIII. The purity of seeds of lots IV, V and VII was 80%. The VI seeds were clean 78%. In the seed of red clover were found of the other species, 0.8% (III lot) of alfalfa seeds, 1% (lot VI) and 0.5% (lot VIII). Inert materials consisted of cereal residues, blossoms, empty seed and broken seeds, and their part ranged from the lowest values of 7.2% in natural seed of lot III, to 21% for seeds of lot VI. In the seeds of lot I inert matter were 11.6%, in seed lot II inert matter amounted to 11.5%. In seed of lot IV, inert matter was 16.5%. Seed lot V and VII accounted for 20% of the inert matter in the form of harvest residues, while for seeds of lot VIII they amounted to 14.5%. In the seed of seed lot III, 7% of the weeds were. From weed seed sample of 5 g, 6 seeds of dodder (*Cuscuta* spp.) and 6 seeds of curly docks (*Rumex* sp.) were found. The other weeds were pigweed (*Amaranthus retroflexus*), bindweed (*Convolvus arvensis*), white goosefoot (*Chenopodium album*), and lowgrass (*Polygonum aviculare*). Seeds of lot II had the highest number of weeds (12%) in the form of plantains (*Plantago* L.) and chamomile (*Matricaria chamomilla*). In a sample of 5 g analysis, 6 seeds of dodder were found. In the seeds of lot I 3.4% of weeds were found, and in the seed sample of 5 g were found 20 of dodder and 5 seeds of curly dock. The natural seed of the lot IV, had 3.5% weeds, and in the 5 g sample there were 20 seeds of dodder, as well as seeds of plantains and chamomile. In the seed of the lot V there was the seed of the plantains. The seed of the lot VI had 25 seeds of the dodder and 2 seeds of curly dock in the sample of 5 g. In the seed of VII and VIII lots, no significant quantities of weeds were found in the samples.

Table 1. The average purity of red clover seed

Lot	I	II	III	IV	V	VI	VII	VIII	<i>F</i> <i>test</i>
Seed structure	%	%	%	%	%	%	%	%	
Pure seed	85 a	75 c	85 a	80 b	80 b	78 bc	80 b	85 a	**
Other species	-	1.5 a	0.8 bc alfalfa	-	-	1 b alfalfa	-	0.5 c alfalfa	**
Inert matter	11.6 c	11.5 c	7.2 d	16.5 b	20 a harvest residue	21 a harvest residue	20 a harvest residue	14.5 b harvest residue	***
Weed	3.4 c in 5 g 20 dodder, 5 curly dock	12.0 a in 5 g 6 dodder, plantain chamomile	7.0 b in 5 g 6 dodder, 6 curly dock, pigweed, bindweed, white goosefoot, lowgrass	3.5 c in 5 g 20 dodder, plantain, chamomile	plantains	in 5 g 25 dodder, 2 curly dock	-	-	***
Total	100	100	100	100	100	100	100	100	

*F* test, statistical significance levels: \* $p \leq 0.05$ , \*\* $p \leq 0.01$ , \*\*\* $p \leq 0.001$ , ns – not significant ( $p \geq 0.05$ )  
 Tukey test statistical significance levels:  $p \leq 0.05$ , differences in row marked in small letters a, b, c...

The purity of the red clover seeds after the processing is shown in Table 2. The red clover seeds had higher purity than legally prescribed (>95%). The purity ranged from at least 97% in the case of seed lot II seeds to 99.7% in the seed of lot IV.

Table 2. The average purity of processed red clover seed

Lot	I	II	III	IV	V	VI	VII	VIII	F test
Seed structure	%	%	%	%	%	%	%	%	
Pure seed	99.4	97.0	99.0	99.7	99.0	98	97.2	98.2	ns
Other species	-	1.8 a (alfalfa) 0.2 (grasses)	0.6 b (alfalfa)	0.1 c (grasses)	0.2	0.2 c (alfalfa, birdsfoot trefoil)	-	0.4 bc (alfalfa)	***
Inert matter	0.3	0.8	0.2	0.1	0.4	-	2.6	1.2	***
Weed	0.3	0.2	0.2	0.1	0.4	0.8	0.2	0.2	***
Total	100	100	100	100	100	100	100	100	-

F test, statistical significance levels: \* $p \leq 0.05$ , \*\* $p \leq 0.01$ , \*\*\* $p \leq 0.001$ , ns – not significant ( $p \geq 0.05$ )

Tukey test statistical significance levels:  $p \leq 0.05$ , differences in row marked in small letters a, b, c...

In the purity of the processed seed, no statistically significant difference was found between the lots ( $p \geq 0.05$ ). All other lots of processed seeds had the content of quarantine weeds and impurities within legally prescribed limits. Seed of quarantine weeds of the dodder and curly dock was not found in seed samples for analysis. At the end of the seed processing the amount of processed seed was measured. The quantities of natural seed of the red clover of all eight lots at the beginning of the seed processing and the amount of processed seeds at the end of the seed processing are shown in Table 3.

Table 3. Amounts of processed red clover seed on processing machines

Seed structure	Lot (kg)								F test
	I	II	III	IV	V	VI	VII	VIII	
Natural seed	2073 ab	1127 bc	3680 a	1950 ab	1133 bc	830 c	1408 b	488 c	***
Processed seed	1553 c	750 d	2750 b	1280 c	623 d	440 d	977 cd	3636 a	***
Processing output (%)	74.91 a	66.5 b	74.72 a	65.6 b	55.1 c	53.0 c	69.4 ab	74.43 a	**
Losses (%)	11.86 b	11.26 b	12.1 b	17.9 b	31.0 a	32.0 a	13.26 b	12.43 b	***

F test, statistical significance levels: \* $p \leq 0.05$ , \*\* $p \leq 0.01$ , \*\*\* $p \leq 0.001$ , ns – not significant ( $p \geq 0.05$ )

Tukey test statistical significance levels:  $p \leq 0.05$ , differences in row marked in small letters a, b, c...

This table also shows the calculated values for the processing output and the losses on the processing equipment expressed in percentages. The highest percentage processing output of seeds ranged from 74.91%, 74.72% and 74.43% in seeds of I, III and VIII lot, respectively. The smallest percentage of the use of red clover seeds was for seeds of seed lot VI and amounted to 53%. In this seed, the largest loss of seeds on the processing machines was 32%. The smallest seed losses ranged from 11.26%, 11.86% and 12.1% to seeds of II, I and III lot, respectively. Highly significant influence of seed lot on natural seed, processed seed, processing output, and seed losses ( $p \leq 0.01$  or  $p \leq 0.001$ ) was determined.

## Conclusion

Based on the obtained results of the research it can be concluded that in the seed processing of the red clover seed with a different content of inert materials and weeds, all relevant parameters of the treatment depend on the initial purity, and the content of quarantine weeds. The purity of natural red clover seeds ranged from 75% to 85%. The content of inert materials and weeds was different in different seed lots. The content of inert materials was from 7.2% to 21%. The largest weed content in natural seed was 12%. The biggest problem in the processing of red clover seeds is quarantine weeds, above all the dodder (*Cuscuta* spp.) and curly dock (*Rumex* sp.). Their removal makes processing more difficult and more expensive to, and therefore increases the costs. In the production of red clover seed it is best preventive use pure seed without weeds. During the seed processing all failures in the technological process can lead to large losses of seeds, which at the same time presents great economic losses.

## Acknowledgment

This study was supported by the Ministry of Education, Science and Technological Development of the Republic of Serbia, Project No TR – 31057.

## References

- Babić M., Babić Lj. (1998). Uticaj osnovnih fizičkih osobina semena pšenice na karakteristike strujanja vazduha. Selekcija i semenarstvo, Novi Sad, Srbija. 5(3-4): 29-32. (Influence of basic wheat seed physical properties onto airflow characteristics. Plant breeding and seed production, Novi Sad, Serbia. Vol. 5(3-4): pp. 29-32).
- Black, M., Bewley, J., Halmer, P. 2006. The Encyclopedia of Seeds Science, technology and uses. Wallingford, UK.
- Copeland, O., Lawrence, McDonald, Miller, 2004. Seed Drying. Seed Science and Technology, Norwell, Massachusetts, pp. 268– 276.
- Čaturilo, S., Nikolić, B. 1986. Korovi lucerke i njihovo suzbijanje. Nolit, Beograd, Srbija. (Alfalfa weeds and their suppression. Nolit, Belgrade, Serbia).
- Đokić, D. 2010. Primena različitih tehničko-tehnoloških sistema u doradi semena lucerke. Doktorska disertacija. Univerzitet u Beogradu, Poljoprivredni fakultet, Beograd. (Application of diverse technological systems in the alfalfa seed processing. Doctoral dissertation. University of Belgrade, Faculty of Agriculture, Belgrade).
- Đokić D., Stanisavljević R. 2012. Possibility of Improving Seed Processing of Red Clover (*Trifolium pratense* L.) and Alfalfa (*Medicago sativa* L.). Book of the proceedings International Conference on BioScience: Biotechnology and Biodiversity – Step in the Future – The Forth Joint UNS – PSU Conference, June 18-20, Novi Sad, Serbia, pp. 135-148.
- Đokić D., Stanisavljević R., Terzić D., Marković J., Radivojević G., Anđelković B., Barać S. (2012). Primena različitih tehnoloških procesa u doradi semena crvene deteline. Poljoprivredna tehnika. Univerzitet u Beogradu, Poljoprivredni fakultet, Institut za poljoprivrednu tehniku, Beograd, Srbija. br. 3, 1-10. (Application of various technological processes in red clover seed processing. Agricultural Engineering. University of Belgrade. Faculty of Agriculture, Institute of Agricultural Engineering. Belgrade, Serbia. No. 3, pp. 1-10).
- Đokić D., Rade Stanisavljević, Dragan Terzić, Jasmina Milenković, Zoran Lugić, Saša Barać, Aleksandar Vuković (2016): Uticaj korovskih vrsta na efikasnost dorade semena crvene

- deteline (*Trifolium pratense* L.). 18 Naučni skup sa međunarodnim učešćem. Aktuelni problemi mehanizacije poljoprivrede. Univerzitet u Beogradu, Poljoprivredni fakultet, Beograd. 29-37. (Effect of weed species on the efficiency of processing red clover (*Trifolium pratense* L.) seeds. 18th Scientific Conference. Current problems and tendencies in Agricultural Engineering. University of Belgrade. Faculty of Agriculture, Belgrade. pp. 29-37).
- Đukić, D., Moisuc, A., Janjić, V., Kišgeci, J. 2004. Krmne, korovske, otrovne i lekovite biljke, Poljoprivredni fakultet. Novi Sad, Srbija. (Forage, weeds, poisonous and medicinal plants, Faculty of Agriculture. Novi Sad, Serbia).
- ISTA-International Rules for Seed Testing, 1999. Seed Science and Technology, 27, Supplement. p. 1 – 333. Basserdorf, Switzerland.
- Karagić, Đ., Katić, S., Vasiljević, S., Milić, D. 2007. Semenarstvo lucerke u Vojvodini. XI simpozijum o krmnom bilju Republike Srbije sa međunarodnim učešćem, Novi Sad, Srbija, Vol. 44. No. I, 87-98. (Alfalfa seed production in the Vojvodina Province. XI Symposium on forage crops of Republic of Serbia with international participation. Novi Sad, Serbia, Vol. 44. No. I, pp. 87-98).
- Karagić, Đ., Jevtić, G., Terzić, D. 2010. Forge legumes seed production in Serbia. Biotechnology in Animal Husbandry. Publisher: Institute for Animal Husbandry, Belgrade-Zemun, Serbia. 26 (spec. issue), book 1: pp. 133-148.
- Lakić, Ž., Vojin, S. 2010. Variability of agronomic traits of red clover genotypes (*Trifolium pratense* L.). Biotechnology in Animal Husbandry. Publisher: Institute for Animal Husbandry, Belgrade-Zemun, Serbia. 26 (spec. issue), book 2: pp. 35-40.
- Lugić, Z., Radović, J., Terzić, D., Tomić, Z., Spasić, R. 2000. Semenarstvo višegodišnjih leguminoza u centru za krmno bilje Kruševac. XI savetovanje, Semenarstvo krmnog bilja na pragu trećeg milenijuma, Sombor, Srbija, 47-55. (Seed production of perennial legumes in Centre for forage crops in Krusevac. XI Symposium, Forage seed production at the treshold of new millenium, Sombor, Serbia, pp. 47-55).
- Marković, J., Ignjatović, S., Radović, J., Lugić, Z. 2007. Uticaj faze razvića na sadržaj makro i mikroelemenata u lucerki i crvenoj detelini. XI simpozijum o krmnom bilju Republike Srbije sa međunarodnim učešćem, Novi Sad, Srbija, Vol. 44. No. I, 401-406. (Effect of growth stage on microelements and trace elements content in alfalfa and red clover. XI Symposium on forage crops of Republic of Serbia with international participation. Novi Sad, Serbia, Vol. 44. No. I, pp. 401-406).
- Službeni list SFRJ br. 47, 1987. Beograd, Srbija. (Official Gazette of the SFRY, No 47, 1987. Belgrade, Serbia).
- Glasnik Republike Srbije, br. 45, 2005. Beograd, Srbija. (Official Gazette of the Republic of Serbia, No 45, 2005. Belgrade, Serbia).
- Vasiljević, S., Katić, S., Mihailović, V. 2011. Oplemenjivanje crvene deteline (*Trifolium pratense* L.) na poboljšan kvalitet krme. Zbornik referata, 45 savetovanje agronoma Srbije, Zlatibor, 30. 01.-05. 02. 2011, 127-137. (Breeding of red clover (*Trifolium pratense* L.) on improved quality feed. Proceedings, 45 consulting agronomist of Serbia, Zlatibor, 30, 01.-05th February. 2011, pp. 127-137).
- Vučković, S. 1999. Krmno bilje. Beograd: Institut za istraživanje u poljoprivredi "Srbija", Nova Pazova, "Bonart", Srbija. (Forage Crops. Belgrade: Agricultural Research Institute "Serbia", Nova Pazova, "Bonart", Serbia).
- <http://pod2.stat.gov.rs/ObjavljenePublikacije/G2016/pdf/G20162019.pdf>. Accessed 08.06.2017. Statistički godišnjak Republike Srbije, 2016. Republički zavod za statistiku Srbije, Beograd. Srbija). (Statistical yearbook of the Republic of Serbia, 2016. Statistical Office of the Republic of Serbia, Belgrade, Serbia).

## THE EFFECT OF MULTI-YEAR CROP ROTATION ON THE WEEDINESS OF MAIZE

Dušan KOVAČEVIĆ<sup>1\*</sup>, Željko DOLIJANOVIĆ<sup>1</sup>, Vesna MILIĆ<sup>2</sup>, Nemanja GRŠIĆ<sup>1</sup>,  
Aleksandar KOVAČEVIĆ<sup>1</sup>

<sup>1</sup>University of Belgrade, Faculty of Agriculture, Zemun, R.Serbia

<sup>2</sup>University of East Sarajevo, Faculty of Agriculture, Bosnia and Herzegovina

\*Corresponding author: dulekov@agrif.bg.ac.rs

### Abstract

The paper deals with results of the effects of different crop rotation on the weediness of maize. The trial was carried out on the experimental estate of the Faculty of Agriculture - Zemun "Radmilovac" near Belgrade in Serbia. The trial was established in 1992 and has been lasting ever since. The following cropping patterns were included in investigations: continuous cropping, two-field crop rotation (winter wheat-maize) and three-field crop rotation (winter wheat-maize-soya bean) and six-field crop rotation (sunflower-winter wheat-maize-soya bean, spring barley+red clover, red clover). The goal of a crop rotation is to create an unstable environment that discourages weeds from becoming established in the field. The following effects of different crop rotation were studied: floristic composition in weed sinuzia of maize, number of individuals and biomass. Cropping pattern which included many various crops (two-field crop rotation, three-field crop rotation, six-field crop rotation) have better effect in weed control, especially perennial, than continuous cropping of maize. On the basis of our investigations, it has been concluded that the cropping systems had the important application in maize production and protective role in weed control. By rotating crops with different planting dates and growth periods, contrasting competitive characteristics and dissimilar management practices, the regeneration niche of different weed species could be disrupted and particular weed species prevented.

**Keywords:** *Crop rotation, Continuous cropping, Weeds, Maize.*

### Introduction

On the basis of many researches for future of agriculture development in XXI century, as alternatives of conventional obtrude sustainable agriculture. It is considered that future in agriculture will be on the flexible cultural practice, developing of biotechnology and appreciation of basic ecological principles in soil usage. Cultural practices enable maximum utilization of genetic potential for grain yield under the specific agro-ecologic conditions. Today we have important changes will appear in application some cultural practices first of all: soil tillage, fertilization, weed control, crop rotation etc. (Kovacevic, 2008). Agriculture is increasingly based on market laws of supply and demand, that is, conjuncture and this is where economic interests dominate, which are often not in accordance with the agro-biological reasons, at least when it comes to crop rotation (Kovacevic, 2012b). The main crop in sowing structure in Serbia is maize. Apart from continuous maize cropping that is still evident and is still only possible due to the absolute domination of maize on arable land in sowing structure of Serbia, there is still two-field crop rotation (winter wheat - maize) and an increasing number of three-field crop rotation, which includes soya bean, which is very positive (Dolijanović et al., 2009). Dynamics of weed populations in arable fields are influenced by environmental and soil characteristics and also by cropping system and

management practices. Manipulation of cropping systems to improve weed management requires a better understanding of the spatial and temporal dynamics of weeds, seed losses and seed production (Koocheki et.al. 2009). Crop rotation is the most general and most comprehensive cultural practice, which more or less links all others in a mutually dependent system, designed for the successful achievement of certain objectives. The application of crop rotations can significantly increase yield, and one of more important reasons for the yield increase is the reduction of weed infestation, especially of the number of plants per perennial weed species. Two, three and four crop rotations are exceptionally important for the reduction of weed infestation of the most important field crops: maize, wheat and soya bean (Kovacevic and Lazic Branka, 2012a,). All stated studies emphasise the reduction of the number of weed plants per species, the number of perennial weeds, and therefore the reduction of weed biomass per area unit. A situation is largely reverse, when winter wheat is cultivated in continuous cropping, especially in long-term continuous cropping. The effect of the crop rotation on weediness of crops is long lasting: as effects of continuous cropping cannot be explained in a short period, equally, the effects of crop rotations, particularly multi species crop rotations, can be explained only after long-term cultivation of a certain crop in such cultivation systems (Liebman et al, 2001; Dolijanovic et al., 2014). The aim of present study was to evaluate the effects of continuous cropping and different crop rotation on weed community in a twenty three-year period.

### **Material and Methods**

The effect of multi-year continuous cropping and different cropping rotations on weediness in maize were examined on luvisc chernozem soil type in the experimental estate of the Faculty of Agriculture - Zemun "Radmilovac" near Belgrade (Serbia), in 1992 and has been conducted ever since (Picture 1).



Picture 1 Experimental field with different rotation marked with arows and circle (Google map)

The following cropping pattern has been observed:



continuous cropping of maize and different crop rotations: two-crop rotation (winter wheat-maize), three-crop rotation (winter wheat-maize-soya bean) and six-crop rotation (winter wheat-maize-soya bean-spring barley+ red clover-red clover-sunflower).

The plot size under one crop that is one rotation was 12 areas.

The common conventional cropping practices specific for each individual crop were applied in systems, continuous cropping and crop rotations. Long-term effects of various cultivation systems on weed infestation were observed on weed samples drawn on May 27, 2015 by the one square meter area method.

The floristic composition, number of weed plants per species and fresh biomass were determined in the field and then air dry biomass of weeds was measured.

All parameters of weed infestation were statistically processed by the method of a single factor analysis of variance (STATISTICA 5.0 for Windows), while the least significant difference (LSD) test was used for individual comparison of differences between means.

### Results and Discussion

Tables 1 present long-lasting effects of continuous cropping of maize and a various crop rotations on weed floristic composition in maize.

The differences between continuous cropping of maize and other crop rotation systems in weediness were obviously, mainly a result of different weather conditions, especially precipitation sums, and distribution during the growing season of maize in investigated period. Not only do crop rotations affect the reduction of weed infestation, but they also result in greater efficiency of other cropping practices in weed control, first chemical and mechanical crop cultivation measures (Kovacevic et al., 2008). According to data presented in Tables 1, the weed community of maize in all rotation systems was composed of 15 weed species during investigation period, respectively. *Solanum nigrum* L., *Chenopodium album* L., *Amaranthus retroflexus* L., and *Datura stramonium* L. prevailed among annual broadleaf weed species, while *Convolvulus arvensis* L., *Sorghum halepense* (L.) Pers., *Agropyrum repens* (L.) Beauv. *Cynodon dactylon* (L.), Pers., and were dominant perennial weed species. The highest number of weed plants and weed plants per species, with a significant number of annual broadleaf weed plants per species, was registered in maize continuous cropping in investigation period. Perennial weed species, *Convolvulus arvensis* L., *Sorghum halepense* (L.) Pers., *Agropyrum repens* (L.) Beauv., *Cynodon dactylon* (L.) and prevailed and their number was significantly higher with longer continuous cropping compared with tree crop rotation. Not only was a great number of weed plants per species detected in continuous cropping, but also the greatest fresh and air-dry weed biomass was recorded. Again, perennial weed plants per species were more troublesome and they could not be easily eliminated by the application of herbicides. Several-year continuous cropping resulted in qualitative changes in the composition of anthropogenic weed community, due to the application of selective herbicides, which successfully suppressed weed species, and a vacant ground was inhabited by resistant and perennial weed species (Drazic Danica, 1999).

Crop rotations, even a two-crop rotation, as a crop rotation with the lowest number of rotations, have a positive effect on the reduction of weed infestation (Kovacevic, 1989). Kovacevic (2004) pointed out that the crop rotation was not just the most important measure, but also the only measure that could properly facilitate crop protection against weeds, diseases and pests.

Table 1: The effect of different rotations on weed floristic composition in maize (2015.)

No	Weed species	Continuous cropping of maize	Crop rotation		
			two-crop rotation	three-crop rotation	6 - crop rotation
1.	<i>Agropyrum repens</i> (L.) Beauv.	3.20			
2.	<i>Amaranthu sretroflexus</i> L.	3.00	1.66		1.17
3.	<i>Ambrosia artemisiifolia</i> L.	1.64	1.11		1.17
4.	<i>Avena fatua</i> L.				1.64
5.	<i>Capsella bursa-pastoris</i> (L.) Med.	2.84		0.82	
6.	<i>Cirsium arvense</i> (L.) Scop.	3.14		6.10	3.19
7.	<i>Chenopodium album</i> L.	4.04	2.12	1.42	1.89
8.	<i>Convolvulus arvensis</i> L.	11.70	2.16	1.42	1.67
9.	<i>Cynodon dactylon</i> (L.) Pers.	2.11	1.02	2.02	
10.	<i>Datura stramonium</i> L.	2.51	0.94	1.06	2.62
11.	<i>Polygonum aviculare</i> L.	1.66			
12.	<i>Sinapis arvensis</i> L.	1.98		0.96	3.50
13.	<i>Sorghum halepense</i> (L.) Pers.	9.88	1.90	2.33	5.10
14.	<i>Solanum nigrum</i> L.	7.12	2.16	2.18	4.80
15.	<i>Sonchus oleraceus</i> L.	4.04	3.23	2.32	
Total number individuals of weeds		58.86	16.3	20.63	26.75
Total number of weed species		14	9	10	10
Number annual broadleaf weed individuals		28.83	11.22	8.76	16.79
Number perennial weed individuals		30.03	5.08	11.87	9.96
Fresh Biomass g m <sup>-2</sup>		284.13	144.51	156.10	168.11
Air Dry Biomass g m <sup>-2</sup>		61.10	31.02	34.41	50.60

LSD	Total number individuals of weeds	Total number of weed species	Number annual broadleaf weed individuals	Number perennial weed individuals	Fresh Biomass	Air Dry Biomass
0.05	1.98	0.51	2.02	2.02	8.81	2.11
0.01	3.13	0.92	3.01	3.01	12.14	3.44

Due to a greater number of plant species entering the six-crop rotation, possibilities for weed infestation are also greater. According to our studies and studies conducted by Kovacevic et al. (2008), the six-crop rotation expressed greater efficiency in the reduction of weed infestation only in relation to winter wheat continuous cropping. Liebman and Davis (2000) have stated that by the rotation of crops with different sowing dates (summer, spring, autumn) and growth periods, contrasting competitive characteristics and dissimilar management practices, regeneration niches of different weed species could be disrupted and increases in specific weed species prevented. The increased number of weed plants per species per area units means enhanced competition for principal factors of the growth and development, hence the crop density is lower, and without the optimum density, there are no optimum yields. Our study show that the greatest number of weed plants per species was detected in continuous cropping of maize, then in six crop rotations and the lowest number was established in the two crop rotation. A statistically significant dependence between continuous cropping and

crop rotations, as well as, among crop rotations, was estimated by the statistical analysis of data obtained during the years of investigation. The differences between two and three crop rotation, as well as, between two and six crop rotation were statistically significant. The increase of weed fresh biomass per area unit is mainly a result of a greater presence of perennial or annual broadleaf weeds, which are generally more competitive. The lowest values of weed fresh biomass per area unit were obtained in the three crop rotation. The differences in weed fresh biomass among cultivation systems were mainly statistically very significant, with the exception of the difference between the two crop rotation and remaining studied rotations.

### Conclusion

According to the obtained results during investigations of effect multi-year different cropping rotations (crop rotation and continuous cropping) on the weediness of maize in the experimental agricultural farm of Radmilovac (Serbia) the following conclusions can be made:

The weed community in maize was composed of 15 weed species, with dominancy of terophytes.

The annual species *Solanum nigrum* L., *Chenopodium album* L., *Amaranthus retroflexus* L., and *Datura stramonium* L. prevailed among annual broadleaf weed species, while *Convolvulus arvensis* L., *Sorghum halepense* (L.) Pers., *Agropyrum repens* (L.) Beauv., *Cynodon dactylon* (L.), Pers., prevailed from perennials in the weed community in maize.

Obtained results indicate that the highest number of weed plants, weed plants per species, fresh and air-dry biomass were recorded in maize continuous cropping of maize.

The statistically lowest values of the number of weed plants per species and fresh biomass, as the most important parameters of weediness, were recorded in the three crop rotation (winter wheat-maize-soya bean).

Crop rotations, especially three and two crop rotations, were more efficient in the reduction of weed infestation than the six crop rotation and especially continuous cropping of maize.

### References

- Dolijanovic, Z., Kovacevic, D., Oljaca Snezana, Momirovic, N. (2009): Growing winter wheat in continuous cropping and two-crop rotation. *Agricultural Engineering*, XXXIV (2): 143–148 (Serb).
- Dolijanovic, Z., Kovacevic, D., Momirovic, N., Oljaca Snezana, Jovovic, Z. (2014): Effects of crop rotations on weed infestation in winter wheat. *Bulg. J. Agric. Sci.*, 20: 416-420.
- Drazic Danica (1999): The importance of crop rotation on weed control. In: *Crop rotation in field crops* (Molnar, I. Editor), Institute of Field and Vegetable Crops. Novi Sad: 167-190 (Serb).
- Koochehi, Alireza, Nassiri Mehdi, Alimoradi Leila, Ghorbani Reza (2009): Effect of cropping systems and crop rotations on weeds. *Agronomy for Sustainable Development*. Volume 29, Issue 2: 401–408.
- Kovacevic, D., 1989. The effect of different presowing tillage methods and care measure on soil physical properties and grain yields of maize in different crop rotation. PhD thesis. Faculty of Agriculture. University of Belgrade, Zemun, pp. 1-202 (Serb.).
- Kovacevic, D., 2004. Organic Farming-The concept toward environmental protection. A periodical of Scientific Research on Field and Vegetable Crops. Institute of Field and Vegetable Crops, Novi Sad, 40: 353-371 (Serb.).

- Kovacevic, D., Dolijanovic, Z., Oljaca Snezana, Jovanovic, Z. (2008): The effect of crop rotation on weed control. *Acta Biologica Iugoslavica (Serija G), Acta Herbologica*, 17 (2): 45-53 (Serb).
- Kovacevic, D., Dolijanovic, Z., Oljaca, Snezana, Jovanovic, Z., Milosev D., Milic Vesna (2010): Effects of crop rotation on weed floristic composition in winter wheat. *Journal of Scientific Agricultural Research*, 71 (1): 17-25 (Serb).
- Kovacević, D., Lazic Branka (2012a): Modern trends in the development of agriculture and demands on plant breeding and soil management. *Genetika*. Vol. 44, No.1, 201-216. Belgrade.
- Kovacevic, D., Dolijanovic, Z., Jovanovic, Z., Milic Vesna (2012b): Climate change in Serbia: Dependence of winter wheat yield on temperatures and precipitation. Third International Scientific Symposium „Agrosym 2012“ Jahorina, Book of the proceedings, November 15 - 17, [editor in chief Dušan Kovačević]. - Istočno Sarajevo: Poljoprivredni fakultet, 2012. - 1 elektronski optički disk (CD-ROM). <http://www.agrosym.unssa.rs.ba>: 270-276.
- Liebman, M., Davis, A. S. (2000):. Integration of soil, crop and weed management in low-external-input farming systems. *Weed Res.*, 40: 27-47.
- Liebman, M., Mohler L. C., Staver P. C. (2001): *Ecological Management of Agricultural Weeds*. Cambridge University Press.pp.1-531.

## TESTING OF MAIZE INBREED LINES SEED GERMINATION IN THE SOIL

Jasna KOJIĆ\*, Marija MILIVOJEVIĆ, Tanja PETROVIĆ, Marijenka TABAKOVIĆ, Nikola STEVANOVIĆ

Maize Research Institute, Zemun Polje Slobodana Bajića 1, 11185 Belgrade- Zemun, Serbia

\*Corresponding author: kojicjasna@gmail.com

### Abstract

The aim of this paper is to present soil as a growing medium used in germination tests of seeds of some insecticide-treated maize inbred lines that have been carried out at the seed testing laboratory of the Maize Research Institute, Zemun Polje in Belgrade. Although soil is not recommended as a primary growing medium for seed germination because it is not included into standard methods, it is the most natural and the best growing medium for seed germination testing under laboratory conditions. Soil is recommended when seedlings show phytotoxic symptoms or when results of the standard germination test are uncertain. The standard method B(etween) P(aper) with 4x100 seeds and filter paper + soil method with 4x50 seeds were applied in the study in 2015 and 2016. Seeds were treated with the fungicide Maxim Xl and the insecticide Sonido. Soil used in the study was degraded chernozem taken from a maize field and prepared for the medium according to the standard procedure. Seeds were germinated in the germination room at the temperature of 20<=>30°C and 16:8 of light : dark photoperiod. The first count and total germination were recorded on the 4<sup>th</sup> and the 7<sup>th</sup> day, respectively, in both methods. Obtained results indicate that total germination for all maize inbred lines was greater in both years of investigation when filter paper + soil method was applied.

**Key words:** *Seed germination, Maize inbreds, Soil*

### Introduction

Seed germination is the most important parameter of seed quality and its laboratory testing provides information on the maximum potential of germination under optimum conditions. The maximum seed germination potential is often directly opposed to seed germination under environmental conditions, due to which there are differences between laboratory and field germination.

Beside standard methods in seed germination testing, non-standard methods that provide natural conditions for seed germination, are often applied, and they usually give better results of testing. Non-standard methods have to be verified to be applicable. A cold test is a non-standard method applied in seed vigour testing, where soil, sand or their mixture are used as a substrate. Nijenstein and Kruse (2000) established that the least variation of the results was obtained when sand was used as a substrate in the cold test.

The seed germination testing in the soil as a substrate is non-standard method and it is not recommended as a primary method for germination tests, but as an alternative to organic substrates, when results of standard germination tests are doubtful and when a germination expresses phytotoxic symptoms. When the soil is used as a substrate in the seed germination tests, it is necessary that soil meets criteria given in the paragraph 5.4.2 of the ISTA Rules, ISTA Rules (2017), according to which there should be a sufficient amount of air and moisture to provide the growth of the root system; pH has to be within the range of 6.0-7.5

and the substrate has to be microbiologically pure and non-toxic. Each new soil supply for seed germination tests is subject to quality control of these parameters, with the recommendation that the germination substrate is used only once. The two-year research of seed germination in soil in the Missouri laboratory showed that the soil was the best substrate for the growth of all kinds of seeds, Fuhr (1933). Comparing germination substrates and their effects on germination, the seedling development was the most advanced only in the soil, ISTA Handbook of Seedling Evaluation (2013). Although the soil is the most natural substrate for seed germination, it is difficult to standardise this method to be applicable in the laboratory, because each laboratory uses soil from its surroundings, and due to it test results are inconsistent. More consistent results may be gained by using the same soil in the inter-laboratory test comparisons. Radić et al. (2004) established that the seed testing methods should be developed and that their standardisation should be performed in the future, so that they would meet current quality standards and market requirements. A greater application of soil as a seed germination substrate has begun by insecticide treatments of seeds due to phytotoxicity and uncertainty of the results obtained by the standard method. It has been observed in laboratories that seed germination in the soil had yielded the best results of total germination, especially in seeds of inbred lines treated with insecticides, which otherwise had slower and lower germination than hybrids.

### Material and methods

During 2015 and 2016, 10 seed lots of inbred lines, produced in various locations and different years, were tested at the Seed Testing Laboratory of the Maize Research Institute, Zemun Polje. The seed was processed and treated with fungicide Maxim XL 035FS and insecticide Sonido. According to Ferguson (1993), seed lots with similar values of seed germination, may differ in physiological maturity, and therefore in seed vigour. The following two test methods were applied: BP (between filter paper method) with 4x100 seeds (standard method) and the filter paper + soil method with 4x100 seeds (non-standard method). The soil was degraded chernozem taken from the maize field, sieved to obtain a smaller and more uniform fraction. In 2015, 20 bags with soil were taken from the field (pH=7.5, moisture=17.9%, and moisture capacity=48%). Seeds of the species *Festuca rubra*, susceptible to toxicity, were germinated to establish non-toxicity of the collected soil. The soil was sieved through the 5-mm sieve and 67.6% soil passed through the sieve. In 2016, 60 bags with soil were taken from the field. Seeds of the species *Festuca rubra* were germinated to establish non-toxicity of the collected soil, and at that time it was established that the soil did not contain toxic matters and that it was microbiologically pure (pH=7.5, moisture=14.4%, and moisture capacity=46%). Furthermore, the soil was sieved through the 5-mm sieve and 93.24% soil passed through the sieve with this mesh size, ISTA Handbook of Seedling Evaluation (2013). When the standard method was applied, the seed was placed on water saturated filter paper, which was covered by another filter paper, then it was rolled and placed into the germination cabinet at the alternating temperatures 20<=>30°C and the light regime 16 h : 8 h (light : dark). When the non-standard method was applied, the seed was placed on previously water saturated filter paper, to which soil was added, then it was rolled and placed into the germination cabinet under the same test conditions (alternating temperatures 20<=>30°C and the light regime 16 h : 8 h (light : dark)). The first count, in both methods, was made on fourth day, while the total germination was determined on the seventh day, ISTA Rules (2017). The obtained values were expressed as the percentage of normal seedlings.

Gained results were statistically processed by the computer program MSTAT. The two factorial analysis of variance and the least significant difference (LSD) test were applied, Hadživuković (1991).

### Results and Discussion

The analysis of variance shows statistically significant differences in total germination over tested seed lots, as well as over the applied germination methods. The seed germination method, year of seed germination testing and the analysed lots of inbred lines affected seed germination. Interactions among observed factors were also very significant (Table 1). The year of investigation did not affect tested seed germination. There were no statistically significant differences between replications and between the interactions of the factor B.

Table 1. Statistical significance of effects of observed factors on total germination of seeds

Factor	Degree of freedom (DF)	Mean squares (MS)	F value
Replication	1	2.450	0.261 <sup>ns</sup>
Method (A)	1	4681.800	500.8646 <sup>**</sup>
Year (B)	1	31.250	3.3432 <sup>ns</sup>
AB	9	352.800	37.7430 <sup>**</sup>
Lot (C)	9	356.856	38.1768 <sup>**</sup>
AC	9	145.439	15.5592 <sup>**</sup>
BC	9	182.944	19.5716 <sup>**</sup>
ABC	9	76.439	8.1775 <sup>**</sup>
Error	39	9.347	

ns – not significant; \*\* - significant at the level of 0.01%; df – degree of freedom

The highest seed germination percentage in both years was recorded when the filter paper + soil method was applied. Lower values were obtained by the standard seed germination method.

In 2015, average total germination over methods was higher by 19% when the filter paper + soil method was applied. Moreover, in 2016, total germination was greater by 11% in the variant when the filter paper + soil method was applied. The lowest total seed germination was recorded in the lots 1, 2 and 4 (80.00%, 74.88 and 67.75%, respectively), while the highest value was established in the lots 6, 8 and 10 (87.00%, 88.75% and 87.38%, respectively).

The analysis of results by the LSD test for the interaction between two methods and lots shows that the lowest value of total germination was in the lot 4 (F), which is a statistically significant difference, while differences obtained in lots 8, 10, 6 and 7 (A) were not statistically significant.

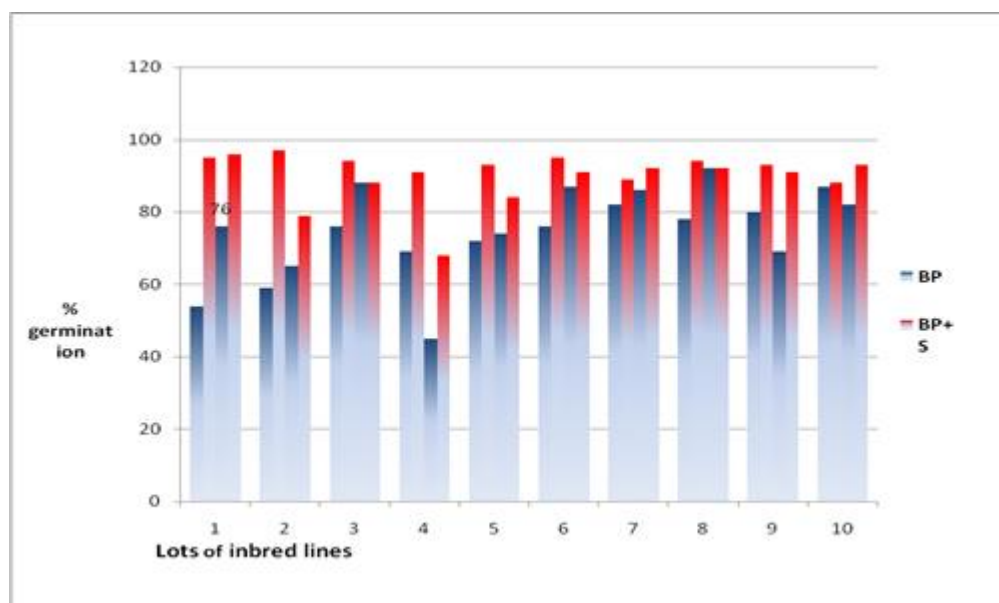
The gained results on seed germination (Table 2) indicate that the filter paper + soil method is suitable for testing seeds treated with insecticides. The comparison of results obtained by the standard and non-standard method shows that seed germination was significantly lower when the standard method was applied including all 10 lots and both years of investigation.

Table 2. Average seed germination (%) in 2015 and 2016 over methods and lots

2015	Method	Tested lots										Average over methods
		1	2	3	4	5	6	7	8	9	10	
	BP	54	59	76	69	72	76	82	78	80	87	73,1 D
	FP+S	95	97	94	91	93	95	89	94	93	88	92,60 C
2016	BP	76	65	88	45	74	87	86	92	69	82	76,05 A
	FP+S	96	79	88	68	84	91	92	92	91	93	87,15 B
Average over lots		80.00 D	74.88 E	86.13 AB	67.75 F	80.38 CD	87.00 A	86.88 A	88.75 A	83.13 BC	87.38 A	

FP+S-filter paper + soil, BP – between filter papers

Figure 1. Total seed germination (%) over methods



BP – between filter papers, FP+S-filter paper + soil

### Conclusion

Based on achieved results it can be concluded that soil as a substrate for seed germination tests is suitable for seeds treated with insecticides. It was also confirmed that soil as a substrate in seed germination tests is more natural environment for seed, hence the results of germination tests were higher than the results gained by the standard method. Despite the defined properties that the soil has to have in order to be used as a substrate for seed germination tests, it is difficult to standardised soil as a method due to its inconsistency in chemical, microbiological and physical traits. The soil method should always be an alternative to the standard seed germination method when there is a doubt in test results. Results of germination tests obtained by the filter paper + soil method were higher in both years than those obtained by the standard BP method. The Seed Testing Laboratory has been using soil as the substrate for seed germination tests. Although this method is very demanding, as it is



necessary to collect soil, sieve and check it, certainty of results is the reason why we have decided to use this method.

### **References**

- Clara Fuhr (1933) – Proceedings of the Association of Official Seed Analysts of North America (1930), vol 23/24/25/26, pp 263-265
- Ferguson J.M. (1993): AOSA Perspective of Seed Vigoru Testing. Journal of seed Technology, vol 7, no 2, 101-105
- International Seed Testing Association (2013). ISTA Handbook on Seedling Evaluation, ISTA Basserdorf, CH
- International Seed Testing Association (2016). International Rules for Seed Testing, ISTA Basserdorf, CH
- Nijënstein J.H., Kruse M. (2000): The potential for standardisation in cold testing of maize (*Zea mays* L.), Seed Sci. & Technology, 28, 837-851
- Radić V., Milošević M., Establishment of quality indicators for corn seeds using various methods of testing (2004): Plant Breeding and seed production, vol X, no 1-4, pp. 51-59

## **CHANGES IN FRUIT QUALITY OF STRAWBERRY CULTIVAR ‘JOLY’ DURING HARVEST**

Jelena TOMIĆ\*, Marijana PEŠAKOVIĆ, Žaklina KARAKLAJIĆ-STAJIĆ, Rade MILETIĆ, Svetlana M. PAUNOVIĆ, Mira MILINKOVIĆ

Fruit Research Institute, Kralja Petra I, 9, Čačak, Republic of Serbia

\*Corresponding author: jtomic@institut-cacak.org

### **Abstract**

The aim of this research was to determine differences in physico-chemical properties of strawberry in four harvest time (T1: 05.05.; T2: 13.05.; T3: 22.05.; T4: 29.05.). The research was conducted in an experimental planting of strawberry cultivar ‘Joly’ at the Fruit Research Institute, Čačak (Serbia). Strawberries were planted in August 2015 in double rows on beds covered with black polyethylene foil. Physico-chemical properties such as fruit mass, size, (length and width), shape index, firmness, total soluble solids and antioxidant capacity were investigated. Results showed that major changes in fruit were developmentally regulated. Significant decreases in mass and size coupled with significantly decline in antioxidant capacity were determined at T3 and T4 time. Shape index was higher in fruits gathered at T3 compared to another harvest times. On the other hand, significantly higher total soluble solids and firmness were observed in the fruits collected at T3 and T4 time. The obtained results underline the important role of harvest time on quality characteristics of strawberry ‘Joly’. Fruit harvested in the first half of harvesting season showed a good physical properties and antioxidant capacity, which could positively influence the fruit marketing. The best performance in terms of fruit firmness indicates better shelf life of fruits harvested in the second half of the harvesting season.

**Keywords:** *strawberry, harvest time, physico-chemical properties*

### **Introduction**

An important factor in the intensification of strawberry production is cultivar innovation, which aims to ensure that the market is supplied with high quality fruits as evenly as possible. In strawberries plantations of Republic of Serbia, apart from ‘Clery’, as a predominant cultivar, an intense expansion of the cultivar ‘Joly’ can be observed in recent years. When defining the value for cultivation and use of introduced cultivars, a lot of importance is given to ripeness, maturity, irrigation, and fertilisation, in addition to the effect of genotype. Strawberry is a non-climacteric fruit and it must be harvested at full maturity to achieve maximum quality. The main changes in fruit composition, which are usually associated with ripening, take place when the fruit is still attached to the mother plant. Consequently, strawberries should be harvested ready for consumption. This means there is very short period of fruit at its best quality (Manning, 1996; Cordenunsi et al., 2003; Voća et al., 2006). Pincemail et al. (2012) point out that the harvest (in the phase of the full maturity of fruit) is a highly significant factor of fruit quality. Harvesting at the proper stage of maturity is essential for optimum quality and often for the maintenance of this quality after harvest (Strum et al. 2003).

The aim of this study is to establish the harvests, which will secure the best quality of strawberries ‘Joly’.

## **Materials and Methods**

The strawberry samples intended for the analysis of the fruit quality were harvested in the plantation of 'Joly' cultivar located in central Čačak, in the Western Morava valley, the west area of Serbia (43° 53' N, 20° 20' E, 225 m altitude). The layout of the experiment was a completely randomized design, with the effect of one factor, harvest time, analyzed. Sixty plants (3 replications, 20 plant each) were planted in August 2015, applying the standard cultural practices, including a drip-irrigation system. The plants were planted on the slopes, covered with a black PE foil, in a two-row planting system, and the density of 30×30cm. In March, the plantation was covered with a plastic tunnel. The samples for the analysis were gathered in the four harvest time during of May 2016(T1: 05.05.; T2: 13.05.; T3: 22.05.; T4: 29.05.) in phase completely ripe when exhibited an intense red colour all over the fruits. Physical properties of fruit (weight (g), length (mm), width (mm), shape index and firmness) are determined by standard morphometric methods on the sample of 60 fruit per a harvest (3 replications, 20 fruits each). Fruit weight is determined by measuring on analytical scale Mettler, with accuracy of ± 0.01 g. Height and width are determined by a digital caliper (Carl Roth, Germany) accuracy of ± 0.05 mm. (mm). The value of fruit shape index is obtained by calculation, establishing relationship between fruit length and width. Fruit firmness is determined by using a penetrometer, and results were expressed in N. The soluble solids content (SSC) was determined by digital refractometer (ATC, Belgium) at 21°C. A drop of homogenized and filtrated sample was placed on the lens and the reading was taken in % of soluble solids content in the fruit. The antioxidant capacity was determined by a ABTS method, spectrophotometry in ethanol extract of the sample (Re et al., 1999). The results were expressed in mg equivalents of Trolox per 100 g of fresh weight (mg Troloxeq 100 g<sup>-1</sup>fw). The data obtained in the research was processed applying the Fisher model of variance analysis (ANOVA, F test) and the statistics software package STATISTICA version 8.0 (StatSoft, Inc., Tulsa, OK, USA). The analyses were performed in three replications and the obtained values were expressed as the mean value. Testing the significance of differences between the means of the treatments and their interaction effects was performed using the LSD test and the significance level of 0.05.

## **Results and Discussion**

Physical properties of fruits represent an important indicator of quality, and fruit mass is one of the most important pomological properties of the highly productive cultivars of strawberry. In evaluating new strawberry cultivars, large fruits are especially favoured, which is significant from the point of increasing the efficiency of hand-picking and marketing. The results obtained in this research revealed a significantly higher fruit mass in the first harvest (40.1 g), compared to other harvests under consideration (Table 1). In accordance with the greatest fruit mass, the highest values of fruit dimensions were also recorded (52.2 and 46.7 mm) in T1. Milivojević et al. (2015) emphasize that despite approximate yields of cultivar 'Joly' per plant as in cultivar 'Clery', the average fruit mass of the cultivar 'Joly' were higher for the 4.1 g. The variation in the shape of fruit was also evident between the two mentioned cultivars, whereas 'Joly' was characterized by an elongated conical shape (value of the shape index of 1.11), and the fruit shape in 'Clery', predominantly roundly tapered (value of the shape index 0.99 ) In our study too, the cultivar 'Joly' was characterized by an elongated conical shape of the fruit throughout the harvesting season, with a significantly higher value in T3 (value of the shape index 1.3), compared to other investigated harvests. In addition to the mass, dimension and shape index, the firmness is a trait that directly affects the quality of the strawberries. According to the results obtained in our research, a significantly higher

firmness was observed in T3 and T4 (13.08 and 13.90 N, respectively), compared to other two harvests under consideration. Shape, size, density, specified gravity, colour, firmness, pH value, and titratable acids are some of the major physical and physicochemical characteristics that are critical in the design of harvesting and processing equipment (Liang et al. 1991; Xie & Zhao, 2003).

Table1. Influence of harvest time on fruit physical properties

Harvest time	Mass (g)	Length (mm)	Width (mm)	Shape index	Firmness (N)
T1	40.1 ± 079 a	52.2 ± 1.49 a	46.7 ± 1.82 a	1.1 ± 1.82 b	8.50 ± 0.05 b
T2	26.6 ± 1.57 b	42.5 ± 0.84 b	38.7 ± 1.41 b	1.1 ± 1.41 b	10.27 ± 0.03 b
T3	12.0 ± 0.68 c	38.4 ± 1.62 c	29.5 ± 0.73 c	1.3 ± 0.73 a	13.08 ± 0.02 a
T4	8.3 ± 0.26 d	25.8 ± 0.32 d	25.8 ± 0.42 c	1.0 ± 0.42 b	13.90 ± 0.03 a

The different lower-case letters in the columns indicate statistically significant differences among the mean values at  $P \leq 0.05$  level (LSD test).

Our research shows that there has been a considerably growing dissatisfaction with non-uniform quality of strawberry fruit (Voća et al., 2007). Consumer acceptance of strawberries depends to a large extent, on the taste of the fruit, which is closely related to the content of soluble solids matter (Tulipani et al., 2008). Figure 1 shows the impact made by the harvest time on SSC in strawberry fruits.

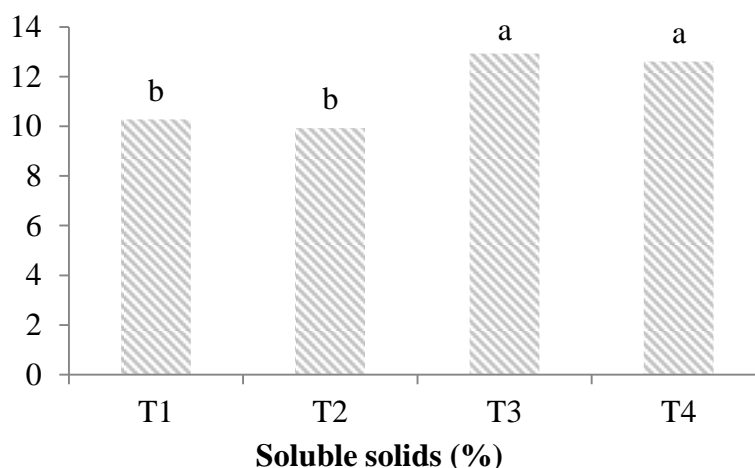


Figure 1. Effect of harvest time on the soluble solids content in strawberries ‘Joly’; the different letters indicate statistically significant differences at  $P \leq 0.05$  level (LSD test).

Significantly higher SSC was observed in later harvests (T3–12,93% and T4–12,60%) compared to earlier harvests (T1–10,27% and T2–9,93%). The results obtained in this work correspond to earlier investigations carried out by Strum et al. (2003) who, in the course of studying the content of total soluble solids in strawberry fruits of 13 different cultivars and maturity stage, established a strong increase in SSC during the last stage of ripening in cultivars ‘Miss’, ‘Eros’ and ‘Symphony’. On the other hand, Capocasa et al. (2008) found a negative correlation between fruit size and most of the nutritional quality parameters. The same authors pointed out that strawberry fruit size negatively correlated with the commercial

quality (TA and SSC) and nutritional parameters (TPH, TEAC and FRAP). The stated results are in accordance with the results of our investigations, having in mind that fruits of the second half of harvesting season are characterized by significantly lower mass and dimension, and a substantially higher content of SSC in relation to the fruits picked in the first two harvest times. However, based on the data shown in Figure 2, a consistently high antioxidant capacity in all harvests could be observed, except in T4 with the lowest value of antioxidant capacity recorded ( $2.64 \text{ mmol Trolox eq} \cdot 100 \text{ g fw}^{-1}$ ). Results by Tomić et al. (2015) indicate that a newly strawberry cultivar ‘Joly’ containing high antioxidative capacity was superior to a major cultivar ‘Clery’ that has been broadly cultivated in Republic of Serbia. The stated results are important particularly having in mind that demand and availability of strawberries (*Fragaria × ananassa* Duch.) have increased substantially during recent years, driven in part, by the highly desired taste of the fruit, along with its known health-promoting properties (Wang et al. 2005; Bordonaba & Terry, 2010). The greatest part of biological effects of polyphenols can be contributed to their antioxidant activity. However, it is important to emphasize that the chemical composition of fruit berries is conditioned by a number of factors, among which most important are genotype, climatic conditions, agricultural practices, degree of fruit ripeness and others. Previously conducted research (Battino & Mezzetti, 2006; Tulipani et al., 2008) point to the crucial role of genotype in the content of antioxidants in strawberries.

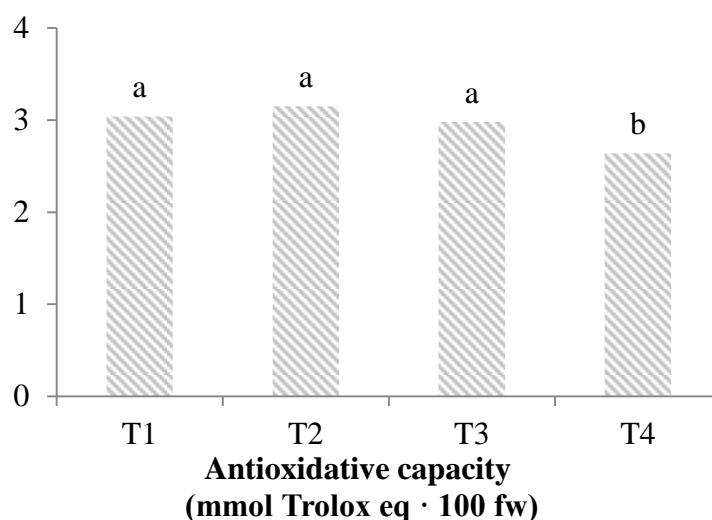


Figure 2. Effect of harvest time on the antioxidant capacity in strawberries ‘Joly’; the different letters indicate statistically significant differences at  $P \leq 0.05$  level (LSD test).

### Conclusion

The best result concerning the external appearance and the beneficial health effect of fruits strawberry cultivar ‘Joly’ can be achieved in earlier harvests, which could positively influence the fruit marketing. The best performance in terms of fruit firmness and soluble solids content indicates better shelf life of fruits harvested in the second half of the harvesting season. We suggest that the fruit quality of strawberry cultivar ‘Joly’, in future investigations, should be coupled with subjective evaluations by a taste panel to yield complete information about the edible quality of fresh fruit.

### **Acknowledgements**

This study is the part of the project No. 31093 financed by Ministry of education, science and technological development of the Republic of Serbia. We hereby express our sincere gratitude for the support. 'Content of bioactive components in small and stone fruits as affected by cultivar specificities and growing conditions, and obtaining biologically valuable products by improved and newly developed technologies'.

### **References**

- Battino, M., Mezzetti, B. (2006). Update on fruit antioxidant capacity: a key tool for Mediterranean diet. *Public health nutrition*, 9, 1099–1103.
- Bordonaba, J.G., Terry, L.A. (2010). Manipulating the taste-related composition of strawberry fruits (*Fragaria* × *ananassa*) from different cultivars using deficit irrigation. *Food Chemistry*, 122(4), 1020–1026.
- Capocasa, F., Scalzo, J., Mezzetti, B., Battino, M. (2008). Combining quality and antioxidant attributes in the strawberry: The role of genotype. *Food Chemistry*, 111, 4, 872–878.
- Cordenunsi, B.R., Nascimento, J. R.O., Lajolo, F.M. (2003). Physico-chemical changes related to quality of fvestrawberry fruit cultivars during cool-storage. *Food Chemistry*, 83, 167–173.
- Liang, M., Chen, L.H., Hegwood JR., C.P. (1991). Physical and mechanical properties of muscadine grapes. *Technical Bulletin-Mississippi Agricultural and Forestry Experiment Station*, 176, 1–22.
- Manning, K. (1996). Softfruits. In: Seymour, G.B., Taylor, J.E., Tucker, G.A. (Eds.), *Biochemistry of fruit ripening*, Chapman & Hall London: 347–373.
- Milivojević, J., Radivojević, D., Nikolić, M. 2015. Production properties and quality of cultivars and new selection of strawberries introduced from Italy. *Proceedings of the Fifth Conference 'Innovation in fruit growing', theme 'Contemporary production of the strawberry'*, 65-75.
- Pincemail, J., Kevers, C., Tabart, J., Defraigne, J.O., Dommes, J. (2012). Cultivars, culture conditions, and harvest time influence phenolic and ascorbic acid contents and antioxidant capacity of strawberry (*Fragaria* × *ananassa*). *Journal of Food Science*, 77, 2, 205–209.
- Re, R., Pellegrini, N., Proteggente, A., Pannala, A., Yang, M., Rice-Evans, C. (1999). Antioxidant activity applying an improved ABTS radical cation decolorization assay. *Free radical biology and medicine*, 26(9), 1231–1237.
- StatSoft, Inc. 2007. *STATISTICA* (data analysis software system), version 8.0.
- Sturm, K., Koron, D., Stampar, F. (2003). The composition of fruit of different strawberry varieties depending on maturity stage. *Food Chemistry*, 83, 3, 417–422.
- Tomic, J., Milivojevic, J., Pesakovic, M. (2015): The response to bacterial inoculation is cultivar-related in strawberries. *Turkish Journal of Agriculture and Forestry*, 39, 332–341.
- Tulipani, S., Mezzetti, B., Capocasa, F., Bompadre S., Beekwilder, J., Ric de Vos, C.H., Capanoglu, E., Bovy, A., Battino, M. 2008. Antioxidants, phenolic compounds, and nutritional quality of different strawberry genotypes. *Journal of Agricultural and Food Chemistry*, 56, 696–704.

- Voća, S., Dobričević, N., SkendrovićBabojelić, M., Družić, J., Duralija, B., Levačić J. (2006). Differences in fruit quality of strawberry cv. Elsanta depending on cultivation system and harvest time. *Agriculturae Conspectus Scientificus*, 72 (4), 285–288.
- Wang, S.Y., Feng, R., Lu, Y., Bowman, L., Ding, M. (2005). Inhibitory effect on activator protein-1, nuclear factor-kappaB, and cell transformation by extracts of strawberries (*Fragaria* × *ananassa*Duch.). *Journal of Agricultural and Food Chemistry*, 53(10), 4187–4193.
- Xie, J., Zhao, Y. (2004). physical and physicochemical characteristics of three U.S. strawberry cultivars grown in the Pacific Northwest. *Journal of Food Quality*, 27, 181–194.

## EFFECT OF GROWING SEASON AND GENOTYPE ON WINTER WHEAT QUALITY

Kristina LUKOVIĆ<sup>1\*</sup>, Veselinka ZEČEVIĆ<sup>2</sup>, Slaven PRODANOVIĆ<sup>3</sup>, Jelena MILIVOJEVIĆ<sup>1</sup>, Vera ĐEKIĆ<sup>1</sup>

<sup>1</sup>Centre for Small Grains, Kragujevac, Serbia

<sup>2</sup>Faculty of Biofarming, Bačka Topola, John Naisbitt University Belgrade, Serbia

<sup>3</sup>Faculty of Agriculture, University of Belgrade, Zemun, Serbia

\*Corresponding author: kika@kg.ac.rs

### Abstract

In this study, 11 winter wheat cultivars (KG-56S, Toplica, Perfekta, Takovčaka, Aleksandra, Vizija, Planeta, Kruna, Harmonija, Rujna and Premija) were investigated. The research was conducted in experimental field of the Centre for Small Grains Kragujevac (Serbia) during two growing seasons (2012/13, 2013/14). Variability of bread-making quality properties (sedimentation value and wet gluten content) was investigated. Quality components depended significantly upon genotype and environment factors. For a two-year average, sedimentation value varied from 23.33 ml (Premija) to 33.33 ml (Aleksandra, Planeta and Harmonija). The analyses of variance showed highly significant differences in sedimentation values between genotypes ( $F=244.273^{**}$ ), investigated years ( $F=717.176^{**}$ ), as well as their interaction ( $F=50.767^{**}$ ). The highest wet gluten content on average was established at KG-56S cultivar (39.63 %) and the lowest at Kruna (27.92 %). There were highly significant differences in the wet gluten content among genotypes ( $F=81.622^{**}$ ), investigated years ( $F=816.569^{**}$ ), as well as their interaction ( $F=25.974^{**}$ ). The analysis of phenotypic variance indicated that the highest impact of variance for sedimentation value belonged to genotype, while the highest impact of variance for wet gluten content belonged to year.

**Key words:** *wheat, cultivar, quality, sedimentation value, gluten content.*

### Introduction

Grain quality is a complex character that depends on a number of traits, and the individual contribution of each trait varies depending on the specific reaction to environmental conditions (Mladenov *et al.*, 2001).

It is known that the quality of wheat depends, to a large extent, on the quantity and quality of gluten. Gluten proteins, consisting of gliadins and glutenins, play an important role in bread-making quality of wheat flour as gliadins mainly contribute to dough viscosity and extensibility, while glutenins affect dough strength and elasticity (Wieser, 2007). The composition of the stored proteins is a genotype characteristic and is independent of the conditions of the external environment. In recent years, a large number of papers have been published in which the emphasis of the positive effect of some gluten subunits on the technological quality of wheat (Li *et al.*, 2009; Kaya and Akcura, 2014; Mohan and Gupta, 2015).

However, the quantity of proteins depends to a great extent on the environmental factors. Thus, in a favorable regime of a mineral nutrition, soil moisture and air temperature, wheat genotypes achieve greater efficiency in pouring grains, accumulation of nitrogenous substances in the grain, and therefore increased protein content in grains. On the other hand, high temperatures in the filling phase, as well as prolonged harvest caused by abundant



precipitation, lead to changes in the quality of wheat and protein content (Đurić *et al.*, 2010; Hurkman and Wood, 2011).

Knowledge of the relative contributions of genotype and environment, as well as genotype and environment interaction effects on wheat quality, leads to more effective selection in breeding programs and segregation of more uniform parcels of grain better suited to the needs of customers (Williams *et al.*, 2008). It is desirable that wheat varieties maintain a good and stable grain quality in different environmental conditions. Stability of wheat quality characteristics over locations and years is important to the milling and baking industry, whose processing technology requires consistent raw materials in order to produce a quality end product (Grausgruber *et al.*, 2000).

The goal of this research is investigation of influence of the year, genotypes and their interactions on some wheat quality traits.

### **Materials and Methods**

In this study, 11 winter wheat cultivars (KG-56S, Toplica, Perfekta, Takovčaka, Aleksandra, Vizija, Planeta, Kruna, Harmonija, Rujna and Premija) were investigated. The research was conducted in the experimental field of the Centre for Small Grains Kragujevac (Serbia) during two growing seasons (2012/2013 and 2013/2014). Experiment was carried out by the standard technology of scientific farming production of wheat. The period of the experiment is characterized by different meteorological conditions. During the growing period of wheat 2012/2013., 611.1 mm of precipitation fell in the area of Kragujevac. The average air temperature for the same period was 9.83°C. In the range from October 2013. to June 2014., 629.6 mm of precipitation fell in Kragujevac, while the average air temperature for the same period was 10.42°C (Republic Hydrometeorological Service of Serbia). The stem elongation period of wheat, during the month of April, started in similar temperature conditions in both vegetation seasons, with an amount of precipitation significantly higher in 2013/14. (129.1 mm compared to 41.2 in 2012/13.). During a May, when heading takes place and the process of grain filling starts, 2013/14 is characterized by extreme rainfall (227 mm) and slightly lower air temperature (15.4°C). However, in June, the air temperature was similar in both vegetation seasons but the amount of rainfall was higher in 2012/13. (85.4 mm compared with 66.9 mm in 2013/14.).

Variability of bread-making quality properties (sedimentation value and wet gluten content) was investigated. Grain samples were milled using a Brabender Quadrumat Junior laboratory mill. The quality analysis of Zeleny sedimentation test was carried out by ICC standard method No. 116/1 (1994), and wet gluten content was done by ICC standard method No. 106/2 (1984).

The results of the research were studied by Analysis of Variance (ANOVA) according to completely randomized block design with two main factors (genotype and year) and using MSTAT-C statistical program. Evaluation of importance of the difference between average values of studied characteristics was tested by separate LSD test. Components of variance (genetic, interaction and environment) were calculated by Falconer (1981).

### **Results and Discussion**

The genetically determined composition of gluten is the main determinant of genotypic differences in baking quality (Payne *et al.* 1987). Sedimentation value and wet gluten content are important quality components due to their positive correlation with other parameters of technological quality of wheat (Zečević *et al.*, 2004; Vázquez *et al.*, 2012; Laidig *et al.*, 2017). These quality parameters are both an indicator of the quality and quantity of proteins.

In these studies, it was found that sedimentation value in analyzed wheat cultivars varied, and on average it ranged from 23.33 ml (Premija) to 33.33 ml (Aleksandra, Planeta and Harmonija). In the first year of the research, the highest average value of the sedimentation had the cultivar Planeta (32.67 ml), and in the second year the cultivar Harmonija (38 ml). On average, the sedimentation value was higher in 2014 (31.76 ml) compared to 2013 year (28.03 ml), Table 1.

Analysis of variance showed highly significant differences among investigated genotypes ( $F=244.273^{**}$ ), years ( $F=717.176^{**}$ ) and their interactions ( $F=50.767^{**}$ ). Components of variance for sedimentation volume have shown that the most variability belonged to genotype (46.07%), while the influence of the year (28.82%) and interactions genotype x year (23.68%) was lower (Table 2). This suggests that sedimentation depends predominantly on genetic factors, but the impact of environmental factors and their interaction (genotype x environment), that play a major role in the expressing of this property, should not be ignored (Zečević *et al.*, 2007; Kaya and Akcura, 2014; Abdipour *et al.*, 2016).

Table 1. Mean values for sedimentation volume of winter wheat cultivars

Genotype	Sedimentation volume (ml)		
	Year		Average
	2012/2013	2013/2014	
Kg-56S	28.67fg	32.67d	30.67c
Toplica	32.00de	34.00c	33.00a
Perfekta	28.67fg	29.33f	29.00d
Takovčanka	28.00g	31.00e	29.50d
Aleksandra	32.00de	34.67c	33.33a
Vizija	28.00g	36.00b	32.00b
Planeta	32.67d	34.00c	33.33a
Kruna	26.67h	25.33i	26.00e
Harmonija	28.67fg	38.00a	33.33.a
Rujna	21.67j	29.00fg	25.33e
Premija	21.33j	25.33i	23.33f
Average	28.03	31.76	29.89

Distinct letters in the row indicate significant differences according to LSD test ( $P \leq 0.05$ ).

Table 2. Analysis of variance for sedimentation volume of winter wheat cultivars

Source	DF	MS	F	LSD		Components of variance	
				0.05	0.01	$\sigma^2$	%
Genotype (A)	10	78.076	244.273**	0.728	1.035	10.31	46.07
Year (B)	1	229.227	717.176**	-	-	6.45	28.82
AB	10	16.227	50.767**	1.029	1.464	5.30	23.68
Error	42	0.320	-	-	-	0.32	1.43
Total	65	-	-	-	-	22.38	100

\*\* Significant at P = 0.01 level

The quality of wheat products depends on the quantity and quality of gluten. It is known that the quality of gluten is one of the most important factors in breeding to improve the quality of grain wheat, which plays a decisive role in the quality of dough and bread.

The highest wet gluten content was established in average at Kg-56 s cultivar (39.63%), and the lowest at Kruna (27.92%). Looking at the years of research, in the first year the highest wet gluten content was established at Kruna cultivar (45.20 %), and in the second year at Planeta (35.25 %). On average, the wet gluten content was higher in 2013 (36.89%) compared to 2014 year (30.75%). All of the analyzed cultivars had wet gluten content above 30%, except at Kruna, what indicated good technological quality of flour and dough (Table 3).

Table 3. Mean values for wet gluten content of winter wheat cultivars

Genotype	Wet gluten content (%)		
	Year		Average
	2012/13	2013/14	
Kg-56S	45.20a	34.06fg	39.63a
Toplica	38.28bc	32.75gh	35.51bc
Perfekta	38.76b	30.20ijk	34.48cd
Takovčanka	33.96fg	29.93jk	31.94e
Aleksandra	39.03b	31.32hij	35.17bc
Vizija	39.59b	31.51hij	35.55bc
Planeta	36.99cd	35.25ef	36.12b
Kruna	33.64g	22.20l	27.92g
Harmonija	36.10de	31.53hi	33.81d
Rujna	34.28fg	29.48k	31.88e
Premija	29.99ijk	30.04ijk	30.01f
Average	36.89	30.75	33.82

Distinct letters in the row indicate significant differences according to LSD test ( $P \leq 0.05$ ).

Analysis of variance's components has shown that the biggest share in the wet gluten content have the year (56.30%), while the influence of variety and interactions variety x years was lower, Table 4.

Table 4. Analysis of variance for wet gluten content of winter wheat cultivars

Source	DF	MS	F	LSD		Components of variance	
				0.05	0.01	$\sigma^2$	%
Genotype (A)	10	62.206	81.622**	1.123	1.597	7.068	21.79
Year (B)	1	622.320	816.569**	-	-	18.258	56.30
AB	10	19.795	25.974**	1.588	2.259	6.344	19.56
Error	42	0.762	-	-	-	0.762	2.35
Total	65	-	-	-	-	32.432	100

\*\* Significant at P = 0.01 level

These results were different from the results published by Zečević *et al.* (2007), who established that the largest impact of variances in the total variance for gluten content belongs to the genotype. Mladenov *et al.* (2001), on the other hand, found that the largest contribution of variance for wet gluten content belongs to the interaction cultivar x environment. These authors carried out research on a number of sites, which affected high components of the variance for the interaction cultivar x environment. The same authors pointed out that relatively high value of genotype x environment interaction for quality traits require multiple years and site testing to accurately assess the genetic potential of varieties.

Improvement of end-use quality in bread wheat depends on a complete understanding of current wheat quality and the influences of genotype, environment, and genotype x environment interactions on quality traits (Zhang *et al.*, 2004).

### Conclusion

The investigation of wheat quality characteristics has shown that there are differences between wheat varieties indicating the specificity of the genotype. Different values of tested wheat properties in different cultivation years have also been established, which indicates the existence of different environmental factors in the years of research. On average, the highest sedimentation value was established at Premija cultivar. Components of variance for sedimentation volume were shown that the most variability belonged to genotype, while influence of the year and interactions genotype x year was approximately the same.

Cultivar KG-56S had the highest average value of wet gluten content. On average, the wet gluten content was higher in 2013 compared to 2014 year. Analysis of variance showed highly significant differences among investigated genotypes, years and their interactions for both analyzed traits of wheat quality.

### Acknowledgement

This investigation was supported by Ministry of Education, Science and Technology Development of Republic of Serbia, Project III 46006.

## References

- Abdipour M., Ebrahimi M., Izadi-Darbandi A., Mastrangelo A.M., Najafian G., Arshad Y., Mirniyam G. (2016). Association between grain size and shape and quality traits, and path analysis of thousand grain weight in Iranian bread wheat landraces from different geographic regions. *Notulae Botanicae Horti Agrobotanici Cluj-Napoca*, 44(1), 228-236.
- Đurić V., Mladenov N., Hristov N., Kondić-Špika A., Racić M. (2010). Effect of rainfalls on wheat quality in 2009 harvest season. *Field and Vegetable Crops Research*, Novi Sad, 47(1), 335-340.
- Falconer D. S. (1981). *Introduction to quantitative genetics*. Longman, London and New York.
- Grausgruber H., Oberforster M., Werteker M., Ruckenbauer P., Vollmann J. (2000). Stability of quality traits in Austrian-grown winter wheats. *Field Crops Research*, 66, 257-267.
- Hurkman W.J., Wood D.F. (2011). High temperature during grain fill alters the morphology of protein and starch deposits in the starchy endosperm cells of developing wheat (*Triticum aestivum* L.) grain. *Journal of Agricultural and Food Chemistry*, 59, 4938-4946.
- ICC (1984): Standard Method. No.106/2. Approved 1960, revised 1984. Determination of wet gluten in wheat. Vienna, Austria: International Association for Cereal Science and Technology.
- ICC (1994): Standard Method. No.116/1. Approved 1972, revised 1994. Determination of sedimentation value (Zeleny) in wheat. Vienna, Austria: International Association for Cereal Science and Technology.
- Kaya Y., Akcura M. (2014). Effects of genotype and environment on grain yield and quality traits in bread wheat (*T. aestivum* L.), *Food Science and Technology*, Campinas, 34(2), 386-393.
- Laidig F., Piepho H.P., Rentel D., Drobek T., Meyer U., Huesken A. (2017). Breeding progress, environmental variation and correlation of winter wheat yield and quality traits in German official variety trials and on-farm during 1983–2014. *Theoretical and Applied Genetics*, 130(1), 223-245.
- Li Y., Huang C., Sui X., Fan Q., Li G., Chu X. (2009). Genetic variation of wheat glutenin subunits between landraces and varieties and their contributions to wheat quality improvement in China. *Euphytica*, 169, 159-168.
- Meteorološki godišnjak-klimatološki podaci. Republički hidrometeorološki zavod, Republika Srbija. Preuzeto 29.08.2017. sa internet stranice: [http://www.hidmet.gov.rs/latin/meteorologija/klimatologija\\_godisnjaci.php](http://www.hidmet.gov.rs/latin/meteorologija/klimatologija_godisnjaci.php).
- Mladenov N., Przulj N., Hristov N., Đurić V., Milovanović M. (2001). Cultivar-by-environment interactions for wheat quality traits in semiarid conditions. *Cereal Chemistry*, 78(3), 363-367.
- Mohan D., Gupta R.J. (2015). Gluten characteristics imparting bread quality in wheats differing for high molecular weight glutenin subunits at Glu D1 locus. *Physiology and Molecular Biology of Plants*, 21(3), 447-451.
- Payne P.I., Nightingale M.A., Krattiger A.F., Holt L.M. (1987). The relationship between HMW glutenin subunit composition and the bread-making quality of British-grown wheat varieties. *Journal of the Science of Food and Agriculture*, 40, 51-65.
- Vázquez D., Berger A.G., Cuniberti M., Bainotti C., Miranda M.Z., Scheeren P.L., Jobet C., Zúñiga J., Cabrera G., Verges R., Peña R.J. (2012). Influence of cultivar and environment on quality of Latin American wheats. *Journal of Cereal Science*, 56, 196-203.

- Wieser H. (2007). Chemistry of gluten proteins. *Food Microbiology*, 24, 115-119.
- Williams R.M., O'Brien L., Eagles H.A., Solah V.A., Jayasena V. (2008). The influences of genotype, environment, and genotype  $\times$  environment interaction on wheat quality. *Australian Journal of Agricultural Research*, 59(2), 95-111.
- Zhang Y., He Z., Ye G., Zhang A., Ginkel V.M. (2004). Effect of environment and genotype on bread-making quality of spring-sown spring wheat cultivars in China. *Euphytica*, 139(1), 75-83.
- Zečević V., Knežević D., Mićanović D. (2004). Genetic correlations and path-coefficient analysis of yield and quality components in wheat (*Triticum aestivum* L.). *Genetika*, 36(1), 13-21.
- Zečević V., Knežević D., Mićanović D. (2007). Variability of technological quality components in winter wheat. *Genetika*, 39(3), 365-374.

## THE EFFECTS OF HYDROGEL AND ZEOLITE TREATMENT ON ORNAMENTAL FLOWERS TRANSPLANTS

Lazar PAVLOVIĆ, Emina MLADENOVIĆ\*, Martina ZORIĆ, Jelena ČUKANOVIĆ,  
Ksenija HIEL

Department of Fruit growing, Viticulture, Horticulture and Landscape architecture, Faculty of Agriculture,  
University of Novi Sad, Serbia

\*Corresponding author: eminam@polj.uns.ac.rs

### Abstract

This research was conducted in order to examine the influence of zeolite and hydrogel, on the growth of *Tagetes patula* var. Disco Marietta and *Salvia splendens* var. Fuego transplants. Both, zeolite and hydrogel have ability to improve physical and mechanical properties of the soil, they increase its ability to retain water and nutrients. The experiment was set in a split-plot design with a total of 100 plants for each species. Four different media were studied: plants potted in commercial substrate, plants potted in the combination of commercial substrate and zeolite (90:10), plants dipped in the solution of hydrogel and water (2gr/dm<sup>3</sup>) and then potted in commercial substrate, plants dipped in solution of hydrogel and water (2gr/dm<sup>3</sup>) and then potted in the combination of commercial substrate and zeolite (90:10). Depending of species, different parameters were observed. For *Tagetes patula* in this research the measured parameters were: the height of plants, number of formed leaves, length of formed leaves and the number of formed flowers. To examine the influence of zeolite and hydrogel on the growth of *Salvia splendens* transplants following parameters were measured: height of the plants, number of formed leaves, height of the flowering stem, number of formed flowers. The results of this research showed that the use of the combination of zeolite and hydrogel, or separately is recommended for production of these plants. The best results, for *Tagetes* were given by the transplants that were treated with the combination of zeolite and hydrogel, while the measured parameters of *Salvia* were highest if the transplants were treated with zeolite only.

**Keywords:** *Tagetes*, *Salvia*, zeolite, hydrogel, flowers

### Introduction

French marigold (*Tagetes patula* L.) and scarlet sage (*Salvia splendens* L.) are very popular decorative flowering species in urban green areas due to its beautiful colored flowers and resistance on different types of stress. These annual decorative flowering plants are mostly used in urban green areas and home gardens; they are most decorative during the summer while they are flowering. *Salvia splendens* var. „Fuego“, used for the purpose of this research is one of the most popular varieties of this species because it produces a continuous display of bright red bushy spikes during the summer, also *Tagetes patula* var. „Disco Marietta“ is becoming more popular due its highly decorative double-colored long-lasting flowers. According to Zeljković et al., (2010), growth and survival of plants in open field strongly depends on flower transplants quality, therefore it is important to examine the influence of different soil materials in order to produce quality transplants and minimize the stress during open field planting. According to Orikiran et al., (2009) water is the most important soil physical factor that affects plant growth and quantification of such growth is relevant for the understanding of the plant-water relationship. With the use of different soil amendments, it is

possible to minimize the effect of drought and to conserve and enhance soil fertility. Soil amendment is any organic or inorganic material that could be added to a soil to improve its physical properties with a goal to provide a better environment for roots growth and development (Owais et al., 2009). Zeolite is one of the natural soil amendments often used in developing new substrates for seedlings production and potted plants growing because of its positive effects on improving drainage and aeration, reducing leaching of pesticides and fertilizers from the substrate, and saving water during irrigation. It has strong sorption properties, high cation exchange capacity (CEC) and high content of micro- and macronutrients (Noori et al., 2006). The aim of this research was to determine the influence of zeolite as a natural, and hydrogel as a synthetic soil amendments on growth of French marigold (*Tagete spatula* var. „Disco Marietta“) and scarlet sage (*Salvia splendens* var. „Fuego“) transplants.

### Material and methods

This research was conducted during 2016 in greenhouse of the Faculty of Agriculture in Novi Sad, Vojvodina, Serbia. The town of Novi Sad has long tradition in landscape architecture, in production and usage of different decorative flowers in order to improve the complete look of its streets and parks. The experiment was designed by split plot method in 4 repetitions using 10 plants in control group, and 30 plants in each examined media. Seeds of *Tagetes patula* var. „Disco Marietta“ and *Salvia splendens* var. „Fuego“ were used as plant material. All seeds were sown in containers filled with Klasmann-Deilmann substrate. A substrate was the mixture of white and black peat, with pH 5.5-6.5. After reaching growth of two true leaves development plants were transplanted in PVC pots with 8 cm diameter filled with different substrates. Total number of 100 plants of each species was used, divided into 4 different groups, depending on the substrate. For each species, 10 plants in control groups (C) were potted in commercial Klasmann-Deilmann substrate „Florabella“ which is a mixture of white and black peat, with pH 5.5-6.5. Number of 30 plants for each species were planted in mixture (Z) of commercial substrate „Floribunda“ and commercial zeolite (klimoptilolit) originated from Serbian mines in a ratio 90:10. Third media, used during this research (H) was created by dipping the plants in the solution of commercial hydrogel produced by German company Evonik Stockhausen GmbH and water (2gr/dm<sup>3</sup>). After the treatment plants were potted in the commercial substrate „Floribunda“. The last examined media (ZH) was created as a combination of commercial substrate „Floribunda“, zeolite and hydrogel. First step was to create a media, mixture of zeolite and commercial substrate (90:10) as for group Z. Plants were treated with solution of water and hydrogel, as for group H, and then potted in the media. Depending of species, different parameters were observed. For *Tagetes patula* var. „Disco Marietta“ in this research measured parameters were: the height of plants, number of formed leaves, length of formed leaves and the number of formed flowers. To examine the influence of zeolite and hydrogel on the growth of *Salvia splendens* var. „Fuego“ transplants following parameters were measured: height of the plants, number of formed leaves, height of the flowering stem, number of formed flowers.



## Results and discussion

There is numerous research on positive impact of different soil amendments including zeolite as natural and hydrogel as synthetic amendment, on various plants species growth. This research was conducted in order to examine the influence of different media amendments and its combinations on vegetative growth and number of formed flowers on two popular flowering species: *Tagetes patula* var. „Disco Marietta“ and *Salvia splendens* var. „Fuego“. The results of measured parameters were observed 45 days after the treatment of transplants. Presented values are referred to average number of examined properties per plant. According to previous research on influence of zeolite on growth of French marigold (Farzad et al., 2007) zeolite decreased leaching of nitrogen, potassium, phosphorus, calcium, and magnesium due to increase in cation exchange capacity (CEC) of soil mixture. Considering that, zeolite has positive effects on vegetative growth of French marigold and ability to form flowers, which the results of this research confirm. The results shown on Graph1. indicate that in this period of time highest measured parameters were observed in the group of plants that are treated with hydrogel and then potted in mixture of commercial substrate and zeolite (Z). Average height per plant in this group was (33,4 cm) for 7,4 cm higher than the average height of plants in control group (26 cm). Average height per plant in groups treated with zeolite (30cm) and hydrogel (32,1 cm) is higher than in control group for 15,3 % and 23,4 % respectively. The average number of formed leaves per plant and its length was the lowest in control group 15,2 leaves per plant and 10,7 cm respectively, while in the group of plants treated with mix of hydrogel and zeolite the average value of number of formed leaves was 39,4per plant and its length 14,6 cm. Higher results of these parameters were observed in the other two groups in comparison with control group; plants treated with zeolite were higher for 4 cm in average per plant in comparison to a control group, and developed 19,8 more leaves in average per plant. Plants treated with hydrogel were in average higher for 6,1 cm per plant, and developed 23,4 more leaves in average per plant in comparison to control group. During the research it was observed that flowering started on all plants that were treated with these soil amendments. In this period of time none of the plants in control group formed flowers. Highest number of formed flowers were observed in the group of plants treated with combination of hydrogel and zeolite (7,5 per plant), and lowest values were observed in group of plants treated with hydrogel (6,3 per plant) and zeolite (5,4 flowers per plant).

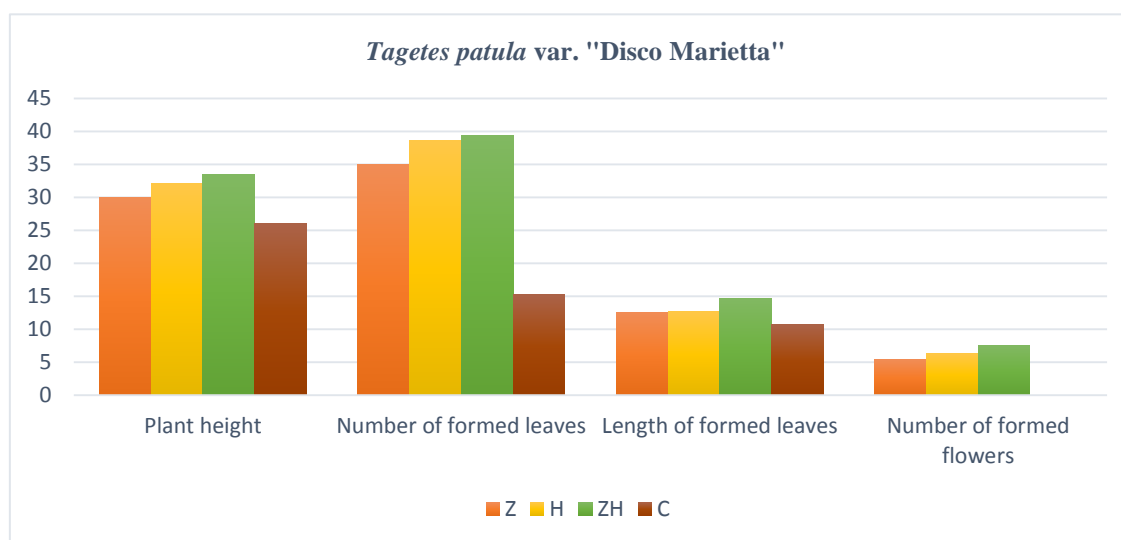


Chart 1. Results of measured parameters on *Tagetes patula* var. „Disco Marietta“

Data shown on Chart 1. represents the results of the final measurement which was conducted 45 days after the treatment of *Tagetes patula* var. “Disco Marietta” transplants. Different colors represent measured parameters: height of the plants (cm), number of formed leaves on the plants, length of formed leaves (cm) and the number of formed flowers on plants planted in different media. Orange color represents results of plants that were planted in mixture of commercial substrate and zeolite (Z), yellow color represents values of plants that were treated with hydrogel (H), green color stands for values of measured parameters of plants that were treated with hydrogel and then potted in mixture of commercial soil and zeolite (HZ), and red colors represents control (C), untreated group of plants that were potted in commercial substrate.

Hydrogel as a synthetic material used as a soil amendment, according to Akhter et al., 2004. has enormous capacity to absorb water, and make it available to plants over time, also increase in water holding capacity due to hydrogel significantly reduced the irrigation requirement of many plants. According to previous research (Ljubojević et al., 2017) hydrogel has positive growth effects on different *Salvia* species; amended hydrogel provided sufficient amount of available water and ions, also mitigated the negative influence of higher salt concentrations, thereby decreased leaf damage, defoliation and petal loss, while also improved vitality. Zeolite is being used as a soil amendment during the production of different ornamental plants, also, based on previous research zeolite used as a soil amendment has positive effect on growth of *Petunia hybrid* Juss. transplants (Zeljkojić et al., 2017). During this research, highest values of measured parameters on Scarlet sage transplants are recorded in the group of plants treated with zeolite. Compared to control group, average height per plant in this group (32cm) was for 8 cm higher than the average height per plant in control group (26 cm). Plants from other two treated groups also developed greatest height than plants in control group. Average height per plant in group treated with hydrogel (28 cm) was for 4 cm higher than in control group, and average height per plant in group of plants treated with zeolite and hydrogel (30 cm) was for 6 cm higher than in control group. The number of formed leaves per plant in control group was 7 which is lower than the other treated groups of plants. Groups of plants treated with zeolite, combination of hydrogel and zeolite and hydrogel formed 16,10 and 16 leaves in average per plant, respectively. Parameters which included observing flowers in this research were the highest on the plants that were treated with zeolite. Plants in this group formed 66 flowers on flower stem in average per plant, with the height of flower stem of 22 cm per plant. Number of formed flowers on flower stem in control group was for 11,86 % lower with average number of 59

formed flowers per plant. Average length of flower stem per plant formed in control group (15cm) was lower than in group of plants treated with hydrogel (17 cm) and group of plants treated with combination of zeolite and hydrogel (18 cm). Average number of formed flowers on flower stem per plant in groups that were treated with combination of hydrogel and zeolite and hydrogel was higher than the number of formed flowers on flower stem in control group, but lower for 6,4 % and 4,7% in comparison to the number of formed flowers on flower stem in the group of plants treated with zeolite.

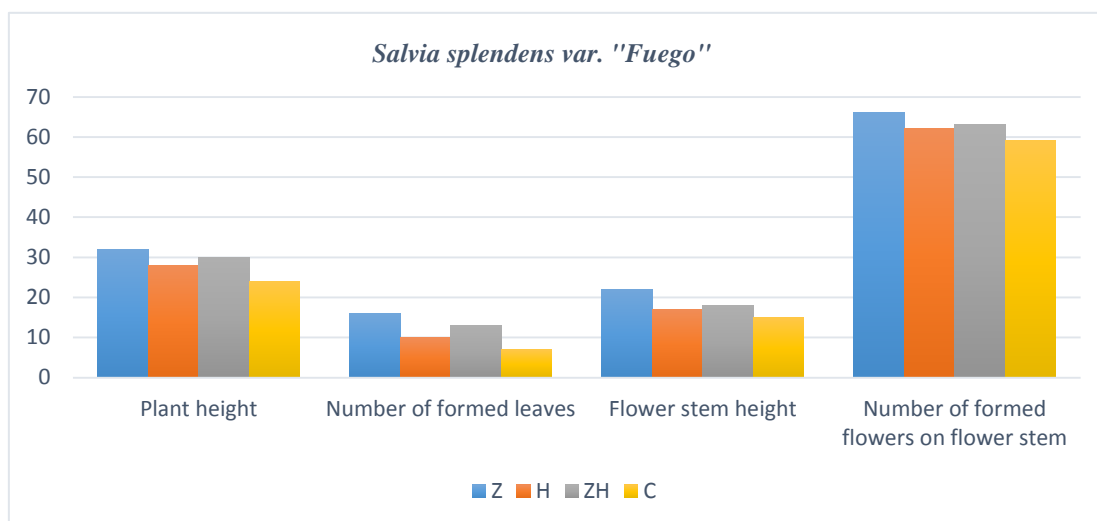


Chart 2. Results of measured parameters on *Salvia splendens* var. „Fuego“

Data shown on Chart 2. represents the results of the final measurement which was conducted 45 days after the treatment of *Salvia splendens* var. „Fuego“ transplants. Different colors represent measured parameters: height of the plants (cm), number of formed leaves on the plants, length of formed flower stems (cm) and the number of formed flowers on plants planted in different media. Blue color represents results of plants that were planted in mixture of commercial substrate and zeolite (Z), orange color represents values of plants that were treated with hydrogel (H), grey color stands for values of measured parameters of plants that were treated with hydrogel and then potted in mixture of commercial soil and zeolite (ZH), and yellow colors represents control (C), untreated group of plants that were potted in commercial substrate.

## Conclusions

Measured data, collected during this research show evidence for a positive impact of both hydrogel and zeolite, as well as the combination of these two soil amendments have on vegetative growth and forming of flowers on *Tagetes patula* var. „Disco Marietta“ and *Salvia splendens* var. „Fuego“. During this research, all of observed parameters on both species were higher in comparison to non treated plants in control group. The results show that vegetative growth of French marigold, its height, number and length of formed leaves were the highest on plants that were potted in media which was a mixture of these two soil amendments and commercial substrate. Also, this group of plants had highest number of formed flowers. Highest vegetative measured parameters, its height and number of formed leaves observed on Scarlet sage were in the group of plants which were treated with zeolite. Scarlet sage plants treated with zeolite also formed the highest number of flowers and highest flowers stem. It was concluded that both, zeolite and hydrogel had a pronounced effect on vegetative growth, flower and physiological characteristics of African marigold and Scarlet sage. It may be recommended that zeolite and hydrogel being used, as an amendment to soil of ornamental plants such as African marigold and Scarlet sage to improve vegetative growth and flowering.

### Acknowledgement

This paper is a result of project of Ministry of Science, Education and Technological Development, Republic of Serbia. Project number: III43007, Name of project: Research of climate change and their impact on the environment: monitoring the impact, adaptation and mitigation.

### References

- Akhter, J., Mahmood, K., Malik, K. A., Mardan, A., Ahmad, M., & Iqbal, M. M. (2004). Effects of hydrogel amendment on water storage of sandy loam and loam soils and seedling growth of barley, wheat and chickpea. *Plant Soil and Environment*, 50(10), 463-469.
- Farzad, N., Morteza, K. K., Saeid, E., & Hassan, S. (2007). The effects of natural zeolite on vegetative growth, flower and physiological characteristics of African marigold (*Tagetes erecta* L. 'Queen'). *Horticulture, Environment and Biotechnology*, 48(4), 241-245.
- Ljubojević, M., Ognjanov, V., Maksimović, I., Čukanović, J., Dulić, J., Szabò, Z., & Szabò, E. (2017). Effects of Hydrogel on Growth and Visual Damage of Ornamental *Salvia* Species Exposed to Salinity. *CLEAN–Soil, Air, Water*, 45(2).
- Noori, M., Zendehtel, M., & Ahmadi, A. (2006). Using natural zeolite for the improvement of soil salinity and crop yield. *Toxicological & Environmental Chemistry*, 88(1), 77-84.
- Orikiriza, L. J., Agaba, H., Tweheyo, M., Eilu, G., Kabasa, J. D., & Huttermann, A. (2009). Amending soils with hydrogels increases the biomass of nine tree species under non-water stress conditions. *Clean-Soil, Air, Water*, 37(8), 615.
- Owais, S. J., Abdel-Ghani, A. H., Ghrair, A. M., Al-Dalain, S. A., & Almajali, N. (2013). Effect of Natural Jordanian Volcanic Tuff on Growth, Irrigation Water Saving and Leaves Mineral Content of *Salvia officinalis*. *Jordan Journal of Agricultural Sciences*, 9(4).
- Savi, T., Marin, M., Boldrin, D., Incerti, G., Andri, S., & Nardini, A. (2014). Green roofs for a drier world: effects of hydrogel amendment on substrate and plant water status. *Science of the Total Environment*, 490, 467-476.
- Zeljковиć, S. B., Parađiković, N. A., Babić, T. S., Đurić, G. D., Oljača, R. M., Vinković, T., M., & Tkalec, M. B. (2010). Influence of biostimulant and substrate volume on root growth and development of scarlet sage (*Salvia splendens* L.) transplants. *Journal of Agricultural Sciences, Belgrade*, 55(1), 29-36.
- Zeljковиć, S., Šušak, U., Parađiković, N., Gidas, J. D., Tkalec, M., & Todorović, V. (2017, January). Application of zeolite in surfinia (*Petunia hybrida* Juss.) transplants production. In 52nd Croatian and 12th International Symposium on Agriculture, Dubrovnik, 290.

## EFFECT OF NITROGEN ON YIELD AND NITRATE CONTENT IN POTATO TUBERS

Ljiljana BOŠKOVIĆ-RAKOČEVIĆ\*, Goran DUGALIĆ, Nikola BOKAN, Marijana DUGALIĆ

University of Kragujevac, Faculty of Agronomy, Čačak, Serbia

\*Corresponding author: ljiljabr@kg.ac.rs

### Abstract

The production of potatoes, as a highly labor-intensive and profitable vegetable and field crop, requires fertilization, especially the use of nitrate fertilizers, as a major cultural operation. To determine the most favorable nitrogen application rate that would ensure high yields along with optimum nitrate accumulation in potato tubers, a field trial was established using different types (urea and CAN) and rates (50, 100 and 200 kgN/ha) of nitrogen fertilizers in two potato cultivars ('Lizeta' and 'Kondor'). The experiment was conducted on a leached soil under the agroenvironmental conditions of Mountain Radočelo (slopes of Mountain Golija) in Serbia. Results showed that, in both cultivars, average potato yields were higher under CAN treatment ('Lizeta' 32.511 kg/ha; 'Kondor' 32.952 kg/ha) than under urea treatment ('Lizeta' 31.877 kg/ha; 'Kondor' 29.142 kg/ha). Increasing rates of nitrogen and treatments with urea and CAN led to an increase in soil nitrate nitrogen after plant uptake, but its content was lower in all treatments than before trial establishment. Nitrate nitrogen levels in the soil were higher after urea fertilization (12.2 mg/kg) than after CAN treatment (7.6 mg/kg). Average nitrate accumulation was higher in potato tubers fertilized with CAN, particularly in 'Lizeta' ('Lizeta' 236.2 mg/kg; 'Kondor' 198.3 mg/kg), whereas the use of urea gave an average nitrate content of 208.4 mg/kg in 'Lizeta' and 174.7 mg/kg in 'Kondor'.

**Keywords:** *Potato, Nitrogen fertilizers, Yield, Nitrate content*

### Introduction

Nitrogen (N) is one of the nutrients that exert the greatest influence on plant growth and development under diverse environments (Cao and Tibbitts, 1993). It is for this reason that the use of nitrogen fertilizers has been intensified in agricultural production. Crops can utilize different N forms, the main ones being nitrate ( $\text{NO}_3^-$ ) and ammonium ( $\text{NH}_4^+$ ) ions (Coraspe-Léon et al., 2009). Also, urea is an important N source, but experimental results have indicated that uptake capability and use of different N forms ( $\text{NO}_3^-$ ,  $\text{NH}_4^+$  or urea) vary depending on the plant species, developmental stage, soil pH, temperature, light intensity and root carbohydrate content (Cao and Tibbitts, 1993; Tan et al., 2000; Lea and Azevedo, 2007). Moreover, as different forms of nitrogen cause an uneven uptake and accumulation of harmful nitrates by crops, it is essential to properly determine the amount of nitrogen required to achieve high yields of good quality crops, particularly in view of the increasing importance given to nitrate content as a quality parameter of vegetables. Given that vegetable consumption accounts for the highest daily dietary intake of nitrates (about 72-94%, European Commission), and considering the important role of potatoes in the amount of vegetables consumed, some European Union countries have recommended limits for nitrate levels in tubers used in the human diet. In Germany, the maximum allowable nitrate concentration in tubers should not exceed 200 mg/kg; in Poland, nitrate limits are set at 183 mg/kg (Cieslik and Sikora, 1998).

Previous research on the effect of different forms and rates of nitrogen on crop yield and nitrate uptake in different plant species has shown that nitrate accumulation in edible organs is directly dependent on the type of nitrogen fertilizer applied (Gunes et al., 1995; Pavlou et al., 2007). The lowest nitrate accumulation was found under treatment with urea, followed by ammoniacal nitrogen, and the highest under nitrate nitrogen (Inal and Tarakcioglu, 2001; Abu-Rayyan et al., 2004; Silva et al., 2013). Nitrate content in potato tubers was about four times lower under ammoniacal nitrogen than after treatment with the nitrate form of nitrogen (Seria et al., 2004). Potato yield was highest after urea treatment, which gave a tuber nitrate content of 207.8 mg/kg (Drápal et al., 2013). Given the economic importance and nutritional value of potatoes and their high proportion in the human diet, this study focused on examining the effect of different nitrogen forms and rates, and cultivars on yield and nitrate accumulation in edible parts.

### **Material and methods**

The effect of different types and rates of nitrogen fertilizers (CAN and urea) on tuber yield and nitrate accumulation in tubers of two potatoes cultivars ('Liseta' and 'Kondor') was examined in 2015. The experiment was laid out in a randomized block design with three replications at the village of Bzovik, Municipality of Kraljevo (Latitude 43° 25' 33" N, Longitude 20° 25' 53" E; 1107 m altitude), on a luvisol of the Mountain Radočelo massif.

Fertilization treatments included: T1 – (unfertilized) control; T2 –50 kgN/ha using CAN; T3–100 kgN/ha using CAN; T4–200 kgN/ha using CAN; T5–50 kgN/ha using urea; T6–100 kgN/ha using urea; T7–200 kgN/ha using urea. Potatoes were planted on 30 April 2015 at a spacing of 70 x 25 cm, and harvested on 28 September 2015.

Before trial establishment, soil samples were collected from a depth of 30 cm for the following analyses: soil pH was measured at a 1:2.5 ratio of soil to distilled water and 1M KCl; humus content was determined by oxidation with KMnO<sub>4</sub> solution (according to Kotzman); total nitrogen was estimated by Kjeldahl analysis (Gerhardt Vapodest); nitrate nitrogen content in the saline extract; available phosphorus and potassium were evaluated by extraction with 0.1M NH<sub>4</sub>-lactate and 0.4M CH<sub>3</sub>COOH, according to Egner-Riehm (P was analyzed spectrophotometrically by the phospho-vanadate colorimetric method and K was determined by flame photometry); available Al was measured by Sokolov's method.

After harvest, potato tubers were sampled and analyzed for nitrate content by Kjeldahl's micromethod.

All data in the present study were subjected to analysis of variance (ANOVA), and means were separated by LSD test at  $P \leq 0.05$  using the MSTAT-C statistical computer package (Michigan State University, East Lansing, MI, USA).

### **Results and discussion**

Soil along with its physical and chemical properties is an important prerequisite for crop production. The results of agrochemical testing (Table 1) showed an acid reaction of the soil, indicating the necessity for soil amendment practices such as liming and humification in further potato production as the coefficient of nutrient use efficiency in such soils is lower than in less acidic soils richer in organic matter (Bošković-Rakočević and Bokan, 2003). Regardless of the strongly acid reaction of this soil, mobile aluminum content (3.38 mg/100 g soil) was within the limits tolerable to plants (Jakovljević et al., 1991). This was of high importance, given the particularly deleterious effect of excess mobile aluminum in the arable layer, as evidenced by the decrease in root penetration depth and, hence, reduction in the uptake of nutrients and water from the soil (Foy, 1974). Total nitrogen, available phosphorus and available potassium

levels were high, whereas the concentration of nitrate nitrogen was optimal, suggesting the suitability of this soil for potato production.

Table 1. Agrochemical characteristics of the soil

Depth (cm)	pH/H <sub>2</sub> O	pH/KCl	Humus (%)	N (%)	NO <sub>3</sub> -N (mg/kg)	Al	P <sub>2</sub> O <sub>5</sub>	K <sub>2</sub> O
						mg/100 g		
0-30	4.75	3.80	3.1	0.21	19.8	3.38	23.3	47.3

After the experiment and upon potato harvest, soil analyses revealed significant changes in nitrate nitrogen content (Table 2), which was lower in all treatments than before trial establishment (19.8 mg/kg). As indicated by its low levels in the soil, the nitrate nitrogen applied through fertilization was uptaken by plants, and the amount of nitrate nitrogen remaining in the soil after CAN treatment was significantly lower than after urea treatment. This was an expected finding considering the long period of time taken for urea as an amide fertilizer to transform in the soil. Increasing rates of both fertilizers led to an increase in the level of nitrate nitrogen remaining in the soil after plant uptake, but all values were below the maximum level tolerable by vegetable crops (<50 mg/kg). Similar conclusions in a study on lettuce were drawn by Bošković-Rakočević et al. (2009). Cultivars showed no significant differences in soil nitrate nitrogen content.

Table 2. Nitrate content in the soil and potato tubers (mg/kg)

Treatment	NO <sub>3</sub> -N in the soil		NO <sub>3</sub> -N in potato tubers	
	‘Liseta’	‘Kondor’	‘Liseta’	‘Kondor’
Control	3.5	3.5	52.0	58.0
50 kgN/ha KAN	5.3	7.0	117.4	109.2
100 kgN/ha KAN	6.4	8.0	198.5	190.7
200 kgN/ha KAN	10.5	8.8	392.7	295.0
<i>Average</i>	<i>7.4</i>	<i>7.9</i>	<i>236.2</i>	<i>198.3</i>
50 kgN/ha Urea	8.6	7.0	105.6	88.5
100 kgN/ha Urea	10.8	12.4	180.9	174.3
200 kgN/ha Urea	17.5	17.0	338.7	261.3
<i>Average</i>	<i>12.3</i>	<i>12.1</i>	<i>208.4</i>	<i>174.7</i>

0.05  
LSD

0.9474

18.9924

0.01

1.2782

25.6230

Soil nitrogen content is the most important external factor affecting nitrogen accumulation in plants. As the soil in this study had optimal nitrate levels, nitrate concentration in potato tubers, particularly at the highest nitrogen application rate, was above the average for this crop (below 200 mg/kg) (Corré and Breimer, 1979). The lowest nitrate content in potato tubers was recorded in the control treatment, in both cultivars (‘Liseta’ 52.0 mg/kg; ‘Kondor’ 58.0 mg/kg), and the highest at an application rate of 200 kgN/ha, using both nitrogen fertilizers. As shown by the results given in Table 2, the increasing nitrogen rates led to an increase in the nitrate content of potato tubers, and nitrogen rates up to 100 kg/ha posed no risk of increased nitrate accumulation in edible parts of potatoes, which was consistent with the findings of Đurovka et al. (1992). After urea treatment, potato tubers accumulated significantly lower levels of nitrate than after

CAN treatment, which complied with the results of Inal and Tarakcioglu (2001) and Silva et al. (2013), who also determined the lowest nitrate accumulation after urea treatment.

The analysis of the effect of cultivar on the nitrate content of potato tubers showed that 'Liseta' accumulated significantly higher amounts of nitrate after both urea and CAN treatments, compared to 'Kondor', as previously reported by Bošković-Rakočević and Pavlović (2009). The average nitrate content after CAN treatment was 236.2 mg/kg in 'Liseta' tubers and 198.3 mg/kg in 'Kondor' potatoes. A similar tendency was observed after urea treatment ('Liseta' 208.4 mg/kg, 'Kondor' 174.7 mg/kg). These results indicate that 'Kondor' has better genetic tolerance to nitrate accumulation, as previously found by Joern et al. (1995), who studied genotypic differences in potato nitrogen requirements and highlighted the importance of nitrogen fertilizer optimization as the main factor in improving potato tuber yield and quality.

In addition to the proper choice of cultivar, proper mineral nutrition adapted to soil fertility conditions is an important parameter in obtaining high yields. As the soil in this study had a good supply of nutrients and as the tested factors included different potato cultivars and nitrogen forms and rates, the different yields produced were due to the interactive effects of these factors (Table 3).

Table 3. Yield of potato cultivars 'Liseta' and 'Kondor'(kg/ha)

Treatment	'Liseta'		'Kondor'	
	Yield	Index	Yield	Index
Control	26,857	100	21,428	100
50 kgN/ha KAN	31,428	117.0	31,428	146.7
100 kgN/ha KAN	30,285	112.8	29,714	138.7
200 kgN/ha KAN	36,000	134.0	37,715	176.0
<i>Average</i>	<i>32,571</i>		<i>32,952</i>	
50 kgN/ha Urea	29,864	111.2	26,285	122.7
100 kgN/ha Urea	31,482	117.2	29,142	136.0
200 kgN/ha Urea	34,286	127.7	32,000	149.3
<i>Average</i>	<i>31,877</i>		<i>29,142</i>	

The lowest average potato yield in both cultivars was obtained in the control ('Liseta' 26,857 kg/ha, 'Kondor' 21,428 kg/ha). Increasing nitrogen rates for both types of nitrogen fertilizer resulted in an increase in potato yield, particularly in 'Kondor'. Specifically, the nitrogen rate of 200 kgN/ha applied through CAN increased potato yield in 'Kondor' by 76.0%, as opposed to the 34.0% increase in 'Liseta'. Similarly, under urea treatment, at the highest nitrogen application rate, potato yield increased by 49.3% in 'Kondor', and by 27.7% in 'Liseta'. The average potato yields, as dependent on the nitrogen application rate, indicated that yield was substantially affected by mineral nutrition (Drápal et al., 2013; Silva et al., 2013). Table 4 shows the effect of cultivar, fertilization and the cultivar x fertilization interaction on potato yield, nitrate content in the soil and nitrate content in potato tubers. The results of ANOVA indicated very significant effects of cultivar, fertilization and the cultivar x fertilization interaction on all tested parameters, except the effect of cultivar on soil nitrate content.



Table 4 - Analysis of variance of the tested parameters (ANOVA)

Effect of cultivar on the traits analyzed				
Traits	Mean sqr. Effect	Mean sqr. Error	F	p-level
Potato yield	3.342859	3.342859	10.92**	0.002609
NO <sub>3</sub> -N in the soil	0.259	0.259	0.81 <sup>ns</sup>	0.376766
NO <sub>3</sub> -N in potato tubers	12220	12220	94.47**	0.000000
Effect of fertilization on the traits analyzed				
Traits	Mean sqr. Effect	Mean sqr. Error	F	p-level
Potato yield	5.689278	9.482130	30.98**	0.000000
NO <sub>3</sub> -N in the soil	709.766	118.294	368.03**	0.000000
NO <sub>3</sub> -N in potato tubers	388236	64706	500.26**	0.000000
Effect of cultivar x fertilization on the traits analyzed				
Potato yield	5.094932	8.491554	2.77*	0.030318
NO <sub>3</sub> -N in the soil	20.306	3.384	10.53**	0.000004
NO <sub>3</sub> -N in potato tubers	12644	2107	16.29**	0.000000

### Conclusions

The study on different potato cultivars fertilized by different forms and rates of nitrogen suggested the following:

Increasing rates of nitrogen and treatments with urea and CAN led to an increase in soil nitrate nitrogen after plant uptake, but its content was lower in all treatments than before trial establishment.

The lowest nitrate content in potato tubers was recorded in the control treatment, in both cultivars, and the highest at an application rate of 200 kgN/ha, using both nitrogen fertilizers. After urea treatment, potato tubers accumulated significantly lower levels of nitrate than after CAN treatment, with 'Liseta' accumulating significantly higher amounts of nitrate compared to 'Kondor'. Nitrogen fertilization rates up to 100 kg/ha posed no risk of increased nitrate accumulation in potato tubers, whereas the rate of 200 kgN/ha resulted in the nitrate content of tubers higher than the average for this crop.

The average potato yields showed that mineral nutrition had a significant effect on yield.

### Acknowledgments

This study is part of TR 31059, 31024 and 31054 projects financially supported by the Ministry of Education and Science of the Republic of Serbia.

### References

- Abu-Rayyan, A., Kharawish, B.H., Al-Ismaïl, K. (2004): Nitrate content in lettuce (*Lactuca sativa* L.) heads in relation to plant spacing, nitrogen form and irrigation level. *J. Sci. Food Agr.*, 84(9), 931-936.
- Bošković-Rakočević, Lj., Bokan, N. (2003): Gajenje krompira na zemljištu sa visokim sadržajem mobilnog aluminijuma (Potato cultivation on land with high content of mobile aluminum). *Agroznanje*, 4, 152-160.

- Bošković-Rakočević, Lj., Pavlović, R., Stevanović, D., Vukelić, N. (2009): The nitrate content in lettuce leaves depending on the type and the application rate of nitrogen fertilizers. *J. Sci. Agric. Res.*, 70(252), 69-76.
- Bošković-Rakočević, Lj., Pavlović, R. (2009): Effect of nitrogen on the yield and nitrate content of early potato grown under greenhouse conditions. *Acta Agr. Serbica*, 14(27), 93-99.
- Cao, W., Tibbitts., T.W. (1993): Study of various  $\text{NH}_4^+/\text{NO}_3^-$  mixture for enhancing growth of potatoes. *J. Plant Nutrit.*, 16, 1691-1704.
- Cieslik, E., Sikora, E. (1998): Correlation between the levels of nitrates and nitrites and the contents of potassium, calcium and magnesium in potato tubers. *Food Chem.*, 63, 525-528.
- Coraspe-León, H.M., Muraoka, T., Franzini, V.L., Espinal, F.S.C., Trivelin, P.C.O. (2009): Absorción de formas de nitrógeno amoniacal y nítrica por plantas de papa en la producción de tubérculo semilla. *Agronomía Tropical*, 59, 45-58.
- Corré, W.J., Breimer, T. (1979): Nitrate and nitrite in vegetables. Center for Agricultural Publishing and Documentation, Wageningen.
- Drápal, K., Jůzl, M., Elzner, P., Mareček, V. (2013): The effect of urea with urease inhibitors and urea on yield and nitrate content in potato tubers. *Acta Univ. Agric. Silv. Mendeliana Brun.*, 61, 1613-1619.
- Đurovka, M., Ilin, Ž., Marković, V., Seferović, S. (1992): Sadržaj nitrata ( $\text{NO}_3$ ) i nitrita ( $\text{NO}_2$ ) kod mladog krompira u zavisnosti od đubrenja (The content of nitrate ( $\text{NO}_3$ ) and nitrite ( $\text{NO}_2$ ) in young potatoes, depending on fertilization). *Savremena poljoprivreda*, 40 (1-2), 220-223.
- Foy, C.D. (1974): Aluminum Toxicity in Plants. *Agron. J.*, 66, 715-719.
- Gunes, A., Post, W.H.K., Aktas, M. (1995): Effect of partial replacement of nitrate by  $\text{NH}_4\text{-N}$ , urea-N and amino-N in nutrient solution on nitrate accumulation in lettuce (*Lactuca sativa* L.). *Agrochimica*, 39, 326-333.
- Inal, A., Tarakcioglu, C. (2001): Effect of nitrogen form on growth, nitrate accumulation, membrane permeability and nitrogen use efficiency of hidroponically growth bunch union order boron deficiency and toxicity. *J. Plant Nutrit.*, 24(10), 1521-1534.
- Jakovljević, M., Mišović, M., Bročić, Z. (1991): Uticaj primene organskih i mineralnih đubriva na hemijska i biološka svojstva pseudogleja (Effect of organic and mineral fertilizers on the chemical and biological properties of pseudogley). *Zbornik radova Poljoprivrednog fakulteta Beograd*, 36(596): 171-180.
- Joern, B.C., Vitosh, M.L. (1995): Influence of applied nitrogen on potato. 1. Yield, quality and nitrogen uptake. *Am. Potato J.*, 72, 51-63.
- Lea, P.J., Azevedo., R.A. (2007): Nitrogen use efficiency. 2: aminoacid metabolism. *Annals of Applied Biology*, 151, 269-275.
- Pavlou, G.C., Ehaliotis, C.D., Kavvadias, V.A. (2007): Effect of organic and inorganic fertilizers applied during successive crop seasons on growth and nitrate accumulation in lettuce. *Sci. Hort.*, 111, 319-325.
- Serio, F., Elia, A., Signore, A., Santamaria, P. (2004): Influence of nitrogen form on yield and nitrate content of subirrigated early potato. *J. Sci. Food Agr.*, 84(11), 1428-1432.
- Silva, J. G., França, M.G.C., Gomide, F.T.F., Magalhaes, J. R. (2013): Different Nitrogen Sources Affect Biomass Partitioning and Quality of Potato Production in a Hydroponic System. *Am. J. Potato Res.*, 90, 179-185.
- Tan, X.W., Ikeda, T., Oda, M. (2000): Effects of nickel concentration in the nutrient solution on the nitrogen assimilation and growth of tomato seedlings in hydroponic culture supplied with urea or nitrate as the sole nitrogen source. *Sci. Hort.*, 84, 265-273.

## THE NUMBER OF *AZOTOBACTER* SP. DEPENDING ON SOIL TYPE AND AZOTE QUANTITY UNDER "UGAR" AND SOWN CORN

Ljubica ŠARČEVIĆ - TODOSIJEVIĆ<sup>1</sup>\*, Ljubiša ŽIVANOVIĆ<sup>2</sup>, Jelena GOLIJAN<sup>2</sup>

<sup>1</sup>High Medical - sanitary School of Professional Studies "Visan", Belgrade, Serbia

<sup>2</sup>University of Belgrade, Faculty of Agriculture, Belgrade, Serbia

\*Corresponding author: ljsarcevic@gmail.com

### Abstract

The entire quantity of microorganisms and some of their ecophysiological groups represent the most significant factor of soil fertility under the sown growing plants.

In this research, we have determined the number of *Azotobacter* sp., the group of free azotofixators depending on the soil type, the manner of the soil cultivation and the quantity of the applied N fertilizer. Sowing of the soil samples from which *Azotobacter* sp. was isolated, had been done on the selective fertile Fjodor ground. We estimated the influence of two soil types, "cernozem" and "gajnjaca", on the quantity of *Azotobacter* sp. The microfield observation of the "cernozem" soil type was set on the location of Zemun Polje (Serbia) while the microfield observation of the soil type "gajnjaca" was set on the location of Rača Kragujevačka. The quantity was estimated on "ugar" and under the sown corn. We studied the growing quantities of azote fertilizers, N<sub>30</sub>, N<sub>60</sub>, N<sub>120</sub>, N<sub>180</sub> kg ha<sup>-1</sup>, on the quantity of *Azotobacter* sp. The control was with no fertilizer. The quantity of *Azotobacter* sp. showed the depending result on the soil type, the manner of the soil cultivation and the applied fertilizer quantity. The high quantity of the applied azote fertilizer had an inhibitory influence on the number of this group of microorganisms.

**Keywords:** *microorganisms, Azotobacter, soil, azote, corn.*

### Introduction

Soil is a very dynamic environment and a basic substratum for growing plants. Microorganisms are a living part of soil and a biological azotofixation is one of the most important processes that they take part in (Govedarica et al., 1997). Although symbiotic azotofixation has a special place in a fixation of atmospheric nitrogen, free azotofixators are also significant for agroecosystems. Free azotofixators make a high proportion in soil (Najdenovska, 2001). They obtain different organic compounds out of the root secretions of plants which they use as energetic source for their metabolism. As a result, their concentration in rhizosphere is higher. *Azotobacter* sp. is usually found in surface soil layers and it is mainly proportioned in rhizosphere of plants. The number and activity of free azotofixators depend on great number of factors (Kiss et al., 1978). The entire number of bacteria as well as free azotofixators varies, depending on a soil type and profile depth. The greatest number in all soil types is in their surface Ah horizon, in 0-10 centimeters, while their number decreases with the depth growing (Cvijanović, 2002). *Azotobacter* was found in all subtypes of "cernozem". "Gajnjaca" can be very abundant or reduced in *Azotobacter*, which is caused by heterogeneity that appears in the processes of genesis (Vojinović, 1956). The important factor that affects the entire number of microorganisms and their ecophysiological groups is the applied fertilizer. High quantities of the applied NPK fertilizer decreases the contents of organic substance in soil (Asmus, 1980; Popović, 2010; Tabaković, et al., 2015).

There is a concerned dependence of the influence of the applied mineral fertilizers on the number and activity of soil microorganisms (Đorđević, 1998). High quantities of the applied mineral fertilizers have an inhibitory influence on both, the entire number of microorganisms and azotobacters as well as on general soil biogenesis (Glamočlija et al., 2016). In this work, the number of *Azotobacter* sp. is determined depending on soil type and the quantity of applied nitrogen fertilizer under "ugar" and sown maize.

### Material and methods

The research of the influence of the soil type and quantity of nitrogen on the number of *Azotobacter* sp. is carried out in two areas: Eastern Srem (The Institute for maize "Zemun Polje") and Central Šumadija (Rača Kragujevačka) in Serbia during 2013. year. Microfield testings are done by method of split plots in four repetitions. The research included the three following factors:

1. Soil type (A)
  - A<sub>1</sub> – "cernozem" (Zemun Polje)
  - A<sub>2</sub> – "gajnjaca" (Rača Kragujevačka)
2. Quantity of nitrogen (B)
  - B<sub>1</sub> – Control (without fertilizer)
  - B<sub>2</sub> – P<sub>90</sub> K<sub>60</sub> N<sub>30</sub> kg ha<sup>-1</sup> (basis, phon)
  - B<sub>3</sub> – P<sub>90</sub> K<sub>60</sub> N<sub>60</sub> kg ha<sup>-1</sup>
  - B<sub>4</sub> – P<sub>90</sub> K<sub>60</sub> N<sub>120</sub> kg ha<sup>-1</sup>
  - B<sub>5</sub> – P<sub>90</sub> K<sub>60</sub> N<sub>180</sub> kg ha<sup>-1</sup>
3. The manner of using soil (C)
  - C<sub>1</sub> – "ugar"
  - C<sub>2</sub> – under crop

The applied agrotechnique during the observations was standard, as the same as for regular maize production. During the realization of this project, the following methods are used:

- method of field observation,
- analysis of meteorological conditions during the observational period,
- laboratory analysis of the chemical features of soil.

The variation of the income of grown plants and the number of soil microorganisms can be observed in great measure as a consequence of weather conditions. For undisturbed growth and development of maize, as well as for proliferation of microorganisms, there is a requirement for convenient meteorological conditions, above all, average air temperatures and good regime of rainfall during the time of researching.

Eastern Srem is settled in the area of medium continental climate, between two big rivers, the Danube and the Sava with which it borders in the north, east and south. This area is specified by average annual temperature of 11.9<sup>0</sup>C and the quantity of rainfall is to be 638.3 mm. Winters are with approximate temperatures of 1.6<sup>0</sup>C and rainfall of 113.4 mm. Springs can be slightly colder (12.1<sup>0</sup>C) than autumns (12.4<sup>0</sup>C), but with a higher quantity of rainfall (159.0 mm in relation to 152.1 mm). Average summer temperatures are 21.4<sup>0</sup>C and rainfall of 213.8 mm. A microfield testing station was set in Zemun Polje, on 88 meters altitude.

The area of Rača Kragujevačka encloses the basin of the samenamed river which lies between the basin of the Jasenica in the north and the basin of Lepenica in the south and it belongs to Šumadija lowlands (Milojević, 1954). The climate of Rača is medium continental. The average annual temperature, according to the meteorological station recordings in Kragujevac, is 11.2<sup>0</sup>C and the average annual rainfall is 617 mm. The period with temperatures above 10<sup>0</sup>C lasts for 206 days (4. IV- 27. X), and the average sum of effective temperatures is about 1.451<sup>0</sup>C. (Živković and Kostoski, 2000). In geomorphological respect, Rača Kragujevačka

represents the integral part of Šumadija lowlands relief. Field microtesting is conducted on 193 meters altitude. The number of *Azotobacter* sp. depending on mentioned factors, is examined on different soil types; "cernozem" (subtype carbon cernozem) and "gajnjaca" (entric cambisol). Chemical features of "cernozem" are dependant on its abundance in humus and mineral clay as well as in lime and absorbed calcium ( $\text{Ca}^{++}$ ). The quantity of humus in "cernozem" can vary considerably, and its quantity in our "cernozem" is 2.5 to 6%.

Table 1. Chemical features of carbon "cernozem" (Zemun Polje)

Depth (cm)	pH		Humus (%)	Nitrogen (%)	C/N	CaCO <sub>3</sub> (%)	mg /100 g	
	H <sub>2</sub> O	n/1KCl					P <sub>2</sub> O <sub>5</sub>	K <sub>2</sub> O
0 - 30	7.71	7.34	2.86	0.19	8.6:1	4.40	25.40	22.20
30 - 60	7.81	7.48	2.47	0.17	8.6:1	11.60	17.10	18.40
60 - 90	7.87	7.66	1.11	0.08	8.4:1	24.10	2.70	7.00

On the basis of the chemical analysis results (table 1), which are performed in the agrochemical laboratory of The Faculty of Agriculture in Zemun, it can be said that the reaction of the soil mixture was mild alcal. There is medium humus and nitrogen concentration present in this type of soil and easily accessible phosphore and kalium are highly proportioned. The proportion of carbonates rises as a depth of a profile grows. As a climately adjust soil, "gajnjaca" is created in all elements of relief, so it is formed in plains, loess plateaus, river basins as well as on hilly relief of Šumadija. Biological activity of "gajnjaca" is significant. It influences fast humus decomposing in field soil. Chemical features of soil on a tested field are shown in table 2.

Table 2. Chemical features of "gajnjaca" (Rača, Miraševac)

Depth (cm)	pH		Humus (%)	Nitrogen (%)	C/N	CaCO <sub>3</sub> (%)	mg/100 g	
	H <sub>2</sub> O	n/1KCl					P <sub>2</sub> O <sub>5</sub>	K <sub>2</sub> O
0 - 30	6.40	5.58	2.73	0.16	9.8:1	0.00	4.30	18.90
30 - 60	6.51	5.71	2.00	0.12	9.6:1	0.00	0.60	17.80
60 - 90	6.53	5.74	1.56	0.10	9.0:1	0.00	0.70	20.00

According to the results of the chemical analysis (table 2), conducted in the agrochemical laboratory of the Faculty of Agriculture in Zemun, it can be said that the reaction of soil mixture was acidly mild. The proportion of humus and nitrogen concentration was medium. On the basis of easily accessible phosphore contents, which is obtained by Al- method, its supply was low, while easily accessible kalium, taken by the same method, had a medium proportion. The presence of carbonates in a layer from 0 to 90 centimeters wasn't confirmed. The soil samples for microbiological analysis are taken on the depth from 0 to 30 centimeters. The number of microorganisms is determined by a standard indirect method of sowing diluted samples on selective nutritious substrata, which were afterwards incubated on the temperature of 28<sup>0</sup>C. The number of *Azotobacter* sp. in the soil is determined by the method of fertile drops on nutritious substratum of Fjodorov (10<sup>2</sup>g<sup>-1</sup>).

Table 3. Chemical composition of nutritional substratum of Fjodorov

<b>K<sub>2</sub>HPO<sub>4</sub></b>	0.3 g
<b>CaHPO<sub>4</sub></b>	0.2 g
<b>MgSO<sub>4</sub></b>	0.3 g
<b>K<sub>2</sub>SO<sub>4</sub></b>	0.2 g
<b>NaCl</b>	0.5 g
<b>FeCl</b>	0.1 g
<b>CaCO<sub>3</sub></b>	5.0 g
<b>Mixture of microelements</b>	1.0 ml
<b>Saccharose</b>	20.0 g

Agar	16.0 g
Distilled water	1000 ml

The number is expressed in grammes of completely dry soil. The results of the research were analysed by descriptive statistics method.

### Results and discussion

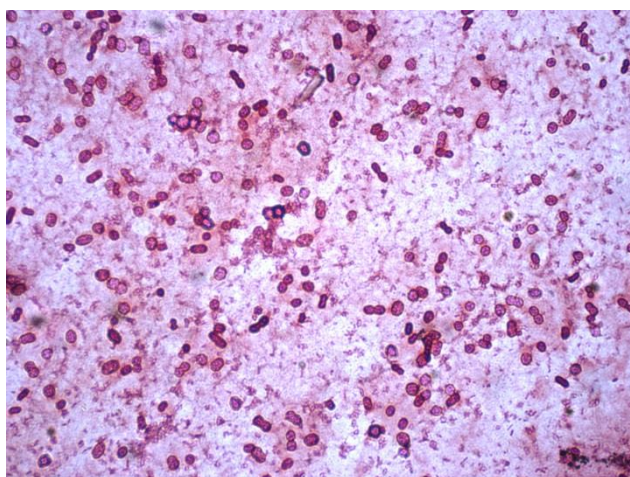
*Azotobacter* sp. belongs to a group of free azotofixators, the group of microorganisms that adopt elementary nitrogen and changes into amoniac form and then turn into organic one. The number of *Azotobacter* sp. is in significant and very significant correlative connection with the entire number of microorganisms (Šarčević, Ljubica, 2010). The number of *Azotobacter* sp. in "cernozem" was from  $100.4 - 182.7 \times 10^2 \text{g}^{-1}$  and its number in "gajnjava" was  $45.7 - 119.2 \times 10^2 \text{g}^{-1}$ . The variable analysis confirmed the influence of all examined factors and their interactions on the number of *Azotobacter* sp. (table 4).

Table 4. The influence of soil type, quantity of nitrogen and the manner of using soil on the number of *Azotobacter* sp. ( $10^2 \text{g}^{-1}$ )

Soil type (A)	Quantity of nitrogen (B)	The manner of using soil (C)		Average AB	Index (%)		
		"Ugar"	"Under crop"				
"Cernozem"	Control	126.1	145.4	135.8	111.8		
	PKN <sub>phon</sub>	115.7	127.3	121.5	100.0		
	PKN <sub>60</sub>	182.7	102.7	142.7	117.4		
	PKN <sub>120</sub>	121.8	135.2	128.5	105.8		
	PKN <sub>180</sub>	112.3	100.4	106.4	87.6		
	Average AC	131.7	122.2	127.0	-		
	Index (%)	100.0	92.8	-	100.0		
"Gajnjava"	Control	125.7	130.3	128.0	145.5		
	PKN <sub>phon</sub>	119.2	56.8	88.0	100.0		
	PKN <sub>60</sub>	89.9	45.7	67.8	77.0		
	PKN <sub>120</sub>	90.3	103.7	97.0	110.2		
	PKN <sub>180</sub>	110.2	117.4	113.8	129.3		
	Average AC	107.1	90.8	98.9	-		
	Index (%)	100.0	84.8	-	77.9		
Average BC	Control	125.9	137.9	131.9	125.9		
	PKN <sub>phon</sub>	117.5	92.1	104.8	100.0		
	PKN <sub>60</sub>	136.3	74.2	105.3	100.5		
	PKN <sub>120</sub>	106.1	119.5	112.8	107.6		
	PKN <sub>180</sub>	111.3	108.9	110.1	105.1		
Average C	119.4	106.5	113.1	-			
Index (%)	100.0	89.2	-	-			
LSD	A	B	C	AB	AC	BC	ABC
0.05	16.54	18.91	29.05	33.21	42.87	44.98	59.28
0.01	19.39	24.32	35.12	50.31	57.01	56.30	69.13

The soil type influenced in great measure the number of *Azotobacter* sp. There was a higher number of *Azotobacter* sp. in "cernozem" than in "gajnjaca". This phenomenon can be explained by the fact that "cernozem" is a type of soil with significant biogenesis, weak alcal reaction of soil mixture, easily accessible phosphore and very rich in kalium which has been proved by the results of chemical analyses (table 1).

The applied quantity of nitrogen had remarkably good impact on the number of *Azotobacter* sp. All of the applied quantities of nitrogen caused a significant and very significant decrease of the number of *Azotobacter* sp. in relation to the control.



Picture 1. *Azotobacter* sp. isolated from the samples of "cernozem" on nutritious substratum of Fjodorov

The process of nitrogen reduction consists of a series of biochemical reactions, which are catalyzed by the enzyme of nitrogenase and it is highly sensitive on molecular nitrogen. Molecular nitrogen is a powerful recipient of hydrogen and it suppresses the creation of reduced nitrogen products (Đukić and Jemcević, 2000). The majority of researches (Epanchinov, 1975; Đorđević, 1998; Hajnal-Jafari, 2010; Šarčević, Ljubica, 2010) showed that the number of *Azotobacter* sp. increases only after the applying of  $N_{30}$  and  $N_{60}$   $kg\ ha^{-1}$ , whereas high quantities of the applied nitrogen ( $N_{90}$  and  $N_{120}$   $kg\ ha^{-1}$ ) decreases very significantly the number of *Azotobacter* sp. in relation to the control in soil under sown maize. These researches confirmed this noticed pattern.

The variable analysis confirmed that the way of using soil ("ugar" or "under crop") had a significant effect on the number of *Azotobacter* sp. The number of *Azotobacter* sp. under "ugar" was higher than under sown maize. Considering the fact that "ugar" is soil without herbal tillage, the noticed pattern can be explained by the absence of competitive connections of *Azotobacter* sp. with herbal roots.

### Conclusion

The number of *Azotobacter* sp. in "cernozem" was between  $100.4 - 182.7 \times 10^2 g^{-1}$ , and in "gajnjaca"  $45.7 - 119.2 \times 10^2 g^{-1}$ . The variable analysis confirmed a significant influence of all examined factors and their interactions on the number of *Azotobacter* sp.

The number of *Azotobacter* sp. in "cernozem" was considerably higher than in "gajnjaca".

All the applied quantities of nitrogen caused a significant and a very significant decrease of the number of *Azotobacter* sp. in relation to the control.

The number of *Azotobacter* sp. under "ugar" was higher than under sown maize.

The more expressive number of free azotofixators in "cernozem", which correlates with a general biogenesis, apart from the abundance in humus and mineral substances, proves itself as a notable factor which provides soil fertility.

### References

- Asmus, F. (1980). Effect of organic manure on crop yield and organic wather content of sundy. Soil studies about humus. VIIth Inter. Sym. 14 - 16, Prague.
- Cvijanović, G. (2002). The influence of diazotrophs on the income and microbiological activity in soil under sown maize, wheat and soya, PhD thesis, The Faculty of Agriculture, Novi Sad.
- Dorđević, S. (1998). Phosphomonoesterase activity of soil under sown maize, PhD thesis, The Faculty of Agriculture, Novi Sad.
- Đukić, D., Jemcev, V. (2000). Microbiology, Military publishing department, Military book, Belgrade.
- Epanchinov, A. (1975). Effect of mineral fertilizers on the microflora of corn roots. Prikl. Bikhim. Mikrobiol., Russian, 258 - 263.
- Glamočlija, Đ., Janković, S., Popović, V., Kuzevski, J., Filipović, V., Ugrenović, V. (2015). Alternative agricultural plants in conventional and organic system of cultivation, Monography, IPN Belgrade, ISBN 978-86-81689-32-5; 1-355. p. 201-212.
- Govedarica, M., Milošević, N., Jarak, M. (1997). Biological azotofixation in agriculture: Capability, use and perspective, The collection of works of The Institute for agriculture and vegetable growing, vol. 29, 27-35, Novi Sad.
- Hajnal - Jafari, T. (2010). The influence of inoculation on the income and microbiological activity in soil under sown maize, PhD thesis, The Faculty of Agriculture, Novi Sad.
- Kiss, S., Balarda, M., Radulesku, D. (1978). Soil Polysacharidases. In: Activity and agricultural importance in Soil enzymes. Ed. R. G. Burrs. Academic Press, London, 117 - 140.
- Milojević, M. (1954). The economic and geographical characteristics of the Kragujevačka Rača river basin, The collection of works SAN, XLI, The Institute for Geography 9, 163-203, Belgrade.
- Najdenovska, O. (2001). Azotobacter and its activity under sown potato, PhD thesis, The Faculty of Agriculture, Novi Sad.
- Popović, V. (2010): Influence of agro-technical and agro-ecological practices on seed production of wheat, maize and soybean, PhD Thesis, University of Belgrade, Faculty of Agriculture, 1-145. 86-90.
- Šarčević, M. Ljubica (2010). Effect of quantity of nitrogen fertilizer on microbiological activity of soil under sown maize, M.A. thesis, University of Belgrade, Faculty of Agriculture.
- Tabaković, M., Jovanović, S., Popović, V., Ranković, D., Stanisavljević, R., Štrbanović, R. (2016). Variables of characteristics of hybrid seed of maize at different locations of production, XXX Conference of agronomists, veterinarians, technologists and agroeconomists, Belgrade, Vol. 22, 135-172.
- Vojinović, Ž. (1956). The enclosure to the research of the extent of azotobacter in soil in Serbia, The Archives of Agricultural Sciences, vol. 26, 1-16, Belgrade.
- Živković, D., Kostoski, S. (2000). Agroclimatic characteristic of the Republic of Serbia, Book of Proceedings of the First Conference on Medicinal and Aromatic Plants of Southeast European Countries, May 29 - June 03, 151 - 162, Arandelovac, Yugoslavia.



## INFLUENCE OF *PSEUDOMONAS* SPP. AND METALLURGICAL SLAG AMENDMENT ON MACROELEMENTS CONTENT IN RADICCHIO GROWN ON ACID SOIL

Radmila PIVIĆ<sup>1</sup>, Aleksandra STANOJKOVIĆ-SEBIĆ<sup>1</sup>, Zoran DINIĆ<sup>1</sup>, Magdalena KNEŽEVIĆ<sup>1\*</sup>, Renata ILIČIĆ<sup>2</sup>, Dragana LATKOVIĆ<sup>2</sup>, Dragana JOŠIĆ<sup>1</sup>

<sup>1</sup>Institute of Soil Science, Teodora Drajzera 7, 11000 Belgrade, Serbia

<sup>2</sup>University of Novi Sad, Faculty of Agriculture, Trg Dositeja Obradovića 8, Novi Sad, Serbia

\*Corresponding author: [knez.magdalena@gmail.com](mailto:knez.magdalena@gmail.com)

### Abstract

Radicchio, *Chicorium* spp. var. *rossa di treviso*, grows well in soils with a pH of 5.5 - 6.8, especially in well drained loose fertile soils which are rich in nutrients. Thus, if the cultivation of this plant is planned on the soils with high soil acidity such as Stagnosol, a necessary lime should be applied along with regular fertilization. The aim of this study was to investigate the influence of calcium containing metallurgical slag (MS), a by-product from a steel factory, as a potential liming agent on macroelement content in radicchio leaves. The effect of applied bacteria was also tested, knowing that some of the fluorescent *Pseudomonas* species are plant growth promoting rhizobacteria (PGPR) capable to colonize the plants roots, stimulate the growth and have antagonism towards phytopathogenic microorganisms. The study was performed through vegetative experiments in semi-controlled greenhouse conditions. Along with the slag, the effect of two indigenous PGPR strains from *Pseudomonas* genera, Q4 and B25, was tested through the following variants: V1: Control; V2: Strain Q4; V3: B25 strain; V4: Metallurgical slag; V5: MS+ strain Q4 and V6: MS + strain B25. P was determined by spectrophotometer, K - by flame emission photometry and total N and C by using elemental CNS analyzer Vario EL III, while Ca and Mg were determined by AAS. All treatments showed positive effects on plant and root yield as well as on elemental chemical composition of radicchio leaves, whereby the effect of variant with MS and Q4 strain was the most pronounced. In addition, this effect on N, K, Ca and Mg contents was statistically significant in relation to the control.

**Keywords:** *Pseudomonas* strains, metallurgical slag, stagnosol, macroelements, radicchio.

### Introduction

Radicchio “Rossa di Treviso” is the classic red tall Italian radicchio. It belongs to the genus *Cichorium* and family Asteraceae. Radicchio plant is resistant to cold, as it is an early variety which can be harvested from the end of the summer and during the winter. Radicchio is suitable for growing in containers or pots. Due to nutritional features of radicchio leaf, the consuming in a form of fresh vegetable was intensified, which lead to increasing commercial interest during the last years (Filippini et al., 2011). Radicchio has many useful substances with antioxidant properties, including carotenoids, vitamins A, B<sub>6</sub>, K, as well as macro- and micro- elements, such as phosphorus, potassium, zinc, copper, iron, etc. (Ćustić et al., 2003; Mulabagal et al., 2009). The plant has a certain kind of bitterness since it has high content of sesquiterpene lactones, such as lactucin, 8-desoxylactucin and lactucopicrin (Ferioli et al., 2015).

Regarding the soil, it grows well in soils with a pH of 5.5 - 6.8, but loose fertile soils that have plenty of nutrients and good drainage are ideal. Thus, if the cultivation of this plant is planned on the soils with high soil acidity such as Stagnosol, a necessary lime should be applied along

with regular fertilization. The use of traditional alkaline liming materials in amelioration of soil acidity consequently improves crop production and it is a common practice (Bolan et al., 2003; Troeh and Thompson, 2005). During the last few years, metallurgical slag has prompted its use as a liming material on acid agricultural soils (Lopez et al., 1995). In recent years, interest in soil microorganisms able to promote plant growth or help prevent the attack of soil-borne plant pathogens has increased. These beneficial bacteria are usually referred to as plant growth-promoting rhizobacteria or PGPR (Lucas García et al., 2004). Their use as biofertilizers in plant production plays an important role as a supplement for improving the growth and yield of several agricultural, horticultural and medicinal plants (Lugtenberg and Kamilova, 2009). Growth promotion and disease control by these bacteria are complex interrelated processes, involving direct and indirect mechanisms that include synthesis of some metabolites (auxin, cytokinin and gibberellins), production of siderophore, antibiotics, hydrogen cyanide (HCN), and volatile compounds, while the others include mineral solubilization (e.g., phosphorus), competition, and induced systemic resistance (Adesemoye et al., 2008). Some of the fluorescent *Pseudomonas* species have already been considered as potentially powerful PGP agents (Souza et al., 2015). The aim of the study was to investigate the influence of calcium containing metallurgical slag, a by-product from the steel factory, as a potential liming agent, along with two indigenous plant growth promoting rhizobacterial *Pseudomonas* spp. strains Q4 and B25, on macrolelement content in the leaves of radicchio grown on acid Stagnosol type of soil.

### Material and Methods

The bacterial strains *Pseudomonas* spp. Q4 and B25, isolated from rhizosphere of maize and clover, respectively, were characterized in our previous studies using biochemical and 16S rDNA analyses (Jošić et al., 2012; Jošić et al., 2015). The bacteria were grown in liquid King's B medium (KB) for 24 h at 120 rpm. All experiments were conducted using bacterial culture in concentration of  $10^6$  CFUml<sup>-1</sup>. The experiment was conducted using homogenized soil - Stagnosol (WRB, 2014). The soil samples were air-dried, crushed and passed through a sieve ( $\leq 2$  mm). Before setting up the trial, preliminary soil physical and chemical properties were studied. Soil granulometric composition and chemical soil properties were determined (Maksimovic et al., 2008). The same soil type was used in our previous investigation of radicchio without MS amendment (unpublished data). The soil properties are shown in Table 1.

Table 1. Physical and chemical properties of Stagnosol (means  $\pm$  standard deviation value).

Granulometric composition (fraction, %)	Chemical properties		
Bulky sand (2-0.2 mm)	5.0 $\pm$ 0.59	pH in 1M KCl	4.45 $\pm$ 0.01
Miniature sand (0.2-0.02 mm)	25.9 $\pm$ 1.33	Humus (%)	2.26 $\pm$ 0.47
Dust (0.02-0.002 mm)	45.1 $\pm$ 1.22	Available P <sub>2</sub> O <sub>5</sub> (mg 100g <sup>-1</sup> )	3.73 $\pm$ 0.28
Clay (< 0.002 mm)	24.0 $\pm$ 0.21	Available K <sub>2</sub> O (mg 100g <sup>-1</sup> )	19.80 $\pm$ 1.54
Total sand (> 0.02 mm)	30.9 $\pm$ 1.05	Available Ca (mg 100g <sup>-1</sup> )	240.00 $\pm$ 19
Dust + clay (< 0.02 mm)	69.1 $\pm$ 1.05	Available Mg (mg 100g <sup>-1</sup> )	35.00 $\pm$ 3.89

Chemical composition of metallurgical slag (MS) used in this experiment (Table 2) was determined in our previous study (Pivić et al., 2011). This material has very alkaline reaction (pH = 12.50), with the content of calcium in oxide forms (CaO) from 33-45%, of which about 50% is easily soluble in 1 M ammonium acetate; content of the total magnesium is about 0.40% and it was mainly in forms of MgO (0.70%); total phosphorous contained in the material is about 0.60%, where nearly all the amount is in available forms for plants; content

of the total iron is high (about 15%), with noticeable lower amounts of its soluble forms; manganese is present in total amount of about 1.8% , but with noticeable low amounts of soluble forms; zinc is contained in lower amounts (10-20 mg kg<sup>-1</sup>), while the content of copper is a little higher (about 200 mg kg<sup>-1</sup>).

Table 2. Chemical composition of metallurgical slag (Pivić et al., 2011).

Parameter	Average value	Parameter	Average value
pH in H <sub>2</sub> O	12.48	Total P <sub>2</sub> O <sub>5</sub> (%)	0.61
Total Ca (%)	26.20	Total Fe (%)	15.34
Total CaO (%)	36.60	Available Fe (mg kg <sup>-1</sup> )	3.38
Total CaCO <sub>3</sub> (%)	65.80	Total Mn (%)	1.80
Available Ca (%)	17.18	Available Mn (mg kg <sup>-1</sup> )	3.12
Total Mg (%)	0.41	Total Zn (%)	14.60
Available Mg (%)	0.07	Total Cu (%)	228.8

The pot experiment was conducted during the fourth week of July until the second week of November in 2013, in plastic pots with 4 kg of homogenized soil. The effect of PGP *Pseudomonas* spp. and MS amendment were studied on radicchio (*Cichorium* spp.) variety *rossa di treviso*, in pot experiment (five plants per pot) under semi-controlled conditions in the glasshouse. Six experimental variants were set up in 3 replications, as follows: Control (V1); strain Q4 (V2); strain B25 (V3); Metallurgical slag (V4); strain Q4 + MS (V5); strain B25 + MS (V6). Before sowing the radicchio, MS with granulation of 0.2 mm and in the amount of 1.33 g kg<sup>-1</sup> was mixed with soil in appropriate experimental plastic pots (V4-V6). The inoculation of the soil and radicchio plants in appropriate pots (V2-V3, V5-V6) was carried out with the solution containing 150 ml of distilled water and 50 ml of Q4 or B25 liquid culture. Control (V1) was treated with solely 200 ml of distilled water. Radicchio plants were grown for 16 weeks according to the standard growing methods. Leaf and root samples were dried at 105°C for a period of 2 hours and their biomass was weighed. The following macroelements were analyzed in the leaf samples: nitrogen (N) and carbon (C) were analyzed on elemental CNS analyzer Vario EL III (Nelson and Sommers, 1996); phosphorus (P) and potassium (K) contents were determined by method named as “wet” combustion, i.e. they were heated to boiling with the mixture of concentrated sulfuric and perchloric acids. In the obtained solution, P was determined by spectrophotometer with molybdate, and K - by flame emission photometry (Jakovljević et al., 1985); calcium (Ca) and magnesium (Mg) were determined by Atomic Absorption Spectrometry (AAS) (Wright and Stuczynski, 1996), where the plant material was converted to a solution by method named as "dry" combustion, i.e., first by heating at 550°C (for several hours) and then by treating the obtained ash with hydrochloric acid (Miller, 1998). The obtained data on soil properties represent the arithmetic means of three replicates and standard deviation values. The effects of V1-V6 treatments on the studied chemical parameters of the plants were evaluated using the analysis of variance (SPSS 20.0, Chicago, USA), followed by Duncan's Multiple Range Test (DMRT). Significant differences between means were tested by the LSD test at P = 0.05.

## Results and Discussion

The results of physical and chemical properties of plowed layer of the studied Stagnosol, shown in Table 1, indicated that it is a clay loam according to the soil textural class determined on the basis of particle size distribution. According to the reference values (Šestić et al., 1969), it has very acid reaction and medium humus content, with a very low content of

available phosphorus and medium provided with available potassium. It is medium provided with calcium and with high content of magnesium. All tested variants gave higher yield in comparison with the control sample (Table 3). Application of MS in combination with B25 strain (V6) had the best activity on yield of plant mass, while the combination of MS and Q4 strain (V5) showed slightly weaker activity. These two variants also gave the highest root mass yields. Results of merely application of MS (V4), Q4 (V2) and B25 strain (V3) were similar, with values of plant and root yield not significantly higher than the control sample (V1).

Table 3. Yield of plant and root mass for each variant

Variant	Yield of plant mas (g/pot) *	Root mass yield (g/pot) *
V1 (Control)	7.06±0.03 <sup>b</sup>	0.46±0.02 <sup>b</sup>
V2 (Q4)	13.14±0.20 <sup>b</sup>	0.76±0.09 <sup>b</sup>
V3 (B25)	11.82±0.82 <sup>b</sup>	0.94±0.36 <sup>b</sup>
V4 (MS)	10.86±5.70 <sup>b</sup>	0.63±0.36 <sup>b</sup>
V5 (Q4+MS)	20.03±5.15 <sup>a</sup>	1.51±0.04 <sup>a</sup>
V6 (B25+MS)	21.48±0.92 <sup>a</sup>	1.43±0.13 <sup>a</sup>
P value	***	***
LSD (0.05)	5.65	0.39

\* means ± standard deviation; LSD - least significant difference; values followed by the same letter in a column is not significantly different at P< 0.05 based on Duncan's Multiple Range Test

*Pseudomonas* spp. has also proven to increase tomato plant yield for 46%, due to its ability to colonise the plant's root, produce variety of antimicrobial compounds, and induce plant's defence mechanisms (Arseneault et al., 2015). Increase in root yield for 179% has been recorded for apple plants, 42% for wheat and maize, and up to 200% for potato, when treating plants with different *Pseudomonas* strains (Gupta et al., 2013). These data are in consistence with results obtained in our study, where V5 and V6 induced plant and root mass yield increase for over 280%.

The data on main chemical growth parameters in radicchio leaves influenced by the treatments applied is shown in Table 4. The positive effects N, P, K, C, Ca and Mg content in the samples of leaves in relation to the control was observed for all studied treatments. The maximal values for all tested available macroelements were achieved by applying the combination of MS and Q4 strain (V5). This influence was statistically significant at P<0.05 regarding the content of N, K, Ca and Mg, with the highest statistical significance for K, while for the content of P and C there were no statistically different between the treatments.

Table 4. Effect of applied treatments on the content of macroelements in radicchio leaves.

Variants	Macroelements (% of dry biomass) *					
	N	P	K	C	Ca	Mg
V1 (Control)	3.39±0.03 <sup>b</sup>	0.65±0.04	2.11±0.09 <sup>c</sup>	38.09±0.58	1.32±0.08	0.31±0.01 <sup>b</sup>
V2 (Q4)	3.39±0.41 <sup>b</sup>	0.68±0.03	2.80±0.12 <sup>b</sup>	38.86±0.57	1.38±0.21	0.35±0.04 <sup>ab</sup>
V3 (B25)	3.73±0.52 <sup>ab</sup>	0.67±0.01	2.33±0.21 <sup>bc</sup>	38.59±1.11	1.35±0.17	0.35±0.03 <sup>ab</sup>
V4 (MS)	3.60±0.08 <sup>ab</sup>	0.67±0.06	2.77±0.12 <sup>b</sup>	39.43±0.36	1.57±0.01	0.38±0.01 <sup>ab</sup>
V5 (Q4+MS)	4.06±0.03 <sup>a</sup>	0.73±0.04	3.46±0.40 <sup>a</sup>	40.00±0.91	1.71±0.06	0.40±0.01 <sup>a</sup>
V6 (B25+MS)	3.43±0.05 <sup>b</sup>	0.67±0.02	2.37±0.14 <sup>bc</sup>	38.80±0.37	1.39±0.19	0.36±0.03 <sup>ab</sup>
P value	*	NSD	***	NSD	*	*
LSD (0.05)	0.404	0.067	0.368	1.636	0.251	0.046

\* means ± standard deviation; LSD - least significant difference; values followed by the same letter in a column is not significantly different at P< 0.05 based on Duncan's Multiple Range Test

Limitations in crops growth on acid soils are well known. However, the optimum pH range of soil for the growth of most crops is between 5.5 and 7.0, within which most plant nutritive are available (Goulding et al., 2016). Regarding the effects of slag amendments to acid soil, Besga et al. (1996) reported increase in the soil pH linearly, which has allowed the plant absorption of phosphorus, due to a changing of insoluble forms to soluble ones, as well as increase in the Ca and Mg contents. Other authors have also proved that PGP *Pseudomonas* strains can induce increase in N, P and K levels in different plants (Vikram et al., 2007; Ordookhani et al. 2011).

### Conclusions

Application of MS in combination with B25 strain (V6), as well as its combination with Q4 strain (V5) had the best activity on yield of plant and root mass. The data on studied macroelements in radicchio leaves showed that all studied treatments exhibited positive effects on the content of N, P, K, C, Ca and Mg in relation to the control. The most pronounced effect was registered in the variant with metallurgical slag and *Pseudomonas* sp. Q4 strain. This influence was statistically significant regarding the content of N, Ca, Mg and especially K, which presents a very important element for nutrient quality of vegetables.

### Acknowledgment

This study was conducted as a part of the project III 46007, financially supported by the Ministry of Education, Science and Technological Development of the Republic of Serbia.

### References

- Adesemoye A.O., Obini M., Ugoji E.O. (2008). Comparison of plant growth-promotion with *Pseudomonas aeruginosa* and *Bacillus subtilis* in three vegetables. *Brazilian Journal of Microbiology*, 39, 423-426.
- Arseneault, T., Goyer, C., & Filion, M. (2015). *Pseudomonas fluorescens* LBUM223 Increases Potato Yield and Reduces Common Scab Symptoms in the Field. *Phytopathology*, 105(10), 1311-1317.
- Besga G., Pinto M., Rodríguez M., López F., Balcázar N. (1996). Agronomic and nutritional effects of Linz-Donawitz slag application to two pastures in Northern Spain. *Nutrient Cycling in Agroecosystems*, 46, 157-167.
- Bolan N.S., Adriano D.C., Curtin D. Soil Acidification And Liming Interactions with Nutrient and Heavy Metal Transformation and Bioavailability. *Advances in Agronomy*, 78, 215-272.
- Ćustić M., Poljak M., Čoga L., Čosić T., Toth N., Pecina M. (2003). The influence of organic and mineral fertilization on nutrient status, nitrate accumulation, and yield of head chicory. *Plant, Soil and Environment*, 49, 218-222.
- Ferioli F., Manco M., D'Antuono, L. (2015). Variation of sesquiterpene lactones and phenolics in chicory and endive germplasm. *Journal of Food Composition and Analysis*, 39, 77-86.
- Filippini M.F., Nicoletto C., Sambo P., Cavagnaro J.B., Pimpini F. (2011). Influence of fertilization on the growth of radicchio "Rosso di Chioggia" cultivated in two different environments. *Revista de la Facultad de Ciencias Agrarias UNCuyo*, 43, 111-131.
- Jakovljević M., Pantović M., Blagojević S. (1985). Manual in chemistry of soil and waters. University of Belgrade, Faculty of Agriculture (in Serbian).

- Jošić D., Delić D., Rasulić N., Stajković O., Kuzmanović D., Stanojković A., Pivić R. (2012). Indigenous Pseudomonads from rhizosphere of maize grown on pseudogley soil in Serbia. *Bulgarian Journal of Agricultural Science*, 18, 197-206.
- Jošić D., Ćirić A., Soković M., Stanojković-Sebić A., Pivić R., Lepšanović Z., Glamočlija J. (2015). Antifungal activities of indigenous plant growth promoting *Pseudomonas* spp. from alfalfa and clover rhizosphere. *Frontiers in Life Science*, 8, 131-138.
- Goulding, K. (2016). Soil acidification and the importance of liming agricultural soils with particular reference to the United Kingdom. *Soil Use and Management*, 32(3), pp.390-399.
- Gupta K.V., Schmoll M., Maki M., Tuohy M., Mazutti M.A. (2013). *Applications of microbial engineering*. Boca Raton: CRC Press.
- Lopez F.A., Balcaza, N., Formoso A., Pinto M., Rodriguez M. (1995). The recycling of Linz-Donawitz (LD) converter slag by use as a liming agent on pasture land. *Waste Management and Research*, 13, 555-568.
- Lucas García J.A., Probanza A., Ramos B., Ruiz Palomino M., Gutiérrez Mañero F.J. (2004). Effect of inoculation of *Bacillus licheniformis* on tomato and pepper. *Agronomie, EDP Sciences*, 24, 169-176.
- Lugtenberg B., Kamilova F. (2009). Plant growth-promoting rhizobacteria. *Annual Review of Microbiology*, 63, 541-556.
- Maksimovic S., Blagojevic S., Pivic R., Stanojkovic A. (2008). Quality characteristics of some grass species cultivated on fly-ash deposits of a thermal power station. *Fresenius Environmental Bulletin*, 17 (5), 584-588.
- Miller R. (1998). High-temperature oxidation: dry ashing. In, Kalra Y., "Handbook of reference methods for plant analysis", CRC Press, Boca Raton, Florida, 53-56.
- Mulabagal V., Wang H., Ngouajino M., Nair M. (2009). Characterization and quantification health of beneficial anthocyanins in leaf chicory (*C. intybus*) varieties. *European Food Research and Technology*, 230, 47-53.
- Nelson D.W., Sommers L.E. (1996). Total carbon, organic carbon, and organic matter. In, Sparks D.L., "Methods of soil analysis, Part 3", SSSA, Madison, Wisconsin, 961-1010.
- Ordookhani K., Sharafzadeh S., Zare M. (2011). Influence of PGPR on growth, essential oil and nutrients uptake of sweet basil. *Advances in Environmental Biology*, 5, 672-677.
- Pivić R., Stanojković A., Maksimović S., Stevanović D. (2011). Improving the chemical properties of acid soils and chemical composition and yield of spring barley (*Hordeum vulgare* L.) by use of metallurgical slag. *Fresenius Environmental Bulletin*, 20, 875-885.
- Šestić S., Glintić M., Manojlović S. (1969). Interpretation of the results of soil analysis. In, "Handbook for systematic control of soil fertility and fertilizers use", Center for the Improvement of Agricultural Production in Serbia - Professional Board for Control of Soil Fertility and the Use of Mineral Fertilizers, Belgrade, Serbia, 67-80 (in Serbian).
- Souza, R., Ambrosini, A. and Passaglia, L. (2015). Plant growth-promoting bacteria as inoculants in agricultural soils. *Genetics and Molecular Biology*, 38(4), 401-419.
- SRPS ISO 10390:2007 (2007). Soil quality - determination of pH. Institute for Standardization of Serbia, Belgrade, Serbia.
- Troeh F.R., Thompson L.M. (2005). *Soils and fertility*. 6th Edition. Blackwell Publishing, New Jersey.
- Vikram A., Krishnaraj P.U., Hamzehzarghani H., Jagadeesh K.S. (2007). Growth promotional potential of *Pseudomonas fluorescens* FPD-10 and its interaction with *Bradyrhizobium* sp. *Research Journal of Microbiology*, 2, 354-361.
- Wright R.J., Stuczynski T. (1996). Atomic absorption and flame emission spectrometry. In, Sparks D.L., "Methods of soil analysis, Part 3", SSSA, Madison, Wisconsin, 65-90.

## EFFECT OF DIFFERENT SEED TREATMENTS ON THE DORMANCY BREAKING AND GERMINATION OF DARWIN'S BARBERRY (*BERBERIS DARWINII* HOOK)

Marija MARKOVIĆ\*, Mihailo GRBIĆ, Dragana SKOČAJIĆ, Matilda ĐUKIĆ, Danijela ĐUNISIJEVIĆ-BOJOVIĆ

University of Belgrade, Faculty of Forestry, Kneza Visislava 1, 11030 Belgrade, Serbia

\*Corresponding author: marija.markovic@sfb.bg.ac.rs

### Abstract

Darwin's barberry is a decorative, medicinal, edible and low demanding evergreen shrub, grown as an ornamental plant in Western Europe. This species should be used in green spaces in Serbia more often. *B. darwinii* can be propagated by seed, but it has endogenous seed dormancy. For this reason, we decided to investigate which chilling treatment will be effective in breaking its dormancy. The seeds used in our experiments were collected in Hyde Park in London, and after maceration they were cold stratified in perlite or in bags without a substrate for 3, 4 and 5 months. The parameters of seed germination were determined according to the ISTA rules. The best results were achieved with the seeds cold stratified in perlite for 4 and 5 months, whose germination rate was 73.5% and 73.0% respectively. However, seeds stratified for 5 months in perlite had a higher germination energy (69.0%) compared with seeds stratified for 4 months (37.0%). There are indications that germination rate can be improved with combination of warm and cold stratification, so additional research should be conducted.

**Keywords:** *Darwin's barberry, seed dormancy, cold stratification, generative propagation.*

### Introduction

Darwin's barberry (*Berberis darwinii* Hook) is a thorny, dense branched, evergreen shrub growing up to 3 m (4 m). The leaves are dark glossy green, broadly oblong, with a spiny margin. It flowers from April to May, and the flowers are gold to orange, produced in dense, drooping racemes, followed by blue-black berries ripening in summer (Tenenbaum, 2003; Weber, 2017). Darwin's barberry is native in South America, growing in moist open woodlands of the alpine regions of Chile, Argentina and Patagonia (Weber, 2017). It is a decorative, low demanding plant suitable for slopes and cottage or informal gardens. It is a good hedging plant, that can be pruned. *B. darwinii* prefers warm, moist loamy soil, but it also tolerates thin, dry and shallow soil as well as heavy clay soil. It grows well in full sun or light shade, in zones 7 to 9 (Huxley *et al.*, 1999; Tenenbaum, 2003). This is a melliferous, edible and medicinal species (Fern, 2000; Janick and Paull, 2006). Outside its native range, Darwin's barberry is grown as an ornamental plant in Western Europe and North America. In New Zealand and Australia it is considered an invasive species and a serious threat to indigenous biodiversity (Weber, 2017). However, according to the DAISIE, a database of alien and invasive species in Europe (<http://www.europe-aliens.org/>), Darwin's barberry is not an invasive species in Europe. Furthermore, the Royal Horticultural Society recommends its use as a low maintenance and decorative species (<https://www.rhs.org.uk>). Taking into account all these characteristics, *B. darwinii* should be recommended for use in green spaces in Serbia.

*B. darwinii* can be propagated from seeds or cuttings. Vegetatively, Darwin's barberry can be propagated from semi-hardwood cuttings (Hartmann *et al.*, 2010). Its seeds have dormancy mechanisms in order to prevent seed germination during an inappropriate season. For this reason, in natural conditions, seeds germinate in the spring following dispersal (Figueroa, 2003), therefore seed dormancy is often broken during a certain period of low temperature. This can be achieved artificially by storing imbibed seeds at low temperatures, a treatment known as a cold stratification (Baskin, Baskin 1998, Grbić, 2003). *B. darwinii* has endogenous seed dormancy and its seeds require cold stratification, for 2 to 3 months at 4°C or can be sown in fall in a cold frame when it should germinate in early spring (Dirr and Heuser, 1987; Bonner and Karrfalt, 2008; Hartmann *et al.*, 2010). It is important to remove all pulp from the seeds, because the seeds are susceptible to fungal infections (Piotto and Noi, 2003). However, there are no data available about the exact stratification time and expected germination rate. For this reason, we decided to investigate the effect of different seed pretreatments on the dormancy breaking and germination of this species.

### Material and Methods

Seeds were collected from the mother plant growing in Hyde Park in London, near the Diana Princess of Wales Memorial, on 17th of June, 2008. After collection, all pulp from seeds was removed and they were thoroughly washed with distilled water, surface dried and stored at room temperature before testing. Six pre-sowing chilling treatments were made. The seeds were stratified at 3-5°C for 3, 4 or 5 months. There were two groups of treatments. The first one was chilling in plastic, transparent bags which were opened each week and moisture was controlled (naked stratification). The second group of seeds was put in the chilling in perlite. The seeds in control treatment were tested without chilling pretreatments. After stratification, the seeds were treated with Previcur N fungicide (0.3 % v/v) and placed on the top of two layers of filter paper in petri dishes. Humidity was controlled daily by adding distilled water if necessary. Temperature during germination was 20°C. Germination was carried out in long day conditions (light/dark period 16/8h). The germination was tested according to ISTA (1985) rules for the genus *Berberis*. The first count was the 7th day (germination energy) and the last count was the 21th day after placing the seeds. In this period, the number of germinated seeds was recorded daily. Besides germination rate and germination energy, real germination rate was also calculated as a percentage of sound (viable) seeds that germinate (Grbić *et al.*, 2010). Each treatment consisted of four replicates with 50 seeds per repetition. The obtained data were statistically analyzed using the program Statgraphics Plus, Ver 2.1.

### Results and Discussion

In the control treatment there were no germinated seeds. The same result was obtained after a 3-month stratification period, with seeds that did not germinate in both treatments (chilling in plastic bags and chilling in perlite). After 4 months of chilling in perlite, seeds started to germinate during stratification, and 26% seeds germinated before testing. The seeds continued to germinate and germination energy was 37.0%, germination rate was 73.5%. Contrary to that, the seeds from naked stratification did not germinate during a 4-month stratification period, and after testing, germination rate was noticeably lower - only 4.5%, and germination energy was 0%. During 5 months of stratification in perlite, the seeds also started to germinate, and after stratification there were 67.5% germinated seeds. After testing on the filter paper in petri dishes, germination rate reached 73.0%. In naked stratification treatment, during the 5



months of stratification, only one seed germinated. After testing, germination energy was low - 1.5% and germination rate was only 7% (table 1).

Table 1. Germination of collected seeds

Treatment	Germination rate	Germination energy	Real germination rate
Control	0.0c	0.0c	0.0c
3 months stratification in perlite	0.0c	0.0c	0.0c
3 months naked stratification	0.0c	0.0c	0.0c
4 months stratification in perlite	73.5a	37.0b	73.8a
4 months naked stratification	4.5bc	0.0c	4.8bc
5 months stratification in perlite	73.0a	69.0a	75.1a
5 months naked stratification	7.0b	1.5c	7.1b

Values followed by different letters are significantly different at the  $P < 0.05$  level according to the LSD test

Compared to results obtained with other barberry species, germination rate recorded in our research is lower than germination percentage of *B. aristata* (84%) after 2 months of stratification at  $-5^{\circ}\text{C}$  (Thakur *et al.*, 2005). Belwal *et al.* (2015) had applied different pretreatments including soaking the seeds in different solutions, different temperatures and storage conditions and they got germination rate 92% for *B. aristata*, but only 50.6% for *B. jaeschkeana*. Results obtained in our research showed that stratification in substrate as well as duration of stratification strongly influenced germination response (Table 1). Germination rate was almost the same after 4 or 5 months for seeds stratified in perlite (73-73.5%), but germination energy was considerably higher after 5 months of stratification than after 4 months. An investigation of the germination of *B. manipurana* indicated that light conditions can also affect germination (Deb *et al.*, 2017). The highest germination rate (seeds stratified at  $4^{\circ}\text{C}$  for 75 days) was 82.5% in 50% shade, 65% in 75% shade and 52.5% in normal light conditions. However, Deb *et al.* (2017) stated that *B. manipurana* is a species that grows in shady moist habitats, so better germination in light shade than in full sun conditions could be expected. Contrary to this, Maliwichi-Nyirenda *et al.* (2011) showed that light conditions did not affect the germination of *B. holstii*, but seeds stored at  $5^{\circ}\text{C}$  germinated faster than the seeds kept at room temperature, although *B. holstii* is the African species that does not require cold stratification for germination. Thakur *et al.* (2006) found that seeds of *B. aristata* are facultatively photoblastic with a maximum germination of 77-83% after 3 months of stratification. Bonner and Karrfalt (2008) stated that simple cold stratification of *Berberis* spp. is not always successful and that there is a possibility of presence of some immature embryos in some barberry seeds, so a period of warm stratification followed by cold stratification can increase germination rate.

### Conclusion

*B. darwinii* satisfactory germination rates (73%) can be obtained after 5 months of stratification in perlite at temperatures from 3 to  $5^{\circ}\text{C}$ . However, taking into account the results obtained with other barberry species, there is a possibility of improving the germination of *B. darwinii* by testing the effects of other factors (e.g. light, stratification at other temperatures, soaking the seeds in different solutions).

## Acknowledgement

This study was supported by the Ministry of Education and Science of Serbia, grant No 43007.

## References

- Belwal T., Bisht A., Bhatt I.D., Rawal R. (2015). Influence of seed priming and storage time on germination and enzymatic activity of selected *Berberis* species. *Plant Growth Regulation*, 77: 189-199.
- Bonner F.T., Karrfalt, R. P. (2008). *The Woody Plant Seed Manual*. USDA Forest Service.
- Deb C., Sangtam T., Jamir N. (2017). Seed Biology of *Berberis manipurana* Ahrendt: A Threatened Natural Dye Yielding Plant. *American Journal of Plant Sciences*, 8: 1285-1295.
- Dirr, M.A., Heuser Jr., C.W. (1987). *The Reference Manual of Woody Plant Propagation: From Seed to Tissue Culture*. Varsity Press, Inc.
- Fern K. (2000). *Plants for a future: edible & useful plants for a healthier world*. Permanent Publications, Hampshire.
- Figueroa, J. A. (2003). Seed germination in temperate rain forest species of southern Chile: chilling and gap dependency germination. *Plant Ecology* 166: 227-240.
- Grbić, M. (2003). Seed Dormancy and Germination – Mechanisms, Clasifications and Practices. *Glasnik Šumarskog fakulteta* 87: 25-49.
- Grbić M., Skočajić D., Obratov-Petković D., Bjedov I., Đukić M., Đunisijević-Bojović D. (2010). Presowing treatments to breaking seed dormancy of *Pterocarya stenoptera* C. DC as an indicator of potential invasiveness. *Bulletin of the Faculty of Forestry* 103: 29-40
- Hartmann, H. T., D. E. Kester, F. T. Davies Jr., and R. T. Geneve. eds. (2010). *Plant Propagation: Principles and Practices*, 8th Edition. Chapter 20, Propagation of Ornamental Trees, Shrubs, and Woody Vines. Upper Saddle River, New Jersey, Prentice Hall
- Huxley A., Griffiths M., Levy, M. (1999). *The new Royal Horticultural Society dictionary of gardening*. London: Macmillan Press.
- ISTA - International Rules for Seed Testing (1985). Adopted at the 20th International Seed Testing Congress, Canada.
- Janick J., Paull R. (2006). *The encyclopedia of fruit and nuts*. Cambridge, MA, CABI North American Office.
- Maliwichi-Nyirenda C.P., Maliwichi L.L., Franco M., (2011). Medicinal uses of *Berberis holstii* Engl. (Berberidaceae) in Malawi, the only African endemic barberry. *Journal of Medicinal Plants Research* 5 (8), 1367–1373.
- Piotto B, Noi A (2003). Propagation of Mediterranean trees and shrubs from seed. APTA (Agency for the protection of the environment and for technical services) report, Roma, Italy. p.19
- Tenenbaum, F., ed. (2003). *Taylor's encyclopedia of garden plants*. Houghton Mifflin Harcourt, New York
- Thakur A, Thakur PS, Mehta R (2006) Studies on germination, viability and vigour in Indian barberry (*Berberis aristata* DC.), an endangered medicinal plant species of Western Himalayas. *Indian Forester* 132(4): 485–492.
- Thakur A., Thakur P.S, Mehta R. (2005). Effect of presowing treatments on seed germination in *Berberis aristata*. *Indian Journal of Plant Physiology*, 10/4: 338-343

Weber E. (2017). *Invasive Plant Species of the World: A Reference Guide to environmental weed*, 2nd Edition. CAB International.

<http://www.europe-aliens.org/speciesFactsheet.do?speciesId=6093> Accessed on 5/2/2017

<https://www.rhs.org.uk/Plants/2105/Berberis-darwinii/Details> Accessed on 5/2/2017

## EFFECT OF GIBBERELIC ACID AND POTASSIUM NITRATE ON THE SEED GERMINATION OF BLUE-EYED GRASS (*SISYRINCHIUM ANGUSTIFOLIUM* MILL.)

Marija MARKOVIĆ\*, Mihailo GRBIĆ, Dragana SKOČAJIĆ, Matilda ĐUKIĆ, Danijela ĐUNISIJEVIĆ-BOJOVIĆ

University of Belgrade, Faculty of Forestry, Kneza Viseslava 1, 11030 Belgrade, Serbia

\*Corresponding author: marija.markovic@sfb.bg.ac.rs

### Abstract

Propagation of blue-eyed grass (*Sisyrinchium angustifolium* Mill.) is difficult due to its embryo dormancy. The aim of this research is to establish a suitable method of breaking seed dormancy of this species. The seeds used in this experiment were collected in a private garden in Belgrade, and the effect of different treatments on seed germination was evaluated. These treatments included the application of different concentrations ( $10^{-3}$  M,  $10^{-4}$  M,  $10^{-5}$  M) of GA<sub>3</sub> (gibberellic acid), application of 0.2% KNO<sub>3</sub> (potassium nitrate), cold stratification (1 or 2 months at 3-5°C) and combinations of these treatments. The obtained results showed that *S. angustifolium* requires cold pretreatment for germination, but germination percentage can be considerably improved by treating the seeds with KNO<sub>3</sub> or GA<sub>3</sub>. Data were statistically analysed and the best results were achieved with the seeds treated with  $10^{-3}$  M or  $10^{-4}$  M GA<sub>3</sub> and cold stratified for 2 months (79% and 70% germination rate, respectively).

**Keywords:** Blue-eyed grass (*Sisyrinchium angustifolium* MILL.), cold stratification, GA<sub>3</sub>, KNO<sub>3</sub>,

### Introduction

Blue-eyed grass (*Sisyrinchium angustifolium* Mill.) is a clump-forming perennial species, usually 25-30 cm tall, with a tuft of basal, simple, long, narrow grass-like or linear sword-like leaves. Blue-eyed grass blooms from late spring to mid-summer and flowers are formed in clusters (1 -3 flowers), about 2 cm across, violet-blue with yellow centers. Each flower is short lived, but they bloom successively and flowering can last several weeks (Chapman, 2008; Steiner, 2005). The flowers are open only in the sun, when bees are likely to visit (Cullina, 2000). After flowering, the seed capsules (4-6 mm in diameter) ripen from greenish yellow to dark brown, then split open in 3 sections releasing black, spherical seeds (about 1-1.4 mm in diameter). The seeds should be harvested when the capsules are dark colored and the seeds can be easily taken out (Cullina, 2000; Gardner, 2010). It is native to North America, where it grows on moist fields and meadows, prairies, in open woods, slopes and along stream banks (zones 4 - 9). Blue-eyed grass is grown as an ornamental plant, especially suitable for informal gardens (cottage gardens, woodland gardens, wild gardens), usually used at the front of mixed borders, as an edger for paths or walkways or in rock gardens (Cullina, 2000; Chapman, 2008; Steiner, 2005). *S. angustifolium* is a highly adaptable plant that can survive summer drought but it prefers moderately moist soils that do not dry out with good drainage. It grows in full sun, but tolerates part shade (Cullina, 2000). According to DAISIE (Delivering Alien Invasive Species Inventories for Europe), *S. angustifolium* is escaped from cultivation in some parts of Europe, but it is not considered as an invasive or potentially

invasive species (<http://www.europe-aliens.org>). Also, plantings can be cut back after bloom to avoid any unwanted self-seeding (Steiner, 2005).

Blue-eyed grass can be propagated by seeds or by division of clumps in early spring or fall (Cullina, 2000; Samuels, 2005). According to Cullina (2000) seeds germinate at 21°C after 90 days of moist cold stratification at 4-5°C, but Gardner (2010) states that this presowing treatment is not effective, giving only 15% germination. Similarly, Kuzovkina et al. (2016) state that germination of *S. angustifolium* can be difficult or slow. For species with endogenous dormancy various chemical treatments (gibberellic acid, potassium nitrate) can result in breaking dormancy and increasing the seed germination (Grbić, 2003). Gibberellins promote growth by increasing plasticity of the cell wall followed by the hydrolysis of starch to simple sugars. These sugars reduce cell osmotic potential which results in absorption of high amount of water, thus resulting in cell elongation and growth (Arteca, 1996).

The aim of our research was to find suitable presowing treatment to improve germination of *S. angustifolium*.

### Material and Methods

The ripe fruits were collected in private garden in Belgrade, in September, 2013. Experiment was conducted in the Laboratory for seed testing in Faculty of Forestry, Belgrade. The weight of fruits was measured as well as weight of seeds. This data were used for calculation of extraction factor (the weight of cleaned seeds per given weight of ripe fruits, expressed in percent), number of seeds in 1 kg and absolute weight of seeds (weight of 1000 seeds). Absolute weight of seeds was calculated as a mean weight of 4 samples of 100 seeds multiplied by 10. Collected seeds were used for the next experiment - evaluation of influence of different seed pretreatments on germination. The seeds are treated with solution of GA<sub>3</sub> (gibberellic acid) in concentrations of 10<sup>-3</sup>M, 10<sup>-4</sup>M, 10<sup>-5</sup>M for 24h or with 0.2% solution of KNO<sub>3</sub> (potassium nitrate) for 24h, or they were soaked in the distilled water also for 24h (control). The imbibition is conducted using a water pumps and silicone hoses that enabled a constant flow of oxygen, at the temperature of 20°C. After imbibition, the seeds are put on stratification at the temperature of 3-5°C during 1 or 2 months. The part of seeds are tested without stratification. Total 15 treatments including the control were made (Table 1).

Table 1. Seed pretreatments

Abbreviation	Treatment
C	control
KNO <sub>3</sub>	0.2% solution KNO <sub>3</sub>
GA <sub>3</sub> <sup>-3</sup>	solution 10 <sup>-3</sup> M GA <sub>3</sub>
GA <sub>3</sub> <sup>-4</sup>	solution 10 <sup>-4</sup> M GA <sub>3</sub>
GA <sub>3</sub> <sup>-5</sup>	solution 10 <sup>-5</sup> M GA <sub>3</sub>
1K	1 month stratification
1KNO <sub>3</sub>	0.2% solution KNO <sub>3</sub> + 1 month stratification
1GA <sub>3</sub> <sup>-3</sup>	solution 10 <sup>-3</sup> M GA <sub>3</sub> + 1 month stratification
1GA <sub>3</sub> <sup>-4</sup>	solution 10 <sup>-4</sup> M GA <sub>3</sub> + 1 month stratification
1GA <sub>3</sub> <sup>-5</sup>	solution 10 <sup>-5</sup> M GA <sub>3</sub> + 1 month stratification
2K	2 month stratification

2KNO <sub>3</sub>	0.2% solution KNO <sub>3</sub> + 2 month stratification
2GA <sub>3</sub> <sup>-3</sup>	solution 10 <sup>-3</sup> M GA <sub>3</sub> + 2 month stratification
2GA <sub>3</sub> <sup>-4</sup>	solution 10 <sup>-4</sup> M GA <sub>3</sub> + 2 month stratification
2GA <sub>3</sub> <sup>-5</sup>	solution 10 <sup>-5</sup> M GA <sub>3</sub> + 2 month stratification

Each experiment consisted of four replicates with 25 seeds each. Before testing, seeds were treated with 0.6% solution of commercial preparation Previcur (fungicide). The seeds were placed on the top of two layers of filter paper in the petri dishes, humidity was controlled daily by adding the distilled water if necessary. Temperature during germination was 20°C. Germination was carried out in long day conditions (light/dark period 16/8h). The first count was the 7th day (germination energy) and the last was the 21th day after placing the seeds into germination. Obtained data were statistically analysed using the program Statgraphics Plus, Ver 2.1.

### Results and Discussion

Weight of fruits was 118.12 g, weight of seeds was only 10.86 g, so the extraction factor was low - 9.19. Absolute weight of seeds was 0.63 g, and number of seeds in 1 kg was 1587301. According to Kuzovkina et al. (2016) the number of seeds of *S. angustifolium* in 1 kg is slightly higher - 757000/lb (approximately 1682222/kg).

Table 2. Germination of *S. angustifolium* seeds

Treatment	Germination rate (%)	Germination energy (%)
Control	3 <sup>f</sup>	0 <sup>f</sup>
0.2% KNO <sub>3</sub>	16 <sup>ef</sup>	0 <sup>f</sup>
10 <sup>-3</sup> M GA <sub>3</sub>	7 <sup>f</sup>	1 <sup>f</sup>
10 <sup>-4</sup> M GA <sub>3</sub>	21 <sup>e</sup>	0 <sup>f</sup>
10 <sup>-5</sup> M GA <sub>3</sub>	8 <sup>ef</sup>	0 <sup>f</sup>
1 month stratification	42 <sup>d</sup>	35 <sup>e</sup>
0.2% KNO <sub>3</sub> + 1 month stratification	61 <sup>bc</sup>	61 <sup>b</sup>
10 <sup>-3</sup> M GA <sub>3</sub> + 1 month stratification	67 <sup>ab</sup>	67 <sup>ab</sup>
10 <sup>-4</sup> M GA <sub>3</sub> + 1 month stratification	47 <sup>d</sup>	44 <sup>de</sup>
10 <sup>-5</sup> M GA <sub>3</sub> + 1 month stratification	67 <sup>ab</sup>	60 <sup>bc</sup>
2 month stratification	37 <sup>d</sup>	34 <sup>c</sup>
0.2% KNO <sub>3</sub> + 2 month stratification	61 <sup>bc</sup>	57 <sup>bc</sup>
10 <sup>-3</sup> M GA <sub>3</sub> + 2 month stratification	79 <sup>a</sup>	79 <sup>a</sup>
10 <sup>-4</sup> M GA <sub>3</sub> + 2 month stratification	70 <sup>ab</sup>	68 <sup>ab</sup>
10 <sup>-5</sup> M GA <sub>3</sub> + 2 month stratification	48 <sup>cd</sup>	48 <sup>cd</sup>

In control treatment, only 3% of seeds germinated, and in other treatments without cold stratification (0.2% KNO<sub>3</sub>, 10<sup>-3</sup>M GA<sub>3</sub>, 10<sup>-4</sup>M GA<sub>3</sub>, 10<sup>-5</sup>M GA<sub>3</sub>) germination percentage was also low, ranging from 7% to 21% (Table 2), indicating that *S. angustifolium* seeds have endogenous dormancy that requires cold pretreatment.

Potassium nitrate (KNO<sub>3</sub>) is widely used chemical in the presowing treatments for promoting germination (Copeland and McDonald, 2013). Its use is recommended by ISTA as a standard presowing treatment for germination test of many species (ISTA, 1985). In our research, pretreatments with solution of potassium nitrate influenced germination percentage. After 1 month and 2 months stratification, seeds treated with 0.2% KNO<sub>3</sub> solution germinated better (61%) then seeds stratified without it (42% for 1 month stratification, 37% for 2 month stratification) (Table 2). In treatments without cold stratification, germination percentage was also higher for seeds treated with KNO<sub>3</sub> (16%) compared to control (3%), but there were no significant statistical differences among these values.

Gardner (2010) emphasizes that *S. angustifolium* may requires light pretreatments for germination, and that KNO<sub>3</sub> pretreatment can influence germination of species sensitive to light (Copeland and McDonald, 2013). Deno (1993) states that 40% of *S. angustifolium* seeds germinated after treatment with light, without stratification, at the temperature of 21°C and that there were no germinated seeds in the dark. However, influence of KNO<sub>3</sub> pretreatment on germination is different depending on species, in some cases KNO<sub>3</sub> can be substitute for light, in some cases the light sensitivity of seeds is only increased, but in some cases KNO<sub>3</sub> pretreatment can counteract light inhibition of seed germination. For this reason, additional research of influence of light on *S. angustifolium* seed germination should be conducted.

For stratified seeds, treatments with GA<sub>3</sub> solutions influenced germination percentage strongly, increasing also the germination energy (Table 2). Response of seed on different concentrations of GA<sub>3</sub> differed depending on length of stratification. The best results were achieved with seeds treated with 10<sup>-3</sup>M GA<sub>3</sub> followed by 2 month stratification - 79% germinated seeds. This value was the same as germination energy, which means that all 79% of the seeds germinated after first count, on 7th days from placing seeds on germination.

Copeland and McDonald (2013) indicate that GA<sub>3</sub> pretreatment can be effective for freshly harvested seeds, reducing the time to germination and improving the rate of germination; but also dry seeds that have been after-ripened by natural storage are not as responsive to addition of GA<sub>3</sub>. Deno (1993) states that GA<sub>3</sub> pretreatment did not stimulate germination of *S. angustifolium*, but his experiment was conducted without stratification, and seeds germinated at 21°C, which is in accordance to our results, where percentage of germinated seeds treated with GA<sub>3</sub> without stratification was also low (Table 2).

### Conclusion

*S. angustifolium* can be easily propagated by seeds. The best results are obtained with seeds treated with 10<sup>-3</sup> M GA<sub>3</sub> followed by cold stratification for 2 months at the temperature of 3-5°C. Obtained germination rate was 79%. However, there is possibility to improve germination rate and additional research should be conducted in order to investigate the effect of light on germination of *S. angustifolium*.

### Acknowledgement

This work was supported by the Ministry of Education and Science of Serbia, grant No 43007.

## References

- Arteca, R.N. (1996). Plant growth substances: principles and applications . Chapter 3: Chemistry, biological effects and mechanism of action. Chapman & Hall, New York, USA
- Chapman W. (2008) Wildflowers of Massachusetts, Connecticut, and Rhode Island. Syracuse University Press.
- Copeland L.O., McDonald M. (2013). Principles of Seed Science and Technology. Springer.
- Cullina W. (2000). The New England Wild Flower Society Guide to Growing and Propagating Wildflowers of the United States and Canada. Houghton Mifflin Harcourt, USA. pp. 193-194.
- Deno N.C. (1993). Seed germination: theory and practice. Norman C. Deno, USA.
- Gardner, W. H., (2010). Tallgrass Prairie Restoration in the Midwestern and Eastern United States, Springer
- Grbić, M. (2003). Seed Dormancy and Germination – Mechanisms, Clasifications and Practices. Glasnik Šumarskog fakulteta 87: 25-49.
- ISTA - International Rules for Seed Testing (1985). Adopted at the 20th International Seed Testing Congress, Canada.
- Kuzovkina, Y., Campanelli J., Schulthess C.P., Ricard R., Dreyer G. (2016). Effective Establishment of Native Grasses on Roadsides in New England. New England Transportation Consortium.
- Samuels T.M. (2005). A Georgia Native Plant Guide. Mercer University Press, USA.
- Steiner L.M. (2005). Landscaping with Native Plants of Minnesota, Voyageur Press, USA.
- <http://www.europe-aliens.org/speciesFactsheet.do?speciesId=1862#> Accessed on 8/3/2016



## IMPACTS OF LIMING AND FERTILIZATION ON YIELD OF TWO TRITICALE VARIETIES

Milan BIBERDŽIĆ<sup>1\*</sup>, Saša BARAĆ<sup>1</sup>, Danijela PRODANOVIĆ<sup>1</sup>, Aleksandar ĐIKIĆ<sup>1</sup>, Vera ĐEKIĆ<sup>2</sup>, Dragana LALEVIĆ<sup>1</sup>

<sup>1</sup>University in Prishtina, Faculty of Agriculture, Kopaonička bb, 38232 Lešak, Serbia

<sup>2</sup>Small Grains Research Center, Save Kovacevica 31, 34000 Kragujevac, Serbia

\*Corresponding author: mbiberdzic@gmail.com

### Abstract

Acid soils have unfavorable physic-chemical properties. The aim of this study was investigate the impact of mineral, lime and organic fertilizers on grain yield of triticale on pseudogley. Investigations were carried out in the vicinity of Kraljevo (Serbia) during the 2011/2013. In the trial two varieties of triticale and 10 fertilization variants (V1-N<sub>35</sub> P<sub>60</sub> K<sub>60</sub>, V2-N<sub>60</sub> P<sub>100</sub> K<sub>100</sub>, V3- N<sub>35</sub>P<sub>60</sub>K<sub>60</sub> + 2.5 t/ha CaCO<sub>3</sub>, V4- N<sub>60</sub>P<sub>100</sub> K<sub>100</sub> + 2.5 t/ha CaCO<sub>3</sub>, V5- N<sub>35</sub>P<sub>60</sub>K<sub>60</sub> + 5 t/ha CaCO<sub>3</sub> and V6- N<sub>60</sub>P<sub>100</sub>K<sub>100</sub> + 5 t/ha CaCO<sub>3</sub>, V7- N<sub>35</sub>P<sub>60</sub>K<sub>60</sub> + 2.5 t/ha CaCO<sub>3</sub> + 20 t ha<sup>-1</sup> manure, V8- N<sub>60</sub>P<sub>100</sub>K<sub>100</sub> + 2.5 t/ha CaCO<sub>3</sub> + 20 t ha<sup>-1</sup> manure, V9- N<sub>35</sub>P<sub>60</sub>K<sub>60</sub> + 5 t/ha CaCO<sub>3</sub> + 20 t ha<sup>-1</sup> manure i V10- N<sub>60</sub>P<sub>100</sub>K<sub>100</sub> + 5 t/ha CaCO<sub>3</sub> + 20 t ha<sup>-1</sup> manure) were included. The resulting data were analyzed using the analysis of variance. The application of all the variants of fertilization has led to a significant increase of grain yield compared to the control. The highest average yield of 4750 kg ha<sup>-1</sup> was achieved at the variant with the highest dose applied mineral, lime and organic fertilizers. The average yield achieved using only triticale fertilizers was 2809 kg ha<sup>-1</sup>. Average yield triticale achieved by using a combination of mineral and lime fertilizers was 3726 kg ha<sup>-1</sup>. Combination of mineral, lime and organic fertilizers achieved average yields grain of triticale of 4463 kg ha<sup>-1</sup>. The use of lime and organic fertilizers in combination with the mineral, the acid soils can achieve a satisfactory yield of triticale.

**Key words:** *mineral fertilization, organic fertilization, pseudogley, yield, triticale.*

### Introduction

Villegas *et al.* (2010) point out that triticale is the first artificially created crop due to crossbreeding of wheat and rye. It aimed at combining the desirable characteristics of the parents. Triticale appeared as an interesting crop, suitable for less favorable agroecological conditions and conditions when the production of wheat or rye is limited (Estrada-Campuzano *et al.*, 2008 and Lalević *et al.*, 2012). Estrada-Campuzano *et al.* (2012) they point out that new varieties of triticale are more fertile and well-adapted to the conditions of the soil and the environment in relation to wheat. Samner and Noble (2003) they emphasize that soil acidity is one of the limiting factors of successful plant production and that there are around 4 billion hectares of acidic land in the world, which represents about 30% of the area. Acidity of soil often affects agricultural production, slows down growth, absorbs water and nutrients, which leads to a decrease in the yield of cultivated plants (Sumner *et al.*, 1986). Beckie and Ukrainetz (1996) point out that the weak growth of plants on acid soils can be the result of the presence of phytotoxic substances in a solution such as Al and Mn that cause defects of P, Ca and Mg and reduce the intake of nutrients. The application of N, P and K on acidic soils is of great importance for increasing yields, although they are poorly exploited on these soils (Rashid *et al.*, 2007). Prado *et al.* (2007) and Alvarez *et al.* (2009) note that the lime has long been known as the main material for improving the productivity of mushroom soil and shows

a positive reaction to crops due to the alleviation of poor production characteristics of acidic soils. The use of organic fertilizers, such as green manure and harvest residues, significantly influences the improvement of the soil structure, the increase in productivity of the soil, the reduction of erosion, and the like (Janusiene, 2000).

The aim of our research was to determine the yield of triticale grown on acid soil, depending on the fertilization with mineral, lime and organic fertilizers.

### Materials and Methods

The research was conducted in the vicinity of Kraljevo (Serbia) during the 2011/2013. The trial, in addition to two varieties of triticale (KG-20 and Odisej), control (V0) and ten variants of different combinations (V1-V10) of NPK, liming with CaCO<sub>3</sub> and farmyard manure (FYM) were applied (Table 1).

So there were two variants of only mineral fertilizers (V1- V2), four variants of both mineral and lime fertilizers (V3- V6), and finally four variants consisted of mineral, lime and manure fertilizers, together (V7- V10). Mineral fertilizers were represented with NPK fertilizer, lime with CaCO<sub>3</sub> and organic with manure.

The trial was set according to a block system in three repetitions. Before the basic land cultivation, mineral, lime and manure fertilizers were distributed on the soil surface, and then ploughed in. Other half of nitrogen fertilizer was used in top dressing in a form of ammoniacal nitrogen. Basic land cultivation was carried out in a classic way, on 25 cm depth. Sowing was carried out in October. Harvest was carried out in the phase of dead ripe, and yield was corrected on 14% of moisture. Results were presented as an average of two years experiment and analysed with ANOVA.

Table 1. Fertilization treatments of the field experiment

V0-V10: NPK (kg ha <sup>-1</sup> ), lime (CaCO <sub>3</sub> : t ha <sup>-1</sup> ) and farmyard manure (FYM: t ha <sup>-1</sup> )											
	V0	V1	V2	V3	V4	V5	V6	V7	V8	V9	V10
N	0	35	60	35	60	35	60	35	60	35	60
P <sub>2</sub> O <sub>5</sub>	0	60	100	60	100	60	100	60	100	60	100
K <sub>2</sub> O	0	60	100	60	100	60	100	60	100	60	100
Lime	0	0	0	2.5	2.5	5.0	5.0	2.5	2.5	5.0	5.0
FYM	0	0	0	0	0	0	0	20	20	20	20

#### *Soil and climatic conditions*

Soil at Kraljevo location belongs to the pseudogley soil type. This soil has very bad physical properties (compacted, having high content of silt and clay particles, with slow water percolation) and extremely acid pH value (pH<4.5). Its total humus content is relatively fair, but microbiological activity is low, because of its poor physical properties. That causes low mineralization of organic nitrogen, and so nitrogen fertilizers show a great effect on such soils. It is characterized by low content of available phosphorus (6.70-6.90 mg/100g of soil) and potassium (7.80-9.80 mg/100g of soil). In table 1 are shown chemical properties of the soil.

Table 2. Chemical properties of the soil

Depth (cm)	pH		Humus (%)	Available (mg/100g of soil)	
	H <sub>2</sub> O	nKCl		P <sub>2</sub> O <sub>5</sub>	K <sub>2</sub> O
0-20	5.24	4.34	3.90	6.70	7.80
20-40	5.55	4.48	3.13	6.90	9.80

Average monthly temperature of air, u 2011-12 were slightly lower, especially in January and February, compared with 2012-13. However, in both years, temperatures ranged as optimal and did not have a negative impact on yield. Higher precipitation and their better distribution were noted in the 2012/13 year, especially in October, November and December, which contributed to a better application and the decomposition of fertilizers applied and thus and higher yields. Average temperature and total precipitation was at the level of long-term averages, with the exception of 2011/2012 year where total precipitation was slightly less (table 3.).

Table 3. Precipitation (mm) and mean air-temp. (°C) in Kraljevo

Precipitation (mm) and mean air-temp. (°C) in Kraljevo										
	Oct	Nov	Dec.	Jan.	Feb.	Mar.	Apr.	May	June	Oct-June
The 2011/2012 growing season										
mm	30.4	1.7	63.7	107.1	54.9	24.5	69.1	105.5	17.8	474.7
°C	10.4	3.2	3.3	-0.1	-4.2	8.8	12.7	16.0	23.1	8.1
The 2012/2013 growing season										
mm	56.7	11.1	97.6	95.4	48.7	56.7	73.2	90.3	13.8	553.5
°C	13.7	9.1	0.4	1.2	1.9	8.4	13.4	17.0	24.4	9.9
Average 1961-1990										
mm	46.7	30.8	58.4	99.4	52.7	58.4	79.3	92.8	49.0	567.5
°C	11.3	5.3	1.9	1.4	0.8	7.4	11.9	15.8	23.3	8.8

## Results and Discussion

The goal of each production is to achieve high yields. The yield of triticale grains depends on several factors, such as variety, agro-climatic conditions, agro-technology. Fertilization is a very important agrotechnical operation, especially on lands of poor chemical and physical properties. The following table (table 4.) gives an overview of the yield of triticale depending on the fertilization of acidic soils and variety.

Higher quantities of precipitation and better distribution in 2012/2013 caused higher yields of triticale in that year. The varieties did not differ significantly from the average yield of grain. Varieties of fertilizers did not significantly affect the differences in grain yield between varieties. Only, at the highest doses and combinations of mineral, lime and organic fertilizers, the Odyssey variety had a yield that was higher on the border of statistical significance than KG-20. Thus, the Odyssey variety had the highest yield of 5010 kg ha<sup>-1</sup> on variant 10, where the highest dose of mineral, lime and organic fertilizers was applied. It is evident that the Odyssey variety responded positively to the yield on larger doses of fertilizers.

All varieties of fertilization showed a significant increase in grain yield relative to control. The average yield for both varieties grew with increasing dosage and type of fertilizer. Thus, the highest average yield of 4750 kg ha<sup>-1</sup> was achieved in variant 10 where the highest dose of mineral, lime and organic fertilizers was applied, and the smallest in variant 1 where a lower dose of mineral fertilizers was applied.

Table 4. Impact of fertilization on yield of two triticale varieties

B. Varieties	A.Variants of fertilizing										
	V0	V1	V2	V3	V4	V5	V6	V7	V8	V9	V10
The 2011/2012 growing season: grain yield of triticale (kg ha <sup>-1</sup> )											
Kg-20	1270	2356	2812	3286	3490	3574	3740	3960	4020	4320	4485
Odisej	1352	2332	3140	3470	3686	3676	3820	4055	4471	4870	4910
The 2012/2013 growing season: grain yield of triticale (kg ha <sup>-1</sup> )											
Kg-20	1550	2440	3280	3680	3770	3870	4020	4270	4390	4340	4495
Odisej	1680	2700	3410	3650	3860	4010	4000	4285	4525	4890	5110
Grain yield of triticale (kg ha <sup>-1</sup> ): 2-year averages											
Kg-20	1410	2398	3046	3483	3630	3722	3880	4115	4205	4330	4490
Odisej	1516	2516	3275	3560	3773	3843	3910	4170	4498	4880	5010
Average	1463	2457	3161	3522	3702	3783	3895	4143	4352	4605	4750
	A (fertilization)			B (Variety)				Interaction AxB			
LSD	5%		1%		5%		1%		5%		1%
	415.7		620.9		410.3		570.5		560.4		708.6

By combining mineral and lime fertilizers, the average yield was significantly higher than the yield achieved using only mineral fertilizers. Also, by using a combination of mineral, lime and organic fertilizers, the yield was significantly higher than the yield obtained using the combination of mineral and lime fertilizers, ie very significantly higher than the yield obtained using only mineral fertilizers.

The average yield of triticale was achieved using only mineral fertilizers was 2809 kg ha<sup>-1</sup>, using a combination of mineral and lime fertilizers 3726 kg ha<sup>-1</sup> and using a combination of mineral, lime and organic fertilizers 4463 kg ha<sup>-1</sup> (Figure 1).

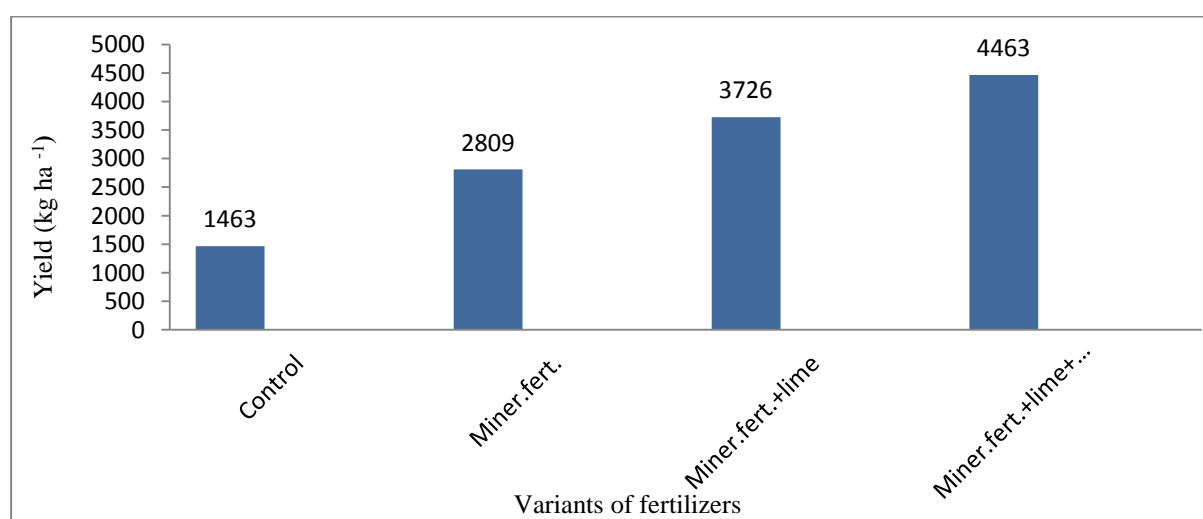


Figure 1. Triticale yield ( kg ha<sup>-1</sup>) depending on the mineral fertilizer, lime and organic fertilizers

These differences in yield are statistically significant.

The results of numerous authors in the country and abroad (Scott *et al.*, 2001; Kaitibie *et al.*, 2002; Kovačević *et al.*, 2006; Jelić *et al.*, 2013; Biberdžić *et al.*, 2013, 2015) show that the application of lime fertilizers in combination with the organic and mineral, the most efficient way to repair acidic soils and increase the yield of cultivated plants, with which our results are in agreement.

### Conclusion

Based on the results of the research, the following can be concluded:

There were no significant differences in grain yield between varieties.

The application of all varieties of fertilization has led to a significant increase in yield of grain in relation to control.

The highest average yield of triticale grains achieved in the variant where the highest dosage of mineral, lime and organic fertilizers was applied.

The average yield of triticale with only mineral fertilizers was 2809 kg ha<sup>-1</sup>.

The average yield of triticale was achieved using a combination of mineral and lime fertilizers amounted to 3726 kg ha<sup>-1</sup>.

Using the combination of mineral, lime and organic fertilizers, average yield of triticale of 4463 kg ha<sup>-1</sup> was achieved.

Using lime and organic fertilizers in combination with mineral, acidic soils, satisfactory yields of triticale grains can be achieved.

### Acknowledgement

The investigation published in this paper is a part of the project “The development of new technologies of small grains cultivation on acid soils using contemporary biotechnology” financed by the Ministry of Education and Science of the Republic of Serbia, grant No TR-31054.

### References

- Alvarez, E., Viade, E., Fernandez-Markos, M. L. (2009): Effect of liming with different sized limestone on the forms of aluminium in a Galician soil (NW Spain). *Geoderma*, 152: 1-8. DOI: 10.1016/j.geoderma.2009.04.011.
- Beckie, H. J., Ukrainetz, H. (1996): Lime-amended acid soil has elevated pH 30 years later. *Can. J. Soil Sci.*, 76: 59-61. DOI: 10.4141/cjss96-009.
- Biberdžić Milan, Jelić Miodrag, Maksimović Goran, Barać Sasa, Stamenković Svetomir, Lalević Dragana (2013): Effect of Acid Soil Fertilization on Morphological and Productive Characteristics of Triticale. *Book of Proceedings. IV International Symposium „Agrosym 2013“*, p. 226-231.
- Biberdžić M., Jelić M., Barać S., Stojković S., Beković D., Jovović Z., Lalević D. (2015): Yield of Winter Barley Depending on Fertilizing Sistem of Acid Soils. *Proceedings of the Fifth International Conference. Research People and Actual Tasks on Multidisciplinary Sciences. Vol.1.*, p.83-88. Lozenec. Bulgaria.
- Estrada-Campuzano G., Miralles D. J., Slafer G. A. (2008): Genotypic variability and response to water stress of preand post-anthesis phases in triticale. *European Journal of Agronomy*, 28 (3): 171–177 <http://dx.doi.org/10.1016/j.eja.2007.07.005>.
- Estrada-Campuzano G., Slafer G. A., Miralles D. J. (2012): Differences in yield, biomass and their components between triticale and wheat grown under contrasting water and nitrogen environments. *Field Research*, 128: 167- 179 <http://dx.doi.org/10.1016/j.fcr.2012.01.003>.

- Janusiene V. (2000): The effect of different types of manure on the content and qualitative composition of humus in a soddy-podzolic sandy loam soil. *Agriculture*. Vol. 71, p. 202-212 (in Lithuanian).
- Kaitibie, S., Epplin, F. M., Krenzer, E. G., Jr., and Zhang, H. (2002): Economics of lime and phosphorus application for dual-purpose winter wheat production in low-pH soils. *Agron. J.* 94, 1139–1145.
- Kovačević, V., Banaj, D., Kovačević, J., Lalić, A., Jurković, Z., Krizmanić, M. (2006): Influences of liming on maize, sunflower and barley. *Cereal Research Communications*, 34, (1), 553-556.
- Lalević D., Biberdžić, M., Jelić, M. & Barać, S. (2012). The characteristics of triticale cultivated in rural areas. *Agriculture and Forestry*, 58(2), 27-34.
- Miodrag Jelic, Goran Dugalic, Jelena Milivojevic, Vera Djekic (2013): Effect of Liming and Fertilization Yield and Quality of Oat (*Avena sativa* L.) on an Acid Luvisol Soil. *Romanian Agricultural Research*, No. 30, Print ISSN 1222-4227; p. 249-258. Online ISSN 2067-5720.
- Prado, R.M., Natale, W., Rozane, D.E.(2007): Soil liming effects on the development and nutritional status of the carambola tree and its fruit-yielding capacity. *Commun. Soil Sci. Plan.*, 38: 493-511. DOI: 10.1080/00103620601174536.
- Rashid, M., A. M. Ranjha, M.A., Waqas, M., Hannan, A., Bilal, A., Saeed, A., Zafar, M., (2007): Effect of P fertilization on yield and quality of oat (*Avena sativa* L.) fodder on two different textured calcareous soils. *Soil and Environ.*, 26: 33-41.
- Scott, B. J., Fisher, J. A., and Cullins, B. R. (2001): Aluminum tolerance and lime increase wheat yield on the acidic soils of central and southern New South Wales. *Aust. J. Exp. Agric.* 41, 523–532.
- Sumner, M.E., Shahanden, H., Bouton, J., Hammel, J. (1986): Amelioration of an acid soil profile through deep liming and surface application of gypsum. *Soil Sci. Soc. Am. J.*, 50: 1254-1258.
- Sumner, M. E., and Noble, A. D. (2003): Soil acidification: The world story. In “*Handbook of Soil Acidity*” (Z. Rengel, Ed.), pp. 1–28. Marcel Dekker, New York.
- Villegas D., Casadesus J., Atienza S., Martos V., Maalouf F., Karam F., Aranjuelo I., Nogues S. (2010): Tritordeum, wheat and triticale yield components under multi-local mediterranean drought conditions. *Field Crops Research*, 116: 68–74 <http://dx.doi.org/10.1016/j.fcr.2009.11.012>.

## PLANT HEIGHT AND GRAIN YIELD OF MAIZE IN DIFFERENT CROPPING SYSTEMS

Milena SIMIĆ<sup>1\*</sup>, Igor SPASOJEVIĆ<sup>1</sup>, Vesna DRAGIČEVIĆ<sup>1</sup>, Dušan KOVAČEVIĆ<sup>2</sup>, Željko DOLIJANOVIĆ<sup>2</sup>, Milan BRANKOV<sup>1</sup>

<sup>1</sup>Maize Research Institute „Zemun Polje“, Belgrade, Serbia

<sup>2</sup>University of Belgrade, Faculty of Agriculture, Belgrade, Serbia

\*Corresponding author: smilena@mrizp.rs

### Abstract

Cropping systems are basically defined by crop rotation. Two crop rotations with winter wheat or three crop rotations with legume crops are the more efficient for maize productivity. When grown in a crop rotation system, maize produces higher biomass, larger leaf area and larger height. Grain yields are also higher and one can also notice other positive effects on agro-ecosystem, including soil and pests. The objective of the study was to evaluate the effects of the cropping systems, namely continuous cropping, two and three crop rotations of maize, on plant height and grain yields and to analyse relations between those two parameters. The study was conducted in an experimental field of the Maize Research Institute Zemun Polje, in Serbia, during 2009-2012. The following factors were evaluated: 1. cropping system of maize - continuous cropping, maize-winter wheat, maize-soybean-winter wheat and maize-winter wheat-soybean rotation; 2. type of hybrid - ZP677 as an older hybrid and ZP606 as a newer, modern hybrid with higher yield potential. The standard technology of maize production was applied. Every year, in the anthesis stage when plants are completely developed, plant height was measured from ten plants per elementary plot while grain yields of maize were determined from two inside rows at the end of the growing season. The data were processed by ANOVA. The grain yield of both maize hybrids was higher when maize was grown in two and three crop rotations in comparison to maize continuous cropping. Newly developed hybrid ZP606 had, on average, a higher yield than ZP677, especially in maize - w. wheat - soybean rotation (8.02 and 10.14 t ha<sup>-1</sup>). The correlation analysis showed high and positive interdependence between plant height and grain yield of maize in all the investigated cropping systems.

**Key words:** *Crop rotation, Maize hybrid, Plant height, Yield.*

### Introduction

The cropping systems are basically defined by crop rotation. Two crop rotations with winter wheat or three crop rotations with winter wheat and legume crops are more efficient for maize productivity. Due to specialisation in agricultural production in Serbia, manure has become less available and mineralised organic matter has to be compensated from other sources. Modifications in cropping systems that increase frequency of legume crops are the most rational method. The presence of plants from the family Fabaceae family significantly contributes to the efficiency of the crop rotation through the reduction of mineral nitrogen fertilizers by 50%, maize yield increase and soil preservation and improvement (Videnović et al., 2007; Jovanović et al., 2004). The advantages of crop diversification lie in less frequent tillage and thereby energy saving, lower amount of applied fertilizers and herbicides and agroecosystem preservation (Spasojević, 2014; Simić et al., 2016). Results from previous investigations showed that crop rotations, especially three crop rotations, reduces number of

individuals and biomass of weeds in maize field more than continuous cropping or six crop rotation (Dolijanović et al., 2011).

When grown in a crop rotation system, maize produces higher biomass, larger leaf area and larger height (Verhulst et al., 2011). Grain yields are also higher and one can also notice other positive effects on agro-ecosystem, including soil and pests. Three crop rotations with legume crop are very effective in maize height and grain yield production (Boomsma et al., 2010). Crop rotation and soil tillage systems influences physical and chemical properties of soil in the root zone which is positively reflecting on maize growth (Martinez et al., 2008).

The objective of the study was to evaluate the effects of the cropping system, namely continuous cropping, two and three crop rotations of maize, on plant height and grain yields and to analyse relations between those two parameters.

### **Material and Methods**

The study was initiated in MRI Zemun Polje, in Serbia, during 2009-2012, with the aim to evaluate the effects of different production systems on maize growth and grain yield. The soil type at the experimental field was slightly calcareous chernozem with 53% sand, 30% silt, 17% clay; with good fertility and 3.3% of organic matter content and moderate drainage. The pH is 6.9 and soil structure is silty clay loam.

The following factors were evaluated: 1. cropping system of maize - continuous cropping (MC), maize-winter wheat (MW), maize-soybean-winter wheat (MSW) and maize-winter wheat-soybean (MWS) rotation; 2. type of hybrid - ZP677 as an older hybrid and ZP606 as a newer, modern hybrid with higher yield potential. The standard technology of maize production was applied. In the autumn of 2008, farmyard manure was applied in all production systems and in MC and MSW every third year, in MW each second year while in MWS rotation farmyard manure was not applied. Additionally, mineral fertilizers were applied in the autumn and during early phases of maize development in the spring. The amounts of mineral fertilizers were determined by the soil analysis. For weed control, herbicide mixture for complete weed control of broadleaf and grass weed species were applied at the recommended doses.

Every year, at the end of the pollination period when plants are completely developed, plant height was measured from ten plants per elementary plot while grain yields of maize were analysed at the end of the growing season. The maize grain yield was measured from two inner rows of each subplot and calculated to 14 % of moisture. The experimental data were statistically processed by analysis of the variance (ANOVA) and analysed by the LSD-test (5%).

#### ***Meteorological conditions***

Meteorological conditions during investigated period were different, (Figure 1). Year 2012 was characterised by the highest average temperature in July and August (27.1 °C and 26.6 °C, respectively). Moreover, the lowest precipitation amount, of only 4 mm was also obtained in August. Present conditions could affect grain filling, reflecting on relative low values of grain yield.

The sum of precipitation was higher in 2009, 2010 and 2014 than in 2008, 2011 and 2012. The 2012 was extremely dry (June - 30.7 mm; August - 5.8 mm and September - 26.0 mm) and unfavourable for maize production. A dry spell during June-September period in 2012 year was especially important since it coincided with maize pollination and yield formation (Figure 1).



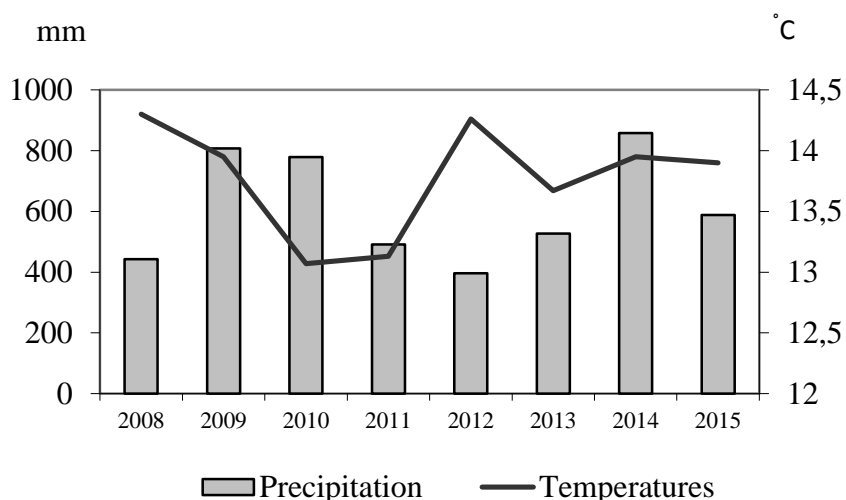


Figure 1. Meteorological conditions 2008-2015

### Results and discussion

Cropping system influenced maize plant height and grain yield after only one rotation, Table 1. In 2011, when maize was sown on the same field after winter wheat, plant height (269.8 and 260.5 cm) was higher for both hybrids than in continuous cropping (247.0 and 253.2). Grain yield was also higher in MW system (9.1 and 10.6 t ha<sup>-1</sup>) than in MC (7.9 and 8.6 t ha<sup>-1</sup>), especially for hybrid ZP606.

Table 1. The effects of crop rotation on plant height and grain yield of two maize hybrids

Crop rotations	Hybrid ZP677		Hybrid ZP606	
	Plant height (cm)	Grain yield (t ha <sup>-1</sup> )	Plant height (cm)	Grain yield (t ha <sup>-1</sup> )
2011.				
MC	247.0	7.9	253.2	8.6
MW	269.8	9.1	260.5	10.6
2012.				
MC	182.9	4.9	180.9	4.8
MSW	201.9	5.2	197.5	7.0
MWS	180.3	5.6	175.8	5.9

In three crop rotations, after one cycle, MSW have shown positive influence on maize height (201.9 and 197.5 cm) in comparison to MC (182.9 and 180.9 cm) while MWS did not (180.3 and 175.8 cm). The similar was with grain yield where both rotations influenced maize yield positively by increasing of yield values in case of hybrid ZP677 while only MSW rotation was suitable for hybrid ZP606.

Relations between plant height and maize yield were positive and significant in both cropping systems-MC and MW for both hybrids (Figure 2). Results from monoculture and three cropping system were even better. The maize plant height and grain yield were highly and positively correlated in MC, MSW and MWS for both maize hybrids (Figure 3). This shows that for investigated hybrids grain yield is influenced by plant height and probably by ear position on the stem. The highest R<sup>2</sup> value - 0.9168 was obtained in MSW rotation for hybrid ZP606.

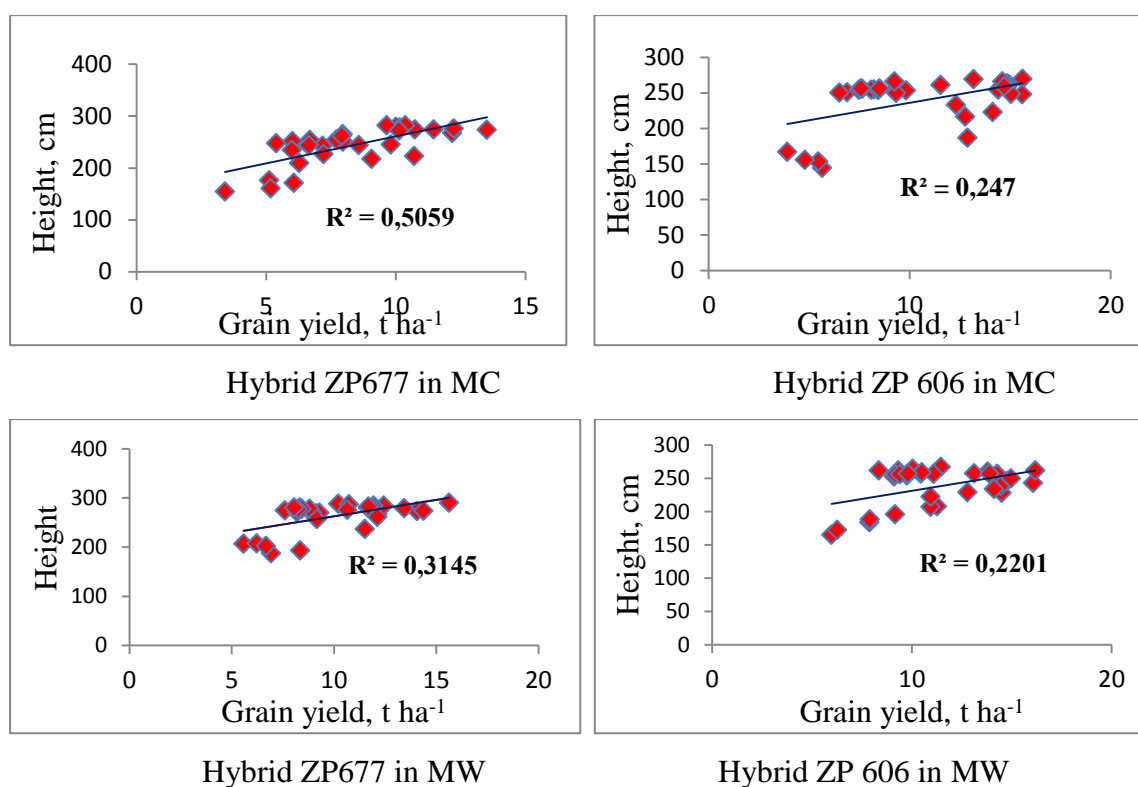


Figure 2. Interactions between plant height and grain yield of maize in continuous cropping and two crop rotation

The period when development of upper and ear leaves of maize plants is completed is very important. The significant relation is obtained between level of development of some morphological parameters of plants and maize grain yield (Raun et al., 2005; Teal et al., 2006). When the maize inbred lines and hybrids were studied, results showed that stem diameter, plant height, ear position on the stem, and dry matter of all plant are significantly related to grain yield (Sadak et al., 2006 cit. Valizadeh and Bahrampour, 2013). In all cropping systems the positive and significant interaction between maize plant height and grain yield were obtained which is in accordance with results of previous studies (Golam et al., 2011). Authors conclude that, beside ear position, the height of whole maize plant significantly correlated with grain yield. Liu and Wiatrac (2011) also noticed significant influence of maize plant height at the stage when upper leaves are developed on grain yield. Regarding to results of previous experiments (Martin and Russell, 1984), maize plant height and ear position are in strong and positive relations with grain yield. Ashofteh Birgi et al. (2010) proved the similar relations between maize grain yield and plant height, ear position and number of rows on the cob. Alaei (2012) received positive and significant correlations between maize plant height and grain yield on the  $P > 0.05$  level while on the  $P > 0.01$  level, the relations were not significant.

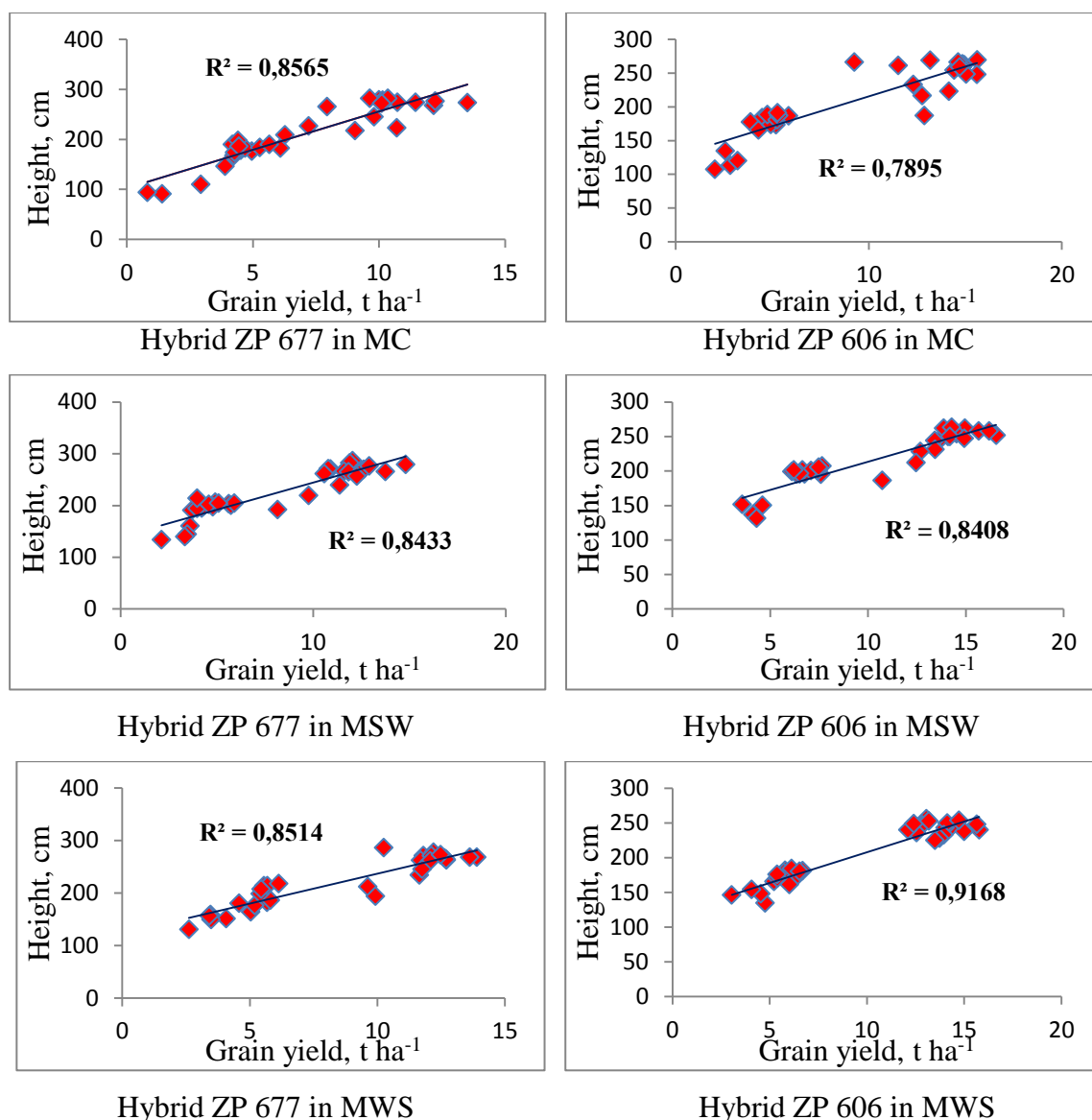


Figure 3. Interaction between plant height and grain yield of maize in continuous cropping and three crop rotations

### Conclusion

The maize plant height and grain yield were highly and positively correlated in maize continuous cropping, maize-soybean-winter wheat and maize-winter wheat-soybean rotation for both maize hybrids, ZP 677 and ZP 606. This shows that for investigated hybrids, plant height and probably by ear position on the stem have influenced grain yield. The values of all measured parameters were the highest in MW rotation which shows that old and the most present cropping system, based on old type of farm ownership and organisation, has advantage in maize production. But, in present time, with new system of farming land organization, crop rotation with legumes as nitrogen source, could be a good substituent and certainly takes advantage over maize continuous cropping.

### **Acknowledgements**

This study was supported by the Ministry of Education, Science and Technological Development of the Republic of Serbia through the project TR31037.

### **References**

- Alaei, Y. (2012): Correlation analysis of corn genotypes morphological traits. *International Research Journal of Applied and Basic Sciences*, 3, 2355-2357.
- Ashofteh Birgi, M., Siahsar, B., Khavari, S., Golbashi, M., Mehdinejad, N., Alizadeh, A. (2010): Investigating the mutual genotypic effects on morphological properties in environment, the yield and the yield components of new varieties of grain corn (*Zea mays* L). *Journal of Agricultural Ecology*, 2, 136-145.
- Boomsma, R.C., Santini, B.J., West, D.T., Brewer, C.J., McIntyre, M.L., Vyn, J.T. (2010): Maize grain yield responses to plant height variability resulting from crop rotation and tillage system in a long-term experiment. *Soil and Tillage Research*, 106(2), 227-240.
- Golam, F., Farhana, N., Zain, M. F., Majid, N. A., Rahman, M. M., Motior, R. M., Kadir, A. M. (2011): Grain yield and associated traits of maize (*Zea mays* L.) genotypes in Malaysian tropical environment. *African Journal of Agricultural Research*, 6, 6147-6154.
- Dolijanović, Ž., Kovačević D., Oljača, S., Simić, M., Jovanović, Ž. (2011): Effects of crop rotation on weed infestation in maize crops. *Proceedings of the 46th and 6th International Symposium on Agriculture*, February, 12-16, Opatija, Croatia, 658-662.
- Jovanović, Ž., M. Vesković, P. Jovin, D. Kovačević (2004): Effect of Different Growing Systems on Maize Yield According to The Concept of Sustainable Agriculture. *Proceedings of the VIIIth ESA Congress*, Copenhagen, Denmark, 611-612.
- Liu, K., Wiatrak, P. (2011): Corn production and plant characteristics response to N fertilization management in dry-land conventional tillage system. *International journal of plant production*, 5, 405-416.
- Martin, M. J., Russel, A. W. (1984): Correlation response of yield and other agronomic traits to recurrent selection for stalk quality in maize synthetics. *Crop Science*, 24, 746-750.
- Martinez, E., Fuentes, J.P., Silva, P., Valle, S., Acevedo, E. (2008): Soil physical properties and wheat root growth under no-tillage and conventional tillage in a Mediterranean environment of Chile. *Soil and Tillage Research*, 99, 232-244.
- Raun, W. R., Solie, J. B., Martin, K. L., Freeman, K. W., Stone, M. L. (2005): Growth stage, development, and spatial variability in corn evaluated using optical sensor readings. *Journal of Plant Nutrition*, 28, 173-182.
- Simić M., Dragičević V., Kresović B., Videnović Ž., Dumanović Z. (2016): Advanced cropping technology of maize (*Zea mays* L.) in Serbia. *Agriculture & Forestry*, 62(1), 227-240.
- Spasojević, I. (2014): The importance of the crop rotation for the increase of maize crop productivity and preservation of the agroecosystem. PhD thesis, University of Belgrade, Faculty of Agriculture, 1-137.
- Teal, R. K., Tubana, B., Girma, K., Freeman, K. W., Arnall, D. B. (2006): In-season prediction of corn grain yield potential using normalized difference vegetation index. *Agronomy Journal*, 98, 1488-1494.
- Valizadeh, H., Bahrapour, T. (2013): Analysis of correlation coefficients between grain yield and its components in average and late-ripening hybrids of grain maize (*Zea mays* L.). *International Journal of Agronomy and Plant Production*, 4, 3377-3383.

- Verhulst, N., Govaerts, B., Nelissen, V., Sayre, D.K., Crossa, J., Raes, D., Deckers, J. (2011): The effect of tillage, crop rotation and residue management on maize and wheat growth and development evaluated with an optical sensor. *Field Crops Research*, 120(1), 58–67.
- Videnović, Ž., Ž. Jovanović, G. Cvijanović, L. Stefanović, M. Simić, 2007. The contribution of science to the development of contemporary maize growing practices in Serbia. In: *Science as sustainable development background*. Maize Research Institute „Zemun Polje“, Belgrade, Serbia, 267 – 285. (In Serbian)
- Videnović Ž., Jovanović Ž., Dumanović Z., Simić M., Srdić J., Dragičević V., Spasojević I. (2013): Effect of long term crop rotation and fertilizer application on maize productivity. *Turkish Journal of Field Crops*, 18 (2), 233-237.

## AN ANALYSIS OF PLUM PRODUCTION IN SERBIA FROM 2005 TO 2016

Milosav GRČAK<sup>1\*</sup>, Dragan GRČAK<sup>1</sup>, Marko AKSIĆ<sup>2</sup>

<sup>1</sup>University of Priština Faculty of Agriculture, Kosovska Mitrovica-Lešak, Serbia

<sup>2</sup>Agricultural pharmacy- Agroaksa, Deveti maj - Niš, Serbia

\*Corresponding author: milosavgrcak@gmail.com

### Abstract

According to the total number of trees and average annual production, the plum has had the leading position among fruit crops in the Republic of Serbia for many years. According to the data on the period from 2005 to 2014, the Republic of Serbia was the second in the world in the production of these fruit crops, right after China. Extremely favorable natural conditions for plum cultivation, among other things, have certainly contributed to the abundance of plums in the Republic of Serbia. However, one can notice that the productive area under this crop has not increased in the past couple of years, which is worrisome. This paper presents an analysis of plum production in the Republic of Serbia, using the index comparison method, i.e. using the statistical data on previous years, comparing them with the data on 2016. The data available on the website of the FAOSTAT statistical database and the Statistical Office of the Republic of Serbia (RZS) were used for the comparison and analysis. The analysis of the available data on the period from 2005 to 2015 showed that the total yield of plums in this period varied, as well as the yield per hectare in tons, ranging from 2.8 to 7.3, depending on the year. However, in 2016, one can notice a slight increase in the total plum production in comparison to 2014 and 2015, while 2013 is still a record year when it comes to yield. The data from these sources differed for certain years, but these deviations of the total yield can be attributed to variations conditioned by the very manner of yield counting, import and export.

**Keywords:** *plum, production, analysis, yield*

### Introduction

If one focuses on the period from 2005 to 2014, based on the FAOSTAT data, one can see that Asia is the world leader in the production of plums with 63.4%. Europe is the second largest producer with 24.9%, followed by North and South America that produce a total of 8.6% of plums in the world market. Africa has a share of 2.9% in the production, while Oceania is at the bottom with only 0.2%. The reason for this dominance of the Asian continent is China, which has a share of 5,538,620 t out of 6,755,726 t, the total weight of plums produced in Asia. These figures are, as already mentioned, an average value in the period from 2005 to 2014. As for the old continent, the plum production in this period has an average of 2,650,880 t. The Republic of Serbia has a share of 20.05%, i.e. 531,405 t and, as such, ranks second in plum production in the world, right after China. A visual presentation of these data is shown in figures 1 and 2. Since the reign of Milos Obrenovic, plums have had great economic significance for Serbia (Michael R. Palairat, 1997). From 1968 to 1977, Yugoslavia had a share of about 18% of the total world production of plums. Today, Serbia is one of the largest producers of plums in the world (Blagojević and Božić, 2012). Serbian climate and soil conditions are extremely favorable for the cultivation of this fruit, so this data has a solid basis (Nikolić *at al.*, 2012). However, what concerns us, and what will directly affect the production of plums in Serbia, is the fact that the production of this type of fruit has

beendecreasing for years, and currently there are no indications for a comprehensive solution to this problem. The objective of this paper is an analysis of the plum production in the Republic of Serbia, which is shown in numbers that represent plum production in recent years, as well as a comparison with the most recent data on the plum production in Serbia.

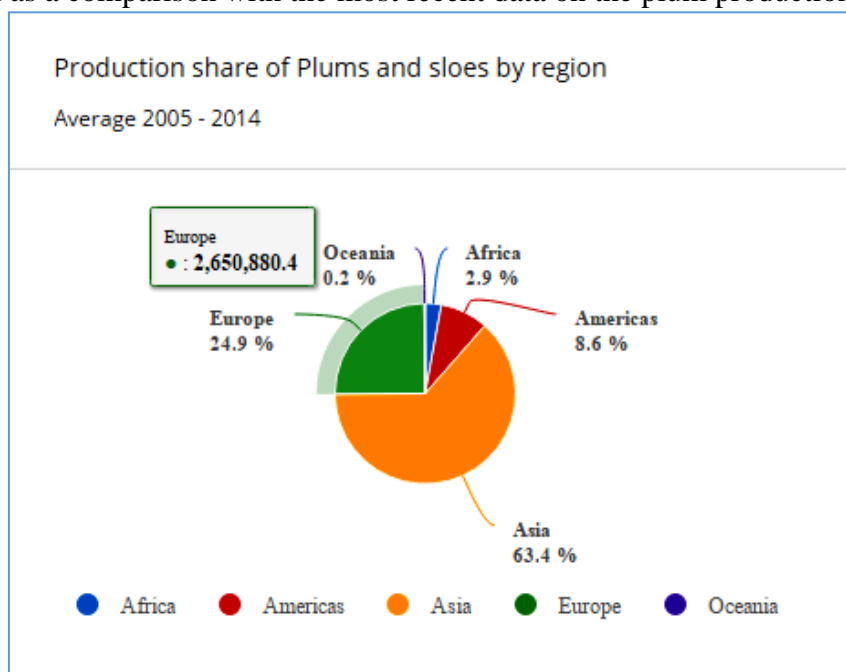


Figure 1. A graphical display of the share in plum production of specific regions in the period from 2005 to 2014, which is available on the FAOSTAT statistical database website.

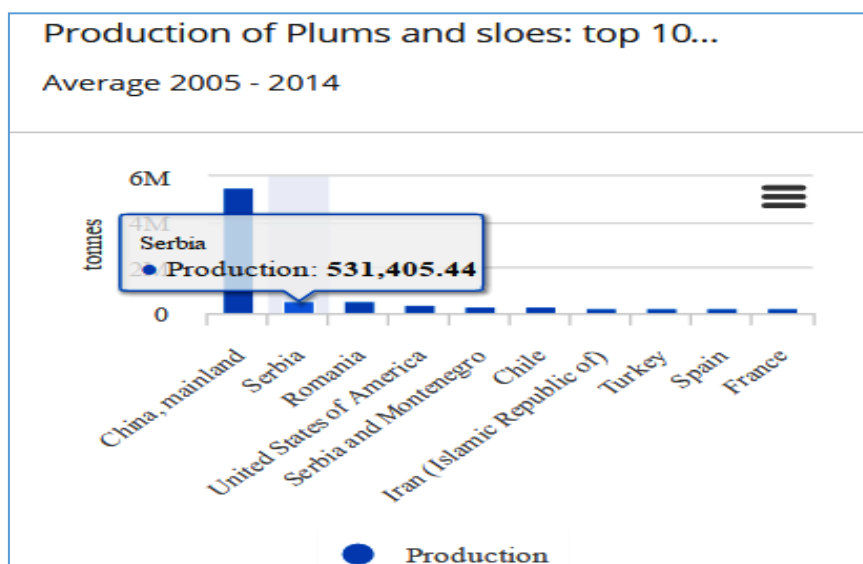


Figure 2. A graphic display of the largest producers of plums in the world in the period from 2005 to 2014, which is available on the FAOSTAT statistical database website.

### Material and methods

According to the data of the Bureau of Statistics of the Republic of Serbia (Table 1), a total plum yield of 463,115 t was found in a productive area of 77,949 ha, while the average yield per hectare was 5.9 t. Out of this, 13.85% of plums were reproduced in the territory of Serbia - North (Belgrade and Vojvodina region), while 86.15% of plums were produced in the

territory of Serbia - South (region of Sumadija, Western, Southern and Eastern Serbia; no data for the autonomous region of Kosovo and Metohija). The data available on the website of the Republic Statistical Office (RZS), as well as the statistical base FAOSTAT, were used for comparison of plum production in recent years with the most recent yield.

Table 1. Plum production in the Republic of Serbia in 2016

2016.	Area harvested (ha)	Production (t)	Yield (t/ha)
Republic of Serbia	77949	463115	5.9
SERBIA - NORTH	5482	64149	11.7
Belgrade region	2507	19908	7.9
Vojvodina region	2975	44241	14.9
SERBIA - SOUTH	72467	398966	5.5
Šumadija and western Serbia	53306	259707	4.9
Southern and eastern Serbia	19161	139259	7.3

### Results and Discussion

An index comparison of the total yield of plums in the Republic of Serbia in recent years (in the interval from 2005 to 2015), which is available on the website of the Republic Statistical Office (RZS), with the last recorded yield from the database of the same website (on 22 February 2017), is presented in Figure 3.

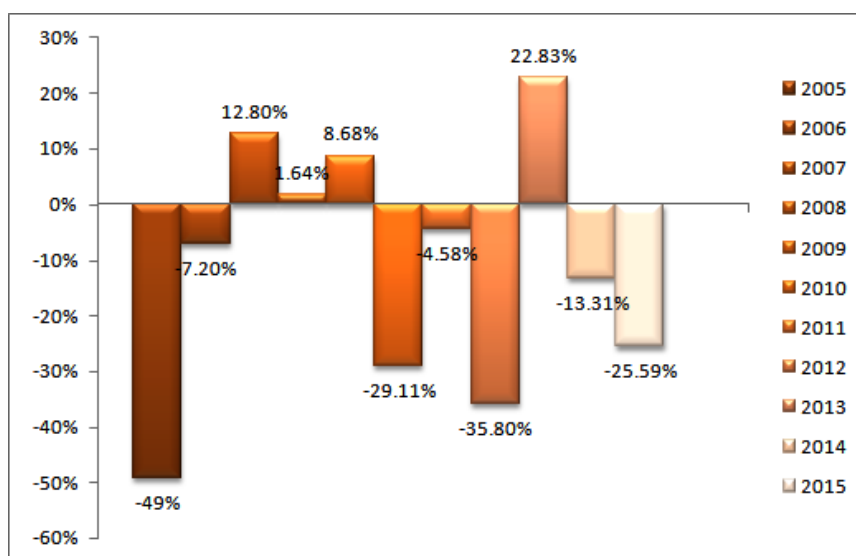


Figure 3. Index display of the total yield of plums in recent years with the current status, which is available on the website of the Republic Institute for Statistics.



Table 2. The data on areas, production and average yields refer to intensive and extensive orchards together. The data are available on the RZS website.

Republic of Serbia (years)	Plum			Population
	Area harvested, ha	Production, t	Yield, t/ha Yield per tree (kg)	
<b>2005</b>	83.560	235.431	2,8 (7)	7.440.769
<b>2006</b>	81.930	429.822	5,2 (13)	7.411.569
<b>2007</b>	81.545	522.366	6,4 (14)	7.381.579
<b>2008</b>	82.407	470.713	5,7 (14)	7.350.222
<b>2009</b>	80.151	503.321	6,3 (15)	7.320.807
<b>2010</b>	80.306	328.285	4,1 (12)	7.291.436
<b>2011</b>	78.663	441.885	5,6 (14)	7.258.753
<b>2012</b>	77.949	297.446	3,8 (11)	7.199.077
<b>2013</b>	77.949	568.840	7,3 (16)	7.164.132.
<b>2014</b>	77.949	401.452	5,2 (13)	7.131.787.
<b>2015</b>	77.949	344.612	4,4 (12)	7.095.383.
<b>2016</b>	77.949	463.115	5,9	<b>7.076.372</b>

Using the index comparison of the total yield of plums in the Republic of Serbia in the period from 2005 to 2015 with the current status, it can be noted that the fluctuations in the results in the given period of observation are relatively large. However, what one can also recognize is some increase in yield in 2016 compared to the two previous years, namely: an increase in the total yield of 25.59% compared to the yield in 2015 and an increase in the yield of 13.31% compared to 2014. In addition to what is stated in Figure 3, the highest total yield was registered in 2013, 22.83% higher compared to the most recent data, while the lowest total yield was registered in 2005, 49% lower compared to the results found in 2016. One can also note from these figures that, compared to 2016, better results regarding the total yield were achieved in the period from 2007 to 2009, as well as in 2013.

From Table 2, one can conclude that the reduction of the productive area under the fruit species was not of crucial importance for the plum yield, although the productive area in 2016 was smaller by 6.7% compared to 2005. In the last 5 years, there have been no changes in this field, but it is a fact that the productive area under plums was steadily decreased in the period from 2005 to 2012, with smaller deviations in 2008 and 2010. According to the data of the Republic Hydrometeorological Service of Serbia on 2015/2016 production year, due to the extremely hot summer and autumn, which was much warmer compared to average conditions, and due to heavy rainfall, conditions for the development of fungal and bacterial diseases were met. In July, a massive hatching of larvae of the second and third generations of the plum moth was registered, but despite all this, the results for 2016 were very favorable, for which timely protection was responsible.

If one looks at Figure 4, which presents information about the total production of plums and sloes in the Republic of Serbia, one can note that there are certain differences in total production between the Statistical Office data and the statistical base FAOSTAT data. The sloe is a fruit species that is grown in small areas in Serbia, so we believe that the data on the FAOSTAT website refer primarily to the plum.

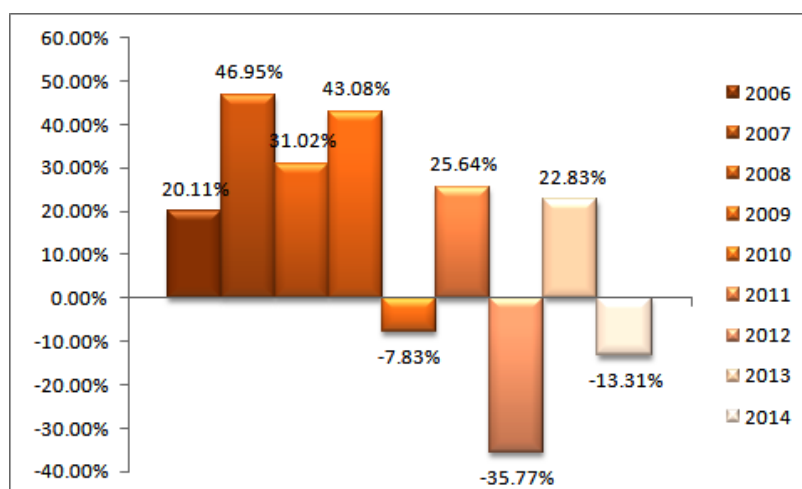


Figure 4. Index display of the total yield of plums for the period from 2006 to 2014, which is available on the FAOSTAT website, with the current status that is available on RZS.

Although the FAOSTAT database currently (22 February 2017) does not possess any data on the production of plums in Serbia before 2006 nor any data after 2014, what one can note is that the FAOSTAT data on the period from 2006 to 2011 are quite different, while the data for the period after 2011 are approximately equal to the data from the Republic Institute for Statistics database. The data on 2014 and 2013 correspond to the data from the RZS database, while the data on the yield in 2012 differ by only 0.03% compared to the data from the RZS database. By observing this index display, one can identify different minimum and maximum values. Unlike the RZS data, based on Figure 4, there is a situation that the maximum total yield was by 46.95% higher in 2007 than the yield registered in 2016. The lowest yield was achieved in 2012, and it was lower by 35.77% compared to the yield in 2016. In Figure 5, the value in tons regarding the yield of plums is presented and the productive area is expressed in hectares. The biggest difference between the FAOSTAT data and the RZS data is for the year 2009, when the yield, according to the FAOSTAT database, was 34.4% higher compared to the RZS data on the same year.

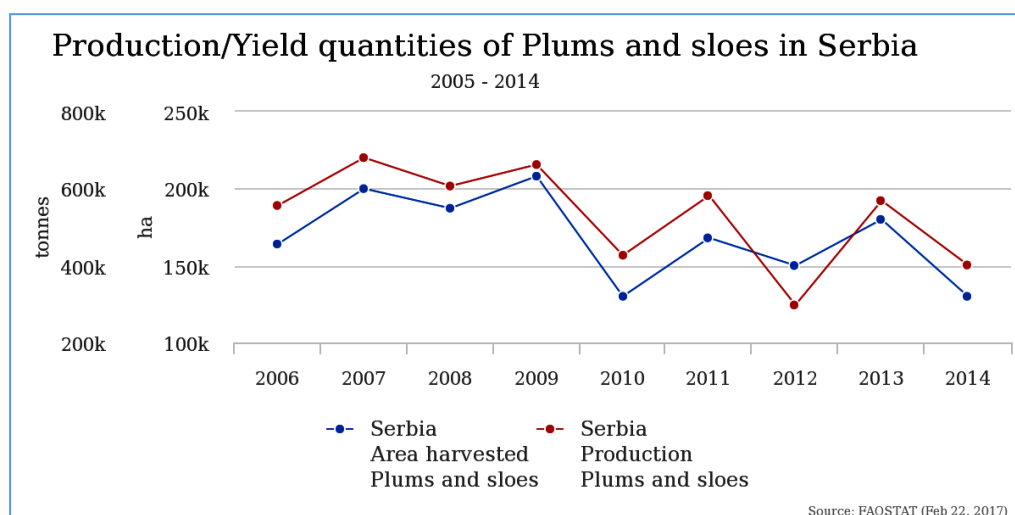


Figure 5. A graphical display of produced plums and sloes, as well as the productive area in the Republic of Serbia for the period from 2006 to 2014, which is available on the FAOSTAT website.

## **Conclusion**

By an index comparison of the total yield of plums in the Republic of Serbia from 2005 to 2014, including the latest yield in 2016, one can notice a slight increase in production compared to the previous two years. A yield of 463,115 t was found in a productive area of 77,949 ha. Although it was not the highest plum yield in Serbia in this crop area, the yield of 2013 was 568,840 t, which showed that the yield was on the rise compared to the previous two years. Certain deviations from the total yield, which can be noted between the different sources in previous years, can be attributed to variations conditioned by the manner of data collection regarding the yield, import and export. In recent years, there has been compliance of the data from these two sources (FAOSTAT and RZS), which is a positive development in this regard.

## **References**

- Blagojević R., Božić V. (2012): „Production technology of plum”. Fruits&Berries. Program of support to private sector development in the field of fruits and berries in South Serbia. Niš, 2012.
- Food and Agriculture Organization of the United Nations for a world without hunger (FAOSTAT): <http://www.fao.org/faostat/en/#data/QC> (access: 22 February 2017 at 21:00)
- Michael R. Palairat (1997): „Merchant Enterprise and the Development of the Plum-Based Trades in Serbia, 1847-1911”. The Economic History Review. New Series, Vol. 30, No. 4 (Nov., 1977), pp. 582-601. Access: 29.1.2017. at 19:2500
- Nikolić D, Keserović Z, Magazin N, Paunović S, Miletić R, Nikolić M, Milivojević J. (2012): Condition and development prospects of fruit growing in Serbia, Paper and Abstract Proceedings. 14th Serbian Congress of Fruit and Grapevine Producers with International Participation, pp. 3-23, 9-12.10.2012, Vrnjačka Banja, Serbia
- Republic Hydrometeorological service of Serbia (RHMZ):  
Republic Institute for Statistics (RZS):  
<http://webrzs.stat.gov.rs/WebSite/Public/PageView.aspx?pKey=139> (access: 22 February 2017 at 20:30)
- Republic Institute for Statistics (RZS): <http://webrzs.stat.gov.rs/WebSite/> (access: 22. February 2017 at 20:10)
- <http://www.hidmet.gov.rs/index.php> (access: 23 February 2017 at 12:00 )
- [https://www.jstor.org/stable/2596008?seq=1#page\\_scan\\_tab\\_contents](https://www.jstor.org/stable/2596008?seq=1#page_scan_tab_contents)

## **IMPACT OF CLIMATE CHANGE ON POTATO YIELD GROWN IN DIFFERENT CLIMATIC ZONE IN BOSNIA AND HERZEGOVINA**

Ružica STRIČEVIĆ<sup>1\*</sup>, Goran TRBIĆ<sup>2</sup>, Mirjam VUJADINOVIĆ<sup>1</sup>, Raduška CUPAĆ<sup>3</sup>,  
Nevenka ĐUROVIĆ<sup>1</sup>, Marija ČOSIĆ<sup>1</sup>

<sup>1</sup>University of Belgrade, Faculty of Agriculture, Nemanjina 6, 11080 Zemun, Serbia

<sup>2</sup>University of Banja Luka, Faculty of Sciences, Mladena Stojanovića 2, Banja Luka, Bosnia and Herzegovina

<sup>3</sup>UNDP Representation Office Banja Luka, Trg Republike Srpske 1/C1, Bosnia and Herzegovina

\*Corresponding author: sruzica@agrif.bg.ac.rs

### **Abstract**

The aim of this paper is to examine the impact of climate change on potato yield and propose adaptation measures for three different climatic areas in Bosnia and Herzegovina (B&H). Aquacrop model V4.0 was used for yield estimation. Input bias corrected data for future climatic parameters were obtained from EBU-POM for IPCC/SRES scenarios A1B and A2, for three time lags early future (2010–2039), mid (2040–2069), and end of century (2070–2099), for three distinct areas Banja Luka, Mostar and Bijeljina. Model calibration was based on available scientific papers. Shorter growing cycle of potatoes on the observed areas is expected in future climatic conditions due to an increase in temperature of air. Slightly shortening of growing cycle till the end of the century can be expected in the Mostar area, and it may even increase on the other ones. Sowing date will be moved towards the winter months. Shorter growing cycle could enable the unrestricted growth of potatoes at all sites, because growth would terminate before the on set of the dry season. Obtained data indicate an increase in the yield of potatoes in relation to the reference period, slight in the area of Banja Luka and Bijeljina, but significant in the Mostar to 13.8% in the near future, 28.7% in mid-century and up to 33% by the end of the century. The largest water shortage might occur in Bijeljina (35%), slightly less in the area of Banja Luka, while irrigation is not primarily in the Mostar area, but timely soil drainage instead.

**Key words:** *climate change, Aquacrop, potato, yield, irrigation.*

### **Introduction**

Enhanced temporal and spatial climate variability was manifested in the last 10 years in Bosnia and Herzegovina (B&H), causing severe droughts (2007, 2011 and 2012) or flooding (2009, 2010 and 2014) and consequently significant material damage in crop production. Many researches has estimated further climate instability in the Southeast Europe throughout the 21<sup>st</sup> century (Senevirante et al., 2006; IPCC, 2014; Jacob et al., 2014) emphasizing that agricultural production would be the most vulnerable (Trbić et al., 2014; Mihailovic et al., 2015). In such changeable weather condition unconstrained crop production depends mainly on water resources management but also on the preparedness of a timely application of adaptation and mitigation measures. Proper preparedness should be based on lesson learned through the historical period, reliable risk approach, and use of crop growth modeling for yield and water management estimation and optimization. Impact of climate change on yield and water requirement of staple food crop has not been widely studied in B&H, only few researches have been done on maize (Stojaković et al., 2015), due to the reasonable restrictions. Namely, for the application of crop growth modeling many reliable input data from experimental researches is needed. Such data are hard to find due to the war. Researches

in surrounding countries confirmed possible impact on climate change on main field crops such as maize, soybean, wheat or sugar beet (Vučetić, 2011, Lalić et al., 2013; Stričević et al., 2014). Since potato is one of the main staple crop with shallow root system, which yield might be affected either by heat, drought or water logging, the aim of this research is to examine the impact of climate change on potato yield and propose adaptation measures for three different climatic areas in Bosnia and Herzegovina (B&H).

### **Materials and methods**

In this research AquaCrop v4.0 model was used for the yield, sowing date and water requirement estimation. This model is water driven, based on water productivity, which means that yield mainly depends on water availability, taking into account temperature and soil fertility stress as limiting factor that might affect the final yield. The model was described in details by Steduto et al., (2009) and Raes et al., (2009). Input climatic data for the three distinct area Banja Luka, Mostar and Bijeljina on a monthly bases for the AquaCrop model was grouped into five section: reference period (1961-1990), current weather condition (2004-2013) (Hydro-meteorological services in Banja Luka; Federal hydrometeorological Service B&H) and the bias corrected data for future climatic parameters were obtained from the regional climate model EBU-POM (Eta Belgrade University - Princeton Ocean Model) (Djurdjević and Rajković, 2008; Gualdi et al., 2008). Initial and boundary conditions were taken from the global model ECHAM5, and the domain of integration covered the Euro-Mediterranean area with the Mediterranean Sea (without the Black Sea). The spatial resolution of atmospheric part of the model was 0.25 ° (about 30 km) and for ocean 0.2 °. Two climate scenarios IPCC SRES A1B and A2 for time slices in the future, centered on the 2020s (2010-2039), the 2050s (2040-2069) and the 2080s (2070-2099) were considered. AquaCrop model calibration was based on available scientific researches and studies (Ćota and Šilj, 2012; Govedarica et al., 2016; Biancalani et al., 2004; Group of authors, 2014). As the technology of cultivation during the reference period (1961-1990.) differed significantly from contemporary ones, the yield simulation was performed for the period 2004 - 2013. Comparison of the obtained results is given as a relative ratio, for example, the possible yield of the climatic conditions during the reference period and the yield of expected future climate conditions during a given scenario, on the same soil and the agronomical practices. The yields ( $\text{tha}^{-1}$ ) could not be compared, because in one experimental field in the course of one year, very different yields were achieved due to the variety, crop density, planting date, growing technology, and so on (Žurovec and Čadro, 2011; Ćota and Šilj, 2012). Such approach was used by other researchers (Bird et al., 2016; Linker et al., 2016).

### **Results and discussion**

Potato growth simulations were run for the sowing optimal time taken from the recorded data (Phenological yearbook, 2004-2014, Hydrometeorological Services for each studied area) which coincide when  $T_{\min}$  fixed at 7 °C for 7 successive days. The obtained sowing dates were in the last decade of 22<sup>th</sup> March in Banja Luka, mid March in Bijeljina and mid to late February in Mostar area, which is in agreement with the current field management practices. Shorter growing cycle of potatoes on the observed areas is expected in future climatic conditions due to an increase in air temperature (Table 1). Current growing season is already shorter for 10 days in the Mostar and Bijeljina and 20 days in the Banja Luka area (2004-2013.) in comparison with reference one. Slight shortening of growing cycle might be expected in the Mostar area until the end of the century, and may even increase on the other areas in regard to actual ones. It should be emphasized that the sowing dates would be

significantly moved towards the winter months (Table 2), due to the expected air temperature increment. An average daily temperature above 7 °C, as favorable conditions for potato planting is expected to be from the end of January to mid-February. Earlier sowing dates and shorter growing cycle will enable the smooth growth of potatoes at all areas and will senesce and mature before the onset of the dry season. The similar results of growth shortening due to temperature increase was obtained in European part of Russia (Novikova et al., 2017), suggesting the same adaptation measures.

Obtained results indicate even an increase in the yield of potatoes in comparison with the reference period (Table 4). Slight increment is expected in the area of Banja Luka (0 - 9.5%) and Bijeljina (from 2.3 - 6.9%), by the 2080s, but significantly in the Mostar area up to 13.8% in the near future, and then up to 28.7% by the 2050s and up to 33% by the 2080s. The only prerequisite in the Mostar area is ensuring a good drainage that can enable soil warming and early planting of potatoes. Obtained results are in accordance with finding of Peltonen-Sainio et al., (2010) studying the long term historical data set on potato yield across the Europe. They emphasize that potato is very prone to react in yield reduction due to any weather anomaly, but also if well supplied by water with favourable temperature could increase yield. Lizana et al., (2017) studied impact of increased temperatures on potato yield. They obtained significant increment of the potato yield when occurred during beginning and mid tuber bulking period and no changes if occurred later. They also emphasized that yield sensitivity was highly dependent on genotype, as it was obtained in B&H (Ćota and Šilj, 2012).

Irrigation of potato should be planned, too. It would enable achievement of genetically potential yield on researched areas. Beside ensuring readily available water to the potato, irrigation affect favourable micro climatic condition. In last few years, irrigation is used not only to provide water to the root system, but also to cool the top soil up to desirable level to assure desirable quality.

The highest increment of water shortage (Table 4) will occur in the Bijeljina region (up to 35%), slightly less in Banja Luka area, whereas in the Mostar, drainage will be primordial measure, not irrigation (Table 5). The area prone to water logging nowadays will continue to under threat of water excess such as Mostar and Herzegovina in general. Whole this region will have favourable climate for potato, but only if drainage channels would be well maintained. These results are somehow expected, due to early sowing dates and avoiding drought period by shorter growing cycle of potato. On another side, the biggest worries for farmers will be the frost that can harm or kill the plants or even snow occurrence, as it was on spring of 2016 or this year. Irrigation system could be designed also to be used as anti-frost mitigation measure, but threat from snow will be farmer's crucial concerns.

Table 1. Growing cycle of potato in different scenarios and locations

Period\Area	Banja Luka		Bijeljina		Mostar	
1960-1990	142		133		130	
2004-2013	107		123		121	
IPCC Scenario	A1B	A2	A1B	A2	A1B	A2
2010-2039	130	129	126	126	119	117
2040-2069	130	125	127	127	117	118
2070-2099	122	124	122	120	117	113

Table 2 Sowing period of potato in different scenarios and locations

Period\Area	Banja Luka	Bijeljina	Mostar
1960-1990	22 March	17 March	20-Feb
2004-2013	20 March	17 March	15-Feb

IPCC Scenario	A1B	A2	A1B	A2	A1B	A2
2010-2039	7 Feb	12 Feb	18 March	16 March	7 Feb	12 Feb
2040-2069	8 Feb	5 Feb	4 March	3 March	8 Feb	5 Feb
2070-2099	28 Jan	2 Feb	21 Feb	23 Feb	28 Jan	2 Feb

Table 3. Change of potato yield (%) by the IPCC scenarios and studied areas in comparison with reference period

Period\ Area	Banja Luka		Bijeljina		Mostar	
2004-2013	-13.0		11.5		9.1	
IPCC Scenario	A1B	A2	A1B	A2	A1B	A2
2010-2039	0.0	1.9	2.3	2.3	10.6	13.8
2040-2069	1.0	7.6	4.6	4.6	28.7	25.5
2070-2099	3.8	9.5	6.9	5.7	30.9	33.0

Table 4. Water shortage increment (%) for the achievement of genetically potential yield in comparison with reference period

Period\ Area	Banjaluka		Bijeljina		Mostar	
Potato water requirements (mm)	534-645		460-545		500-580	
1961-1990	15.0		23.3		15.0	
IPCC Scenario	A1B	A2	A1B	A2	A1B	A2
2010-2039	21.8	21.8	31.8	31.8	8.8	6.0
2040-2069	26.5	22.1	35.6	35.6	6.0	5.0
2070-2099	24.6	22.6	35.0	35.0	5.6	3.9

Table 5. Drainage water during the growth cycle of potato (mm) by IPCC scenarios and study areas

Period\ Area	Banja Luka		Bijeljina		Mostar	
1961-1990	65		9		181	
IPCC Scenario	A1B	A2	A1B	A2	A1B	A2
2010-2039	45	51	5	10	204	233
2040-2069	68	60	5	14	205	255
2070-2099	91	63	14	10	252	250

### Conclusion

Impact of climate change without adaptation measures would be definitely harmful on potato production in all study region in B&H. Applying relatively simple adaptation measure such as earlier sowing date, potato production could stay on present level, or even slightly increase in Banja Luka and Bijeljina area and much more in Mostar. However some prerequisite should be fulfilled such as drainage canals maintenance. For the stable and high yielding production of potato irrigation should be envisaged, especially in the Bijeljina region, and Banja Luka, on shallow and light sandy or sandy-loam soils.

### Acknowledgement

The study was conducted under Project TR 37005 funded by the Serbian Ministry of Education and Science.

## References

- Biancalani R., Predić T., Leko M., Bukalo E., Ljuša M. (2004). Učešće u razvoju načina korišćenja zemljišta na općinskom nivou u Bosni i Hercegovini (LUT) (Participatory Land Use Development in Bosnia and Herzegovina, LUT). Project GCP/BIH/002/ITA, FAO, Rome.
- Bird D.N., Benabdallah S., Gouda N., Hummel F., Koeberl J., La Jeunesse I., Meyer S., Pretenthaler F., Soddu A., Woess-Gallasch S. (2016). Modelling climate change impacts and adaptation strategies for agriculture in Sardinia and Tunisia using AquaCrop and value-at-risk. *Science of the Total Environment*, Vol. 543, p.1019-1027.
- Ćota J., Šilj M., (2012) Dutch early potato varieties in Bosnia and Herzegovina. Third International Scientific Symposium "Agrosym Jahorina 2012" Proceedings, p.167-172.
- Djurdjevic V., Rajkovic B. (2008): Verification of a coupled atmosphere-ocean model using satellite observations over the Adriatic Sea. *Annals of Geophysics* 26:1935-1954.
- Federal hydrometeorological Service B&H, <https://www.fhmzbih.gov.ba/> Accessed on 20/05/2016.
- Govedarica B., Đurđić I., Milić V. (2016). Stanje proizvodnje krompira u Republici Srpskoj. XXI Savetovanje o biotehnologiji. (State of potato production in Republic of Srpska. XXI Biotechnology conference). Proceedings, Vol. 21(23), p. 137-142.
- Group of authors (2014). Inventar stanja poljoprivrednog zemljišta i njegovog korišćenja u regiji Hercegovine (Inventory of the state of agricultural land and its use in the Herzegovina region). USAID, Mostar.
- Gualdi S., Rajkovic B., Djurdjevic V., Castellari S., Scoccimarro E., Navarra A., Dacic M. (2008). Simulations of climate change in the Mediterranean Area, Final Scientific Report. October 2008.pdf. <http://www.earth-prints.org/handle/2122/4675> Accessed 30/06/2016.
- IPCC, 2014: Climate Change 2014: Synthesis Report. Contribution of Working Groups I, II and III to the Fifth Assessment Report of the Intergovernmental Panel on Climate Change [Core Writing Team, R.K. Pachauri and L.A. Meyer (eds.)]. IPCC, Geneva, Switzerland, pp.151.
- Jacob D., Petersen J., Eggert B., et al. (2014). EURO-CORDEX: new high-resolution climate change projections for European impact research. *Regional Environmental Change*, Vol. 2, p. 563-578.
- Lalic B., Eitzinger J., Mihailovic D.T., Thaler S., Jančić M. (2013). Climate change impacts on winter wheat yield change – which climatic parameters are crucial in Pannonian lowland? *Journal of Agricultural Science*, Vol. 151, p 757-774.
- Linker R., Ioslovich I., Sylaios G., Plauborg F. Battilani A. (2016). Optimal model-based deficit irrigation scheduling using AquaCrop: A simulation study with cotton, potato and tomato. *Agricultural Water Management*, Vol. 163, p.236-243.
- Lizana X.C., Avila A., Tolaba A., Martinez J.P. (2017) Field responses of potato to increased temperature during tuber bulking: Projection for climate change scenarios, at high-yield environments of Southern Chile. *Agricultural and Forest Meteorology*, Vol. 239, p.192–201.
- Mihailović, D.T., Lalić, B., Drešković, N., Mimić, G., Djurdjević V., Jančić, M., 2015. Climate change effects on crop yields in Serbia and related shifts of Köppen climate zones under the SRES-A1B and SRES-A2. *International Journal of Climatology*, Vol. 35(11), 3320–3334.
- Novikova L.Yu., Kiru S.D., Rogozina E.V. (2017). Valuable traits of potato (*Solanum L.*) varieties as influenced by climate change in European Russia. *Agricultural Biology*, Vol. 52 (1), p. 75-83.



- Peltonen-Sainio P., Jauhiainen L., Trnka M., et al., (2010). Coincidence of variation in yield and climate in Europe Agriculture, Ecosystems and Environment Vol. 139, p. 483–489, Republic hydro-meteorological service RS,] <http://rhmzrs.com/> Accessed on 20/05/2016.
- Seneviratne I.S., Lüthi D., Litschi M. Schär, C. (2006). Land–atmosphere coupling and climate change in Europe. *Nature* Vol. 443, p.205-209.
- Steduto P., T. Hsiao, E. Fereres, D. Raes. (2012) The yield response to water. The original FAO water production function. In: Crop yield response to water. Irrigation and drainage paper 66. FAO Rome.
- Stojakovic N., Stricevic R., Vujadinovic-Mandic M., Todorovic M. (2015). Impact of climate change on water requirements and yield of maize grown under different pedo-climatic conditions in Bosnia and Herzegovina. Proceedings – Book of abstracts of International Conference on “Modern technologies, strategies and tools for sustainable irrigation management and governance in Mediterranean agriculture” (Eds. F.F. Montesano, A. Parente, N. Lamaddalena, M. Todorovic, L. Trotta), 23-25 September 2015, Valenzano (Bari), Italy.
- Stričević R.J., Djurović, N.Lj., Vuković, A.J., Vujadinović, M.P., Ćosić M.D., Pejić B.S., (2014). Application of Aquacrop model for yield and irrigation requirement estimation of sugar beet under climate change conditions in Serbia. *Journal of Agricultural Sciences (University of Belgrade)*, Vol. 59(3), p 301-317.
- Trbić, G., Bajic, D., Djurdjević, V., Crnogorac, C., Popov, T., Dekić, R.Petrasevic A., V. Rajcevic, V., 2016. The Impact of Climate Change on the Modification of Bioclimatic Conditions in Bosnia and Herzegovina. *Environmental Science* Vol. 1, p. 176-182.
- Vučetić V., (2011). Modelling of maize production in Croatia: present and future climate. *Journal of Agricultural Science* Vol. 149, p. 145–157.
- Žurovec J., Čadro S. (2011). Smanjenje prinosa poljoprivrednih kultura u uvjetima bez navodnjavanja na području sjeveroistočne Bosne (Crops yield reduction in conditions without irrigation in northeastern Bosnia). Proceedings. 46th Croatian and 6th International Symposium on Agriculture. Opatija. Croatia p. 760-764.

## **THE ROLE OF AGRICULTURAL SERVICE IN PRODUCTION OF HEALTHY PLANTING MATERIAL IN RASINA DISTRICT, SERBIA**

Sandra MILETAKOVIC\*, Radomir JOVANOVIC, Dragoljub MILOSAVLJEVIC, Branka ANTIC

Agricultural Service Krusevac, Krusevac, Serbia

\*Corresponding author: sandramiletakovic@gmail.com

### **Abstract**

Rasina district has tradition in production of planting material for the production of nursery plants of fruits and grapevines in the Republic of Serbia. Production of certified planting material is a complex and demanding job that requires good organization, the necessary legislation, trained people, properly equipped competent institutions, a good knowledge of the epidemiology of pathogens and constantly adopting new scientific knowledge, strict implementation of scientific know-how in production process, in order to guarantee the varietal accuracy, defined health status and quality of planting material. According to the current international and national legislation, propagation material can be placed on the market only if it is produced in registered nurseries under official control of phytosanitary service if officially confirmed that they belong to one of the categories listed in the scheme of regulation and certification. Agricultural Service Krusevac, as competent institution for phytosanitary control with professional capacities for the implementation of health control has decades of experience in the control of pathogens of fruit trees and vines in parent plantations and seedling. Phytosanitary control has particular socio-economic importance for farmers providing them with guaranteed quality, safe product placement and income on the domestic and international markets. The production of healthy planting material is also important for farmers, because it allows the fulfillment of international obligations and raising of reputation of the country, compliance with international conventions, and enabling farmers realization of safe financial income of the export of planting material, as well as large quantities of high-quality fruit and grapes and their products.

**Keywords:** *Nursery plants, healthy planting material, Rasina district, Serbia.*

### **Introduction**

The quality planting material is one of the basic conditions of successful fruit growing. The production of planting material in Serbia is regulated by a great number of Rulebooks (Official Gazette of Republic of Serbia, 66/99 and 13/2002; Official Gazette No.10/2003 and 13/2013 and Official Gazette No.39/2016, 59/2016, 115/2016, 119/2017 and 107/2018). The continental species of fruit trees and grapevine are the hosts of a large number of infectious pathogens: viruses, viroids and phytoplasma, systemic infections, as well as diseases of sensitive species of hosts. Depending on specific interaction of species of host plants / degree of the sensitivity of a variety / base and species / kind of pathogens, in appropriate agroecological conditions, the negative effects of infections are being manifested, that can significantly influence the growth and development of the plants, and even the quality of the fruit. Direct economic damages in fruit and vine growing caused by the above mentioned pathogens are well known and documented, as well as the expenses of carrying out the measures of eradication or controlling the diseases.

Infected and grown wild plants present the source of systemic pathogens and by vegetative reproduction it is being transmitted and spread. Legal, not enough controlled, and illegal turnover and exchange of infectious reproductive material for planting is the most important and the most dangerous primary way of spreading the pathogens, at the long distances from the place of growing the main plants to the place of planting material production and nursery plant establishment. Secondary, locally in the nursery plants and between them, certain infectious pathogens are being spread by different vectors. Because of the inability for healing once plants are infected and their long life, infected plants present the permanent source of infection in the wild, with the possibility of being infected by another pathogen or pathogen present in the environment, which together can lead to even more damage. Successful strategies for suppressing systemic pathogens and their elimination, or minimizing economic damage, are based on the integral application of a set of mainly preventive measures: quarantine control of taking in and spreading of harmful pathogens by international trade and the exchange of plant material with a potential pathogen, production and use for planting true-to-type and healthy planting material, phytosanitary control of the health of risky categories of plants for the purpose of early detection and elimination of the sources of infection, the suppression of natural transmitters, the creation and cultivation of commercially acceptable, resistant and tolerant varieties and bases.

In many countries, programs have been functioning for years and include defined procedures for creation, maintenance and production of non-viral or virus tested plants under official phytosanitary control, in recent decades in regulations known as "certification schemes". Most widespread programs of certification are just for different types of fruit trees and vines, developed and recommended in Europe by European and Mediterranean Plant Protection Organization (EPPO) within the phytosanitary measures and standards for the production of healthy plants for planting. The adopted EU directives define the requirements that must be fulfilled regarding the quality and health correctness so that the plant material could be acceptable for the EU market, as well as to prevent taking in and spreading of harmful organisms (Directive 2008/09/EC referring to bringing into the market reproductive planting material and seedlings intended for the production of fruit; Directive 68/193/EEC referring to bringing into the market material for vegetative reproduction of grapevine; Directive 2014/98/EU referring to the implementation of Directive 2008/90/EC for specific requirements of certain kinds and species of fruit trees; Directive 2000/29/EC referring to the protection measures regarding the taking in and spreading into EU of organisms harmful for plants and herbal products). National phytosanitary regulation: Law on planting material of the fruit trees, grapevine and hops and Law on plant health (2009) and appropriate Rulebooks are generally compliant with the regulations of EU. According to the valid, international and national legislation, reproductive and planting material can be put on sale only if it is produced in registered nurseries under official phytosanitary control and if it is officially certified that it belongs to one of the categories stated in the regulation and certification schemes: pre-basic, basic and certified, CAC material, standard and standard S-A material. The knowledge of presence and widespread of pathogens, their biology and epidemiology and existence of reliable methods of detection and identification are necessary precondition and base for each certification scheme implementation.

## **Material and Methods**

The work is based on control system of the existence of the pathogens in main nursery plant, seed plots, grapevine cutting nursery, nursery beds implementation in the Rasina District area in the Republic of Serbia. The survey was published by Agricultural Service Krusevac, and as authorised institution with a professional capacity it is included into a national phytosanitary system for implementation of the system of control of prevention of taking in and out of systemic fruit tree pathogens and grapevines into the country and out of it. It also controls the existence of pathogens in main nursery plants and nursery beds. The aim of health control, implemented by Agricultural Service Krusevac, is risk control of the presence of the virus in the reproductive and planting material of pome and stone fruit and grapevine, and this is what this work will be based on. Health examinations include visual examinations for the presence of plant diseases and pests of the fruit trees and grapevine. Health examinations are done according to the correctly determined rules and above mentioned regulations and rulebooks referring to nursery plants, nursery beds and nursery areas. Health examination and sampling of stone fruit (plums, cherry plum, peach, nectarine, apricot, almond, cherry, magrives, sour cherry) in the planting material production refer to the control of plum pox virus, Prune dwarf virus (PDV), as well as *Prunus necrotic ring spot virus* (PNRS). Health examinations are done by visual examination and sampling. During the control, there are two obligatory visual examinations. The first visual examination: performing a visual examination for the presence of pox virus symptoms of all the plants in main nursery plants and nursery beds in the nursery garden during the phase of active vegetative plant growing, in the period of the end of May-June and beginning of July. The visual examination for the presence of host plants of pox virus and eventually the presence of the symptoms on these plants is obligatory in the spatial isolation zone (buffer protection zone) as well, around the queen cell (1km in radius) and around the nursery beds in the nursery plant (in radius of 500 m). The burgeon of the bases of stone kinds of fruit trees in the queen cells of the nursery plant could have a very significant role in spreading the virus infecting by leaves lice. During the visual examination of the queen cells and nursery plants we state the presence of the burgeons as well and give suggestions for their removal. The existing situation and the result of visual examination is noted. The second visual examination for the presence of the pox symptoms on the plants in the queen cells, nursery beds and spatial isolation zone is performed for the second time in the period of September-October.

The appropriate sampling is the key step for successful determining of the viruses in the plant material, and for this kind of examination the sampling data are used, which was done in the period from 2008-2016. In the main nursery plant, samples of leaves from each individual main tree of all categories of reproduction material were taken during the period of the first visual examination. Where there were symptoms which eventually can indicate the presence of the virus, leaves with the symptoms were sampled. Where symptoms weren't noticed, the sampling is done in the following way: completely developed leaves from the basic part of burgeon from all sides of the treetop were sampled, but also from the inside of the treetop, 3-4 leaves from each branch (from 4 branches 3-4 leaves are sampled or from 5 branches 2-3 leaves are sampled for example; 12-16 leaves in total). The samples are packed with adequate marking and official order of the authorized service - Agricultural Service Krusevac- should be sent to diagnostic laboratory of first degree, according to the procedure described in Standard operating procedure for phytopathological diagnostic laboratories. Ministry of Agriculture, Forestry and Water Management of the Republic of Serbia (SOP) for plum pox virus (MPŠVRS and IVČ, 2008).

In the Nursery rootstock and planting material, leaves with the symptoms which can indicate the presence of pox virus from each seedling in the period of first visual examination were

sampled. Leaves from individual host plant with manifested symptoms which can indicate the presence of pox virus within the phytosanitary regulations regulated isolation space were sampled. The samples are packed, marked with official order of authorized service-Agricultural Service Krusevac- and forwarded to authorized diagnostic laboratory of first degree, according to the procedure described in SOP for plum pox virus (MPŠVRS and IVČ, 2008). During the second sampling, which spans September and the beginning of October, collective samples of leaves are randomly taken from four consecutive seedlings in a row, including the second visual check of nursery beds of the planting material which didn't show any presence of the Sharka virus and where hosting plants failed to show the presence of the virus in the puffer zone. The samples are taken to be tested in a diagnostic laboratory of the first degree. The nursery beds intended for export are especially tested by taking of random collective samples. In case of the detection of the Sharka virus hosting plants in the puffer zone during the first visual check and the confirmation of the virus by means of a serial test, during the second sampling it is obligatory for samples to be taken from 1% of the plants in nursery beds. The collective samples of leaves from four consecutive seedlings in a row are taken to be tested by ELISA serial test or collective samples from ten seedlings are taken to be tested by IC-RT-PCR/RT-PCR test. Sampling for the presence of PDV and PNRSV is conducted within original nursery blocks of grafts and seeds; 10% of an area is sampled depending on the type not the variety. Four shoots, in the length of 10-15 cm, including leaves, are taken as samples from 10% of the trees; one shoot is taken on each of the four main points of the compass (north, south, east, and west) and put in a bag to make a single sample comprising four shoots. If there are trees with changes detected on them, a targeted sampling is conducted. The samples are packed, labeled and sent in accordance with the warrant issued by the designated institution, Agricultural Service Krusevac, to a diagnostic laboratory of the first degree, following the procedure laid out in the rulebook for sanitary check of crops and objects for production of planting material (MPŠVRS, 2008). The pome fruit (apple, pear, medlar, quince and sorbus) is checked in its original nursery blocks and nursery beds for the presence of *Erwinia amylovora* – two visual checks are conducted (the period between the checks is the same as with the stone fruit). The checks were conducted in the original nursery blocks and nursery beds and in the isolated perimeter ranging 500 meters in radius. In the nursery blocks where the presence of *Erwinia amylovora* was not confirmed, 10% of the main trees and bushes were checked for the presence of Apple chlorotic leafspot trihovirus (ACLSV). Leaves were sampled from the bottom part of the tree tops of the original trees on each of the four main points of the compass (north, south, east, and west). One sample contains 24 leaves. The samples are packed, labeled and sent in accordance with the warrant issued by the designated institution, Agricultural Service Krusevac, to a diagnostic laboratory of the first degree, following the procedure laid out in the rulebook for sanitary check of crops and objects for production of planting material (MPŠVRS, 2008).

As far as the grapevine is concerned, two sanitary checks were conducted during one year on original plants (vines) and the production of grapevine grafts (grapevine graft nurseries). The first sanitary check is due in the period that spans July, August and the first half of September and the second in October. The samples are checked for the presence of Grapevine Fanleaf Virus (GFLV) and Grapevine Leafroll Virus (GLRV); the check was particularly conducted on original seedlings of grapevine buds and cuttings. Each of the espaliered original seedlings of grapevine for production of cuttings and buds was visually checked according to the rulebook; 10% of the vine samples formed 1% of the collective samples. The samples are packed, labeled and sent in accordance with the warrant issued by the designated institution, Agricultural Service Krusevac, to a diagnostic laboratory of the first degree, following the procedure laid out in the rulebook for sanitary check of crops and objects for production of planting material (MPŠVRS, 2008).

## **Results and Discussion**

Testing of the nursery blocks to above-mentioned viruses in the period between 2008 and 2016 proved that the main nursery blocks situated in an enclosed space showed no sign of PDV, PNRSV and ACLSV viruses in that particular period. However, the viruses were detected on a small number of original trees situated in an open space during the same period. Due to that fact, our recommendation was that the open-space production should be eradicated while the enclosed-space production should be increased. Our recommendation was accepted by those who produce planting material; the result is that complete growing of main plants in the Rasina District is conducted within enclosed spaces. Enclosed spaces are specially modified areas that should be enclosed from above by a PVC foil which is resistant to radiation and tearing and by a double net with small openings on each side to protect it from insects as the main virus spreading factor as far as the enclosed spaces are concerned. On the front side, it should be protected by a double door with two layers of net. Such an area used for production of the reproductive material (scions) is isolated from the surroundings and completely protected from insects. That particular type of material which is used for production of fruit seedlings and produced in an enclosed space is healthy and free of viruses thus limiting drastically the possibility for their appearance, the PPV especially. The priority of modern growing is choosing the most adequate area where growing shall take place. The choice of the most adequate place for production is a priority of the modern production of seedlings and stone fruit rooted stems. This choice is important since it affects the enclosed perimeter where plants are situated during the two-year growing process and the check for the plants which are the carriers of viruses is obligatory. The prevalence of blackthorn or sloe in the areas where stone fruit is grown happens to be the reason why in the Rasina District exists a great possibility for it to be found near the main nursery blocks and nursery beds, cherry plums and some home-grown varieties of plum; it is not uncommon for blackthorn to appear even within the enclosed perimeter. The role which blackthorn has to play in the spreading of Sharka virus has been examined by means of testing 557 samples gathered in the Rasina District spanning the municipalities of Trstenik, Krusevac, Varvarin and Cicevac. The examination showed that there were no samples of blackthorn which showed any symptoms of a PPV infection; there were no plants stricken with a latent infection. PPV has been detected in only 5 (0.9%) out of 557 samples – the samples have shown signs of chlorotic rings and linear discolouration which couldn't be distinguished from the symptoms detected on a plum infected with the Sharka virus; the remaining 15 plants were infected with the Prune Dwarf Virus (PDV). Prunus Necrotic Ring Spot Virus (PNRS) has been detected in only 3 samples (0.5%). Despite not being the source of latent PPV infection, blackthorn can be the source of a latent PDV infection (117 - 96.7% - out of 121 samples have shown the symptoms of latent PDV infection). It is more than interesting that not one plant infected with the virus of Sharka was detected in 121 sample taken from the blackthorn found in the surroundings of the nursery blocks on peach plantations; on the other hand, those samples proved to be 100% infected with the PPV. It is possible that leaf lice proved resistant to the natural infection with the PPV-M variety of the virus. It is indicative that the PPV infection has been detected only in those samples of blackthorn which showed visible signs of it. Many grown and weed annual plants could get infected during an experiment with Sharka virus, but it is still not proven that PPA could be transmitted by natural means from herbaceous plants to Prunus varieties. It is possible for leaf lice to transmit the virus locally from infected to healthy plants in and between nursery blocks in a non-persistent manner. Leaf lice pick up the virus very quickly and are capable to transmit it only within a few minutes after they had fed on an infected plant; after that period they become less viral. During intervals in spring and

autumn, number of leaf lice reaches its peak; the spring interval spans May, June and the beginning of July and the autumn interval spans the second half of August and the first half of September. The spring intervals are statistically more prominent than the autumn ones, but certainly there are ways for the virus of Sharka to be transmitted during the autumn interval too. The recommendation is for the treatment with mineral oils to be conducted during both intervals thus reducing the possibility of the virus to spread. According to certain studies, transmission via leaf lice is most frequent among those trees that are nearest to the source of infection; it doesn't necessarily happen only among trees in direct neighbouring surroundings but also among the plants as far as 12 meters and farther from the source. Literature sources for the monitoring of the transmission by molecular method show that in 90% of the cases the transmission reaches the distance between 120 (Conti, 1986) and 200 meters, however, transmissions to the distances longer than a few hundred meters have also been recorded. Transmission via leaf lice to a distance longer than 1 kilometer hasn't been confirmed yet, so it is probably as far as the virus can reach in this way.

### **Conclusions**

Sanitary control is of great importance both socially and economically to the growers to whom it guarantees quality, safe distribution and income both on domestic and international market. It provides fruit and vine growers with healthy planting material to enable them to take the first and financially most difficult step towards establishing multi-annual nurseries; it also enables them to keep those uninfected if there are no natural factors and the nurseries are situated on locations safe for production which are isolated enough or far from the source of infection. Sanitary control thus actually enables fruit and vine growers to delay or to slow the factors of infection with the economically harmful pathogens in conditions of their endemic presence which ensures yield and its quality. The production of good planting material is of great importance to the fruit-growing countries that need to raise and preserve the reputation of their country by abiding to the international contracts and respecting the conventions and rules of the organizations of which they are members; it enables them to achieve a secure income via unhinged export of planting materials, large quantities of fruit and grapes, and various products derived from them. The Agricultural Service of Krusevac has, by introducing an enclosed production of original plants, constant monitoring and sanitary check of the isolated perimeter - reduced the number of seedlings of stone fruit and pome fruit which are infected by viruses to the lowest possible degree.

### **References**

- Conti M. (1986). Epidemiology and vectors of plum pox virus of stone fruits. *Inf. Fitopatol.* 36:23-26.
- Dulić-Marković I (2008). Standard operating procedure for phytopathological diagnostic laboratories. Ministry of Agriculture, Forestry and Water Management of the Republic of Serbia, Belgrade.
- OEPP/EPPO. (2004). Diagnostic protocols for regulated pests, Plum pox potyvirus. PM7/32 (1). *Bulletin OEPP/EPPO Bulletin*, 34, 247-256. OEPP/EPPO. 2006. Diagnostics; PM 7/77 (1) - Documentation and reporting on a diagnosis. *Bulletin OEPP/EPPO Bulletin*, 36, 459-460.
- Paunović S., Jevremović D. (2009). Standard operating procedure for phytopathological diagnostic laboratories for plum pox virus (Plum pox virus-PPV). Ministry of Agriculture, Forestry and Water Management of the Republic of Serbia, Plant Protection Directorate, Belgrade and Institute for fruit growing, Čačak, Version 1.0-1-73.

## EFFECT OF DIRECT SELECTION ON PRODUCTIVE TRAITS OF VALERIAN (*Valeriana officinalis* L.)

Slobodan B. DRAŽIĆ\*

Serbian Association of Plant Breeders & Seed Producers, Zemun-Belgrade, Serbia

\*Corresponding author: s.drazic47@gmail.com

### Abstract

Effect of direct selection on root yields and on the essential oil content, are analyzed in the paper. As a source of variability we used selection material which consisted of the heterogeneous population of cultivated valerian. Using the method of direct selection (by vegetative multiplication), we created eight promising clones. Following traits were observed at the selected offspring: plant height (cm), yield of roots per plant (g) and essential oil content (%). During a two-year period of research, clones marked with numbers 97 and 156 have achieved reliably higher root yields. The values for essential oil content were different (0.457-0.825%). Values of variance and coefficients of variations for yield of roots, point out the existence of variability, which is an essential condition for the beginning of selection. The application of direct selection resulted in a high selection gain for yield of roots per plant and very low for essential oil content. The selection gain was greater at the selection intensity of 5% than of 10%.

**Keywords:** clones, direct selection, essential oil, yield of root, selection intensity, selection gain, valerian, variability.

### Introduction

There are 200 species belonging to the genus *Valeriana* distributed in the regions of the Old world, South America and Africa. Besides *Valeriana officinalis*, the following species of this genus are the most important: *V. vallichii* (India), *V. edulis* (North America), *V. latifolia* (Asia) (Dajić and Rančić, 2001). *Valeriana officinalis* L. ( $2n=14$ ) is the most distributed species in Europe. Variability of valerian is expressed through polyploidy, hence there are tetraploid and octoploid types. Valerian from central Europe is mainly tetraploid, while species in England belong to the octoploid type (Schratz, 1961). The increase of the number of chromosomes from  $2n$  to  $3n$ ,  $4n$  and more, results in the increase of cells and organs. The number of chromosomes and the amount of DNA doubled or quadrupled, which did not happen simultaneously with remaining organoids in the cytoplasm, because the actual cytokinesis was omitted. The increase of the whole set of whole set of chromosomes has a positive effect only to a certain extent, thus too many chromosomes may have a depressive effect. As the frequency of polyploidy incidence in nature is small, its occurrence in valerian provides the possibility to select, cross various genotypes and to develop new cultivars. In addition to the occurrence of polyploidy, the studies have shown the presence of variations in yields and essential oil contents, as well as in its ingredients within the species *Valeriana officinalis*, which may be a source of germplasm for the development of improved cultivars (Bos et al., 1998, Dražić, 1990, Nemeth, 2005, Prodanović et al. 2015).

In valerian breeding the programs of direct and indirect selection can be applied, where by it can be used generative and vegetative way of reproduction. Vegetative propagation in the process of breeding is a suitable tool for the observation of effects of genotypes and



environmental factors on the development of quantitative and qualitative traits (Dražić and Stepanović, 2001, Dražić, 2014). Breeding goal was to create an improved and homogenous genotype, which will contribute to the stability increased production of valerian traits.

### **Material and methods**

Using the method of direct selection (by vegetative multiplication), we created eight promising clones. They were homogeneous and had a higher mean values for important traits, so they were additionally studied in comparative experiments. Selected clones were observed in the experimental field in the course of two years. Three traits (height, root yield and essential oil content) were analysed in genotypes that represent selected clone progenies of valerian and were designated. The four-replication trial was set up according to the randomised complete-block design on the marshy black soil type. The elementary plot size amounted to 4 m<sup>2</sup>. The planting distance was 50 x 20 cm (100,000 plants ha<sup>-1</sup>). The genotypes were grown as the annual crop. The common cropping practices were applied during the growing season. Planting was done in October, while roots were harvested in October of the subsequent year. The best quality of valerian roots was determined in October, while the essential oil quality decreased during winter. The roots harvested in spring provided drug of poor quality (Bos et al., 1998). Roots were dried in the warm air dryer. Following main biometric parameters have been calculated: mean value, variance and coefficient of variation. The results were processed by variance analysis application, and significance by LSD test. The effects of selection of superior clones for the height, yield and the essential oil were evaluated. The gain of the selection was expressed in absolute and relative values, as a difference between mean values obtained from selected clones and mean values gained from the entire population of clones.

### **Results and discussion**

**Root yield.** The mean values for the plant height obtained from selected clones were different. Variation width was high, as well as variance and coefficient of variance. Additionally, yields of a dry root varied in a wide range, too. They amounted from 13.1 g (clone 220) to 33.0 g (clone 97) per plant. The average value of root yield per plant was 18 g in a grown population, respectively 17.6 g in selected clones. However, the clones 97 and 156 achieved reliably higher root yields compared to the standard. There are statistically significant differences among these two clones. In comparison to the standard, clone 97 had yield increase of 16 g or 84%, while in clone 156 yield was increased for 6 g or 34%. Both, variance and yield variance had high values, and this indicates on presence of the variability, which is the main precondition for starting the selection process. Variation width was very low for the essential oil content and this reflected on lower values for variance and coefficient of variance. The average content of essential oil in cultivated population was 0.520%, and 0.582% in selected clones. Clones marked with numbers 97 and 156 had the highest essential oil content - 0.737%, respectively 0.825%. However, this difference in the amount of essential oil content have no statistical significance (Table 1 and Table 2).

Table 1. Mean values of traits to select clones

Traits	Clones No.								Mean	Standard	LSD	
	28	49	97	98	101	148	156	220			5%	1%
Height (cm)	36	57	85	53	55	32	77	60	57	64	9.5	13.0
Root yield (g)	14.3	13.8	33.0	13.5	16.0	13.2	24.0	13.1	17.6	18.0	5.5	7.0
Essential oil content (%)	0.49	0.51	0.74	0.62	0.43	0.62	0.83	0.46	0.58	0.52	-	-

Table 2. Parameters of variability code to eight selected clones

Trait	Mean	Min.	Max.	Variance	CV
Height (cm)	57	32	85	284.93	30
Yield of dry roots per plant (g)	17.6	13.1	33.0	45.375	37
Essential oil content (%)	0.582	0.434	0.825	0.0165	22

**Selection gain.** The gain of the selection is expressed in absolute and relative values, as a difference between mean values obtained from selected clones and a mean values obtained from the entire population of clones. Realized selection gain varied depending on the traits and years. For the root yield it varied in the range from 62% to 72%, when the intensity of the selection was 10%, i.e. 5%, Table 3. Unlike root yield, values of the selection gain for essential oil content varied from 0.53% to 0.62% at the selection intensity from 10%, i.e. 5%. In quantitative terms, these acquired values are very small. According to results from previous and these researches, it is concluded that the root yield can have bigger impact on essential oil yield per unit area than its percentage content (Dražić et al. 2006). The analysis of dependence of the yield and the amount of essential oil on the growing conditions, pointed out that the essential oil quantity was a more stable trait, i.e. its variability was under greater control of genetic factors (Dražić and Šurlan, 1991). Recent studies on effects of phenological phases, especially of flowering, pointed out to significantly negative correlations with the essential oil content (Pop, 2010).

Table 3. Selection gain

Selection intensity	Selection for a trait			
	Roots yield (g)		Essential oil content (%)	
	Absolute	Relative	Absolute	Relative
10%	16	62	0.0031	0.53
5%	19	72	0.0036	0.62

## Conclusion

Using the method of direct selection (by vegetative multiplication), we created 8 promising clones. Clones marked with numbers 97 and 156 have achieved reliably higher root yields of 84% and 34% compared to standard. Values of variance and coefficients of variations for yield of roots, point out to the existence of variability, which is an essential condition for the beginning of selection. The values for essential oil content were different (0.457-0.825%). However these differences did not show statistical significance. The application of direct selection (with the use of vegetative multiplication) resulted in a high selection grain for yield of roots per plant and very low for essential oil content. The selection grain was greater at the selection intensity of 5% than of 10%.

## References

- Bos R., Woerdenbag J.H., van Putten M.S.F., Hendriks H., Scheffer C.J.J. (1998): Seasonal variations of the essential oil, valerenic acid and derivatives and valepotriates in *Valeriana officinalis* L. roots and rhizomes, and the selection of plants suitable for phytomedicines. *Planta Medica*, 64, 143-147.
- Dajić Z., Rančić D. (2001): Taxonomi and biological characteristics of valerian (*Valeriana officinalis* L.). Plenary lectures, VII Meeting, Days of Medicinal Plants, with international participation, Belgrade, Yugoslavia, Book of Abstracts, pp. 1-3.
- Dražić S. (1990): Genetička analiza fenotipske varijabilnosti prinosa i kvaliteta lekovitog bilja. *Lekovite sirovine/Matieres medicales*, vol. XXXIX, No 9, 23-29, Belgrade.
- Dražić S., G. Šurlan (1991): Korelacije ranga za prinos i sadržaj etarskog ulja. *Lekovite sirovine/Matieres medicales*, vol. XL, No 10, 13-18, Belgrade.
- Dražić S., Stepanović B. (2001): Breeding and seed production of valerian (*Valeriana officinalis* L.). VII Meeting, Days of Medicinal Plants, with international participation, Belgrade, Book of Abstracts, pp. 9.
- Dražić S., Živanović T., Kostić M. (2006): Efekti direktne selekcije na produktivna svojstva žalfije (*Salvia officinalis* L.). *J.Sci.Agric.Research/Arh.poljopr.nauke*, vol.67, N 240, 87-94.
- Dražić S. (2014): Effect of direct selection on productive traits of marshmallow (*Althaea officinalis* L.). 8th CMAPSEEC, Durres, may 19-22, Albania, Proceedings, pp. 411-415.
- Eva Nemeth (2005): Production and breeding of medicinal plants. *Handbook of Medicinal Plants* (chapter 10). Editors; Zohara Yaniv and Uriel Bachrach, Food Products Press, pp.193-212.
- Pop. M.R. (2010): Correlations between aesthetic quantity of the species traits and essential oil of *Valeriana officinalis* Bulletin of University of Agricultural Sciences and Veterinary Medicine Cluj-Napoca. *Horticulture*, 2010, Vol. 67 No. 1 pp. 519
- Prodanović S., Gordana Šurlan Momirović, Rakonjac, Vera Petrović Danijela (2015): Genetički resursi lekovitih, aromatičnih i začinskih biljaka ex situ. In. *Genetički resursi biljaka*. Univerzitet u Beogradu, Poljoprivredni fakultet, Beograd, Srbija, 179-183.
- Schratz E. (1961): *Arzneipflanzen, Handbuch der Pflanzenzuchtung*, 2, Aufl. Band V, pp.383-474, Paul Rarley, Berlin und Hamburg. Edited by Kappert H. and Rudolf W.

## DIVERSITY OF TALL FESCUE (*Festuca arundinacea* Scherb.) AUTOCHTHONOUS POPULATIONS AND CULTIVARS

Snezana BABIC\*, Dejan SOKOLOVIC, Jasmina RADOVIC, Zoran LUGIC, Goran JEVTIC, Snezana ANDJELKOVIC, Tanja VASIC

Institute for forage crops, 37251, Globoder, Krusevac, Serbia

\*Corresponding author: snezana.babic@ikbks.com

### Abstract

Tall fescue (*Festuca arundinacea* Scherb.) is a perennial grass species, with high yield potential and good biomass quality. It is one of the most productive forage grasses under optimum conditions. This species is often dominant in pastures. Also it has been used for intensive production of hay meadows, in pure sown or in mixtures with legumes. When used for forage production it is not usually mixed with other grasses. Variability of initial material (autochthonous populations, breeding populations or cultivars) is basic requirement for successful breeding of this, as well as other species. The investigated collection included eight autochthonous populations and five cultivars. The study was conducted in an experimental field of the Institute for Forage Crops, on degraded alluvium soil type. The trial was set up in a space plant nursery with plant to plant distance 60x60cm as a randomized block design with 30 plants per genotype in two years. The aim was to determine values and variability for the most important phenological (heading date), morphological traits (plant height, length of leaf, width of leaf, the leaf number, panicle length and the number of tillers per plant), dry matter yield per plant and dry matter yield quality. The highest dry matter yield per plant was measured in cultivars K-20, K-19, Belfine and Elfina. Investigated material has demonstrated significant variability within the genotypes for all studied parameters. Also, among populations variability was very statistically significant for all investigated traits. Genotypes used in this study can be a source of genes for improved productivity and quality in further breeding programme.

**Keywords:** *tall fescue, variability, autochthonous populations, cultivars.*

### Introduction

Tall fescue is forage and turf grass species in temperate regions of the world. Tall fescue is hexaploid ( $2n = 6x = 42$ ), with high level of self-incompatibility (Xu et al., 1991). It is one of the most productive forage perennial grasses, especially in extreme environmental conditions, like summer drought or winter hardiness. Also, regrowth production (second and third cut) is higher than other forage grasses Niemelainen et al. (2000). Increased interest for tall fescue in Europe coming from increased frequency of dry periods during summer. New cultivar of tall fescue have higher digestibility than wild ecotypes which dominate in permanent grasslands that have lower digestibility than other forage grasses. Tall fescue has been usually used for intensive production of hay meadows. Also, it is very tolerant to grazing therefore pastures where it dominates are long lasting. It can be grown as a pure crop or in mixtures with legumes.

Initial step in grass breeding process is identifying of genetic variability of breeding material, which existence ensures success of a plant breeding program. Autochthonous populations have natural variation and very often have satisfactory yielding performance in comparison

with introduced cultivars (Babić et al., 2014), which referred them for direct phenotypic selection for cultivars release (Posselt and Willner, 2007). Most of created cultivars contain autochthonous populations and represent great and important resource of genetic variability. The genetic variability of all traits important for breeding process represents a basic prerequisite for successful selection. The primary aim in tall fescue forage breeding is obtaining cultivars with a high yield and improved quality for livestock feed. The aim of this investigation was to determine genetic variability of eight autochthonous populations and five cultivars. The most important breeding criteria in tall fescue breeding programs, as well as other forage grasses, were increasing of forage yield and digestibility, disease resistance and drought and frost tolerance. Since is tall fescue use as a component of grass-legume mixtures in Serbia, dry matter yield and quality, persistency and rust resistance is most important breeding criteria of this species.

### **Material and methods**

A collection consisting of eight autochthonous populations and five cultivars of tall fescue was investigated during a two years period. Autochthonous populations have collected in hilly-mountainous areas of Serbia, while cultivars originating from commercial production.

Investigation was conducted in an experimental field of the Institute for Forage Crops, on degraded alluvium soil type. The trial was set up in a space plant nursery with plant to plant distance 60x60cm as a randomized block design with 30 plants per population in three replications. Heading date (HD) and morphological traits plant height (PH) (cm), leaf length (LL) (cm), leaf width (LW) (cm), the number of leaves per tiller (NLT), panicle length (PL) (cm), the number of tillers per plant (NTP) and dry matter yield (DMY) (g per plant) were investigated in 2 years; results are shown as two-year mean values. Heading date is presented as number of days from April the first. All morphological traits and dry matter yield per plant were measured at the full heading stage in first cut. Dry matter yield quality (crude protein, crude fibre, ADF and NDF) was determined by the Weende system, in two cuts and the results were presented as two-year average values.

All data were analysed by ANOVA. Differences between accessions were tested by the LSD test. Broad sense heritability ( $h_b^2$ ) was calculated for all traits according to the formula

$$h_b^2 = \frac{\delta_g^2}{\delta_f^2} \cdot 100$$

( $\delta_g^2$  -genetic variance;  $\delta_f^2$  - phenotypic variance)

### **Results and discussion**

Analyses of maturity, morphological traits which influence dry mater yield and quality, as well as biomass production and dry matter quality traits of tall fescue populations and cultivars, showed high within population variability (Table 1 and 2). Also, significant differences between tall fescue autochthonous populations and cultivars were determined for all studied traits (LSD values in Table 1 and 2). For all studied traits determined high values for broad sense heritability, especially for quality traits (Table 3). Leaf length and width and number of leaves per plant influence the forage quality by increasing the crude protein content and improving the dry matter quality. From the point of tall fescue breeding, except increasing of forage yield, soft and smooth leaves were favorable traits, in order to have better dry matter quality.

Table1. Average trait values and variability of tall fescue autochthonous populations and cultivars

Trait	HD	PH	LL	LW	NLT	PL	NTP	DMY
Population		cm	cm	cm		cm		g/plant
Kruševac	37,70	85,19	20,40	7,20	2,44	20,99	135,78	253,66
M. Polje 2	40,63	88,19	27,70	9,63	2,76	23,12	157,33	195,73
Dupci 3	40,44	78,70	21,37	8,15	2,35	22,80	138,89	230,46
M. Polje	39,52	83,85	20,39	8,04	2,39	22,32	149,93	229,73
Crni Vrh 2	39,15	90,19	21,12	7,83	2,39	23,61	127,56	222,02
Zlatibor Kremna	43,00	99,30	22,28	8,54	2,93	24,92	260,92	319,78
Zlatibor Farma	39,63	86,89	21,67	7,11	2,57	20,73	185,81	195,47
Zlatibor Vodice	46,07	92,00	21,65	7,67	3,28	23,21	198,74	223,29
K-20	29,70	93,41	24,97	7,86	2,93	23,09	168,30	392,49
K-19	31,04	107,85	28,25	8,09	2,91	23,87	169,96	387,25
Kora	33,48	93,19	27,32	9,72	3,07	24,82	126,44	356,93
Belfine	32,93	79,56	27,74	7,37	3,52	21,87	225,26	385,09
Elfina	33,00	81,04	24,25	9,02	3,31	24,35	218,19	384,83
Average	37,41	89,18	23,78	8,17	2,84	23,05	174,09	290,52
LSD	0,05	4,63	8,89	3,20	0,73	0,34	1,99	24,06
	0,01	6,74	12,95	4,66	1,06	0,49	2,90	35,04
CV%		15,08	20,09	22,02	19,36	18,71	19,48	28,06

HD - heading date (number of days from April the first); PH - plant height; LL - leaf length; LW - leaf width; NLT - number of leaves per tiller; PL - panicle length; NTP - number of tillers per plant; DMY - dry matter yield per plant

Cultivars K-19, Kora and Belfine and populations M. Polje 2 have optimum ratio of leaf length and width and number of leaves per plant (Table 1), which indicated that these populations have the best biomass quality (Table 2).

Table2. Dry matter yield quality of tall fescue autochthonous populations and cultivars (gkg<sup>-1</sup>)

Trait	Crude protein		Crude fibre		ADF		NDF		
Population	1 cut	2 cut	1 cut	2 cut	1 cut	2 cut	1 cut	2 cut	
Kruševac	117,2	131,6	384,1	322,2	452,4	416,8	735,6	655,4	
M. Polje 2	123,6	140,2	377,2	313,2	465,8	420,6	742,5	654,8	
Dupci 3	112,4	138,7	393,7	304,7	442,4	424,2	746,4	648,7	
M. Polje	111,2	126,5	383,2	323,8	464,7	419,8	738,4	674,2	
Crni Vrh 2	121,5	131,9	371,2	302,3	476,8	416,8	745,4	649,5	
Zlatibor Kremna	120,2	133,2	391,8	312,5	468,4	429,8	750,3	665,5	
Zlatibor Farma	122,3	132,5	388,7	305,6	462,5	424,7	737,7	658,4	
Zlatibor Vodice	119,7	130,2	398,5	314,7	476,4	418,6	745,8	657,8	
K-20	126,0	139,6	389,2	303,2	447,8	410,6	732,4	641,2	
K-19	130,4	140,5	370,5	310,2	446,8	414,2	736,5	642,2	
Kora	129,8	142,4	352,0	301,0	439,8	410,2	728,6	631,5	
Belfine	134,3	145,9	360,4	291,4	440,1	403,5	724,5	635,2	
Elfina	135,6	147,4	358,5	294,5	437,8	406,2	720,4	630,4	
Average	123,4	136,3	378,4	307,7	455,5	416,7	737,3	649,6	
LSD	0,05	12,3	36,5	27,3	40,4	39,8	79,4	62,6	
	0,01	14,4	43,9	30,9	49,9	45,2	88,4	71,4	
CV%		12,88	13,08	12,12	14,06	13,71	14,46	14,28	15,02

The most important indicator of the biomass quality is content of crude protein, which mainly depends on the growth stage at the time of cutting. In this study the accessions with highest crude protein content and lowest crude fibre content were K-19, Kora, Belfine, Elfine and M. Polje 2, accessions with the best ratio leaf length, width and number per plant (Table 2),

which gives them characteristics to be used as sources for improved dry matter quality breeding.

Average crude protein content of collection in the first cut was 123.4 gkg<sup>-1</sup> which is significantly lower compared to the results reported by Niemelainen et al. (2000), where the crude protein content ranged from 151 to 161 gkg<sup>-1</sup>. In the second cut crude protein content (136.3 gkg<sup>-1</sup>) was similar with Niemelainen et al. (2000).

Heading date is a very important trait, because accessions differing in this trait would enable creating of cultivars with diverse maturing time. In general, the latter accessions of grasses have better biomass quality than earlier. In this study, earlier accessions have higher quality values compared to latter, which is substantially similar to results published by Jafari and Rezaeifard (2010). Autochthonous populations included in investigation have latter maturity than cultivars, which provides the ability to create the cultivars differing in maturity, which is of interest for the composition of mixtures for various terms and duration of utilization (Sokolović et al., 2010).

In grasses, number of tillers per plant in the first cut is the trait which has the highest influence on dry matter yield, but number of tillers per plant also affects other important traits like seed production. The highest number of tillers per plant were found in populations Zlatibor Kremna (260.92) and cultivars Belfine (225.26) and Elfina (218.19).

Table 3. Heritability, genetic and phenotypic coefficient of variation

	$h_b^2$ %	$CV_G$ %	$CV_F$ %
Heading date	65,47	12,19	15,06
Plant height	57,66	8,31	10,91
Leaf length	59,12	11,59	15,08
Leaf width	69,81	9,67	11,57
Number of leaves per tiller	69,19	12,86	15,46
Panicle length	34,58	4,48	7,63
Number of tiller per plant	53,67	22,09	30,15
Dry matter yield per plant	85,45	19,65	21,26
Crude protein	1 cut	95,23	12,23
	2 cut	97,26	13,36
Crude fibre	1 cut	96,26	7,86
	2 cut	95,46	7,64
ADF	1 cut	95,26	8,43
	2 cut	94,68	9,12
NDF	1 cut	95,58	5,14
	2 cut	97,45	4,89

Dry matter yield per plant is one of the most important traits in the breeding process. The main aim is to increase the yield of dry matter, or maintain the yield through improving of other traits. The yield is very variable trait, influenced with high number of genes, and largely depends on the agroecological conditions. Highest dry matter yield per plant were scored for cultivars included in research, K-20 (392.49 g per plant), K-19 (387.25 g per plant), Belfine (385.09 g per plant) Elfina (384.83 g per plant) and Kora (356.93 g per plant). Autochthonous population Zlatibor Kremna is in range with cultivars by dry matter yield with 319.78 g per plant. Variability within genotypes studied (CV %) for pheno-morphological traits (Table 1 and 2) was not high, but differences between some genotypes (LSD) were statistically highly significant (Table 1 and 2.). The highest coefficients of variation were for number of tillers per plant (36.68%) and dry matter yield (28.06%), while heading date showed the lowest within population variability (15.08%). Within population variability for quality traits, such as

other, was not high, ranged from 12.12 to 15.02%, which is in agreement with results Babić et al. (2012). Genetic and phenotypic coefficients of variation are relative indicators of variability. They are used to compare the level of variability of traits expressed different units of measure. The most variable traits, as expected, are number of tillers per plant and dry matter yield per plant (Table 3). Broad sense heritability (Table 3) was high for all studied traits, except for panicle length (34.58%). The highest broad sense heritability determined for dry matter yield (85.45%). Broad sense heritability was high for all quality traits, where the lowest heritability was determined for crude protein content in the first cut (95.23%). High values of broad sense heritability for most traits indicate that an improvement of these traits could be possible and predictable in these collections.

### **Conclusion**

According to results of this study, significant differences within and between tall fescue autochthonous populations and cultivars were found for most studied traits. For the most important productivity traits like number of tillers per plant and dry matter yield, the highest values were determined for cultivars included in study and for populations Zlatibor Kremna. Also, important tall fescue criteria breeding are to improve biomass quality. Cultivars K-19, Kora and Belfine and populations M. Polje 2 have favourable ratio of leaf length and width and number of leaves per plant, which influenced that these accessions have the highest crude protein content. The average values, coefficients of variation and broad sense heritability for the most important traits, especially for number of tillers per plant, dry matter yield, leaf length and width and number of leaves per plant indicate a high breeding potential of investigated autochthonous populations and cultivars of tall fescue for these most important traits in tall fescue breeding process.

### **Acknowledgment**

Research was financed by Ministry of education, science and technological development Republic of Serbia, pr. TR31057.

### **References**

- Babić S., Sokolović D., Šurlan Momirović G., Andjelković S., Radović J., Jevtić G., Vasić T. (2014): Genetic variability of the most important traits in meadow fescue accessions. Proceedings of the 30th Eucarpia fodder crops amenity grasses section, 12-16 May 2013., Vrnjacka Banja, Serbia. In: Sokolović D., Huyghe C., Radović J. (eds.), Quantitative Traits Breeding for Multifunctional Grasslands and Turf, Springer, Ch 9, 73-79.
- Babić S., Sokolović D., Šurlan Momirović G., Dinić B., Andjelković S., Marković J. (2012): Variability of herbage quality of meadow fescue populations and cultivars. Proceedings of the 24th General Meeting of the European Grassland Federation, 3-7 June, Lublin, Poland. In: Golinski P. et al (eds.). Grassland Science in Europe, Vol. 17, 332-334.
- Jafari A.A. and Rezaeifard M. (2010): Effects of Maturity on Yield and Quality Traits in Tall Fescue (*Festuca arundinacea* Schreb). American-Eurasian Journal Agriculture & Environmental Science, 9 (1): 98-104.
- Niemeläinen, O., Jauhiainen, L. and Miettinen, E. (2000): Yield profile of tall fescue (*Festuca arundinacea*) in comparison with meadow fescue (*Festuca pratensis*) in Finland. Grass and Forage science, 56, 249-258.



- Posselt U.K., Willner E. (2007): Performance of *Lolium perenne* ecotypes in comparison with cultivars. Proceedings of Eucarpia fodder crops and amenity grasses section meeting, Perugia, Italia, 56-59.
- Sokolović D., Tomić Z., Babić S. (2010): Perennial forage grasses breeding in Serbia: achievements, limits and prospects. XII International Symposium on Forage Crops of Republic of Serbia, 26-28 May, Kruševac-Serbia, Biotechnology in Animal Husbandry, 26 (Spec. issue), Book1, 91-106.
- Xu, W.W., D.A. Sleper, and D.A. Hoisington. 1991. A survey of restriction fragment length polymorphisms in tall fescue and its relatives. *Genome* 34:686–692.

## VARIABILITY OF TOCOPHEROLS CONTENT IN MAIZE INBRED LINES

Snežana MLADENOVIC DRINIC<sup>1,2\*</sup>, Jelena MESAREVIĆ<sup>1</sup>, Milan STEVANOVIĆ<sup>1</sup>, Jelena SRDIĆ<sup>1</sup>, Natalija KRAVIĆ<sup>1</sup>, Milomir FILIPOVIĆ<sup>1</sup>, Violeta ANDELKOVIĆ<sup>1</sup>

<sup>1</sup>Maize Research Institute Zemun Polje, Belgrade, Serbia

<sup>2</sup>Academy of Engineering Sciences of Serbia, Belgrade, Serbia

\*Corresponding author: msnezana@mrizp.rs

### Abstract

One of the most powerful natural fat-soluble antioxidants are tocopherols or better known as vitamin E. Compared with other staple foods, maize grains contain high level of tocopherols. This research was performed to estimate differences in tocopherols ( $\alpha$ -,  $\beta$  +  $\gamma$ -,  $\delta$ ) content in 69 maize inbred lines by using high-performance liquid chromatography (HPLC). Among the inbred lines, significant variation was observed in the traits of interest: average  $\gamma$  -tocopherol content was higher in the sweet corn inbred lines (7.10  $\mu\text{g/g}$ ) but the average  $\alpha$ -tocopherol content was lower (12.99  $\mu\text{g/g}$ ) than in the inbred lines with standard kernel type (40.14  $\mu\text{g/g}$  and 13.5  $\mu\text{g/g}$ ), respectively. The content of  $\alpha$ -tocopherol ranged from 2.35 to 38.14  $\mu\text{g/g}$  in inbreds and from 7.66 to 17.79  $\mu\text{g/g}$  in sweet corn inbreds and  $\gamma$  tocopherol content from 12.10 to 105.2  $\mu\text{g/g}$  in inbreds and from 50.09 to 101.32  $\mu\text{g/g}$  in sweet corn inbreds. The lowest level of all tocopherols have inbred K1263. The inbred lines with the highest content of  $\alpha$ -tocopherol are TVA 973 and H, and with the highest  $\gamma$  -tocopherol content inbred Yum 1-3 and sweet corn line Esteem-F1-6. Those inbred lines could be used in future breeding programs for improving the tocopherol content of commercial inbred lines.

**Keywords:** *genetic variability, inbred lines, maize, tocopherols*

### Introduction

Vitamin E is the common name that describes eight naturally occurring compounds that are lipid-soluble antioxidants with two distinct groups, tocopherols and tocotrienols. The two groups differ in the saturation of the side chain and vary in the number and location of methyl groups (Rochefford, 2002). They are classified according to the location of the methyl group as  $\alpha$ -tocopherol,  $\beta$ -tocopherol,  $\delta$ -tocopherol,  $\gamma$ -tocopherol,  $\alpha$ -tocotrienol,  $\beta$ -tocotrienol,  $\delta$ -tocotrienol and  $\gamma$ -tocotrienol (Moss, 1981). Vitamin E plays an important role in plants development and can protect cell membranes from oxidation, prevent oxidation of polyunsaturated fatty acid, prevent several diseases in humans and other animals, such as cardiovascular disease, Alzheimer's disease, neurological disorders, cancer, cataracts, inflammatory diseases and age-related macular degeneration (Herrera, *et al.* 2001). Vitamin E antioxidant activity order is as follow:  $\alpha$ -tocopherol >  $\beta$ -tocopherol >  $\gamma$ -tocopherol >  $\delta$ -tocopherol.  $\alpha$ -tocopherol is the major vitamin E in nearly all green plants, as well as in seeds and fruits  $\gamma$ -tocopherol is preferentially found (Matea *et al.*, 2008). Tocopherols are essential micronutrients for humans and animals, with several beneficial effects in plants. Among cereals, only maize grains contain high concentrations of tocopherols. Tocopherol levels in maize kernels vary widely, however, the two predominant isomers are  $\gamma$ -tocopherol and  $\alpha$ -tocopherol (Rochefford, 2002). Grams *et al.* (1970) study the concentration of tocopherols in the germ, endosperm and pericarp of the kernal of four maize hybrids. They found that the germ fraction contained 70-86% and the endosperm fraction 27-11% of the tocopherols extracted from the whole grain. In the four hybrids analyzed, the germ fraction contained 94-

96% of the  $\alpha$ -tocopherol as well as 93-96% of the  $\gamma$ -tocopherol extracted from the whole grain. Maize kernels have low  $\alpha$ -tocopherol content, the compound with the highest vitamin E activity, thus, raising the risk of vitamin E deficiency in human populations relying on maize as their primary vitamin E source. Several studies have shown significant differences among maize inbreds for tocopherol levels (Egesel, 2001, Drinic *et al.*, 2014, Anđelković *et al.*, 2016). The aim of this study was comparison tocopherol content of 69 maize inbred lines with different kernal type.

### Material and Methods

Sixty nine maize inbred lines, 19 sweet corn (L1-L19) and 50 maize inbred line with standard kernal type (L20-L69) were study for tocopherol content. Maize seed were milled (Perten 120, Sweden) into flour (particle size < 500  $\mu$ m), in order to obtain greater surface contact and stored at -20°C prior to analysis. Tocopherols ( $\alpha$ -,  $\gamma$ +,  $\beta$ - and  $\delta$ ) were extracted by method proposed by Gliszczyńska-Świgło *et al* (2007) with minor modification. Approximately 0.2 g of sample was mixed with 2-propanol (4 mL) and homogenised for 30 min at room temperature. The extracts were then centrifuged at 3000 rpm for 5 min, filtered through a 0.45  $\mu$ m membrane filter and a aliquot of clear supernatant was directly injected into the Dionex UltiMate 3000 liquid chromatography system (Thermo Scientific, Germany) equipped with fluorescence detector (FLD-3100). Chromatographic separation of tocopherols was accomplished on analytical column, Acclaim Polar Advantage II, C18 (150  $\times$  4.6 mm, 3  $\mu$ m) operated at 30°C. Mixture of acetonitrile and methanol (1:1, v/v) was used as a mobile phase at flow rate of 1 mL/min. Injection volume was 5 $\mu$ L, while the wavelengths for excitation and emission were maintained at 290 nm and 325 nm, respectively. Tocopherols were identified and quantified comparing characteristic retention time of corresponding standards. The tocopherols content is expressed as micrograms per gram dry matter.

### Results and Discussion

Maize displays considerable natural variation for tocopherols content. Presence of tocopherols can vary by genotype, but the majority of the tocopherols in the maize kernel are found in the germ along with most of the stored oil which contains 70% to 86%, while the endosperm contains 11% to 27% (Rochefford *et al.*, 2002). Maize grains have been evaluated for tocopherol levels and substantial natural variation of  $\alpha$ ,  $\gamma$ , and  $\delta$ -tocopherols has been observed, with levels of  $\gamma$ -tocopherol predominant in the total tocopherols pool (Weber, 1987; Egesel *et al.*, 2003).

Average content of  $\alpha$  tocopherol was higher in inbred lines with standard kernal type (13,50  $\mu$ g/g) than in sweet corn inbred lines (12,99  $\mu$ g/g) but sweet corn inbred lines have higher content of  $\gamma$  tocopherol (70,10  $\mu$ g/g) than standard inbred lines (40,14  $\mu$ g/g). Content of  $\alpha$  tocopherol varied from 7,66 to 17,79  $\mu$ g/g for sweet corn and from 2,35  $\mu$ g/g to 38,14  $\mu$ g/g in inbred lines with standard kernal types. The highest level of  $\alpha$  tocopherol have inbred line TVA973 (38,14  $\mu$ g/g) followed by inbred line H (24,04  $\mu$ g/g) and lowest one 2,35  $\mu$ g/g inbred line Va 93.  $\gamma$  tocopherol content range from 50,09  $\mu$ g/g to 101,32  $\mu$ g/g for sweet corn and from 12,10  $\mu$ g/g to 105,02  $\mu$ g/g for inbred lines with normal kernal type (Table 1). The  $\gamma$  tocopherol content was highest in Yum1-3 (105,02  $\mu$ g/g), followed by the sweet corn inbred line Esteem-F1-6 (101,32  $\mu$ g/g), and was lowest in K1263 (12,10  $\mu$ g/g). The highest level of  $\delta$  tocopherol 4,66  $\mu$ g/g have sweet corn inbred line RBN9024-9 and lowest one 0,48  $\mu$ g/g inbred line Yum1-3, average 2,81  $\mu$ g/g in sweet corn inbred lines and 1,47  $\mu$ g/g in inbred lines with standard kernal types. The lowest level of all three ( $\alpha$ ,  $\gamma$ ,  $\delta$ ) tocopherols have inbred K1263

(7,84 µg/g, 12,10 µg/g, 0,96 µg/g, respectively). The distribution of different tocopherols in the inbred lines also varied. In TVA973-1, the content of γT (41,24 µg/g) was almost same as that of αT (38,14 µg/g), where as γT content in Oc117A3T (14,17µg/g) was nearly twice as that of αT (7,40µg/g), even in sweet corn inbred lines LSh2 γT content (77,11µg/g) was more than ten times as that of αT (7,66 µg/g).

Table 1. Content of tocopherols in thirty maize populations

Inbred lines							
No	Alpha tocopherols	Gama tocopherols	Delta tocopherols	No	Alpha tocopherols	Gama tocopherols	Delta tocopherols
1	15,60 ±0,25	50,09±0,81	165±0,03	36	7,40±0,09	14,17±0,17	0,50±0,01
2	13,73±0,05	53,88±0,21	1,80±0,01	37	12,93±0,08	19,20±0,11	0,79±0,00
3	7,66±0,14	77,11±1,43	2,62±0,05	38	2,35±0,01	27,49±0,17	0,85±0,01
4	14,99±0,06	52,95± 0,21	2,17±0,01	39	10,05±0,04	62,17±0,24	2,01±0,01
5	10,68±0,05	75,26±0,34	3,66±0,02	40	21,73±0,16	71,70±0,53	4,27±0,03
6	16,58±0,11	86,12±0,58	3,51±0,02	41	11,31±0,07	63,77±0,40	2,77±0,02
7	11,64±0,30	56,96±1,44	2,72±0,07	42	12,37±0,11	56,60±0,50	6,56±0,06
8	12,29±0,03	71,64±0,15	3,64±0,01	43	7,86±0,07	20,11±0,17	1,74±0,01
9	12,28±0,28	99,26±2,24	4,66±0,11	44	7,84±0,06	12,10±0,10	0,96±0,01
10	12,96±1,36	59,99±6,28	2,70±0,28	45	17,26±0,07	45,64±0,18	1,90±0,01
11	16,06±0,31	85,15±1,66	4,10±0,08	46	13,24±0,15	21,76±0,24	1,21±0,01
12	17,00±0,09	101,32±0,54	4,01±0,02	47	8,77±0,07	47,63±0,40	1,69±0,01
13	9,20±0,16	82,99±1,48	1,69±0,08	48	12,99±0,03	24,27±0,05	0,70±0,00
14	13,57±0,03	59,79±0,15	2,14±0,01	49	20,52±0,17	21,89±0,18	0,59±0,00
15	17,79±0,14	78,67±0,61	3,01±0,02	50	20,24±0,13	31,72±0,20	1,20±0,01
16	9,40±0,08	53,61±0,47	2,09±0,02	51	12,12±0,05	20,20±0,08	0,79±0,00
17	12,58±0,15	57,63±0,71	2,28±0,03	52	13,67±0,06	33,82±0,14	1,74±0,01
18	10,70±0,16	64,47±0,95	1,29±0,05	53	16,66±0,11	32,34±0,20	1,18±0,01
19	12,12±0,19	65,01±1,00	3,64±0,06	54	17,91±0,13	30,90±0,23	1,85±0,01
20	10,59±0,05	28,55±0,13	2,04±0,01	55	9,76±0,03	35,81±0,11	1,21±0,01
21	14,15±0,11	35,73±0,28	1,98±0,02	56	13,35±0,06	33,89±0,16	1,22±0,01
22	24,04±0,29	25,18±0,30	1,08±0,01	57	18,70±0,07	35,74±0,13	0,61±0,00
23	8,16±0,09	51,61±0,60	2,95±0,03	58	19,12±0,08	23,33 ±0,10	0,81±0,00
24	7,23±0,03	44,54±0,20	1,80±0,01	59	19,78±0,13	41,88±0,27	2,02±0,01
25	9,73±0,11	18,25±0,21	0,74±0,01	60	13,62±0,07	28,89±0,14	1,62±0,01
26	10,84±0,07	53,09±0,35	4,39±0,03	61	12,37±0,03	43,97±0,11	1,20±0,00
27	8,66±0,05	29,08±0,16	1,18±0,01	62	14,24±0,06	46,60±0,20	1,46±0,01
28	7,60±0,06	81,69±0,66	2,99±0,02	63	16,80±0,09	72,18±0,41	1,60±0,01
29	12,16±0,13	33,35±0,36	1,15±0,01	64	16,15±0,18	30,31±0,34	0,66±0,01
30	18,00±0,05	63,77±0,18	1,73±0,00	65	15,56±0,12	44,11±0,34	0,92±0,01
31	9,85±0,07	77,46±0,54	2,29±0,02	66	13,82±0,15	45,00±0,47	1,26±0,01
32	9,44±0,07	41,42±0,31	0,77±0,01	67	14,41±0,07	27,16±0,13	0,49±0,00
33	9,82±0,09	105,02±0,92	5,48±0,05	68	9,81±0,02	23,11±0,05	1,36±0,00
34	38,14±0,35	41,24±0,38	2,29±0,02	69	11,16±0,09	16,19±0,14	0,49±0,00
35	10,62± 0,12	71,30±0,80	2,74±0,03				

Several studies have shown significant differences among maize inbreds for tocopherol levels. Forgey (1974) evaluated 20 inbreds and found α tocopherol ranged from 9.1 to 64.6µg/g and γ tocopherol from 13.6 to 128.7µg/g. Kurilich and Juvik (1999) found that total tocopherol content averaged 30.1 µg/g dry weight among 44 maize varieties, with γ-tocopherol most predominant at two-thirds of total tocopherol, α-tocopherol making up 27%, and δ-tocopherol only 4%. Ibrahim and Juvik (2009) study 41 sweet corn genotypes and found that the most abundant form of tocopherols were gamma-tocopherol. α/γ ratio was highest in inbred line H (0,954), followed by L317 (0,938) and TVA973-1 (0,925) and was lowest in Va 93 (0,085) (Table 2).

Table 2.  $\alpha/\gamma$  ratio in sweet corn (1 – 19) and normal inbred lines (50 – 69)

No	$\alpha/\gamma$ ratio	No	$\alpha/\gamma$ ratio	No	$\alpha/\gamma$ ratio	No	$\alpha/\gamma$ ratio	No	$\alpha/\gamma$ ratio
1	0,312	15	0,226	29	0,364	43	0,390	57	0,523
2	0,255	16	0,175	30	0,282	44	0,648	58	0,819
3	0,099	17	0,218	31	0,127	45	0,378	59	0,472
4	0,283	18	0,166	32	0,228	46	0,608	60	0,471
5	0,141	19	0,186	33	0,094	47	0,184	61	0,281
6	0,192	20	0,371	34	0,925	48	0,535	62	0,305
7	0,204	21	0,395	35	0,149	49	0,938	63	0,232
8	0,171	22	0,954	36	0,522	50	0,638	64	0,532
9	0,124	23	0,158	37	0,673	51	0,600	65	0,352
10	0,216	24	0,162	38	0,085	52	0,404	66	0,307
11	0,189	25	0,533	39	0,161	53	0,515	67	0,530
12	0,168	26	0,204	40	0,303	54	0,579	68	0,424
13	0,110	27	0,298	41	0,177	55	0,272	69	0,689
14	0,227	28	0,093	42	0,218	56	0,393		

Besides having a characteristically sweet taste, sweet corn varieties have unique carotenoid and tocopherol profiles relative to common maize,  $\gamma$ -tocopherol is the primary tocopherol. The high variability among sweet corn genomes regulating the synthesis of tocopherols suggests that they are feasible targets for biofortification efforts focused on enhancing antioxidant levels (Nuss and Tanumihardjo, 2010).

### Conclusions

Tocopherols are compounds present in maize that provide health and economic benefits, which potentially could be captured by both producers and consumers to add value to the grain. So, increased levels of tocopherols in maize grain, because of their antioxidant activity, should increase the nutritive value of corn. Compared with sweet corn inbred lines, the normal inbred lines contained broader genetic variations for tocopherols, though the number of sweet corn lines (19) was far smaller than that of normal lines (50). Sweet corn inbred lines have more  $\gamma$ -tocopherol. An effective increase in vitamin E concentration could be achieved by increasing total tocopherols or by increasing the  $\alpha$ /total tocopherol ratio.

### Acknowledgement

This study is supported by the Ministry of Education, Science and Technological Development of the Republic of Serbia as part of a project TR 31068.

### References

- Andelković, V., Mesarović J., Mladenović Drinić S. (2016). Variability of tocopherol and  $\beta$  carotene content in maize grain of inbred lines, populations and their crosses. Book of abstracts of V symposium of the section of the breeding of the organisms of the Serbian Genetic Society, pp.4., Kladovo 27.5-31.5.2016.
- Drinić Mladenović S., Dragičević V., Žilić S., Basić Z., Kovačević D. (2014). Variability of tocopherol and  $\beta$ -carotene contents in maize genotypes. Journal of International

- Scientific Publications: Agriculture and Food Volume 2, 192-198. ISSN 1314-8591 (Online), Published at: <http://www.scientific-publications.net>
- Egesel, C.O. (2001). Genetic variation among maize genotypes for carotenoid and tocopherol compounds. Ph.D. Thesis (62-08, secB; P3423). University of Illinois at Urbana-Champaign.
- Egesel, CO, Wong JC, Lambert RJ et al (2003). Combining ability of maize inbreds for carotenoids and tocopherols. *Crop Sci* 43:818–823.
- Forgey, W.M. (1974). Inheritance of isomers of vitamin E in *Zea mays* L. MS. Thesis. University of Illinois at Urbana-Champaign.
- Gliszczynska-Świągło, A., Sikorska E., Khmelinskii I., Sikorski M. (2007). Tocopherol content in edible plant oils, *Polish journal of food and nutrition sciences*, 57, 4(A), 157-161.
- Grams G. W., C. W. Blessin and G. E. Inglett (1970). Distribution of Tocopherols Within the Corn Kernel. *Journal of the American oil chemists' society*, Vol. 41, No. 9, Pages: 331-339.
- Herrera, E., Barbas C. (2001). Vitamin E: action, metabolism and perspectives. *J Physio and Biochem* 2001, 57(2):43–56.
- Ibrahim KE, Juvik JA. (2009). Feasibility for improving phytonutrient content in vegetable crops using conventional breeding strategies: case study with carotenoids and tocopherols in sweet corn and broccoli. *J Agric Food Chem.* 2009 Jun 10;57(11):4636-44.
- Kurilich, A.C., and Juvik J.A. (1999). Simultaneous quantification of carotenoids and tocopherol in corn kernels extracts by HPLC. *J.Liq. Chromatogr. Related Technol.* 19:2925–2934.
- Matea, C. T., Negrea, O., Has, I., Ifrim, S., Bele, C. (2008). Tocopherol and Fatty acids contents of selected Romanian cereal grains. *Chem. Listy* 99.
- Moss, GP (1981). Nomenclature of tocopherols and related compounds. *Recommendations* 1981. *Eur J Biochem* 1981, 123:473–475.
- Nuss, E. T. and Tanumihardjo, S. A. (2010), Maize: A Paramount Staple Crop in the Context of Global Nutrition. *Comprehensive Reviews in Food Science and Food Safety*, 9: 417–436. doi:10.1111/j.1541-4337.2010.00117.
- Rochefford, T.R., Wong, J.C., Egesel, C.O., Lamber, R.J. (2002). Enhancement of vitamin E levels in corn. *J Am Coll Nutr* 21, 191S–198S.
- Weber EJ (1987). Carotenoids and tocopherols of corn grain determined by HPLC. *J Am Oil Chem Soc* 64:1129–1134

## IDENTIFICATION OF POTENTIAL DUPLICATES IN MAIZE GENE BANKS USING MOLECULAR DATA

Violeta ANĐELKOVIĆ<sup>1\*</sup>, Dragan KOVAČEVIĆ<sup>1</sup>, Ana NIKOLIĆ<sup>1</sup>, Mirjana JANKULOVSKA<sup>2</sup>, Sonja IVANOVSKA<sup>2</sup>, Dane BOSEV<sup>2</sup>, Snežana MLADENOVIĆ DRINIĆ<sup>1</sup>

<sup>1</sup>Maize Research Institute Zemun Polje, Serbia,

<sup>2</sup>Faculty of Agricultural Sciences and Food, R. Macedonia

\*Corresponding author: avioleta@mrizp.rs

### Abstract

The second half of 20<sup>th</sup> century was with growing awareness of importance of landraces conservation for the future. A total of 2217 maize landraces collected in the former Yugoslavia, are stored at Maize Research Institute (MRIZP) gene bank. Out of them, 222 accessions were from the Republic of Macedonia. During 2014, new collecting missions were organised in the eastern and western part of Macedonia. According to collecting site, kernel type and colour, 12 samples from Macedonian (MK) gene bank were chosen for the comparison and identification of possible duplicates with the 16 accessions from the same area and kernel characteristics within MRIZP gene bank. Duplicate accessions are not valuable for widening diversity and required increased financial and storage capacity. In the last few decades, application of molecular markers for polymorphism investigation at the DNA level has been very successful in genetic diversity studies. Based on molecular analysis by 12 Simple Sequence Repeats (SSR), ten genotypes (five from MRIZP and five from MK gene bank) clustered together, with obtained similarity from 0.687 to 0.844. The pair (ZP 1172 and FZNH010040058), had the highest similarity and could be treated as duplicate for MRIZP gene bank. Application of DNA markers, unaffected by environment, successfully discriminate closely related genotypes and possible duplicate accessions. Since identification of absolute genetically identical samples is possible only by comparison of complete genome, that is not necessary for samples considered as duplicates in gene bank management.

**Key words:** *accessions, duplicates, landrace, maize, SSR.*

### Introduction

Maize genetic resources are of high importance for agriculture, but breeding of modern hybrids in the second half of the 20<sup>th</sup> century, contributed to rapid replacement of traditional landraces in Europe. The need for preventing the loss of maize genetic diversity led to organised collecting missions. Since landraces are a valuable source of potentially useful traits, there is necessity to properly conserve and characterise them, prevent from disappearing, and to keep for utilization in breeding. Many maize gene banks were established in different countries, and characterisation of genetic diversity was carried out (Rebourg *et al.*, 2001). However, the usefulness of applied morphological characterisation of gene bank accessions became limited, since they are strongly affected by environment. In the last few decades, application of molecular markers for polymorphism investigation at the DNA level has been very successful in genetic diversity studies (Ignjatović Micić *et al.*, 2008; Barcaccia *et al.*, 2016). Efficient management in gene banks, through seed multiplication and regeneration in *ex situ* collections, is affected by possible loss of genetic integrity and existence of duplicate accessions. The term duplicate accession distinguished historical and

genetic or biological duplicates in genebanks. Passport data, together with geographical origin and/or historical data were used in duplicate identification in many gene banks, but could be uncertain (Hintum and Knüpffer, 1995; Lund *et al.*, 2003). Duplicate accessions are burden to gene bank since they are not valuable for widening diversity and their maintenance and multiplication increase costs. These are important facts for necessity of duplicates identification and elimination of redundant accessions (Treuren *et al.*, 2001). For genetic resources conservation, it is important to know whether phenotypically similar genotypes share similarity in gene combinations. Microsatellite markers are appropriate for the assessment of genetic diversity given their informativeness, co-dominance, high polymorphism, repeatability, and simplicity (Bourguiba *et al.*, 2010). In numerous diversity studies, application of SSRs was appropriate for grouping accessions according to their geographical origin, e.g. in bean (Sharma *et al.*, 2013), tomato, (Mercati *et al.*, 2015), maize (Cömertpay *et al.*, 2012). Replacement of local maize landraces with hybrid maize in the second half of the 20<sup>th</sup> century occurred in former Yugoslavia (western Balkan region, Andjelkovic and Ignjatovic-Micic, 2012). Collection, characterization, and natural classification in coming decades resulted in more than 2000 local maize landraces, stored at MRIZP gene bank. Out of them, 222 landraces were collected in the Republic of Macedonia (Andjelkovic and Ignjatovic-Micic, 2012). In the present paper, diversity between maize landraces collected in the Republic of Macedonia in the second part of 20<sup>th</sup> century, and in 2014. were studied. Applied SSR analysis will contribute to the more efficient *ex situ* conservation, and rationalisation of gene bank collection, e.g. elimination of potential duplicate accessions.

## Material and Methods

### Field Trails

Maize accessions from MRIZP genebank were collected in different years (1974, 1975, 1978, 1980, 1983, 1984 and 1989), and 12 samples from MK gene bank were collected in 2014 (Ivanovska and Jankulovska, 2016) from several locations in R. Macedonia (Table 1). Samples from both genebanks were grouped based on the same/similar collection sites, kernel colour and texture. The landraces were evaluated in 2015 in Zemun Polje, Serbia, and Kumanovo, R. Macedonia with two replications, with the usual cultivation practice. Plants were sown in single row plots with 15 hills per row and spaced 0.75 m apart with intra-row spacing of 0.4 cm between hills. Plots were overplanted and thinned to two plants per hill after seedling establishment.

### DNA Extraction and SSR Analysis

DNA samples from each of the 28 accessions were isolated using leaf material from 15 individuals in a population. Harvested leaves were kept frozen at -30°C and powdered in liquid nitrogen. Total genomic DNA was extracted and purified from 0.1 g of the powder by a CTAB method (Saghai-Marooof *et al.*, 1984). The DNA was quantified and assessed for purity spectrophotometrically, and diluted to a working concentration of 50 ng/μl. A final set of 12 SSR primers were applied in the analysis of the genotypes according to the method of Senior *et al.* (1998). Markers were selected based on amplification size and quality, and whole genome coverage. The amplification reaction was carried out in 25 μl reaction volume containing 1x enzyme buffer, 2.4 mM MgCl<sub>2</sub>, 200 μM dNTP, 0.5 μM primers, 1xBSA, 1U *Taq* polymerase and 50 ng DNA template. Touch-down amplifying program was applied (thermocycler Biometra Proffesional Standard 96) as follows: initial denaturation at 95°C for 5min, 15 cycles of denaturation at 95°C for 30sec, annealing at 63.5°C for one min (-0.5°C/cycle) and extension at 72°C for 1min, then 22 cycles of denaturation at 95°C for



30sec, annealing at 56°C for one min and extension at 72°C for 1min and finally elongation at 72°C for four minutes. The amplified DNA fragments were separated using 8% polyacrylamide gel electrophoresis for 1.5 hours at 80 mA. After staining with ethidium-bromide for 30 minutes, gels were photographed under UV light using Biometra BioDocAnalyze Live gel documentation system. DNA banding patterns from SSR gels were converted into binary form, where a ‘one’ indicates the presence of a specific allele and a ‘zero’ indicates the absence of that allele. Scored data were used to estimate Jaccard’s similarity coefficient (Jaccard, 1908) and the obtained similarity matrix was used in cluster analysis. UPGMA method was applied to obtain the dendrogram. All analyses were performed using R 3.3.1 statistical package.

Table 1. List of accessions of maize landraces, genebank identification document (GB ID), collecting site, acquisition year of maize landraces collected in the Republic of Macedonia

Number	GB ID	Gene bank	Collection site	Acquisition year
1	FZNH010040001	MK	Štip	2014
2	ZP 1818	SRB	Štip	1982
3	FZNH010040037	MK	Probištip	2014
4	ZP 1819	ZP	Probištip	1982
5	ZP 1820	ZP	Probištip	1982
6	FZNH010040036	MK	Probištip	2014
7	ZP 1822	ZP	Probištip	1822
8	FZNH010040052	MK	Štip	2014
9	FZNH010040006	MK	Kavadarci	2014
10	ZP 1682	ZP	Kavadarci	1978
11	FZNH010040010	MK	Kočani	2014
12	ZP 1969	ZP	Kočani	1984
13	FZNH010040058	MK	Štip	2014
14	ZP 1172	ZP	Štip	1974
15	FZNH010040018	MK	Gostivar	2014
16	ZP 1086	ZP	Gostivar	1973
17	FZNH010040060	MK	Delčevo	2014
18	ZP 2223	ZP	Delčevo	1989
19	FZNH010040030	MK	Skopje	2014
20	ZP 1642	ZP	Skopje	1978
21	ZP 1643	ZP	Skopje	1978
22	ZP 1645	ZP	Skopje	1978
23	FZNH010040031	MK	Debar	2014
24	ZP 1090	ZP	Debar	1973
25	ZP 1091	ZP	Debar	1973
26	ZP 1093	ZP	Debar	1973
27	FZNH010040050	MK	Štip	2014
28	ZP 1141	ZP	Štip	1973

## Results and Discussion

With 12 SSR loci distributed uniformly over all ten maize chromosomes, in total 44 alleles were detected among 28 landraces of which 42 were polymorphic. The number of alleles per primer was in a range from 2 to 7 with an average of 3.67 alleles per locus. The average alleles per marker was higher than that found by Molin *et al.* (2013), who assessed 48 maize landraces with 47 markers with an average of 2.9 fragments per marker. The genetic analysis of maize accessions based on SSR polymorphism categorized landraces into the four gene pools (Fig.1). The accessions were grouped according to collecting sites: in the first sub-cluster were accessions collected in the area surrounding Debar and Skopje. Six of them were from MRIZP gene bank, and three were from MK gene bank. The second group mostly consists of landraces, collected in the western part of Macedonia (Gostivar and Debar). The third and fourth sub-clusters consist of samples collected in the eastern part of Macedonia (Štip, Probištip and Kavadarci).

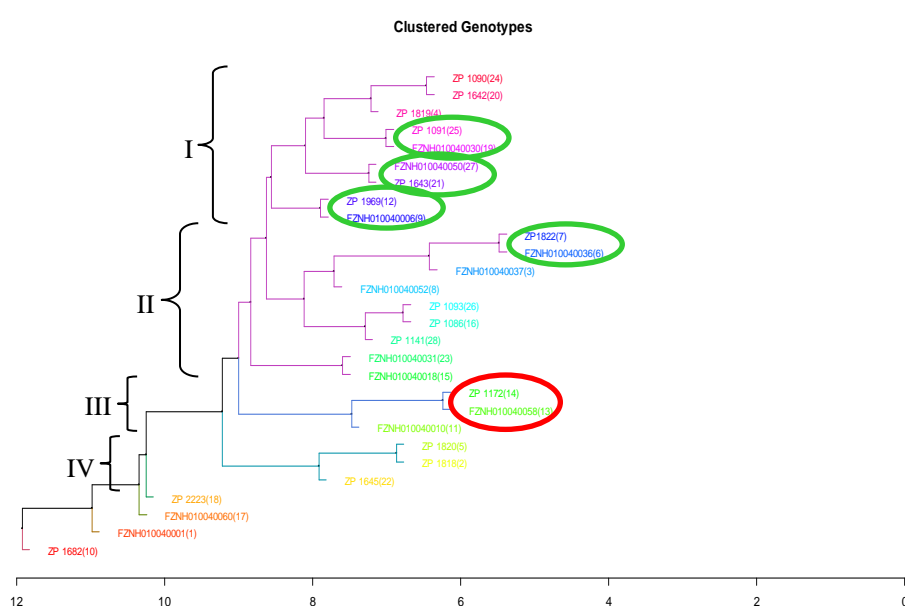


Figure 1. Classification of genetic similarity of maize landraces based on SSR markers, generated by UPGMA cluster analysis.

In the present study, based on SSR markers, maize landraces from the same small area were in the group with genetically similar accessions (Fig.1). Interestingly, ten accessions (five from MRIZP gene bank and five from MK gene bank), collected in different time-scale in the same area, were clustered in pairs.

For ten landraces (five from MK and five from MRIZP genebank) that paired together on dendrogram (Fig. 1.), additional SSR analysis with the same set of primers was performed (Fig 2).

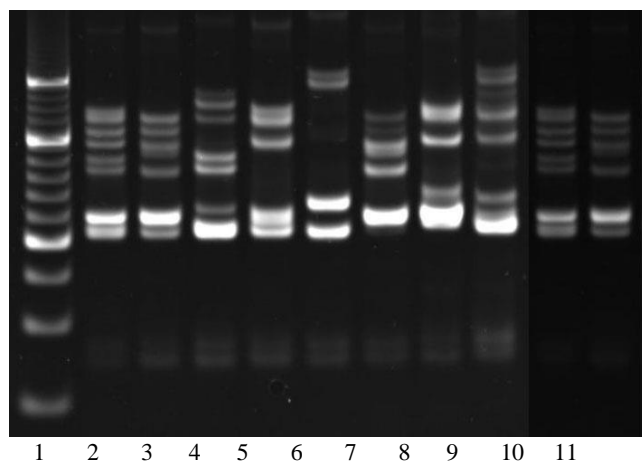


Figure 2 PCR amplification products of 10 landraces with UMC1506 marker. Line 1 20bp DNA Ladder, line 2 ZP 1172, line 3 FZNH010040058, line 4 ZP 1643, line 5 FZNH010040050, line 6 ZP 1091, line 7 FZNH010040030, line 8 ZP 1969, line 9 FZNH010040006, line 10 ZP1822, line 11 FZNH010040036

After pairwise comparison of these samples, by the same set of SSRs, we have obtained high percentage of similarity among pairs (0.687 to 0.844). They were genetically heterogeneous with low probability to be completely identical, but they shared very similar genetic background. The pair ZP 1172 and FZNH010040058, had the highest similarity and could be treated as duplicate for MRIZP gene bank.

As a result of the higher levels of variation that are usually detected with molecular markers, possible duplicates will rarely found to be completely identical. Therefore, verification of probable duplicates using molecular markers is not simply a matter of determining whether two accessions are identical or not, but rather whether they are sufficiently different in order to consider them distinct accessions (Treuren and Hintum, 2003). Application of DNA markers, unaffected by environment, successfully discriminate closely related genotypes and possible duplicate accessions in many crops (Börner *et al.*, 2000; Lund *et al.*, 2003). Identification of absolute genetically identical samples is possible only by comparison of complete genome, that is not necessary for samples considered as duplicates in genebank (Treuren *et al.*, 2001).

### Conclusion

Further comparison and molecular analysis of the rest of the accessions originated from Macedonia are recommended for both gene banks, in order to lower costs of maintenance and regeneration of possible duplicates, and to increase efficiency of gene bank management and usage of collections. Assessment of the accessions within gene bank and identification of variation on morphological and molecular level are also, very valuable for development of core collections and utilisation in breeding, as well as for rationalisation and elimination of redundant germplasm.

### Acknowledgement

This work was supported by Ministry of Education, Science and Technological Development, Republic of Serbia, through the project TR31068.

## References

- Andjelkovic V. and Ignjatovic-Micic D. (2012): Maize genetic resources- Science and benefits. Publisher: Serbian Genetic Society and Maize Research Institute „Zemun Polje“, ISBN 978-86-87109-07-0 (SGS).
- Barcaccia G., Volpato M., Gentili R., Abeli T., Galla G., Orsenigo S., Citterio S., Sgorbati S., Rossi G. (2016): Genetic identity of common buckwheat (*Fagopyrum esculentum* Moench) landraces locally cultivated in the Alps. *Genetic Resources and Crop Evolution* 63: 639-651.
- Bourguiba H., Krichen L., Audergon J.M., Khadari B., Trifi-Farah N. (2010): Impact of mapped SSR markers on the genetic diversity of apricot (*Prunus armeniaca* L.) in Tunisia. *Plant Molecular Biology Reporter* 28: 578-587.
- Börner A., Chebotar S., Korzun V. (2000): Molecular characterisation of the genetic integrity of wheat (*Triticum aestivum* L.) germplasm after long-term maintenance. *Theoretical and Applied Genetics* 100: 494-497.
- Cömertpay G., Baloch F.S., Kilian B., Ülger A.C., Özkan H. (2012): Diversity assessment of Turkish maize landraces based on fluorescent labelled SSR markers. *Plant Molecular Biology Reporter* 30: 261-274.
- Hintum Th.J.L. van and Knüpfper H. (1995): Duplication within and between germplasm collections. I. Identification of duplication on the basis of passport data. *Genetic Resources and Crop Evolution* 42: 127-133.
- Ignjatovic-Micic D., Mladenovic Drinic S., Nikolic A., Lazic-Jancic V. (2008): SSR analysis for genetic structure and diversity determination of maize local populations from former Yugoslavia territories. *Russian Journal of Genetics* 44 (11): 1317–1324.
- Ivanovska S. and Jankulovska M. (2016): Contribution of women to in-situ conservation of agrobiodiversity in Macedonia. *Proceedings of Women in Science and Technology for the Developing World Fifth General Assembly and International Conference, May 16-19, 2016, Kuwait, in press.*
- Jaccard P. (1908): Nouvelles recherches sur la distribution a florale. *Bulletin Societe Vaudoise des Sciences Naturelle* 44:223–270.
- Lund B., Ortiz R., Skogaard I.M., Waugh R. (2003): Analysis of potential duplicates in barley gene bank collections using re-sampling of microsatellite data. *Theoretical and Applied Genetics* 106:1129-1138.
- Mercati F., Longo C., Poma D., Araniti F., Lupini A., Mammano M.M., Fiore M.C., Abenavoli M.R., Sunseri F. (2015): Genetic variation of an Italian long shelf-life tomato (*Solanum lycopersicum* L.) collection by using SSR and morphological fruit traits. *Genetic Resources and Crop Evolution* 62:721-732.
- Molin D., Coelho C.J., Máximo D.S., Ferreira F.S., Gardingo J.R. and Matiello R.R. (2013): Genetic diversity in the germplasm of tropical maize landraces determined using molecular markers. *Genet. Mol. Res.* 12 (1): 99-114.
- Rebourg C., Gouesnard B., Charcosset A. (2001): Large scale molecular analysis of traditional European maize populations. Relationships with morphological variation. *Heredity* 86: 574-587.
- Saghai-Marouf M.A., Soliman K.M., Jorgensen R.A., Allard R.W. (1984): Ribosomal DNA spacer-length polymorphism in barley: Mendelian inheritance, chromosomal location, and population dynamics. *Proceedings of National Academy of Science of USA* 81:8014-8018.

- Senior M.L., Murphy J.P., Goodman M.M., Stuber C.W. (1998): Utility of SSRs for determining genetic similarities and relationships in maize using an agarose gel system. *Crop Science* 38:1088-1098.
- Sharma P.N., Díaz L.M., Blair M.W. (2013): Genetic diversity of two Indian common bean germplasm collections based on morphological and microsatellite markers. *Plant Genetic Resources* 11 (2):121-130.
- Treuren R. van, Soest L.J.M. van, Hintum Th.J.L. van (2001): Marker-assisted rationalisation of genetic resource collections: A case study in flax using AFLPs. *Theoretical and Applied Genetics* 103:144-152.
- Treuren R. van and Hintum Th.J.L. van (2003): Marker-assisted reduction of redundancy in germplasm collections: genetic and economic aspects. *Acta Horticulturae* 623: 139-149.

## FLORISTIC COMPOSITION AND ABUNDANCE OF WEED COMMUNITY IN MAIZE UNDER DIFFERENT FERTILIZATION TREATMENT

Snežana OLJAČA\*<sup>1</sup>, Milena SIMIĆ<sup>2</sup>, Željko DOLIJANOVIĆ<sup>1</sup>, Vesna DRAGIČEVIĆ<sup>2</sup>, Mićo OLJAČA<sup>1</sup>

<sup>1</sup>University of Belgrade, Faculty of Agriculture, Nemanjina 6, 11080 Belgrade, Serbia

<sup>2</sup>Maize Research institute Zemun Polje, S. Bajića 1, 11080 Belgrade, Serbia

\*Corresponding author: soljaca@agrif.bg.ac.rs

### Abstract

This paper deals with results of the effects of different fertilizers on floristic composition and abundance of weeds in maize. The survey was conducted during two-year period (2014-2015) in white maize hybrid ZP 655b. Trial was set up on chernozem soil type in the experimental field of Maize Research Institute in Zemun Polje, Serbia. The objective of the study was to identify floristic composition of weeds, their abundance and biomass in regard to different fertilization treatment. The treatments of fertilization consisted of following variants: control, mineral fertilizer AN, microbiological fertilizer Uniker and organic fertilizer under the trade name „Humus Vita Stallatico“. The fields were surveyed according to the quantitative survey method by using a 1 m x 1 m quadrat with 4 samples of quadrat from each 20m<sup>2</sup> plot. On the basis of two-year results it is obvious that meteorological conditions have very significant influence on floristic composition and abundance of weed community in maize. A total 17 different species in both seasons, with 3 grasses and 14 broadleaves, were identified. The weediness in both years was relatively high but significantly higher in 2015. Average weed density in the plots was 26 plants per m<sup>2</sup> in 2014 and 31 plants per m<sup>2</sup> in 2015. According to results, the fresh and dry biomass of weeds was significantly higher in treatment with microbiological fertilizer in both years followed by treatment with organic fertilizer. Based on abundance and biomass the annual weeds *Solanum nigrum* L. and *Chenopodium hybridum* L. were the most dominant species in 2014, while perennial weed *Sorghum halepense* L. and annual weeds *Bilderdykia convolvulus* (L.) Dum. and *Portulaca oleracea* L. were the most dominant species in 2015. The major percentage of the species falls under the life forms Therophytes and Geophytes, which have been assessed after comparison with the normal world spectrum as proposed by Raunkiaer.

**Keywords:** floristic composition, weed abundance, biomass, maize, fertilizer.

### Introduction

The distribution of weeds can be influenced by ecological and human factors. Human can influence weed flora distribution through agronomic management like plant establishment system, irrigation and use of fertilizer amount and type, rate and effectiveness of herbicides application (Raya et al. 2013; Stefanović et al 2011). Variety of weeds can be found in agricultural fields which could affect the yield potential of crops adversely.

Many agronomic management such as tillage (Kovačević and Momirović 1996; Légère et al. 2008; Swanton et al. 1999), crop rotation (Anderson et al. 1998; Kovačević and Momirović 2008) and fertilization (Pyšek and Lepš 1991; Storkey et al. 2010) have a direct influence on the floristic composition and density of weed communities. Fertilization not only affects the growth of crops but also impacts on a range of selection pressures that potentially affect weed populations, and thus it is an important component of integrated weed management programs

(Simić 2003; Blackshaw and Molnar 2009; Simić et al. 2016). Different soil fertility management practices create a range of microsite conditions for plant species to germinate and establish, and a combination of abiotic (management, climate, etc.) and biotic (pathogens, competition, etc.) ‘filters’ formed has been considered to constrain weed community assembly (Ryan *et al.* 2010). Previous studies have demonstrated that fertilization greatly affects weed species composition, abundance, density, and diversity (Hyvönen and Salonen 2002; Moss et al. 2004; Wan et al. 2012; Simić et al. 2016). Fertilization may influence weed composition indirectly by influencing nutrient and radiation competition between crops and weeds (Simić and Stefanović 2007; Pyšek and Lepš 1991).

### Materials and Methods

A two year (2014-2015) field experiment was conducted at the Maize Research Institute in Zemun Polje, Belgrade, Serbia. Trial was set up on chernozem soil type in the experimental field. White maize hybrid ZP 655b from the collection of Maize Research Institute Zemun Polje was selected for this study. The treatments of fertilization consisted of following variants: control (with no fertilizer), mineral fertilizer AN (ammonium-nitrate 34.4% N) in amount of 75 kg ha<sup>-1</sup> N, microbiological fertilizer Uniker in amount of 10 l/ha and organic fertilizer under the trade name „Humus Vita Stallatico" in amount of 1.5 t ha<sup>-1</sup>. Uniker is microbiological fertilizer witch consisted of following strains of bacteria: *Bacillus megaterium*, *Bacillus lichenioirmis* and *Bacillus subtilis*. It is applied by incorporation into soil prior to sowing, in order to improve soil microbiological activity and increase mineralization of organic matter. „Humus Vita Stallatico" is composted organic fertilizer made from cattle and poultry manure with high content of humified organic matter (48%) and fulvo (9%) and humic acid (10%). Content of nitrogen, phosphorus and potassium is nearly equal with over 3% for each macroelement. The objective of the study was to identify floristic composition of weeds, their abundance and biomass in regard to different fertilization treatment. The fields were surveyed according to the quantitative survey method by using a 1 m x 1 m quadrat with 4 samples of quadrat from each 20m<sup>2</sup> plot. Plants present in quadrats were recorded, sampled, sorted to species level counted and then dried and weighed.

Data was analyzed statistically using analysis of variance and LSD<sub>0.05</sub> were used for comparison, when main effects or interactions were statistically significant.

### Results and Discussion

Meteorological data on the experimental field during two years of trial are shown on Figures 1 and 2. The data shows better meteorological conditions in the first year of this experiment. This year is characterized by big amounts of rainfall (annual sum was 858.4 mm) specially in May and July (Figure 1). Annual temperature mean 13.9 °C was significantly higher than long term temperature mean for Zemun Polje. Relatively high average monthly air temperature was in July and August 23.2°C and 22.6°C, respectively. The second year of experiment 2015 had significantly smaller amount (587.7 mm) and bad rainfall distribution compared with first year. Severe drought is appeared from June to August (Figure 2). Regarding temperature conditions in this period, extremely high temperature means is recorded in July (26.4 °C) and August, (25.7 °C).

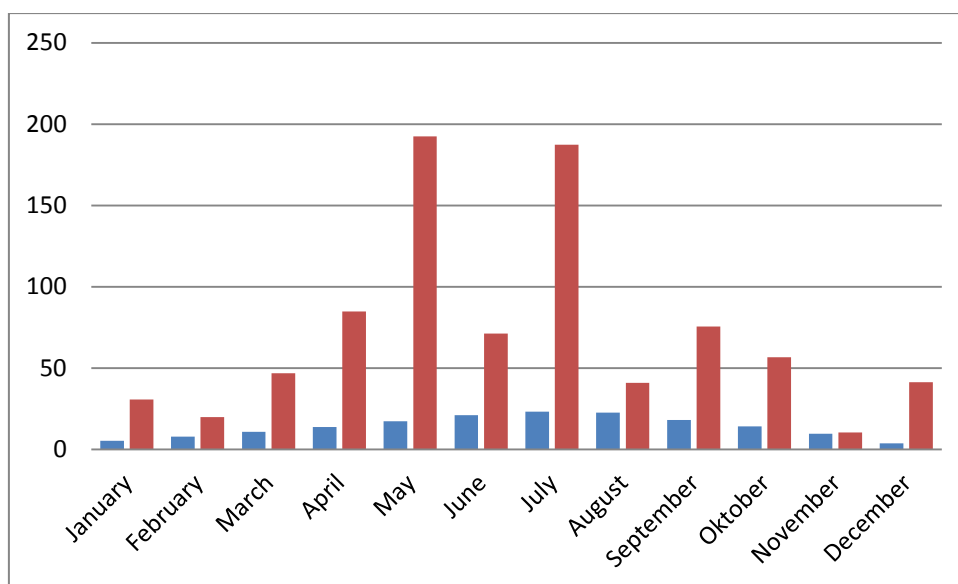


Figure 1. Temperature and precipitation in 2014

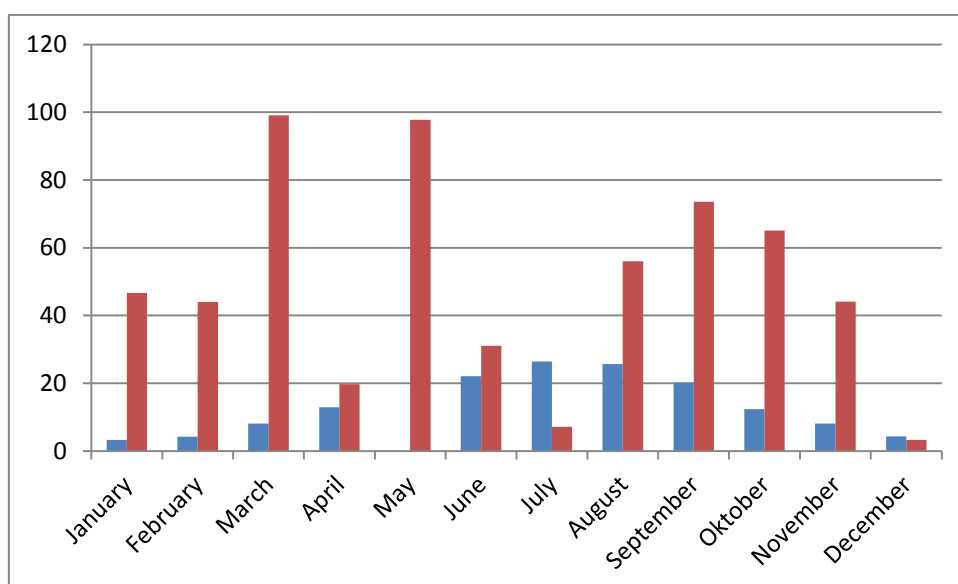


Figure 2. Temperature and precipitation in 2015

A total 17 different species in both seasons, with 3 grasses and 14 broadleaves, were identified (Table 1). The major percentage of the species falls under the life forms Therophytes (14) and Geophytes (3), which have been assessed after comparison with the normal world spectrum as proposed by Raunkiaer. The weed seed bank of maize fields in Zemun Polje is largely dominated by species of the families *Poaceae* (3), *Amaranthaceae* (3), *Polygonaceae* (3), *Chenopodiaceae* (2) and *Solanaceae* (2). Ecological analysis of weed community of maize indicates that thermophile (T4, T5; average T=4.2), heliophile (L4, L5; average L=4.1) species are dominant, also species with preferences of dry or semi-dry habitats (average F=2.6). All these findings are very similar with the results presented by Stefanović et al 2011. Comparing with ecological requirements of maize (thermophile, heliophile, adapted on semi-dry habitats) these results indicate that weeds are very compatible with these requirements. This is one of the proofs which tell us about great weeds adaptability and strong competition ability towards crops.



Table 1. Floristic composition of weed community, life forms and ecological indices

Abbreviation	Species	Life form	Ecological index
CYNDA	<i>Cynodon dactylon</i> (L) Pers	G1	F2, R3, N3, H3, D3, L4, T5.
SORHA	<i>Sorghum halepense</i> L.	G1	F1, R2, N3, H3, D3, L4, T5.
CONAR	<i>Convolvulus arvensis</i> L.	G3	F2, R4, N3, H3, D4, L4, T4.
AMAAL	<i>Amaranthus albus</i> L.	T4	F4, R3, N4, H3, D3, L4, T4.
SOLNI	<i>Solanum nigrum</i> L.	T4	F3, R4, N4, H3, D4, L4, T4.
BILCO	<i>Bilderdykia convolvulus</i> (L.) Dum.	T4	F2, R3, N3, H3, D3, L4, T4.
CHEHY	<i>Chenopodium hybridum</i> L.	T4	F2, R3, N3, H4, D4, L4, T3.
HIBTR	<i>Hibiscus trionum</i> L.	T4	F3, R3, N3, H3, D5, L4, T5.
AMAHY	<i>Amaranthus hybridus</i> L.	T4	F4, R3, N4, H3, D3, L4, T4.
CHEAL	<i>Chenopodium album</i> L.	T4	F3, R4, N3, H3, D3, L4, T4.
POROL	<i>Portulaca oleracea</i> L.	T4	F3, R3, N3, H3, D3, L5, T3.
AMARE	<i>Amaranthus retroflexus</i> L.	T4	F3, R3, N4, H3, D3, L4, T4.
POLLA	<i>Polygonum lapathifolium</i> L.	T4	F3, R3, N3, H3, D3, L5, T3.
DATST	<i>Datura stramonium</i> L.	T4	F3, R3, N4, H4, D4, L4, T5.
ABUTE	<i>Abutilon theophrasti</i> Medik.	T4	F2, R3, N4, H3, D4, L4, T5.
AMBAR	<i>Ambrosia artemisiifolia</i> L.	T4	F2, R3, N4, H2, D2, L4, T5.
PANCG	<i>Panicum crus-galli</i> L.	T4	F3, R3, N5, H3, D4, L3, T4.
Average			2.6, 3.1, 3.5, 3.1, 3.4, 4.1, 4.2

On the basis of two-year results it is obvious that meteorological conditions have very significant influence on floristic composition and abundance of weed community in maize. The weediness in both years was relatively high but significantly higher in 2015. Average weed density in the plots was 26 plants per m<sup>2</sup> in 2014 and 31 plants per m<sup>2</sup> in 2015 (Tables 2 and 3). According to results, the fresh and dry biomass of weeds was significantly higher in treatment with microbiological fertilizer in both years followed by treatment with organic fertilizer.

Table 2. Number and biomass of weeds in 2014

Species	Number of weeds					Fresh biomass of weeds (g m <sup>-1</sup> )				
	B <sub>1</sub>	B <sub>2</sub>	B <sub>3</sub>	B <sub>4</sub>	Aver.	B <sub>1</sub>	B <sub>2</sub>	B <sub>3</sub>	B <sub>4</sub>	Aver.
SORHA	6	3	4	4	4.3a	93.4	81.8	330.8	142.8	162.2b
CONAR	2	2	4	2	2.5b	33.2	80.1	112.3	90.8	79.1b
AMAAL		3	1	2	1.5c		52.0	71.8	17.9	35.4c
SOLNI	4	4	7	8	5.8a	69.1	104.9	304.3	541.3	254.9a
BILCO	2	0	2	0	1.0c	20.9	0	19.3	0	10.1c
CHEHY	4	5	5	8	5.5a	171.3	136.1	193.2	381.7	220.6a
HIBTR	1	0	1	2	1.0c	48.1	0	25.0	79.4	38.1c
AMAHY	0	2	1	0	0.8c	0	94.9	46.8	0	35.4c
CHEAL	3	3	2	2	2.5b	83.5	149.8	120.3	98.5	113.0b
POROL	0		2	1	0.8c			65.2	28.7	23.5c
AMARE		0	1	1	0.5c			35.1	14.3	12.4c
POLLA		0	1	0	0.3c			37.7	0	9.4c
Sum	22a	22a	31b	30b	26.3	519.5a	699.6b	1361.8c	1395.4c	994.1
Dry biomass						102.8	116.3	233.1	218.8	167.8

B<sub>1</sub>-control, B<sub>2</sub>-mineral fertilizer, B<sub>3</sub>-microbiological fertilizer, B<sub>4</sub>- organic fertilizer

Means in columns followed by the same letter are not significantly different according to LSD values ( $P = 0.05$ )

Table 3. Number and biomass of weeds in 2015

Species	Number of weeds					Fresh biomass of weeds (g m <sup>-1</sup> )				
	B <sub>1</sub>	B <sub>2</sub>	B <sub>3</sub>	B <sub>4</sub>	Aver.	B <sub>1</sub>	B <sub>2</sub>	B <sub>3</sub>	B <sub>4</sub>	Aver.
SORHA	14	8	13	10	11.3a	656.4	495.5	692.1	686.4	632.6a
DATST	7	1	2	0	2.5b	421.2	60.4	182.8	0	166.1b
CONAR	0	2	1	4	1.8b	0	38.1	18.3	65.3	30.4c
AMAAL	1	0	0	0	0.3c	11.2	0	0	0	2.8d
ABUTE	2	8	3	3	4.0b	53.3	254.6	59.6	57.3	106.2b
BILCO	4	2	4	2	3.0b	350.2	142.6	458.7	24.4	243.9b
HIBTR	4	1	2	1	2.0b	144.9	25.5	19	31.3	55.2c
AMAHY	1	0	4	1	1.5c	41.7	0	96.5	50.2	47.1c
CHEAL	0	1	0	1	0.5c	0	47.2	0	51.1	24.6c
POROL	3		4	1	2.0b	303.4	147.3	348.2	227.4	256.6b
AMARE		1	0	1	0.5c		18.6	0	45.5	16.0d
CYNDA	1	0	3	0	1.0c	6		33.9	0	10.0d
AMBAR	0	1			0.3c		31.5			7.9d
PANCG			1	2	0.8c			44.3	78.8	30.8c
Sum	37a	25b	37a	26b	31	1988.3a	1261.3b	1953.4a	1317.7b	1630.2
Dry biomass						414.9	246.9	410.4	282.8	338.8

B<sub>1</sub>-control, B<sub>2</sub>-mineral fertilizer, B<sub>3</sub>-microbiological fertilizer, B<sub>4</sub>- organic fertilizer

Means in columns followed by the same letter are not significantly different according to *LSD* values ( $P = 0.05$ )

Based on abundance and biomass the annual weeds *Solanum nigrum* L. and *Chenopodium hybridum* L. were the most dominant species in 2014, while perennial weed *Sorghum halepense* L. and annual weeds *Bilderdykia convolvulus* (L.) Dum. and *Portulaca oleracea* L. were the most dominant species in 2015.

Weeds differ substantially in their response to fertilization. Some weed species (*C. album*) prefer mineral fertilizer AN in favorable 2014 season, while *S. nigrum* and *C. hybridum* gave the highest biomass on plots with organic fertilizer. In dryer 2015 *S. halepense* was abundant in the B3 and B4 treatments (microbiological and organic), whereas *A. theophrasti* dominated in the B2 (mineral fertilizer AN) treatment and *D. stramonium* dominated in the treatment B1 without fertilizer.

The influence of fertilization on weeds depends on the type and quantity of fertilizers, biological crop properties, agronomic management, time and method of fertilization, floristic composition of the weed community. Most of the weed species are characterized by the rapid growth of vegetative biomass and high fertility and because of that they use large amounts of mineral nutrients. Therefore, fertilization can be a powerful factor of influence on weed community in agro-phytocenosis. As some weed species react differently to the content of nutrients, this measure leads to the domination of those species that have adapted to the large amount of nitrogen in the soil (species of the genus *Amaranthus* and *Chenopodium*).

### Conclusion

According to the obtained results during investigations of effects of fertilization on floristic composition and abundance of weeds in maize in Zemun Polje the following conclusions can be made: meteorological conditions have very significant influence on floristic composition and abundance of weed community in maize. The weediness in both years was relatively high but significantly higher in 2015.

A total 17 different species in both seasons, with 3 grasses and 14 broadleaves, were identified. The major percentage of the species falls under the life forms Therophytes (14) and

Geophytes (3). Ecological analysis of weed community of maize indicates that thermophile and heliophile species are dominant, also species with preferences of dry or semi-dry habitats. The fresh and dry biomass of weeds was significantly higher in treatment with microbiological fertilizer in both years followed by treatment with organic fertilizer. Based on abundance and biomass the annual weeds *Solanum nigrum* L. and *Chenopodium hybridum* L. were the most dominant species in 2014, while perennial weed *Sorghum halepense* L. and annual weeds *Bilderdykia convolvulus* (L.) Dum. and *Portulaca oleracea* L. were the most dominant species in 2015.

Better supply of the nutrients causes more emergence of weeds, but at the same time, with the growing competition of crops, weeds are lagging behind in their development and more or less suppressed. Some weed species or ecological groups of weeds can be controlled by regulating the content of particular nutrients, pH and other soil properties. Further research on nutrient limitation and on the biology of individual weed species is needed in order to control the negative effects of farmland weeds on crop yield while maintaining a diverse weed community.

### Acknowledgement

This experiment has been carried out with funding from the Serbian Ministry of Education, Science and Technological Development in the frame of the project TR - 31037.

### References

- Anderson RL., Tanaka DL., Black AL. (1998). Weed community and species response to crop rotation, tillage, and nitrogen fertility. *Weed Technol*, 12: 531-6.
- Blackshaw RE., Molnar LJ. (2009). Phosphorus fertilizer application method affects weed growth and competition with wheat. *Weed Sci*, 57:311-18.
- Hyvönen T., Salonen J. (2002). Weed species diversity and community composition in cropping practices at two intensity levels: a six-year experiment. *Plant Ecol*, 154: 73-81.
- Kovačević D., Momirović N. (1996). Intergrated weed control measures in modern maize production technologies. *Acta herbologica*, 5(1): 5-26.
- Kovačević D. (2008). Weeds of field crops - Biology and control. Monograph, Faculty of Agriculture, Belgrade University, pp. 520.
- Kovačević D., Momirović N. (2008). Role of cropping measures in weed control in modern development of agriculture. *Acta Biologica Iugoslavica (Serija G), Acta Herbologica*, 17(2):23-38.
- Légère A., Stevenson FC., Ziadi N. (2008). Contrasting responses of weed communities and crops to 12 years of tillage and fertilization treatment. *Weed Technol*, 22: 309-17.
- Moss SR., Storkey J., Cussans JW. (2004). The broadbalk long-term experiment at Rothamsted: what has it told us about weeds? *Weed Sci*, 52: 864-73.
- Pyšek P., Lepš J. (1991). Response of a weed community to nitrogen fertilization: a multivariate analysis. *J Veg Sci*, 2: 237-44.
- Raya KB., Ahmed SH., Juraimi AS., Abu Bakar R., Uddin K. (2013). Floristic composition of weed community in selected vegetable fields in Selangor, Malaysia. *Journal of Food, Agriculture & Environment*, 11 (3&4): 1659-1663.
- Ryan MR., Smith RG., Mirsky SB. (2010). Management filters and species traits: weed community assembly in long-term organic and conventional systems. *Weed Sci*, 58: 265-77.

- Simić M. (2003). Sezonal dynamic of weed synuzia, competitiveness and productivity of maize in integral weed control systems. PhD Thesis. Faculty of Agriculture, Belgrade University, pp 199.
- Simić M., Stefanović, L. (2007). Effects of maize density and sowing pattern on weed suppression and maize grain yield. *Pesticides & Phytomedicine*, 22: 93-103.
- Simić M., Dragičević V., Dolijanović Ž., Oljača S., Brankov M. (2016): Importance of fertilization in the system of integrated measures for weed control in maize. X Weed Congress, Vrdnik, Abstract Proceedings, 38.
- Stefanović L., Simić M., Šinžar B. (2011). Weed control in maize agroecosystems. Maize research Institut Zemun Polje, Belgrade, pp 678.
- Storkey J., Moss SR., Cussans JW. (2010). Using assembly theory to explain changes in a weed flora in response to agricultural intensification. *Weed Sci*. 58: 39-46.
- Swanton CJ., Shrestha A., Roy RC. (1999). Effect of tillage systems, N, and cover crop on the composition of weed flora. *Weed Sci*, 47: 454-61.
- Wan KY., Tao Y., Li RH. (2012). Influences of long-term different types of fertilization on weed community biodiversity in rice paddy fields. *Weed Biol Manag*, 12: 12-21.

## THE WHEAT PLANT HEIGHT AND SPIKE TRAITS PHENOTYPIC VARIATION AS A RESPONSE TO ABIOTIC STRESS CONDITION OF HALOMORPHIC SOIL

Sofija PETROVIĆ<sup>1\*</sup>, Miodrag DIMITRIJEVIĆ<sup>1</sup>, Borislav BANJAC<sup>1</sup>, Mirela MATKOVIĆ STOJŠIN<sup>2</sup>, Velimir MLADENOV<sup>1</sup>

<sup>1</sup>Faculty of Agriculture, University of Novi Sad, Novi Sad, Serbia

<sup>2</sup>Faculty of Biofarming, John Naisbitt University, Backa Topola, Serbia

\*Corresponding author: sonjap@polj.uns.ac.rs

### Abstract

An increment of human population and limitations of resources on planet Earth require a novel approach in agriculture. One of the ways to fulfill these requirements is to using a less productive land. Utilization of marginally suitable land is an ongoing process. However, a novel genetic variability is required, as well as, the testing of the existing genetic variation for the best possible utilization of these soils. There is about 120000ha of halomorph soil, solonetz type in Serbia, mainly used as a pasture. The results in this study represent a part of multiyear research of wheat genetic variation grown in abiotically stressful condition of high sodium content of solonetz soil. Three wheat varieties, namely, NSR 5, Pesma and Renesansa were tested for the reaction, through phenotypic variation, in parallel three years trial on chernozem and solonetz soil for plant height and the spike productivity traits, spike length and weight, grain number and weight per spike, and the spike index (SI). Phenotypic variation of individual plants plays more significant role in the grain yield formation in stressful conditions. The variation was examined using AMMI analysis. According to AMMI ANOVA, statistically significant influence of the environment on total trial variation was denoted, as well as, genotype by environment interaction. Results indicate the occurrence of desirable variation within the existing genetic variability that could be exploited to enhance the use-value of less productive land for food production.

**Keywords:** *wheat, soil, stress, yield components.*

### Introduction

The situation human race is facing today and in the future goes as follows - The exact number of people on Earth on 4<sup>th</sup> of July, 2017, at 13:12 hours was 7,516.011.857. Three minutes later human population grew to 7,516.012.328, souls (Worldometers, 2017). During the 20<sup>th</sup> Century, the population has grown from 1.7 to 6 billion people. By the 2050, the number of *Homo sapiens* individuals in the World is going to reach 9.1 billion. According to UN estimation food production requires an increment of 70% to meet projected demands in 2050. Annual cereal production will need to rise from 2.1 billion today to about 3 billion tonnes. However, the ongoing processes are urbanization (predicted ratio of urban population in 2050 is 70%, comparing to 49% of today), environmental erosion including arable land degradation and climate change (Wilkinson and McElroy, 2007; FAO, 2009; Myers *et al.*, 2017). There is a heavy burden on agriculture to meet the challenge in producing more food, adapt to climate change and adopt more sustainable and efficient mode of production. Moreover, priorities have to be seriously readjusted, for example, according to SIPRI (2017), World military spending in 2016 was 1.69 trillion dollars, while global investments in the food and agribusiness sector in 2013 were a bit more than 100 billion dollars (Goedde *et al.*, 2015). Every available resource is to be utilized, research efforts has to be strengthened, and the attitude towards planet Earth limited resources should be much wiser. In order to contribute to an overall effort, to get more experience and eventual useful results in broadening primary

food production, multiyear trials have been established to investigate the influence of halomorphic soil abiotic stress growth conditions on phenotypic variation of broad cereal, bread wheat predominantly, gene pool. The null hypothesis was that the existing genetic variability of semi-dwarf intensive breaded wheat varieties harbor usable gene variation for enhancing tolerance to solonetz soil abiotic stress growth condition. The aim of this article is to follow phenotypic variation of grain yield height and spike traits of three bread wheat varieties that were selected from larger wheat genetic variability.

### Material and Methods

Three bread wheat varieties, NSR 5, Pesma and Renesansa were singled out of a large testing sample that have been put in a multiyear trials, because of its performance through the long-term trial. Variety NSR 5, is an early genotype that was better adapted to unfavorable growth conditions, reacting well to agro environmental conditions improvement. Variety Pesma exhibited the favorably variation of genotype by environment interaction (GEI), on average, over positive environmental variation. This reaction was followed with mean grain yield value above trial average. Variety Renesansa reacted to environmental variation showing slightly enhanced GEI that meant favorable response to agro environmental improvement. Though, somewhat more sensitive to environmental variation than variety Pesma, variety Renesansa had grain yield average, commonly, above the experimental mean value (Petrović *et al.*, 2008, 2009; Dimitrijević *et al.*, 2009, 2011). The experiment was established in three years 2013/14, 2014/15, and 2015/16, at two localities: Kumane village (45.5219940N, 20.1949190E, pH = 9.86) on solonetz soil, and Rimski Šančevi experimental field of the Institute of Field and Vegetable Crops in Novi Sad (45.3249360N, 19.8428830E, pH=6.86) on chernozem, as a parallel control with intensive agricultural practice and the absence of constant stressful growth variation. Plant spike traits, plant height (cm), spike length (cm), spike weight (g), grain weight per spike (g), grain number per spike, and spike index (the ratio between grain weight per spike and spike weight), were followed. The existing genetic variability was tested in Randomized Complete Block Design trial with three replications, in 1m long rows 20 cm apart. 150kg/ha of NPK 15:15:15 fertilizer was applied along with sowing, and 200kg/ha of Potassium ammonium nitrate was additionally applied in spring. Elementary statistics, as well as, AMMI model for sources of variation identification and quantification with the emphasis on genotype by environment interaction have been calculated for studied traits. Statistical significance of mean values was estimated by Fisher's Least Significant Distances (LSD) at the levels of 0.05, and 0.01.

### Results and discussion

Statistically significant variation was denoted in the trial. Within additive component of total variation the main source of phenotypic variability was environment, contributing from 60% (plant height) to 75% (grain weight per spike) to the variation of phenotype. Mass traits in contrast to length one, exhibited statistically significant effect of genotype variation in total phenotypic variation. This is the reflection of the gene system that is more quantitative in mass traits than in length one, and the phenotypic variation is more complex in causes. For all the examined yield components genotype by environment (GEI) interaction was statistically significant source of variation showing the presence of cross over interaction, and different reaction to environmental variation wheat varieties in trial. However, the cause of GEI was predominantly carried out on the first principal component (IPCA1), except the spike weight and the grain weight per spike where IPCA2 showed statistically significant, though, rather small effect on GEI (tab. 1).

Table 1. AMMI ANOVA F values statistical significance for plant height (cm), spike length (cm), spike weigh (g), grain weight/spike (g), grain number/spike and spike index for three bread wheat varieties, over six environments

Source	Degree of freedom	F calculated value						F-table	
		Plant height	Spike length	Spike weigh	Grain weight per spike	Grain number per spike	Spike index	0.05	0.01
Total	53	-	-	-	-	-	-	-	-
Treatments	17	61.13**	11.96**	50.36**	59.72**	24.98**	5.61**	2.02	2.74
Genotypes	2	0.63	2.72	15.41**	13.46**	14.53**	9.12**	3.40	5.61
Environments	5	117.78**	42.26**	127.27**	99.74**	44.69**	11.52**	2.62	3.90
Block	12	1.10	0.67	1.01	1.61	1.28	0.67	2.18	3.03
GEI	10	38.92**	5.61**	18.35**	18.70**	10.97**	3.86**	2.26	3.17
IPCA <sub>1</sub>	6	64.12**	7.75**	27.70**	27.36**	17.69**	5.49**	2.51	3.67
Residuals	4	1.12	2.41	4.33**	5.71**	0.89	1.41	2.76	4.22
Error	24	-	-	-	-	-	-	-	-

*Plant height* was close to the trial average for all three varieties over six environments. However, the GEI was quite different. Variety NSR 5 developed the examine trait well in less favorable environmental conditions on this trial results. That is in accordance to Petrović *et al.* (2012), who found NSR-5 as a flexible variety suitable for a wide range of soil conditions. Varieties Pesma and Renesansa performed similarly during the trial (tab. 2).

Table 2. Mean values for plant height (cm), and the first principal component (IPCA) for three bread wheat varieties, over six environments where abbreviations RŠ and KU stand for localities Rimski Šančevi and Kumane

Varieties	Environments						Mean	IPCAg1
	E1 RŠ 2014	E2 KU 2014	E3 RŠ 2015	E4 KU 2015	E5 RŠ 2016	E6 KU 2016		
NSR-5	84.66	75.89	83.64	96.02	94.80	75.06	85.00	-4.91
Pesma	88.39	69.12	94.94	60.66	107.60	93.05	85.62	2.38
Renesansa	87.25	67.76	93.96	58.71	106.60	92.22	84.42	2.53
Mean	86.77	70.92	90.84	71.79	102.98	86.78	85.01	-
IPCAe1	0.43	-1.01	1.47	-4.93	1.67	2.38	-	-

LSD<sub>0.05</sub>=2.6 LSD<sub>0.01</sub>=3.5

*Spike length* had small additive effect differences, with mean values close to trial average, but differed greatly in multiplicative component of phenotypic variation. Varieties Pesma and NSR 5 showed higher GEI. Variety Renesansa was the most stable one, over the examined environmental variation (tab. 3).

Table 3. Mean values for spike length (cm), and the first principal component (IPCA) for three bread wheat varieties, over six environments where abbreviations RŠ and KU stand for localities Rimski Šančevi and Kumane.

Varieties	Environments						Mean	IPCAg1
	E1	E2	E3	E4	E5	E6		
	RŠ 2014	KU 2014	RŠ 2015	KU 2015	RŠ 2016	KU 2016		
NSR-5	9.39	8.52	8.92	9.04	8.63	7.37	8.64	0.95
Pesma	11.41	6.60	9.31	8.55	8.76	8.40	8.84	-1.10
Renesansa	9.86	7.48	8.77	8.55	8.38	7.46	8.42	0.16
Mean	10.22	7.53	9.00	8.59	8.59	7.74	8.63	-
IPCAe1	-0.89	1.03	-0.10	0.03	0.03	-0.41	-	-

LSD<sub>0.05</sub>=0.44 LSD<sub>0.01</sub>=0.60

Spike weight and grain weight per spike were traits of special interest. Though plant grain yield in intensive agriculture has small positive correlation to grain yield per hectare, in stress conditions, stronger positive correlation exists between these two properties (Denčić *et al.*, 2000). Individual plant performance gains importance in abiotic stress growing conditions. In that sense, individual spike productivity represents an important trait that contributes to grain yield formation per area unit in agricultural practice other than intensive (Dimitrijević *et al.*, 2012). Varieties varied more in GEI than in main effect. The different nature of GEI of NSR 5 and varieties Pesma and Renesansa is evident, where Renesansa was the most stable (tab. 4 and 5).

Table 4. Mean values for spike weigh (g), and the first principal component (IPCA) for three bread wheat varieties, over six environments where abbreviations RŠ and KU stand for localities Rimski Šančevi and Kumane

Varieties	Environments						Mean	IPCAg1
	E1	E2	E3	E4	E5	E6		
	RŠ 2014	KU 2014	RŠ 2015	KU 2015	RŠ 2016	KU 2016		
NSR-5	1.16	1.75	3.89	2.57	2.78	1.31	2.24	-0.97
Pesma	2.03	1.37	2.73	0.99	2.72	1.49	1.89	0.68
Renesansa	1.83	1.47	3.02	1.37	2.74	1.46	1.98	0.29
Mean	1.68	1.53	3.21	1.64	2.75	1.42	2.04	-
IPCAe1	0.74	-0.02	-0.48	-0.75	0.18	0.32	-	-

LSD<sub>0.05</sub>=0.04 LSD<sub>0.01</sub>=0.06

Table 5. Mean values for grain weight/spike (g), and the first principal component (IPCA) for three bread wheat varieties, over six environments where abbreviations RŠ and KU stand for localities Rimski Šančevi and Kumane

Varieties	Environments						Mean	IPCAg1
	E1	E2	E3	E4	E5	E6		
	RŠ 2014	KU 2014	RŠ 2015	KU 2015	RŠ 2016	KU 2016		
NSR-5	0.77	1.23	2.88	1.98	2.17	0.79	1.64	-0.84
Pesma	1.20	0.95	2.16	0.70	2.08	1.17	1.38	0.56
Renesansa	1.20	1.08	2.38	1.03	2.17	1.18	1.51	0.29
Mean	1.06	1.09	2.47	1.24	2.14	1.05	1.51	-
IPCAe1	0.50	-0.02	-0.33	-0.73	0.12	0.46	-	-

LSD<sub>0.05</sub>=0.12 LSD<sub>0.01</sub>=0.16



*Grain number per spike* showed the similar pattern of variation sources behavior, like the rest of examined traits. Additive component of phenotypic variability was smaller than multiplicative. Variety NSR 5 reacted differently to environmental variation, showing the higher mean value of the trait, but had the higher value of GEI in the same time. Varieties Pesma and Renesansa were reacted similarly to the same environmental variation. Variety Renesansa had the most stable reaction, but somewhat lower average than the mean of the trial (tab. 6).

Table 6. Mean values for grain number/spike, and the first principal component (IPCA) for three bread wheat varieties, over six environments where abbreviations RŠ and KU stand for localities Rimski Šančevi and Kumane

Varieties	Environments						Mean	IPCAg1
	E1 RŠ 2014	E2 KU 2014	E3 RŠ 2015	E4 KU 2015	E5 RŠ 2016	E6 KU 2016		
NSR-5	31.94	41.35	56.33	47.47	48.32	24.47	41.65	-3.74
Pesma	41.75	27.41	48.16	20.22	47.71	30.14	35.90	2.72
Renesansa	37.44	29.34	48.58	25.65	46.14	26.92	35.68	1.02
Mean	37.04	32.70	51.02	31.11	47.39	27.18	37.74	-
IPCAe1	2.41	-1.27	-0.37	-3.33	0.80	1.77	-	-

LSD<sub>0.05</sub>=3.05 LSD<sub>0.01</sub>=4.13

*Spike index* could be a reliable marker of high yielding varieties that could be recognized “with quite certainty” (in 91% of cases) after spike index between 0.75-0.83, and higher (Kobiljski and Denčić, 1997). If that was so, variety Renesansa appeared to be a very promising one in abiotic stress conditions of solonetz soil at the locality of Kumane, but in 2016, only. Phenotypic variation for this indexed parameter was of complex nature, since it consists of two distinctively polygenic traits. Main and multiplicative sources of variation were observed. Varieties Renesansa and Pesma had considerable higher mean values of SI than NSR 5, with smaller GEI, as well. Once again, varieties Pesma and Renesansa responded better in different environments than the variety NSR 5 (tab. 7).

Table 7. Mean values for spike index, and the first principal component (IPCA) for three bread wheat varieties, over six environments where abbreviations RŠ and KU stand for localities Rimski Šančevi and Kumane

Varieties	Environments						Mean	IPCAg1
	E1 RŠ 2014	E2 KU 2014	E3 RŠ 2015	E4 KU 2015	E5 RŠ 2016	E6 KU 2016		
NSR-5	0.67	0.73	0.72	0.58	0.78	0.61	0.68	-0.33
Pesma	0.65	0.73	0.78	0.72	0.76	0.78	0.74	0.13
Renesansa	0.65	0.73	0.79	0.74	0.77	0.81	0.75	0.19
Mean	0.66	0.73	0.76	0.68	0.77	0.73	0.72	-
IPCAe1	-0.16	-0.12	0.01	0.19	-0.16	0.24	-	-

LSD<sub>0.05</sub>=0.04 LSD<sub>0.01</sub>=0.05

### Conclusions

According to the results, the main source of phenotypic variation for examined traits was of multiplicative nature. Additive sources of variation was partly notable, but small number of genotypes of similar ideotype influenced that environmental variation had a greater share in total variation than genotypes. Variety NSR 5 had better performance in less favorable growth

conditions, while varieties Renesansa and Pesma reacted similarly to close and more favorable environmental variation, but quite differently than NSR 5. Genetic background of the examined varieties harbor usable genetic variation for further improvement of wheat performance in abiotic soil stress growth conditions, hence all other mode of agricultural practice out of intensive. However, genetic usability of the variety NSR 5 and varieties Pesma and Renesansa differs according to breeding goals and, consequently, selection criteria.

### References

- Denčić, S., Kastori, R., Kobiljski, B., Duggan, B. (2000). Evaluation of grain yield and its components in wheat cultivars and landraces under near optimal and drought conditions. *Euphytica*, 113 (1), pp. 43-52.
- Dimitrijević, M., Petrović, S., Mladenov, N., Belić, M., Hristov, N., Banjac, B. and Vukosavljev, M. (2009). Phenotypic reaction of wheat grown on different soil type. *Genetika*, Vol. 41, No. 2, pp. 169 -177.
- Dimitrijević, M., Petrović, S., Belić, M., Banjac, B., Vukosavljev, M., Mladenov, N. and Hristov, N. (2011). The Influence of Solonetz Soil Limited Growth Conditions on Bread Wheat Yield. *Journal of Agricultural Science and Technology*, Volume 5, No.2 (Serial No.33), pp. 194-201.
- Dimitrijević, M., Petrović, S., and Banjac, B. (2012). Wheat breeding in abiotic stress conditions of solonetz. *Genetika*, Vol 44, No. 1, 91 - 100.
- FAO (2009). High Level Expert Forum “How to Feed the World in 2050”. 12-13. October, Rome, Italy.  
[http://www.fao.org/fileadmin/templates/wsfs/docs/expert\\_paper/How\\_to\\_Feed\\_the\\_World\\_in\\_2050.pdf](http://www.fao.org/fileadmin/templates/wsfs/docs/expert_paper/How_to_Feed_the_World_in_2050.pdf)
- Goedde, L., Horii, M., and Sanghvi, S., (2015). Global agriculture’s many opportunities. In McKinsey on Investing, McKinsey & Company, no. 2, pp. 62-64.
- Kobiljski, B., and Denčić, S. (1997). Spike Characteristics – Selection Criterion for Yield in Wheat. *Plant Breeding and Seed Production*, vol. IV, no. 3-4, pp. 17-22. [Orig. in Serbian]
- Myers, S.S., Smith, M.R., Guth, S., Golden, C.D., Vaitla, B., Mueller, N.D., Dangour, A.D., and Huybers, P. (2017). Climate Change and Global Food Systems: Potential Impacts on Food Security and Undernutrition. *Annual Review of Public Health*, Vol. 38, pp. 259-277.
- Petrović, S., Dimitrijević, M., Belić, M., Banjac, B., and Vuković, N. (2008). Genotype by Environment Interaction in Wheat in Different Agroecological Conditions. *Proceedings 43rd Croatian and 3rd International Symposium on Agriculture*, February 18-21, Opatija, Croatia, pp. 282-285.
- Petrović, S., Dimitrijević, M., Belić, M., Banjac, B., and Vukosavljev, M. (2009). Spike stability parameters in wheat grown on solonetz soil.– *Genetika*, Vol. 41, No. 2, 199-205.
- Petrović, S., Dimitrijević, M., Cimpeanu S.M., Bucur, D., Gurita, A.A., Harja, M., Livija Maksimović, L., and Belić, M. (2012). Spike yield stability in wheat grown under stress conditions of alkaline soil. *Journal of Food, Agriculture & Environment*, 10 (2), p. 480-484.
- SIPRI (2017). Military Expenditure. Stockholm International Peace Research Institute.  
<https://www.sipri.org/research/armament-and-disarmament/arms-transfers-and-military-spending/military-expenditure>
- Wilkinson, B.H., and McElroy, J. (2007). The impact of humans on continental erosion and sedimentation. *Geological Society of America Bulletin*, v. 119, no. 1/2; p. 140–156.
- Worldometer (2017). Current World Population. <http://www.worldometers.info/world-population/>

## YIELD COMPONENTS AND GENETIC POTENTIAL OF WINTER BARLEY

Vera ĐEKIĆ<sup>1\*</sup>, Jelena MILIVOJEVIĆ<sup>1</sup>, Vera POPOVIĆ<sup>2</sup>, Snežana BRANKOVIĆ<sup>3</sup>, Miodrag JELIĆ<sup>4</sup>, Kristina LUKOVIĆ<sup>1</sup>, Dragan TERZIĆ<sup>5</sup>

<sup>1</sup>Small Grains Research Centre, Save Kovacevica 31, Kragujevac, Serbia

<sup>2</sup>Institute of Field and Vegetable Crops, Maxim Gorky St. 30, Novi Sad, Serbia

<sup>3</sup>University of Kragujevac, Faculty of Science, Institute of Biology and Ecology, Kragujevac, Serbia

<sup>4</sup>University of Priština, Faculty of Agriculture, Kopaonička bb, Lešak, Kosovo and Metohija, Serbia

<sup>5</sup>Institute for forage crops, Kruševac, Serbia

\*Corresponding author: verarajic@yahoo.com

### Abstract

The experiment was established in the experimental field of the Small Grains Research Centre in Kragujevac (Serbia) during the 2011/12 and 2012/13 growing seasons. The objective of this study was to investigate the influence of genotype and environment on the yield of winter barley cultivars (Jagodinac, Maksa, Rekord and Grand). The following characteristics were analysed: grain yield, 1000 grain weight and test weight. The highest yield of all tested varieties of winter barley was achieved by Grand (5.081 t/ha), Maksa (4.902 t/ha) and Rekord (4.871 t/ha), while the lowest yield was obtained by Jagodinac cultivar (4.733 t/ha). The lowest 1000 grain weight for all studied locations/sites and the year was recorded for the cultivar Jagodinac (42.60 g), and the highest the cultivar Grand (49.02 g). The largest two-year average value of test weight was found in the cultivar Grand (69.87 kg/hl), and lowest in cultivar Rekord (69.39kg/hl). Very highly significant influence of the cultivar on 1000 grain weight was established at investigated winter barley cultivars by variance analysis, while genotype influence on grain yields, 1000 grain weight and test weight were highly statistically significant. Significant differences in grain yield at investigated barley cultivars were found relative to the interaction environmental factors and cultivars.

**Key words:** *cultivar, grain yield, winter barley*

### Introduction

Barley is globally cultivated on an area of about 47.5 million hectares, an average yield of 2.6 t/ha being realized making it the fifth grown crops (maize, rice, wheat and soybeans). The total production of 124 million tons of barley ranks it fifth among all cultivated cultures. The largest areas under barley are in Russia, Australia, Ukraine and Canada (FAO, 2010). Barley cultivars that were in production until the end of the eighties were characterized by the lower yields, good technological quality and higher stem sensitive on lodging. Due to lower resistance on lodging, that cultivars were grown at modest soils and therefore they had lower yields (Bratković *et al.*, 2014; Đekić *et al.*, 2012; Jelić *et al.*, 2014). Agronomic cultivar value depends not only on its genetic potential for yield, but also on its ability to achieve genetic potential under different conditions of production (Mladenović *et al.*, 2009). New varieties are characterized by good technological quality, better resistance to lodging and diseases, shorter stem and more efficient assimilates usage (Pržulj *et al.*, 2004). Malting barley is expected to have 1000 grain weight of 40 and 46 g and test weight of 68 to 75 kg/hl (Paunović *et al.*, 2006). The yield per unit area is the result of the action of factors of variety fertility in interaction with environmental factors. Therefore, the yield is a relative term and is determined by the variety, environmental conditions and the level of applied technology. Yield is largely

dependent on the genetic potential, which could be defined the yield of variety which was grown in conditions on which it had been adapted, with adequately amounts of water and nutrients and efficient control of pests, diseases, weeds and other stresses (Đekić *et al.*, 2011). Yields considerably vary primarily as a result of agro-ecological conditions during the growing season (Đekić *et al.*, 2015; Popović *et al.*, 2011). Barley is in the usage as an important component of beer and malt production, important and quality component in animal feeding, partially in human nutrition as well as a component in processing industry (Đekić *et al.*, 2015; Pržulj and Momčilović, 2002). As a top-quality forage crop plant, barley is used as fodder unit in meals balancing in feed (Đekić *et al.*, 2010; Bratković *et al.*, 2014). The aim of this study was the determination of the cultivars and environmental factors influence on differences in stability and adaptability of cultivars regard the grain yield, 1000 grains weight and test weight of tested winter barley cultivars, as well as specificity of cultivars exploring regard growing seasons conditions.

## Materials and methods

### Experimental design and statistical analysis

During the 2011/12 and 2012/13 growing seasons, four cultivars of winter barley (Jagodina, Maksa, Rekord and Grand), cultivated at the Small Grains Research Centre in Kragujevac (Serbia) were investigated. Experiments have been conducted in randomized block systems, with a plot size of 5 m<sup>2</sup> (2 m x 2.5 m) in five replicates. The usual techniques for barley production were applied, and it was done in the optimum sowing time in late October, 400 kg/ha of fertilizer NPK 15:15:15 was added in the fall on the investigated plots, while during the spring fertilization, 300 kg/ha (KAN) was supplemented. The following properties were analyzed: grain yield (t/ha), 1000 grain weight (g) and test weight (kg/hl). On the basis of achieved research results the usual variational statistical indicators were calculated: average values, standard error and standard deviation. Statistical analysis was made in the module Analyst Program SAS/STAT (SAS Institute, 2000).

### Meteorological conditions

Kragujevac area is characterized by a moderate continental climate, which general feature is the uneven distribution of rainfall by months. Data in Table 1 for the investigated period (2011-2013) clearly indicate that the years in which the researches were conducted differed from the typical multi-year average for Kragujevac region, regarding the meteorological conditions.

Table 1 Middle monthly air temperature and the amount of rainfall amount (Kragujevac)

Year	Months									Average
	X	XI	XII	I	II	III	IV	V	VI	
Mean monthly air temperature (°C)										
2011/12	10.4	3.1	4.6	0.7	-3.7	8.1	12.9	16.1	23.0	8.35
2012/13	13.5	9.5	1.7	2.9	4.0	6.5	13.4	18.2	19.9	9.96
Average	12.5	6.9	1.9	0.5	2.4	7.1	11.6	16.9	20.0	8.87
The amount of rainfall (mm)										
2011/12	33.3	1.3	43.3	117.2	60.1	5.7	74.5	87.3	57.8	480.5
2012/13	56.2	17.7	16.4	62.4	84.3	102.0	41.2	70.8	30.3	481.3
Average	57.6	70.4	71.5	58.5	62.7	45.4	48.9	56.6	58.2	529.8

The average air temperature in 2011/12 was lower by 0.52°C and 2012/13 was higher by 1.09°C. The sum of rainfall precipitation in 2011/12 was lower by 49.3 mm, where the sum of rainfall in 2012/13 was 48.5 mm lower than the average of many years and with a very uneven distribution of precipitation per months. Spring months March and April in 2011/12 were the surplus of precipitation, what affected unfavorable on the crops. During the March in 2012/13 it was 102.0 mm of rainfall, what was 56.6 mm more compared with the perennial average. Regard the high importance of sufficient rainfall amounts during the spring months, particularly May for small grains production, the distribution and amount of rainfall over the growing season 2011/12 were considerably more favorable, what resulted with the increment of yields during that year. Based on the fact that sufficient amounts of rainfall in these months are very important for the successful production of cereal crops it can be concluded that the years in which the researches were conducted were favorable for the barley growing.

#### Soil and weather conditions

Before the commencement of the experiment, soil samples were taken from the sample surface and the chemical analysis of soil was performed. On the basis of obtained results, it was revealed that the soil belongs to the smonitza type, with relatively high clay content, and unfavorable physical properties. The humus content in the surface layer of soil was low (2.38-2.64%), and a substitution and total hydrolytic acidity were quite high (pH H<sub>2</sub>O=5.99, KCl=4.56). The soil was medium provided with total nitrogen (0,11-0,13% N) and easily accessible potassium (10-14 mg/100 g soil K<sub>2</sub>O), while the available phosphorus content was low (under 10 mg/100 g of soil P<sub>2</sub>O<sub>5</sub>).

#### Results and discussion

Average values of yield (t/ha), test weight (kg/hl) and 1000 grain weight (g) at investigated Kragujevac's winter barley cultivars grown at the Small Grains Research Centre in Kragujevac during two growing seasons, 2011/12 and 2012/13, are presented in Table 2.

Table 2. Average values of investigated barley cultivars characteristics

Traits	Cultivar	2011/12			2012/13			Average		
		x	S	Sx	x	S	Sx	x	S	Sx
Grain yield (t/ha)	Jagodinac	5.680	0.129	0.058	3.786	0.104	0.046	4.733	1.004	0.318
	Maksa	5.474	0.575	0.257	4.330	0.110	0.049	4.902	0.718	0.227
	Rekord	5.662	0.058	0.026	4.080	0.074	0.033	4.871	0.836	0.264
	Grand	5.942	0.301	0.135	4.220	0.202	0.090	5.081	0.939	0.297
1000 grain weight (g)	Jagodinac	45.05	0.414	0.185	40.15	0.392	0.175	42.60	2.610	0.825
	Maksa	50.59	0.850	0.380	44.69	0.850	0.380	47.64	3.211	1.015
	Rekord	51.38	0.766	0.343	45.67	0.465	0.208	48.52	3.068	0.970
	Grand	51.98	0.342	0.153	46.07	0.442	0.198	49.02	3.137	0.992
Test weight (kg/hl)	Jagodinac	68.83	0.539	0.241	70.03	0.699	0.312	69.43	0.864	0.273
	Maksa	68.84	0.576	0.258	69.98	1.037	0.464	69.41	0.993	0.314
	Rekord	68.82	0.829	0.371	69.96	0.723	0.323	69.39	0.948	0.300
	Grand	69.42	0.939	0.420	70.32	0.589	0.263	69.87	0.878	0.278

During the first year of investigations, cultivar Grand achieved the highest grains yield (5.942 t/ha), followed by Jagodinac (5.680 t/ha) and Rekord (5.662 t/ha), while the lowest yield was at Maksa cultivar (5.474 t/ha). During the second year of investigations (2012/13), the yield of Maksa cultivar was the highest with 4.330 t/ha, while the slightly lower yield was realized by Grand cultivar (4.220 t/ha). Average grains yield observed in the two-year period was the highest at Grand variety (5.081 t/ha), while the lowest yield was obtained by Maksa cultivar

(4.902 t/ha). Considerable variation in yield depending on years of research have established Jelić *et al.* (2007), Đekić *et al.* (2011), Popović *et al.* (2011) and Bratković *et al.* (2014). During the first and second years of investigation, Grand cultivar achieved the highest average 1000 grain weight (51.98 g and 46.07 g) compared with other tested barley cultivars. During the both years of investigation, the lowest average value of 1000 grain weight achieved the Jagodinac cultivar (45.05 g and 40.15 g). Pržulj *et al.* (2004) state that good quality brewer's grain needs to have the 1000-grain weight of 45-50 g. The barley cultivar Grand has achieved the highest test weight in both years of investigation compared to other tested barley cultivars (69.42 kg/hl and 70.32 kg/hl). The average two-year value of test weight at Grand cultivar was 69.87 kg/hl, while the lowest average was at Rekord cultivar (69.39 kg/hl). Grain of investigated barley cultivars was characterized by good physical characteristics; especially regarding the test weight and 1000 grain weight. Realized average values of these characteristics in the study were slightly higher than the values obtained by Jelić *et al.* (2007), Bratković (2014) and Đekić *et al.* (2015).

Table 3. Analysis of variance of the tested parameters (ANOVA)

<i>Effect of year on the traits analyzed</i>				
<i>Traits</i>	Mean sqr Effect	Mean sqr Error	F(df1,2) 1, 38	p-level
Grain yield (t/ha)	25.1381	0.090241	278.5649**	0.000000
1000-grain weight (g)	314.1602	7.239855	43.3932**	0.000000
Test weight (kg/hl)	11.9902	0.532230	22.5283**	0.000029
<i>Effect of cultivar on the traits analyzed</i>				
<i>Traits</i>	Mean sqr Effect	Mean sqr Error	F(df1,2) 3, 36	p-level
Grain yield (t/ha)	0.20484	0.776465	0.263814	0.850998
1000-grain weight (g)	87.28275	9.095181	9.596594**	0.000086
Test weight (kg/hl)	0.53167	0.850556	0.625082	0.603464
<i>Effect of the year x cultivar interaction</i>				
<i>Traits</i>	Mean sqr Effect	Mean sqr Error	F(df1,2) 3, 32	p-level
Grain yield (t/ha)	0.257282	0.063837	4.030272*	0.015381
1000-grain weight (g)	0.573417	0.360812	1.589237	0.211219
Test weight (kg/hl)	0.044250	0.578031	0.076553	0.972202

\*Statistically significant difference (P<0.05) \*\*Statistically high significant difference (P<0.01)

Table 3 shows the impact of the year, cultivar and interaction of year x cultivar on yield, 1000-grain weight and test weight. Analysis of variance in double-rowed barley cultivars tested showed statistically highly significant differences in yield, 1000-grain weight and test weight in relation to the growing season (P<0.01). The ANOVA indicated highly significant effects of the cultivar and 1000-grain weight ( $F_{exp}=9.596594^{**}$ ). Statistically significant difference in grain yield is determined under the influence of the interaction year x cultivar. Our results are consistent with the results Madić *et al.* (2009), where the authors state that the growing conditions in the observed years had a significant impact on yield. These results are in agreement with the results obtained by Đekić *et al.* (2015) in double-row barley, showing very highly significant effects of the year and grain yield ( $F_{exp}=18.6766^{***}$ ) and significant effects of the 1000 grain weight ( $F_{exp}=4.10989^{**}$ ). Achieved statistically significantly higher yields in 2011/12 were, primarily, the result of heavy rainfalls and their good distribution as well as favorable air temperatures during the vegetation period (Table 1). Đekić *et al.* (2015)

in his research states that the air temperatures and the rainfall amount and distribution during the barley growing season have the greatest impact on high yields and grain quality.

Table 4. Correlation coefficients by studied environments in two-rowed barley

Correlations between the traits analyzed in the 2011/12			
	Grain yield (t ha <sup>-1</sup> )	1000-grain weight (g)	Test weight (kg hl <sup>-1</sup> )
Grain yield (t/ha)	1.00	0.21 <sup>ns</sup>	0.36 <sup>ns</sup>
1000-grain weight (g)		1.00	0.23 <sup>ns</sup>
Test weight (kg/hl)			1.00
Correlations between the traits analyzed in the 2012/13			
Grain yield (t/ha)	1.00	0.72 <sup>*</sup>	0.04 <sup>ns</sup>
1000-grain weight (g)		1.00	0.11 <sup>ns</sup>
Test weight (kg/hl)			1.00

Positive correlations were observed between grain yield, 1000-grain weight and test weight in barley, as well as individual values for each environment, are shown in Table 4. Positive and medium correlations were also found between grain yield and 1000-grain weight in the 2012/13 year ( $r=0.72^*$ ). Correlative dependence of yield and test weight depending on the tested environment in barley ranged from 0.36 (2011/12) to 0.04 (2012/13) and none showed significance. The correlation coefficients between 1000-grain weight and test weight had positive values of the correlation coefficient in the external environment. Negative correlations of yield and 1000-grain weight, seeds that are not significant, are confirmed in their study of barley by Dodig (2000). Similar values of correlation coefficients that were not significant for yield were also recorded for the test weight ranging from 0.335 is pointed out by Bratković (2014).

### Conclusion

Based on the gain results during the two-year investigation on four Kragujevac's winter barley cultivars, it can be concluded that the grain yield of barley ranged from 4.733 t/ha (Jagodina) to 5.081 t/ha (Grand). Maksa and Rekord cultivars have achieved satisfactory results (4.902 t/ha and 4.871 t/ha). During 2011/12, statistically significantly higher grain yield per area unit, as well as 1000 grain weight was achieved, compared with 2012/13 year. Very highly significant differences in yield, 1000-grain weight and test weight at investigated barley were found in relation to the year. Furthermore, 1000-grain weight was significantly affected by the cultivar interaction ( $p<0.05$ ). The interaction of grain yield and year x cultivar significant differences at investigated barley cultivars ( $p<0.01$ ). In barley cultivars correlation coefficient between 1000-grain weight and test weight was positive.

### Acknowledgements

Investigations necessary for this papers are part of the project TP 31054 "Development of new cereals cultivation technologies on acid soils by usage of modern biotechnology", financed by the Ministry of Education, Science and Technology Development of Republic of Serbia.

### References

Bratković K. (2014): Genetic analysis of yield two row and six row barley application of method of multivariate analysis. Doctoral Dissertation. University in Belgrade.

- Bratković K., Milovanović M., Perišić V., Đekić V., Luković K. (2014): New cultivar winter two-row barley Kg Zlatnik. Proceedings, XVIII International Eco-Conference® 2014, 8th Eco-Conference® on Safe Food, 24-27. September 2014, Novi Sad, 189-197.
- Dodig D. (2000): Morphological and productive characteristics of hybrids of two-row and six-row barley in F4 and F5 generation. Master Thesis. University in Belgrade.
- Đekić V., Staletić M., Glamočlija Đ., Branković S. (2010): Variability of yield and grain yield components of KG winter barley cultivars. Proceedings of the XV International Conference on Biotechnology, 26-27. March 2010, Čačak, Vol. 16 (17), 223-226.
- Đekić V., Milovanović M., Glamočlija Đ., Staletić M. (2011): Yield and components yield grain in Kragujevac of winter barley varieties. Proceedings. 46 Croatian and 6 International Symposium on Agriculture, 14-18. Februar 2011, Opatija, Croatia, 601-604.
- Đekić V., Milovanović M., Staletić M., Popović V., Jelić M. (2012): Effect of genotype and environment on winter barley quality (*Hordeum vulgare* L). Proceedings, XVI International Eco-Conference® 2012 “Safe food”, 26-29. September 2012, Novi Sad, 145-153.
- Đekić V., Milivojević J., Popović V., Branković S., Jelić M., Staletić M., Perišić V. (2015): Genetic potential and yield components of winter barley. Proceedings, 6th International Scientific Agricultural Symposium "Agrosym 2015", 15-18. Oktober, Jahorina, p. 553-558.
- FAOSTAT (2010): <http://fostat.fao.org/faostat/>
- Jelić M., Đalović I., Savić N., Knežević D. (2007): The effect of amounts of seed and dose of nitrogen fertilizers to grain yield and quality of forage winter barley and oat. ječma. A Periodical of Scientific Research on Field and Vegetable Crops, Vol. 44, 481-486.
- Jelić M., Milivojević J., Đekić V., Paunović A., Mandić M., Dugalić G. (2014): The effect of calcification and fertilization on the yield and the utilization of nitrogen and phosphorus by barley plants on pseudoglej soil. Proceedings of the XIX Biotechnology Consultation with International Participation, 07-08. March, Cacak, vol. 19 (21), 47-51.
- Madić M., Paunović A., Knežević D., Zečević V. (2009): Grain yield and yield components of two-row winter barley cultivars and lines. Acta Agriculturae Serbica, Vol. 14, No. 27, 17-22.
- Malešević M., Glamočlija Đ., Pržulj N., Popović V., Stanković S., Živanović T., Tapanarova A. (2010): Production characteristics of different malting barley genotypes in intensive nitrogen fertilization. International Scientific Journal Genetics, „Genetika“ Belgrade, Vol. 42, No. 2, 323-330.
- Mladenović G., Kovačević N., Malešević M., Štatkić S. (2009): NS small grain seed production and marketing in the period 1998–2007. A Periodical of Scientific Research on Field and Vegetable Crops, Vol. 46, No. 2, 379-384.
- Paunovic A., Madić M., Knezevic D., Djurovic D. (2006): The interdependence of productive and technological traits in two-rowed spring barley. Acta Agriculturae Serbica, Vol. XI, No. 22, 37-43.
- Pržulj N. (2001): Cultivar and year effect on grain filling of winter barley. Plant Breeding and Seed Science Vol 45, No. 2, 45-58.
- Pržulj N., Momčilović V. (2002): Novi Sad barley varieties in the agro ecological conditions of South East Europe. Field and Vegetable Crops, 36:271-282.
- Pržulj N., Momčilović V., Petrović N. (2004): Physiological basis of barley yield under near optimal and stress conditions. Plant breeding and seed production, Vol. X, No 1-4, 15-26.



Popović V., Glamočlija Đ., Malešević M., Ikanović J., Dražić G., Spasić M., Stanković S. (2011): Genotype specificity in nitrogen nutrition of malting barley. *International Scientific Journal Genetics, Genetika Belgrade*, Vol. 43, No. 1, 197-204.

## WINTER WHEAT YIELD AND YIELD COMPONENTS DEPENDING ON THE LEVEL OF NITROGEN, PHOSPHORUS AND POTASSIUM FERTILIZATION

Vera ĐEKIĆ<sup>1\*</sup>, Miodrag JELIĆ<sup>2</sup>, Jelena MILIVOJEVIĆ<sup>1</sup>, Vera POPOVIĆ<sup>3</sup>, Snežana BRANKOVIĆ<sup>4</sup>, Mirjana STALETIĆ<sup>1</sup>, Dragan TERZIĆ<sup>5</sup>

<sup>1</sup>Small Grains Research Centre, Save Kovacevica 31, Kragujevac, Serbia

<sup>2</sup>University of Priština, Faculty of Agriculture, Kopaonička bb, Lešak 38219, Kosovo and Metohija, Serbia

<sup>3</sup>Institute of Field and Vegetable Crops, Maxim Gorky St. 30, Novi Sad, Serbia

<sup>4</sup>University of Kragujevac, Faculty of Science, Institute of Biology and Ecology, 34000 Kragujevac, Serbia

<sup>5</sup>Institute for forage crops, Kruševac, Serbia

\*Corresponding author: verarajic@yahoo.com

### Abstract

Effects of mineral nutrition efficiency of wheat have been studied at the stationary field trial of the Small Grains Research Centre in Kragujevac (Serbia) for two years (2008/09 and 2009/10). In this paper, average yields from 7 treatments of increasing doses of nitrogen, phosphorus and potassium nutrients have been studied. The objective of this study was to investigate the influence of mineral nutrition on the yield of winter wheat varieties Takovčanka. Investigation showed a considerable variation of grain yield depending on mineral nutrition. The study showed that most investigated wheat cultivar achieved their highest grain yields less than 120 kg/ha nitrogen rate, phosphorus rate of 100 kg/ha P<sub>2</sub>O<sub>5</sub> and potassium rate of 60 kg/ha K<sub>2</sub>O (3.622 t/ha). Thousand grain weight of wheat significantly varied across years, the highest average thousand grain weight of winter wheat cultivar investigated was achieved in the NP2K variant with the higher phosphorus rate (42.47 g). Analysis of variance was found to have the highly significant effect of years on 1000 grains weight and test weight, and significant effect of years on grain yield. Different combinations of fertilization had the most highly significant influence on grain yield and thousand grain weight. Positive correlations were observed between grain yield and thousand grain weight in all years. Grain yield was significantly positively correlated with 1000-grain weight only in the 2008/09 ( $r=0.66^*$ ) and 2009/10 ( $r=0.79^*$ ). Significant positively and medium correlations were observed between 1000-grain weight and test weight in P treatment.

**Key words:** *fertilization, yield, quality, wheat*

### Introduction

In the last few decades, a huge experimental material on mineral nutrition and fertilization of wheat have been collected. Constant progress in the selection and creation of new varieties gives strong incentive to the studies of various problems of mineral nutrition of wheat. Thus, with the advent of new varieties of wheat (significantly different in regard to a series of useful properties, especially significantly higher yield potential), it was established that their requirements in terms of mineral nutrition are also significantly higher (Đekić et al., 2014, 2016; Jelić et al., 2014).

Winter wheat uses relatively large amounts of mineral elements during the growing season and has a high demand in regard to the soil fertility (Malešević, 2008; Jelić et al., 2013b). Of all macro elements that are taken from the soil, wheat consumes mainly nitrogen, and to lesser extent potassium, significantly less phosphorus and even less sulfur, magnesium and calcium (Jelić et al., 2013a). The quantities of nutritive elements, which are taken from the soil by

wheat during the growing season, depending primarily on the grain yield and mass of vegetative organs. In our conditions, usually the amount of nitrogen to be applied for the high yield, ranges in the total value from 80-120 kg/ha, depending on the agrochemical properties of the soil. According to Malešević et al. (2008), in the ten years of investigation of the impact of increasing nitrogen doses on grain yield, the yield has increased with the increase of the amount of nitrogen. The greatest grain yield was achieved with the highest nitrogen dose, 180 kg ha. However, the average yield achieved in this treatment was not statistically significantly different than the yield obtained with 120 kg/ha N and the authors recommend this quantity as optimum. Similar results are obtained in a number of other studies (Đekić et al., 2014, 2015; Jelić et al., 2014, 2015). In regard to the elements of mineral nutrition, nitrogen plays a major role in increasing the yield of wheat (Malešević, 2008; Kastori et al., 2005). Nitrogen demonstrates the greatest impact when it is used together with phosphorous and potassium, and these two elements, when used without nitrogen, not only do not provide a significant increase in yield of wheat but often suppress it (Đekić et al., 2014; Jelić et al., 2013c). The nutrient deficiency, as well as surplus of fertilizer, can cause a decrease in yield of wheat (Kastori et al., 2005). The use of larger than necessary amounts of fertilizer not only is it economically not justifiable in terms of the direct resources, but in a large number of plant species and varieties such doses may be harmful (lodging and, more intense occurrence of diseases in wheat, etc.), and are common cause of pollution of agroecosystems. The use of fertilizers and certain amendments on extremely acid soils in certain years, particularly those less favorable for production, almost certainly has the different effect on grain filling, resulting in diverse relationships between productive and qualitative traits. The present results confirm the opinion of many authors that the traits analysed and their correlations are genetically determined but are strongly modified by the nutrient status of the environment and weather conditions (Jelić et al., 2015; Đekić et al., 2016). Because of the appearance of new demanded cultivars at permanent changes in soil fertility level and environmental conditions, still exist need to researches mineral nutrition of wheat, as well as determine optimal rates and balanced nutrition ratios in concrete agro-ecological conditions. The main goal of this research was to investigate the effect of long-term applications of identical amounts and ratios of nitrogen, phosphorus and potassium on the yield components of winter wheat cultivar Takovčanka has grown on a vertisol soil. The study was also aimed at optimizing fertilization for maximum profitability in the future wheat production of Central Serbia.

## **Materials and methods**

### *Materials and field trials*

The study was carried out in a stationary field trial involving fertilization over a two years period from 2008/09 to 2009/10. Trials were first set up in the experimental fields of the Small Grains Research Centre in Kragujevac in 1970. Plot size was 50 m<sup>2</sup>. The wheat cultivar used in the experiment was Takovčanka, the dominant cultivar in the production region of Serbia. This investigation included an untreated control and six variants of fertilization: N (120 kg N/ha), P (100 kg/ha P<sub>2</sub>O<sub>5</sub>), NP1K (120 kg/ha N, 60 kg/ha P<sub>2</sub>O<sub>5</sub>, 60 kg/ha K<sub>2</sub>O), NP2K (120 kg/ha N, 100 kg/ha P<sub>2</sub>O<sub>5</sub>, 60 kg/ha K<sub>2</sub>O), NP1 (120 kg/ha N, 60 kg/ha K<sub>2</sub>O) and NP2 (120 kg/ha N, 100 kg/ha P<sub>2</sub>O<sub>5</sub>). A non-fertilized variant served as a control. Total amounts of phosphorus and potassium fertilizers and half the nitrogen rate are regularly applied during pre-sowing cultivation of the soil. The trial was set up in a randomized block design with five replications. Fertilization was regular and followed a long-time scheme.

The crop was harvested at full maturity. Grain yield (t/ha) was harvested and reported at 14% moisture. Three parameters of grain quality, namely test weight (kg/hl) and 1000-grain weight

(g) were analyzed. Thousand grain weight was determined using an automatic seed counter. Test weight is the weight of a measured volume of grain expressed in kilograms per hectoliter. On the basis of achieved research results the usual variational statistical indicators were calculated: average values, standard error and standard deviation. Statistical analysis was made in the module Analyst Program SAS/STAT (SAS Institute, 2000).

#### Soil and agroecological conditions

The trial was set up on a vertisol soil in a process of degradation, with heavy texture and very coarse and unstable structure. The humus content in the surface layer of soil was low (2.22%). Soil pH indicates high acidity (pH in H<sub>2</sub>O 5.19; pH in KCl 4.27), nitrogen content in soil is medium (0.11-0.15%), while the content of available phosphorus ranges from very low (1.7-2.9 mg/100 g soil) in the N variant to very high (26.9 mg P<sub>2</sub>O<sub>5</sub>/100 g soil) in the NPK variants of fertilization. Available potassium contents are high, ranging from 19.5 to 21.0 mg K<sub>2</sub>O/100 g soil.

This study was conducted over a three-year period in the Šumadija region, Central Serbia, on a Vertisol soil, at Kragujevac location, 173-220 m a. s. l. (44° 22' N, 20° 56' E), in a temperate continental climate having an average annual temperature of 11.5°C typical of Šumadija districts in Serbia and a rainfall amount of about 550 mm. The data in Table 1 for the investigated period (2008-2010) clearly indicate that the years in which the researches were conducted differed from the typical multi-year average of Kragujevac region regard the meteorological conditions.

**Table 1.** Mean monthly air temperature and precipitation (Kragujevac)

Year	Months										Aver.
	X	XI	XII	I	II	III	IV	V	VI	VII	
Mean monthly air temperature (°C)											
2008-09	13.1	8.5	4.4	2.3	2.0	6.8	13.4	17.8	20.2	22.5	11.1
2009-10	11.7	8.8	2.6	0.9	3.2	7.2	12.1	16.5	20.2	23.1	10.63
Average	11.8	5.6	1.9	0.6	2.0	6.2	11.2	16.2	19.4	21.3	9.62
The amount of rainfall (mm)											
2008-09	31.3	30.6	29.7	57.7	76.9	40.3	16.8	46.0	137.8	25.2	492.3
2009-10	102.6	77.5	194.2	57.0	150.5	43.3	142.2	116.7	196.7	14.8	1095.5
Average	47.5	50.0	49.5	36.8	33.9	43.5	51.5	64.8	79.3	62.5	479.3

The average air temperature in 2008/09 was higher by 1.48°C and 2009/10 was higher by 1.01°C. The sum of rainfall precipitation in 2008/09 was higher by 13.0 mm, where the sum of rainfall in 2009/10 was 616.2 mm higher than the average of many years and with a very uneven distribution of precipitation per months. Spring months April, May and June in 2009/10 were the surplus of precipitation, what affected unfavorable on the crops. During the April in 2009/10 it was 142.2 mm of rainfall, what was 90.7 mm more compared with the perennial average. During the month of June in 2009/10 it was 196.7 mm of rainfall, what was 117.4 mm more compared with the perennial average.

### **Results and discussion**

Based on the analysis of variance, it can be concluded that are significant differences in grain yield regarding the year of investigation ( $F_{exp}=4.490^*$ ) and highly significant differences at thousand grain weight ( $F_{exp}=29.345^{**}$ ) and test weight ( $F_{exp}=10.785^{**}$ ). Highly significant differences in grain yield and thousand grain weight regard the fertilization of investigation ( $F_{exp}=5.132^{**}$  and  $F_{exp}=8.380^{**}$ ). In the dual interaction between the year and

fertilization, highly significant effects differences in grain yield and thousand grain weight (Table 2).

**Table 2.** Analysis of variance of the tested parameters (ANOVA)

Effect of years on the traits analyzed				
Traits	Mean sq Error	Mean sq Error	F(1. 68)	p-level
Grain yield (t ha <sup>-1</sup> )	8.3207	1.85296	4.49049*	0.037739
1000-grain weight (g)	239.9451	8.17657	29.34545**	0.000001
Test weight (kg hl <sup>-1</sup> )	124.4889	11.54246	10.78530**	0.001619
Effect of fertilization on the traits analyzed				
Traits	Mean sq Error	Mean sq Error	F(6. 63)	p-level
Grain yield (t ha <sup>-1</sup> )	7.34962	1.43214	5.131927**	0.000239
1000-grain weight (g)	58.88333	7.02622	8.380511**	0.000001
Test weight (kg hl <sup>-1</sup> )	7.33195	13.73627	0.533766	0.780564
Effect of the years x fertilization interaction on the traits analyzed				
Traits	Mean sq Error	Mean sq Error	F(6. 56)	p-level
Grain yield (t ha <sup>-1</sup> )	3.40013	1.09827	3.095891**	0.010896
1000-grain weight (g)	11.20314	2.41943	4.630491**	0.000693
Test weight (kg hl <sup>-1</sup> )	9.61181	12.20045	0.787824	0.583204

The use of fertilizers and certain amendments on extremely acid soils in certain years, particularly those less favorable for production, almost certainly has different effects on grain filling, resulting in diverse relationships between productive and qualitative traits. The present results confirm the opinion of many authors that the traits analyzed are genetically determined but are strongly modified by the nutrient status of the environment and weather conditions (Đekić et al., 2013, 2014, 2016; Jelić et al., 2013c, 2014).

Fertilization had a significant effect on grain yield (Table 3). The grain yield of winter wheat significantly varied across years, from 1.101 t/ha to 4.432 t/ha in 2008/09 and from 1.066 t/ha to 2.883 t/ha in 2009/10 (Table 3). In the two-year period, the highest average grain yield of winter wheat cultivar investigated was achieved in the NP2K variant with the higher phosphorus rate (3.622 t/ha). The average grain yield was lowest in the unfertilized control (1.083 t/ha) and significantly higher in fertilized treatments, ranging from 3.284 t/ha (NP2-treatment) to 3.622 t/ha (NP2K). NP1 fertilization induced a significant increase in grain yield, which 2.039 t/ha higher as compared to the control, respectively. The study showed that most investigated wheat cultivar achieved their highest grain yields less than 120 kg/ha nitrogen rate, phosphorus rate of 100 kg/ha P<sub>2</sub>O<sub>5</sub> and potassium rate of 60 kg/ha K<sub>2</sub>O. Grain yield showed a significant dependence on the year and very significant dependence of fertilization (Table 2).

The significantly lower wheat grain yields achieved in the N and NK trial variants than in the NPK and NP variants resulted from the existing phosphorus deficit in the soil, and low pH and high content of mobile Al in soil solution (Jelić et al., 2013b).

Nitrogen, phosphorus and potassium application, particularly on acid soils poorly supplied with these nutrients, has a high effect on the grain yield of oats and other cereal crops (Browne et al., 2006; Jelić et al., 2013a; Mohr et al., 2007; Rashid et al., 2007). Presented results confirm the opinion of many authors that the traits analyzed are genetically determined, but strongly modified by the nutrient status and weather conditions (Đekić et al., 2014; Jelić et al., 2013c).

The control and P-treatment achieved the lowest average 1000 grain weight during the both years of investigation compared with other tested treatments (Table 3). Thousand grain weight of wheat significantly varied across years, from 37.20 g to 44.86 g in 2008/09, from 33.16 g to 40.08 g in 2009/10. During the first year of investigations, the highest average value of

1000-grain weight achieved the NP2K (120 kg/ha N, 100 kg/ha P<sub>2</sub>O<sub>5</sub>, 60 kg/ha K<sub>2</sub>O), NP1 (120 kg/ha N, 60 kg/ha P<sub>2</sub>O<sub>5</sub>) and NP2 (120 kg/ha N, 100 kg/ha P<sub>2</sub>O<sub>5</sub>) treatments (44.86 g, 44.10 g and 44.30 g). During the second year of investigations (2009/10), the highest average value of 1000 grain weight achieved the NP2K (120 kg/ha N, 100 kg/ha P<sub>2</sub>O<sub>5</sub>, 60 kg/ha K<sub>2</sub>O) treatment (40.08 g). In the two-year period, the highest average thousand grain weight of winter wheat cultivar investigated was achieved in the NP2K variant with the higher phosphorus rate (42.47 g). Furthermore, 1000-grain weight was significantly affected by the year x fertilization interaction (Table 2). A number of authors (Browne et al. 2006; Dekić et al. 2013, 2016; Jelić et al., 2013a, 2014) underline that thousand grain weight is a cultivar-specific trait, with considerably higher variations being observed among genotypes than among treatments or environmental factors.

**Table 3.** Grain yield, 1000-grain weight and test weight of winter wheat

Traits	Fertilization	Years						Average		
		2008/09			2009/10			$\bar{x}$	S	S <sub>x</sub>
		$\bar{x}$	S	S <sub>x</sub>	$\bar{x}$	S	S <sub>x</sub>			
Grain yield, (t ha <sup>-1</sup> )	C	1.101	0.357	0.160	1.066	0.376	0.168	1.083	0.346	0.109
	N	3.410	0.925	0.414	2.820	0.673	0.301	3.115	0.823	0.260
	P	2.930	0.491	0.219	1.521	0.737	0.330	2.225	0.949	0.300
	NP1K	3.444	1.704	0.762	2.470	0.840	0.376	2.957	1.367	0.432
	NP2K	4.362	1.921	0.859	2.883	1.044	0.467	3.622	1.653	0.523
	NP1	3.554	0.762	0.341	2.690	1.254	0.561	3.122	1.079	0.341
	NP2	4.432	1.405	0.629	2.136	0.706	0.316	3.284	1.601	0.506
1000-grain weight, (g)	C	37.20	0.520	0.232	33.16	1.297	0.580	35.18	2.324	0.735
	N	42.06	0.351	0.157	39.84	0.518	0.231	40.95	1.242	0.393
	P	39.96	2.194	0.981	39.58	0.438	0.196	39.77	1.505	0.476
	NP1K	42.72	0.926	0.414	39.62	1.952	0.873	41.17	2.178	0.689
	NP2K	44.86	1.014	0.453	40.08	2.348	1.050	42.47	3.042	0.962
	NP1	44.10	1.058	0.473	39.82	3.028	1.354	41.96	3.108	0.983
	NP2	44.30	0.995	0.445	37.18	2.008	0.898	40.74	4.039	1.277
Test weight (kg/hl)	C	66.03	4.344	1.943	71.35	1.797	0.804	68.69	4.205	1.330
	N	68.65	1.600	0.715	70.85	3.688	1.649	69.75	2.920	0.923
	P	67.06	3.990	1.784	71.97	3.217	1.439	69.51	4.286	1.355
	NP1K	69.27	3.973	1.777	72.45	1.811	0.810	70.86	3.359	1.062
	NP2K	69.88	5.003	2.238	72.05	3.237	1.448	70.96	4.134	1.307
	NP1	70.69	2.128	0.952	70.69	4.548	2.034	70.69	3.348	1.059
	NP2	70.20	4.083	1.826	71.09	3.132	1.401	70.64	3.462	1.095

Test weight is an indicator of grain quality, particularly grain monetary value. Table 3 presents average values for grain test weight across years and treatments. All testing fertilization variants had test weight greater than 70 kg/hl, except control, N and P variants. During the first year achieved the highest test weight at NP1-treatment (70.69 kg/hl), followed by NP2 (70.20 kg/hl), while the lowest test weight was the control (66.03 kg/hl). During the second year of investigations, the test weight of NP1K was the highest with 72.45 kg/hl, while the slightly lower test weight was realized by NP2K (72.05 kg/hl). The average two-year value of test weight at NP1K was (70.86 kg/hl) and NP2K (70.96 kg/hl), while the lowest average two-year value was at control treatment (68.69 kg/hl). Grain test weight showed a very significant dependence on the year (Table 2). In all years, the use of different treatments induced a significant increase in grain test weight.

**Table 4.** Correlations between the traits analyzed during 2008-2010

Traits	Correlations in 2008/09			Correlations in 2009/10		
	GY, t/ha	1000 GW, g	TW, kg/hl	GY, t/ha	1000 GW, g	TW, kg/hl
Grain yield (t/ha)	1.00	0.66*	0.52*	1.00	0.79*	-0.09 <sup>ns</sup>
1000-grain weight (g)		1.00	0.36*		1.00	0.05 <sup>ns</sup>
Test weight (kg/hl)			1.00			1.00

Positive and significantly correlated correlations were observed (Table 4) between grain yield and thousand grain weight in all years. Testing the correlation coefficients between grain yield and test weight of wheat (Table 4) was found positive and medium significantly correlated between in 2008/09, but negative and low correlations between in 2009/10. However, thousand grain weight were medium significantly positively correlated with grain yield only in the first year ( $r=0.66^*$ ) and strong significantly positively correlated in the second year ( $r=0.79^*$ ). The results suggest that grain yield and quality formation is affected by both genetic and environmental factors (Đekić et al., 2014, 2016; Jelic et al., 2015).

**Table 5.** Correlation coefficients for the traits analyzed across treatments

Correlations between the traits analyzed in the unfertilized control			
	Grain yield, t ha <sup>-1</sup>	1000-grain weight, g	Test weight, kg hl <sup>-1</sup>
Grain yield, t/ha	1.00	0.27 <sup>ns</sup>	0.10 <sup>ns</sup>
1000-grain weight, g		1.00	-0.60 <sup>ns</sup>
Test weight, kg/hl			1.00
Correlations between the traits analyzed in the 80 kg/ha N			
Grain yield, t/ha	1.00	0.50 <sup>ns</sup>	-0.46 <sup>ns</sup>
1000-grain weight, g		1.00	-0.44 <sup>ns</sup>
Test weight, kg/hl			1.00
Correlations between the traits analyzed in the 60 kg/ha P <sub>2</sub> O <sub>5</sub>			
Grain yield, t/ha	1.00	-0.08 <sup>ns</sup>	0.69*
1000-grain weight, g		1.00	-0.23 <sup>ns</sup>
Test weight, kg/hl			1.00
Correlations between the traits analyzed in the 80 kg/ha N, 60 kg/ha P <sub>2</sub> O <sub>5</sub> , 60 kg/ha K <sub>2</sub> O			
Grain yield, t/ha	1.00	0.06 <sup>ns</sup>	-0.31 <sup>ns</sup>
1000-grain weight, g		1.00	-0.36 <sup>ns</sup>
Test weight, kg/hl			1.00
Correlations between the traits analyzed in the 80 kg/ha N, 100 kg/ha P <sub>2</sub> O <sub>5</sub> , 60 kg/ha K <sub>2</sub> O			
Grain yield, t/ha	1.00	0.62 <sup>ns</sup>	0.39 <sup>ns</sup>
1000-grain weight, g		1.00	-0.01 <sup>ns</sup>
Test weight, kg/hl			1.00
Correlations between the traits analyzed in the 80 kg/ha N and 60 kg/ha P <sub>2</sub> O <sub>5</sub>			
Grain yield, t/ha	1.00	0.79**	-0.20 <sup>ns</sup>
1000-grain weight, g		1.00	-0.17 <sup>ns</sup>
Test weight, kg/hl			1.00
Correlations between the traits analyzed in the 80 kg/ha N and 100 kg/ha P <sub>2</sub> O <sub>5</sub>			
Grain yield, t/ha	1.00	0.80**	0.19 <sup>ns</sup>
1000-grain weight, g		1.00	-0.14 <sup>ns</sup>
Test weight, kg/hl			1.00

Table 5 shows the correlation coefficients between the studied fertilization treatments and analyzed traits. Positive correlations were observed between grain yield and thousand grain weight in all treatments. Negative correlations were observed between thousand grain weight and test weight in all treatments. Positive and strong correlations were also found between grain yield and thousand grain weight in the NP1-treatment ( $r=0.79^{**}$ ) and NP2 treatment ( $r=0.80^{**}$ ). The present results confirm the opinion of many authors that the traits analyzed and their correlations are genetically determined but are strongly modified by the nutrient status of the environment and weather conditions (Đekić et al., 2014; Jelić et al., 2013a; 2015). Đekić et al. (2016) stated positive correlation between grain weight and grain yield.

### **Conclusion**

Based on the gain results during the two-year investigation on seven treatments fertilization, it can be concluded that the highest yield achieved the treatment NP2K (3.622 t/ha). The highest average thousand grain weight of winter wheat cultivar investigated was achieved in the NP2K variant with the higher phosphorus rate (42.47 g). All testing fertilization variants had test weight greater than 70 kg/hl, except control, N and P variants. Considering the average values during the 2008-10 period, it was evident that the 1000 grain weight and test weight were highly statistically significantly different between the years ( $p<0.01$ ) and significantly different between of years on the grain yield ( $p<0.05$ ). Effect of fertilization treatments on the grain yield and 1000-grain weight was highly statistically significant. Also, the effect of the interaction of the year x fertilization on the grain yield and 1000-grain weight was significant. Investigations of year x fertilization interactions present the important basis for the further more successful growing, breeding and zoning of wheat. Significantly positively and medium correlated with yield and 1000 grain weight both in 2008/09 (0.66\*, respectively), and significantly positive and strongly correlated in 2009/10 (0.79\*, respectively). Significant positively and medium correlations were observed between 1000-grain weight and test weight in P treatment.

### **Acknowledgements**

Investigations necessary for this papers are part of the project TP 31054 "Development of new cereals cultivation technologies on acid soils by usage of modern biotechnology", financed by the Ministry of Education, Science and Technology Development of the Republic of Serbia.

### **References**

- Browne R. A., White E. M., Burke J. I. (2006): Responses of developmental yield formation processes in oats to variety, nitrogen, seed rate and plant growth regulator and their relationship to quality. *J. Agric. Sci. (Camb.)*, Vol. 144, p. 533-545.
- Đekić V., Staletić M., Jelić M., Popović V., Branković S. (2013): The stability properties of wheat production on acid soil. *Proceedings, 4th International Symposium "Agrosym 2013"*, 03-06. Oktober, Jahorina, p. 84-89.
- Đekić V., Milovanović M., Popović V., Milivojević J., Staletić M., Jelić M., Perišić V. (2014): Effects of fertilization on yield and grain quality in winter triticale. *Romanian Agricultural Research*, No.31, p. 175-183.
- Đekić V., Milovanović M., Milivojević J., Staletić M., Popović V., Simić D., Mitrović M. (2015): Impact of year and grain quality of winter wheat. *Proceedings of research papers, Belgarde*, Vol. 21, No. 1-2, p. 79-86.



- Đekić V., Milivojević J., Jelić M., Popović V., Branković S., Staletić M., Terzić D. (2016): The influence of mineral nutrition on winter wheat yield. Proceedings, VII International Scientific Symposium "Agrosym Jahorina 2016", AGROSYM, 06-09. October, Jahorina, p. 392-398.
- Jelić M., Dugalić G., Milivojević J., Đekić V. (2013a): Effect of liming and fertilization on yield and quality of oat (*Avena sativa* L.) on an acid luvisol soil. Romanian Agricultural Research, 2013, No. 30, p. 239-248.
- Jelić M., Đekić V., Milivojević J., Dugalić G., Madić M. (2013b): Yield stability parameters triticale on acid soils. Proceedings, Faculty of Agronomy, 15-16. Mart, Čačak, Vol. 18 (20), p. 93-98.
- Jelić M., Dugalic G., Milivojevic J., Djikic S., Đekić V., Savic N., Gudzic N. (2013c): Influence of perennial application of fertilizers and ameliorative measures on changes of pseudogley soil properties and grain yield of winter wheat. 1st International Congress Soil-Water-Plant, 23-26 September, Belgrade, p. 195-207.
- Jelić M., Milivojević J., Đekić V., Paunović A., Tmušić N. (2014): Impact of liming and fertilization on grain yield and utilization of nitrogen and phosphorus in wheat plant grown on soil type pseudogley. Proceedings of research papers, Belgarde, Vol. 20, No. 1-4, p. 49-56.
- Jelic M., Milivojevic J., Nikolic O., Đekić V., Stamenkovic S. (2015): Effect of long-term fertilization and soil amendments on yield, grain quality and nutrition optimization in winter wheat on an acidic pseudogley. Romanian Agricultural Research, No.32, p. 165-174.
- Kastori R. et al. (2005): Nitrogen: Agrochemical, Cultural Practice, Physiological and Ecological Aspects, Monografija, urednik R. Kastori, Institute of Field and Vegetable Crops, Novi Sad, 2005, p. 1-419.
- Malešević M. (2008): Mineral nutrition of small grains in integrated crop management system. Proceedings Institute of Field and Vegetable Crops, Vol. 45, No. 1, p. 179-193.
- Malešević M., Starčević LJ., Jaćimović G., Đurić V., Šeremešić S., Milošev D. (2008): The yield of winter wheat depending on the conditions and the level of nitrogen fertilization. Proceedings, Faculty of Agronomy, Vol. 13 (14), p. 135-141.
- Mohr R. M., Grant C. A., May W. E., Stevenson F. C. (2007): The influence of nitrogen, phosphorus and potash fertilizer application on oat yield and quality. Can. J. Soil Sci., Vol. 87, p. 459-468.
- Rashid M., A. M. Ranjha M. A., Waqas M., A. Hannan A., A. Bilal A., Saeed A., M. Zafar M. (2007): Effect of P fertilization on yield and quality of oat (*Avena sativa* L.) fodder on two different textured calcareous soils. Soil and Environ, Vol. 26, p. 33-41.
- SAS/STAT (2000). User's Guide, Version 9.1.3. SAS Institute Inc.

## **ANALYSIS OF VEGETABLE PRODUCTION IN SERBIA**

Vera RAŠKOVIĆ\*, Vojislav TOMIĆ, Vera MILOŠEVIĆ, Milan GLIŠIĆ

Higher Agricultural School of Vocational Studies Šabac, Serbia

\*Corresponding author: vera.raskovic75@gmail.com

### **Abstract**

Vegetable production is one of the most intensive forms of agricultural production, although the areas of that production are getting smaller and smaller, regardless of our favourable ecological conditions. In Serbia, in 2006, vegetables were grown on 8% arable land. According to the latest data concerning the structure of planted arable land and gardens, vegetable accounts for 2.5%. Large regional deviations (differences) in achieved yield of the observed cultures can be noticed in Serbia. This paper tried to determine the place of Serbia when vegetable production is in question, in relation to the other neighbouring countries of the former Yugoslavia. In 2014, only Bosnia and Herzegovina had lower yield than Serbia. But, all the regional countries have something in common: lower average yield than EU. What encourages is the fact that the yield significantly increased in 2015 in relation to the previous year, making us approach the average production of our neighbouring countries. Having in mind that the vegetable fields are becoming smaller and smaller, production mainly stagnates. All 5 observed cultures are mostly imported in our country, but since the last five years, we haven't noticed any regularity, i.e. that one culture distinguishes more than the others, or that the import is only of seasonal character. The aim of this paper is to examine the conditions in vegetable production in Serbia, to compare them with those in our neighbouring countries which also went through the transition period in order to determine the problems of vegetable production in Serbia and how to reduce them.

**Key words:** *Vegetable production, Yield, Serbia.*

### **Introduction**

The reason for decreasing vegetable areas, in spite of favourable agroecological conditions as well as long tradition in the families of our producers is connected to the fact that they are faced with a lot of problems, among which are the following:

Low yield which influences incompatibility on the foreign market.

Our market is too open for import, both in off-season and season, not considering the needs of our domestic producers. Serbia exports vegetables annually in the value of only \$ 96.3 million, although real opportunities are far greater (Ilin et al, 2013). Generally, trends in vegetable trade are getting worse in Serbia year after year, which points to deep structural problems in production, processing and trade (Živkov et al, 2012).

The production is not coordinated, making a great variety of quantity and quality supply.

In the private sector, there is a much more pronounced fragmentation of the property. In European Union, the average size of the farm is 20.7 ha, which is five times greater than the average size of the family farm in Serbia (Pejanović, 2013).

The main problem of the producer is not how to produce, but how to sell some sort of vegetable, due to poorly organized purchase of vegetable products in a larger territory of our country.

All the above mentioned problems have been recognized for several generations, not nowadays.

In order to recognize where Serbian vegetable growing is now, we compared our production with the production in the region, which are in a sense similar according to the degree of development and production conditions. The aim of this paper is to suggest the measures of strategy vegetable growing development, as well as agricultural production in general, after making the analysis of vegetable growing production.

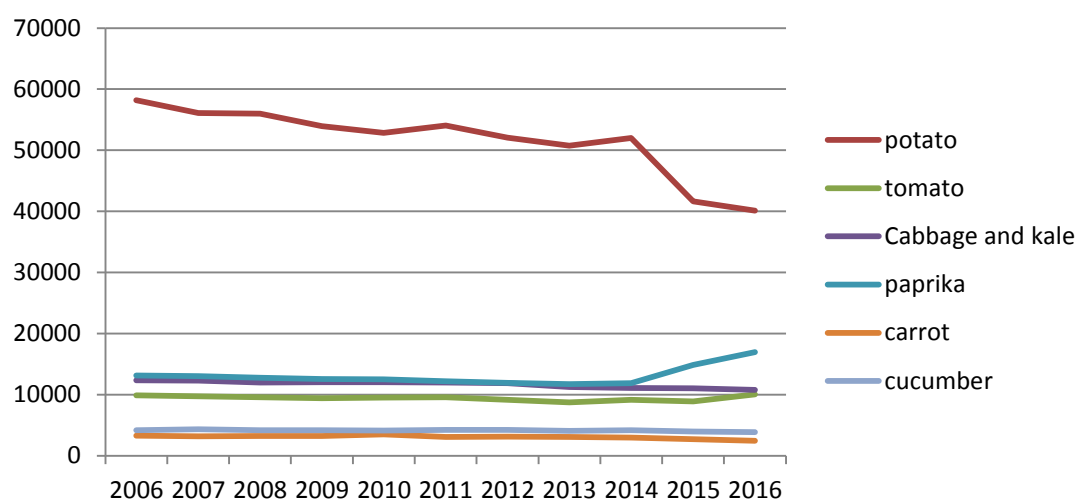
### Materials and methods

In this paper we used data from the following sites: *Food and agriculture Organization of the United Nations (FAOSTAT)*, *Trade Map of International Trade Centre (ITC) Statistical Office of the Republic of Serbia (RZS)* and *System of market information of agriculture in Serbia (STIPS)*. Data from different literature sources have been compared and on the basis of that conclusions were drawn.

### Results and discussion

The production of vegetables and potatoes in Serbia in the last 10 years

Potato has been a dominant crop for the last ten years. There are many reasons for that. As it is already known, potato is an industrial crop used in many ways (starch, alcohol, spiritus, even in electric current production), it is a tradition and habit that potato is a dominant crop in nutrition, it can easily be kept and stored in contrast to some other crops, as well as in some regions it is the most acceptable crop for growing due to edaphic and ecological conditions. During the period of ten years, potato production covered the area of 41,9% in relation to totally 10 sorts whose areas are noticed by RZS, i.e. 53000 ha were used for potato growing. The expected potato production in 2016/ 2017 leads to decreasing areas to 40000ha which is 19% lower than the previous year.

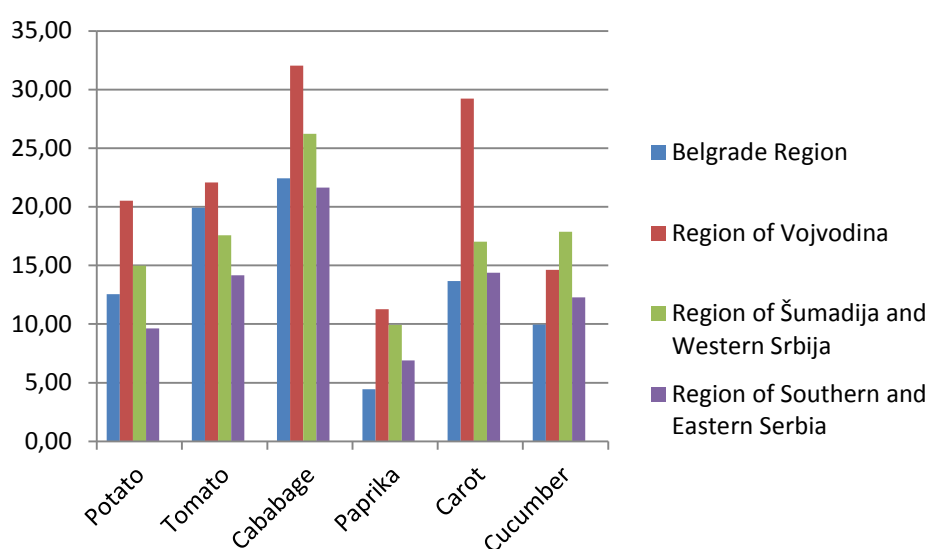


Graph. 1. The areas with potatoes and vegetables from 2007 – 2016 in ha

The analogy can be made between average potato producers and average vegetable producers. The most potato producers 36% are on 2 – 5ha farms (data taken by MPZZS ). Speaking about the crops, increasing and decreasing depend on their refunding in the previous year, and potato production is the most illustrative example. In 2014, the yield in the Republic was 11,4

t ha<sup>-1</sup>, in 2013 it was 15,1 t ha<sup>-1</sup>, i.e. 24,5% higher. In the year when the yield was better, it could be sold at 35 – 40 RSD., while in 2014 the price at the market was 32 – 35 RSD.(STIPS). In 2015 these oscillations in profit influenced on decreasing the areas to 10000ha or 25%. The opposite example is that pepper in Šumadija region (Kraljevo – market) in September 2014 was sold at 70 RSD., but in the same period in 2013 at 40 RSD (STIPS). That's why the areas with pepper, in the region, increased in 2015 to 1380 ha or 23,3%. According to this it is obvious that the producers are left to their own, the “ smaller “ ones cannot afford one “ bad “ year and are forced to give up. Another group presents “ ad hoc “ producers who follow the principle of profit.

In our country there is a pronounced incompatibility regarded the choice of crops, areas and the most important – achieved profit. The region of Šumadija is the best-known for vegetable growing, but Vojvodina has more areas with carrot ( RZS). Previous researches ( Živkov at all, 2012 ) as well as ours determined that Vojvodina (Graph.2.) had the highest average yield and in relation to some other regions, is the closest to European average.



Graph.2 Average yield ( t ha<sup>-1</sup>) of vegetables by the regions of Serbia (2010-2015)

The problems of Serbian vegetable growing noticed ten years ago are still current. In 2006, Biljana Persnall concluded that the problems are as follows:

-The lack of modern cold storage plants with controlled atmosphere, and not enough centers for purchase. In some regions, technology is out of date ( machinery ), small supply that can only satisfiesthe needs of domestic market, nonstandard production, inadequate packaging, organized import lobby, bad or none organized export, inadequate initiative policy for vegetable producers.

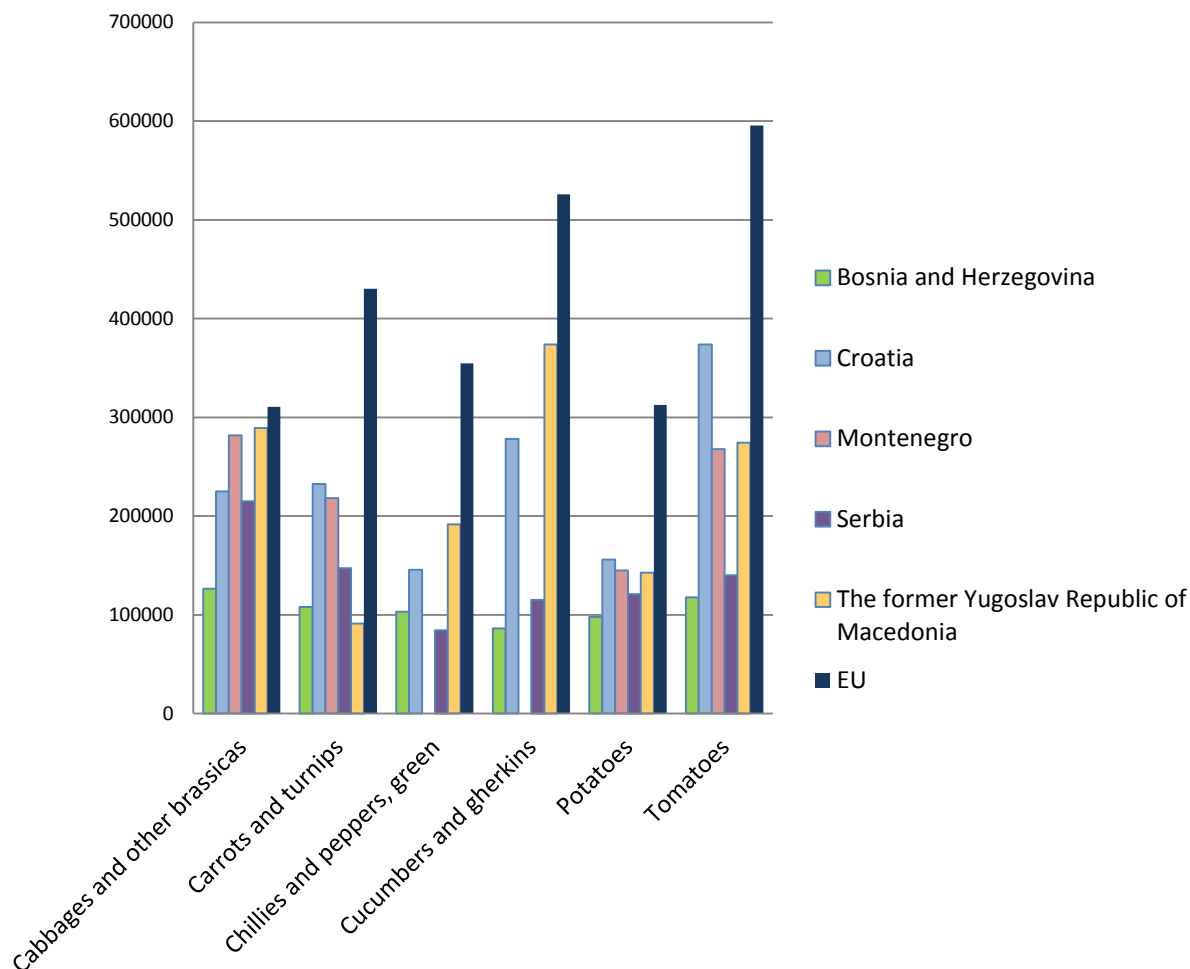
Something that we worry about is bad age distribution and low educational structure of rural population. Constant migration from villages to towns makes the most important problem since these producers should already be retired (Rašković et al, 2016 ).

Vegetable growing in relation to the countries in Region and EU

With the increasing of world population, the market of world food is in constant growth, too (Milošević et al. 2012). According to Ilin (2010) there is a great incompatibility in production and demand on our planet. EU is very significant world producer of food, where about 55 million vegetables are produced, for approx. 450 million people. It is very interesting that vegetable growing covers 4% of arable areas in EU countries. The total food value is 15%.

The same author concludes that it is very clear that food production as well as vegetable growing are above the needs of population.

According to graph.3, it can be seen that the average vegetable growing in EU until 2014 was significantly higher than the average in Serbia and our neighboring countries. Only Croatia almost reached EU average since it became the member of EU in 2013.



Graph.3. Vegetable yield in  $t\ ha^{-1}$  in regional countries and average yield in EU

According to the last official data, yields per area unit are increasing, but due to area decreasing, our competitiveness at the world and European market is still at the bottom of the scale. Our chance, especially for smaller producers, besides investing in conventional production, is to enlarge organic agricultural production – vegetable growing. It is something that most of the authors agree with in Serbia (Ilin et al, 2013, Lazić, 2011, Raškovič at all 2013).

It is also noticed at the global market that there are less big producers and more associated producers (Dehnen – Schmutz et al, 2010).

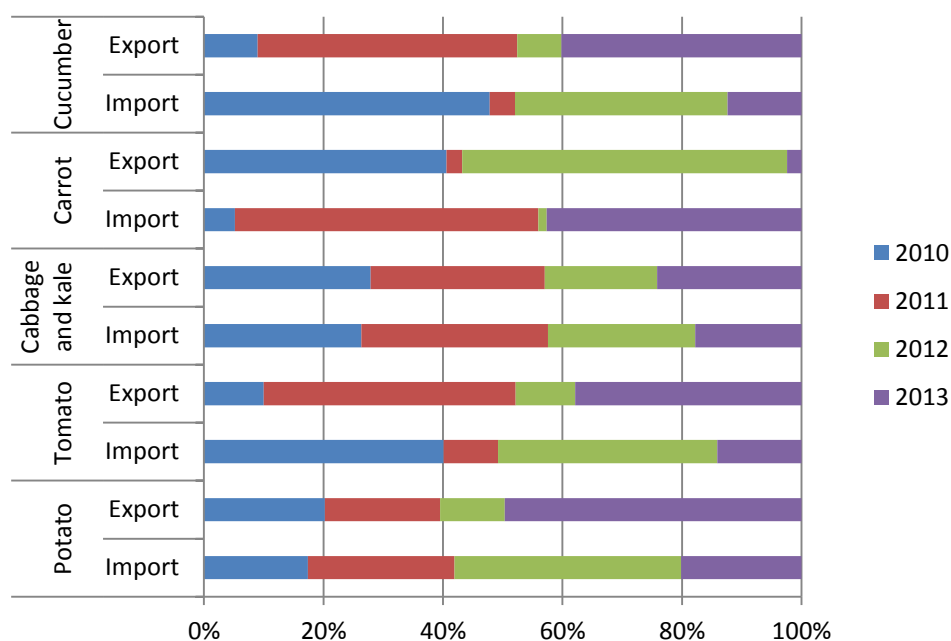
The market of expensive products of higher nutritive quality, both fruit and vegetables, is bigger and bigger (Sophia Wu Huang, 2004, Bojnec and Ferto, 2008). In EU producers are aware how important the local products are, so we have to take measures and interests for local sorts of high quality, not price.

#### Import and export of vegetables in The Republic of Serbia

By analysing competitive economy of Serbia, speaking about fruit and vegetable growing in 2006, Biljana Persnal at all consider that “ Negligible part ( in promiles or some percents ) of totally produced quantities are exported. Export of these products, and other vegetable growing crops is dominantly directed to the markets of neighbouring countries.”

Slightly different opinion is written in Ilin’s paper in 2012. It is said that at this level of production, market surpluses of middle late and late vegetables are accomplished, but only 96,3 million vegetables are exported. He also thinks that Serbia has to overcome the deficit of early and middle early vegetables, which according to the author lasts already two centuries due to increasing the production in protected area.

According to the researches of Marković ( 2016 ) about the export structure of agricultural-food processing products of The Republic of Serbia, the most represented are cereals, fruit and vegetables, totally exported at approx.. 24%. On the other hand, the most important products that are imported speaking about the import field of agricultural-food processing are fruit and vegetables, approx. 24%.



Graph.4.Import and export of vegetables from Serbia from 2010-2013 ( FAO )

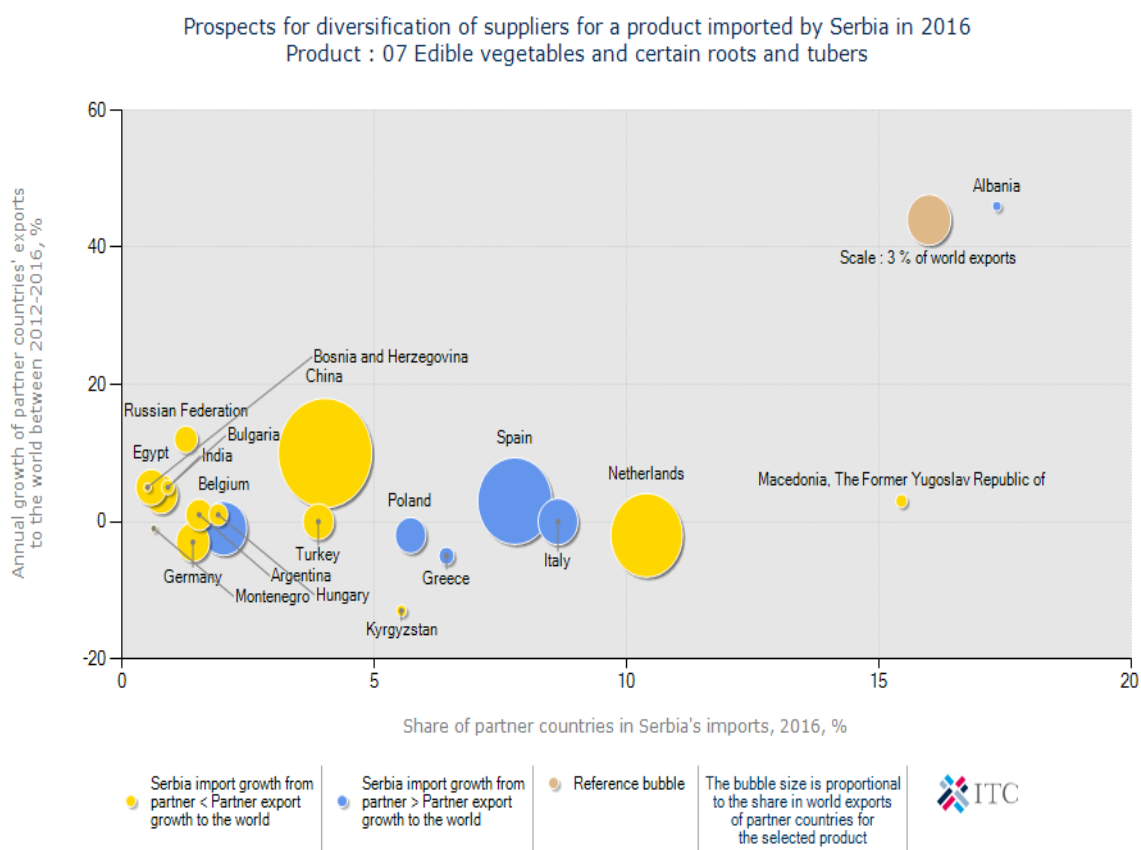
Import-export was analysed by FAO until 2013. Four last years were taken into account.

Unfortunately, every attempt for logical conclusion regarded oscillation between import and export was unsuccessful.

If we try to analyse the relation between production and import, we can notice that the production has no big deviations in examined years, while oscillations in import – export were significant.

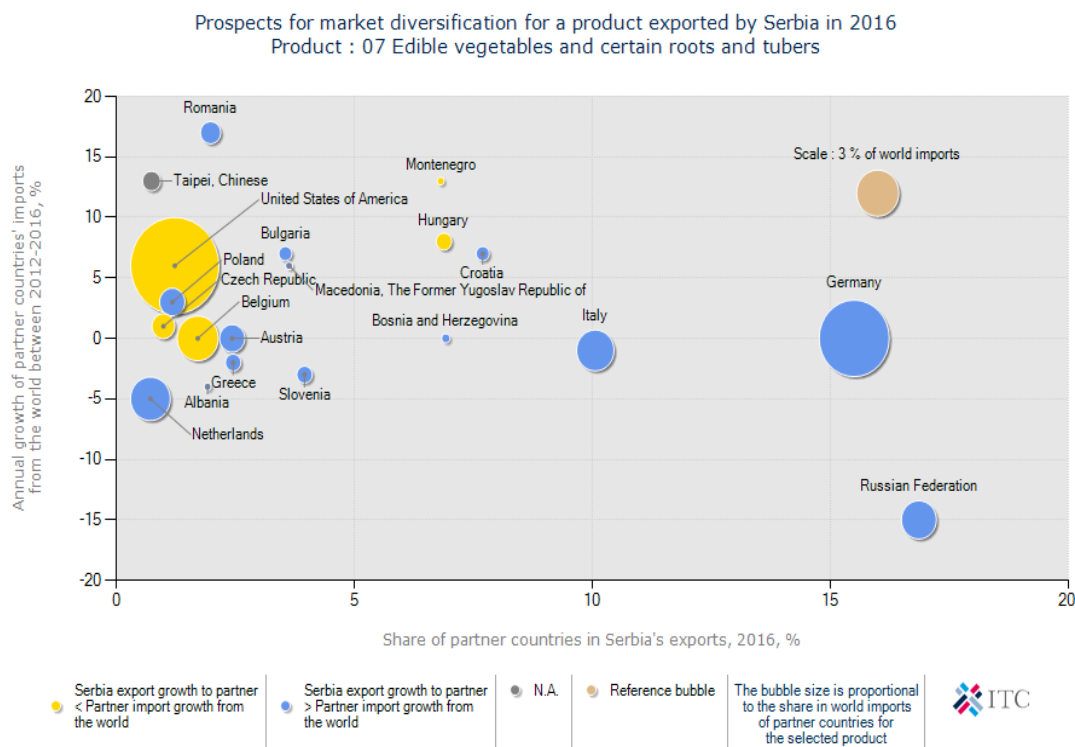
Partial connection is seen in the example of tomato. The lowest yield ( but not so drastic ) was in 2010 and 2012. That’s why, the largest quantities of this vegetable were imported then. It is not clear why in 2012, when it was a poor crop of carrot, export was 20 times higher than import. If we say that import is of seasonal character, i.e. tomato and cucumber, the oscillations must not be so high. So, it can happen that in one year we can have dominated import of one crop, and in the next year dominated export of the same crop.

The largest quantities are imported from Albania 17,34%, then Macedonia 15,45 %, The Netherlands 10,4%, Italy about 9%, Spain 8%, Greek 7% and Poland 6%.



Graph.5. Import of vegetables in Serbia in 2016

These data show that the largest quantities are imported from neighbouring countries with warmer climate and cheap labour force, at lower prices ( early vegetables ) but the import continues even when we do have vegetables in our country ( i.e. tomato, watermelon, melon...) which negatively influence on our domestic vegetable market. Growth of import from Albania, approx.. 46% at annual level, is very significant. Vegetable growing has always contained a sociological characteristic which helped small farms to survive. There are very favourable ecological conditions for vegetable growing in Serbia, no matter that tomato imported from Albania, Macedonia, Turkey etc. is cheaper, it must not be allowed to lose this battle which means survival for many farms, making them exporters of their vegetables. The Netherlands is an important exporter since it belongs to the group of countries that give high subventions for agriculture. It has high level of technology and yields, so its production price is lower than ours. Our producers cannot take abreast with such prices. The supply for any kind of vegetable that comes from Serbia is at minimum level, so we do not have influence on the price at world market, but that price determine the price in our country. Our total production is not large, and we export only few per cent, i.e. out of 639,410 t of potatoes, we export 1.919t or 0.3% (mpzzs)



Graph.6.Export of vegetables from Serbia in 2016

Source:trademap.org

The biggest export is in Russian federation, about 17%, Germany 15,5 %, Italy 10%. The problem is that all these three countries have a trend for decreasing annual export, most decreased is to Russia, even 15%. Significant annual increasing export is noticed toward neighbouring countries, Montenegro about 13%, Hungary 8% and Croatia about 7%. Higher yield and better product qualities can be maintained only by using modern technology in vegetable growing, leading to bigger competitiveness at foreign market. So, it is possible through higher investment in production. Producers can get subventions (*Published in "Official Gazette of Republic of Serbia", No 38/16, April 13, 2016*) All suggested measures have only one aim – production increasing, better quality and better disposal of goods. For small producers, it is very important if more cold storage plants and storages become easily available, if they can easily sell their vegetables, specialize in the production of certain crop, increase the capacities (machinery), as well as advance their knowledge.

### Conclusion

According to the analysis of important elements of Serbian vegetable growing (areas, yield, trade, available financial resources ) during the last five years, and parallel with previous researches, the following conclusions can be made:

In spite of the fact that there are favourable ecological conditions in Serbia, there is a trend for decreasing vegetable areas.

There is a clear regional incompatibility when choice of crops, areas, and the most important –achieved yield are in question. The region of Šumadija is the best-known for vegetable growing, but the highest yield is in the region of Vojvodina autonomous province.

Producers are left to their own, the decision what to grow and on which areas depend on financial ( un ) success in the previous production year.



Yields of all the countries in the region are under EU average. Among neighbouring countries, only Bosnia and Herzegovina has worse position than Serbia.

It is optimistic that the vegetable yields in Serbia are increasing from year to year, but since the areas decrease, we are not on the list of important world or European vegetable producers. Supply of vegetables at European market is bigger than demand, so production and market change in order to encourage local production, the production of specific crops in the region where quantity is more important than quality.

Organic production is on very low level in Serbia, and that's why it should be offered as a part of ethno-tourism.

Our producers have the only chance and it is their mutual supply, if not for world market, but for European or Russian.

Organized purchase is necessary, and its result should be supplying at the market of standard quality products.

More cold storage plants are necessary, as well as to offer fresh fruit, secondary products, i.e. secondary industry should be enlarged.

To fulfil all these nice wishes, more investment is of great importance, and that should be done through price supports credits.

### **References**

- Bojnec Š., Ferto I. (2008). European enlargement and agro-food trade. *Canadian Journal of Agricultural Economics* 56 (4): 563-579.
- Dehnen-Schmuts K., Holdenrieder O., Jeger M.J., Pautasso M. (2010): Structural change in the international horticultural industry: some implications for plant health. *Scientia Horticulturae* 125 (1): 1-15.
- Ilin Ž. (2010). The situation in the production of vegetables in Serbia at the end of the first decade of the 21st century. *Proceedings, XI Counseling "Contemporary vegetable production"*, Faculty of Agriculture Novi Sad, December 11, 2010, p. 4-6.
- Ilin Ž., Gvozdrenović Đ., Božanski, J., Novković N., Adamo B. (2013). Production of vegetables in the function of village development, *Proceedings of the Village Development Perspective, SANU Department of Chemical and Biological Sciences*.
- Lazić B. (2011). Organic vegetation. *Endowment Andrejević, Belgrade*, p.88
- Marković M. (2016). Importance of agro-food products in the foreign trade of the Republic of Serbia, *Internattionall sciientiiffiic conference - ERAZ 2016: Knowledge based sustainable economic development*
- Milošević V., Đukanović L., Rašković V., Stepić R. (2012). Application of new technologies in agriculture in order to protect the environment. *International conference NEWENVIRO new approaches for assessment and improvement of environmental status in the Balkan region; Interactions between organisms and environment, S.Kamenica, Serbia, May 28-30, 4*
- Pejanović R. (2013). Development problems and priorities of agriculture in Republic of Serbia. *Performance and development possibilities of the agriculture industry in AP Vojvodina: contribution to the regional strategy for the promotion of agrarian business*.
- Presnall B., Branković A., Savčić R. (2006). Fresh fruits and vegetables 2006: competitiveness of the Serbian economy, *Jefferson Institute, Beograd*
- Rašković V., Đukanović L., Stepić R., Milošević V. (2015). Organic farming –Brochure for farmers, *agricultural High School of Professional Studies Sabac*.
- Rašković V., Đukanović L., Stepić R., Milošević V. (2013). Prospects of development of organic agriculture and eco -tourism in the area of Fruška Gora, *24thInternational Scientific-Expert Conference on Agriculture and Food Industry*

- Rašković V., Stepić R., Milošević V., Glišić M. (2016). Role of Higher Education in Rural Development of Serbia Collection of Works Perspective of Village Development, SANU Department of Chemical and Biological Sciences
- Rašković V., Stepić R., Milošević V., Kovačević B., Veselić M. (2014). The importance of choosing the tomato variety on the dynamics of yield formation and the amount of gross income realized, Presentation; III International Symposium and XIX Scientific Conference of Agronomists of Republic of Srpska, March 25-28, 2014, Trebinje, Bosnia and Herzegovina.
- Wu Huang Sophia (2004). Global Trade Patterns in Fruits and Vegetables, Electronic Outlook Report from the Economic Research Service, Number WRS 04-06.
- [www.fao.com](http://www.fao.com)
- [www.rzs.co.rs](http://www.rzs.co.rs)
- [www.slglasnik.com](http://www.slglasnik.com)
- [www.stips.minpolj.gov.rs](http://www.stips.minpolj.gov.rs)
- [www.trademap.org/Index.aspx](http://www.trademap.org/Index.aspx)
- Živkov G., Obućina B., Teofilović N., Bernardon P., Dulić I. (2012). Study: Analysis of trends in the production and trade of agricultural products from Vojvodina in relation to production and trade in Serbia, the region, the EU and the world ", for" Agricultural Export Promotion Fund - APF ", studies financed by the Republic of Austria

## EARLY PHYTOTOXIC EFFECTS OF SULFONYLUREA HERBICIDES IN MAIZE LINES

Vesna DRAGIČEVIĆ\*, Milan BRANKOV, Milena SIMIĆ

Maize Research Institute “Zemun Polje”, Slobodana Bajića 1, 11185 Zemun Polje, Serbia

\*Corresponding author: vdragicevic@mrizp.rs

### Abstract

Maize lines are susceptible to various stressful conditions. One of the main problems in maize seed production is weed control and absence of registered herbicides, while the herbicides commonly used in hybrid crop could express phytotoxicity to maize lines. The susceptibility of six maize lines to sulfonylurea herbicides (Motivell 6 OD – H1 and Equip – H2), applied in recommended dose – RD and double dose – DD was tested during 2015 and 2016. Herbicides were applied in 5-6 leaves phase (15-16 BBCH). Aboveground parts of maize plants were sampled for phytic phosphorus ( $P_{phy}$ ) determination 48 hours after herbicide application. Grain yield was determined after harvest. Irrespective to the variations in grain yield between years, H1 treatment in average increased grain yield of L1, L3, L5 and L6 (mainly in RD) and decreased yield of L2 and L4, while H2 increased average grain yield of L3, L4 and L6 and decreased it of L1, L2 and L5, with slightly higher values obtained by DD, when compared to control. H1 treatment induced mainly decrease in  $P_{phy}$  concentration, while H2 induced increase in  $P_{phy}$  concentration in comparison to control, as a consequence of induced stress. This was underlined mainly by DD of applied herbicides. Variations in  $P_{phy}$  concentration in maize leaves showed significant and positive correlation with grain yield in L2, L3, L4 and L6, while the correlation was negative in L1 and L5. In those lines, H2 mainly induced yield reduction. The highest yield reduction by both herbicide treatments were obtained in L2, line with the highest  $P_{phy}$  increase induced also by herbicides, which defines it as a sensitive genotype. For its production, sulfonylurea herbicides are not recommendable for use.

**Keywords:** *Maize lines, Sulfonylurea herbicides, Phytic phosphorus, Grain Yield.*

### Introduction

Weed control, which imply herbicide application is one the most important measures in maize seed production. In general, maize lines have smaller habitus, enabling better conditions for higher weed infestation, than maize hybrid crop. In some cases, when weed infestation is high enough, this could lead to the total yield devastation (Stefanović et al., 2007). What is more, maize lines have increased susceptibility to various stressful factors, including herbicides (Stefanović et al., 2010), what means that herbicide application in maize seed crop is necessary and difficult measure to apply. The signs of herbicide phytotoxicity on maize plants are frequently linked to growth delay, reduction in plant height, leaf area, and as it was upper mentioned, it could lead to total destruction of the plants. Due to the crop susceptibility, agro-ecological conditions and type, herbicides could induce temporary stress, when plants are able to regenerate in lesser or greater extent and to achieve grain yield or permanent stress, when greater plant damages exist, having as a consequence greater yield losses or yield absence (Carvalho, 2007). Weed control was successfully achieved by the introduction of sulfonylurea herbicides. Auškalnienė and Auškalnis (2006) stated that the green biomass of maize was 1–18.4 t ha<sup>-1</sup> higher in plots treated with sulfonylurea herbicides, than in the untreated plots. On

the other hand, sulfonylurea herbicides could express high phytotoxicity on maize lines in comparison to herbicides from the other groups (Stefanović et al., 2010). The signs of phytotoxicity could vary among seasons, with severe injuries during colder seasons with low precipitation level (Dragičević et al., 2012). The same authors indicate that in susceptible lines, increase in dry matter and free energy could be considered as an early sign of phytotoxicity, while the individual herbicides affect plants energetic system differently. For instance, nicosulfuron increases energy consumption, while the foramsulfuron increases plant potential energy, mainly from metabolism.

Phytic acid is the main phosphorus storage in the plants and it is mostly seed constituent. Nevertheless, it also has an important role in green parts of plants in protection during stressful conditions, particularly when environmental pollutants are considered. Dutta et al. (2014) found that vegetables with increased phytate content such as radish, are the most tolerant to arsenic, with least reduction in germination and dry matter production, the lowest lipid peroxidation value and highest chlorophylls and carotenoids stability indices. Dragičević et al. (2011a) and Brankov et al. (2015) also suggested that phytate plays an important role in expression of herbicide tolerance in maize, particularly when sulfonylurea herbicides are considered. The insignificant variation in phytate content, as well as slight yield reduction was observable in tolerant maize lines. The aim of this study was to examine response of six maize inbred lines to two sulfonylurea herbicides (nicosulfuron and foramsulfuron) applied in recommended and double dose and to define tolerant lines, based on alterations in phytic phosphorus content and grain yield.

### **Material and Methods**

The field experiment was conducted during 2015 and 2016 in the field of the Maize Research Institute, in Zemun Polje on a slightly calcareous chernozem soil type under rain-fed conditions. During both experimental years, winter wheat was a preceding crop. The influence of two sulfonylurea herbicides applied in recommended (RD) and double doses (DD) were tested: H1 - Motivell Extra 6 OD (nicosulfuron 60 g a.i. l<sup>-1</sup>), applied in 0.75 and 1.5 l ha<sup>-1</sup>, respectively and H2 - Equip (foramsulfuron 22.5 g a.i. l<sup>-1</sup>), applied in 2 and 4 l ha<sup>-1</sup>, respectively and C – control (without herbicide application), on set of 6 ZP inbred lines. 48 hours after application, plant shoots were sampled for chemical analysis. The experiment was conducted by RBCD design with four replications: main plots encompassed 4 rows of each line, while subplots included two herbicides and control, without herbicide application.

The sowing was performed at the end of April in 2015 and at the middle of April in 2016, due to the meteorological conditions, while the herbicides were applied in the 5–6-leaf phase. The content of phytic phosphorus (P<sub>phy</sub>) was determined after drying at 60 °C and milling of the samples, by the method of Dragičević et al. (2011b). At the end of vegetation, the maize grain yield was measured and calculated to 14 % of moisture.

The experimental data are presented with standard deviation (SD) and the dependences between grain yield and the content of phytic phosphorus were obtained by correlation (Pearson's coefficients).

**Meteorological conditions.** The experimental years were relatively similar accordingly to the average temperature and precipitation sum (Table 1). The main differences were expressed between first (April-June) and second (July-October) part of vegetative period, when average monthly temperatures were slightly lower in the first part of 2015 and higher during the second part of 2015, when compared to 2016. 2015 was also characterized with the lower precipitation sum during anthesis period (Jun-July) in regard to 2016.

Table 1. Average monthly air temperatures and precipitation sums for vegetative period (April-October) in 2015 and 2016 at Zemun Polje

Month	IV	V	VI	VII	VIII	IX	X	Aver./Sum
Year	Monthly average temperatures							
2015	12.9	19.1	22.1	26.4	25.7	20.2	12.4	19.8
2016	15.3	17.6	23	24.2	22.3	19.4	11.2	19.0
	Precipitation sum							
2015	19.7	97.8	31.1	7.2	56	73.6	65.1	350.5
2016	51.9	47.4	107.4	33.6	43.2	36.6	60.3	380.4

### Results and Discussion

The relatively unfavourable conditions present during anthesis period of 2015 reflected negatively on grain yield, with lower values achieved, when compared to 2016 (Figure 1). Only L6 had similar yields in 2015 and 2016 (4.14 and 3.92 t ha<sup>-1</sup>, respectively), what is from 0.98-2.86 t ha<sup>-1</sup>, higher than other lines in 2015 and from 0.11-1.60 t ha<sup>-1</sup>, higher than L1 and L2 in 2016. Tested lines, also expressed high variability in response to applied sulfonylurea herbicides. It is important to underline that sulfonylurea herbicides express good efficiency in weed control, but in parallel, they also expressed increased phytotoxicity in maize crop, particularly when inbred lines are considered (Stefanović et al., 2007; Malidža, 2007).

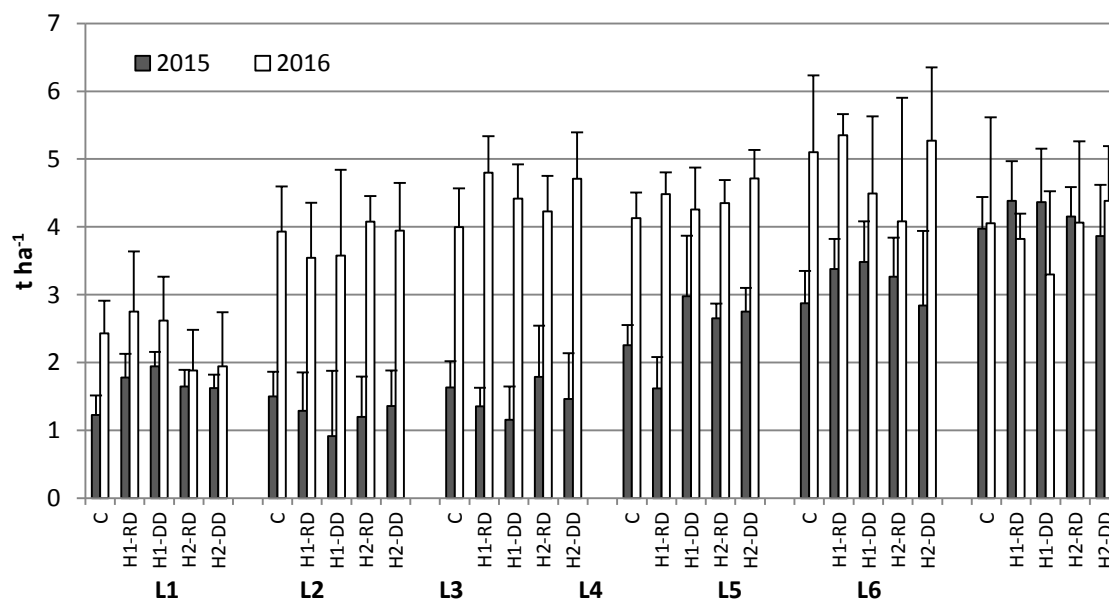


Figure 1. Grain yield of 6 maize inbred lines (L1 - L6) treated with nicosulfuron (H1) and foramsulfuron (H2) applied in recommended dose (RD) and double dose (DD) and control (C) – without herbicide treatment

H1 treatment (nicosulfuron) was reflected on the increase of grain yield values in L1, L4, L5 and L6 in 2015 (mainly in DD treatment), as well as in L1, L3, L4 and L5 in 2016 (mainly RD treatment), when compared to control and other treatments. Nevertheless, grain yield reduction in both years by H2 treatment (foramsulfuron) was observable in L1 and L5, meaning that this treatment induced permanent stress and so, the higher yield losses, in regard to the nicosulfuron (Carvalho, 2007). The lowest values of grain yield were noticed in 2015 by H1-DD combination in L2 and in 2016 by H2-RD in L1, while the highest values were obtained by H1-RD treatment in L5 and L6 (for 2015 and 2016, respectively). Accordingly to

the results of Stefanović et al. (2010) and Brankov et al. (2015), reduction in maize grain yield was slight in tolerant lines, when sulfonylurea herbicides were applied, while in sensitive genotypes visible damages were connected to the losses of grain yield. Phytate is important metabolite that plays key role in tolerance to herbicides (Dragičević et al, 2011a). The examined genotypes reacted variously to applied herbicides, with negligible difference between seasons (average values for 2015 and 2016 were 2.00 and 1.92 mg g<sup>-1</sup> of P<sub>phy</sub>, respectively). The difference between genotypes in average P<sub>phy</sub> content varied from 4.3% (between L2 and L3) to 20.1% (between L2 and L4). Examined lines reacted mostly to nicosulfuron treatment by reduction of the P<sub>phy</sub>, while foramsulfuron increased P<sub>phy</sub> content in shoot (Figure 2). RD increased P<sub>phy</sub> content in L2, L5 and L6, while DD increased in the shoots of L1, L3 and L4, irrespective to the season). The highest values were obtained in 2015 by H2-RD in L6 and in 2016 by H1-DD in L4. In sensitive lines, particularly during the stressful seasons (like 2015), when higher losses of grain yields were present, the increase in phytate content is observable (Brankov et al., 2015). What is more, the obtained difference between applied sulfonylureas could lay in their diverse impact on plant energetic system, since nicosulfuron increases energy depletion, while foramsulfuron increases energy from metabolism (Dragičević et al., 2012).

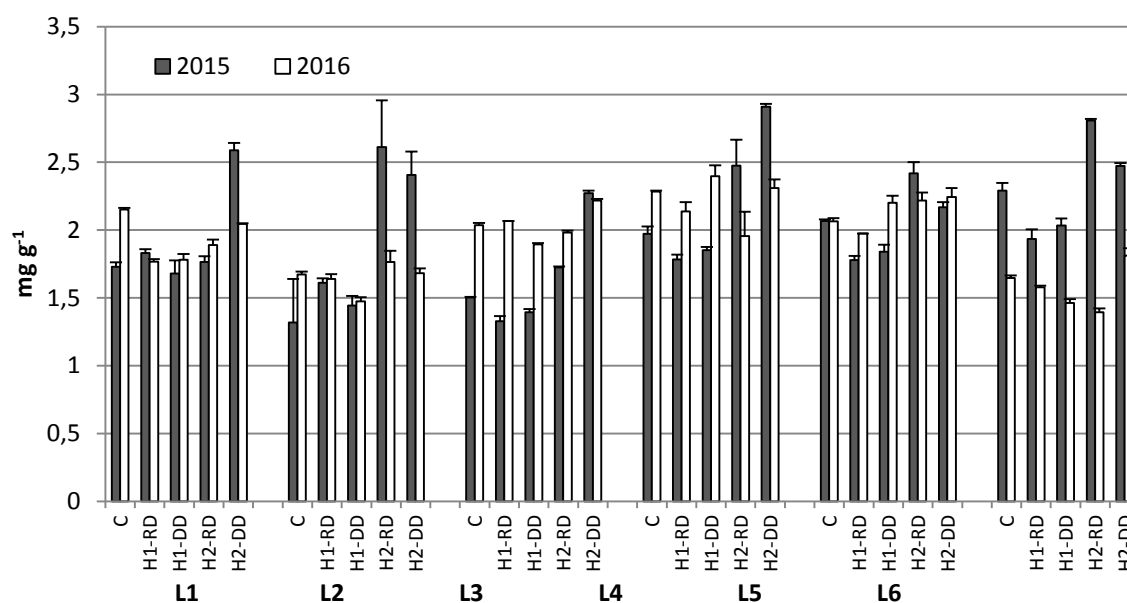


Figure 2. Content of phytic phosphorus of 6 maize inbred lines (L1 - L6) treated with nicosulfuron (H1) and foramsulfuron (H2) applied in recommended dose (RD) and double dose (DD) and control (C) – without herbicide treatment

The results present in Table 1 indicate significant correlation between grain yield and P<sub>phy</sub> content in maize shoots, 48h after herbicide application. The significant and positive correlation was obtained with application of both herbicides and the higher coefficient (0.565) was noticed by the application of nicosulfuron (H1), indicating that alterations in P<sub>phy</sub> content are good indicators of plant reaction to herbicide stress, particularly when sulfonylureas are considered. Brankov et al. (2015) also underlined that phytate is an important factor that contributes to herbicide tolerance in maize lines. The highest coefficients were achieved for L4 and L5 (0.78 and -0.87, respectively). In L2, L3, L4 and L6, P<sub>phy</sub> increase was connected to the grain yield raise, while in L1 and L5, P<sub>phy</sub> increase was linked to the grain yield reduction.

Table 1. Correlation between grain yield and phytic phosphorus in maize grain

Line	H1	H2	L1	L2	L3	L4	L5	L6
Correlation coefficient	0.565*	0.338*	-0.62*	0.50*	0.58*	0.78*	-0.87*	0.62*

\*The significant values at the level of significance of 0.05.

### Conclusions

Obtained data indicated that variations in phytate content in maize leaves during the first 48h after herbicide application are the good indicator of genotype tolerance to sulfonylureas. Phytate is also an important factor that regulates tolerance to herbicides, irrespective to the diverse response observed in different lines. In general lines with high  $P_{phy}$  content in leaves are potentially more tolerant to sulfonylureas and environmental stressful factors (such as meteorological factors) having the least yield losses in relation to the susceptible lines.

### Acknowledgements

This study was supported by the Ministry of Education, Science and Technological Development of the Republic of Serbia through the project TR31037.

### References

- Auškalnienė O., Auškalnis A. (2006). Effect of sulfonylurea herbicides on weeds and maize. *Agronomy Research* 4 (Special issue): 129–132.
- Brankov M., Simić M., Dragičević V., Vrbničanin S., Spasojević I. (2015). Genotype dependent tolerance to herbicides of maize (*Zea mays*, L) inbred lines. *Genetika*, 47 (1): 97-106.
- Carvalho de J. P., Nicolai M., Rodrigues Ferreira R., de Oliveira A. V. Figueira, Christoffoleti P.C. (2009). Herbicide selectivity by differential metabolism: Considerations for reducing crop damages. *Science Agriculture (Piracicaba, Braz.)*, 66: 136-142.
- Dragičević V., Simić M., Brankov M., Spasojević I., Kresović B. (2011a): Alterations of phosphorus metabolism in maize inbred lines influenced by herbicides. *Herbologia*, 12 (3): 93-102.
- Dragičević V., Simić M., Brankov M., Spasojević I., Sečanski M., Kresović B. (2012). Thermodynamic characterisation of early phytotoxic effects of sulfonylurea herbicides to maize lines. *Pesticides and Phytomedicine (Belgrade)*, 27 (3): 231–237.
- Dragicevic V., Sredojevic S., Peric V., Nišavic A., Srebric M. (2011b). Validation study of a rapid colorimetric method for the determination of phytic acid and inorganic phosphorus from seeds. *Acta Periodica Technologica*, 42: 11-21.
- Dutta P., Islam Md.N., Mondal S. (2014). Interactive effect of arsenic stress and seed phytate content on germination and seedling development of different vegetable crops. *Journal of Plant Physiology and Pathology*, 2: 2
- Malidža G. (2007). The sulfonylurea herbicides selectivity towards maize, depending on the genotype and the application of insecticides. Ph.D. thesis, Faculty of Agriculture, Belgrade, 1-82.
- Stefanović L., Simić M., Dragičević V. (2010). Studies on maize inbred lines susceptibility to herbicides. *Genetika*, 42 (1): 155-168.
- Stefanovic L., Simic M., Rošulj M., Vidakovic M., Vancetovic J., Milivojevic M., Misovic M., Selakovic D., Hojka Z. (2007). Problems in weed control in Serbian maize seed production. *Maydica*, 52: 277-280.

## RESULTS OF INVESTIGATION WITH DIFFERENT VARIETIES OF SWEET POTATO IN SOMBOR AREA (SERBIA)

Vladimir SABADOŠ<sup>1\*</sup>, Jelena IVAN, Olivera SEKULIĆ<sup>1</sup>, Danijela DOROTIĆ<sup>1</sup>

<sup>1</sup>Agricultural extension services “Sombor”

\*Corresponding author: agroso@mts.rs

### Abstract

Sweet potato is becoming more popular culture for cultivation because of its nutritive values and pleasant taste. It is one of the most significant vegetable cultures in the world, while in our region people do not know much about it and it is not frequently cultivated vegetable. Sweet potato does not have much in common with potato except that they are used in the same way for the meal preparation. Latin name for sweet potato is *Ipomea batatas* and it belongs to the family of Convolvulaceae, while *Solanum tuberosum* potato belongs to the family of Solanaceae. Cultivation of sweet potato requires special climatic conditions and the right choice of soil. Agroecological conditions of our country are suitable for a successful cultivation of sweet potato, which is evident in the results of the trial conducted in PSS Sombor. On the trial field of PSS Sombor, the trial with two varieties of sweet potato was conducted during the period of three years. The trial is conducted in two variants with mulching with black foil and without mulching in “drop by drop” system. During the vegetation, no chemical treatments for protection from diseases and insects were applied. The trial results showed that with the application of modern growing technology, sweet potato can be successfully grown in Vojvodina.

**Keywords:** *sweet potato, vegetable, cultivation*

### Introduction

In recent year the demand for sweet potatoes in the Serbian market has increased. Sweet potato is tropical plant, but it can be successfully cultivated in moderate climates, where it is grown from seedlings. It is suitable for organic production because it is highly resistant to diseases and pests. Sweet potato (*Ipomea batatas* L.) is a perennial tropical plant, widely grown and used in Asia, America and Africa, but in Serbia it is less cultivated plant species. Sweet potato is a biennial plant, but in Serbia it is cultivated as annual plant. Secondary bundle tuber of root and young leaves are used in consuming. Taste of sweet potato is specific for its sweetness after what it has been named. One plant can develop four to eighteen tuberous roots, every root can weight 100-500 grams. A stem can reach the length of 60 cm to 5 m. Leaves are heart-shaped and smooth, colour of flowers is light pink to light violet. The plant is high in calories, and it contains a lot of starch, but it contains no fat and it has low content of sugar. Content of vitamins (A, B6, C, E) and minerals (K, Ca, Mg, Fe) is very high. Sweet potato is especially suitable for people who are diabetics because of low glycemic index. In food preparation, it is used in same way as an ordinary potato. It can be cooked, fried and flour can be made of it. Young leaves can be cooked in a similar way as spinach. Yellow coloured sweet potato is suitable for salted food and sweets can be prepared with orange and red sweet potato. It can be boiled faster than ordinary potato.

It is the best to produce sweet potato on deep and fertile soil. It needs high humidity and production can be high only under irrigation. Sweet potato also requires moderate climate,



minimum four months without frost. Temperatures below 15<sup>0</sup>C and higher than 30<sup>0</sup>C hinder the development of plant and can decrease yield. Temperatures below 10<sup>0</sup>C can cause internal damage of plant. In our climatic conditions sweet potato flowers in autumn, seeds do not mature, so seedlings are produced in a green house under controlled conditions. Nursery plants are ready for planting after four to six weeks, when they are in stage of 5 to 6 leaves and their height is 15 -25 cm. In order to make the production successful, a primary tillage should be performed in autumn with fertilization with farmyard manure (20-30 t/ha) and usage of other fertilizers is based on the results of the analysis of soil fertility. Seedbed finishing is in spring, and it is about 5-10 cm deep. Planting time is after spring frosts, and at least 2 – 3 nodes must be in ground during the planting. Spacing between rows is 100-120 cm and 30-50 cm between plants in a row. Favorable conditions for the plant growth can be achieved with application of black mulch foil. In the same time, the irrigation system „drop by drop“ is applied. Sweet potato can be produced on the same parcel after three years. Three month after planting sweet potato is ready to harvest. Sometimes harvest can occur later if a producer wants to have bigger roots and higher yield. Common length for market is 15-20 cm and recommended weight is 150-400 grams. In our climatic conditions harvest of sweet potato is in the period from August to October, always before first frosts. Tuberous roots will develop firm crust if plant parts that are above ground are cut several days before harvest. Firm crust and tuberous roots reduce the possibility of mechanical damage during harvest and storage of sweet potato. Harvest of sweet potato can be done by hand or by a potato digger. Before storage, it is necessary to separate damaged roots from healthy ones, with the aim to prevent infections and losses. For longer storage, sweet potato requires temperature around 15<sup>0</sup>C and relative humidity 85-90%

### **Material and Methods**

Trial was set up on the trial field of PSS „Sombor“ in three years (2014, 2015, 2016) on soil type grassland black soil. These three years were different regarding precipitation amount. First year (2014.) had enough amount and good disposition of rainfall, while 2015. and 2016. were deficient in precipitation during vegetation period. Trial was set up with two varieties of sweet potato with different colours of flesh in two variants. Varieties with orange and white flesh colour were in variants with and without black mulch foil under the irrigation by „drop by drop“ system. In all observed years, planting of sweet potato was in the stage of four leaves, in first decade of May. Row spacing in planting was 120 cm between rows and 40 cm between plants in one row. The elementary parcel had 250 plants. The aspects that were observed in the trial during the years mentioned above are the following: yield, dry matter and sugar content.



Picture 1: Nursery plants of sweet potato

### **Results and Discussion**

Sweet potato with orange flesh colour with usage of mulch foil achieved average yield of 105,3 t/ha, while variant without usage of foil achieved average yield of 68,8 t/ha (Table 1). Achieved difference in yield was 36,5 t/ha, it is for 53% higher than the yield in the variant with usage of foil. Dry matter content in sweet potato with orange flesh colour was 19,4 % in the variant with usage of foil, without foil usage it was 18,5 %. Difference in dry matter content in variant with and without foil was 0,9 %, it is about 4 % higher than in variant with usage of foil. Sugar content in orange coloured flesh sweet potato variety with usage of foil was 11,0 % without usage of foil was 10,8%. It is for 2% higher in variant with foil usage. Sweet potato with white flesh colour with usage of mulch foil achieved average yield of 118,1 t/ha, while variant without usage of foil achieved average yield of 81,9 t/ha (Table 2). Difference between average yield was 36,2 t/ha, which is 42% higher yield in variant with usage of foil. Dry matter content in sweet potato with white flesh was 18,2 % in variant with and without foil usage. Sugar content in white coloured flesh sweet potato variety with usage of foil was 10,0% , without usage of foil was 9,5%. It is for 5% higher in variant with foil usage.

Table 1: Average yield, dry matter content, and sugar content in orange sweet potato variety during 2014-2016. year

	variety	Average yield t/ha	Dry matter %	sacch mass %
Without the use of foil	Orange batat	68,8	18,5	10,8
With the use of foil	Orange batat	105,3	19,4	11,0
different		36,5	0,9	0,2
%		53	4	2

Table 2: Average yield, dry matter content, and sugar content in white sweet potato variety during 2014-2016. year

	variety	Average yield t/ha	Dry matter %	sacch mass %
Without the use of foil	White batat	81,9	18,2	9,5
With the use of foil	White batat	118,1	18,2	10,0
different %		36,2	0	0,5

### Conclusion

Sweet potato-batat is becoming more popular culture for cultivation because of its nutritive values and pleasant taste. Batat is suitable for organic production because the plant is resistant to diseases and pests. The results of the three-year trials with sweet potato show that due to the application of mulch foil the yields are higher than in the cases without usage of foil.



Picture 2: Orange and white flesh varieties of sweet potato

The trial results on the trial field of PSS „Sombor“ in three years (2014, 2015, 2016) showed that with the application of modern growing technology, sweet potato can be successfully grown in Vojvodina.

### **References**

- Lazić B., Đurovka M., Marković V., Ilin Ž., (2011) - Vegetable crops, University of Novi Sad, Faculty of Agriculture
- Ilić Z., Fallik E., Dardić M., (2009) – Harvest, sorting, packaging and storing of vegetables, Faculty of Agriculture, Kosovska Mitrovica
- <https://www.google.rs/search?q=aktuelni+savetnik+batat&oq=aktuelni+savetnik+batat&aqs=chrome..69i57.4948j0j7&sourceid=chrome&ie=UTF-8> (20.12.2015)
- [www.batat.rs](http://www.batat.rs) (24.10.2016.)
- [www.bezgluten.net](http://www.bezgluten.net) (24.10.2016.)
- <http://www.medicalnewstoday.com/articles/281438.php> (07.11.2016.)
- <https://www.agroklub.rs/sortna-lista/povrce/batat-356/> (07.11.2016.)
- <http://www.field-crops.org/assets/pdf/product512fa99bd3c05.pdf> (04.02.2011.)
- <http://blogs.reading.ac.uk/tropical-biodiversity/2013/01/ipomoea-batatas> (07.01.2013.)

## THE EFFECT OF COVER CROPS ON THE CONTENT OF VITAMIN C IN GRAIN OF SWEET MAIZE

Željko DOLIJANOVIĆ<sup>1\*</sup>, Snežana OLJAČA<sup>1</sup>, Dušan KOVAČEVIĆ<sup>1</sup>, Milena SIMIĆ<sup>2</sup>, Jelena SRDIĆ<sup>2</sup>, Nebojša MOMIROVIĆ<sup>1</sup>, Đorđe MORAVČEVIĆ<sup>1</sup>

<sup>1</sup>University of Belgrade, Faculty of Agriculture, Belgrade, Serbia

<sup>2</sup>Maize Research Institute „Zemun Polje“, Belgrade, Serbia

\*Corresponding author: dolijan@agrif.bg.ac.rs

### Abstract

The investigation was conducted in the experimental field of the Maize Research Institute Zemun Polje, Serbia, during 2013/14-2014/15. The experiment was established as a block design with four replications. As winter cover crops-CC (factor A) the following plants were grown: CV–common vetch (*Vicia sativa* L.), FP-field pea (*Pisum sativum* L.), WO-winter oats, (*Avena sativa* L.), FK-fodder kale (*Brassica oleracea* (L.) *convar. acephala*), two variants with mixture of legume crops and oats (CV+WO and FP+WO) and two control treatments: a variant in which the surface was covered with dead organic mulch (DOM) and traditional variant (TV) in which, after ploughing in the fall, plot stayed uncovered during the winter. Green biomass of the cover crops was incorporated into the soil, immediately after cutting. A half of the elementary plot was infested with bio-fertilizer Uniker (BF), in an amount of 10 t ha<sup>-1</sup> (factor B). The bio-fertilizer Uniker contains the strains of cellulolytic and proteolytic bacteria to support the mineralization of entered crop residues. The seeds of sweet maize ‘ZPSC 421su (FAO 400) were sown at the arrangement of 70 cm between rows and 22 cm between plants in the row (65,000 plants per ha). Preceding crop in both years was winter wheat. The content of vitamin C (L- and D – ascorbic acid) was determined by iodometric titration method. The data were processed by ANOVA. The investigated factors (CC and BF) and their interactions showed very significant effect on vitamin C content in both years. The greatest impact on vitamin C content was exhibited in variant of fodder kale but the lowest in variant with winter oats. The vitamin C content usually increased after all the leguminous cover crops compared with DOM and TV. Application of bio-fertilizer influenced positively content of vitamin C only in favourable meteorological conditions in 2015.

**Keywords:** *Sweet maize, cover crops, content of vitamin C, microbiological fertilizer*

### Introduction

Sweet maize, as a vegetable crop, is a special type of maize with particular characteristics, such as sweet taste, thin pericarp and endosperm with delicate texture, and with a high nutritional value (proteins, sugars, and most of vitamins and microelements) (Santos *et al.*, 2014). The content of nutrients depends on the genotype, meteorological conditions and the selected growing technology. It is clear that the way to the exploitation of sweet maize is through maize breeding, requiring the evaluation of the response of cultivars to environmental conditions, of the variability within and between the germplasm under study and the selection of superior genotypes for agronomic traits of interest (Revilla *et al.*, 2010). For the improvement of sweet maize, two strategies can be applied: (1) the introduction of the "sweet" trait into a genotype with normal endosperm, adapted to the growth environment, or (2) the incorporation of sweet maize genotypes into a conventional breeding program. Weather conditions during the growing season, in particular air temperature, have the greatest

influence on sweet maize growth, yield and yield quality (Stone *et al.*, 1999). In order to obtain high yields of good quality the scientists have been searching for the most appropriate growing practices (Dolijanović *et al.*, 2013). In selecting growing technology of sweet maize, climate change must be taken in account, particularly the occurrence of drought periods in the growing season of crops. It is very important to provide enough organic matter, due to the lack of manure which was previously the most applied, it is necessary to search for alternative sources of organic matter. Cover crops used as green manure are a valuable source of organic matter. In the last decades, the evidence of negative impact of agriculture to the environment renewed interest in growing cover crops in autumn and winter, the effect of which is to take up nitrogen that would otherwise be lost, resulting in decreased nitrate concentrations in leachate (Collins *et al.*, 2007). Studies on an application of cover crops had secondary effect of green manures on the yield quality and nutritive value of sweet maize (Zaniewicz-Bajkowska *et al.*, 2012). Bio-fertilizers have an important role in keeping high soil fertility and crop yields increasing (Mahdi *et al.*, 2010; Janošević *et al.*, 2017). The positive impact of microbiological fertilizers is also observed in regards to quality of plant products, as for example increase in lycopene and vitamin C accumulation in sweet maize (Rosa, 2015) and in tomato fruits (Verma *et al.*, 2015; Ochoa-Velasco *et al.*, 2016) and higher glutathione content in maize grain (Dragicevic *et al.*, 2013). Data obtained in this study from field experiments provides valuable knowledge regarding the (i) influences of different type of cover crops and (ii) the applied form of fertilizers (i.e. microbiological) on content of vitamin C in grain of sweet maize.

### Material and methods

A field experiment was carried out in 2013/14–2014/15 growing seasons, at the Experimental Field of Maize Research Institute in Zemun Polje near Belgrade (44°52'N; 20°20'E). The soil was slightly calcareous chernozem with 47% of clay and silt and 53% of sand. The soil at 0-30-cm layer contained 3.22% of organic matter, 0.19% of total N, 1.9% of organic C, 16.2 and 22.4 mg per 100 g soil of available P and extractable K, respectively, 1.38% of total CaCO<sub>3</sub> and had pH 7.3. The experiment was established as a block design with four replications. As winter cover crops (factor A) the following plants were grown: CV–common vetch (*Vicia sativa* L.), FP-field pea (*Pisum sativum* L.), WO-winter oats, (*Avena sativa* L.), FK-fodder kale (*Brassica oleracea* (L.) *convar. acephala*), two variants with mixture of legume crops and oats (CV+WO and FP+WO) and two control treatments: a variant in which the surface was covered with dead organic mulch (DOM) and traditional variant: after ploughing in the fall plot stayed uncovered during the winter (TV). The cover crops (CC) were sown in the amount: common vetch – 120 kg, field pea – 150 kg, oat – 160 kg, and fodder kale 15 kg per ha, and in mixture relation between legume and oats was 70:30. The plot size was 17.5 m<sup>2</sup>. The seeds from the Department for Forage Crops of the Institute of Field and Vegetable Crops in Novi Sad was used for planting of cover crops in both years. Sweet maize hybrid ZPSC 421<sub>SU</sub> (FAO 400) was sown at the arrangement of 70 cm between rows and 22 cm between plants in the row (65,000 plants per ha). Preceding crop in both years was winter wheat. The soil preparation in autumn (ploughing and seedbed preparation) was performed immediately before sowing, when also soil samples were taken for available N analysis at depths of 0-20 cm and 20-40 cm. Further soil sampling from all CC and control treatments was done in the spring, after CC harvest, as well as after sweet maize harvesting. Before the sowing of CC (autumn) and sweet maize (spring) mineral fertilization was applied in order to obtain 120 kg ha<sup>-1</sup> N, 90 kg ha<sup>-1</sup> P and 60 kg ha<sup>-1</sup> K. The total amount of P and K fertilizer was applied in autumn with mono-potassium phosphate fertilizer (a.m. 0:52:34) and the required N amount was incorporated together with sweet maize sowing (urea 46% a.m). Nitrogen fertilization

followed: for non-legume crops and control treatments it was 120, for sole legume it was 80 and for mixture it was 90 kg ha<sup>-1</sup> N. The remaining 40 or 30 kg ha<sup>-1</sup> N was considered to be provided by nitrogen fixation. Green biomass of the cover crops was incorporated in the soil immediately after. Half of the elementary plot was infested with bio-fertilizer (BF) - Uniker (mobilizer of nutrients) in an amount of 10 l ha<sup>-1</sup> (factor B). The bio-fertilizer contains the strains of cellulolytic and proteolytic bacteria to support the mineralization of entered crop residues. The ears were harvested at the stage of milk maturity of kernels. The schedule of the main works on the experiment is shown in Table 1.

Table 1. Chronology of field operations and length of vegetation period of sweet maize

Cover crops sowing	October, 30 2013	November, 13 2014
	2014	2015
Cover crops sampling	April, 23	May, 12
Cover crops and microbiological fertilizer incorporated	May, 12	May, 21
Sweet maize sowing	May, 20	May, 21
Hand weeding 1	June, 27	June, 22
Hand weeding 2	July, 17	July, 15
Sweet maize harvest	August, 14	August, 21
Length of vegetation period of sweet maize (in days)	86	92

The total content of vitamin C (L-ascorbic acid D-ascorbic acid) in the grain of sweet maize was determined by iodometric titration method (Rikovski et al., 1989). The obtained data were processed using analysis of variance for two-factorial experiments (ANOVA). Statistical analysis was performed by SPSS 15.0 (IBM Corporation, Armonk, New York, USA) for Windows Evaluation version. For the individual comparisons, the least significant difference (LSD test) was used.

#### Meteorological conditions

The meteorological conditions during the growing season are presented in Table 2.

Table 2. Average air temperatures and precipitation sums from April to September at Zemun Polje

Months	Temperature (°C)		Precipitation (mm)	
	2014	2015	2014	2015
April	13.7	12.9	84.8	19.7
May	17.4	19.1	192.5	97.8
June	21.1	22.1	71.2	31.1
July	23.2	26.4	187.4	7.2
August	22.6	25.7	41.0	56.0
September	18.0	20.2	75.6	73.6
Average/Sum	19.3	21.1	652.5	285.4

More favourable conditions in term of quantity and distribution of precipitation were in the first year of the investigation. The first year examination also characterized by optimal air temperatures, which has had an effect on the investigation parameter of sweet maize. Precipitation in June and July 2015 were the lowest and air temperatures were the highest but, in this year application of microbiological fertilizer caused a higher content of vitamin C in all investigation treatments.

## Results and discussion

Representative conclusions about the effects of different cover crops and microbiological fertilizer on the content of total amount of vitamin C in grain of sweet maize are obtained by the insight into the results shown in Table 3. The investigated factors (CC and BF) and their interactions showed very significant effect on vitamin C content in both years. The greatest impact on vitamin C content was exhibited in variant of fodder kale but the lowest in variant with winter oats and common vetch. Application of bio-fertilizer influenced positively content of vitamin C only in favourable meteorological conditions that were in 2015. Microbiological fertilizers, usually have positive influence on crop immunity to stressful conditions, particularly drought.

Table 3. The vitamin C content (mg %) in sweet maize grain

Treatments	2014			2015		
	BFØ	BF	Average	BFØ	BF	Average
CV	21,12	21,71	21,42	24,05	31,09	27,57
WO	21,41	27,57	24,49	19,36	26,99	23,18
FK	31,09	29,92	30,51	29,33	32,27	30,80
FP+WO	30,51	28,75	29,63	25,23	31,68	28,46
DOM	29,92	26,40	28,16	26,40	31,09	28,75
CV+WO	31,09	24,05	27,57	26,99	32,27	29,63
FP	29,33	22,29	25,81	25,23	31,68	28,46
TV	29,92	27,57	28,75	25,23	31,09	28,16
<b>Average</b>	<b>28,05</b>	<b>26,03</b>	<b>27,04</b>	<b>25,23</b>	<b>31,02</b>	28,12

LSD 0,05	CC**	BF**	CC*BF**
2014	0,98	0,49	1,39
LSD 0,05	CC**	BF**	CC*BF*
2015	1,18	0,59	1,67

p<0.01 very significant (\*\*); p<0.05 significant (\*); p>0.05 no significant (ns)

The chemical composition of vegetables is genetically conditioned but it could be also modified by factors affecting the growing plant (Lee and Kader, 2000). Content of vitamin C in sweet maize kernels ranged from 21.42 to 30.51 mg% in first and 23.18 to 30.80 in second year of investigation. In general, winter catch crops significantly increased vitamin C content of sweet maize compared with control treatments (Table 3). In addition, legume crops (CV and FP) grown alone contributed to lower concentrations of vitamin C compared to legumes and WO mixtures. Zaniewicz-Bajkowska *et al.* (2011) reported no significant differences in ascorbic acid content of sweet corn following serradella, faba bean summer catch crops, FYM and after mineral fertilisation alone. On the contrary, the kernel ascorbic acid content of sweet corn grown after phacelia and amaranth were significantly higher than the control without organic manure (Zaniewicz-Bajkowska *et al.*, 2012). Other studies have indicated that an application of green manures favourably affected vitamin C and sugar contents of onion, red beet (Jabłońska-Ceglarek *et al.* 2002), white cabbage (Jabłońska-Ceglarek and Rosa, 2003) and leek (Rosa and Jabłońska-Ceglarek, 2009). Salama *et al.* (2014) reported substantially higher vitamin C levels in fennel with organic cultivation compared with mineral cultivation alone. Many studies have found that lower yields, better taste, more Vitamin C, and higher antioxidant levels in organic vegetables are correlated with lower levels of readily available nitrogen (Theuer, 2006). A major focus on many organic farms is increasing the supply of nitrogen for crops, in order to narrow the differences in yields between conventional and organic production systems. Will success in increasing the nitrogen available to plants on organic farms erase the quality advantages of organic produce? Organic potatoes generally

contain more ascorbic acid (Vitamin C) (Hajšlová *et al.*, 2005). Both of these phenomena are associated with lower plant tissue nitrate levels and correspondingly slower growth rates and greater physiological maturity at harvest. This highlights a major difference between organic management and conventional management: the nitrogen economy of the plant. Nitrogen economy has both a quantitative aspect – the amount of nitrogen applied – and a qualitative aspect – the source(s) of that nitrogen. Organic cropping technology frequently is a low-nitrogen input system. This probably is responsible for the generally lower yields of organically cultivated produce, even by technically capable organic farm managers.

Worthington (2001) cited that organic manuring increased vitamin C in lettuce, potato, cabbage and spinach compared to cultivation without organic manuring, the effect being negative for carrot. However, Ismail and Fun (2003) observed increased vitamin C levels only in organically manured swamp cabbage; the organic matter had no effect on vitamin C in Chinese mustard, lettuce and spinach. Warman and Havard (1998) have claimed that it is difficult to indicate which sweet maize cultivation method- mineral fertiliser or organic manure-based one, more favourably influences vitamin C content in sweet corn kernels. The vitamin C content can be influenced by kernel maturity, fertility and moisture content in the soil, cultivation, meteorological conditions and even time of the day (Shewfelt, 1990).

### **Conclusion**

Based on the results, obtained effects of the cover crops, with and without microbiological fertilizer, on content of vitamin C in grain of sweet maize grown on chernozem under rain fed conditions, the following can be concluded: Meteorological conditions during the trial had an important impact on content of vitamin C in all the cropping systems. In favorable year (such as 2014), biofertilizer did not show an effect on the content of vitamin C, and in the second year application of this fertilizer have shown efficacy trough very significant increases in the content of vitamin C. The greatest impact on vitamin C content was exhibited in variant of fodder kale but the lowest in variant with mixture of winter oats and common vetch.

### **Acknowledgement**

This study was supported by the Ministry of Education, Science and Technological Development of the Republic of Serbia.

### **References**

- Collins H.P., Delgado J.A., Alva A.K., Follett R.F. (2007). Use of nitrogen – 15 isotopic techniques to estimate nitrogen cycling from a mustred cover crop to potatoes. *Agron. J.*, 99, 27–35.
- Dolijanović Ž., Momirović N., Simić M., Kovačević D., Oljača S., Mikić A. (2013). Fall and spring sown legume-cereal cover crops for sweet maize production. 2nd International Scientific Conference „Soil and Crop Management: Adaptation and Mitigation of Climate Change”, September 26-28, 2013, Osijek, Croatia. *Proceedings*, 128-135.
- Dragicevic V., Spasojevic I., Oljaca S., Simic M., Dolijanovic Z. (2013). Grain quality in organic and ecological cropping systems. IV International Symposium „Agrosym 2013“, Jahorina 03.-06. October 2013, Bosnia and Herzegovina, *Proceedings*: 700-705.
- Hajšlová J., Schulzová V., Slanina P., Janne K., Hellenas K.E., Andersson C. (2005). Quality of organically and conventionally grown potatoes: Four-year study of micronutrients, metals, secondary metabolites, enzymic browning and organoleptic properties. *Food Addit. Contam.*, 22: 514–534.



- Ismail A., Fun C.S. (2003). Determination of vitamin C,  $\beta$ -carotene and riboflavin contents in five green vegetables organically and conventionally grow. *Malaysian J. Nutr.*, 9(1), 31–39.
- Jabłońska-Ceglarek R., Franczuk J., Zaniewicz-Bajkowska A., Rosa R. (2002). The effect of summer catch crops on yielding and chosen elements of nutritious value of onion and red beet. *Folia Hort.*, 14(2): 11–23.
- Jabłońska-Ceglarek R., Rosa R. (2003). Forecrop green manures and the size and quality of white cabbage yield. *EJPAU, Horticulture*, 6, 1.
- Janosevic B., Dolijanovic Z., Dragicevic V., Simic M., Dodevska M., Djordjevic S., Moravcevic Dj., Miodragovic R. (2017). Cover crop effects on the fate of N in sweet maize (*Zea mays L. saccharata* Sturt.) production in a semiarid region. *International Journal of Plant Production* 11 (2): 285-294.
- Lee S.K., Kader A.A. (2000). Preharvest and postharvest factors influencing vitamin C content of horticultural crops. *Postharv. Biol. Technol.*, 20, 207–220.
- Mahdi Sh., Hassan G.I., Samoon S.A., Rather H.A., Showkat A.D., Zehra B. (2010). Bio-fertilizers in organic agriculture. *J. Phyt.* 10: 42-54.
- Ochoa-Velasco C.E., Valadez-Blanco R., Salas-Coronado R., Sustaita-Rivera F., Hernández-Carlos B., García-Ortega S., Santos-Sánchez N.F. (2016). Effect of nitrogen fertilization and *Bacillus licheniformis* biofertilizer addition on the antioxidants compounds and antioxidant activity of greenhouse cultivated tomato fruits (*Solanum lycopersicum L.* var. Sheva). *Sci. Hort.* 201: 338–345.
- Revilla P., Malvar R.A., Ordás B., Rodriguez V.M., Ordás A. (2010). Genotypic effects on field performance of maize plants carrying the allele sugary 1. *Plant Breeding* 192: 92-95.
- Rikovski I., Džamić M., Rajković M. (1989). *Manual of Analytical Chemistry*. Gradjevinska knjiga, Belgrade.
- Rosa R., Jabłońska-Ceglarek R. (2009). The effect of green fertilizers in the form of forecrops on the content of selected elements of nutritional value in leek (*Allium ampeloprasum* ssp. porrum) cv. ‘Blizzard’. *Electron. J. Pol. Agric. Univ., Horticulture*, 12, 1.
- Rosa R. (2015). Quality of sweet corn yield depending on winter catch crops and weed control method, *Acta Sci. Pol. Hortorum Cultus*, 14(2) 2015, 59-74 .
- Salama Z.A., El Baz F.K., Gaafar A.A., Zaki M.F. (2014). Antioxidant activities of phenolics, flavonoids and vitamin C in two cultivars of fennel (*Foeniculum vulgare* Mill.) in responses to organic and bio-organic fertilizers. *J. Saudi. Soc. Agric. Sci.*, in press, corrected proof, DOI: 10.1016/j.jssas.2013.10.004.
- Santos P.H.A.D., Pereira M.G., Trindade R.S., Cunha K.S., Entringer G.C., Vettorazzi J.C.F. (2014). Agronomic performance of super-sweet corn genotypes in the north of Rio de Janeiro, *Crop Breeding and Applied Biotechnology* 14: 8-14.
- Shewfelt R.L. (1990). Sources of variation in the nutrient content of agricultural commodities from the farm to the consumer. *J. Food Qual.*, 13(1): 37–54.
- Stone P.J., Sorensen I.B., Jamieson P.D. (1999). Effect of soil temperature on phenology, canopy, development, biomass and yield of maize in a cool-temperate climate. *Field Crops Res.*, 63(1): 169–178.
- Theuer R. (2006). State of Science review: Taste of Organic Food. <https://organic-center.org/reportfiles/TasteExecSummary.pdf>
- Verma S., Sharma A., Kumar R., Kaur C., Arora A., Shah R., Nain L. (2015). Improvement of antioxidant and defense properties of Tomato (var. Pusa Rohini) by application of bioaugmented compost. *Saudi J. Biol. Sci.* 22: 256–264.

- Warman P.R., Havard K.A. (1998). Yield, vitamin and mineral contents of organically and conventionally grown potatoes and sweet corn. *Agric. Ecosyst. Environ.*, 68(3): 207–216.
- Worthington V. (2001). Nutritional quality of organic versus conventional fruits, vegetables and grains. *J. Altern. Compl. Med.*, 7(2): 161–173.
- Zaniewicz-Bajkowska A., Rosa R., Kosterna E., Franczuk J. (2011). Serradella and faba bean catch crops as a kind of organic manuring in sweet corn cultivation. In: *Nowoczesne metody analizy surowców rolniczych*. Puchalski, Cz., Bartosz, G. (eds). Wyd. UR, Rzeszów.
- Zaniewicz-Bajkowska A., Rosa R., Kosterna E., Franczuk J. (2012). Phacelia and amaranth catch crops in sweet corn cultivation. Part II. Selected components. *Acta Sci. Pol. Hortorum Cultus*, 11(1): 161–169.

## EVALUATION OF ANTIOXIDANT PROPERTIES OF *SALVIA OFFICINALIS* L., *ROSMARINUS OFFICINALIS* L. FROM EASTERN SLOVAKIA AND FLORSALMIN

Janka PORÁČOVÁ<sup>1\*</sup>, Juliana BARANOVÁ<sup>1</sup>, Vincent SEDLÁK<sup>1</sup>, Zuzana GOGALOVÁ<sup>1</sup>,  
Marta MYDLÁROVÁ BLAŠČÁKOVÁ<sup>1</sup>, Daniela GRUĽOVÁ<sup>2</sup>, Mária KONEČNÁ<sup>1</sup>, Ruslan  
MARIYCHUK<sup>2</sup>, Adriana ELIÁŠOVÁ<sup>2</sup>, Jozef FEJÉR<sup>2</sup>, Janka KOTOSOVÁ<sup>1</sup>

<sup>1</sup>Department of Biology, Faculty of Humanities and Natural Sciences, Presov University in Presov, Slovakia

<sup>2</sup>Department of Ecology, Faculty of Humanities and Natural Sciences, Presov University in Presov, Slovakia

\*Corresponding author: janka.poracova@unipo.sk

### Abstract

Oxygen is an essential component of our life, but imbalance in metabolism and production of reactive oxygen species (ROS) generate some disorders such as Alzheimer's disease, Parkinson's disease, aging and many other neural disorders. The high level or incorporation of free radicals to living system leads to processes of neurodegeneration. The antioxidant system of body plays important role in prevention of many diseases caused by the effect of radicals. The perspective therapeutic resource is a diet rich in natural antioxidants. Nowadays, research is focused on medicinal herbs as a commercial source of antioxidants. This study was conducted to evaluate the potential antioxidant properties of ethanol extracts *Salvia officinalis* L., *Rosmarinus officinalis* L. and commercial tincture from sage (Florsalmin®). The extracts were prepared from dried and fresh plant material. The antioxidant activity was measured spectrophotometrically by DPPH method. The results were expressed by the percentage of DPPH radical inhibition (%) and statistically evaluated. The results of the investigation indicated that *Rosmarinus officinalis* ethanol extract from fresh plant material showed the higher inhibitory capacity of DPPH radical. The inhibition value of DPPH by ethanol extract of *Rosmarinus officinalis* L. was 48.13% (in t = 0 minutes) and 67.46% (t = 35 minutes). Statistical significance in DPPH inhibition values was found in comparing fresh sage ethanol extracts and Florsalmin® at t = 10 and t = 15 (p < 0.04). By comparing dries sage and Florsalmin® statistical significance p < 0.008 was found. We did not found a statistical significance between rosemary extracts and Florsalmin®.

**Keywords:** DPPH, Free radicals, Neurodegenerative diseases, Fresh plant material, Dried plant material.

### Introduction

The human organism is exposed to free radicals in everyday activities. Free radicals come not only from the outside environment, but also from the internal environment due to various reactions of metabolism or energy production. Antioxidant and oxidative compounds are in a certain equilibrium in the organism, and this condition is disturbed by changes in free radical concentration. Oxidative damage to the central nervous system can have a serious impact on human health. Damage to some of the central nervous system may accumulate free radicals and cause degenerative processes. The result of these processes is the emergence of neurodegenerative diseases. The most well known are Alzheimer's disease, Parkinson's disease, Huntington's disease and amyotrophic lateral sclerosis.

In connection with neurodegenerative diseases, the relationship between neurodegeneration, free radicals and antiradical properties of natural substances is increasingly being discussed. The natural substances contained in the plant material show different positive properties for

the human organism. Antiradical activity has been proven in several plant species belong in to the family (*Lamiaceae*), e.g. *Teucrium polium* L. showed a mild correlation between flavonoid content and antiradical activity determined by the DPPH method (Malki et al., 2015). Several studies (Obulescu *et al.*, 2011; Özcan *et al.*, 2015; Abuashwashi *et al.*, 2016) have pointed to antiradical activity of *Salvia officinalis* L. and *Rosmarinus officinalis* L..

### Material and method

*Salvia officinalis* L. and *Rosmarinus officinalis* L. contain rosemary acid and carnosic acid, which belong to important antioxidants. To compare antiradical activity, we used extracts from dried and fresh plant parts as well as purchased product FLORSALMIN® tincture of salvia, which is commonly available for inflammatory diseases of the oral cavity, gums and pharynx.

The plants were grown in the village Petkovce (49 ° 00'06 "S 21 ° 35'53" V), in the southwest part of Ondavska vrchovina at an altitude of about 205 meters, east of the river Topľa. The surface of the village Petkovce consists of loess and slopes. The plants were grown without any chemical preparations and other preparations that could affect the result.

Florsalmin® - medicinal salt tincture is a dilute hydroalcoholic salt extract of medical with anti-inflammatory and antimicrobial effect. It is liquid greenish to brown, strong aromatic scent. The medicine is used for inflammatory diseases of the oral cavity, gingivitis and pharynx, such as supportive treatment for angina and after surgery in the oral cavity, to suppress odor from the mouth. It is used internally for supportive treatment of increased potency of various origins in disorders of balance in the area of vegetative nerve, stress, obesity, increased activity of the thyroid and in the transition period in women with inappropriate hormonal treatment. The medicine can be taken by adults, adolescents and children. The medication is a medical salvia tincture (1: 6.6). The excipients are 60% ethanol (alcohol), purified water. Manufacturer: Saneca Pharmaceuticals a.s., Hlohovec, Slovakia. (Florsalmin®, 2010).

A study by Amaral *et al.* (2013) demonstrated that, according to the literature, ethanol extract of medicinal rosemary from other high concentrations of carnosic acid and rosmarinic acid, which are recognized as natural antioxidants, reinforces the importance of ethanol plant extracts as strong antioxidant compounds (Amaral *et al.*, 2013). Therefore, we have decided to prepare ethanol extracts of selected plant species. For the preparation of ethanol extracts we used 25 grams dried and fresh plants.

The plants were extracted into 50 ml of 96% ethanol. The solutions were kept in a cool and dark place for 24 hours. The extracts were collected by filtration and the obtained extracts were stored in cold and dark place for 12 hours.

#### Determination of antiradical activity by DPPH method

For determination of antiradical activity we used DPPH method (Brand a Williams, 1995; Sachéz-Moreno *et al.* 1998). The DPPH solution was prepared daily from the DPPH radical in 96% ethanol. We used 0.006 g of DPPH radical and 250 ml of 96% ethanol. The solution was mixed by ultrasonic stirrer and stored in a cold and dark place.

For determination of antioxidant activity of analyzed samples we used the mixture of DPPH solution (in volume 5 ml) and analyzed extract or tincture Florsalmin® (in volume 10 ul). The reaction between active substances of extract and DPPH solution ran for 35 minutes at room temperature in the dark. For each analysed extract we used four measurement. Antioxidant activity was measured spectrophotometrically by spectrophotometer UV-1800 (Schimadzu, Japan). The kinetic reaction was manifested by decoloration of solution and as a decrease in measured absorbance at  $\lambda = 517$  nm. This reaction was observed at time intervals - in 5

minute at 8 times. Activity of antioxidants in the analyzed extracts was presented by inhibition of DPPH radical. Formula for inhibition of DPPH radical is presented as:

$$\text{Percentage (\%)} \text{ of inhibition DPPH radical} = [(A_{C0} - A_{AT}) / A_{C0}] * 100$$

Percentage (%) of inhibition DPPH radical represents the ability of the monitored extract to remove DPPH at a certain time,  $A_{C0}$  is the absorbance value of DPPH solution at time  $t = 0$  minutes and  $A_{AT}$  presents the sample absorbance value in the presence of antioxidant at time  $t = 0$  minutes to  $t = 35$  minutes (Habanová *et al.*, 2008). The results were statistically evaluated.

## Results and discussion

The antioxidant activity was determined in the extracts of *Salvia officinalis* L., *Rosmarinus officinalis* L. and in tincture Florsalmin®. Plants were selected on the base of their basic properties - they contain rosinic acid and carnosic acid, which are strong antioxidants compound. Recent studies have shown that *Salvia officinalis* L. and *Rosmarinus officinalis* L. have similar properties and composition of phenolic compounds and their antioxidant activity were especially attributed to rosinic acid and carnosic acid (Erkan *et al.*, 2008).

For preparation of ethanol extracts was used 96.3 % ethanol. This concentration of ethanol increase the leaching of polyphenols - anthocyanins in the extracts (Li *et al.*, 2007; Angela *et al.* 2008).

In all analysed samples and tincture Florsalmin® was detected a decrease in absorbance. A more pronounced decrease in absorbance was measured in the first half of the measurement (at 0 minutes, 5 minutes, 10 minutes). In the second half of the measurement, the decrease in absorbance significantly slowed, respectively, stagnated at one absorbance value. That indicated finished reaction of active substance and DPPH radical. From obtained values of absorbance was calculated percentage of inhibition of DPPH radical by active substance in extracts and tincture.

The highest antiradical activity was shown by the Florsalmin® tincture sample. The percentage of inhibition at the beginning of the measurement at  $t = 0$  minutes was 63.07 % and at the end of the measurement at  $t = 35$  minutes showed percentage of inhibition 85.55 %. This indicates a good ability to free radicals uptake. The lowest antioxidant activity determined by DPPH method showed a sample of dried *Salvia officinalis* L.. The percentage of inhibition of DPPH radical in the start of the measurement was 30.17% at time  $t = 0$  min, and in the end of measurement, at the time  $t = 35$  minutes was the value of percentage of inhibition 42.05%. The extract from fresh *Salvia officinalis* L. showed the ability to uptake DPPH radical at  $t = 0$  minutes 32.28% and at time  $t = 35$  minutes 44.16%. In compare of antioxidant properties of extracts showed the extract from fresh *Salvia officinalis* L. the highest antioxidant ability. Similar results were found in extracts from fresh ( $t = 0$  minutes,  $I = 48,13$  %;  $t = 35$  minutes,  $I = 67,46$  %) and dried ( $t = 0$  minutes,  $I = 35,66$  %;  $t = 35$  minutes,  $I = 51,61$  % ) *Rosmarinus officinalis* L..

A different methodology was used to measure antioxidant properties of *Salvia officinalis* L. in study Roman, Neagu and Radu (2009). They measured the antioxidant properties of the methanol extract of *Salvia officinalis* L. The measurement run at a wavelength of 516 nm. Percentage of inhibition was higher than in our case - 85% (Roman *et al.*, 2009). According to the study by Kaledaite *et al.* (2011), *Salvia officinalis* L. had a low DPPH inhibition values and it contained fewer phenolic compounds (Kaledaite *et al.* 2011). Tepe *et al.* (2007) found that the antiradical effect of *Salvia officinalis* L. does not depend on the number of phenolic

compounds but on the position of *ortho*- and *para*- hydroxyl groups, which increases the polarity of the compound and increases its ability to capture free radicals (Tepe *et al.*, 2007).

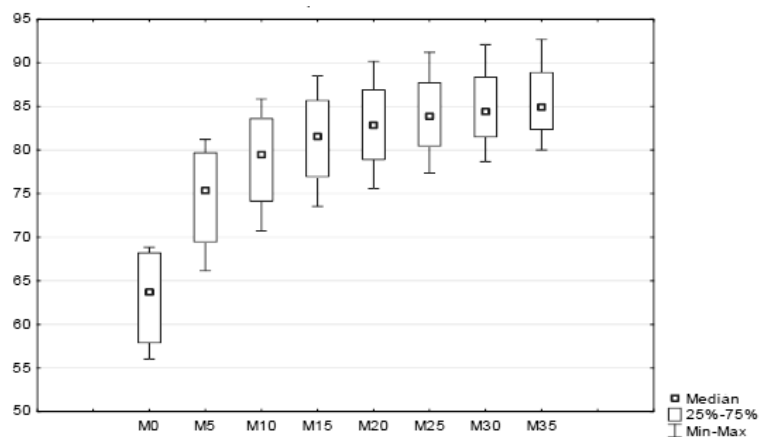
According to Papageorgiou *et al.* (2008) has *Rosmarinus officinalis* L. a more potent antioxidant activity and higher antiradical activity during February as during May, so the ability to free radicals also affects the vegetation state and harvest time (Papageorgiou *et al.*, 2008). Luis and Johnson (2005) studied antioxidant properties of *Rosmarinus officinalis* L. and they claimed, that the extracts of leaves are dependent on the concentration of rosmarinic acid and carnosic acid as well as the presence of other important constituents such as carnosol. The content of substances also affects the ecological growth conditions that affect the antioxidant potential of *Rosmarinus officinalis* L. (Luis *et al.*, 2005).

The STATISTICA program was used to statistical process the results obtained. Friedman's analysis of variance revealed by significant differences. From the resulting values we found that Florsalmin® tincture has the highest increments among other extracts depending on time. The highest differences was detected at time  $t = 5 - 0$  min, where Florsalmin® tincture had the highest increase (11,51). The increment in extracts of fresh *Rosmarinus officinalis* L. are significant at  $t = 5 - 0$  min (6,41). The least significant is the average increment for dried *Rosmarinus officinalis* L. over a period of 5-0 min..

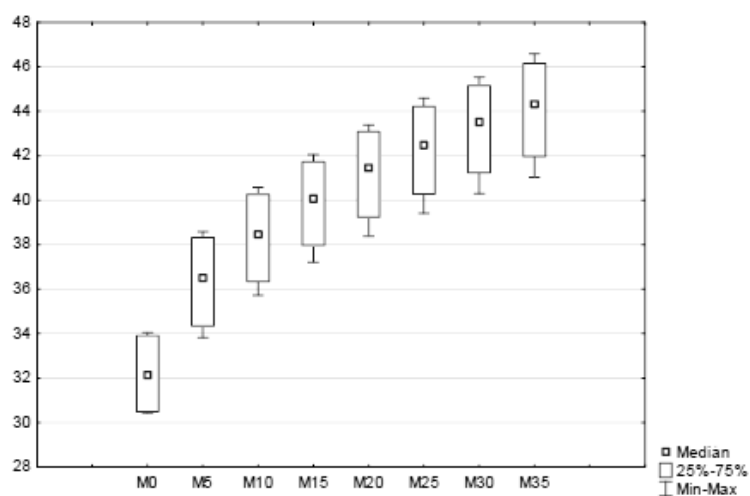
The difference between increments at time  $t = 5 - 0$  min in fresh *Salvia officinalis* L. (4,13) and dried *Salvia officinalis* L. (3,93) are not significant. Extract from dried *Rosmarinus officinalis* L. showed the smallest differences. From 15 minutes, the differences between the samples were insignificant.

To test the significance in differences in the mean of the observed extracts, we used a variance analysis – ANOVA. Based on Kendall's conformity factor, the median represented a mean value. We were interested in the value  $p = 0.00022$ , which showed that the results of the measurements varied, depending on the time, by increasing the values. The graphs show that there are bigger differences in the diameters between the samples and Florsalmin® tincture, fresh and dried sage, fresh and dried rosemary. Interestingly, Florsalmin® tincture sample and the rosemary dried sample showed a decrease in data variability, although the other variability of data increased.

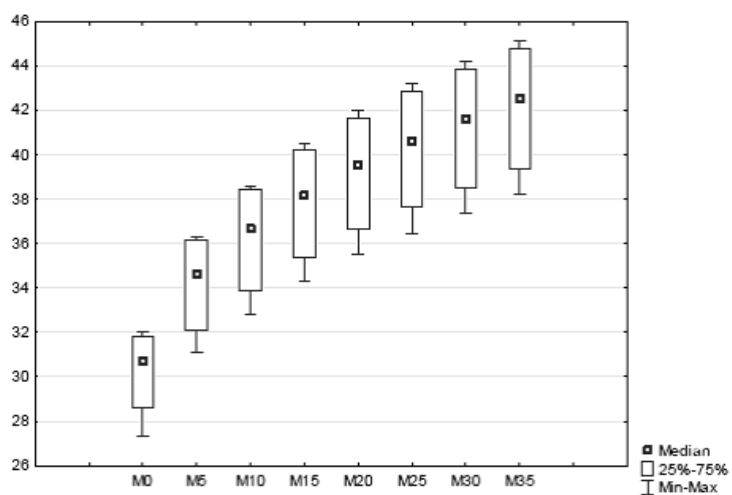
To statistically assess the significance of differences in the antiradical capability of selected samples, we used the Kruskal-Wallis test. The significant differences were confirmed in each measured time (0-35 min) between Florsalmin® tincture and fresh *Salvia officinalis* L. (in all cases at the level of 0.05) and between Florsalmin® tincture and dried *Salvia officinalis* L. (at level 0.01). Based on the Kruskal-Wallis test, multiple values of  $p$  values were statistically significant for Florsalmin® tincture, fresh and dried *Salvia officinalis* L. at time  $t = 0$  minutes. On the based of the comparison of the values, the association between tincture and fresh *Salvia officinalis* L. was found (0,041236) and dried *Salvia officinalis* L. (0.008180). At time  $t = 5$  min, associations between Florsalmin® and *Salvia officinalis* L. were found in extracts of fresh *Salvia officinalis* L. (0,041236) and dried *Salvia officinalis* L. (0,008180). At time  $t = 10$  minutes and 15 minutes, there was also a statistically significant relationship found between tincture and extracts from *Salvia officinalis* L. fresh (0.041236) and *Salvia officinalis* L. dried (0.008180). The relationship between Florsalmin® and extracts from fresh *Salvia officinalis* L. (0.018862) and dried *Salvia officinalis* L. (0.003362) at  $t = 20-35$  min was also statistically significant.



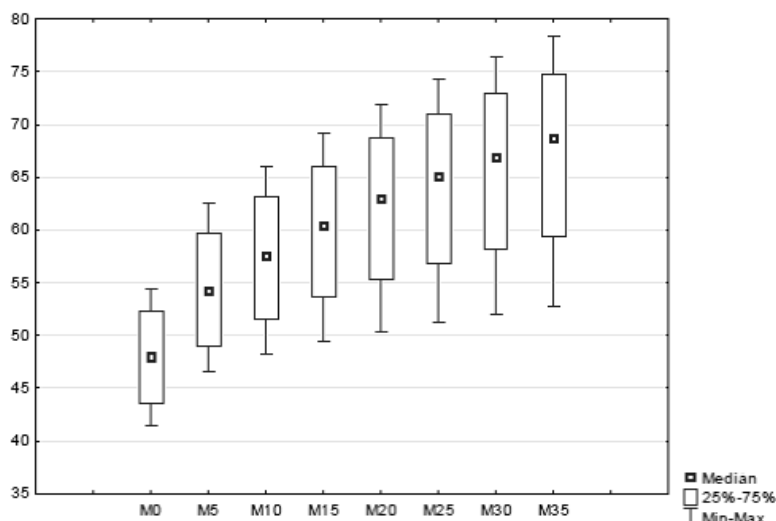
Graph 1: Florsalmin®



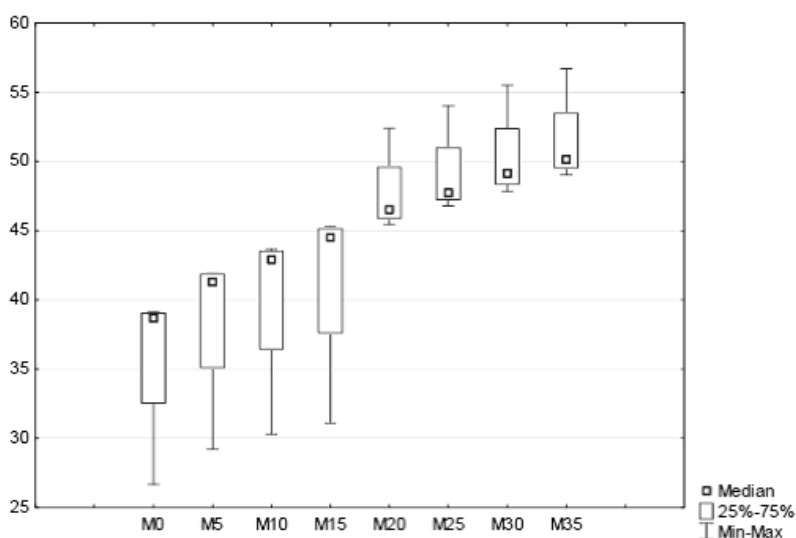
Graph 2: Extracts of fresh *Salvia officinalis* L.



Graph 3: Extracts of dried *Salvia officinalis* L.



Graph 4: Extracts of fresh *Rosmarinus officinalis* L.



Graph 5: Extracts of dried *Rosmarinus officinalis* L.

### Conclusion

The statistically significant difference is between Florsalmin® and extract from dried and fresh *Salvia officinalis* L., similarly statistically significant difference was also determined by ANOVA in a study by Nickavar, Kamalinejad and Izadpanah (2007). *Rosmarinus officinalis* L. did not have a significant relationship with Florsalmin® or *Salvia officinalis* L. on the basis of a comparison of  $p$  values.

### Acknowledgement

This work is the result of the Project implementation: University Science Park TECHNICOM for Innovation Applications Supported by Knowledge Technology - II. phase, ITMS: 313011D232, supported by the Research and Innovation Operational Programme funded by the ERDF.



## References

- Angela, M., Meireles, A., (2008). Extracting Bioactive Compounds for Food Products: Theory and Applications. London: CRC Press. ISBN 978-1-4200-6239-7.
- Özcan, M.M., Özkan, G., (2015). Determination of antioxidant activity and total phenol contents of two *Salvia* extracts. *Indian Journal of Traditional Knowledge*. Vol. 14, 226-230.
- Obulesu, M., Rao, D.M., (2011). Effect of plant extracts on Alzheimer's disease: An insight into therapeutic avenues. *J Neurosci Rural Pract.*, Vol. 2, 56–61.
- Abuashwashi, M.A., Palomino, O.M., Serranillos, M.P.G., (2016). Preliminary Studies on the Protective Effect of *Rosmarinus Officinalis* on Astrocytes, *Journal of Pharmacology & Clinical Research*, Vol. 1 Issue 2 - March 2016.
- Florsalmin, (2010). Pisomná informácia pre používateľa. Výrobca: Saneca Pharmaceuticals a.s., Nitrianska 100, 92027 Hlohovec.
- Brand-Williams, W., Cuvelier, M. E., Berset, C., (1995). Use of free radical method to evaluate antioxidant activity, *Lebensmittel-Wissenschaft und Technologie/Food science and Technology*. Vol. 28, 25-30.
- Sanchez-Moreno, C., Larrauri, J.A., Saura-Calixto, F., (1998). A procedure to measure the antiradical efficiency of polyphenols, *Journal of the Science of Food and Agriculture*, Vol. 76, 270-276.
- Roman, G. P., Neagu, E. A, Radu, G. L., (2009). Antiradical activities of *Salvia officinalis* and *Viscum album* L. extracts concentrated by ultrafiltration process. In: *Acta Scientiarum Polonorum, Technologia Alimentaria*. Vol. 8, 47-58.
- Habánová, M., Habán, M., (2008). Hodnotenie antiradikálovej aktivity vybraných rastlinných zdrojov, *Acta fytotechnica et zootechnica*. Vol. 1, 21-24.
- Erkan, N., Ayranci, G., Ayranci, E., (2008). Antioxidant activities of rosemary (*Rosmarinus officinalis* L.) extract, blackseed (*Nigella sativa* L.) essential oil, carnosic acid, rosmarinic acid and sesamol, *Food chemistry*. Vol. 110, 76-82.
- Li, W., Pickard, D.M., Beta, T., (2007). Effect of thermal processing on antioxidant properties of purple wheat bran. *Food Chemistry*, Vol. 104, 1080-1086.
- Kaledaite, R. et al., (2011). Investigation of antiradical activity of *Salvia officinalis* L., *Urtica dioica* L., and *Thymus vulgaris* L. extracts as potential candidates for a complex therapeutic preparation, *Journal of Medicinal Plants Research*. Vol. 5, 6090-6096.
- Tepe, B. et al., (2007). Antioxidant potentials and rosmarinic acid levels of the methanolic extracts of *Salvia verticillata* (L.) subsp. *verticillata* and *S. verticillata* (L.) subsp. *Amasiaca* (Freyn and Bornm.) Bornm, *Food Chemistry*. Vol. 100, 985-989.
- Papageorgiou, V. et al., (2008). Variation of the chemical profile and antioxidant behavior of *Rosmarinus officinalis* L. and *Salvia fucicosa* Miller Grown in Greece, *Journal of Agricultural and Food Chemistry*. Vol. 56, 7254-7264.
- Luis, J. C., Johnson, C. B., (2005). Seasonal variations of rosmarinic and carnosic acids in rosemary extracts. Analysis of their in vitro antiradical activity, *Spanish Journal of Agricultural Research*. Vol. 3, 106-112.
- Nickavar, B., Kamalinejad, M., Izadpanah, H., (2007). In vitro free radical scavenging activity of five *Salvia* species, *Pakistan Journal of Pharmaceutical Sciences*. Vol. 20, 291-294.

## GRAIN AND PROTEIN YIELD OF SELECTED GRAIN LEGUMES IN SUB-ALPINE AND PANNONIAN GROWING CONDITIONS

Aleš KOLMANIČ

Crop Science Department, Agricultural Institute of Slovenia, Ljubljana, Slovenia

\*Corresponding author: ales.kolmanic@kis.si

### Abstract

The present article discusses the productivity of selected grain legumes in integrated production systems in sub-alpine (Jablje) and pannonian (Rakičan) growing conditions in Slovenia. With the decline in legume cultivation Slovenia is a net importer of grain legumes. Furthermore, almost all soybean is imported and approximately 97% of imported soybean is GM. To support the introduction of soybean and reintroduction of selected grain legumes, a three year state project was started in autumn 2014. Twenty-six cultivars of soybean, four cultivars of peas, two faba-beans, blue, yellow and white lupin were tested in two growing conditions in 2016 and yields and content of protein were evaluated. Results in Jablje show that the average grain yields of soybean, faba-beans, peas, white, blue and yellow lupins were 4761, 3724, 3675, 3658, 2188 and 644 kg/ha, respectively. Average protein yields per hectare were 1718, 975, 579, 1277, 632 and 252 kg/ha, respectively. At Rakičan, unfavorable conditions with late spring frost, drought and high temperatures interrupted development of lupins. Therefore only soybeans, faba-beans and peas could be evaluated. Nevertheless, drought conditions during summer also significantly affected soybean development, reducing yields and crude protein content. Average grain yields of soybean, peas and faba-beans were 3223, 4295 and 2291 kg/ha, respectively. Average protein yields per hectare were 895, 799 and 588 kg/ha, respectively. Results show that soybean had higher average yields of grain compared to other legumes at Jablje while yields of peas were competitive at Rakičan. Nevertheless, overall high crude protein content of soybean resulted in highest protein yield per hectare at both locations.

**Keywords:** *Soybean, pea, faba-bean, lupin, grain yields, protein yields*

### Introduction

General trends in agriculture towards simplification and specialization are partly responsible for a significant decline in legume cultivation and plant diversity at the farm level in Europe (Brouwer, 2006). However, the resulting high deficiency of high quality plant proteins for animal feeding in Europe is the main driver of high grain legume imports, especially imports of soybeans from North and South America (Nemecek et al., 2008). Soybean is globally the most important legume in agriculture and one of the four most important crops worldwide in providing food security (Ray et al., 2013). Slovenia is a net importer of grain legumes with close to 70% of legumes imported. The share of imported soybean is even higher and the fact that 97.5% of the imported soybean is genetically modified creates additional important negative public opinion. To decrease the production deficit of plant proteins and dependence on the import of plant protein the general consensus in the EU was to promote the cultivation of protein crops (Bues et al., 2013). As a result, the CAP 2014-2020 is supporting grain legumes with a number of measures. Legumes are an important part of agriculture, providing many environmental benefits and ecosystem services (Zander et al., 2016). Intensive

production systems in Slovenia rely mainly on high external nitrogen inputs to achieve high production levels. The negative side of such systems is the range of environmental issues, as discussed by Van Grinsven et al. (2014) and Bavec et al. (2015). An important benefit of legumes is also the possible reduction of mineral nitrogen fertilizer applications, as most of the legumes have the ability to develop root nodules and fix N<sub>2</sub> with compatible rhizobia in symbiosis (Bues et al., 2013; Graham and Vance, 2003). Soybean cultivation in Central Europe is relatively new as breeding of early-maturing varieties suited to growing conditions in central Europe started a few years ago (Zimmer et al., 2016). In Slovenia only a small percentage of fields was cultivated with soybean until 2015 (STAT, 2017). However, the introduction of early varieties and financial stimulation in the CAP 2014-2020 (ca. 2,759,740 EUR in 2015 or ca. 330 EUR/ha in Slovenia) resulted in a rapid increase of legume cultivation in 2015 and 2016, especially the cultivation of soybean. Soybean cultivation increased from 404 ha in 2014 to 1705 and 2466 ha in 2015 and 2016, respectively. Cultivation of peas also increased from 221 ha in 2014 to 447 and 611 ha in 2015 and 2016, respectively. The Slovenian Ministry for Agriculture, Food and Forestry started a three-year state research project named "Soybean" in the late summer of 2014. Two faculties and two research institutes have participated in the project with the main goal to increase the cultivation of grain legumes in Slovenia. As the name suggests, soybean is the main focus of the project. Nevertheless, the potential of pea, faba-bean and lupin production in different pedo-climate conditions are also studied.

The aim of this paper is to present an overview of grain and the protein production potential of different varieties of soybean (*Glycine max* L. Merrill), peas (*Pisum sativum* L.), faba-beans (*Vicia faba* L.), blue lupin (*Lupinus angustifolius* L.), yellow lupin (*Lupinus luteus* L.) and white lupin (*Lupinus albus* L.) in two climates (semi-arid pannonian and sub-alpine) and soil conditions (sandy and clay soils) observed in 2016.

### Materials and Methods

Experimental fields are located at Jablje, (central Slovenia, 46°8'N, 14°33'E, altitude 307 m, pH 5.9) and Rakičan (east Slovenia, 46°39'N, 16°11'E, altitude 186 mm, pH 6.4). The Jablje climate is categorized as sub-Alpine (cool and wet growing conditions, average yearly precipitation 1367 mm, average yearly temperature 8.96 °C) and the Rakičan climate is categorized as Pannonian (semi-arid conditions, average yearly precipitation 812 mm, average yearly temperatures 9.77 °C). Soil texture at Jablje is a clay loam, characterized with slow infiltration and good water retention capacity. At Rakičan a brown loamy sand soil is characterized with high infiltration and low retention capacity. Twentysix varieties of soybean, four varieties of pea, two varieties of faba-bean and one variety of blue, yellow and white lupin were included in the experiment in 2016. The experiment was arranged as a completely randomized block design with four replications. Each experimental plot was 6x2.5 m<sup>2</sup>. At both locations soils were prepared for sowing with the use of minimum tillage. Seeding density was 50-120 plants per m<sup>2</sup> (depending on grain legume, maturity and the germination percentage) and row spacing was 25 cm. Seeds were sown using a Wintersteiger experimental seeder for small grain cereals. Prior to seeding, all soybeans seeds were inoculated with *Bradyrhizobium japonicum*. However, as limited nodulation was observed, 60 kg of N was added with mineral nitrogen fertilisers during growth. P<sub>2</sub>O<sub>5</sub> and K<sub>2</sub>O were applied according to the results of AL analysis. Blocks were sprayed with post-emergence herbicides to prevent weed development. Crops were harvested with a Wintersteiger plot harvester when most of the varieties achieved full maturity. Grain was then weighed and samples were prepared for further analysis. Grain moisture was measured immediately after harvest and if necessary samples were dried to 9% moisture at 40°C. Moisture was

determined by heating the samples at 103°C for 4 h (EC 152/2009 App. III A). Dried samples from all the repetitions were then taken and combined to estimate average of crude protein content of the variety. Crude proteins were analysed using the method ISO 5983, with a conversion factor of 6.25. Protein yields were calculated by multiplying the crude protein content on dry matter (DM) basis with the yields of dry matter per hectare.

### Results and Discussion

**Jablje:** Weather conditions in 2016 were not optimal for soybean cultivation. Monthly precipitation was close to average for most of the growing period (Table 1). Sowing and early development was affected with intense rain resulting in water-saturated fields. Average monthly temperatures were above the long-term average (1981-2010) with peak temperatures (+33 °C) occurring during soybean flowering and pod formation. During harvest, intense rain delayed harvest and increased grain moisture contents. Solar radiation in 2016 was slightly above average.

Table 1: Basic weather parameters at Jablje

	months	I	II	III	IV	V	VI	VII	VIII	IX	X
Average temperatures in 2016		-1	3.6	5.5	10.4	13.9	18.5	21.3	18.9	16.4	8.7
Long term average temperatures		-1.7	-0.2	4.1	8.8	14.1	17.4	19.4	18.7	14.2	9.6
Average precipitation in 2016		67.5	191.3	90.2	100.2	113.8	147.8	90.7	114.9	43.3	137.4
Long-term average precipitation		66	65	90	95	107	145	122	135	140	137

Long-term=1981-2010

Relatively favourable growing conditions resulted in very high yields of grain legumes (Figure 1). Average grain yields of soybean (9% moisture) varied from 3778 kg/ha to 5387 kg/ha. Average yields of peas varied from 3424 kg/ha to 4009 kg/ha. Average yields of faba-bean varied from 3302 kg/ha to 4145 kg/ha. Average grain yields of lupins were 643 kg/ha, 2188 kg/ha and 3658 kg/ha for yellow, blue and white lupin, respectively. Overall, the highest grain-yielding variety of soybean was ‘Silvia PZO’ (5387 kg/ha, 21.5% grain moisture at harvest), maturity group 0/00. The second highest-yielding variety was ‘PR91M10’ (5381 kg/ha, 21.9% grain moisture), maturity group 0. Ten varieties of soybean achieved average yields of above 5000 kg/ha with no significant differences observed among them (data not shown). The highest-yielding variety of pea was ‘Astronavte’, yielding 4009 kg/ha at 15.2% moisture. The highest-yielding variety of faba-bean was Slovenian variety ‘Zoran’, yielding 4145 kg/ha at 13.6% moisture.

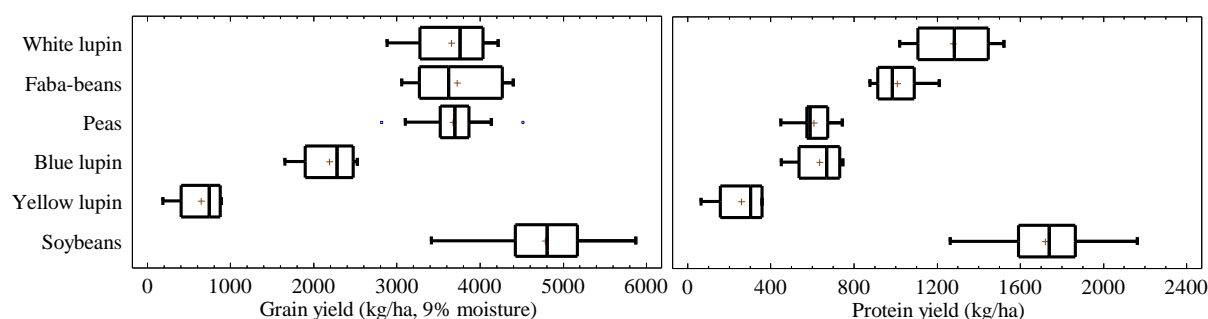


Figure 1: Comparison of average yields of different legumes at Jablje in 2016

Some variability was observed with grain yields. High volatility of grain yields of legumes has been much discussed and yield instability is a major obstacle in increasing legume cultivation. Nevertheless, agronomic measurements to improve yield stability are limited

(Zander et al., 2016). Crude protein content of soybean ranged from 362 g/kg DM, the lowest, to 430 g/kg DM, the highest. The content was higher compared with peas (167-186 g/kg DM), faba-bean (282-294 g/kg DM) and blue lupin (299-326 g/kg DM). Protein content of white lupine (358-396 g/kg DM) was comparable to soybean and protein content of yellow lupine (386-449 g/kg DM) was higher. Protein yields per hectare were highest with soybean and varied from 1349 kg/ha, the lowest, to 1945 kg/ha the highest. The difference between the soybean variety with the highest ('Shouna') and the lowest ('Smuglyanka') protein yield was 30%. Protein yields of pea, faba-bean, blue and yellow lupin were lower. Furthermore, yellow lupin and pea were overall the lowest protein-yielding legumes at Jablje (252-633 kg/ha. However, the protein yield of white lupin variety 'Energy' (1277 kg/ha was comparable to the lowest yielding varieties of soybean.

**Rakičan:** Conditions for legume growth and development in 2016 were not optimal for legumes (Table 2). A drought period in April and intense frost in late April severely affected lupins. Therefore no yield data for lupins were collected on this location. Average monthly temperatures were above the long-term average (1981-2010) with peak temperatures (+35°C) occurring during the soybean reproductive stage. Monthly precipitations were close to average from May to July. Low water-holding capacity of soils, below average precipitation and high temperatures occurred at the end of August and persisted almost to the end of September. This resulted in premature maturation of soybean. Solar radiation in 2016 was slightly above average.

Table 2: Basic weather parameters at Rakičan

	months	I	II	III	IV	V	VI	VII	VII	IX	X
Average temperatures in 2016		-0.2	5.9	6.9	12.2	15.6	19.8	22.0	19.5	17.4	9.6
Long term average temperatures		-0.8	0.9	5.3	10.2	15.4	18.6	20.4	19.6	15.1	10.3
Average precipitation in 2016		34.6	108.9	37.9	37.0	123.4	110.3	81.9	53.1	27.9	78.3
Long-term average precipitation		37	36	58	61	86	114	98	111	106	88

Long-term=1981-2010

Average yields of soybeans varied from 2760 kg/ha to 3835 kg/ha (Figure 2). The highest yield was achieved with variety 'Giuliette' (3835 kg/ha), maturity group 1. Nevertheless, this variety was too late maturing, having 43.2% grain moisture at harvest. The second highest yielding soybean variety was 'ES Mentor' (3659 kg/ha, 15.9% moisture), maturity group 00. Eight varieties with grain yield above 3340 kg/ha showed no statistical differences among them (data not shown). Average yields of peas varied from 4248 kg/ha to 4343 kg/ha. No significant differences were observed amongst the varieties. Average yields of faba-beans varied from 2108 kg/ha to 2474 kg/ha. Yields of variety 'Merkur' were significantly higher. Average grain yields (9% moisture) of soybean at Rakičan were lower compared to Jablje, indicating more unfavourable growing conditions. Faba-bean also showed low adaptability to conditions at Rakičan, with a high infection rate with *Botrytis fabae* and very low competitiveness with weeds. On the contrary, yields of peas were higher compared to soybeans at Rakičan. The highest average yielding legumes were peas (4294 kg/ha), followed by soybeans (3223 kg/ha) and faba-beans (2291 kg/ha). Crude protein content of soybeans ranged from 257 g/kg DM to 343 g/kg DM. Protein content was higher compared to peas, 189-198 g/kg DM, and faba-beans, 279-284 g/kg DM. The highest calculated protein yield was observed with variety "ES Mentor" (1142 kg/ha). Lowest calculated protein yield was observed with the variety "Sanda" (770 kg/ha). Difference between the highest and the lowest protein yield was ca 60.3%. Protein yields of peas varied from 779 kg/ha to 814 kg/ha.

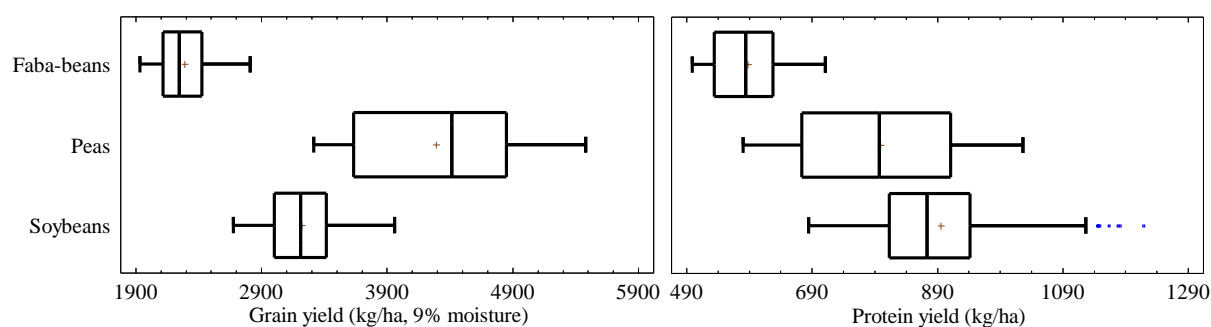


Figure 2: Comparison of average yields of different legumes at Rakičan in 2016

Water deficit can result in smaller plants and more pods per plant, correlating with less biomass and lower 1000-seed weight (Dogan et al., 2007). Drought also affects protein and fat content in the grains. Therefore, cultivation of soybean in semi-arid growth conditions could be risky. Peas are in theory more appropriate for semi-arid conditions. However, at both locations the varieties of peas showed high tendencies to lodge and some varieties were showing a tendency for grain loss. Lodging is a serious problem in dry pea cultivation, significantly affecting yields (Singh and Srivastava, 2015) and consequently reducing its competitiveness with soybean in semi-arid conditions. Nevertheless, various agronomical managements can be implemented to minimize this tendency (Schouls and Langelaan, 1994). Faba-beans, blue and yellow lupin varieties used in the experiment were shown not to be competitive with soybean and peas. Reasons for this can be partially found in a high rate of infection with fungal diseases, poor competition with weeds and considerable late spring frost damage.

### Conclusions

Results of trials showed that soybean had higher average yields of grain compared to other legumes at Jablje (sub-alpine climate) while average yields of peas were higher at Rakičan (pannonian climate). Nevertheless, with its high crude protein content, soybean gave the highest protein yield per hectare at both locations. With the exception of white lupin at Jablje, yields of lupins and faba-beans were not competitive. Optimal soybean maturity groups for Slovenia were 00-000, though maturity group 0 could also be recommended for sowing. Intensive production systems in Slovenia rely mainly on high external nitrogen inputs to achieve high production levels. Increase of the share of soybean in cropping systems could have multiple environmental benefits, not only on reducing imports of plant proteins but also on reducing nitrogen inputs. However, symbiotic fixation was questionable with only a few nodules per plant observed in the 2016 trials. Therefore the expected reduction of nitrogen inputs with an increasing share of soybean cultivation could also be questionable and needs further evaluation.

### Acknowledgements

This research was financially supported by grants from the Ministry of Agriculture, Food and Forestry of Slovenia and the Slovenian Research Agency in Target research programs 2014, entitled "Soybean" (V4-1407) and the program entitled "Agrobiodiversity" (P4-0072), financially supported by a grant from the Slovenian Research Agency, Ljubljana, Slovenia.

### References

Bavec F., Bavec S., Grobelnik Mlakar S., Jakop M., Robačar M., Rozman Č., Bavec M. (2015). Needs for production of grain protein crops in Europe and possibilities for more

- bio-based green economy including nitrogen use. Proceedings of the 16th International Conference Rural-Urban Symbiosis Ramiran: 497-501.
- Brouwer F. (2006). Main trends in agriculture. In: Zander, P., Amjath-Babu, T.S., Preissel, S., Reckling, M., Bues, A., Schläfke, N., Kuhlman, T., Bachinger, J., Uthes, S., Stoddard, F., Murphy-Bokern, D., Watson, C. (2016). Grain legume decline and potential recovery in European agriculture: a review. *Agronomy for Sustainable Development*, 36: 26.
- Bues A., Preissel S., Reckling M., Zander P., Kuhlmann T., Topp K., Watson C., Lindstrom K., Stoddard F.L., Murphy-Bokem D. (2013). The environmental role of protein crops in the new common agricultural policy. Agriculture and rural development, European Parliament, Brussels.
- Dogan E., Kirnak H., Copur O. (2007). Deficit irrigations during soybean reproductive stages and CROPGRO-soybean simulations under semi-arid climatic conditions. *Field Crops Research*, 103(2): 154-159.
- Graham P.H., Vance C.P. (2003). Legumes: Importance and constraints to greater use. *Plant Physiology*, 131 (3): 872-877.
- Nemecek T, von Richthofen J.S, Dubois G, Casta P, Charles R, Pahl H. (2008). Environmental impacts of introducing grain legumes into European crop rotations. *European Journal of Agronomy*, 28: 380-393.
- Ray D.K., Mueller N.D., West P.C., Foley J.A. (2013). Yield trends are insufficient to double global crop production by 2050. *PLoS ONE*, 8(6), e66428.
- Schouls J., Langelan J.G. (1994). Lodging and yield of dry peas (*Pisum sativum* L.) as influenced by various mixing ratios of a conventional and a semi-leafless cultivar. *Journal of Agronomy and Crop*, 172, 3: 207-214.
- Sekulić P., Kurjački I. (2011). Soybean response to environmental factors. In: Miladinović J., Hrustić M., Vidić M. Soybean. Institute of Field and Vegetable Crops, Novi Sad: pp. 203-226.
- Sing A.K., Srivastava C.P. (2015). Effect of plant types on grain yield and lodging resistance in pea (*Pisum sativum* L.). *Indian Journal of Genetics and Plant Breeding*, 75, 1: 69-74.
- STAT-Statistical office of Republic of Slovenia. (2016). Crop production in Slovenia in 2016. <http://www.stat.si/StatWeb/en/show-news?id=5852&idp=11&headerbar=0> (accessed: 10.7.2017).
- Van Grinsven H.J.M., Spiertz J.H.J., Westhoek H.J., Bouwman A.F., Erisman J.W. (2014). Nitrogen use and food production in European regions from a global perspective. Nitrogen workshop special issue paper *Journal of Agriculture Science*, 152: 9-19.
- Zander P., Amjath-Babu T.S., Preissel S., Reckling M., Bues A., Schläfke N., Kuhlman T., Bachinger J., Uthes S., Stoddard F., Murphy-Bokern D., Watson C. (2016). Grain legume decline and potential recovery in European agriculture: a review. *Agronomy for Sustainable Development*, 36: 26.
- Zimmer S., Messmer M., Haase T., Piepho H.P., Mindermann A., Schulz H., Habekuss A., Ordon F., Wilbois K.P. Hess J. (2016). Effects of soybean variety and Bradyrhizobium strains on yields, protein content and biological nitrogen fixation under cool growing conditions in Germany. *European Journal of Agronomy*, 72: 38-46.

## EFFECT OF OPTIMIZED REGULATED DEFICIT IRRIGATION ON THE PROFITABILITY OF PURPLE GARLIC IN A SEMIARID REGION OF SPAIN

Alfonso DOMÍNGUEZ\*, Bruno C. LÉLLIS, José J. PARDO, José M. TARJUELO, Ángel MARTÍNEZ-ROMERO

University of Castilla-La Mancha (www.uclm.es), Technical School of Agricultural and Forestry Engineers, Regional Centre of Water Research (<http://crea.uclm.es>), Albacete, Spain

\*Corresponding author: [alfonso.dominguez@uclm.es](mailto:alfonso.dominguez@uclm.es)

### Abstract

In the semiarid areas of Spain the main limitation factor for agriculture is the availability of irrigation water. MOPECO (model for the economic optimization of the irrigation water) aims to maximize the profitability of irrigated farms through a more efficient use of available irrigation water and cultivable area. For reaching this objective, the model combines the “optimized regulated deficit irrigation” (ORDI) methodology with the typical meteorological year. A two years experiment (2015 and 2016) was conducted in Albacete in order to determine the effect of ORDI on the yield, quality and profitability of the purple garlic cultivar “Morado de Las Pedroñeras”. The crop received five irrigation doses: Non deficit (control), 100% of typical irrigation requirements (IR) of the crop in the area, 90% IR, 80% IR, and 70% IR. As expected, yield increased with the volume of irrigation water supplied to the crop (from 8256 to 10055 kg ha<sup>-1</sup> of 70% IR and Non deficit treatments, respectively). Nevertheless, the water productivity in economic terms was higher for the ORDI treatments (from 3.34 to 5.53 € m<sup>-3</sup> of Non deficit and 70% IR treatments, respectively). In consequence, for a similar volume of available irrigation water, producers can increase the profitability of their farms by cropping a higher area (that cannot be irrigated due to the lack of water) applying a volume of water per hectare (managed by using the ORDI methodology) lower than the irrigation requirements of the crop.

**Keywords:** *Water productivity, MOPECO, crop modelling, ORDI, typical meteorological year.*

### Introduction

Farms are businesses that intend to get profits through the production of food. This sector is highly conditioned by numerous economic (i.e. harvest price, labor costs...), political (i.e. customs duty, production subventions, laws for the protection of the environment...), social (i.e. food security, maintain rural population...), technical (i.e. machinery, crops...), and environmental (i.e. climate, soil, diseases...) factors.

In arid and semiarid areas, the lack of water resources for irrigation is a relevant determinant for agricultural production. Moreover, the progressive price increase of the energy required for supplying irrigation water to crops, as well as the low price of harvests in the international market (FAO, 2017), are conditioning the profitability of irrigated farms in these areas.

Garlic (*Allium sativum* L.) is one of the most disseminated crops in the world (around 1.5 Mha) (FAO, 2017). The 58% of the total cultivated area in Spain (21.000 ha) is located in Castilla-La Mancha (CLM) region (MAGRAMA, 2015). In this area it is cropped a high quality purple cultivar called “Ajo Morado de Las Pedroñeras”, which is affected by the competence of white cultivars (higher yields and lower cultivation costs).



More than the 95% of the garlic cultivated area in CLM is irrigated (MAGRAMA, 2016). However, the amount of water that farmers can use for irrigating is limited due to the scarcity of water resources in this region. This fact, in addition with the high cost of the energy required by the pressurized irrigation systems, has caused that farmers demand strategies to improve the efficiency of water use and make more profitable the cultivation of purple garlic (Fabeiro et al., 2003).

MOPECO model (Ortega et al., 2004) was conceived for optimizing the gross margin (GM) of irrigated farms, especially in arid or semiarid areas with water scarcity and/or high crop costs that may affect the profitability of agricultural activities. The model determines the area and the amount of water to be dedicated to each crop for maximizing the GM of a farm, depending on the availability of both irrigable land and volume of irrigation water (López-Mata et al., 2016). The volume of irrigation water is translated into full irrigation or into the level of deficit that must be reached at the end of the cropping period. Leite et al. (2015) developed a methodology for optimizing the allocation of a certain volume of irrigation water (lower than the typical irrigation requirements of the crop) during the cropping season for maximizing yield, which is based on the “optimized regulated deficit irrigation” (ORDI) (Domínguez et al., 2012) and the “typical meteorological year” (TMY) (Domínguez et al., 2013) methodologies.

The main aim of this work was to validate the methodology “ORDI for limited volumes of irrigation water” on a garlic crop, and to analyse the effect of this methodology on yield, diameter of bulbs, and farms profitability under the semiarid conditions of CLM.

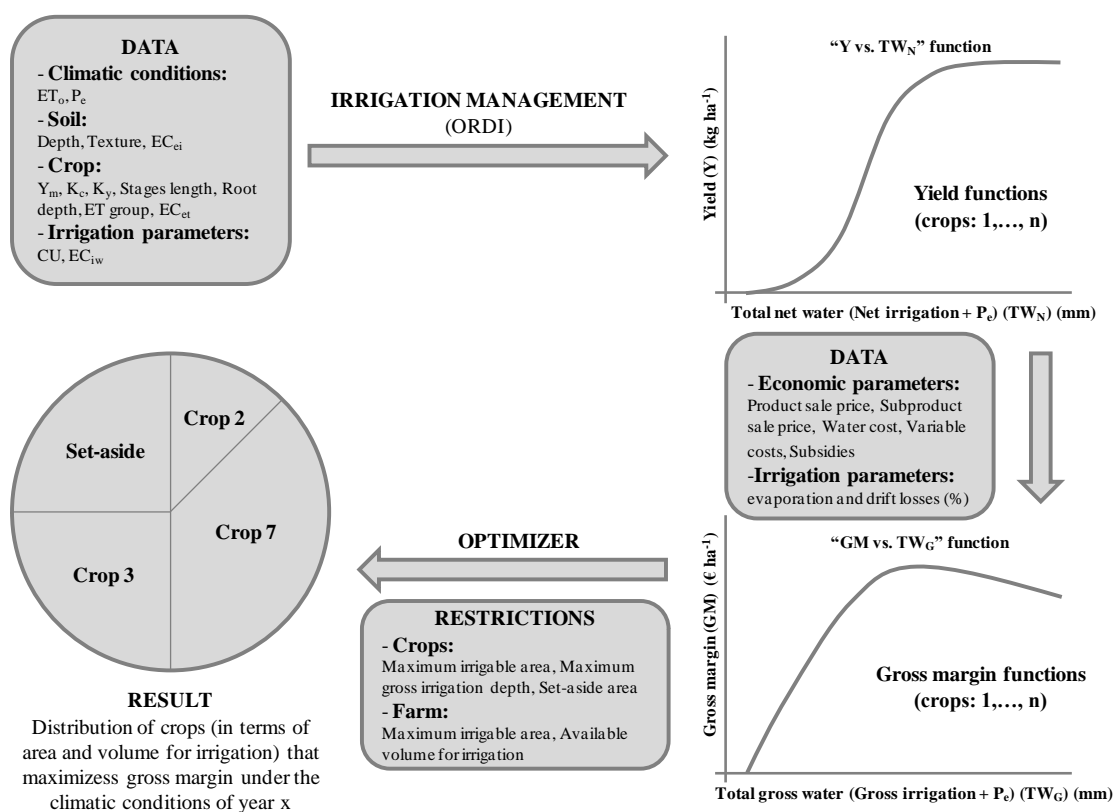
### **Material and Methods**

The two years field experiment was conducted during years 2015 and 2016 in Albacete (Spain). Bulbs were manually seeded with 0.08 m between plants and 0.50 m between lines. There were four experimental plots (2.5 x 18.0 m) per deficit treatment randomly distributed, while in the case of the T100 and SD treatments there were three. The irrigation system was drip irrigation (0.5 x 0.5 m between pipes and emitters) with self-compensating emitters (flow: 3,8 l h<sup>-1</sup>). In each treatment a precision flowmeter was installed for measuring the total amount of water received by the crop. Moreover, in each plot two tensiometers (at 20 and 40 cm depth) and one volumetric probe (four sensors at 10, 20, 30 and 40 cm depth) were installed. The climatic data were registered by a climatic weather station placed at the experimental farm. The soil of the experiment was classified as Xeric Torriorthent with a loam texture while the average soil depth was 40 cm. The electrical conductivity of the irrigation water is the usual in the area (0.8 dS m<sup>-1</sup>).

Five volumes of irrigation water were supplied to the crop: no deficit “SD”, and other four with different limited volumes of available irrigation water: 100% “T100”, 90% “T90”, 80% “T80”, and 70% “T70” of the net irrigation requirements for the climatic conditions of the typical meteorological year (TMY), which were calculated as 2750 m<sup>3</sup> ha<sup>-1</sup> = T100.

The aim of MOPECO is to maximize gross margin (GM) through the efficient use of irrigation water. A set of data is required for the simulation of the optimal “Yield vs. Total Net Water” (Y vs. TW<sub>N</sub>) function of each crop under the climatic conditions of a certain year. In this function, TW<sub>N</sub> = net irrigation (I<sub>N</sub>) + effective rainfall (P<sub>e</sub>). To obtain Y vs. TW<sub>N</sub>, the model simulates a range of deficit irrigation schedules using the optimized regulated deficit irrigation (ORDI) methodology, considering the effects of irrigation uniformity and electrical conductivity of water on yield. The Y vs. TW<sub>N</sub> function is translated into “Yield vs. Total Gross Water” (Y vs. TW<sub>G</sub>), where TW<sub>G</sub> = gross irrigation (I<sub>G</sub>) + P<sub>e</sub>, to include the application efficiency of the irrigation system. The GM vs. TW<sub>G</sub> function is then calculated using economic data of the crop. Finally, the model calculates the optimal distribution of crops that

fulfil the restrictions imposed by the user (crops, irrigable area, and available amount of water for irrigation) (Fig. 1).



$ET_0$ : daily reference evapotranspiration (mm);  $P_e$ : daily effective rainfall (mm);  $EC_{ei}$ : water conductivity of the saturated soil extract at the beginning of the irrigation season ( $dS\ m^{-1}$ );  $Y_m$ : potential yield of the crop in the area ( $kg\ ha^{-1}$ );  $K_c$ : crop coefficient (dimensionless) (Allen et al., 1998);  $K_y$ : crop yield response factor by growing stage (dimensionless) (Doorenbos and Kassam, 1979);  $EC_{et}$ : water conductivity of the saturated soil extract that decreases the evapotranspiration capacity of a crop ( $dS\ m^{-1}$ ); ET group: it conditions the daily value of the fraction of the total available water (TAW) that a crop can extract without suffering water stress (Danuso et al., 1995); CU: uniformity coefficient of the irrigation system;  $EC_{iw}$ : electrical conductivity of the irrigation water in the area ( $dS\ m^{-1}$ ).

Figure 1. Flowchart of MOPECO model.

From sowing to harvest, it was monitored the phenological progression of the crops by using the BBCH scale (Bleiholder et al., 2001). This monitoring allowed to determine the duration in growing-degree-days (GDD) ( $^{\circ}C$ ) of each phenological stage.

The "ORDI for limited volumes of irrigation water" methodology (Leite et al., 2015) determined the actual versus maximum evapotranspiration rate ( $ET_a/ET_m$ ) objective for each phenological stage of the crop depending on the availability of irrigation water and the forecasted climatic conditions according to the TMY. A TMY (Hall et al., 1978) represents the conditions considered "typical" over a long time period and it was adapted by Domínguez et al. (2013) for forecasting irrigation schedules. A TMY consists of 12 months selected from individual years and concatenated to form a complete year with daily values. These  $ET_a/ET_m$  objectives changed with time depending on the progression of the weather conditions during the cropping season.

The moment and the amount of irrigation water applied to each crop was determined by the soil water balance module of MOPECO (Domínguez et al., 2011), and corroborated by the readings of the soil moisture sensors installed in the experimental plots.

At harvest, several parameters were evaluated: yield, bulbs diameter distribution, and water productivity (WP) in terms of yield ( $\text{kg mm}^{-1}$ ) and profitability ( $\text{€ mm}^{-1}$ ). Harvest prices were obtained from Coopaman (Cooperativa de ajos de La Mancha), while cultivation costs were calculated by using real data of one standard farm.

### Results and Discussion

As expected, the SD was the one that achieved the highest total yield in the two seasons, and the T70 the lowest, with significant differences observed between some treatments (Table 1). In consequence, SD was the treatment that reached the highest profitability per unit of area, while T70 reached the lowest (Table 1). On the contrary, the water productivity in terms of yield and profitability was highest for the T70 treatment (Table 1).

Table 1. Volume of irrigation water (IW), yield (Y), profitability (P), and water productivity (WP) in terms of yield (WPY) and profitability (WPP).

Year	Treatment	IW ( $\text{m}^3 \text{ ha}^{-1}$ )	Y ( $\text{T ha}^{-1}$ )	P ( $\text{€ ha}^{-1}$ )	WPY ( $\text{kg m}^{-3}$ )	WPP ( $\text{€ m}^{-3}$ )
2015	SD	2672	9.92a	9939.84	6.34c	3.72c
	T100	2672	9.92a	9939.84	6.34c	3.72c
	T90	2007	8.89b	8891.01	7.48b	4.43b
	T80	1797	8.55bc	8553.72	7.78b	4.76b
	T70	1594	8.44c	8448.20	8.61a	5.30a
2016	SD	3435	10.19a	10167.60	4.94c	2.96c
	T100	2748	9.07b	9068.40	5.27bc	3.30bc
	T90	2502	8.89b	8907.12	5.65b	3.56b
	T80	2224	8.27c	8273.28	5.74b	3.72b
	T70	1871	8.09c	8082.72	6.74a	4.32a

a, b, c: significant homogeneous group ( $p \geq 0.05$ ) between treatments (Duncan's test)

The distribution of bulbs per diameter (Fig. 2) corroborates the P results in Table 1. The distribution of bulbs in 2015 was similar for all the treatments. However, in 2016 due to drier climatic conditions that increased the irrigation water requirements of the crop (Table 1), only SD reached a distribution of bulbs similar to 2015. In the rest of strategies, the distribution of bulbs was moved to the left (lower price categories).

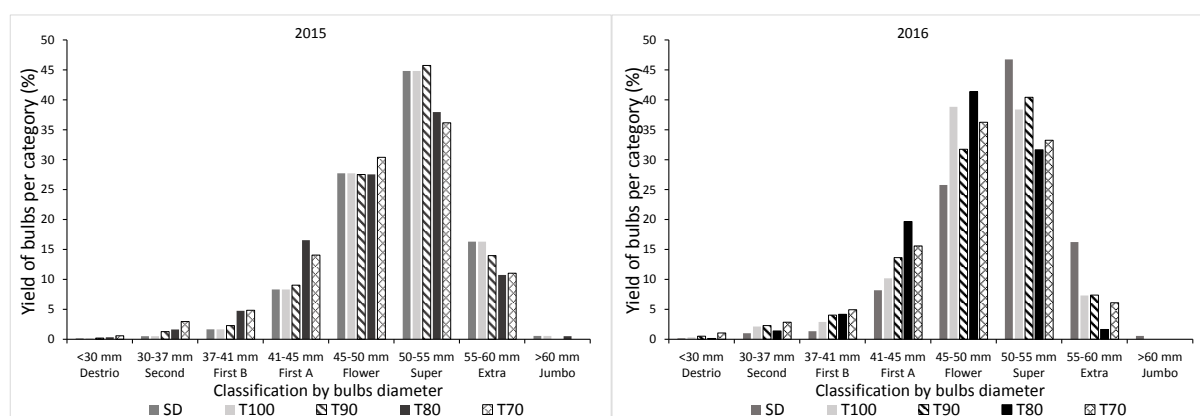


Figure 2. Yield of bulbs per diameter and year.

These results were used for analysing an example where a producer is planning the distribution of crops on its farm for the next season. In the last 20 ha this person wants to crop garlic, but the total amount of available irrigation water is  $35,000 \text{ m}^3$ , which is lower than the typical irrigation requirements of the crop ( $2750 \text{ m}^3 \text{ ha}^{-1}$ ). So, the farmer can opt by cropping a

lower area using the T100 strategy (no-deficit conditions under intermediate typical conditions) or by cropping a higher area applying the 70% of the typical irrigation requirements (T70). The rest of the area will be cultivated with a rain-fed crop that generates 150 € ha<sup>-1</sup>. Moreover, three climatic conditions were considered: a dry year (irrigation requirements higher than typical), an intermediate year (irrigation requirements similar to typical), and a humid year (irrigation requirements lower than typical). The distribution of dry, intermediate and humid years in the area for ten years is 3, 4 and 3, respectively.

As expected, the profitability per unit of cropped area with garlic was higher for the T100 strategy in the three climatic scenarios (Table 2). However, due to it is possible to cultivate a higher area by using the T70 strategy (Table 2) and its higher WPP (Table 1), for the 20 ha of the farm, the T70 strategy reached a higher total profitability than T100 in the three climatic scenarios. This way, for the climatic distribution of dry, intermediate and humid years, the average profitability increase per unit of area of the farm would be around 890.45 €.

Table 2. Comparison between the T100 and T70 strategies under real conditions.

Strategy	Area (ha)	IW (m <sup>3</sup> ha <sup>-1</sup> )	Profitability of garlic (€ ha <sup>-1</sup> )			Profitability of the farm (20 ha)		
			Dry	Intermediate	Humid	Dry	Intermediate	Humid
T100	11.36	2,750	7,485	9,700	10,161	86,353	111,523	116,761
T70	16.23	1,925	5,608	7,219	9,762	91,601	117,751	159,039

## Conclusions

The SD treatment was the one that reached the best combination between yield and calibre of bulbs with high commercial value in both seasons. Nevertheless, this work has demonstrated that it is possible to increase the profitability of irrigation farms by cropping a higher percentage of the irrigable area but supplying the same amount of irrigation water using the ORDI methodology. This result is possible thanks to a greater water productivity of the deficit treatments (the average WP increment of T70 was 26% with regards SD).

## References

- Allen R.G., Pereira L.S., Raes D., Smith M. (1998). Crop Evapotranspiration: Guide- lines for Computing Crop Water Requirements. Irrigation and Drainage, Paper No. 56. FAO, Italy.
- Bleiholder, H., Weber, E., Lancashire, P.D., Feller, C., Buhr, L., Hess, M., Wicke, H., Hack, H., Meier, U., Klose, R., van den Boom, T., Stauss, R., 2001. Growth stages of mono- and dicotyledonous plants BBCH Monograph. 2nd edition. Ed. Meier, U. Federal Biological Research Centre for Agriculture and Forestry. Braunschweig, Germany.
- Danuso F., Gani, M., Giovanardi, R., 1995. field water balance: BidriCo 2. In: L.S. Pereira, van der Broeck, B.J., Kabat, P., Allen, R.G. (eds.). Crop-Water-Simulation Models in Practice. ICI-CIID, SC-DLO. Wageningen Pres. Wageningen, The Netherlands.
- Domínguez, A., Tarjuelo, J.M., de Juan, J.A., López-Mata, E., Breidy, J., Karam, F., 2011. Deficit irrigation under water stress and salinity conditions: The Mopeco-salt model. *Agric. Water Manage.* 98, 1451-1461.
- Domínguez, A., de Juan, J.A., Tarjuelo, J.M., Martínez, R.S., Martínez-Romero, A., 2012. Determination of optimal regulated deficit irrigation strategies for maize in a semi-arid environment. *Agric. Water Manage.*, 110, 67-77.
- Domínguez, A., Martínez-Romero, A., Leite, K.N., Tarjuelo, J.M., de Juan, J.A., López-Urrea, R., 2013. Combination of typical meteorological year with regulated deficit

- irrigation to improve the profitability of garlic in central Spain. *Agric. Water Manage.* 130, 154–167.
- Doorenbos, J., Kassam, A.H., 1979. Yield response to water. *Irrigation and Drainage Paper No. 33.* FAO, Italy.
- Fabeiro Cortés, C., Martín de Santa Olalla, F., López Urrea, R., 2003. Production of garlic (*Allium sativum* L.) under controlled deficit irrigation in a semi-arid climate. *Agric. Water Manage.* 59, 155–167.
- FAO, 2017. Food and Agricultural Commodities Production. Food and Agriculture Organization of the United Nations, [www.fao.org](http://www.fao.org) (Consulted: March 31st 2017)
- Hall I.J., Prairie R.R., Anderson H.E., Boes E.C. 1978. Generation of Typical Meteorological Years for 26 SOL-MET stations. SAND 78-1601, Sandia National Laboratories, Albuquerque, NM.
- Leite, K.N., Martínez-Romero, A., Tarjuelo, J.M., Domínguez, A., 2015. Distribution of limited Irrigation water based on optimized regulated deficit irrigation and typical meteorological year concepts. *Agric. Water Manage.*, 148, 164-176.
- López-Mata E., Orengo-Valverde J.J., Tarjuelo J.M., Martínez-Romero A., Domínguez A., 2016. Development of a direct-solution algorithm for determining the optimal crop planning of farms using deficit irrigation. *Agric. Water Manage.*, 171, 173-187.
- MAGRAMA, 2015. Anuario de estadística 2014. Ministerio de Agricultura, Alimentación y Medio Ambiente, Madrid, Spain.
- Ortega, J.F., De Juan, J.A., Martín-Benito, J.M., López-Mata, E., 2004. Mopeco: An Economic Optimization Model For Irrigation Water Management. *Irrigation Science*, 23 (2), 61–75.

## MINERAL PROFILE OF TWO PHENOTYPES OF GALEGA KALE (*Brassica oleracea* L. var. *acephala* cv. Galega)

Lucía GÓMEZ-LIMIA, Jorge ARMESTO, Noemí COBAS, Inmaculada FRANCO, Sidonia MARTÍNEZ\*

Food Technology, Faculty of Science, University Campus As Lagoas s/n, 32004 Ourense, University of Vigo, Spain

\*Corresponding author: sidonia@uvigo.es

### Abstract

*Brassica* spp. have a great economic significance. They are widely distributed, and extensively cultivated throughout the world. Galega kale (*Brassica oleracea* var. *acephala* cv. Galega) is an important biennial crop in the Iberian Peninsula, especially in northern parts of Spain and Portugal. Some varieties of Galega kale have smooth leaves while others have curly or crinkly leaves. *Brassica* vegetables are important sources of dietary minerals. However, their content depends on factors such as species, variety, ecotype, maturity, agricultural practices, postharvest conditions and the plant part. The aims of this study were both, to investigate the six nutritionally important minerals of different edible portions of Galega kale (leaves, stems and whole plant) and to differentiate the curly- and smooth-leaved phenotypes. Curly- and smooth-leaved varieties of Galega kale were obtained from local markets supplied by six production areas in the province of Ourense (Galicia, NW Spain). All plants were harvested in the vegetative growth period. The edible portions were sorted into leaves and stems before being washed. The plants were also analysed whole (75% leaves and 25% stems). Minerals were assessed using an atomic absorption spectroscope. Galega kales is an excellent source of potassium, calcium or iron. Potassium was, quantitatively, the most important element in the sample analysed. Comparison of the varieties revealed higher K content and lower Fe content in whole curly kale than in whole smooth kale. Ca, Mg, Fe, Zn and Cu contents were higher in leaves than stems. However, K content was higher in stems than in leaves.

**Keywords:** Minerals, Galega kale, Curly leaves, Smooth leaves.

### Introduction

*Brassica* spp. are considered health food protective and highly beneficial for the maintenance of health and prevention of diseases, as they are a rich source of bioactive compounds, such as vitamin C, polyphenols, glucosinolates, carotenoids, calcium or iron.

Kale (*Brassica oleracea* var. *acephala*) is a nutritionally important crop grown all over the world whose the beneficial effects have been known for a long time (Kurilich *et al.*, 1999; Podsędek, 2007). Kales are a rich source of minerals such as calcium, phosphorus, iron, magnesium, copper, and potassium (Lisiewska *et al.*, 2009; Martínez *et al.*, 2011; Sikora and Bodziarczyk, 2012). Some of these minerals are commonly deficiencies micronutrient in both developed and developing countries (Welch and Grahan, 2002; White and Broadley, 2005).

Galega kale (*B. oleracea* var. *acephala* cv. Galega) is one of the oldest crops in Iberian Peninsula, especially in northern parts of Spain and Portugal. This vegetable has different varieties and ecotypes; some may have leaves with smooth or curly edges (Cartea *et al.*, 2002). Generally, curly leaves are more appreciated by consumers than smooth leaves; however, smooth leaves are more expended because of the farmers use them for fodder.

Although some nutrients of Galega kales have been quantified in previous works no study has been conducted that includes data on the differences in mineral composition between curly and smooth kales.

The aims of this work were to investigate the six nutritionally important minerals of different edible portions of Galega kale (leaves, stems and whole plant) and to differentiate between the curly- and smooth-leaved phenotypes.

### Material and Methods

Fresh curly and smooth Galega kales (*B. oleracea* var. *acephala* cv. Galega) were purchased from local markets serving different production areas in the province of Ourense (Galicia, northwest Spain). All plants were harvested in the vegetative growth period during 2015. Samples were uniform size, and appearance and were free of defects. For analytical purposes, inedible parts were discarded, and the edible portions were sorted into leaves and stems and washed. The plant was also analyzed whole (in this case, the proportion of leaves of stems was 75% leaves and 25% stems).

Determination of mineral content was performed in the central laboratory facilities (CACTI) at the University of Vigo. Samples (leaves, stems and whole plants) (0.5 g) were digested in a microwave oven (CEM MARSX press model, Matthews, NC) (1600 W, 20 min) after adding 1 mL of H<sub>2</sub>O<sub>2</sub> and 10 mL of HNO<sub>3</sub>. Potassium (K), calcium (Ca), magnesium (Mg), zinc (Zn) and iron (Fe) were assessed using an atomic absorption spectrophotometer (Varian Spectra A-220 Fast Sequential; Agilent Technologies, Santa Clara, CA, USA). An inductively coupled plasma mass spectrometer (ICP-MS X Series, Thermo Fisher Scientific Inc., Waltham, MA) was used for copper (Cu) determination. The calculations of the minerals were based on the comparison of absorption of samples against known concentration of standards and results were converted. The results are expressed as dry weight basis.

Each sample was analysed at least in triplicate. Data are expressed as the means  $\pm$  standard deviation (SD) of the measurements. Statistical analysis were conducted using two-way ANOVA with a confidence interval of 95 % ( $P < 0.05$ ) and a least squares difference (LSD) test were performed using Statistica 8.0 software for Windows (Statsoft Inc. 1996, Tulsa, OK, USA). A canonical discriminant analysis (CDA) was performed in order to differentiate cooking procedure as a function of different studied parameters. The variables were selected for CDA by extraction of principal components (PCA) through a factor analysis, i.e. Those variables with the greatest discriminant capacity were selected.

### Results and Discussion

Table 1 shows mineral contents of leaves, stems and whole Galega kales (curly and smooth). Galega kales are an excellent source of mineral, such as potassium, calcium or iron.

Potassium (K) was, quantitatively, the most important element in the sample analysed, followed by calcium and magnesium. The concentrations of K were higher in the stems (42.88-47.15 g/kg) than in the leaves (29.12-23.88 g/kg). In the leaves and whole plant, K contents were higher in curly kales than smooth kales; however, in the stems, those were higher in smooth kales. These data are consistent with the results reported by Kmiecik *et al.* (2007) in white and green cauliflower (30.35 and 32.47 g/kg, respectively) and Puupponen-Pimia *et al.* (2003) in cauliflower (40.8 g/kg). Mansour *et al.* (2015) also reported similar values to those we have found in broccoli and in cauliflower (40 and 39 g/kg, respectively). Rosa and Heaney (1996) also found that K content was higher in the stems than in the leaves of Portuguese cabbages and Galega kales.

Table 1. Minerals contents of the edible portions of two phenotypes of Galega kales (dry weight).

	Edible portions	K (g/kg)	Ca (g/kg)	Mg (g/kg)	Fe (mg/kg)	Zn (mg/kg)	Cu (mg/kg)
<b>Curly kales</b>	<i>Leaves</i>	29.12±2.62 <sup>a</sup>	46.04±3.63 <sup>a</sup>	3.62±0.30 <sup>a</sup>	147.32±21.38 <sup>a</sup>	28.07±2.07 <sup>a</sup>	4.94±0.43 <sup>ac</sup>
	<i>Stems</i>	42.88±1.61 <sup>b</sup>	26.04±2.89 <sup>b</sup>	2.94±0.26 <sup>b</sup>	31.88±3.34 <sup>b</sup>	17.59±2.18 <sup>b</sup>	3.03±0.28 <sup>b</sup>
	<i>Whole</i>	33.47±3.78 <sup>c</sup>	33.42±5.20 <sup>c</sup>	3.08±0.72 <sup>ab</sup>	99.17±8.63 <sup>c</sup>	27.97±1.04 <sup>a</sup>	4.54±0.25 <sup>c</sup>
<b>Smooth kales</b>	<i>Leaves</i>	23.88±2.11 <sup>d</sup>	38.39±4.49 <sup>d</sup>	3.29±0.42 <sup>ab</sup>	103.04±17.43 <sup>c</sup>	30.07±1.48 <sup>a</sup>	5.32±0.22 <sup>a</sup>
	<i>Stems</i>	47.15±3.75 <sup>e</sup>	17.22±1.58 <sup>e</sup>	2.08±0.23 <sup>c</sup>	40.64±4.69 <sup>b</sup>	16.43±5.46 <sup>b</sup>	3.18±0.11 <sup>b</sup>
	<i>Whole</i>	26.73±1.54 <sup>ad</sup>	36.02±2.83 <sup>c</sup>	2.97±0.32 <sup>b</sup>	76.04±3.18 <sup>d</sup>	28.34±0.98 <sup>a</sup>	5.05±0.24 <sup>ac</sup>

<sup>a-c</sup> Mean values of at least three determinations ± standard deviation (dry weight) with different superscript in the same column were significantly different (P < 0.05).

Calcium (Ca) was also found in an appreciable amount in Galega kales (33.42 and 31.21 g/kg in whole curly and smooth kales, respectively). Calcium content was higher in leaves than in stems, and curly kales showed higher calcium content than smooth kales. Rosa and Heaney (1996) obtained in kales values of Ca between 23.8 and 33.8 g/kg dry matter. Ali (2015) found calcium contents of 35.95 g/kg in cauliflower.

Magnesium (Mg) was found in higher concentrations in Galega kales (3.08-2.97 g/kg). Leaves showed higher values than stems. No significant differences were found between leaves and whole plant of curly and smooth kales. The results are consistent with those Ayaz *et al.* (2006) (2.4 g/kg) and Martínez *et al.* (2011) (2.9 g/kg) in kales.

Galega kales are also a good source of iron (Fe) (99.17-76.04 mg/kg). Leaves and whole plant in curly kales showed higher Fe content than those of smooth kales; however, stems of smooth kales had higher Fe content than those of curly kales. These results were similar to those reported by Rosa and Heaney (1996), and Martínez *et al.* (2011) in Galega kales. Ayaz *et al.* (2006) reported Fe content of 72.6 mg/kg in leaves of kale. Puupponen-Pimia *et al.* (2003) observed lower iron contents (45.7 mg/kg) in cauliflower.

The zinc (Zn) content was also higher in the leaves than the stems, and no significant differences between curly and smooth kales were observed. The results are similar to those reported by Rosa and Heaney (1996), and Martínez *et al.* (2011) in Galega kales. Puupponen-Pimia *et al.* (2003) found Fe content of 35.8 mg/kg in cauliflower.

The copper (Cu) content in whole Galega kales was at the level of 4.54-5.05 mg/kg. The leaves showed higher Cu content than stems. The Cu content in curly and smooth kales was similar. The results are consistent with those Ayaz *et al.* (2006) (5.1 g/kg) and Martínez *et al.* (2011) (5.77 g/kg) in kales.

The data were examined by multivariate statistical techniques with the aim of discriminating among samples. All the minerals studied were analyzed after factorial analysis carried out to identify the most important variables in the classification. Canonical discriminant analysis was performed on these variables. Minerals analysis revealed a discriminate structure. The analysis correctly classified 100% samples according to the edible part (leaves, stems and whole plant) (Figure 1), but not according to the phenotypic.



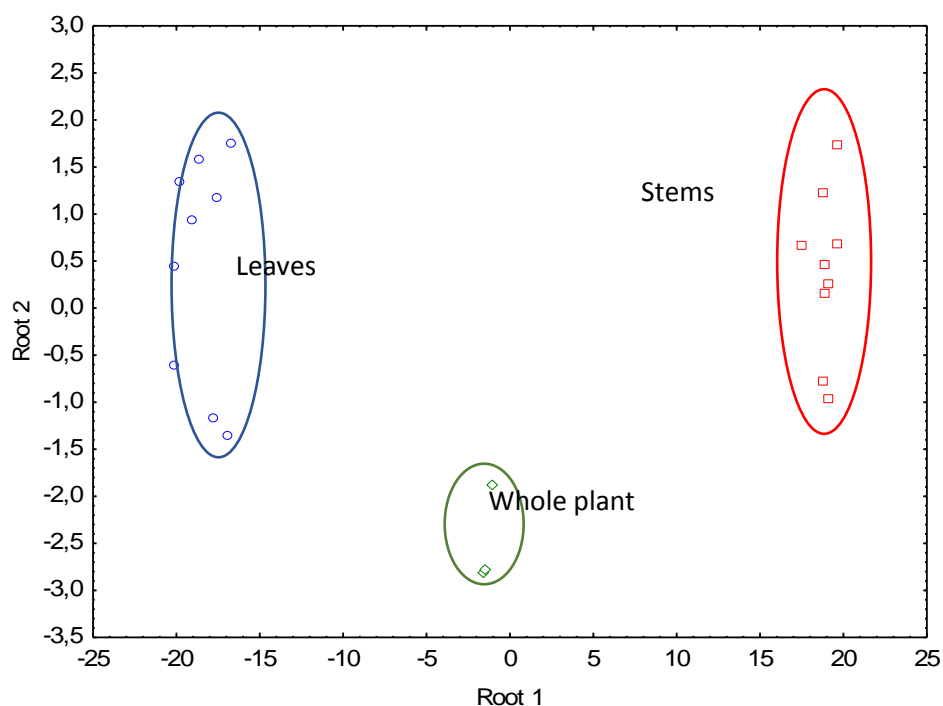


Figure 1.- Principal component analysis of minerals elements for edible parts Galega kales.

### Conclusions

Most of these minerals are essential nutrient and has an important role in the body human. In general, Galega kales have high mineral elements content, and their consumption in adequate amount could contribute to normal body growth and adequate protection against some diseases. Levels of Ca, Mg, Fe, Zn and Cu were higher in the leaves than stems, whereas K was higher in the stems. Phenotype had a significant influence ( $P < 0.05$ ) on the K and Fe contents.

### References

- Ali A.M. (2015). Effect of food processing methods on the bioactive compound of cauliflower. *Egyptian Journal of Agricultural Research*, vol. 93, pp.117-131.
- Ayaz F.A., Glew R.H., Millson M., Huang H.S., Chuang L.T., Sanz, C., et al. (2006). Nutrient contents of kale (*Brassica oleracea* L. var. *acephala* DC.). *Food Chemistry*, vol. 96, pp. 572-579.
- Cartea M.E., Picoaga A., Soengas P., Ordás A. (2002). Morphological characterization of kale populations from northwestern Spain. *Euphytica*, vol. 129, pp. 25-32.
- Kmiecik W, Lisiewska Z., Korus A. (2007). Retention of mineral constituents in frozen brassicas depending on the method of preliminary processing of the raw material and preparation of frozen products for consumption. *European Food Research and Technology*, vol. 224, 573-579.
- Kurilich A.C., Tsau G.J., Brown A., Howard L., Klein B.P., Jeffery E.H., Kushad M., Wallig M.A., Juvik J.A. (1999). Carotene, tocopherol, and ascorbate contents in subspecies of *Brassica oleracea*. *Journal of Agricultural and Food Chemistry*, vol. 47, pp. 1576–1581.
- Lisiewska Z., Gębczynski P., Bernas E., Kmiecik W. (2009). Retention of mineral constituents in frozen leafy vegetables prepared for consumption. *Journal of Food Composition and Analysis*, vol. 22, pp. 218-223.

- Mansour A.A., Shekib L.A., El Shimy N.M., Sharara M.S. (2015). Comparative study between the bioactive compounds and antioxidant activity of broccoli and cauliflower and the effect of domestic processing on them. *The International Journal of Science and Technoledge*, vol. 3, pp 246-254.
- Martínez S., Losada P., Franco I., Carballo J. (2011). Protein, amino acid, ash and mineral contents in Brassica spp. grown in Northwest Spain. *International Journal of Food Science and Technology*, vol. 46, pp. 146-153.
- Puupponen-Pimia R., Hakkinen S.T., Aarni M., Suortti T., Lampi A.M, Eurola M., et al. (2003). Blanching and long-term freezing affect various bioactive compounds of vegetables in different ways. *Journal of the Science of Food and Agriculture*, vol. 83, pp. 1389–1402.
- Rosa E., Heaney R. (1996). Seasonal variation in protein, mineral and glucosinolate composition of Portuguese cabbages and kale. *Animal Feed Science and Technology*, vol. 57, pp. 111–127.
- Sikora E., Bodziarczyk I. (2012). Composition and antioxidant activity of kale (*Brassica oleracea* L. var. acephala) raw and cooked. *Acta Scientiarum Polonorum*, vol. 11, pp. 239-248.
- Welch R.M., Graham, R.D. (2002). Breeding crops for enhanced micronutrient content. *Plant and Soil*, vol. 245, pp. 205–214.
- White P.J., Broadley M.R. (2005). Biofortifying crops with essential mineral elements. *Trends in Plant Science*, vol. 10, pp. 586–593.

## EVALUATION OF THREE INTRODUCED WINE GRAPE VARIETIES UNDER A RAIN-FED SYSTEM OF AGRICULTURE IN SYRIA

Ola T. ALHALABI\*, Bayan M. MUZHER, Alaa ALZGAIR

General Commission for Scientific Agricultural Research, Syria

\*Corresponding author: ola\_halabi@msn.com

### Abstract

The present study was carried out by the General Commission for Scientific Agriculture Research – Pome and Grapevine Division in Sweida Province (Syria) during 2014 and 2015 to evaluate three introduced wine varieties Carignan, Cabernet Sauvignon and Chardonnay, under a rain-fed system of agriculture. The results indicated that bud burst in the two varieties, Carignan and Chardonnay, happened on 25<sup>th</sup> April, and in Cabernet Sauvignon it was on May 2<sup>nd</sup>. Carignan and Cabernet Sauvignon significantly were more vigorous than Chardonnay in blade length and width, internode length and diameter. Cabernet Sauvignon had the highest length of bunch (158 mm), while there was no significant variance in bunch width among all the studied varieties. Carignan significantly showed higher values of bunch weight (328.4 g), berry length, width and weight, must yield and tree yield. A chemical analysis of must showed that Chardonnay variety insignificantly had higher total soluble solids (23.2%) than the two other varieties, and there was no significant variation in total sugar as well among studied varieties, while Chardonnay significantly showed the lowest total acid content (5.5 g/L) than the other two varieties. Consequently, the results revealed distinct traits that encourage us to use the studied wine varieties in the similar environmental conditions.

**Key words:** *Grape, Carignan, Cabernet Sauvignon and Chardonnay cultivars, evaluation.*

### Introduction

Grape is widely spread across the world and can be divided into four main groups: European, American, French/American hybrids, and Muscadine, which are used for different purposes: table fruit, wine, juice, jam, jellies and raisins (Maughan *et al.*, 2016). There are many wine grape varieties produced different types of wine such as Cabernet Sauvignon which is considered as the most of the noble French varieties (Galet, 1998); Chardonnay is one of the eminent varieties for the production of high quality white wines in the world (Bettiga, 2003), Tempranillo is a very famous Spanish variety, gives 28 dissimilar types of wines (Dimovska *et al.*, 2015), Carignan is used to produce red table wine (Dokoozlian, 2003), and Riesling and Silvaner are German white wine variety (Sweet, 2009).

The evaluation of grape varieties adaptation to new region with special microclimates, is an important work, however requirement of heat accumulation during fruit maturation is generally the limit factor (Reynolds *et al.*, 2004; Moulton *et al.*, 2008; Wise, 2015). Influence of different locations, with various topography in western Colorado, on fruit quality and production of 35 wine grape varieties was studied to select the most suitable one in each microclimate (Hamman and Dami, 1999). Six varieties of German white wine were evaluated in Romania to compare their qualitative and quantitative performance with the country of origin (Store and Ioana, 2015). Evaluation of 11 wine grape varieties in

Karnataka for the variation in growth and yield was done to choose the proper one to the conditions of the studied area (Hachcholli *et al.*, 2016).

In Syria, grape is the main tree, it occupies the second position of deciduous fruit trees in production after apple tree depending on old local cultivars. Thus, it is very important to improve viticulture by using new introduced varieties beside our local ones. Since, the aim of this study is to evaluate three introduced wine grape varieties under rain fed agriculture at high altitude in the south of Syria.

### Materials and Methods

This investigation was achieved during 2014-2015 at Pome and Grapevine Division-GCSAR in Sweida province which located in the south of Syria at 1525 m altitude. The mean rainfall 525mm. The monthly average temperature of growth season, during the period of study, was as following: 10.8 °C, 16 °C, 19.5 °C, 20.5 °C, 19 °C, 21 °C and 16 °C in April, May, June, July, August, September and October respectively.

#### Plant materials

Three introduced grape wine varieties, they are 25 years old, grafted on the rootstock Polsen 1103, the training system is cordon, the distance between vineyards and between the rows is 2.5 x 3 m under rain fed system agriculture. These varieties are:

- Carignan: is a Spanish variety, the bunch is broad conical, the berry is short oval, with dark purple- black skin (Dokoozlian, 2003).
- Cabernet Sauvignon: is a French variety, the bunch is conical, the berry is round, with blue black skin (Wolpert, 2003).
- Chardonnay: is a French variety, the bunch is cylindrical, the berry is round, with yellow to amber skin (Bettiga, 2003).

#### Methods

Evaluation of the studied varieties was done depending on the descriptors IPGRI (1997) and OIV (2009) as the following:

Time of bud burst.

Full maturity of the berry: maximum sugar content of the berry.

Length of internodes (very short  $\leq 60$  mm, short  $\sim 90$  mm, medium  $\sim 120$  mm, long  $\sim 150$  mm and very long  $> 180$  mm).

Diameter of internodes (very small  $\leq 5$  mm, small  $\sim 8$  mm, medium  $\sim 11$  mm, big  $\sim 14$  mm and very big  $> 17$  mm).

Length of the leaf blade

Width of the leaf blade

Length of the bunch (very short  $\leq 80$  mm, short  $\sim 130$  mm, medium  $\sim 180$  mm, long  $\sim 230$  mm and very long  $> 280$  mm).

Width of the bunch (very narrow  $\leq 40$  mm, narrow  $\sim 80$  mm, medium  $\sim 120$  mm, broad  $\sim 160$  mm and very broad  $> 200$  mm).

Single bunch weight (very low  $\leq 100$  g, low 150-250 g, medium 350-450 g, high 650-950 g and very high  $> 1200$  g).

Yield: kg/ tree

Berry length (very short  $\leq 8$  mm, short  $\sim 13$  mm, medium  $\sim 18$  mm, long  $\sim 23$  mm and very long  $> 28$  mm).

Berry width (very narrow  $\leq 8$  mm, narrow  $\sim 13$  mm, medium  $\sim 18$  mm, broad  $\sim 23$  mm and very broad  $> 28$  mm).

Single berry weight (very low  $\leq 1$ g, low 1.7-2.3 g, medium 3.5 g, high 7-9 g and very high  $> 12$  g).

Must yield of berries (very little <50 ml juice/ 100 g berries, little 50-65 ml/ 100 g, medium 66-75 ml/ 100g, high 76-90 ml/ 100g and very high >90 ml/ 100 g).

Total soluble solids content of must

Sugar content of must (low ~ 15%, medium ~18% and high ~21%).

Total acid content of must: tartaric acid g/L (very low  $\leq 3$ , low 6, medium 9, high 12 and very high 15).

### Experimental design and statistical analysis

The experiment was designed in complete randomized blocks design, using 15 trees from each variety in three replications. The variance among varieties was analyzed for each trait by one way ANOVA analysis, LSD5% was calculated to compare means.

## Results and discussion

The time of bud burst happened on 25<sup>th</sup> April in Carignan and Chardonnay varieties, earlier than Cabernet Sauvignon variety, which was on 2<sup>nd</sup> May, the late time of bud burst is preferable in the regions which are subjected to spring frost like the studied region. Studies on Cabernet Sauvignon indicated that it is a late bud burst (Sweet, 2008). Hamman and Dami (1999) considered bud burst on 25<sup>th</sup> April as an early date, and on 10<sup>th</sup> May as a late one. The time of full maturity of berries was late in all studied varieties, it was at the first of October in Cabernet Sauvignon, while in Carignan and Chardonnay were on 10<sup>th</sup> October, due to the moderate summer temperatures in the studied region. These results are in agreement with literature studies, that Cabernet Sauvignon considered as a mid to late season variety, depending on heat unit accumulations, thus ripening occurs in late August to late October (Wolpert, 2003), Carignan is a late season variety, ripens in late September to mid October (Dokoozlian, 2003), and Chardonnay is an early season variety, but in cold regions it ripens in mid to late October (Bettiga, 2003).

Blade length of Carignan was the highest one among studied varieties, showed significant difference with Chardonnay. Likewise, Chardonnay significantly revealed the smallest blade width among studied varieties (Table 1), this result is in agreement with IPGRI (1997) that the size of Carignan blade is classified as large one. The internodes of studied varieties were very short to short, Chardonnay significantly has the shortest internodes (62 mm), while Cabernet Sauvignon showed the highest one (78 mm). However, the internode length of Cabernet Sauvignon is considered a short one according to OIV (2009). The length of internode varies along the cane according to changeable growth rates through the season (Hellman, 2003). The internodes diameter of Chardonnay and Carignan varieties were very small, while it was very small to small in Cabernet Sauvignon, which showed significant variance with Chardonnay (Table 1), which depends on growth vigor of the variety.

Table 1: Blade length and width (mm), internodes length and diameter (mm) in the studied varieties.

Variety	Blade length (mm)	Blade width (mm)	Internodes length (mm)	Internodes diameter (mm)
Carignan	108 a	141 a	75 a	5 ab
Cabernet Sauvignon	106 ab	142 a	78 a	5.6 a
Chardonnay	99 b	130 b	62 b	4.6 b
LSD5%	8	9	8	0.7

Means in columns having the same letters are not significantly different

The bunch length of studied varieties was short to medium according to IPGRI (1997) and OIV (2009) descriptors. However, Carignan significantly showed the shortest bunch (128 mm) among studied varieties. On the other hand, the bunch width was medium to broad in

Carignan variety, and narrow to medium in Cabernet Sauvignon and Chardonnay varieties, the variances were insignificant among the studied varieties (Table 2). The highest bunch weight was 328.4 g in Carignan, which is classified as low to medium weight, while the bunch of Cabernet Sauvignon and Chardonnay varieties had low weight, they significantly differed than Carignan. In addition, Carignan revealed the highest significant yield (30.5 kg/tree) among studied varieties (Table 2), this indicates to the high yield of this variety under rain fed system of agriculture. However, the yield of varieties mainly depends on genetic factors which regulate the fertility of buds, then on the environmental conditions, age of tree and fertilizing management (Lisek, 2014). In comparison with literatures reviews, our results revealed higher bunch length, lower bunch weight and yield in Cabernet Sauvignon than the obtained results in Karnataka which were 132 mm, 276 g and 17.6 kg/tree for bunch length, bunch weight, and yield respectively (Hachcholli *et al.*, 2016) . On other hand, Chardonnay showed higher values of bunch weight and yield than the results obtained by Wise and Gardner, (2016) in the Long Island.

Table 2: Bunch length and width (mm), bunch weight (g) and yield kg/tree in the studied varieties.

Variety	Bunch length (mm)	Bunch width (mm)	Bunch weight (g)	Yield kg/tree
Carignan	128 b	121	328.4 a	30.5 a
Cabernet Sauvignon	158 a	106	202.3 b	14 b
Chardonnay	143 a	106	217 b	12.3 b
LSD5%	25		71.9	10.4

Means in columns having the same letters are not significantly different

The berry length and width of Carignan (16 mm and 15.3 mm respectively) were significantly higher than the other studied varieties (Table 3), however its berry was short to medium and narrow to medium for length and width respectively, while in the other studied varieties were very short to short and very narrow to narrow according to IPGRI (1997) and OIV (2009). Moreover, the berry weight of Carignan variety (2.32 g) was low, and showed significant variance with the other studied varieties, which their berry weight were very low to low, which revealed significant difference between each other (Table 3). This result is in agreement with Dokoozlian, (2003); Wolpert, (2003) and Bettiga, (2003) which reported that Carignan has medium berry, while Cabernet Sauvignon and Chardonnay have small berry. In addition, the berry weight in Cabernet Sauvignon and Chardonnay was higher than the results obtained by Hachcholli *et al.*, (2016) and Hamman and Dami, (1999) which were 1.81 g and 1.63 g respectively. The must yield of berries was medium (75 ml/100 g) in Carignan, followed by Cabernet Sauvignon, they showed significant differences with Chardonnay (Table 3). However, the berries must yield of Cabernet Sauvignon and Chardonnay varieties was low to medium.

Table 3: Berry length and width (mm), berry weight (g) and must yield (ml/ 100g) in the studied varieties.

Variety	Berry length (mm)	Berry Width (mm)	Berry weight (g)	Must yield (ml/100 g)
Carignan	16 a	15.3 a	2.32 a	75 a
Cabernet Sauvignon	12 b	12 b	1.22 c	73 a
Chardonnay	12 b	12.7 b	1.45 b	68 b
LSD5%	0.7	1	0.9	2.6

Means in columns having the same letters are not significantly different

The figure (1) showed that Chardonnay had insignificant highest total soluble solids of must content (23.2%) among studied varieties, and there was insignificant difference between the other studied varieties. The must content of sugar was medium to high in all studied varieties (20, 18.8 and 18.5% in Cabernet Sauvignon, Chardonnay and Carignan respectively), with insignificant differences among them. The total acid content of must was significantly very low to low in Chardonnay (5.5 g/L), and low to medium in the other studied varieties (7.1 g/L), the difference between Cabernet Sauvignon and Carignan was insignificant (Figure 1). Carignan showed the lowest value of total soluble solids and total sugar among studied varieties, this indicated to its high requirement of heat accumulation. Cabernet Sauvignon showed less little total soluble solids content and more total acid than the literature reviews which were 23 % and 5.8 g/L respectively (Hamman and Dami, 1999; Wise and Gardner, 2016). On the other hand Chardonnay showed less total acid content than the result obtained by Hamman and Dami (1999) which was 6.8 g/L. Climatic factors, mainly temperature, have a most important influence on fruit composition at maturity, that hot climates help higher sugar content and lower acidity; while cool climates cause little sugar accumulation and keep extra acidity (Hellman, 2003).

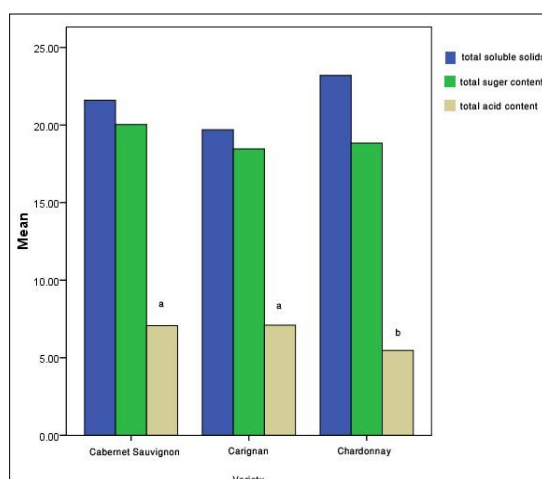


Figure 1: The must content of total soluble solids, total sugar and total acidity in the studied varieties. (LSD5% for total acid content= 0.68, means above bars of same colors having the same letters are not significantly different).

## Conclusion

Evaluation of the studied wine grape varieties, Carignan, Cabernet Sauvignon and Chardonnay, indicated that they can succeed under rain fed system of agriculture at high altitude 1525 m. As well as, it is necessary to evaluate their performance in lower altitude, and under irrigated system of agriculture.

## References

- Bettiga, L. 2003. Chardonnay. Wine Grape Varieties in California, 45-49.
- Dimovska, V., Ilijeva, F., Petropulos, V.I., Sofijanova, E. and Neceva, Z. 2015. Characteristics of Tempranillo grape variety (*Vitisvinifera*L.), grown in Tikves's vineyard. Scientific works of food technologies volume LXII: 251-255.
- Dokoozlian, N. 2003. Carignane. Wine Grape Varieties in California, 41-43.

- Galet, P. 1998. Grape Varieties and Rootstock Varieties. Oenoplurimediasarl. Chaintré, France.
- Hachcholli, A., Hipparagi, K., Rani, S., Ravindranath and Balesh, G. 2016. Evaluation of wine grape varieties for growth and yield under northern dry zone of Karnataka. *International Journal of Scientific Research*, 5(2): 409- 411.
- Hamman, R. A. and Dami, I. E. 1999. Evaluation of 35 wine grape cultivars and ‘Chardonnay’ on 4 rootstocks grown in Western Colorado. Colorado State University Agriculture Experiment Station, 10p.
- Hellman, E. W. 2003. Grapevine structure and function. In: H. W. Edward (Ed): Grape grower’s handbook, 5-19. Corvallis, Oregon: Oregon State University Press.
- IPGRI, (1997). Descriptors for Grapevine (*Vitis* spp.).
- Lisek, j. 2014. Evaluation of Yield and Healthiness of twenty table grapevine cultivars grown in central Poland. *Journal of Horticultural Research*, 22(1): 101-107.
- Maughan, T., Pace, M. and Black, B. 2016. Grape varieties for Utah. Horticulture/Grapes Utah State University Extension, 4p.
- Moulton, G., Miles, C., King, J. and Echlin, C. 2008. Summary of results: wine grape variety trail for Maritime Western Washington. Washington State University, 54p.
- OIV. (2009). Code des caracteres descriptifs des varieties et especes de vitis.
- Reynolds, A., Cliff, M., Wardle, D. and King, M. 2004. Evaluation of wine grapes in British Columbia: Chardonnay and Pinot noir clons. *HortTechnology*, 14(4): 594- 602.
- Stroe, M. V. and Ioana, C. 2015. Research on qualitative and quantitative performance of German origin varieties in Ecopedoclimetic conditions of the experimental field U.S.A. M. V. Bucharest. Online ISSN 2286- 1580, ISSN- L2285- 5653.
- Sweet, N. 2008. Cabernet Sauvignon. FPS Grape Program Newsletter, 16-32.
- Sweet, N. 2009. Riesling selections. FPS Grape Program Newsletter, 23-37.
- Wise, A. 2015. Twenty-two years of grape variety trials Shape Long Island grape industry. Research focus, Cornell Viticulture and Enology, 5p.
- Wise, A. and Gardner, A. 2016. Evaluation of winegrape cultivars and clones. Viticultural research on Long Island. Cornell University, Cooperative Extention of Suffolk Country, 7p.
- Wolpert, J. 2003. Cabernet Sauvignon. *Wine Grape Varieties in California*, 37-39.



## EVALUATION OF THE BEHAVIOR OF SOME *PISTACIA VERA* FEMALE GENOTYPES IN THE SOUTH OF SYRIA

Najwa Motaeb ALHAJJAR\*, Bayan Mohammad MUZHER

General Commission for Scientific Agricultural Research, Syria

\*Corresponding author: najwa81hj@yahoo.com

### Abstract

This investigation was conducted by the General Commission for Scientific Agricultural Research- Scientific Agricultural Center in Sweida and in pistachio fields during 2012- 2015. The aim of the investigation was to evaluate the behavior of some *P.vera* female genotypes (6 Ashouri, 2 Batouri, 2 Ajami, 1 Beadi and 2 Turkish genotypes) through determining the most important parameters used for evaluating the adaption and success of pistachio cultivation. All studied Ashouri genotypes tended to bloom earlier (12-21<sup>th</sup> March) than other genotypes, whereas the full flowering period of the two Turkish genotypes were late (1-4<sup>th</sup> April). The largest nut dimension was 1.95cm in BatouriGhrahibeing significantly different than all other studied genotypes. The percentage of dried kernel weight to total dried nut weight was 50.55% in fluffy AshouriMawardi genotype, while it was 39.63% in AshouriLesan Altair genotype. The split nuts percentage ranged between 7-93%. Three cases of blank nuts were defined; some of them are newly registered: 1. The barthinocarpy phenomena: The oval grows for a short time without fertilization. 2. Abnormal kernels: The kernel occupies just 1/3 of the shell plenum, and in some cases the kernel seemed to be sticky. 3. The decomposition of the cotyledon's endosperm into a sweet liquid, also the kernel in this case occupies just 1/3 of the internal space inside the shell. The current results indicate there is a huge genetic diversity of female *P.vera* species, which are still cultivated marginally and have important commercial traits as BatouriGhrahi and Fluffy AshouriMawardi genotypes. These genotypes are supposed to be separated cultivars and need to be identified at molecular level for the purpose of identification; i.e. to be confidently credited as commercial cultivars by the governmental nurseries within the Ministry of Agriculture in Syria.

**Keywords:** Pistachio, *P.vera*, behavior evaluation, blank nuts, split nut percentage.

### Introduction

The genus *Pistacia* belongs to *Anacardiaceae* family comprises more than 11 different species, whereas *Pistaciavera* is one of the most prominent horticultural plants from an economic and commercial point of view (Afzadi *et al.*, 2007). The main cultivated areas are the middle and west Mediterranean basin countries, basically Iran, Turkey and Syria. Since this species has a great adaption to harsh environmental circumstances, its cultivation spreads widely in the boor societies and in arid and semi-arid regions (Padulosi *et al.*, 1996) where other fruit trees practically can not grow, pistachio with its powerful root system and shady patulous crown is of great soil and water-protective importance. It may be grown in desert areas since it needs long hot summers for fruit maturation and high winter chilling (Chattiet *al.*, 2017). Pistachio with dioeciously and heterozygous nature has a high genetic diversity (Aliakbarkhaniet *al.*, 2013). In Syria the main produced regions of *P.vera* crop are Aleppo, Hama and Idleb provinces. In the last few decades, this cultivation was widely spread to other provinces at the south of Syria. However, there are a lot of genotypes belong to the

same cultivar with different local names especially in the new cultivated areas. Even though this cultivation is still depends on a narrow genetic platform in spite of a wide number of important genotypes which are still marginally cultivated and recognized of valuable commercial characters (Basha *et al.*, 2007). Some of these individuals could be genetically important for breeding and fertilization programs. Hence, this investigation aimed to evaluate the behavior, and the main limited parameters as blank nuts of different forms, split nut percentage and the productivity of the most spread genotypes of different local names to assess a base of genetic identifications for further genetic relationships among genotypes and cultivars.

## Materials and methods

This research was conducted during 2012-2015 in the South of Syria.

### Plant material

Thirteen different genotypes related to different commercial cultivars (25 years old) were studied: 6 Ashouri genotypes (Common Ashouri, Fluffy Ashouri Mawardi, Ashouri Mawardi, white Ashouri, Ashouri Lesan Altair, and Ashouri Abu Reha)-2 Batouri genotypes (Batouri Ghrahi, and red Batouri)-2 Ajami genotypes (Ajami Ras Alkharouf, and Common Ajami)-Beady cultivar – and 2 Turkish genotypes (Turk.1 and Turk.2).

### Methods

Phenological stages: According to (IPGRI, 1997).

Morphological parameters: Nut diameter  $D_p = (L.W.T)^{1/3}$  and Nut sphericity  $\phi = (D_p/L) \times 100$  according to (Mohsenin, 1980; Galedaret *et al.*, 2008; Kardoushet *et al.*, 2009). Kernel weight/total nut weight (wet and dry weight) according to (AOAC, 1995). Split nuts percentage according to (Kashaninejad *et al.*, 2002) Blank nuts percentage in each panicle, and the Production which's estimated as (Kg/tree).

## Results and discussion

### Phenological stages

The Phenological stages are affected by soil structure (Tuncet *et al.*, 2013), and the temperature of winter and spring seasons (Javanshah, 2010). The major genotypes of Ashouri cultivar (Ash) were recognized by their early blooming period, so the full blooming stage of the genotypes (Common Ash., White Ash., and Lesan Altair) was from 11-15<sup>th</sup> march, whereas it was between 14-21<sup>th</sup> march in the genotypes (Fluffy Mawardi, Mawardi and Abu Reha) as it is illustrated in Table (1). In Batouri cultivar the both genotypes bloomed on 16<sup>th</sup> and 22<sup>th</sup> march. However, Red Batouri genotype was bloomed earlier than Batouri Ghrahi of about 3-4 days. The both genotypes of Ajami cultivar varied of their full blooming date, and it was earlier in the Common genotype of about 3-4 days than the genotype Ras Alkharouf (20-23<sup>th</sup> march). The full flowering date of Turkish genotypes (Turk.1 and Turk.2) was somehow late in comparison with all Syrian genotypes, now that the full flowering date was during 1-4<sup>th</sup> April. Kebouret *et al* (2013) mentioned that the full flowering period of some Syrian cultivars planted in Algeria ranged from 10-20<sup>th</sup> April according to their environmental circumstances.

Table1:Phonological stages of all studied *P.vera* genotypes.

cultivar	genotype	budswelling	Pre-bloom	full bloom	flowerset
Ashouri	Common.	2-4Feb.	8-11Mar.	12-15Mar.	15-17Mar.
	Fluffy mawardi	5-6Feb.	12-13Mar.	14-17Mar.	18-20Mar.
	Mawardi	7-9Feb.	12-14Mar.	15-18Mar.	19-22Mar.
	White	3-4Feb.	8-10Mar.	11-14Mar.	15-17Mar.
	Lesanaltair	2-4Feb.	7-10Mar.	11-14Mar.	15-18Mar.
Batouri	Abu reha	7-9Feb.	14-17Mar.	18-21Mar.	22-23Mar.
	Ghrahi	9-11Feb.	15-18Mar.	19-22Mar.	23-25Mar.
Ajami	RedBat.	7-9Feb.	13-15Mar.	16-19Mar.	20-22Mar.
	Rasalkharouf	7-8Feb.	13-16Mar.	17-19Mar.	20-22Mar.
Bead	Common	10-12Feb.	17-19Mar.	20-23Mar.	24-25Mar.
	Bead	9-11Feb.	14-17Mar.	18-21Mar.	22-24Mar.
Turkey	Turk.1	14-16Feb.	28-31Mar.	1-4April	5-7 April
	Turk.2	16-18Feb.	29-31Mar.	1-3 April	4-6 April

### Nut diameter and sphericity

The mean of the nuts diameter varied among all studied specimens. The largest diameter was 1.95 cm in Red Batouri genotype of significant differences ( $P \leq 5\%$ ) in comparison with all other studied genotypes. The largest nuts diameter among the genotypes belong to Ashouri cultivar was 1.82 cm in Mawardi of significant differences in comparison with all other genotypes except for Fluffy Mawardi genotype which was 1.79 cm (Table.2). These results were closed to the average of Ashouri nuts dimensions 1.45x1.50x2.70 cm as indicated by (Hadj-Hassan, 2003) on the same cultivar. Ajami nut diameters were closely in both genotypes, it was 1.81 cm in the Common genotype and 1.83 cm in Rasalkharouf. A notable difference of nuts diameter was noticed between the two Turkish genotypes. However, the smallest nuts diameter was 1.56 cm in Turk.2 which was closed to some Turkish genotypes according to (Ak and Acar, 2001) as their results showed nuts dimension of 1.93-2.03 cm for length, 0.94-1.15 cm for width and 0.72-1.1 cm for thickness. The highest percentage of nuts sphericity was 74.9% in Fluffy Ashouri Mawardi of significant differences with all estimated genotypes, followed by Bead cultivar 70.8% which was also of significant differences in comparison with all other genotypes. The nut sphericity percentage of both Ashouri genotypes (Common, and Lesan Altair) was identical (66.7%). The both Ajami genotypes (Common and Rasalkharouf) showed close percentages of nut sphericity 68.8% and 69.1% respectively. The percentage of the genotype Batouri ghrahi was lightly low (65%) cause the nut's length is extremely large and reaches in average 3 cm. These variances among all genotypes indicated to a huge genetic variance inside each cultivar and this might indicate that some of these genotypes are not descended from the same cultivar and this confusion occur due to the frailer of grafting accompanied with low experience of the farmers to differentiate between the grafted and non-grafted seedlings, now that these differentiations are as a result of seed genetic segregation. In comparison with previous literature, the current results of nuts sphericity were lower than the results showed by (Polat *et al.*, 2007) whereat the nuts sphericity percentage was 82%.

### Wet and dried kernel weight to the total nuts weight

The highest ratio of kernel/ wet nut weight was 37.55% in the genotype Turk.2 of significant differences with other genotypes except Turk.1 and Ajam.1 genotypes (37.27% and 37.45%) respectively. As it is illustrated in Table (2), the highest percentage of kernel weight/ wet nut weight within Ashouri genotypes was 36.37% in Lesan Altair, even though this genotype had the smallest kernel size, and this might be due to a high content of kernel's moisture, Whereas

the lowest percentage was 31.36% in Ashouri AbuRehagenotype, which indeed has thick, and wet shell nut that reduce the percentage of the total kernel wet weight to the total nut weight. Significant differences were shown between the two Batouri genotypes (34.55 and 31.61%), this result also confirms our previous prediction that the genotype BatouriGrahi is not descended from Batouri cultivar. Hadj- Hassan (2003) indicated that the ratio of kernel/nuts wet weight could be estimated of 1/3 in a general sight, and there were differences between the cultivars (40% in Oliemi, 36% in Batouri and 34% in Ashouri). The highest percentage of dried kernels and nuts weight was 50.55% in Fluffy AshouriMawardi genotype of significant differences ( $P \leq 5\%$ ) in comparison with all studied specimens. In Batouri cultivars the ratio of dry kernel weight to total dry nut weight was 42.92% in BatouriGhrahi and 47.85% in RedBatouri of significant differences. The percentage of both Turkish genotypes was almost the same (47.72 and 47.81%). The current results were higher in comparison with Misirli and Ozeker (2001) that their results indicated to a percentage of dry nut and kernel weight between 34.86-37%.

#### Split nut percentage

The highest split nuts percentage was 93% in the genotype Fluffy Mawardi of significant differences with all studied genotypes except the genotype AshouriMawardi which was 89% (Table, 2). In the red Batouri genotype the split nuts percentage was low (36%), while it was median (62%) in BatouriGhrahi genotype. Alhajjareta *et al.* (2013) mentioned that the split nut percentage of different pistachio genotypes in Syria ranged between 24-96%, whereas Kayimov *et al.* (2001) indicated to a split nut percentage of only 21% for Batouri cultivar. The two Ajami's genotypes showed median nut split percentages 61% and 78% of significant differences between each other. The split nut percentage was also low in Beadi cultivar (45%), which was lower than the split percentage in comparison with Kayimov *et al.* (2001) for the same cultivar (57%). However, the split nut percentage was too low in both Turkish genotypes (less than 20%). In parallel to previous review for Turkish cultivars, Gokce and Akcay (1993) indicated to ratios of split nut percentage ranged between 32-71%, and (Ak and Acar, 2001) mentioned that this ratio ranged between 37-92% in different Turkish genotypes.

#### Blank nuts percentage

This percentage is evaluated at maturity time. In the current study the blank nut phenomena was estimated from two weeks after fruit set until one month before maturity time. The highest blank nut percentage was obtained in AshouriLesan Altair 13.98% of significant differences with all other genotypes, whereas the lowest percentage was 4.22% in Fluffy AshouriMawardi genotype. The variance of blank nuts percentage in Ashouri genotypes is higher than the other cultivars. The blank nut percentage in BatouriGhrahi 5.4% which is significantly less than the blank nut percentage in red Batouri (6.8%). Ghrabet *et al.* (2010) indicated to a high percentage of blank nut ranged between 2-60% in *P. vera* genotypes in Tunisia. Several blank nuts cases were identified, some of them were due to Parthenocarpic phenomena (Fig 1-A1) as the oval grows for a short time without fertilization. Other blank nuts cases were defined as incorrect fertilization, the phenomena that the embryo does not continue its naturally growth 'which is known as an abortion phenomena'. Moreover, other three blank nuts cases were registered for the first time: Abnormal kernels as the kernel occupies just 1/3 of the shell plenum (Figure, 1-A2), and in some cases the kernels seemed to be sticky (Figure 1-A3), and the decomposition of the cotyledon's endosperm into a sweet liquid (Figure 1-A4), also the kernel in this case occupies just 1/3 of the internal space inside the shell. The reason for each blank nut case needs to be deeply identified.

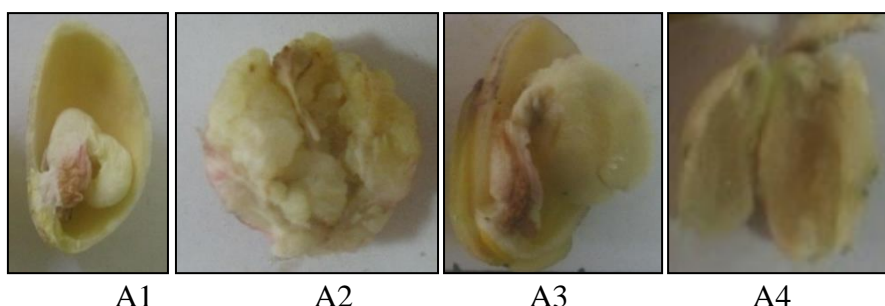


Figure 1: Blank nut phenomena: A1:Parthincarpy, A2: Abnormal kernels, A3:The decomposition of the cotyledon's endosperm into a sweet liquid.

#### The production

The production was estimated as Kg per tree under rainfed cultivation, and the results indicated to a large variance within the studied genotypes especially in Ashouri genotypes and it ranged between 5 to 25 kg/tree(Table,2).

Table 2: The main characters of different studied genotypes of *P.vera* L.

genotype	Diameter cm	Sphericity %	Kernel size	Total weight %		Split nut%	Blank nut%	Production Kg/tree
				Wet	Dry			
Common Ash.	1.70 <sup>DE</sup>	66.7 <sup>EF</sup>	1.90 <sup>CD</sup>	35.74 <sup>C</sup>	46.55 <sup>CD</sup>	83 <sup>B</sup>	6.17 <sup>CD</sup>	23 <sup>B</sup>
Fluffy Ash. mawardi	1.79 <sup>BCD</sup>	74.9 <sup>A</sup>	1.98 <sup>C</sup>	34.48 <sup>D</sup>	50.55 <sup>A</sup>	93 <sup>A</sup>	4.22 <sup>G</sup>	25 <sup>A</sup>
Ash. mawardi	1.82 <sup>BC</sup>	67.6 <sup>D</sup>	1.82 <sup>D</sup>	34.35 <sup>D</sup>	45.67 <sup>DE</sup>	89 <sup>A</sup>	4.67 <sup>FG</sup>	22 <sup>B</sup>
White Ash.	1.7 <sup>DE</sup>	63 <sup>H</sup>	1.50 <sup>FG</sup>	32.62 <sup>E</sup>	48.57 <sup>B</sup>	73 <sup>C</sup>	8.72 <sup>B</sup>	17 <sup>D</sup>
Ash. Lesanaltair	1.72 <sup>DE</sup>	66.7 <sup>EF</sup>	1.36 <sup>G</sup>	36.37 <sup>BC</sup>	39.63 <sup>J</sup>	50 <sup>E</sup>	13.98 <sup>A</sup>	5 <sup>E</sup>
Ash. Abu reha	1.72 <sup>DE</sup>	66.2 <sup>F</sup>	1.54 <sup>EF</sup>	31.36 <sup>F</sup>	43.70 <sup>GH</sup>	75 <sup>C</sup>	6.1 <sup>CD</sup>	20 <sup>C</sup>
Bat. ghrahi	1.95 <sup>A</sup>	65 <sup>G</sup>	2.32 <sup>A</sup>	34.55 <sup>D</sup>	47.85 <sup>B</sup>	62 <sup>D</sup>	5.4 <sup>DEF</sup>	22 <sup>B</sup>
Red Bat.	1.83 <sup>B</sup>	67.8 <sup>D</sup>	2.15 <sup>B</sup>	31.61 <sup>F</sup>	42.92 <sup>H</sup>	36 <sup>F</sup>	6.8 <sup>C</sup>	18 <sup>D</sup>
Aja. Rasa lkharouf	1.83 <sup>B</sup>	69.1 <sup>C</sup>	2.02 <sup>BC</sup>	37.45 <sup>A</sup>	45.15 <sup>EF</sup>	61 <sup>D</sup>	5.21 <sup>DEF</sup>	22 <sup>B</sup>
Common Aja.	1.81 <sup>BC</sup>	68.8 <sup>C</sup>	1.92 <sup>CD</sup>	33.27 <sup>E</sup>	41.36 <sup>I</sup>	78 <sup>BC</sup>	5.8 <sup>DE</sup>	20 <sup>C</sup>
Beady	1.72 <sup>DE</sup>	70.8 <sup>B</sup>	1.66 <sup>E</sup>	33.29 <sup>E</sup>	44.23 <sup>FG</sup>	45 <sup>E</sup>	8.2 <sup>B</sup>	17 <sup>D</sup>
Turk.1	1.75 <sup>CDE</sup>	67.3 <sup>DE</sup>	1.91 <sup>CD</sup>	37.27 <sup>AB</sup>	47.72 <sup>BC</sup>	17 <sup>H</sup>	4.69 <sup>FG</sup>	22 <sup>B</sup>
Turk.2	1.56 <sup>F</sup>	67.8 <sup>D</sup>	1.37 <sup>G</sup>	37.55 <sup>A</sup>	47.81 <sup>BC</sup>	7 <sup>G</sup>	5.02 <sup>EPG</sup>	23 <sup>B</sup>
<b>LSD5%</b>	0.08	0.62	0.15	0.96	1.27	5.21	0.98	1.98

#### Conclusion

This investigation allows the identification of parallelism in ancestral variability of close genotypes within *P.vera* species. It allows development of new variants and races of practical interest as Fluffy AshouriMawardi and BatouriGhrahigenotypes. These genotypes are supposed to be separated cultivars and need to be identified at molecular level to be confidently credited as commercial cultivars by the governmental nurseries within the Ministry of Agriculture in Syria. Hence, collecting of genotypes and variants acquire new meaning with the purpose of management of plant genetic resources.

## References

- Afzadi, M.A., Tabatabaei, B.E.S., Mohammadi, S.A. and Tajabadipur, A. 2007. A comparison of genetic diversity in species and cultivars of pistachio (*Pistacia sp. L.*) Based on Amplified fragment length polymorphism (AFLP) markers. *Iranian Journal of Biotechnology*, 5(3):147-152.
- Ak, B.E. and Acar, I. 2001. Pistachio production and cultivated varieties grown in Turkey. In: Project on underutilized Mediterranean species. *Pistacia: towards a comprehensive documentation of distribution and use of its genetic diversity in Central and West Asia, North Africa and Mediterranean Europe*. Report of the IPGRI Workshop. Irbid Jordan, Pp:27-34.
- Alhajjar, N.M., Muzher, B.M. and Hamed, F. 2013. Morphological and molecular characterization for some seedlings of pistachio vera genotypes and cultivars in Swaidaprovence. *Damascus Journal for Agricultural Sciences*, 29(3):131-149.
- Aliakbarkhani, S.T., Talaie, A. and Fatahi Moghaddam, M.R. 2013. Diversity of morphological and phenological traits and kernel chemical composition of pistachio genotypes from Feizabad region, Khorasan, Iran. *Seed and Plant Important Journal*, 29(3):405-421.
- AOAC. 1995. *Official Methods of Analysis*, 15th ed. Association of Official Analytical Chemists, Washington D. C.
- Basha, A.I., Padulosi, S., Chabane, K. and Hadj-Hassan, A. 2007. Genetic diversity of Syrian pistachio (*Pistacia vera L.*) varieties evaluated by AFLP Markers. *Genet Resource Crop Evol.*, 54: 1807-1816.
- Chatti, K., Choulak, S., Guenni, K. and Salhi Hannachi, A. 2017. Genetic diversity analysis using morphological parameters in Tunisian pistachio (*Pistacia vera L.*). *Journal of Research in Biological Science*, 2:29-34.
- Galedar, M.N., Jafari, A. and Tabatabaeifar, A. 2008. Some physical properties of wild pistachio (*Pistacia vera L.*) nut and kernel as a function of moisture content. *Int. Agrophysics*, 22: 117-124.
- Ghrab, M., Zribi, F., Chelli-Chaabouni, A., Gouta, H. and Ben-Mioun, M. 2010. Genetic diversity of pistachio in Tunisia. *Option Mediterraneennes*, n.94:221-228.
- Gokce, M.H. and Akcay, M. 1993. Antepfistigiçesitkatalogu (in Turkish with descriptors in English). T.C. Tarım ve Köy İşleri Bakanlığı, Ankara, Turkey, 361(20): P.64.
- Hadj-Hassan, A. 2003. Characterization of fruit species: the case of pistachio spp. In: conservation through sustainable use of fruit genetic resources in Central Asia. IPGRI, Rome, Italy, P: 48-64.
- IPGRI. 1997. *Pistacia vera L. Descriptor*, P. 53.
- Javanshah, A. 2010. Global warming has been affecting some morphological characters of pistachio trees (*Pistacia vera L.*). *African Journal of Agricultural Research*, 5(4): 3394-3401.
- Kardoush, M., Dairy, M.A., Shdeifat, S. and Albashabsheh, N. 2009. Effect of some local pollinators on fruit characteristics of three pistachio cultivars in Aleppo area. *Research Journal of Agriculture and Biological Science*, 5(3): 255-260.
- Kashaninejad, M., Tabil, L.G., Mortazavi, A., Safe Kordi, A., Nakhaei, M. and Nikkho, M. 2002. Effect of drying methods on quality of pistachio nuts. *The Society for engineering in Agricultural, Food, and Biological Systems*, Pp. 1-16.
- Kayimov, A.K., Sultanov, R.A. and Chernova, G.M. 2001. Pistachio in Central Asia. In: towards a comprehensive documentation and use of *Pistacia* genetic diversity in Central and West Asia, North Africa and Europe. Padulosi, S. and Hadj-Hassan, A. (eds.). Report of the IPGRI Workshop, Pp: 49-55.

- Kebour, D., Mekademi, K. and Boutekrabt, A., 2013. Test of a study of phenology of pistachio fruit (*Pistacia vera* L.) in the orchard Tighennif (W. Mascara, Algeria). *Journal of current research in Science*, 1(4): 185-191.
- Misirli, A. and Ozeker, E. 2001. Characterization of some *Pistacia* spp. through phenolic content. In: XI GREMPA Seminar on Pistachios and Almonds, (Ak, E. ed). *Cahiers Options Mediterraneennes*, 56: 223-226.
- Mohsenin, N.N. 1980. *Physical properties of plant and animal materials*. Gordon and Breach Science Publishers. NW, New York, P.742.
- Padulosi, S., Caruso, T. and Barone, E. 1996. *Taxonomy, distribution, conservation and uses of Pistacia genetic resources*. Palermo, Italy. International Plant Genetic Resources Institute, Rome, Italy, P. 69.
- Polat, R., Aydin, C. and Erolak, B. 2007. Some physical and mechanical properties of pistachio nut. *Bug. J. of Agr. Scin.*, 13: 237-246.
- Tunc, E., Celik, M.A. and Gulersoy, A.E. 2013. Investigation of the phenology of pistachio (*Pistacia vera* L.) on different soil types using MODIS NDVI Data. *International Journal of Scientific Research*, 2(12): 231-237.

## OPTIMAL HARVEST DATE OF THE APPLE ROYAL RED CULTIVAR FOR LONG STORAGE IN THE SOUTH OF SYRIA

Bayan M. MUZHER\*, Ola T. ALHALABI

General Commission for Scientific Agricultural Research, Syria

\*Corresponding author:bmuzher@hotmail.com

### Abstract

This investigation was done during 2011-2012 by the General Commission for Scientific Agriculture Research- Pome and Grapevine Division in Sweida province (Syria), to determine the optimal harvest date of the Royal Red apple cultivar for long-term storage. The fruits were harvested five dates in one-week intervals from 20<sup>th</sup> September to 18<sup>th</sup> October, and then stored at 0° c and 95% relative humidity for seven months. The changes in main physical and chemical indicators were measured on monthly basis. The results showed that after 7 months of storage the lowest significant weight loss was 2.2% in the fruits harvested on 11<sup>th</sup> October, while it was 5.1% and 4.3% in the fruits harvested on 20<sup>th</sup> September and 18<sup>th</sup> October, respectively. The highest fruit flesh firmness was 5.4 kg/cm<sup>2</sup> in the fruits harvested on 4<sup>th</sup> October, followed by 5.2 kg/cm<sup>2</sup> firmness in the fruits harvested on 11<sup>th</sup> October and 27<sup>th</sup> September. The highest total soluble solids and total sugars were 18.6°B and 16.7%, respectively, in the fruits harvested on 11<sup>th</sup> October. Consequently, 11<sup>th</sup> October was the best harvest date for the fruits to achieve high storability with the following indicators: temperature accumulation 1943° c. days, 164 days after full bloom, starch index 4, flesh firmness 6.6 kg/cm<sup>2</sup> and total soluble solids 14.5%. These results indicate the importance of determining the harvest date for each cultivar in order to reduce weight loss and improve fruit quality during long storage.

**Key words:** *Apple, long-term storage, harvest date and weight loss.*

### Introduction

Apple is one of the most important fruit trees in Syria, the total area arrived 51574 ha produced 307199 metric tons (Annual agricultural Statistical abstract, 2015). General commission for Scientific Agricultural Researches introduced the main commercially important apple cultivars which evaluated in different climatic regions (Muzher and Alhalabi, 2012). Apples are climacteric fruits need sufficient understanding about the harvest date according to the final purpose of production. Long term storability depends on harvest date, if the fruits picked at late maturity they will not remain for long time even under optimal storage conditions (Vielma *et al.*, 2008; Galmarini *et al.*, 2013). Likewise, Valiuskaite *et al.*, (2006) found that fruit rot raised on fruits which picked at early or late maturity date. On the other hand, fruits that harvested at advanced maturity having short storage life and are more susceptible to mechanical injury, pathogens and physiological disorders (Juan *et al.*, 1999). However, the degree of maturity affected apple fruits quality during shelf life (Juhnevic-Radenkova *et al.*, 2014). Many quality parameters are useful to predict and determine the optimal harvest date in apple fruits like firmness, starch conversion, total soluble solids, and titratable acidity (DeLong *et al.*, 1999; Babojelic *et al.*, 2007). However, growers concentrate on the determination of optimal harvest date which minimize the weight loss, and maximize fruit quality during storage period (Kviklienè *et al.*, 2008). Each apple cultivar should picked



before entering the climacteric period to get optimal quality during the storage period (Little and Holmes 2000). On the other hand, maturity time for the same cultivar may change every year depending on bloom date and the environmental conditions during the growth season (Papamihal, 2013). Since, the taste and flavor are the most important sensory indicators that determine the acceptability of fruits for marketing (Abbott *et al.*, 2004; Abbas *et al.*, 2012). Soliva-Fortuny *et al.*, (2002) suggested that the storability of apple fruits depends on the thickness of wax layer, while Gregersons, (2009) stated that the harvest date depends on chemical composition especially the content of water and sugar.

Apples are the main favorite fruits for consumers in Syria, which led to introduce new competitive commercial cultivars and determine their storability and the changes of quality indicators during storage period. Therefore, the aim of the present investigation was to determine the optimal harvest date for long term storage with good quality parameters for Royal Red apple cultivar depending on efficient physical and chemical indicators.

### Materials and methods

The present research has been conducted during 2011-2012 in the orchards and laboratory at Pome and Grapevine Division which located at 1525m altitude, under rain fed conditions, the mean rainfall 525mm.

#### Plant material

Royal Red apple cultivar: Fruits are conical, dark red, the average weight 205.7 g. Trees are 20 years old grafted on seedling rootstock *Malus domestica* Borkh.

#### Methods

Fruits were picked during five dates in one week intervals from 20<sup>th</sup> September to 18<sup>th</sup> October, which correlated with 143, 150, 157, 164, and 171 days after full blooming (DAFB) and linear temperature accumulation 1750, 1803, 1875, 1943 and 2033°. Days, respectively, then stored at 0° ±0.5 c and 95% relative humidity for seven months. Initial physical and chemical parameters for fruits were achieved at each harvest date and repeated on monthly basis, and the following indicators were studied:

Fruit weight loss%: It was calculated by weighing the same fruits at each interval and at the end of cold storage duration using the following formula:

$$\text{Weight loss (\%)} = [(W_1 - W_2) / W_1] * 100$$

where  $w_1$  is initial weight of fruit samples and  $w_2$  is Weight of fruit samples at each storage periods.

Fruit firmness ( $\text{kg.cm}^{-2}$ ): using penetrometer for 10 fruits from each replicate.

Starch index: using Iodine with potassium iodine solution using 1-8 scale depending on (Blanpied and Silsby, 1992)

Total soluble solids (°Brix ): using digital refractometer (Schwallier, 2005)

Total sugar%: using Fehling solution depending on (Lane and Eynon.1923).

Titrate acidity %: which was determined by titrating fruit juice against 0.1 NaOH with phenol phthalin as indicator and calculated as gram per 100ml Malic acid (Graham,2004)

Experimental design and statistical analysis

Complete randomized block design was used. The analysis of variance to compare means of measured parameters for each indicator during each storage period was done using one way ANOVA by LSD test ( $p < 0.05$ ).

## Results and discussion

### Weight loss

Data in Table (1) showed the effect of harvest date on weight loss percentage during storage period. Generally noticed an increase in weight loss % with the advancement of storage period in all harvest dates which also observed by (Kaur and Dhillon, 2015). After three months of storage period, the second harvest date (27/9) significantly showed the lowest weight loss (0.8%), while the highest significant loss was in the first harvest date (2.2%) due to pick fruits at early date. After seven months of storage, the fourth harvest date (11/10) showed the lowest weight loss% (2.2%) which was in significant with all other harvest dates, while the fifth and first harvest dates revealed the highest significant weight loss% which were (4.3 and 4.2%, respectively) which may due to the fact that fruits were picked at the fifth and the first dates were harvested at late and early maturity dates, which was in agreement with (De Belie *et al.*, 2000, and Kvikliene *et al.*, 2011).

### Fruit firmness

There were no significant variances between all harvest dates at the picked time (0 days). After three months of storage, the first harvest date significantly showed the lowest fruit firmness (4.1Kg. cm<sup>-2</sup>) in the comparison with all other harvest dates, while the second harvest date revealed the highest fruit firmness (6.5Kg. cm<sup>-2</sup>) with significant variance in the comparison with all other harvest dates except the fifth one (6.2 Kg. cm<sup>-2</sup>). After seven months of storage, the first harvest date also significantly showed the lowest fruit firmness (3.6 Kg. cm<sup>-2</sup>) when compared with all other harvest dates, followed by the fifth date ( 4.1 Kg. cm<sup>-2</sup>), while the third one showed the highest fruit firmness with no significant variance with the second and the fourth dates (Table 1). The decrease in fruit firmness might be due to the respiration rate and enzymatic activity (Ganai *et al.*, 2014), and occurs through different stages depending on the increase of readily soluble pectin (Herregods, 1999). However, firmness of qualitative apple should be not lower than 4.4 kg cm<sup>-2</sup> (Kupferman, 1992).

Table 1: Effect of harvest dates on weight loss percentage and firmness during storage period.

Harvest date	Weight loss percentage		Firmness(kg.Cm <sup>-2</sup> )		
	3 months	7 months	0 days	3 months	7 months
20/9	2.2 a	4.2 a	6.6a	4.1 c	3.6 c
27/9	0.8 e	2.9 c	6.6a	6.5 a	5.2 a
4/10	1.4 c	3.5 b	6.6a	6.0 b	5.4 a
11/10	1.3 d	2.2 d	6.6a	5.8 b	5.2 a
18/10	1.6 b	4.3 a	6.3a	6.2 ab	4.1 b
LSD 5%	0.05	0.27	0.37	0.48	0.39

Means in columns having the same letters are not insignificantly different

### Starch conversion

The starch continued broken up in apple fruits with the advancement of harvest date and storage period. The lowest starch index was in the fruits were picked in the first three interval dates (3), while fruits were picked in the fifth date significantly showed the highest starch index (5.6) which was in agreement with (Kvikliene *et al.*, 2006) . Juhnevica- Radenkova *et al.*, (2014) stated that the suitable starch index(1-10) of different type of storage for determination of optimal harvesting time ranged between 4 -5 depending on apple cultivar. After three months starch index increased in all harvest dates and the fifth one showed the highest value (6.3) in significant variance with all other harvest dates except the fourth one (5.7). After seven months starch was broken up in all fruits of all harvest dates (Figure 1). Lopez - Camelo, (2004) reported that apple fruits remain untangled even starch is broken up.

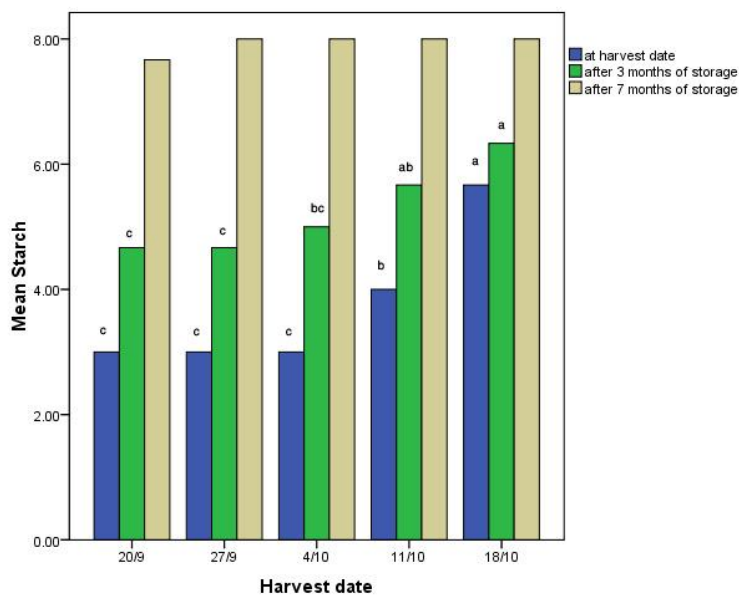


Figure 1: Effect of harvest date on starch conversion during storage period in Royal Red apple fruits. LSD 5% (for 0 days and after three months was 0.49 and 0.9, respectively). (Means above bars in each color having the same letters are not insignificantly different)

#### Total soluble solids (TSS° B )

The harvest date and the storage period affected TSS content in apple fruits. TSS increased with the advancement of harvest date (Table 2). The lowest TSS was found in the first harvest date which was in significant variance with all other harvest dates except the second one. The fifth date which is the latest date revealed the highest TSS (17.2°B) in significant variance with all other harvest dates. After three months of storage the fifth harvest date significantly showed the highest TSS (20.5°B) which indicated that the fruits are at the ripening process due to biochemical changes especially the increase of enzymes responsible of the hydrolysis of starch to soluble sugars (Kaur and Dhillon, 2015). The lowest TSS was in the first harvest date (15.9°B) in significant variance with the fourth and fifth harvest dates, while there were no significant variance between the other harvest dates. After seven months, the fourth one significantly revealed the highest TSS% (18.6°B) in the comparison with all other dates (Table 2). The results revealed a decrease of TSS in the fifth harvest date which related to the fast decline of quality parameters (Kvikliene *et al.* 2011). Our results were in agreement with (Kvikliene *et al.* 2008) which found that the TSS decreased after 90 days of storage in fruits that picked at late maturity.

#### Total sugars% (TS%)

The rate of total sugar increased with the advancement of harvest date (Table 2). The picked fruits at the fifth date significantly revealed the highest TS% (15.5%), while the first one showed the lowest TS% (12.3%). After three months, continually the fifth harvest date revealed the highest TS% (17.5%) in significant variance with all other dates, while the first one revealed the lowest TS% (14.3%) in significant variance with the fourth date (15.5%). After seven months, the fourth harvest date significantly revealed the highest TS% (16.7%). The increase of TS% may be due to the hydrolysis of insoluble polysaccharide into simple sugar (Wijewardane and Guleria, 2013).

#### Titrateable acidity% (TA%)

The results showed the decrease of TA% with the advancement of harvest dates and with the storage period (Table 2). Fruits that picked at the first date significantly revealed the highest TA% (0.36%), while fruits that picked at the fifth harvest date showed the lowest TA%

(0.23%) in significant variance with all other dates except the fourth one. Titratable acidity considered as an efficient tool in predicting taste of apples and in the assessment of fruit quality (Harker *et al.*, 2002). After three months of storage TA% was decreased in all harvested dates except the second one which significantly revealed the highest TA% (0.30%), followed by the first date (0.26%). After seven months of storage, TA% continued the decreasing in all harvest dates except the fourth one and all harvested dates showed the same TA% (0.20%) except the fifth one which significantly revealed the lowest TA% (0.16%). The decrease of TA% in fruits might be due to the diminishing of their organic acids as respiratory substrates during storage (Keditsu *et al.*, 2003; Wijewardane, 2013).

Table2: Effect of the harvest date on TSS, TS and TA in Royal Red apple cultivar during storage period

Harvest date	TSS (°B)			TS%			TA%		
	0days	3 months	7months	0 days	3months	7months	0 days	3months	7 months
20/9	13.7d	15.9c	16.6c	12.3d	14.3c	14.9c	0.36a	0.26b	0.20a
27/9	14.3cd	16.3bc	17.5b	12.8cd	14.7bc	15.3bc	0.30b	0.30a	0.20a
4/10	14.5c	16.7bc	16.5c	13.1c	15bc	14.9c	0.28bc	0.23bc	0.20a
11/10	15.5b	17.2b	18.6a	13.9b	15.5b	16.7a	0.26cd	0.20c	0.20a
18/10	17.2a	20.5a	17.6b	15.5a	17.5a	15.6b	0.23d	0.20c	0.16b
LSD 5%	0.73	1.04	0.46	0.66	0.9	0.41	0.03	0.03	0.03

Means in columns having the same letters are not insignificantly different

### Conclusion

Obtained results based on the physicochemical parameters during storage period indicate that the optimal harvest date for Royal red apple cultivar which picked for long term storage is at 164 days after full blooming which correlated with the linear temperature accumulation 1943°c. days, with starch index 4, flesh firmness 6.6 kg/cm<sup>2</sup> and total soluble solids 14.5%. These results indicate the importance of determining the harvest date for each commercial cultivar.

### References

- Abbas, M. M., Mohar, T. A. and Shabbir, K. 2012. Performance of apple varieties under climatic conditions of Murree Hills. *J. Agric. Res.*, 50(3): 393-401.
- Abbott, J.A., Saftner, R. A., Gross, K. C., Vinyard, B. T. and Janick, J. 2004. Consumer evaluation and quality measurement of fresh-cut slices of ‘Fuji, Golden Delicious, GoldRush, and Granny Smith’ apples. *Postharv. Biol. and Techn.* 33: 127–140.
- Annual agricultural statistical abstract. 2015. Ministry of agriculture and agrarian reform. Damascus. Syria.
- Babojelic, M. S., Ivancic., K., Druzic, J., Kovac, A. and Voca, S. 2007. Chemical and sensory characteristics of three apple cultivars (*Malus x domestica* Borkh.). *Agriculturae Conspectus Scientificus* , 72 (4): 317-322.
- Blanpied, G.D. and Silsby, K.J. 1992. Predicting harvest date windows for apples. *Cornell Cooperative Extension Information Bulletin* 221, 12 pp.
- De Belie, N., Shotte, S., Lammertyn, J., Nicolai, B. and De Baerdemaeker, J. 2000. Firmness changes of pear fruit before and after harvest with the acoustic impulse response technique. *J Arg. Eng Res.* 77:183–191.
- DeLong J. M., Prange R. K., Harison P. A., Shofield R. A. and DeEll J. R. 1999. Using the Streif index as a final harvest window for controlled-atmosphere storage apples. *Hort. Science*, 34(7): 1251-1255.

- Ganai, S. A., Ahsan, H., Rather, A.H., Imtiyaz A., Wani, A., Lone, A. Iqbal, J.Q., Amin, A. and Wani, S. M.2014. Effect of harvest maturity and postharvest treatments on some chemical parameters of apple cv. Red delicious. *Int. J. Adv. Res.*, 2(8): 25–33.
- Galmarini, M. V., Symoneaux, R., Chollet, S. and Zamora M.C. 2013. Understanding apple consumers expectations in terms of likes and dislikes: use of comment analysis in a cross-cultural study. *Appetite*, No. 62, p. 27–36.
- Graham, O. S., Wichham, L. D. and M. Mohammed (2004). Growth, development and quality attributes of miniature golden apple fruit. *Food, Agriculture & Environment* Vol. 2 (1): 90-94.
- Gregersons J. (2009) Apples. Shelf Life Advice. <http://shelflifeadvice.com/fruit/fresh-fruit/apples>.
- Harker, F.R., Marsh, K.B., Young, H., Murray, S.H., Gunson, F.A. and Walker, S.B. (2002). Sensory interpretation of instrumental measurements 2: sweet and acid taste of apple fruit. *Postharvest Biology and Technology*. 24:241-250.
- Herregods, M. 1999. CA - storage of fruits and vegetables. In: *Post-harvest losses of perishable horticultural products in the Mediterranean region*. Chania: CIHEAM, 3-9.
- Juhneva- Radenkova, K., Skudra, L., Skrivele, M., Radenkovs, V. and Seglina, D. 2014. Impact of the degree of maturity on apple quality during the shelf life. *Foodbalt*, 161-166.
- Juan, J. L., Frances, J., Montesinos, E., Camps, F. and Bonany, J.1999. Effect of harvest date on quality and decay losses after cold storage of “Golden Delicious” apple in Girona, Spain. *Acta Hort.* 485:195–202.
- Kaur, K. and Dhillon, W. S. 2015. Influence of maturity and storage period on physical and biochemical characteristics of pear during post cold storage at ambient conditions. *J Food Sci Technol*. 52(8): 5352–5356.
- Keditsu, S. E., Smith, S.T. and Gomez, J. 2003. Effect on ethanol vapor treatments on light rown apple. *Postharvest Biology and Technology*, 18: 268-278.
- Kvikliene N., Kviklys, D., Valiuskaite, A. and Viskelis P. 2006. Changes in fruit quality during ripening and storage in the apple cultivar "Auksis". *Journal of Fruit and Ornamental Plant Research*. 14(2): 195-202.
- Kvikliene, N., Kviklys, D., Lanauskas, J. and Uselis, N. 2008. Harvest time effect on quality changes of apple cultivar ‘Alva’ during ripening and storage. *Sodininkystė ir daržininkystė*, 27(1): 3–8.
- Kvikliene, N., Kviklys, D., Valiuskaite, A., Viskelis, P., Uselis, N., Lanauskas, J. and Buskiene, L.2011. Effect of harvest date on fruit maturity, quality and storability of ‘Lodel’ apples. *J Food Agric Environ*. 9:210–213.
- Kupferman, E.1992. Retaining the firmness of apples in storage. *Tree Fruit Postharvest Journal*, 3: 4–6.
- Lane, J. H. and L., Eynon (1923). Determination of reducing sugars by means of Fehling's solution with methylene blue as internal indicator. *J. Soc. Chem. Ind. Trans*. 32-36.
- Little, C.R. and Holmes, R.J. 2000. Storage technology of apples and pears. Department of Natural Resources and Environment, Knoxfield, Victoria, Australia.
- Lopez- Camelo, A. F. 2004. Manual for the preparation and sale of fruits and vegetables. From field to market. Instituto Nacional de Tecnología Agropecuaria Estación Experimental Agropecuaria, 1: 11–26.
- Muzher, B. M. and Al-Halabi,O.T. 2012. Evaluation of the most important apple varieties in Syria. *Damascus university journal for the agricultural sciences*, 28(1): 65-76.
- Papamihal, D. 2013. Assessment of some maturity indicators and fruit growth in three apple cultivars. The 1st International Conference on “Research and Education – Challenges Towards the Future” (ICRAE2013), 1- 10.

- Schwallier, P., Brown, A. and D. Ruwersma (2005). MSU Fruit Team Apple Maturity Report. Grand Rapids Area Report Number 7. Michigan State University Extension.
- Soliva-Fortuny, R., Oms-Oliu G. and Martin-Belloso, O. 2002. Effects of ripeness stages on the storage atmosphere, color and textural properties of minimally processed apple slices. *Journal of the Science of Food and Agriculture*, 67: 1958–1962.
- Valiuskaite, A., Kvikliene N., Kviklys, D. and Lanauskas, J. 2006. Post-harvest fruit rot incidence depending on apple maturity. *Agronomy research*,4: 427-431.
- Vielma, M. S., Matta, F. B. and Silval, J. L. 2008. Optimal harvest time of various apple cultivars grown in Northern Mississippi. *Journal of the American Pomological Society* 62(1) 13- 22.
- Wijewardane, R. M. N. A. 2013. Application of Polysaccharide Based Composite Film Wax Coating for Shelf Life Extension of Guava (var. Bangkok Giant). *Journal of Postharvest Technology*, 1 (1): 16-21.
- Wijewardane, R.M.N.A. and Guleria, S.P.S. 2013. Effect of pre-cooling, fruit coating and packaging on postharvest quality of apple. *Journal of Food Science and Technology*, 50 (2): 325-331.

## EFFECT OF A MAGNETIC TREATMENT OF SALT WATER ON SEED GERMINATION

Hsan Youssef MEHDAOUI<sup>1\*</sup>, Manuela Roldão OLIVEIRA<sup>2</sup>, Monem KALLEL<sup>1</sup>

<sup>1</sup>Laboratory of Environmental Engineering and EcoTechnology (GEET), National School of Engineers of Sfax, University of Sfax, Tunisia

<sup>2</sup>Instituto Nacional de Investigação Agrária e Veterinária, I.P., 2784,505, Portugal

\*Corresponding author: hsanyoussefmahdoui@outlook.fr

### Abstract

A magnetic treatment of water is an innovative technology in the field of agriculture. Hence, a study was run to evaluate the impact of magnetized salt waters on seeds germination (tomato, corn and turnip). A comparison was made for germination percentage (%) and root length (mm) between the treatments and the control. In addition, the effect of the magnetic treatment on water properties was investigated. A magnetic treatment device (MTD) with a magnetic field of 13.5 mT was used. Three ranges of salinity (2.1 g/L; 4.2 g/L and 6.6 g/L) were used in addition to distilled water as a reference. The results showed a decrease in the electrical conductivity values after passing the water samples through the MTD. The pH showed an increasing tendency that stabilized after 24 hours. The germination percentage (%) and root length (mm) were higher than in the control group for the different ranges of salinity, for all the seeds. Corn germination under the magnetized salt water of 4.2 g/L showed the highest ratio, reaching 28% higher than control. The best root development was observed in the tomato seeds with 24% longer, always with the magnetized salt water of 4.2 g/L comparing to control. In conclusion, our study shows that a magnetic treatment improves the germination ratio and root length of seeds.

**Keywords:** *Magnetic Water Treatment, Salt Water, Germination, Root Length, Seeds.*

### Introduction

The scarcity of water is a major problem in many countries of the world. Farmers in arid and semi-arid areas don't only suffer from the lack of water quantities, but also from its poor quality in particular the high level of salinity. The magnetic treatment of irrigation water, which was developed during the last two decades, could be a partial solution to this problem.

This novel technology is known to be an eco-friendly and non-expensive (Otsuka and Ozeki, 2006). Review of literature suggests that water can be magnetized when exposed to a magnetic field (Maffei, 2014). After magnetization, water pH increase slightly while its electrical conductivity and total dissolved salts decrease (U. *et al.*, 2016). This technology enhance evaporation ratio (Guo *et al.*, 2012) (Holysz *et al.*, 2007) and the viscosity of treated waters (Cai *et al.*, 2009). It reduce the scale deposit (Calcite deposit) according to many authors (Latva *et al.*, 2016) (Mahmoud *et al.*, 2016) (Myśliwiec *et al.*, 2016).

In addition to its direct effects on the water itself, the irrigation with magnetized water shows higher productivity and a positive impact on plants growth (Maheshwari and Grewal, 2009) as well as on seed germination percentage (De Souza *et al.*, 2006) and roots development (Iqbal *et al.*, 2016).

In the current study, we will evaluate the effect of magnetization on some chemical characteristics of natural salt water with different ranges of salinity, then evaluate the productivity of those magnetized water to enhance seed germination.

## Material and Methods

The magnetic Treatment Device (MTD) used for this experiment is made of stainless steel with a power of 13.5mT. The water must pass in the direction indicated previously by the manufacturer in order to guarantee its magnetization.

Three different waters with 3.02, 5.83 and 8.65 mS/cm of salinity were used during the experiment. All waters were brought from farms located in the agricultural zone of Menzel Chaker, Sfax, Tunisia.

The experiment took place in the laboratory of Environmental Engineering and EcoTechnology (GEET) at the National School of Engineers of Sfax, Sfax, Tunisia.

In germination test were used seeds of tomato (Rio grande), turnip (turnip guebsi) and corn (commun corn), all bought from a local supplier recognized by the ministry of agriculture and water resources of Tunisia. For each experiment, 100 seeds were used. In each petri dish, we put 3 layers of filter paper, 10 seeds than 5 ml of the water. Seeds were grown in the dark, at constant temperature (25°C) and humidity (100%) for 7 days, at the end of which the germination percentage and the length of roots were determined.

Electrical Conductivity and pH was measured according to the NF T 90-008.

The analyses of the element  $Ca^{2+}$  and  $Mg^{2+}$  was laid out according to the NF EN ISO 7980. NF T90-005 and those of the  $Na^{+}$  and  $K^{+}$  were according to the NF T90-020.and the concentration determined by atomic absorption spectrometry.

## Results and Discussion

After passing through the magnetic treatment device, we don't observe any significant change on the chemical characteristics of the water (Table 1) for the three ranges of salinity used. The exception concerns the pH and the electrical conductivity values. For all waters, pH value (Fig.1) shows a slight increase that is maintained for 24 hours after the treatment. Whereas, the electrical conductivity (Fig.2) decreased 9%, 2.5% and 1.7% for the magnetized waters in salinity W1, W2 and W3 respectively and the effect was permanent for the same time interval as indicated for the pH. We suggest that the magnetic field don't change the chemical characteristics of water, but work on the physical properties of the water and its molecules arrangement as it was explained by (Toledo et al., 2008).

Table 3. Chemical characteristics of the irrigation water. W1 (3.02mS/cm), W2 (5.83 mS/cm), W3 (8.65mS/cm); NM-non magnetized; M -magnetized.

	W1		W2		W3	
	NM	M	NM	M	NM	M
pH	7.16	7.40	6.65	6.82	6.91	7.10
EC (mS/cm)	3.02	2.73	5.83	5.68	8.65	8.50
$Ca^{2+}$ (meq/L)	7.4	7.4	30.05	30.05	32.05	32.05
$Mg^{2+}$ (meq/L)	0.039	0.035	0.028	0.030	0.035	0.04
$Na^{+}$ (meq/L)	3.64	3.63	4.04	3.43	4.77	4.80
$K^{+}$ (meq/L)	1.53	1.51	1.26	1.25	1.48	1.47
$Cl^{-}$ (meq/L)	15.25	14.68	18.07	18.07	47.45	47.45
$SO_4^{-}$ (meq/L)	10.41	10	51.66	51.66	48.75	48.75
SAR	1.887	1.882	1.041	0.884	1.19	1.198



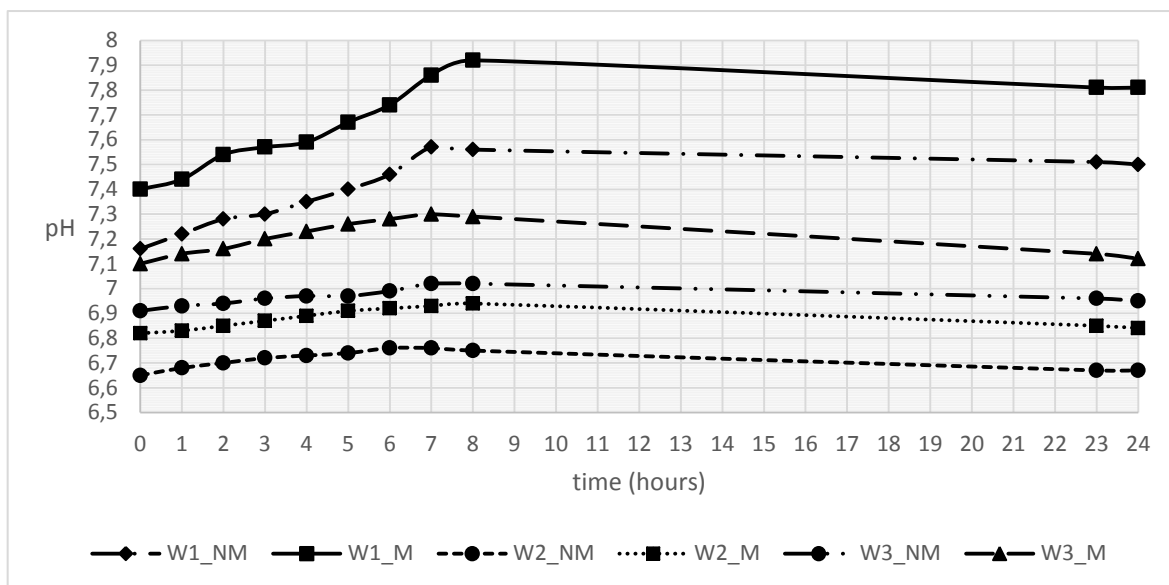


Figure 4. Effect of the magnetic treatment on the water pH

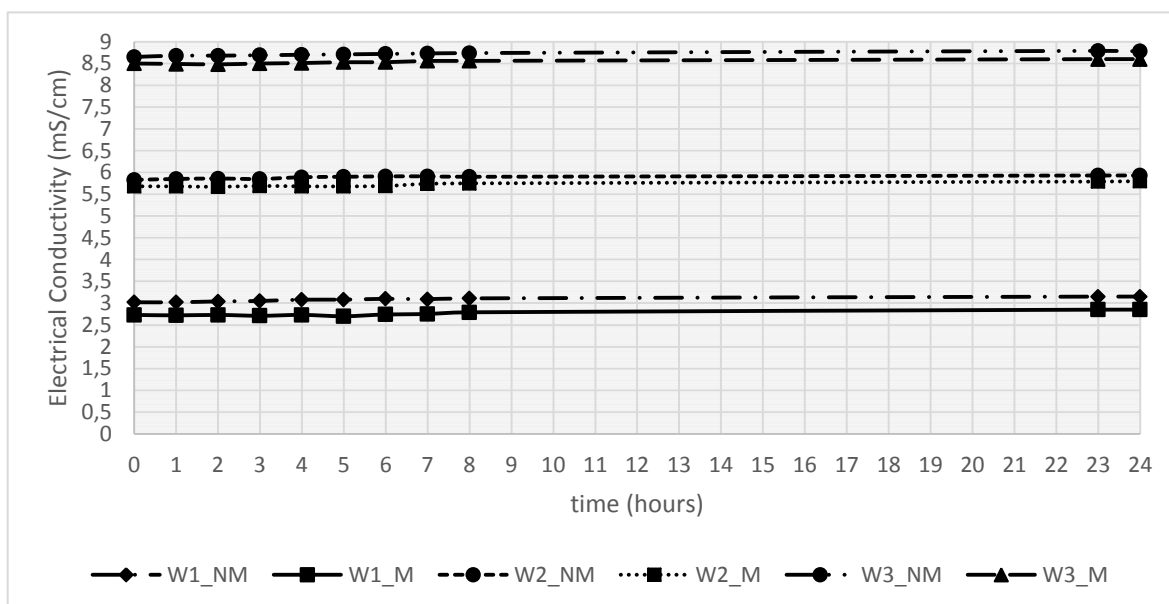


Figure 5. Effect of the magnetic treatment on the electrical conductivity of water

## Germination

From Fig.3 is possible to see that salinity did not affect germination of turnip and corn and that magnetized water improved germination in both species. Germination of turnip seeds with magnetized water was increased by 11.6%, 5.7% and 7.1% for salinity W1, W2 and W3 respectively. Turnips are more salt tolerant at germination than at subsequent stages of growth. Francois (1984) found that salinity level of 11.6 dS/m had no effect on final germination percentage. Tomato and corn are moderately sensitive to salinity and tolerance to salt level exists among genotypes (Singh *et al.*, 2012). Tomato was the specie that presented lower values of germination with the salinity. However, for the same salinity level, the magnetization of the water caused increases of 15.1%, 16.7% and 17.9% in the germination percentage. Salinity did not affect germination of maize seeds and, as for the other two species, germination increased by 9.9%, 27.9% and 20.9%, respectively, in W1, W2 and W3 salinities with magnetized water.

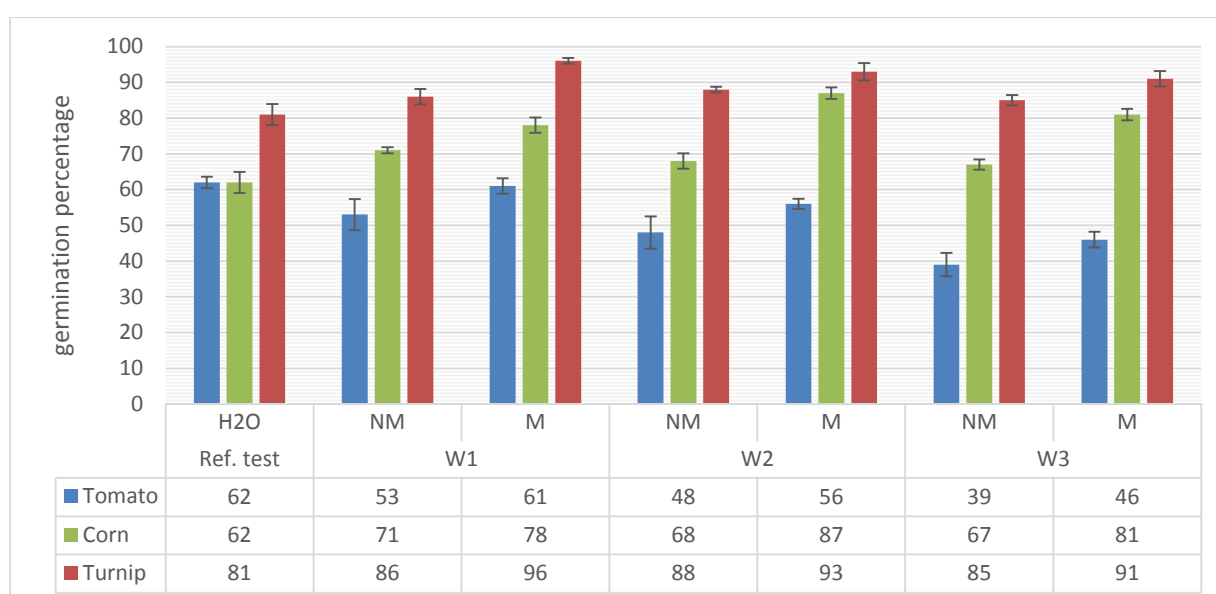


Figure 6. Effect of three levels of salinity (W1, W2, W3), non-magnetized (NM) and magnetized (M) water on seed germination of tomato, turnip and corn

## Roots length

Length of root provides an important clue to the response of plants to salinity. Turnip was the specie that presented longer roots in all saline levels (Fig.4) and with increments of 10.5%, 4% and 5.6% with magnetized water. Growth of tomato roots was affected only in higher salinity (W3-8.65 mS/cm) while corn roots show a decrease in growth from W2 (5.63 mS/cm). In tomato, root length increased by 15.2%, 24.07% and 14.73% and in maize increased by 5.7%, 8.4% and 23.7%, respectively, in W1, W2 and W3 salinities with magnetized water.

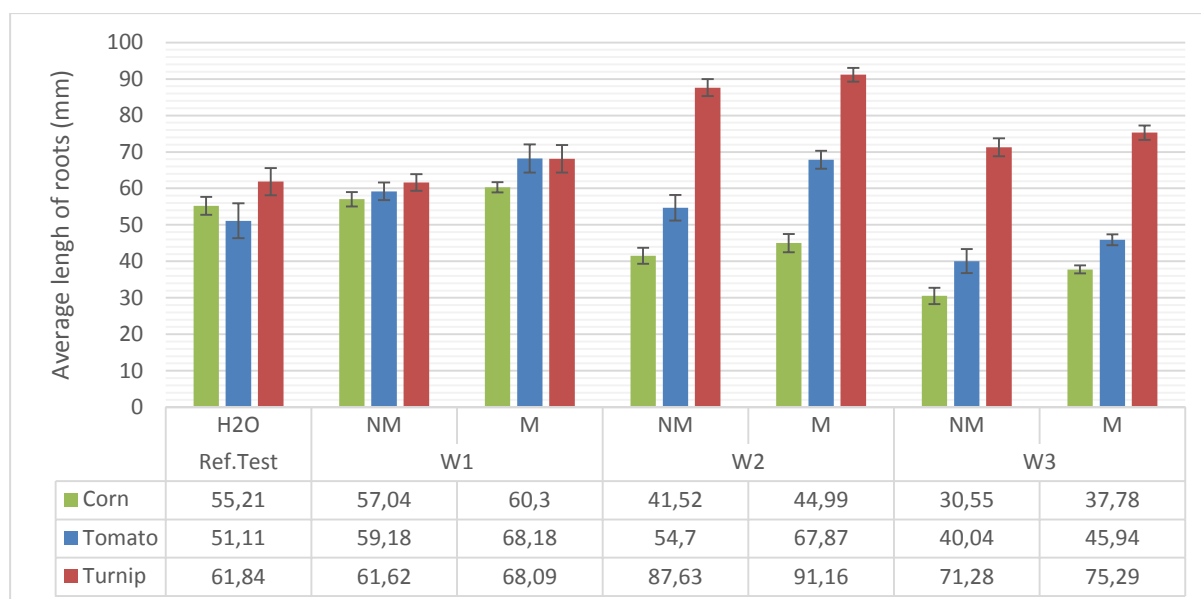


Figure 4. Effect of three levels of salinity (W1, W2, W3), non-magnetized (NM) and magnetized (M) water on root length of tomato, turnip and corn

### Conclusions

The results showed that after passing water samples through Magnetic Treatment Device, its pH presented a tend to increase, while the electrical conductivity decreased compared to normal water. Those magnetized salt waters overcome the deleterious effects of salinity and enhanced the germination percentage for the three chosen seeds as well as the length of root. Those results encourage us to conduct more research under greenhouse and in the farms. More investigations shall be done concerning the effect of magnetic field on the physical characteristics of water as well as in other physiological parameters.

### References

- Cai, R., Yang, H., He, J., Zhu, W., 2009. The effects of magnetic fields on water molecular hydrogen bonds. *J. Mol. Struct.* 938, 15–19. doi:10.1016/j.molstruc.2009.08.037
- De Souza, A., Garcí, D., Sueiro, L., Gilart, F., Porras, E., Licea, L., 2006. Pre-sowing magnetic treatments of tomato seeds increase the growth and yield of plants. *Bioelectromagnetics* 27, 247–257. doi:10.1002/bem.20206
- Francois, L.E., 1984. Salinity effects on germination, growth and yield of turnip. *HortScience* 19, 82-84.
- Guo, Y.-Z., Yin, D.-C., Cao, H.-L., Shi, J.-Y., Zhang, C.-Y., Liu, Y.-M., Huang, H.-H., Liu, Y., Wang, Y., Guo, W.-H., Qian, A.-R., Shang, P., 2012. Evaporation Rate of Water as a Function of a Magnetic Field and Field Gradient. *Int. J. Mol. Sci.* 13, 16916–16928. doi:10.3390/ijms131216916
- Holysz, L., Szczes, A., Chibowski, E., 2007. Effects of a static magnetic field on water and electrolyte solutions. *J. Colloid Interface Sci.* 316, 996–1002. doi:10.1016/j.jcis.2007.08.026
- Iqbal, M., ul Haq, Z., Malik, A., Ayoub, C.M., Jamil, Y., Nisar, J., 2016. Pre-sowing seed magnetic field stimulation: A good option to enhance bitter melon germination, seedling growth and yield characteristics. *Biocatal. Agric. Biotechnol.* 5, 30–37. doi:10.1016/j.bcab.2015.12.002

- Latva, M., Inkinen, J., Rämö, J., Kaunisto, T., Mäkinen, R., Ahonen, M., Matilainen, J., Pehkonen, S., 2016. Studies on the magnetic water treatment in new pilot scale drinking water system and in old existing real-life water system. *J. Water Process Eng.* 9, 215–224. doi:10.1016/j.jwpe.2016.01.009
- Maffei, M.E., 2014. Magnetic field effects on plant growth, development, and evolution. *Front. Plant Sci.* 5. doi:10.3389/fpls.2014.00445
- Maheshwari, B.L., Grewal, H.S., 2009. Magnetic treatment of irrigation water: Its effects on vegetable crop yield and water productivity. *Agric. Water Manag.* 96, 1229–1236. doi:10.1016/j.agwat.2009.03.016
- Mahmoud, B., Yosra, M., Nadia, A., 2016. Effects of magnetic treatment on scaling power of hard waters. *Sep. Purif. Technol.* 171, 88–92. doi:10.1016/j.seppur.2016.07.027
- Myśliwiec, D., Szcześ, A., Chibowski, S., 2016. Influence of static magnetic field on the kinetics of calcium carbonate formation. *J. Ind. Eng. Chem.* 35, 400–407. doi:10.1016/j.jiec.2016.01.026
- Otsuka, I., Ozeki, S., 2006. Does Magnetic Treatment of Water Change Its Properties? *J. Phys. Chem. B* 110, 1509–1512. doi:10.1021/jp056198x
- Singh, J., Sastry, E.V.D., Singh, V., 2012. Effect of salinity on tomato (*Lycopersicon esculentum* Mill.) during seed germination stage. *Physiol. Mol. Biol. Plants*, 18(1):45–50.
- Toledo, E.J.L., Ramalho, T.C., Magriotis, Z.M., 2008. Influence of magnetic field on physical–chemical properties of the liquid water: Insights from experimental and theoretical models. *J. Mol. Struct.* 888, 409–415. doi:10.1016/j.molstruc.2008.01.010
- U., S., O., S., E.J., J., 2016. The impacts of magnetic treatment of irrigation water on plant, water and soil characteristics. *Agric. Water Manag.* 178, 21–29. doi:10.1016/j.agwat.2016.08.016

## SEED PROPERTIES OF HAWTHORN (*Crateagus* sp.) SPECIES AND EFFECTS OF SULFURIC ACID PRETREATMENTS ON SEED COAT THICKNESS

Askin GOKTURK\*<sup>1</sup>, Sinan GUNER<sup>1</sup>, Ferhat YILDIRIM<sup>2</sup>

<sup>1</sup>Artvin Coruh University, Faculty of Forestry, Forest Engineering Department, 08000 Artvin, Turkey

<sup>2</sup>Artvin Coruh University, Institute of Science, 08000 Artvin, Turkey

\*Corresponding author: agokturk@artvin.edu.tr

### Abstract

The aim of the study was to determine of some seed properties and the effect of sulfuric acid pretreatments on the seed coat thickness of *Crataegus microphylla* (C. Koch.), *C. monogyna* (Jacq.), *C. orientalis* (Palas. Ex. Bieb.), *C. pontica* (C. Koch) and *C. pseudoheterophylla* (Pojark.) seeds. For this purpose, seed weight, size, moisture contents and coat thickness of seeds were considered as seed properties. Ripe fruits of the species were collected from wild plants growing in Artvin province (Turkey) in October 2016. Identification of seed properties and experiments were performed in May 2017. The seed coat thicknesses were measured from the thinnest and thickest part of the seeds. The seeds were kept in sulfuric acid for 1 - 5 hours to determine scarification rates. The diameters and lengths of the seeds were also measured before and after the acid pretreatment. As a result of the study, it was determined that seed properties of *Crataegus* species varied significantly and of acid pretreatment durations affected seed coat thicknesses at different rates. The seed coat thickness of the thinnest part of seed changed between 0.82 (*C. orientalis*) and 1.63 mm (*C. pseudoheterophylla*). Species with the largest seed diameter were *C. pontica* and *C. pseudoheterophylla* (5.81 and 6.56 mm, respectively) and the species with smallest diameter was *C. orientalis* (3.48 mm). While the seed diameters pretreated with one hour sulfuric acid scarified by 4.68%, seed diameters pretreated with five hours sulfuric acid scarified by 10.04%. The most affected seeds by acid scarification belong to *C. orientalis* and the least affected seeds belong to *C. pontica*. It has been also determined that even though *C. orientalis* have the lowest seed weight (8.88 g) and the least seed size (3.47-6.36 mm) among the hawthorn species, it is one of the species which has highest (8.98%) moisture content.

**Key words:** Hawthorn seeds, seed weight, seed size, moisture content, coat thickness, sulfuric acid, scarification rate.

### Introduction

Hawthorn trees (*Crataegus* spp.) are tolerated to extreme edaphic and climatic conditions in which they grow. Because of this adaptation, hawthorn trees can be found in even the midst of steppe or high altitude pasture of mountains (Gultekin et al., 2005). In addition, they have important usage areas such as in medicine and pharmacology. Hawthorn trees also provide a major food source not only for humans but also for wildlife due to their nutritional value.

Despite their mentioned importance, seedling production efforts have not been successful because of the difficulties in germination of their seeds. Seed dormancies blocks the germination process despite the presence of favorable environmental conditions, and is one of the factors that negatively affect the growth of the greatest number of high-quality seedlings in the shortest amount of time (Yahyaoglu and Olmez, 2005).

Seed dormancies are classified as external, internal, secondary and combined inhibitors. External germination inhibitors, due to the seed coat, occurs when the seed coat limits or blocks the passage of water and gas (physical), the seed coat mechanically blocks the growth

of the embryo (mechanical), or the presence of certain chemicals in the seed coat inhibit germination (chemical). Internal seed dormancy or embryonic seed dormancy occurs when there are inhibiting substances present in the embryo and in the nutritional tissue surrounding the embryo, resulting in an undeveloped embryo when the seed disintegrates or at the time it is picked (Bonner and Vozzo, 1987; Tilki 2005; Guner and Tilki 2009). The aforementioned seed dormancies vary among different varieties and seed sources or within seed sources of a given species as well as seed harvest time and among individuals (Wolf and Kamondo, 1993; Poulsen, 1996).

Warm or cold wet stratification is recommended to eliminate seed dormancy from fruit meat and endosperm. The most commonly used method is to fold the seeds in a humid, low temperature environment in a given period (Genc, M., 2005). Chemical scarification in sulfuric acid is recommended to prevent seed dormancy due to the seed coat.

Seed dormancy resulting from the water scarcity and gas movement through the thick and hard seed coat and the underdevelopment of the embryo (Hartmann et al., 1997; Gokturk and Yilmaz, 2015). As a result, stratification and sulfuric acid scarification methods need to be carried out together for an extended period to eliminate seed dormancy (Yahyaoglu et al., 2006). The length of the sulfuric acid pretreatment period varies due to differences in seed coat thickness among hawthorn species (Lasseigne and Blazich, 2003; St. John, 1982). For example while the species of *C. phaenopyrum* can germinate very easily due to its very thin seed coat (Brinkman, 1974; Dirr and Heuser 1987; Bir, 1992; Lasseigne and Blazich, 2003), it is recommended that hawthorn species such as *C. monogyna*, *C. douglassii* with thick seed coats be treated with an acid scarification process for periods ranging from 30 mins to 480 mins prior to other pretreatments (Dirr and Heuser, 1987; Lasseigne and Blazich, 2003).

*Crataegus microphylla* (C. Koch.), *C. monogyna* (Jacq.), *C. orientalis* (Palas. Ex. Bieb.), *C. pontica* (C. Koch) and *C. pseudoheterophylla* (Pojark.) species have natural distribution in Artvin (Turkey) region (Gokturk et al., 2006).

The objectives of this study are i) determination of some seed properties, ii) determination of sulfuric acid pretreatment effects on seed coat thickness of *Crataegus* species

### Materials and methods

In this study, five *Crataegus* species naturally growing in Artvin region, located in the northeastern part of Turkey including *C. microphylla* (C. Koch.), *C. monogyna* (Jacq.), *C. orientalis* (Palas. Ex. Bieb.), *C. pontica* (C. Koch) and *C. pseudoheterophylla* (Pojark.) were sampled to obtain seeds and fruits. Ripe fruits of the species were collected from wild plants in October 2016. The seeds were separated from the fruit material, rinsed in tap water, dried in the shade, and stored at  $4 \pm 1$  °C in plastic bags. Identification of seed properties and the experiments to determine the scarification rates of seed coat by sulfuric acid were performed at Artvin Coruh University Seed and Afforestation Laboratory in May 2017.

Seed properties including diameter, length, seed weight (100 seeds), moisture content and coat thickness were measured. Digital caliper was used to measure diameter, length and coat thickness of seeds. In order to measure the seed thickness, seeds were pressed in a clamp and then seeds were filed with sandpaper by using honing machine until half of the seed length was reached. A hundred seeds per species were used in this process. After sandpapering process, it was observed that seed thickness was not uniform. Therefore, coat thickness was measured separately at points where the seed coat was the thickest and the thinnest. These measurements were recorded as thick and thin coat thickness.

By determining seeds weight, average weight of 8 samples ( $\bar{X}$ ), each is consisting of 100-seed, was used (ISTA, 1993). 10 seeds with 4-replication were used to determine moisture content of seeds. Seed samples were placed in a dry oven and dried at 105°C for 24 hours

after which they were weighed and recorded. Moisture content was calculated after dry weights of the seeds were measured by the following formula:

$MC = ((IW - DW) / IW) \times 100$ , where MC is moisture content, IW is initial weight and DW is dry weight.

30 seeds with 4-replication per species were kept in sulfuric acid for 1 to 5 hours periods to determine the scarification rates. The diameter and the length of seeds were measured both prior to being placed in sulfuric acid and after being removed and rinsed with water. Seed diameter was measured in two directions perpendicular to each other and the average of these measurements was recorded as the diameter value. The following formulas were used to calculate scarification rates of seed diameter (Sd) and length (Sl):

$$SRD: (Sd_b - (Sd_b - Sd_a)) * 100 / Sd_b \qquad \qquad \qquad SRL: (Sl_b - (Sl_b - Sl_a)) * 100 / Sl_b$$

where SRD is the scarification rate on seed diameter, SRL is the scarification rate on seed length,  $Sd_b$  and  $Sl_b$  are root diameter and length before being treated with sulfuric acid, and  $Sd_a$  and  $Sl_a$  are root diameter and length values after scarification in sulfuric acid.

One-way ANOVA was used to identify the interspecies differences in seed properties and the Duncan test was used to determine which species differed significantly. Multiple ANOVA was used to identify the effect of treatment period and species on scarification rates.

### Results and discussion

It was observed significant differences ( $\alpha < 0.05$ ) in the diameter, length, weight, moisture content and coat thickness of seeds among *Crataegus* species. *C. orientalis* had the smallest seed diameter and length as 3.48 mm and 6.37 mm respectively; and *C. pseudoheterophylla* had the largest seed diameter and length as 6.56 mm and 8.38 mm respectively (Table 1).

Interspecific differences in coat thickness found in this study are similar to those found by Lasseigne and Blazich (2003) and St. John (1982). Coat thickness varied not only among species but also within species. In this study, variability of seed coat thickness was observed even on the same seed. *C. orientalis* had the smallest coat thickness (0.82 mm) and *C. pontica* had the greatest coat thickness (1.63 mm) at the thinnest part of the seed coats. *C. orientalis* possessed the smallest seed weight (8.88 g) and the highest moisture content (8.98%) while having the thinnest coat thickness.

Table 1. Seed characteristics of the hawthorn species

Species	Diameter (mm)	Length (mm)	Seed weight (g/100 seeds)	Thin coat (mm)	Thick coat (mm)	Moisture content (%)
<i>C. microphylla</i>	4,87 b*	8,00 c	11,71 b	1,11 c	1,79 a	6,02 a
<i>C. monogyna</i>	5,35 c	7,78 b	13,79 c	1,00 b	2,30 c	8,57 b
<i>C. orientalis</i>	3,48 a	6,37 a	8,88 a	0,82 a	2,12 b	8,98 c
<i>C. pontica</i>	5,81 d	8,26 d	20,09 d	0,90 ab	2,96 e	9,03 c
<i>C. pseudoheterophylla</i>	6,56 e	8,38 d	22,21 e	1,63 d	2,74 d	6,12 a

\*The letters in a given column indicate significant differences among species

It was observed that the scarification rates in both the diameter and the length of seeds increased in all species, as the duration in sulfuric acid increased (Figure 1, Table 2). Similar results were also obtained in species-level evaluations. Change in seed diameter due to scarification was the greatest in *C. orientalis* (8.67%) and the smallest in *C. pontica* (5.90%). Change in seed length due to scarification was the greatest in *C. microphylla*, 12.03% and the smallest in *C. pontica*, 4.60% (Figure 2).

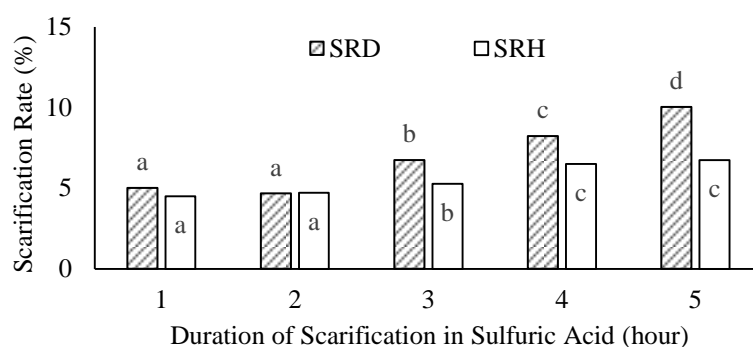


Figure 1. Scarification rates in seed diameter (SRD) and length (SRL) due to duration of scarification in sulfuric acid.

Table 2. Scarification rates in seed diameter and length among species due to duration of scarification in sulfuric acid.

Species	SRD/H (%)	Duration (Hour)				
		1	2	3	4	5
<i>C. microphylla</i>	SRD	1,36 a*	4,45 b	2,09 a	10,55 c	11,13 c
	SRL	9,57 a	11,25 b	11,97 b	15,81 c	11,53 b
<i>C. monogyna</i>	SRD	6,09 a	6,73 ab	6,29 a	7,29 c	9,01 d
	SRL	6,18 ab	6,02 a	5,96 a	6,80 bc	7,24 c
<i>C. orientalis</i>	SRD	3,32 a	4,23 a	9,60 b	10,20 b	14,94 c
	SRL	3,19 a	4,44 b	5,06 c	5,79 d	6,08 d
<i>C. pontica</i>	SRD	5,29 b	3,57 a	3,83 a	7,92 c	8,62 c
	SRL	2,26 a	2,79 a	4,28 b	6,67 c	6,89 c
<i>C. pseudoheterophylla</i>	SRD	5,52 b	4,19 a	7,51 c	7,48 c	7,68 c
	SRL	5,11 a	5,39 a	5,01 a	5,51 a	6,44 b

\*The letters in a given line indicate significant differences among

It was determined that *C. orientalis* had the greatest change in seed diameter due to scarification (8.67%) and the smallest change in seed length due to scarification despite being the species with the smallest thin coat thickness (0.82 mm). The high scarification rate observed in seed diameter of *C. orientalis* may be attributed to its high moisture content (8.98%). However, *C. pontica* had the smallest scarification rate observed both in seed length and diameter despite being the species with the highest moisture content (9.03%). Sulfuric acid may be negatively affecting germination by reacting with the moisture in seed coat and accessing the embryo. Indeed, Gokturk and Yilmaz (2015) and Baba (2017) found that sulfuric acid scarification employed to eliminate seed dormancy from seed coats negatively affected germination. Gokturk and Yilmaz (2015) could not detect germination when sulfuric acid scarification was used in *C. orientalis* and Baba (20117) observed better germination with ash solution treatment compared to sulfuric acid scarification in *C. orientalis* and *C. pontica* species.



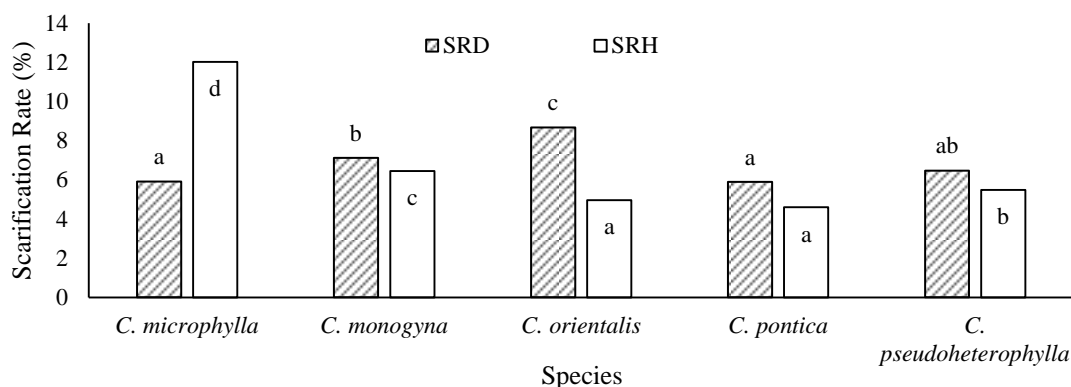


Figure 2. Distribution of scarification rates (measured as changes in seed diameter and length) among species following scarification in sulfuric acid. (Letters denote significant differences among species for SRD and SRL, respectively).

### Conclusions and Recommendations

Interspecific differences in terms of seed characteristics and an increase in scarification rate in seed coat with the increase in duration of scarification in sulfuric acid is an expected phenomenon. However, it is especially important to know the differences in seed characteristics and the proportional values of the scarification resulting from varying durations of sulfuric acid scarification and how they differ among species in evaluation of germination studies. The results show that there are significant differences among species in terms of seed characteristics. *C. orientalis* is the species, which has the smallest seed diameter and length and *C. pseudoheterophylla* is the species with the greatest seed diameter and length. *C. orientalis* and *C. pontica* have the smallest thin coat thickness while they have the greatest moisture content.

Scarification rate measured both as change in seed diameter and length increases as the duration of scarification in sulfuric acid increases. The scarification rate associated with seed diameter is greater compared to seed length. *C. orientalis* has the greatest and *C. pontica* has the smallest change in in seed diameter among species. Change in seed length is the smallest in *C. pontica* and *C. orientalis* and the greatest in *C. microphylla*.

The duration of sulfuric acid scarification should be decided based on the coat thickness and moisture content to prevent damage to the seed given the effect of sulfuric acid on the seed. Possible negative effects of long duration sulfuric acid scarification are particularly problematic for species with thin coat thickness and high moisture content.

### References

- Baba, A., 2017. Investigations on effects of cold stratification, floating in ash solution and sulfuric acid pretreatments on overcoming seed dormancy of *Crataegus orientalis* (Paal. ex. m. Bieb) (oriental hawthorn) and *Crataegus pontica* (Pojark.) seeds, Master thesis, Artvin Coruh University, Institute of Science and Technology, Artvin.
- Bir, R. E., 1992. Growing and Propagating Showy Native Woody Plants, Chapel Hill: University of North Carolina Press., Pp. 192.
- Bonner, F.T. and Vozzo J.A., 1987. Seed Biology and Technology of *Quercus*. USDA Forest Service GTR-SO-66. New Orleans, LA.
- Brinkman, K. A., 1794. *Crataegus* L., Hawthorn, Schopmeyer CS, Tech. Coord. Seeds of Woody Plants in the United States, Agriculture Handbook, 450, Washington, DC: USDA Forest Service., pp. 356-360.

- Dirr, M. A. and Heuser, C. W. Jr. 1987. The Reference Manual of Woody Plant Propagation, From Seed to Tissue Culture, Athens, GA: Varsity Press., p. 239.
- Genc, M., 2005. Ornamental Plant Breeding, Basic Breeding Techniques. Suleyman Demirel University Faculty of Forestry, No. 55, Isparta, p. 273
- Gokturk, A., Olmez, Z., Temel, F., 2006. Some native plants for erosion control efforts in Coruh River Valley. Pakistan Journal of Biological Sciences, 9 (4), 667-673.
- Gokturk, A., Yilmaz, S., 2015. Effects of sowing site, sowing time and some pretreatments on germination of oriental hawthorn (*Crataegus orientalis* Paal. Ex. M. Bieb) seeds, Journal of Forestry Faculty, Artvin Coruh University, Journal of Forestry, 16 (2): 190-202
- Gultekin, H. C., Yildiz, D., Divrik A., Gultekin U.G. and Genc M., 2006. A Research on the Breaking of Seed Dormancy in *Crataegus orientalis* Pallas. ex. Bieb., *Crataegus tanacetifolia* (Lam.) Pers., *Crataegus aronia* (L.) Bosc. ex. DC species. Anadolu University Journal of Science and Technology, 7 (1), 111-117.
- Guner, S. and Tilki, F. 2009. Dormancy Breaking in *Cotinus coggygria* scop. Seeds of Three Provenances". Scientific Research and Essays, 4(2), 73-77.
- Hartman, H. T., Kester, D. E., Davies, F. T. and Jr, Geneve, R. L., 1997. Plant Propagation: Principles and Practices. 6th ed. Upper Saddle River, NJ: Prentice-Hall, p. 770.
- ISTA (International Seed Testing Association), 1993. Rules For Testing Seeds: Rules, Seed Science and Technology, 21 (Suppl.): pp. 1-259.
- Lasseigne, F. T. and Blazich, F. A., 2003. *Crataegus* L., [www.wpsm.net/ Crataegus.pdf](http://www.wpsm.net/Crataegus.pdf) 25.07.2004.
- Poulsen, K. 1996. Case Study: Neem (*Azadirachta indica* A. Juss.) Seed Research, Eds: Ouedraogos, A.S., Poulsen, K., Stubsgaard, F., Proceedings of an International Workshop on Improved Methods for Handling and Storage of Intermediate/Recalcitrant Tropical Forest Tree Seeds, June 8-10, Umlebaek, Denmark.
- St. John, S. 1982. Acid Treatment of Seeds of *Crataegus monogyna* and other *Crataegus* Species, Combined Proceedings of the International Plant Propagators Society, 32, 203-205.
- Tilki, F., 2005. The effects of stratification, storage and temperature on the germination of *Fraxinus ornus* L. Seeds, Anadolu University Journal of Science and Technology, 6 (2), 191-196.
- Wolf, H. and Kamondo, B., 1993. Seed Pre-Sowing Treatment, Tree Seed Handbook of Kenya, Ed: Albrecht, J., Kenya Forestry Research Institute, pp: 55-62, Nairobi.
- Yahyaoglu, Z. and Olmez, Z., 2003. Seed Technology and Nursery Technique Lecture Notes, Kafkas University Artvin Forestry Faculty Publication No: 2, Artvin, s. 114.
- Yahyaoglu, Z., Olmez, Z., Gokturk, A. and Temel, F. 2006. Effects of cold stratification and sulfuric acid pretreatments on germination of hawthorn (*Crataegus* spp.) Seeds, Zonguldak Karaelmas University, Journal of Faculty of Forestry, 8 (10), 72-77

## THE EFFECTS OF SOME SUMMER PRUNING AND HUMIC SUBSTANCE APPLICATIONS ON THE NUTRITIONAL VALUE OF ALPHONSE LAVALLÉE GRAPE CULTIVAR

Aydın AKIN

Selçuk University, Faculty of Agriculture, Department Horticulture, Konya, TURKEY

\*Corresponding Author: aakin@selcuk.edu.tr

### Abstract

Viticulture is an important agricultural branch in Turkey. Grape is the most grown fruit species in Turkey. The study was conducted Alphonse Lavallée grape variety (*Vitis vinifera* L.) grown on grafted 1103 Paulsen rootstock in Turkey in 2016. In the study, It was investigated effects of Control (C), 1/3 Cluster Tip Reduction (1/3 CTR), Shoot Tip Reduction (STR), Humic Substance Application (HS), 1/3 CTR+STR, 1/3 CTR+HS, STR+HS, 1/3 CTR+STR+HS applications on nutritive values. According to results; the maximum dry matter content 87.64 g/100 g with HS, 87.76 g/100 g with 1/3 CTR+HS, 87.78 with STR+HS and 87.67 with 1/3 CTR+STR+HS applications; the maximum crude protein 3.38 g/100 g with HS and 3.40 g/100 g with STR+HS applications; the maximum crude cellulose 4.46 g/100 g with HS application; the maximum total sugar content 64.64 g/100 g with STR and 64.64 g/100 g with HS applications were obtained. No statistically significant difference was found in terms of crude ash content.

**Keywords:** *Alphonse Lavallée grape cultivar, 1/3 cluster tip reduction, shoot tip reduction, TKI-humas application, nutritive values.*

### Introduction

Turkey is among the most important viticulture countries in the world. Viticulture is a source of livelihood for a significant number of producers. It was produced 74 million tons from 7 million hectares in the World (Anonymous 2017). 4.000.000 tons grape from 435.227 hectares was produced vineyard in Turkey (Anonymous 2016). Humic acid in nutrition of the plants plays an important role directly and indirectly (Lobartini et al. 1997). In the full bloom period of humic acid application, berry weight, titratable acidity and maturity index values of Italy grape cultivar increased significantly (Ferrara and Brunetti 2010). Reducing cluster number application in Amasya and Cardinal grape cultivars decreased the amount of titratable acid and fresh grape yield per vine, while it increased maturity index value (Dardeniz and Kısmalı 2002). 1/3 Cluster Reduction + Humic Substance application was increased grape yield, berry weight values of Horoz Karası grape variety. 1/3 Cluster Reduction application was increased grape yield and maturity index values of Gök grape variety (Akin 2011a). The highest grape yield was obtained in 1/3 cluster tip reduction + herbagegreen in Müşküle table grape variety (Akin 2011b). The highest fresh grape yield with 5.48 kg/vine was obtained with HA application in Kabarcık (*Vitis vinifera* L.) grape cultivar (Akin and Alağöz 2016). İter and Altındışli (2007) was reported that 100 g of raisins contained 275 kcal, 2.7 g protein, 0.4 g oil, 69.4 mg carbohydrate, 64 mg Ca, 2.2 mg Fe, 86 mg P, 1060 mg K, 19 mg Na, 12 µg carotene, 0.70 µg vitamin E, 0.25 mg vitamin B6, 0.05 mg Riboflavin, 0.8 mg Niacin, 27 µg Folate, 4.8 µg Biotin. Altındışli (2003) was put forward that raisin is accepted as a high-calorie and quick source of energy; it attracts attention with its sustainable energy content and positive effects on health. Raisin is a very good source of inulin. İter and Altındışli (2007)

was reported that there can be 3.63 grams of inulin in 100 grams; with its prebiotic characteristic, it has positive effects on cholesterol, immunity and intestinal health and digestible fiber has positive effects on intestines and digestion. Raisins are valued for their medicinal and nutraceutical properties. They are widely used and are popular as a good source of potassium, magnesium and fiber (Dev *et al.*, 2008). Raisins eliminate bad breath and they are good for lung diseases, bad mood, forgetfulness, anemia, liver vulnerability and hoarseness. A lot of grapes should be eaten to get rid of leprosy (Subaşı and Bostan, 2011). Nutritional values of raisin gained by drying Gök grape variety in the sun and in the shade are compared. According to the data collected, in the grapes dried in the sun, the amount of dry matter, crude ash, crude oil, crude fiber, total sugar, phosphorus, and magnesium, and in those dried in the shade the amount of crude protein, sodium, selenium were found to be relatively high in the statistical sense. The differences between these two drying methods in terms of potassium, calcium, iron, zinc, copper and boron and energy values were found to be statistically insignificant (Akın *et al.* 2011).

The purpose of this study was to identify the effects on the nutritional value of some summer pruning and humic substance applications of Alphonse Lavallée grape cultivar.

### Materials and Methods

This study was conducted in the viticulture of Selçuk University in Konya, Turkey in 2016. Alphonse Lavallée grape cultivar is evaluated as table grape and grafted 1103 Paulsen rootstock. Yield and development is a good standard grape variety, matures in the middle of the season, big and long cluster, big and round berry, black-blue colour and suitable for short pruning.

Experimental design; 1) Control (C), 2) 1/3 Cluster Tip Reduction (1/3 CTR), 3) Shoot Tip Reduction (STR), 4) Humic Substance (HS), 5) 1/3 CTR+STR, 6) 1/3 STR+HS, 7) STR+HS, 8) 1/3 CTR+STR+HS.

Effects on nutritive values of this application in the cultivar Alphonse Lavallée grape were determined. This study were used 63 vines of Alphonse Lavallée grape variety. The maturing grapes were harvested and the necessary measurement and analysis procedures were carried out according to the following criteria.

*1/3 Cluster Tip Reduction (1/3 CTR):* The 1/3 cluster tip reduction (berry thinning) was applied by cutting the tips of the cluster at the point of one third of the cluster length, while the 1/3 cluster reduction of all clusters outside the control in the berry set period was conducted.

*Shoot Tip Reduction (STR):* From 40 to 45 cm long and 10 cm from the ends of the shoots located on the cluster part is amputated.

*TKI-Humas Composition:* TKI-Humas; leonardit produced from low-quality lignite, containing 12% humic and fulvic acid is a liquid natural organic soil conditioner (Gezgin 2013). Total Organic Matter: 5%; Humic Acid + Fulvic Acid: 12%; Water Soluble Potassium Oxide (K<sub>2</sub>O-3%), PH: 11-13.

*Implementation of TKI-Humas on Soil:* 333 ml TKI-Humas/5 lt water for each vine was applied. Applications were made in the evening near the cool hours.

1. TKI-Humas was applied to soil before bud burst,
2. TKI-Humas was applied to soil before blooming.

Fresh grapes taken from Alphonse Lavallée grape cultivar vineyards that belonged to farmers were dried at three intervals with 10 kilograms each in the sun. Samples from the raisins were taken for analyses which were done immediately.

*Dry matter analysis:* The tare of the dry mass container, which is put into desiccator after being kept in a drying-oven of Binder brand at 105 °C for an hour, is taken. (a) 2-2.5 grams of

mashed dried grape is placed in the container (b) it is kept at 105 °C in drying cabinet for 8 hours and taken to desiccator. It is weighed after it cools down. (c) By using the formula dry mass= c-a x 100/sample amount, dry mass was calculated. Results were given as g/100 g.

*Crude protein analysis:* Kjeldahl apparatus of Behr brand was used for the analysis. The apparatus is switched on and left for 15 minutes to make it ready. 1-1.5 g mashed raisin sample is weighed and put into Kjeldahl tube; 1 gram catalyzer is added in it and 20 ml dense H<sub>2</sub>SO<sub>4</sub> is added. It is kept in the incineration unit until it becomes light yellow or green. 80 ml 3-percent boric acid is put into an erlenmayer with a capacity of 300 ml; 2-3 drops of methyl rot is added; the color changes into pink. The Kjeldahl tube with burned sample, and the erlenmayer with boric acid are placed in the distillation unit. 100 ml pure water is poured into the tube, 33-percent 100 ml NaOH added. Te ammonia formed in the tube is retained by boric acid. The color changes into yellow; then, by using N/7 H<sub>2</sub>SO<sub>4</sub>, titration is carried out until the color changes into pink. The results are given as g/100 g.

*Crude ash analysis:* Burning the organic parts of the sample at 550 °C and considering the remaining parts as crude ash. The tare of the ash container, which was placed into desiccator after being kept for an hour, was taken (a) 1-1.5 g sample is weighed and put into it (b) the sample is kept in the ash furnace of Proderm brand at 550 °C for 6-8 hours, and it is taken to desiccator. It is weighed after it cools down (c) Dry matter is calculated by using the formula dry matter= (c-a) x 100/the amount of sample. The results are given as g/100 g.

*Crude cellulose (fiber) analysis:* According to Van Soest et al. (1991), cellulose analysis apparatus of Velp brand was used to carry out analysis. The results are given as g/100 g.

*Total sugar analysis:* 50 grams of grapes from the samples brought to the laboratory were kept in the drying cabinet for five days until it reached its constant zero humidity. 25 grams of grapes taken from the samples were mashed and 50 ml of water at 90 °C was poured into it. After it was blended in a mixer with heater for 4 hours at 45 °C, it was mashed and filtered through filter paper. The value was determined by taking several drops of filtered matter and reading it with the help of hand-size refractometer apparatus (Atago RX 7000 Alpha) at 20 °C. The results are given as g/100 g.

The research was planned in a completely randomized block design as a simple factorial experiment, and variance analyses and multiple comparison tests were done by JMP statistical package program (version 7.0; SAS Institute, Cary, NC, USA).

## Results and discussion

Dry matter, crude protein, crude ash, crude fiber and total sugar were affected differently from applications. The results of nutritional value analyses were given in Table 1.

Table 1. Nutritional values of Alphonse Lavallée raisin (g/100 g)

Applications	Dry matter	Crude protein	Crude ash	Crude fiber	Total sugar
Control	86.64 b	3.33 ab	4.75	4.41 ab	64.59 ab
1/3 CTR	86.63 b	3.34 ab	4.73	4.40 abc	64.54 ab
STR	86.97 ab	3.29 ab	4.75	4.28 c	64.65 a
HS	87.64 a	3.38 a	4.72	4.46 a	64.65 a
1/3 CTR+STR	86.47 b	3.23 b	4.72	4.30 bc	64.55 ab
1/3 CTR+HS	87.76 a	3.24 b	4.75	4.37 abc	64.52 ab
STR+HS	87.78 a	3.40 a	4.73	4.37 abc	64.45 b
1/3 CTR+STR+HS	87.67 a	3.35 ab	4.79	4.37 abc	64.56 ab
LSD 5%	0.96	0.13	N.S.	0.13	0.18

N.S.: No significant

According to findings, dry matter content of the raisin was found to be statistically significant (Tab. 1). The maximum dry matter content was determined 87.64 g/100 g with HS, 87.67 g/100 g with 1/3 CTR+STR+HS, 87.76 g/100 g with 1/3 CTR+HS and 87.78 g/100 g with STR+HS applications. The minimum dry matter content was found 86.47 g/100 g with 1/3 CTR+STR, 86.63 g/100 g with 1/3 CTR and 86.64 g/100 g with C applications. In the similar studies, 83.68 g/100 g dry matter in Ekşi Kara raisin and 83.31 g/100 g dry matter in Kara Dimrit raisin (Akın et al. 2011) were found.

Crude protein content was statistically significant (Tab. 1). The maximum crude protein content was determined 3.38 g/100 g with HS and 3.40 g/100 g with STR+HS applications. The minimum crude protein content was found 3.23 g/100 g with 1/3 CTR+STR and 3.24 g/100 g with 1/3 CTR+HS applications. In the similar studies, Crude protein content was 2.89 g/100 g in Kara Dimrit raisin and 2.31 g/100 g in Ekşi Kara raisin (Akın et al. 2011). 2.7 g/100 g was determined in Sultani Seedless raisin (İlter and Altındışli 2007).

Crude fiber content was found to be statistically significant (Tab. 1). The maximum crude fiber content was determined 4.46 g/100 g with HS application. The minimum crude fiber content was found 4.28 g/100 g with STR application. In the similar studies, 2 g/100 g crude fiber was reported in Sultani Seedless raisin (İlter and Altındışli 2007). 18.42 g/100 g crude fiber in Kara Dimrit raisin and 14.92 g/100 g in Ekşi Kara raisin was determined (Akın et al. 2011).

Total sugar contents were found to be statistically significant (Tab. 1). The maximum total sugar content was determined 64.65 g/100 g with STR and 64.65 g/100 g with HS applications. The minimum total sugar content was found 64.45 g/100 g with STR+HS application. In similar studies, it was determined 69.4 g/100 g total sugar in Sultani Seedless (İlter and Altındışli 2007). 73.60 g/100 g total sugar content in Kara Dimrit raisin and 74.51 g/100 g in Ekşi Kara raisin was determined (Akın et al. 2011).

As a result, Alphonse Lavallée raisin has a important food source in terms of dry matter, crude protein, crude cellulose and total sugar content. It is played an important role for more conscious consumer with determining of the nutritional values of Alphonse Lavallée raisin. Crude ash content was not effected statistically from applications. It can be advise to increase dry matter content with HS, with 1/3 CTR+HS, with STR+HS and with 1/3 CTR+STR+HS applications; to crude protein content with HS and with STR+HS applications; to crude cellulose content with HS application; to total sugar content with STR and with HS applications.

### **Acknowledgements**

This research was supported by a grant from Selçuk University, Scientific Research Projects Institute-Turkey (Project No: 16401100).

### **References**

- Akın A (2011a). Effects of cluster reduction, herbagegreen and humic acid applications on grape yield and quality of Horoz Karasi and Gök üzüm grape cultivars”. African Journal of Biotechnology. 10 (29): 5593-5600.
- Akın A (2011b). Effects of cluster tip reduction and some growth regulating applications on grape yield and quality of the Müşküle grape variety. YYU J AGR SCI, 21(2):134-139.
- Akın A, Altındışli A, Keskin A.H. & Sahin R (2011). Comparison of nutritional values in different drying conditions of Gök grape cultivar. 34th World Congress of Vine and

- Wine ‘‘The Wine Construction’’ 20-27 th June 2011 Porto-Portugal. (Poster No: 350) (www.oiv2011.pt)
- Akın A & Alağöz Ö (2016). The effects of cluster tip reduction and humic acid applications on yield and quality of Kabarcık grape cultivar. International Participant 3. National Humic Substance Congress. 3-5 November 2016, Konya, P: 239-249.
- Altındışli A (2003). An overview on Turkish Sultana production and recent developments, International Dried Grapes Producing Countries Conference, 23-24 October 2003, Izmir, Turkey.
- Anonymous (2017). FAO Statistical database. <http://faostat.fao.org>. Rome: Retrieved February 02, 2017.
- Anonymous (2016). Crop plant production statistics. <http://tuikapp.tuik.gov.tr/bitkiselapp/bitkisel.zul> tuik, Retrieved December 26, 2016.
- Dardeniz D., Kışmalı I. (2002). The researches on the effects of different crop load on pruning weight, yield and quality of Amasya and Cardinal grape cultivars. Ege Univ. Agriculture Faculty Publications. Bornova-İzmir, 39: 9-16.
- Dev S.R.S, Padmini T, Adedeji A, Gariépy Y. & aghavan G.S.V (2008). A comparative study on the effect of chemical, microwave, and pulsed electric pretreatments on convective drying and quality of raisins. *Drying Technology*, 26: 1238–1243.
- Gezgin S. (2013). Use of TKI-Humas, a source of humic and fulvic acid in plant breeding. [www.tkihumas.gov.tr](http://www.tkihumas.gov.tr) .Retrieved July 18, 2016.
- Ferrara G., Brunetti G. (2010). Effects of the times of application of a soil humic acid on berry quality of table grape (*Vitis vinifera* L.) cv Italia’’. *Spanish Journal of Agricultural Research*. 8(3): 817-822.
- İlter E., Altındışli A (2007). Seedless dried grape. Turkish Sultans, Aegean Exporters’ Association, Can Puplicer, İzmir. n: 1-49.
- Lobartini J.C, Orioli, G.A. & Tan K.H. (1997). Characteristics of soil humic acid fractions separated by ultrafiltration, *Commun. Soil Sci. Plant Anal.* 28: 787-796.
- Soest V.P.J, Robertson J.B., Lewis B.A. (1991). Methods for dietary fiber, neutral detergent fiber, and nonstarch polysaccharides in relation to animal nutrition symposium: Carbohydrate methodology, metabolism, and nutritional implications in dairy cattle. *J Dairy Sci* , 74: 3583-3597.
- Subaşı E. & Bostan S.Z. (2011). Grape drying. ([www.ziraatcim.net/images/dosyalar/sunum12.ppt](http://www.ziraatcim.net/images/dosyalar/sunum12.ppt)) (Access Date, 27.01.2017). (In Turkish).

## DETERMINATION THE EFFECTS OF NITROGEN DOSES ON HAY YIELD AND QUALITY CHARACTERISTICS OF SOME OAT CULTIVARS/LINES

Celal BAYRAM\*, İlknur AYAN

Ondokuz Mayıs University, Agricultural Faculty, Department of Agronomy, Samsun, Turkey

\*Corresponding author: byrm.celal@gmail.com

### Abstract

In order to healthy ruminant feeding, they must eat high quality forage and at least half of feed should consist of forage. Though oat commonly use food and feed in the world, our country main usage area of oat is feeding as forage and kernel. The climatic characteristics of Samsun are very suitable for oat requirements. The aim of this study is to determine the effects of 5 different doses of nitrogen, on hay yield and mineral matter content of 2 oat varieties and 1 oat cultivars/lines. The experiment was established according to split plots design with 3 replicates in 11 November 2016. Harvest was made when oat become dough stage. During harvest 500 g sample was taken for each plot and dried in an oven at 60 °C temperature until constant weight. Then these samples grounded and analysed protein, ADF, NDF and mineral contents. The effect of applied nitrogen doses on hay yield was very significant and dry hay yield changed between 5589.68 – 20237.69 kg $ha^{-1}$ . The highest leaf ratio was determined to Line 38 (37.55%). Results obtained for Ca concentration in this study were more than these recommended values. Mg concentration of genotypes were ranged from 0.07% to 0.13%. This study showed that N doses had great effect on hay yield, crude protein, ADF and NDF content of oat cultivars and line. N15 and/or N20 doses can be recommended in similar ecological conditions regarding the genotype.

**Keywords:** *Oat, nitrogen dose, hay yield; mineral content*

### Introduction

In order to healthy ruminant feeding, they must eat high quality forage and at least half of feed should consist of forage. Small grain cereal forage are greatly adjusted highly multi-purpose forages used for pasture, green chop, silage and hay (Fohner, 2002). Though oat commonly use food and feed in the world, our country main usage area of oat is feeding as forage and kernel. Climatic conditions of Samsun province is very suitable for oat. The proof of this fact that there are a huge variation of local oat population or ecotypes in Samsun (Kün, 1983). Oat (*Avena sativa* L.) is used extensively as feed for livestock because of its high quality as well as its high-forage yield (Moreira, 1989; Zhang et al., 1998). Oat would be very important crop in this region because of its really good adaptation, higher yield, nutritious and palatable for ruminants (Aydin *et al.*, 2010). Oat can be grown as a catch crop from October to May without any time limitation for summer main crops. Yield potential and response of nitrogen fertilizer of oat is higher than the other cool season cereals. Additionally, it is possible to obtain high quality silage from oat forage (Hartman, 2000; Frazer and Mc Cartney, 2004). The aim of this study is to determine the effects of 5 different doses of nitrogen, on hay yield and mineral matter content of 2 oat varieties and 1 oat cultivars/lines.



## Materials and methods

This study was conducted to determine the effects of 5 N doses (0, 5, 10, 15 and 20 kg da<sup>-1</sup>) on hay yield and mineral contents of 2 oat cultivars (Kahraman and Faikbey) and 1 oat lines in Agricultural Research Center of Ondokuz Mayıs University. In experiment oat seeded with 20 cm row spacing and each plot was consist of 6 rows. Consider soil sample analysis, 8 kg/da P<sub>2</sub>O<sub>5</sub> was applied the whole experiment area. The half of N doses were applied with seeding, the other part was given when the plants started active growing in spring. Experiment was not irrigated. The experiment was established according to split plots design with 3 replicates in 11 November 2016. Maturity at harvest was determined using Zadoks's scale (Zadok et al., 1974). Harvest was done at late milk dough (Zadok scale 77). During harvest 500 g sample was taken for each plot and dried in an oven at 60 °C temperature until constant weight. Then these samples grounded and analysed protein, ADF, NDF and mineral contents. Analyses of grinded samples were performed in Foss NIRSystems (Hoy *et al.*, 2002) Model 6500 Win ISI II v1.5 device by using IC-0904FE calibration program. Resultant data were subjected to statistical analyses according to split plot design. Differences in means were tested with Duncan's multiple range test.

## Results and discussion

Significant differences were determined amongst the genotypes and N doses in the point of hay yield. While the highest hay yield was obtained from Faikbey cultivar (14271 kg ha<sup>-1</sup>) as an average of N doses, two others genotypes were in the same statistical group. Regard the mean of genotypes, the highest hay yield was determined to N20, N15 and N10 doses (14248, 13821 and 13214 kg ha<sup>-1</sup>, respectively). The lowest hay yield was 6426 kg ha<sup>-1</sup>, obtained from N0 dose (Table 1). In previous studies carried out similar ecological conditions, oat hay yields were ranged between 12.1 – 12.9 t ha<sup>-1</sup> (Aydın *et al.*, 2010; Mut *et al.*, 2006).

The responses of genotypes to N doses were different. While hay yield of the cultivar Faikbey linearly increased parallel to N dose increase, hay yields of the other genotypes increased until N15 dose and then decreased (Table 1 and Figure 1). The highest leaf ratio was determined to Line 38 (37.55%). Even though leaf ratios slightly increased parallel to N dose increase, there were not significant differences (Table 1).

Protein content is an important feed factor, with high quality feed having high protein content. The chemical composition and nutritive value of green plant material can give useful information about the forage quality (Kjos, 1990). In terms of protein concentration there were no differences amongst the genotypes, but differences amongst the N doses were significant. Though increasing N doses increased protein content of genotypes, only N20 dose was in different and the highest group (Table 1). The results were consistent with the findings of Ericson *et al.* (1977), Kim *et al.* (2006) and Aydın *et al.* (2010).

Plant cell walls, containing a digestible and an indigestible fraction are an important element fixing forage quality. ADF (acid detergent fiber) and full denomination NDF contents in forages. Important quality characteristics for forages are the concentrations of ADF and NDF (Caballero *et al.*, 1995; Assefa and Ledin, 2001). In this experiment while differences amongst the genotypes were significant, there were no differences amongst the N doses considering the ADF and NDF values. The highest ADF and NDF ratios were obtained from Faikbey cultivar (34.1 and 56.83%, respectively) (Table 1). The effects of N doses on ADF and NDF ratios did not exactly unveil, because the whole plants harvested the same growing stage (Zadok Scale 77). The results were consistent with the findings of Kim *et al.* (2006) and Aydın *et al.* (2010).

Table 1. The values about hay yield and some agricultural characteristics obtained from some oat genotypes that was applied different N doses

Cultivar-line / N Doses	Hay Yield (Kg Ha <sup>-1</sup> )					
	No	N5	N10	N15	N20	Average
Faikbey	7488.43	11460.75	16855.73	15314.78	20237.69	14271.47 a
Kahraman	5589.68	9117.80	10765.72	13524.80	11279.16	10055.43 b
Hat 38	6201.02	9230.06	12021.70	12624.66	11227.54	10260.99 b
Average	6426.37 c	9936.20 b	13214.38 a	13821.41 a	14248.12 a	
	Leaf Ratio (%)					
Faikbey	32.37	28.78	31.81	31.82	34.66	31.88 b
Kahraman	24.32	24.38	24.58	26.42	25.56	25.05 c
Hat 38	36.41	38.40	35.40	40.24	37.32	37.55 a
Average	31.04	30.52	30.60	32.83	32.51	
	Crude Protein (%)					
Faikbey	9.06	8.7	8.05	9.07	10.46	9.07
Kahraman	9.31	9.04	9.06	9.45	10.51	9.47
Hat 38	9.04	8.15	8.59	9.32	10.11	9.04
Average	9.13b	8.63b	8.56b	9.28b	10.36a	
	ADF (%)					
Faikbey	34.62	31.88	34.15	34.35	35.52	34.1a
Kahraman	29.07	29.03	27.9	27.86	29.13	28.59b
Hat 38	29.6	29.06	29.32	31.84	28.94	29.75b
Average	31.1	29.99	30.45	31.35	31.2	
	NDF (%)					
Faikbey	57.47	53.7	57.32	56.43	59.24	56.83a
Kahraman	51.35	51.37	47.85	48.92	51.59	50.21b
Hat 38	51.45	50.04	52.1	54.62	50.85	51.81b
Average	53.42	51.7	52.42	53.32	53.89	
	Ca (%)					
Faikbey	0.43	0.46	0.41	0.49	0.48	0.45a
Kahraman	0.39	0.42	0.39	0.37	0.43	0.39b
Hat 38	0.37	0.38	0.37	0.36	0.43	0.38b
Average	0.39	0.42	0.39	0.41	0.45	
	K (%)					
Faikbey	1.51	1.18	1.33	1.34	1.93	1.45b
Kahraman	2.16	1.91	2.09	2.23	2.33	2.14a
Hat 38	2.22	1.99	1.94	2.02	1.99	2.03a
Average	1.96	1.69	1.79	1.87	2.08	
	Mg (%)					
Faikbey	0.09	0.11	0.12	0.10	0.07	0.09b
Kahraman	0.11	0.11	0.12	0.13	0.12	0.11a
Hat 38	0.11	0.12	0.10	0.11	0.12	0.11a
Average	0.10	0.12	0.12	0.11	0.10	
	P (%)					
Faikbey	0.31	0.30	0.29	0.29	0.30	0.29c
Kahraman	0.35	0.33	0.34	0.35	0.34	0.34a
Hat 38	0.34	0.33	0.33	0.32	0.32	0.32b
Average	0.33	0.32	0.32	0.32	0.32	

\*There was not significant differences amongst to figure shown the same letter in the same line or column (P<0.05)

There were significant differences amongst cultivars/line regarding their mineral content. The effects of N doses on mineral concentration of genotypes were found not to be significant. Differences in Ca contents were significant between cultivars/line. While the highest Ca ratio

determined in Faikbey cultivar (0.45%), there were no differences Kahraman cultivar and Line 38 (0.39 and 0.38%, respectively). Even if could not found statistical differences, in general, increasing N doses increased Ca concentration. Tajeda *et al.* (1985) reported that forage crops should contain at least 0.3% of Ca for ruminants. The American National Research Council (NRC, 1984) recommended that forage crops should contain 3.1 g kg Ca concentration for beef cattle. Results obtained for Ca concentration in this study were more than these recommended values (Table 1).

Differences in K contents of cultivars/line were significant. The highest K concentration was determined in Line 38 and Kahraman cultivar (respectively 2.14 and 2.0%). These results were higher than suggested values of 0.85% by Tajeda *et al.* (1985). But high K concentration may cause Mg deficiency (Loreda *et al.*, 1986).

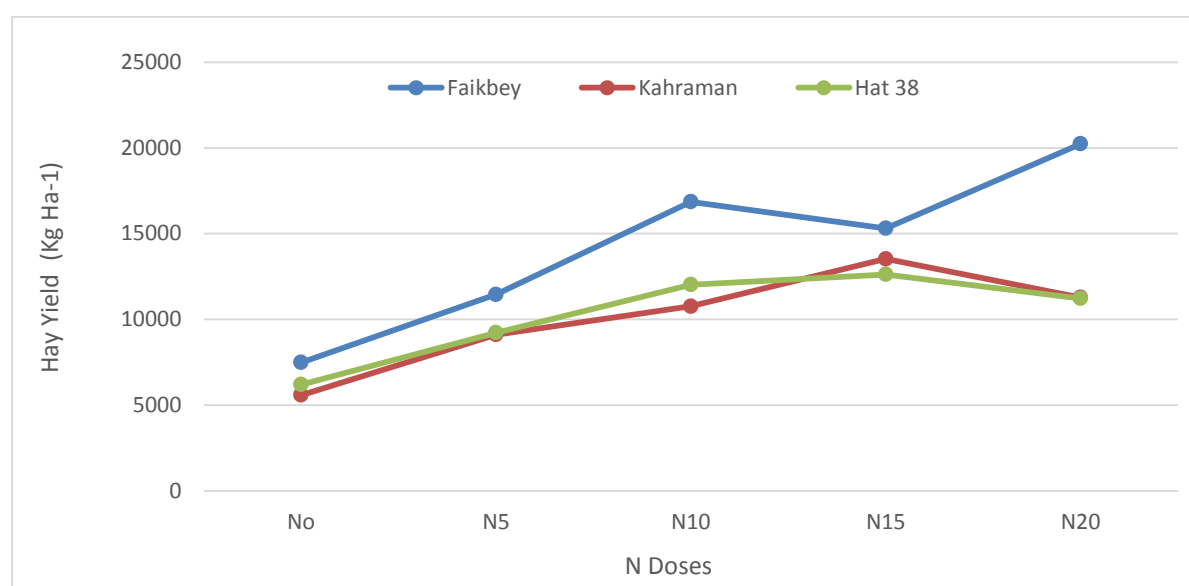


Figure 1. Hay yields of oat genotypes according to N doses

Mg content was higher in Kahraman cultivar and Line 38 than in Faikbey cultivar and this difference was statistically significant. Mg concentration of genotypes were ranged from 0.07% to 0.13% (Table 1). Mg concentrations for forage crops are recommended as 0.2% for ruminants by Tajeda *et al.* (1985) and 1 g kg for beef cattle by the NRC (1984). Grass tetany or hypomagnesemic tetany in cattle is caused by an imbalance of K, Ca and Mg in the diet. Mineral imbalances, deficiencies or excess and low bio-availability of essential minerals result in negative economic impacts when animal performance and health are compromised (Van Soest, 1982). Magnesium deficiency may lead to a reduction in weight gain, milk production and conception rate (Stuedemann *et al.*, 1983). P contents of genotypes were altered between 0.29% and 0.35%. While the highest P concentration was determined in Kahraman cultivar (0.34%), the lowest one obtained from Faikbey cultivar (0.29%) (Table 1). Results obtained for P concentration in this study were adequate for ruminants (National Research Council, 2001).

### Conclusion

This study showed that N doses had great effect on hay yield, crude protein, ADF and NDF content of oat cultivars and line. N15 and/or N20 doses can be recommended in similar ecological conditions regarding the genotype. But, to clear the recommendation this type study should carry out at least 2 year.

## **Acknowledgements**

This study was financially supported by the Scientific Research Council of Ondokuz Mayıs University with a project number of PYO.ZRT.1904.17.003 (Master Thesis Project).

## **References**

- Assefa G. and Ledin I., 2001. Effect of variety, soil type and fertilizer on the establishment, growth, forage yield, quality and voluntary intake by cattle of oats and vetches cultivated in pure stands and mixtures. *Anim. Feed Sci. Technol.*, 92: 95-111.
- Aydın, N., Mut, Z., Mut, H., Ayan, İ., 2010. Effect of Autumn and Spring Sowing Dates on Hay Yield and Quality of Oat (*Avena sativa* L.) Genotypes. *Journal of Animal and Veterinary Advances*. 9(10):1539-1545.
- Caballero, A.R., E.L. Goicoechea-Oicoechea and P.J. Hernaiz-Ernaiz, 1995. Forage yields and quality of common vetch and oat sown at varying seeding ratios and seeding rates of vetch. *Field Crops Res.*, 41: 135-140.
- Ericson, D.O., N.R. Riveland and E.W. French, 1977. The nutritional value of oat hay harvested at several stages of maturity. *North Dakota Farm Res.*, 35: 13-16.
- Fohner, G., 2002. Harvesting maximum value from small grain cereal forages. *Proceedings Western Alfalfa and Forage Conference*, Dec. 11-13, California, pp: 28-33.
- Fraser, J. ; McCartney, D., 2004. Fodder oats in North America: Chapter III. In: Suttie, J. M.; Reynolds, S. G. *Fodder oats: a world overview*. FAO Plant production and protection Series N°33. FAO, Rome, Italy.
- Hartman, M. 2000. Oats production in Alberta - oats for fodder (available at [www.agric.gov.ab.ca/crops/oats/utility02.html](http://www.agric.gov.ab.ca/crops/oats/utility02.html)).
- Hoy, M. D., Moore K. J., George, J. R., Brummetr, E. C. 2002. Alfalfa yield and quality as influenced by establishment method. *Agronomy J.*, 94, 65-71.
- Kim, J.D., S.G. Kim, S.J. Abuel, C.H. Kwon, C.N. Shin, K.H. Ko and B.G. Park, 2006. Effect of location, season and variety on yield and quality of forage oat. *Asian-Aust. J. Anim. Sci.*, 19: 970-977.
- Kjos, N.P., 1990. Evaluation of the feeding value of fresh forages, silage and hay using near infrared reflectance analysis (NIR). I. A comparison of different methods for predicting the nutritive value. *Norwegian J. Agric. Sci.*, 4: 305-320.
- Kün, E., 1983. *Serin İklim Tahılları*. Ankara Üniversitesi Ders Kitabı: 240. A. Ü. Basımevi.
- Loreda, C.M.A., G.A. Ardilla and V.J. Alvarez, 1986. Variation in mineral concentrations in grasses in the cattle farming area of the coribbean herb. *Abstract*, 56: 928-929
- Moreira, N., 1989. The effect of seed rate and nitrogen fertilizer on the yield and nutritive value of oat-vetch mixtures. *J. Agric. Sci.*, 112: 57-66.
- Mut, Z., I. Ayan and H. Mut, 2006. Evaluation of forage yield and quality at two phenological stages of triticale genotypes and other cereals grown under rainfed conditions. *Bangladesh J. Bot.*, 35: 45-53.
- National Research Council, 2001. *Nutrient Requirements of Dairy Cattle*. 7th Rev. Edn., National Academy of Sciences, Washington, DC.
- NRC. (National Research Council), 1984. *Nutrient Requirements of Domestic Animals: Nutrient Requirements of Beef Cattle*. 6th Revised Edn., NAS/NRC., Washington DC., USA.
- Stuedemann, J.A., S.R. Wilkinson, H. Cioria and A.B. Caudle, 1983. Effect of levels of nitrogen fertilization of Kentucky-31 tall fescue (*Festuca arundinacea* Schreb.) on brood

- cow health. Proceedings of the International Grassland Congress, (IGC'83), Westview Press, Lexington,pp: 728-732
- Tajeda, R., L.R. McDowell, F.G. Martin and J.H. Conrad, 1985. Mineral element analyses of various tropical forages in Guatemala and their relationship to soil concentrations. *Nutr. Rep. Int.*, 32: 313-324.
- Van Soest, P.J., 1982. *Nutritional Ecology of the Ruminant*. O and B Books Inc., Corvallis.
- Zadok, J.C., T.T. Chang and C.F. Konzak, 1974. A decimal code for growth stages of cereals. *Weed Res.*, 14: 415-421.
- Zhang, Y.S., X.M. Zhou and Q.J. Wang, 1998. A preliminary analysis of production performance of Oat at alpine meadow pasture. *Acta Agrestia Sin*, 6: 115-123.

## INVESTIGATION OF RELATION BETWEEN SOME PHYSIOLOGICAL PARAMETERS AND YIELD IN MAIZE (*ZEA MAYS* L.)

Sevda KILINC<sup>1</sup>, Cetin KARADEMIR<sup>2\*</sup>, Zehra EKIN<sup>3</sup>

<sup>1</sup>GAP International Agricultural Research and Training Center, Diyarbakir, Turkey

<sup>2\*</sup>Siirt University, Faculty of Agriculture, Department of Field Crops, Siirt, Turkey

<sup>3</sup>Yuzuncu Yil University, Faculty of Agriculture, Department of Field Crops, Van, Turkey

\*Corresponding author: cetinkarademir@siirt.edu.tr

### Abstract

This study was carried out to determine relationships between physiological characteristics and yield of some maize varieties. The research was laid out as randomized complete block design with four replications in 2015 maize growing season. Six grain maize varieties which have different properties (PR31D24, Kalipso, 70MAY82, Suerto, P1921, DKC6724) were used as material. According to the obtained results, there were significant differences among varieties in terms of pre-flowering, flowering, post-flowering period's chlorophyll contents (SPAD readings), leaf area index (LAI) and stomatal conductance. The P1921 variety had highest yield by 15181.0 kg ha<sup>-1</sup>. The correlation analysis showed that there were significant and positive correlations among grain yield and flowering period's chlorophyll content. It was determined that there were interrelations between physiological and morphological parameters and these interrelations affects grain yield; in addition, the results indicated that chlorophyll content can be used as selection criteria in maize breeding programs.

**Key words:** *Adaptation, physiology, maize, quality, yield*

### Introduction

Maize is annual plant that belongs to *Poaceae* family. Its grain contains 70% starch, 20% protein, 5% oil, 2% sugar, 2% ash, vitamin A and pentosanes. Maize not only used for human and animal foods but also it used in industrial area as raw material for producing alcohol, oil, semolina *etc.* In the World's cereals production it takes place on the top with 183 million hectares planting area, 1.021 million tons production and 50.2 kg ha<sup>-1</sup> average yield (Anonymous, 2014).

Maize must be produced as sufficient amounts and quality for meeting the needs of agricultural industries. The main researches must be focused on selecting suitable varieties for ecological conditions and resistant to the environmental factors, using quality seeds and generalizing planting hybrid seeds for increasing production. High temperature, water deficiency, freezing, pollution, drought and salt stress may decrease yield by negatively effects physiological structure of plant. Environmental factors such as drought, heat temperature *etc.* the most yield limiting in the maize. It was reported that at flowering stages occurring drought stress leads to yield decreasing (Chimenti *et al.*, 2006; Saini and Westgagge, 2000). Therefore, for increasing yield and quality determining the physiological basis of resistance of environmental factors is most important research areas. The results of such researches will help to develop new varieties in breeding programs.

The significant improvement has been made in yield potential by plant breeding. The successful of breeding depend on association between breeder and plant physiologists (Jackson *et al.*, 1996). The recent researches indicated that physiological parameters such as stomatal conductance, photosynthesis rate, cell membrane thermostability, plant canopy

temperature and chlorophyll content can be used as selection criteria for yield (Fisher *et al.*, 1998; Amthor, 2001; Bavec and Bavec, 2001; Reynolds *et al.*, 2001; Soltani and Galeshi, 2002; Koç *et al.*, 2003; Yıldırım *et al.* 2009).

At early development stages, if leaf area index is changed the leaf photosynthesis rate can be increased by increasing daily light used by plant and this cause high yielding (Lopez-Castaneda and Richards, 1994; Hafid *et al.*, 1998). Plant photosynthesis and biomass production is closely related with ability of taking light by leaves (Muchow *et al.*, 1990). Determination of leaf area where transpiration and production taken place is significant in terms of yield (Saeed and El-Nadi, 1998). Plant canopy temperature which associated with photosynthesis, stomatal conductance, water transmission etc. is significant selection criterion (Rashid *et al.*, 1999). Chlorophyll content and canopy temperature is important criteria for developing high content and cooler ability varieties (Babar *et al.*, 2006).

This study was carried out to determine relationships between physiological characteristics and yield of some maize varieties.

### Material and Methods

The experiment was carried out at the GAP International Agricultural Research and Training Center's experimental area during 2015 growing seasons in Diyarbakir, Turkey.

In the study 6 maize varieties were used as material. The experiment was laid out as randomized complete block design (RCBD) with four replications. Each plot consisted of four rows of 5 m length, between and within the row spacing were 0.70 m and 0.20 m respectively. Seeds were planted with combine drilling machine on 27<sup>th</sup> April, 2015 and all plots were treated with 20-20-0 composite fertilizer to provide 100 kg ha<sup>-1</sup> N and 100 kg ha<sup>-1</sup> P<sub>2</sub>O<sub>5</sub>. Just before the flowering, 100 kg ha<sup>-1</sup> N was applied as ammonium nitrate to the trial as an additional N source. Experimental plots were irrigated for the first time as sprinkler irrigation, the other irrigation was realized as furrow irrigation and repeated nine times at ten to twelve-days interval. Plots were harvested by hand and the harvests from the middle two rows of the plots were weighed and calculated for grain yield. The harvest was done on 29<sup>th</sup> of September. Statistical analysis were performed using JMP 5.0.1 statistical software (<http://www.jmp.com>) and the means were grouped with LSD<sub>(0.05)</sub> test. In the study chlorophyll content (SPAD values), leaf area index, stomatal conductance, plant canopy temperature and grain yield were observed.

**Chlorophyll content (SPAD values):** Observation was taken from randomly selected ten plants between 11<sup>00</sup> a.m - 15<sup>00</sup> p.m. at three different growing stage as pre-flowering, flowering and post-flowering by Minolta SPAD 502 chlorophyll meter.

**Leaf area index (LAI):** The observation was taken from each plots by LAI-2200 (LI-COR) Plant canopy analyzer.

**Canopy Temperature:** The observation was taken from each plots between 11<sup>00</sup> a.m - 15<sup>00</sup> p.m. by portable infrared thermometer (DT-8811H) according to methods of Reynolds et al, 2001.

**Stomatal conductance:** Observation was taken from randomly selected ten plants between 11<sup>00</sup> a.m - 15<sup>00</sup> p.m. by leaf porometer (Model SC-1).

## Results and Discussion

The analysis of variance of the investigated characteristics and the findings from the maize varieties are presented in Table 1 and Table 2.

The differences between varieties with respect to chlorophyll content were highly significant in terms of pre-flowering and flowering periods ( $p < 0.01$ ), the difference for post-flowering period was significant at ( $p < 0.01$ ) level (Table 1).

Table 1. Mean of Chlorophyll Content

Variety	Chlorophyll Content (SPAD)		
	Pre Flowering Chlorophyll Content (SPAD values)	Flowering Chlorophyll Content (SPAD values)	Post Flowering Chlorophyll Content (SPAD values)
PR31D24	45.05 b	49.70 c	51.03 c
SUERTO	39.45 d	49.30 c	53.05 bc
70MAY82	43.65 bc	53.38bc	56.05 ab
KALİPSO	50.88 a	55.95ab	57.80 a
P1921	47.13ab	58.08 a	56.25 ab
DKC6724	40.65 cd	52.53bc	53.45 bc
MEAN	44.47	53.15	54.60
LSD <sub>(0.05)</sub>	3.9**	4.20**	4.22*
CV(%)	5.82	5.24	5.13

\* The difference between the averages indicated by the same letter does not matter at 0.05

\*\* The difference between the averages indicated by the same letter does not matter at 0.01

From Table 1, it can be seen that the means of pre flowering period's chlorophyll contents changed from 39.45 to 50.88; Kalipso variety had highest chlorophyll content (50.88), while Suerto variety had lowest (39.45). The means of pre flowering chlorophyll contents was 44.47. Previous researchers found that significant differences in terms of pre flowering chlorophyll contents Akarken and Taş (2014), Erdal (2014).

The means of flowering period's chlorophyll contents changed from 49.30 to 58.08; P.1921 variety had highest chlorophyll content (58.08), while Suerto variety had lowest (49.30). The means of flowering chlorophyll contents was 53.15. P.1921 and Kalipso varieties had highest values and shared the same statistical group (Table 1). The results of the study in terms of flowering period's chlorophyll content was coincide with that of Akarken and Taş (2014), Erdal (2014). In terms of post-flowering chlorophyll contents, the means changed from 51.03 to 57.80; Kalipso variety had the highest value (57.80), while PR31D24 variety had the lowest value (51.03). The means of varieties were 54.60. KALİPSO, P.1921 and 70MAY82 varieties had highest values and shared the same statistical groups. The significant differences at post-flowering period were reported by Akarken and Taş (2014), Erdal (2014), Reynolds *et al.*, (1994).

When comparing the three periods, the results showed that chlorophyll content increased from pre flowering periods to post flowering periods for all varieties except P.1921. The highest values were obtained from post-flowering period, only P.1921 variety showed high value at flowering period. The correlation analysis showed that there were significant and positive correlations among grain yield and flowering period's chlorophyll content. This result coincide with results of Karademir *et al.*, (2009) who reported that direct positive effect of chlorophyll content on yield.

From Table 2 it can be seen that the means of leaf area index changed from 1.77 to 3.35; 70 MAY 82 variety had highest chlorophyll content (3.35), while Suerto variety had lowest (1.77). The means of leaf area index was 2.32. 70MAY82 and PR31D24 varieties had highest



leaf area index values and shared the same statistical group. These results coincide with the results of Karademir *et al.*, (2012), Elings, 2000; Koca and Turgut 2012; Gitelson *et al.*, (2003), Traore *et al.*, (2000) who reported positive relation between LAI and yield.

In terms of plant canopy temperature the means changed from 38.95 to 42.48; P.1921 variety had highest plant canopy temperature (42.48), while 70 MAY 82 variety had lowest (38.95). This findings coincide with previous studies. Reynold *et al.*, (1994) reported that there was positive relation between yield and low plant canopy temperature; Karademir *et al.*,(2012) reported that negative correlation between yield and canopy temperature.

From Table 2 it can be seen that the means of stomatal conductance changed from 66.29 to 107.43, Suerto variety had highest stomatal conductance (107.43), while Kalipso variety had lowest (66.29). The means of stomatal conductance was 85.17. Suerto and P.1921 varieties had highest stomatal conductance and shared the same statistical group. In crops decreasing stomatal conductance by closing stoma is important for protection against to drought stress (Chaves *et al.*, 2009; Arve *et al.*, 2011; Erdal, 2014). The results of this study is coincide with that of Erdal (2014) who reported that existence significant differences between genotypes, but not with those of Reynolds *et al.*, (1994) who found positive relation between stomatal conductance and yield. This situation may stemmed from growing varieties in different environment.

Table 2. Mean of Leaf Area Index (LAI), Plant Canopy Temperature, Stomatal Conductance and Yield

Variety	Leaf Area Index (LAI)	Plant Canopy Temperature (°C)	Stomatal Conductance (mmol/m <sup>2</sup> sn)	Yield (kg ha <sup>-1</sup> )
PR31D24	2.63 ab	40.25	90.36 ab	1375.1.6
SUERTO	2.02 b	40.80	107.43 a	12326.1
70MAY82	3.35 a	38.95	72.75 bc	13488.1
KALİPSO	1.77 b	40.65	66.29 c	14451.1
P1921	1.87 b	42.48	102.64 a	15181.0
DKC6724	2.28 b	39.85	70.54 bc	14621.9
MEAN	2.32	40.50	85.17	13969.9
LSD <sub>(0,05)</sub>	0.93*	ns	23.74**	ns
CV(%)	26.69	5.68	16.78	12.34

\* The difference between the averages indicated by the same letter does not matter at 0.05

\*\* The difference between the averages indicated by the same letter does not matter at 0.01

From Table 2 it can be seen that the means of grain yield changed from 12326.1 to 15181.0 kg ha<sup>-1</sup>, P.1921 variety had highest grain yield (15181.0 kg ha<sup>-1</sup>), while Suerto variety had lowest (12326.1 kg ha<sup>-1</sup>). The means of grain yield was 13969.9 kg ha<sup>-1</sup>. P.1921, KALİPSO and DKC6724 varieties had highest grain yield. These results are coincide with those of Howell *et al.*, (1996), Atakul *et al.*, (2014), Kılınç *et al.*, (2014), but the results of this research were higher than of Mankong (2000). This situation may stemmed from growing different varieties in different environment.

### Conclusion

The results of the study showed that leaf chlorophyll content, leaf area index and plant canopy temperature characteristics can be used as selection criterion in breeding programs. Because generally the varieties have high physiological values showed higher yields and these results confirmed by previous researchers who reported that physiological parameters significant for yield. In terms of varieties P.1921, DKC6724 and KALİPSO varieties were promising varieties fort that region.

## References

- Akarken, N., Taş, T., 2014, Determination of Leaf Chlorophyll Density in Some Maize Inbred Lines. International Mesopotamia Agriculture Congress / 22-25 September 2014 Diyarbakır – Turkey. P: 967
- Amthor JS. 2001. Effects of Atmospheric CO<sub>2</sub> concentration on Wheat Yield: Review Of Results From Experiments Using Various Approaches To Control CO<sub>2</sub> Concentration. Field Crops Research, 73: 1-34.
- Anonymous, 2014. Turkish Statistical Institute. www.tuik.gov.tr.
- Anonymous, 2014. Food and Agriculture Organization, www.faostat.org.
- Arve, L.E., Torre, S., Olsen, J.E., Tanino, K.K., 2011. Stomatal Responses to Drought Stress and Air Humidity, Abiotic Stress in Plants - Mechanisms and Adaptations, Shanker, A., (Ed.), InTech.
- Atakul, Ş., Kahraman, Ş., Kılınç, S. 2014. Determination Of a Single Hybrid Corn Genotypes Performance In Diyarbakır Conditions International Mesopotamia Agriculture Congress / 22-25 September 2014 Diyarbakır – Turkey. P: 387-392.
- Babar, M.A., Reynolds, M.P., Van Ginkel, M., Klat, A.R., Raun, W.R., Stone, M.L., 2006. Spectral reflectance to estimate genetic variation for in-season biomass, leaf chlorophyll, and canopy temperature in wheat. Crop Sci., 46 (3): 1046-1057.
- Bavec, F., Bavec, M., 2001. Chlorophyll meter readings of winter wheat cultivars and grain yield prediction. commun. Soil Sci. Plant Anal. Res., 32: 2709–2719.
- Chaves, M.M., Flexas, J., Pinheiro, C., 2009. Photosynthesis under drought and salt stress: regulation mechanisms from whole plant to cell. Annals of Botany. 103:551–560.
- Chimenti, C.A., Marcantonio, M. and Hall, A.J., 2006. Divergent selection for osmotic adjustment results in improved drought tolerance in maize (*Zea mays* L.) in both early growth and flowering phases. Field Crops Research. 95: 305-315
- Elings, A., 2000. Estimation of leaf area in tropical maize. Agronomy Journal 92: 436–444.
- Erdal, Ş., 2014. Determination of drought tolerance level of maize (*zea mays*l.) inbred lines and molecular characterization, PhD Thesis, Süleyman Demirel University , Isparta
- Fischer, R.A., Rees, D., Sayre, K.D., Lu, Z.M., Condon, A.G., Larque-Saavedra, A., 1998. Wheat yield progress is associated with higher stomatal conductance and photosynthetic rate, and cooler canopies. Crop Sci., 38:1467-1475.
- Gitelson, A.A., Vina, A., Arkebauer, T.J., Rundquist, D.C., Keydan, G., Leavitt, B., 2003. Remote estimation of leaf area index and green leaf biomass in maize canopies. Geophysical Research Letters, 30:5:1248.
- Hafid, R.E., Smith, D.H., Karrou, M., Samir, K., 1998. Morphological attributes associated with early-season drought tolerance in spring durum wheat in a mediterranean environment. Euphytica, 101:273-282.
- Howell, T.A., Evett, S.R., Tolk, J.A., Schneider, A.D. And Steiner, J.L., 1996. Evapotranspiration of corn – southern high plains. American Society of Agricultural Engineers, 158 – 166.
- Jackson, P.A., Robertson, M., Cooper, M., Hammer, G., 1996. The role of physiological understanding in plant breeding: from a breeding perspective. Field Crops Res. 37:11-23.
- Karademir Ç., Karademir E, Çopur O., Gençer O., 2012 b. Effect of drought stress on leaf area in cotton (*Gossypium hirsutum* L.). 11th Meeting of Inter-Regional Cooperative Research Network on Cotton for the Mediterranean and Middle East Regions. 5-7 November, Antalya

- Karademir E., Karademir Ç., Gençer O., 2012 a. Effect of heat stress on leaf area in cotton (*Gossypium hirsutum* L.). 11th Meeting of Inter-Regional Cooperative Research Network on Cotton for the Mediterranean and Middle East Regions. 5-7 November, Antalya.
- Karademir, Ç., Karademir, E., Ekinci, R., Gençer, O. 2009. Correlations and path coefficient analysis between leaf chlorophyll content, yield and yield components in cotton (*Gossypium hirsutum* L.) under drought stress conditions. *Notulae Botanicae Horti Agrobotanici Cluj-Napoca (ISI)* , 37 (2): 241-244.
- Karademir, E., Karademir, Ç., Ekinci, R., Başbağ, S., Başal H. 2012 c. Screening cotton varieties (*Gossypium hirsutum* L.) for heat tolerance under field conditions. *African Journal of Agricultural Research (ISI)*. 7(47): 6335-6342
- Kılınç, S., Atakul, Ş. and Kahraman, Ş. 2014. Determination Of Some Hybrid Maize Genotypes Adaptation and Consistency Capabilities International Mesopotamia Agriculture Congress / 22-25 September 2014 Diyarbakır – Turkey. P: 426-431.
- Koc, M., Barutcular, C., Genc, D., 2003. Photosynthesis and productivity of old and modern durum wheats in a Mediterranean Environment. *Crop Science*, 43(6):2089-2097.
- Koca, Y.O., Turgut İ. 2012. The Effect of Different Sowing date for Grain Yield, Dry Matter Accumulation, Leaf Area Index and Some Growth Parameters in Maize (*Zea mays* L.) Adnan Menderes University Journal of Agriculture Faculty 2012; 9(1) : 1 - 10
- Lopez-Castaneda, C., Richards, R.A., (1994). Variation in temperate cereals in rainfed environments II. phasic development and growth. *Field Crops Res.* 39:85-98.
- Mankong, M. C. 2000. Estimation of genetic coefficients of thai hybrid varieties for the CERES - Maize Model. [www.grad.cmu.oc.th/abstract](http://www.grad.cmu.oc.th/abstract)
- Muchow, R.C., Sinclair, T.R., Bennett, J.M., 1990. Temperature and solar radiation effects on potential maize yield across locations. *Agon. J.* 82:338-343.
- Rashid, A., Stark, J.C., Tanveer, A., Mustafa, T., 1999. Use of canopy temperature measurements as a screening tool for drought tolerance in spring wheat. *J. Agronomy & Crop Science* 182: 231-237.
- Reynolds, M.P., Nagarajan, S., Razzaque, M.A., Ageeb, O.A.A., 2001. Heat tolerance. application of physiology in wheat breeding. (Editorler: M.P. Reynolds, I. Ortiz-Monasterio., A. McNab). Mexico, DF, CIMMYT.
- Reynolds, MP., Balota, M., Delgado, M.I.B., Amani I., and Fischer, R.A., 1994. Physiological and morphological traits associated with spring wheat yield under hot, irrigated Conditions. *Australian Journal of Plant Physiology* 21(6): 717-730 .
- Saeed, I.A.M., and El-Nadi, .H., 1998. Forage sorghum yield and water use efficiency under variable irrigation. *Irrig Sci*, 18: 67–71.
- Saini, H.S., and Westgate, M.E., 1999. Reproductive growth in grain crops during drought. *Advances in Agronomy.* 68 : 59-96
- Soltani, A., Galeshi, S., 2002. Importance of rapid canopy closure for wheat production in a temperate sub-humid environment: experimentation and simulation. *Field Crops Research*, 77:17-30
- Traore, S.B., Carlson, R.E., Pilcher, C.D., Rice, M.E., 2000. Bt and non- bt maize growth and development as affected by temperature and drought Stres. *Agronomy Journal* 92: 1027–1035.
- Yıldırım, M., Akıncı, C., Koç, M., Barutçular, C., 2009. Applicability of Canopy Temperature Depression and Chlorophyll Content in Durum Wheat Breeding. *Anadolu J.Agric Sci.* 24(3):158-166.

## PEST SPECIES IN CHESTNUT GROWING AREAS OF IZMIR AND MANISA PROVINCES AND THEIR ECONOMIC IMPORTANCE

Cevdet KAPLAN<sup>1</sup>, Tefvik TURANLI<sup>2</sup>, N. Mükerrerem ÇELİKER<sup>2</sup>

<sup>1</sup>Siirt University, Faculty of Agriculture, Department of Plant Protection, Siirt, Turkey

<sup>2</sup>Directorate of Plant Protection Research Institute, Bornova-Izmir, Turkey

\*Corresponding author: cevdetkaplan@siirt.edu.tr

### Abstract

The European chestnut (*Castanea sativa* Miller) is a native species of Turkey that grows in the coastal Black Sea, Marmara and Aegean regions and has a great economic importance. Insect pests cause significant economic yield losses in the chestnut. This study was carried out in order to determine the pest species in chestnut areas of Izmir and Manisa provinces of Turkey in the period 2012-2014 and their economic importance. Sampling was performed in 52 chestnut orchards in total of 4 districts. The knocking method, visual checking and pheromone traps were used in the determination of the species. As a result of the study on the most widespread and most common pest species, the following species were found to be economically significant: *Stephanitis pyri* F. (Het.: Tingidae), *Lachmus roboris* L. (Hem.: Lachnidae), *Alebra albostriella* (Fall.), *Zyginella pulchra* Low (Hem.: Cicadellidae) in the leaves, *Parthenolecanium rufulum* (Cockerell) (Hem.: Coccidae) in the leaves and shoots, *Cydia splendana* (Hbn.), *Pammene fasciana* L. (Lep.: Tortricidae) and *Curculio elephas* Gyll. (Col.: Curculionidae) causing damage to the fruit and *Coccus coccus* L. (Lep.:Coccidae), *Synanthedon vespiformis* L. (Lep.: Aegeridae), *Morinus funereus* Mulsantand, *Prionus basicanus* Fairmaire (Col.: Cerambycidae) causing damage to the woody tissues. It was observed that chestnut cancer (*Cryphonectria parasitica* (Murrill) Barr) was also common in the areas where the study was conducted. It was determined that chestnut cancer was widespread and tree dryness was common in the chestnut areas where woody tissue-harming pests, such as *C. coccus* and *S. vespiformis* were common. *C. splendana* and *C. elephas* usually cause harm in orchards that are at lower elevations and close to settlements. They also cause a significant labour loss as a result of observing wormy fruits at chestnut enterprises. Thus, *C. coccus*, *S. vespiformis*, *C. splendana*, *C. elephas* species are the most significant species that cause economic loss. Alternative control methods against these pests must be developed in the near future.

**Keywords:** *Chestnut, pests, economic importance, Turkey.*

### Introduction

Chestnut (*Castanea sativa* Mill.) is mixed especially with leafy plant species such as oak, hornbeam, beech and linden in the Marmara and Northern Anatolia regions in Turkey. It has a local natural distribution in the Aegean and Mediterranean regions, but it is mostly cultured. Chestnut growing is common in Izmir (Beydağ, Ödemiş, Tire) and Aydın (Nazilli) provinces in the Aegean region (Mağden 1950, Delen 1979, Seçkin 1981).

Chestnut, an important tree species with economic importance in the Mediterranean region, is used in the food industry, as timber in the wood industry and also for landscaping purposes (Santos et al.,2014).

There are 2 008 thousand chestnut trees at the age of fructiferous in Turkey, and 63 750 tons of chestnut are produced (Anonymous, 2015). Turkey is ranked as the second in the world in

terms of chestnut production after China, the biggest chestnut producer in the world. Turkey accounts for about 3% of the world chestnut production. The Aegean region provides about 61% of Turkey's chestnut production. Chestnut is economically produced in Beydağ and Ödemiş districts of Izmir and constitutes the main source of living for producers.

Some insect pests in chestnut areas lead to a decrease in fruit quality and weakening of trees and even drying of them over time by causing significant damages in the fruits, trunk, branches, and shoots, in woody tissue and leaves in chestnut trees (Kaplan and Turanlı, 2011). In recent years, complaints have been continuously received from producers regarding the insect pests in chestnut. Studies on the determination of insect pests in chestnut and the loss ratios of some species in the Aegean region (Önuçar and Ulu 1987; Karagöz and Gençsoylu, 2004) were previously carried out. However, these studies were carried out in a local and narrow area. Therefore, it is necessary to carry out such studies in wider areas.

In this paper, the pest species determined by the observations made in chestnut areas of Izmir (Beydağ, Ödemiş and Kemalpaşa districts) and Manisa provinces in the Aegean region in the period 2012-2014 were evaluated, and information about their economic importance was given.

### Material and Methods

This study was carried out in order to determine the pest species in chestnut areas of Izmir (Beydağ, Kemalpaşa, and Ödemiş) and Manisa (Turgutlu) provinces in the Aegean region (Turkey) in a total of 52 chestnut orchards in the period of 2012-2014 and their economic importance.

The surveys were conducted weekly or bi-weekly in the periods during which the pests were intense in April and November. At first, a general observation was made in each chestnut orchard and then the trees at different points to represent the chestnut orchard were checked. The study of Lazarov and Grigorov (1958) was used in the determination of the number of trees examined during surveys. The visual checking, knocking method, pheromone traps and branch counting method were used in the determination of pest species. Fruit samples were taken in some chestnut orchards during the harvesting period, they were cultured, and the adults of the worms inside the fruits were obtained.

### Results and Discussion

As a result of the study carried out, a total of 33 insect pests species of different orders and families were determined in the chestnut areas of Izmir and Manisa provinces between the period of 2012-2014 (Table 1). From among the pest species, about 11 species causing significant economic losses were determined. The parts of the chestnut trees (leaf, fruit, root, trunk, and branches) on which the species causing significant economic losses are fed were assessed in 3 groups by considering their behaviors. It was determined that the most widespread and important pest species were the species causing damage in the tissue in the trunk and branches.

It was determined that *Coccus coccus* L., *Synanthedon vespiformis* L. and *Prionus basicanus* Fairmaire were the species causing damage to the woody tissues in the trunk and branches of chestnut trees, *Cydia splendana* (Hbn.), *Pammene fasciana* L. and *Curculio elephas* Gyll. were the species causing fruit to get wormy, *Stephanitis pyri* F., *Lachmus roboris* L., *Alebra albostriella* (Fall.) and *Zyginella pulchra* Low were the species causing significant damages in the leaves of trees, and *Parthenolecanium rufulum* (Cockerell) was important pest species in the leaves and shoots.

## Important species causing damage to the woody tissues in the root, trunk, and branches of chestnut trees

*Synanthedon vespiformis* (L.), this pest was found in all chestnut areas of Izmir and Manisa provinces. The damage caused by its larva by feeding between the barked and woody layer of trees was found to be significant. In particular, this pest was observed to be more common in the trees in orchards where chestnut cancer (*Cryphonectria parasitica*) was found. The signs suggestive of yellowing, growth deficiency and graft incompatibility were found in some branches and leaves of trees on which the larvae were found. It was determined that larvae were mainly intense in the parts where the lateral branches connected to the trunk, and that fluid flow was observed in these parts during summer.

It was observed that the flight of adults of *S. vespiformis* continued in pheromone traps in the orchards from the end of June to the end of October. Adult flight became intense between the first week of July and the first week of October. It was determined in previous studies that this species caused significant economic losses to the woody tissues in the chestnut areas of Izmir province (Önuçar and Ulu, 1987) and in the chestnut areas of Aydın province (Karagöz and Gençsoylu, 2004).

Table 1. Pest species determined in the chestnut areas of Izmir and Manisa provinces in the period 2012-2014

Order	Family	Species
Dermoptera	Forficulidae	<i>Forficula auricularia</i> L.
Heteroptera	Cercopidae	<i>Aphrophora alni</i> Fall.
		<i>Neophilaenus campestris</i> (Fall.)
	Cicadellidae	<i>Alebra albostriella</i> (fall.)
		<i>Asymetresca decedens</i> (Paoli)
		<i>Dryodurgades reticulatus</i> (H.S.)
		<i>Ribautiana</i> sp.
		<i>Zyginella pulchra</i> Löw.
	Cicadidae	<i>Lyrise splebejus</i> (Scopoli)
	Tingidae	<i>Stephanistis pyri</i>
	Cixiidae	<i>Reptalus horridus</i> (Linn.)
Psyllidae	<i>Cyamophila odontopy</i> Log.	
Lachnidae	<i>Lachnus roboris</i> L.	
Coleoptera	Curculionidae	<i>Allandrus</i> sp.
		<i>Aspidiapion radiolus</i> Kirby
		<i>Oxystoma cracca</i> L.
		<i>Protapionnigritarse</i> Kirby
		<i>Squamapion</i> sp.
		<i>Euthrichapion</i> sp.
		<i>Polydrusus (Conocetus)</i> sp.
		<i>Curculio elephas</i> Gyll.
		<i>Phyllobius rufitarsis</i> Po.
		<i>Polydrusus gracilicornis</i> Kies.
	Cerambycidae	<i>Morinus funereus</i> Mulsantand
		<i>Prionus basicanus</i> Fairmaire
	Scarabaeidae	<i>Anomola osmanlis</i> Bch.
		<i>Polyphylla fullo</i> L.
	<i>Potosia speciosa</i> Ad.	
Lepidoptera	Aegeriidae	<i>Synanthedon vespiformis</i> (L.)
	Gracilariidae	<i>Phyllonorycter messaniella</i> Zell.
	Lymantridae	<i>Euproctis chrysoorrhoea</i> L.
	Tortricidae	<i>Cydia splendana</i> (Hbn.)
<i>Pammene fasciana</i> (L.)		

*Cossus cossus* L., in recent years, its intensity in the chestnut areas in Izmir and Manisa provinces has increased, and it has become a significant pest. It has been more intensely observed in the trees in orchards where chestnut cancer (*C. parasitica*) is found.

It was found that the adult density of *C. cossus* was low in pheromone traps in chestnut orchards. The adult flight was determined to be between June and September. However, it was determined in the observations that the larvae density of the pest was high and that the larvae in different periods during the year were present together in tree trunks and branches. It was determined that the larvae passed to the main trunk and came closer to the soil as the larva stage progressed. It was observed that late-period larvae opened big galleries in the parts where trees' trunks touched the soil at the end of June and in July. Indeed, Anonymous (2008) states that *C. cossus* spends the winter inside the galleries it opens in the root-crown, trunks and thick branches of the trees in the larva period, its adults emerge towards the end of June, cause damage especially in neglected orchards, its larvae cause damage to the trunk and branches of trees closer to the soil by opening galleries, and also cause significant damages by carving the bottom of the tree trunks all around at 10-15 cm soil depth and by destroying transmission pipes, and cause trees to get dry within a few years if they are not controlled.

### **Important species causing damage to chestnut fruits**

As a result of the study, *Cydia splendana* (Hbn) and *Curculio elephas* (Gyllenhal)) were determined to be the pests that cause damage to chestnut fruits and the loss of quality. *Pammene faciana* L. causing getting wormy in chestnut hedgehogs and fruits in the early period was also found.

*Pammene faciana* L. was determined in all districts where the studies were carried out. Its adult flight was determined to be in July. It was determined that its first damage was found in the period during which the hedgehogs had 0.8 cm external diameter and 0.3 cm internal diameter and that a larva damaged more than one hedgehog.

*Cydia splendana* (Hbn) causes significant damages to chestnut fruits. It is especially more common in orchards that are at lower elevations and close to village settlements. It is a pest species to which pesticide is applied by producers. It was found in most of the orchards controlled. Its loss ratio was found to be higher in wild species. It was observed that its adults flowed from the first week of July to the middle of October, the harvest time, in nature and that the highest adult emergence was in the last week of August and in the third week of September.

*Curculio elephas* (Gyll.) was not found to be considerably widespread and intense in the observed orchards. However, its adults were determined during knocking performed in a number of orchards in Beydağ district. A large number of *C. elephas*-infected fruits were determined in the fruit samples taken in chestnut processing plants during the harvest period. In the study carried out, it was observed that chestnut growers applied post-harvest burial spraying against inner fruit worms and some growers applied green part spraying after observing adults in July-August.

In previous studies, Önuçar and Ulu (1987) determined that *P. faciana* (L.) mainly caused damage to hedgehogs in chestnuts in Izmir province, that *C. splendana* (Hbn) and *C. elephas* (Gyll.) directly caused damage to the fruits and that *P. faciana* and two other pests caused getting wormy in hedgehogs by 15.28% and in fruits by 15.70%, respectively, Karagöz et al. (2007) determined that 15-20% of the total annual production was lost due to the damage caused by *C. splendana* and *C. elephas*, and Speranza and Paparatti (2009) determined that chestnut inner worms were the main pests in Italy, that *Curculio elephas* (Gyll.) and *C. Propinquus* (Desbr.) were found by 5% and 95%, respectively, and that yield loss was between 20-90% due to these species.

### **Important species causing damage to leaves in chestnut trees**

*Stephanistis pyri* F., It was determined to be the most important species causing damage to leaves in chestnut trees. It was found in all chestnut orchards controlled. This pest can be observed in chestnut trees from May to November. It was observed that the density of *S. pyri* reached the highest value during the period between the end of August and the end of September. Karagöz and Gençsoylu (2003) state that this species is the important pest species in chestnut areas in Aydın province. The adults of *S. pyri* reduce the yield and quality since the leaves will not be able to perform their physiological functions because of yellowing on the top surface of the leaves in chestnut trees as a result of laying eggs, puncture in the leaf epidermis, covering of the leaves with a black substance and because their wastes stick on the surfaces of leaves. Önder and Lodos (1983) point out that *S. pyri* causes harm in different forests and fruit trees.

*Lachmus roboris* L, It was found in most of the chestnut orchards where studies were carried out in Izmir and Manisa provinces. It was found in the hedgehog's stem and bottom parts in colonies in shooting ends of chestnut trees. It was determined that there was an increase in the density of *L. roboris* in the period between mid-September and early October and that they were fed with the sweetish substance extracted by ants by coming together in the shoots they exist. Bürges and Çal (1982) determined that *L. roboris* is among the species which are considered to be economically important in chestnut orchards in Hungary and lead to defoliation in young leaves when they are intense and fed in the buds of young leaves, Önuçar and Ulu (1987); Karagöz and Gençsoylu (2004) found that this species is economically important in leaves in the orchards of Izmir (Ödemiş and Tire districts) and in Aydın provinces, respectively.

*Alebra alostriella* (Fall.), It was observed that the density of this species increased between the end of July and the end of September. It was found more especially in chestnut orchards at 800-1100 m elevations. In the leaves of the trees on which *A. alostriella* was intense, it was observed that light-coloured areas emerged in the sucking zones of the pest and leaves were yellowed like spots and defoliated earlier.

### **Important species causing damage to leaves and shoots in chestnut trees**

*Parthenolecanium rufulum* (Cockerell), It was only found in the chestnut orchards in Kemalpaşa (Izmir) and Turgutlu (Manisa) districts where sampling was performed. It was determined that 5.66% of the controlled orchards were infected with the pest. It was determined that the pests were not very common in chestnut areas but were intense in chestnuts around oak forests.

In previous studies, it was determined that *P. rufulum* gave one generation per year in the Aegean region and spent the winter on 1-2 year shoots in the 2nd nymph period. Adult females are formed towards the end of April. It was determined that egg hatching started at the end of June and lasted about two weeks (Kaplan et al., 2016). Ecevit et al. (1987) determined that egg hatching of *P. rufulum* in hazelnut in the Black Sea region started in late June and that egg-laying adults emerged at the end of April, in mid-May and continued for 58 days. Rainato & Pellizzari (2009) state that *P. rufulum* on *Quercus robur* in Italy gives one generation per year, spends the winter in the 2nd nymph period, female adults begin to appear in the middle of April, their females lay eggs between the end of April and the end of May, and that egg hatching is at the end of May.

### **Conclusions**

In conclusion, 11 pest species causing economic damages depending on orchards and region were determined in the chestnut areas of Izmir and Manisa provinces of Turkey. It was determined that the species causing damage to the tissue around the branch, trunk and root-



crown were mainly observed in orchards where there were trees with chestnut cancer and that inner fruit worms were less in grafted varieties and more in wild varieties. It has been concluded that cultural precautions are important in reducing the density of the pest species and will be effective if they are applied by all producers in large areas. Chestnut areas in Turkey, by topographic structure, are the places where chemicals are applied at the least, and there is a certain natural balance. Eco-friendly biotechnical struggle studies such as mass trapping and confusion technique should be carried out against *C. splendana*, *C. elephas*, *S. vespiformis* and *C. cossus* and their results should be put into practice.

#### Acknowledgements

This study was supported by Izmir Directorate of Special Provincial Administration. We would like to thank Prof. Dr. Hüseyin BAŞPINAR (Adnan Menderes University, Faculty of Agriculture, Department of Plant Protection, Aydın) who identified Cicadellidae species, Prof. Dr. Göksel TOZLU who identified Cerambycidae species and Prof. Dr. Levent GÜLTEKİN (Atatürk University, Faculty of Agriculture, Department of Plant Protection, Erzurum) who identified Curculionidae species.

#### References

- Anonymous (2008). Zirai Mücadele Teknik Talimatları, Cilt 4 [Agricultural Control Technical Instructions, Volume 4]. Tarım ve Köyişleri Bakanlığı Tarımsal Araştırmalar Genel Müdürlüğü, Ankara
- Anonymous (2015). Türkiye İstatistik Kurumu (TÜİK) Bitkisel Üretim İstatistikleri [Turkey Statistical Institute (TÜİK) Plant Production Statistics]. <http://www.tuik.gov.tr>, (Date accessed: 20.10.2015).
- Bürges G., Gal T. (1982). Ometterie de teroteri della biocenosi del castagno: note bioecologiche. Mem. Soc. Ent. Ital., 60 (2):105-110 p.
- Delen N.(1979). Kestane kanseri (*Endothia parasitica* (Murill) Anderson and Anderson) Hastalığın Yayılışı ve Biyolojisi [Spread and Biology of Chestnut cancer (*Endothia parasitica* (Murill) Anderson and Anderson) Disease]. T.C. Gıda-Tarım ve Hay. Bak. Zir. Müc. Zir. Kar. Gn. Md. Araş. Eserl. Ser. No: 36,110 p.
- Ecevit O., Işık M., Yılmaz F. (1987). Fındıklarda zararlı fındık koşnili *Parthenolecanium corni* ve *P.rufulum* ile virgül kabuklu biti *Lepidosaphes ulmi*'nin biyoekolojik özellikleri ve fındık koşnilinin mücadele metotları üzerine araştırmalar [Studies on the bioecological features of hazelnut *coccoidea* *Parthenolecanium corni* and *P. rufulum* and comma scale insect *Lepidosaphes ulmi* causing damage to hazelnut and on the methods of controlling hazelnut *coccoidea*]. 19 Mayıs Üniversitesi yayınları No: 19, 34 p.
- Kaplan C.,Turanlı T. (2011). Ege Bölgesi kestane alanlarındaki zararlı böcek türleri ve mücadelesi [Insect pest species in chestnut areas in the Aegean region and control of them]. Türkiye I. Orman Entomolojisi ve Patolojisi Sempozyumu, Antalya, 131-136 p.
- Kaplan C., Turanlı T. (2016). İzmir ve Manisa illeri kestane ağaçlarında *Parthenolecanium rufulum* (Cockerell) (Hemiptera: Coccidae)'un yayılışı biyolojisi ve doğal düşmanların belirlenmesi [Determination of the distribution, some biological characteristics and natural enemies of *Parthenolecanium rufulum* (Cockerell) (Hemiptera: Coccidae) harmful to Chestnut trees in İzmir and Manisa provinces in Turkey]. Türkiye Entomoloji Dergisi, 40 (3): 331-343.
- Karagöz M., Gençsoylu İ. (2004). Aydın ili kestane yetiştirme alanlarında zararlı ve yararlı türler ve ekonomik önemleri [Harmful and beneficial species in chestnut growing areas in Aydın province and their economic importance], Türkiye I. Bitki Koruma Kongresi, Samsun, 109 p.

- Lazarov H., Grigorov S.(1958). Entomologia. Zemizdat, Sofia 453 pp.
- Mağden R. Z.(1950). Özel Meyvecilik Kitabı [Special Fruit Growing Book], 173 p.
- Önuçar A., Ulu O. (1987). İzmir İli Çevresindeki Kestane Yetiştirme Alanlarında Fauna Tespiti ve Meyvelerde Kurtlanmaya Neden Olan Zararlılar ile Savaşım Olanakları Üzerinde Araştırmalar [Studies on the Fauna Detection in Chestnut Growing Areas around Izmir province and the Pests Causing Getting Wormy in Fruits and the Possibilities of Controlling], Türkiye Bilimsel ve Teknik Araştırma Kurumu Tarım ve Ormancılık Araştırma Grubu Proje No: TOAG-523 (Sonuç raporu). 119 p.
- Önder F.,Lodos N. (1983). Preliminary List of Tingidae With Notes on Distribution and Importance of Species in Turkey. Ege Üniv. Zir. Fak. Yay. No:449,51ps.
- Rainato A., Pellizzari G. (2009). Observations on biology of Parthenolecanium rufulum (Cockerell, 1903) (Hemiptera: Coccoidea: Coccidae) in North-eastern Italy. XI International Symposium on Scale Insect Studies, 24-27 September, Oeiras, Portugal, Pp: 37-38.
- Santos C., Machado H., Correia I., Gomes F., Gomes-Laranjo J., Costa R., (2014). Phenotyping Castanea hybrids for Phytophthora cinnamomi resistance. Plant Pathol. Early View, Doi: 10.1111/ppa.12313
- Seçkin E. (1981). Bursa İli Kestanelerinde (Castanea sativa Mill.) Zarar Yapan Tortiricidae (Lepidoptera) Familyası Türleri, Tanınmaları, Zararları, Kısa Biyolojileri ve Doğal Düşmanları Üzerinde Araştırmalar [Studies on the Species, Recognition, Losses, Short Biology and Natural Enemies of the Tortiricidae (Lepidoptera) Family Causing damage to Chestnuts in Bursa Province (Castanea sativa Mill.)]. T.C. Gıda-Tarım ve Hay. Bak. Zir. Müc. Zir. Kar. Gn. Md. Araş. Eserl. Ser. No: 16,122 p.
- Speranza S., Paparatti B. (2009). Chemical control of Chesnut weevil in Center Italy. 1st European Congress on Chestnut-Castanea,2009, 411-413 p.

## ECONOMIC ANALYSIS OF FERTILIZATION IN THE RANGELANDS BY NUTRITIONAL VALUE: A NEW OPINION

Duygu ALGAN<sup>1</sup>, Ibrahim AYDIN<sup>1\*</sup>, Nuh OCAK<sup>2</sup>

<sup>1</sup>Department of Field Crops, Faculty of Agriculture, University of Ondokuz Mayıs, 55139, Kurupelit, Samsun, Turkey

<sup>2</sup>Department of Animal Science, Faculty of Agriculture, University of Ondokuz Mayıs, 55139, Kurupelit, Samsun, Turkey

\*Corresponding author: iaydin@omu.edu.tr

### Abstract

Total production cost can increase, whereas total revenue and net benefit may reduce, due to an increase in custom fertilizer application cost in a degraded rangelands subjected to mineral fertilization. Therefore, to highlight the benefit response to applications of N, P and K on such a rangeland, the profit or loss was compared in three economic analyses. The data were obtained from an experiment organized during 2013-2015 to increase the productive potential of the rangeland, by fertilization composed of three nitrogen (0, 60 and 120 kg N ha<sup>-1</sup>) and phosphorus (0, 60 and 120 kg P ha<sup>-1</sup>) and two potassium (0 and 80 kg K ha<sup>-1</sup>) rates. In all economical analysis were used total production cost (labour, mineral fertilizers, etc.), total revenue based on hay yield and price (HYP), the relative feed value (RFV) index as a tool for evaluating and marketing (RFVP) or conversion rate of consumable crude protein to meat on the hoof in cow-calf (CMP). The net benefit was higher in analysis based on CMP compared to other analysis. Moreover, the analyses based on HYP or RFVP had a lower profit or higher loss in the N up to 60 kg ha<sup>-1</sup>. Therefore, NPK fertilization rates did not increase forage production enough to be profitable for animal production based on hay yield or RFV precise. These results indicate that this comparison was important to farmers because they are interested in seeing the criteria required to obtain a given increase in net benefits.

**Keywords:** *Rangeland improvement, range fertilization economics, relative feed value, crude protein yield*

### Introduction

Rangelands, which compose ~69% of the world's dryland area (du Toit *et al.*, 2017) are the cheapest feed resource available for domestic ruminants (Louhaichi *et al.*, 2009). The feeding of sheep, goats and cattle is mainly based on the exploitation of rangeland resources in many parts of the world (Kohestani and Yeganeh, 2016; Uzun *et al.*, 2016). Therefore, degradation of rangelands subjected to heavy grazing for a long time is a serious problem in the countries like Turkey, due to the decreased proportion of land desirable for grazing plant species and the decreased density of plant or richness of species as a result of the elimination of the less grazing-tolerant species (Anderson and Hoffman, 2007; Uzun *et al.*, 2016). Rangeland rehabilitation and optimal exploitation are the most important scientific and technical efforts with various methods in range management (Kohestani and Yeganeh, 2016).

Because animal performance mainly depends on the quality of forage available to domestic ruminants (Amiri and Shariff, 2012), in practice, performance of animals reflects forage quality, which is a broader term that not only includes nutritive value, but also forage intake. The nutrient value of rangeland forages depends upon their ability to meet nutritional requirements of the grazing animals throughout the year (Amiri and Shariff, 2012).

Disturbances in promoting and maintaining diversity in rangelands are important in terms of forage quantity and quality determining grazing animal performance. In countries like Turkey, rangeland restoration is a goal of Governments with the enactment of the Rangeland Law. Fertilizers have been supplied by government and villagers have inconsiderately used fertilizer on the rangelands (Aydin and Uzun, 2005), because the most practical and effective method to increase the herbage quantity and quality in rangelands is by adequate fertilization with mineral compounds (Aydin and Uzun, 2005; Frame and Laidlaw, 2011). As result, it has increased the use of fertilizer inputs (ie. nitrogen, phosphorous and potassium shorthanded as 'NPK') to achieve that level of real production. The importance of fertilizers in delivering the productivity is still recognised in today's technological world, because rangeland management practices improve livestock productivity and also protect the environmental status. However, total production cost can increase, whereas total revenue and net benefit may reduce, due to an increase in custom fertilizer application cost in a degraded rangelands subjected to mineral fertilization. Today, a number of economic analyses models based on hay yield and price (HYP) or conversion rate of consumable crude protein to meat on the hoof in cow-calf (CMP) that determined economic returns of fertilization has been used for sustainable rangeland management (Guevara *et al.*, 2000; Islam and Adjesiwor, 2005). There is scarce information on whether the relative feed value (RFV) index as a tool for evaluating and marketing (RFVP) as economic analyses model was a new option that can be used. Furthermore, farmers are interested in seeing the criteria required to obtain a given increase in net benefits. Therefore, the aim of this study was the profit or loss was compared in three economic analysis models to highlight the benefit response to applications of NPK in terms of maintaining and improving rangelands degraded by overgrazing.

### Material and Methods

The data with respect to hay and protein yields, crude protein content and RFV of this research were obtained from a study carried out in a heavily grazed rangeland in Ondokuz Mayıs town of Samsun province, in Turkey (41° 29' 0" N, 36° 4' 0" E, elevation of 10 m) between 2013 and 2015 (Aydin *et al.* (2016). In this study, the effects of overseeding (unseeded and seeded) and fertilization composed of three nitrogen (0, 60 and 120 kg N ha<sup>-1</sup>) and phosphorous (0, 60 and 120 kg P ha<sup>-1</sup>) and two potassium (0 and 80 kg K ha<sup>-1</sup>) rates on yield and quality of overgrazed rangeland have been studied. As reported by Aydin *et al.* (2016), total precipitation and mean temperature were 578.3 mm and 16.0 °C in the first year and 776.2 mm and 15.5 °C in the second year of the experiment. Soil characteristics of experimental area were as follows: soil texture is loamy; organic matter content is 2.1%; extractable P is 2.6 mg kg<sup>-1</sup>; K extraction is 43.0 mg kg<sup>-1</sup>; saturation extract pH is 7.1. The botanical composition of the experimental area consisted of 20% legume, 35% grass and 45% other family plants. The studied rangeland had a ratio of desirable perennial plant species of 10%. In this study, 18 different fertilizer combinations (N<sub>0</sub>P<sub>0</sub>K<sub>0</sub>, N<sub>0</sub>P<sub>0</sub>K<sub>80</sub>, N<sub>0</sub>P<sub>60</sub>K<sub>0</sub>, N<sub>0</sub>P<sub>60</sub>K<sub>80</sub>, N<sub>0</sub>P<sub>120</sub>K<sub>0</sub>, N<sub>0</sub>P<sub>120</sub>K<sub>80</sub>, N<sub>60</sub>P<sub>0</sub>K<sub>0</sub>, N<sub>60</sub>P<sub>0</sub>K<sub>80</sub>, N<sub>60</sub>P<sub>60</sub>K<sub>0</sub>, N<sub>60</sub>P<sub>60</sub>K<sub>80</sub>, N<sub>60</sub>P<sub>120</sub>K<sub>0</sub>, N<sub>60</sub>P<sub>120</sub>K<sub>80</sub>, N<sub>120</sub>P<sub>0</sub>K<sub>0</sub>, N<sub>120</sub>P<sub>0</sub>K<sub>80</sub>, N<sub>120</sub>P<sub>60</sub>K<sub>0</sub>, N<sub>120</sub>P<sub>60</sub>K<sub>80</sub>, N<sub>120</sub>P<sub>120</sub>K<sub>0</sub>, N<sub>120</sub>P<sub>120</sub>K<sub>80</sub>) were selected to support high-quality rangeland composition and growth and environmental stability. The assumptions of these economic analyses models were as follows, to use of fertilizers NPK to repair and to achieve greater production of good quality of forage in rangeland degraded, to utilize the forages from overgrown rangelands improved as hay, to evaluate the conversion rate to meat of forage CP consumed by the grazing animals, and to constitute from hay sale the benefits livestock owners get from the rangelands improved by a fertilizer. Therefore, the economic analysis models based on hay yield and price (HYP), the relative feed value (RFV) index as a tool for evaluating and marketing (RFVP) or conversion rate of consumable crude protein to

meat on the hoof in cow-calf (CMP) were used to evaluate the profitability (profit or loss) of 18 different fertilizer combinations. Because to determine a fertilization profitability therefore was required the comparison of costs and returns from economical analyses models, in all economical analyses models were used total production cost (Table 1) and total revenue. Net benefit was calculated using the following equation:

Profit/loss ( $\$ \text{ ha}^{-1}$ ) = total revenue – total production cost (Islam and Adjesiwor, 2005).

All Turkish lira amounts are converted into today's or “present” the United States dollar (\$) terms due to the fact that most financial inputs (e.g. prices and costs) and production inputs (e.g. yields, product quality) can be readily varied on a yearly basis. Price data for fertilizers were obtained from local sources in central Samsun. As known, the RFV is an index representing forage quality and is one of the systems used by forage testing laboratories for many years. Thus, the higher the RFV is the higher the quality, and consequently, this means a higher price for that hay. Hay buyers and sellers have used this index for estimating hay quality (Newman *et al.*, 2014). The prices of hay based on RFV as a tool for evaluating and marketing (RFVP) is estimated by using the regression equation:

$$\text{RFVP} (\$ \text{ kg}^{-1}) = 5 + 0.5x,$$

where x is RFV of produced hay. This equation was based on the prices of hays with the lowest RFV (e.g. wheat straw) and the highest RFV (e.g. alfalfa hay) in Turkey during the last three years. The conversion rate of consumable crude protein to meat on the hoof in cow-calf was assumed to be 1.8 kg (NRC, 1996; Aydin and Uzun, 2005).

Table 1. Parameters and prices used in cost and revenue estimation are shown in Table 1.

Item	Unit	January 2017 Price (\$)
Fertilizers		
Ammonium nitrate	kg	0.21
Triple superphosphate	kg	0.57
Potassium sulphate	kg	1.16
Other expenditures		20% of fertilizer prices
Meat on the hoof	kg	4.45
Hay	kg	0.17

Data on hay and protein yields, crude protein content and RFV of rangeland were analyzed by one-way ANOVA with fertilization as the only factor. When differences appeared, Duncan's test was used at the  $P = 0.05$ . All statistical analysis was performed by means of SPSS 11.0 for Windows software (SPSS Inc., NY, USA).

## Results and Discussion

Although current findings revealed that, for high-dose N fertilization to be effective on HY of the rangelands (Table 2), the fertilizer with N should be composed of 60 kg N, 120 kg P, 80 kg K  $\text{ha}^{-1}$ , due to an adverse effect on botanical composition and long-term sustainable production (Aydin *et al.*, 2016). Both P and K fertilization (except for 80 kg K without N and P) without N increased the CP content of the rangelands. Because of high CP content of the rangelands fertilised by fertilizer with high-dose P and K without N or high HY of rangelands fertilised by fertilizer with high-dose N with or without P and K, the CPY of these rangelands had the greatest CPY. The results with respect to hay yields support idea that nitrogen fertilizer application was profitable but might not be sustainable in the long term (Islam and Adjesiwor, 2005).

Table 2. The hay and crude protein (CP) yields, CP content and relative feed value (RFV) of the overgrazed rangeland fertilized with different fertilizer combinations.

Fertilizer	Yield (kg ha <sup>-1</sup> ) of		CP content (g kg <sup>-1</sup> )	RFV
	Hay	CP		
N <sub>0</sub> P <sub>0</sub> K <sub>0</sub>	1837 i	286.9 i	156.2 de	115.3 abc
N <sub>0</sub> P <sub>0</sub> K <sub>80</sub>	2025 hi	333.7 hi	164.8 bcd	122.3 ab
N <sub>0</sub> P <sub>60</sub> K <sub>0</sub>	2171 ghi	373.4 h	172.0 ab	124.9 ab
N <sub>0</sub> P <sub>60</sub> K <sub>80</sub>	2679 fg	452.8 fg	169.0 abc	124.6 ab
N <sub>0</sub> P <sub>120</sub> K <sub>0</sub>	2736 fg	462.1 efg	168.9 abc	120.4 ab
N <sub>0</sub> P <sub>120</sub> K <sub>80</sub>	3107 df	556.5 bcd	179.1 a	128.1 a
N <sub>60</sub> P <sub>0</sub> K <sub>0</sub>	2457 gh	384.5 gh	156.5 de	111.1 b-f
N <sub>60</sub> P <sub>0</sub> K <sub>80</sub>	2601 fgh	407.1 gh	156.5 de	114.7 a-d
N <sub>60</sub> P <sub>60</sub> K <sub>0</sub>	3205 def	505.4 def	157.7 de	124.1 ab
N <sub>60</sub> P <sub>60</sub> K <sub>80</sub>	3376 cde	536.4 b-e	158.9 de	123.4 a-e
N <sub>60</sub> P <sub>120</sub> K <sub>0</sub>	3656 b-e	562.3 bcd	153.8 def	122.7 ab
N <sub>60</sub> P <sub>120</sub> K <sub>80</sub>	3727 bcd	610.1 ab	163.7 bcd	123.4 ab
N <sub>120</sub> P <sub>0</sub> K <sub>0</sub>	3479 cde	525.0 c-f	150.9 ef	100.6 d-g
N <sub>120</sub> P <sub>0</sub> K <sub>80</sub>	3603 b-e	553.8 bcd	153.7 def	101.0 g
N <sub>120</sub> P <sub>60</sub> K <sub>0</sub>	3677 b-e	555.6 bcd	151.1 ef	100.0 b-f
N <sub>120</sub> P <sub>60</sub> K <sub>80</sub>	3872 bc	590.5 abc	152.5 ef	103.4 c-g
N <sub>120</sub> P <sub>120</sub> K <sub>0</sub>	4153 ab	596.8 abc	143.7 f	98.8 fg
N <sub>120</sub> P <sub>120</sub> K <sub>80</sub>	4484 a	644.8 a	143.8 f	100.2 efg

a,b,c.. Values denoted by the different letter are significantly different (P<0.05).

The economic analysis models of the costs and benefits from adopting various combinations of fertilization practices indicate that profit and loss conservation can be comparable (Figure 1). Profit is equal the sum of maintenance cost, high productivity and persistence (Islam and Adjesiwor, 2005). Therefore, key indicators as the benefit to cost ratio and net present value must be positive for the analyzed practices taking account of the increases in forage yield and quality in terms of a common botanical composition and long-term sustainable production for various combinations of NPK fertilization. Indeed the highest net returns for HYP, CMP and RFVP were obtained from rangelands fertilized with the N<sub>120</sub>P<sub>0</sub>K<sub>0</sub>, N<sub>120</sub>P<sub>120</sub>K<sub>0</sub> and N<sub>60</sub>P<sub>120</sub>K<sub>0</sub> fertilizers, respectively (Figure 1). Although the HY almost double in fertilizer cases with N without quality share, the net benefits for all fertilization combinations was lower for HYP and RFVP analyses than for CMP model. Therefore, when based on the conversion rate to meat of forage CP consumed by the grazing animals, all fertilization combination used, except for N<sub>0</sub>P<sub>0</sub>K<sub>80</sub> were profitable for operations that dominate rangeland use in country like Turkey. Our belief was that improved knowledge and information will not only lead to better decisions of farms, but also to develop and support the use of economic models that inform government and corporate decisions. For a profit maximizing or cost minimizing, the profitability of fertilization can be provided some insights into the decisions to be made. While the profit for most ranchers is not the most important decision criterion in the economic sense, they can generally be assumed to prefer more income to less (Gentner and Tanaka, 2002).

After taking account of the botanical composition and long-term sustainable production (Aydin *et al.*, 2016), the profit of CMP analyse model was more profitable than the other two models by around twice. As in the present study, when rangelands were fertilized with mineral compounds to increase the herbage quantity and quality in rangelands (Aydin and Uzun, 2005; Frame and Laidlaw, 2011) has a serious effect on RFV. The results indicate that net benefit

based on RFVP and HYP falls by about \$8.12 and 10.38 (as average of application increased the HY) compared to CMP (\$39.31). Similar results were obtained for other applications; corresponding values of application that did not affect HY were \$0.84-1.51, and 16.36, respectively. This was because profitable results of fertilization based on CMP may be related to less profitable results based on HYP or RFVP. The profit or loss of both HYP and RFVP was resulted in estimated the improvements in rangeland degraded being almost the same as for the assumptions in the present study.

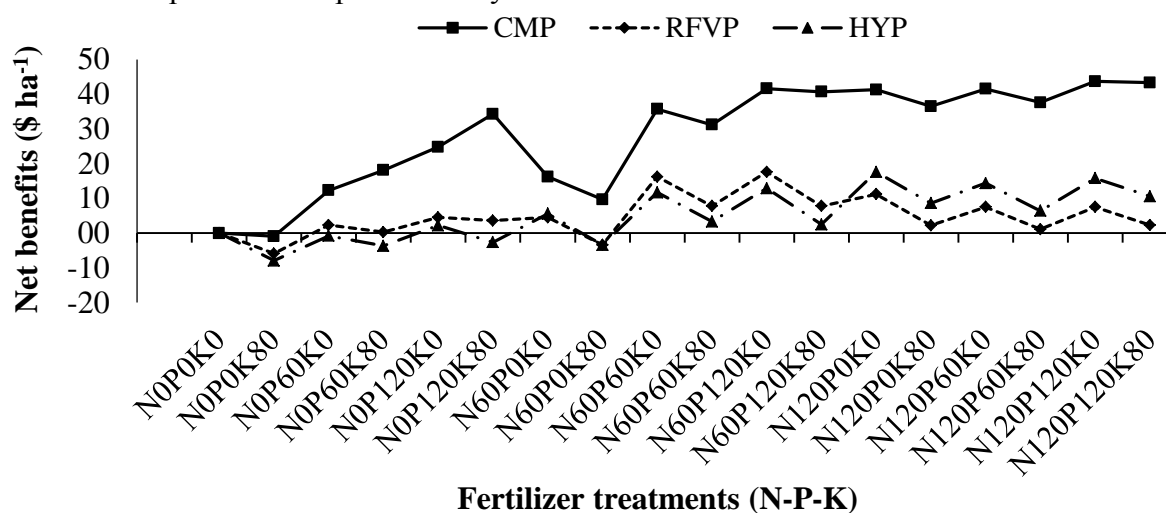


Figure 1. The net benefits from the heavily grazed rangeland fertilized with different fertilizer (NPK) combinations. The economic analysis models based on hay yield and price (HYP), the relative feed value (RFV) index as a tool for evaluating and marketing (RFVP) or conversion rate of consumable crude protein to meat on the hoof in cow-calf (CMP).

Selling the forages obtained from each fertilization application may be brought NPK combinations close to the profitability produced under the assumptions based on HYP or RFVP. Therefore, even with improvement provided in the rangeland degraded, studied NPK combinations were the least profitable in analyses based on HYP or RFVP. The sensitivity of profit or loss to hay yield, CP content and RFV was also tested. The sensitivity of RFV of the forages from the rangelands was more certain, although that of RFV for N<sub>120</sub> with or without P and K was lower than that of HYP. The results were shown to be more sensitive to assumed CMP and RFVP.

### Conclusions

The economic analysis models based on HYP and RFVP were reduced the net benefit compared to CMP. Except for N<sub>0</sub>P<sub>0</sub>K<sub>80</sub>, all the NPK combinations were produced higher net benefit in the analysis based on CMP. The reductions in net benefit due to the sale of hay from the rangelands fertilized by different NPK may be offset by weight gains of grazing animals and greater productivity of farms. The benefits of the economic analysis model based on RFVP that a new option was indicated to be small to make them worth adopting given the forages available, especially in the rangelands fertilized with high-dose N. In general, the economic analysis models based on HYP and RFVP was not to equate the value of the marginal product to the marginal factor costs. Therefore, it can be said that the grazing of animals in such rangelands may produce just enough income to cover the cost of producing it. The relative values of rangeland outputs have changed depending on the assumptions of the economic analysis models used. In today, questions should be focus on whether rangelands degraded were being managed for economic and ecological sustainability. Based on the

results, the precautions should be proposed to repair natural rangelands and achieve greater production of good quality of forage by using different agricultural practices.

### **Acknowledgments**

Financial support for this project was provided by The Scientific and Technological Research Council of Turkey (Project no: 112 O 742).

### **References**

- Amiri F., Shariff A.R.B.M. (2012). Comparison of nutritive values of grasses and legume species using forage quality index. *Songklanakarin Journal of Science and Technology*, 34(5), 577-586.
- Anderson P.M.L., Hoffman M.T. (2007). The impacts of sustained heavy grazing on plant diversity and composition in lowland and upland habitats across the Kamiesberg mountain range in the Succulent Karoo, South Africa. *Journal of Arid Environments*, 70(4), 686-700.
- Aydın İ., Olfaz M., Algan D. (2016). Effects of some improvement procedures on potential disease risks caused by yield, botanical composition and mineral balance of natural ranges. The Scientific and Technological Research Council of Turkey, TOVAG-1120742, Final Report of the Project, Samsun.
- Aydın I., Uzun F. (2005). Nitrogen and phosphorus fertilization of rangelands affects yield, forage quality and botanical composition. *European Journal of Agronomy*, 23(1), 8-14.
- du Toit J.T., Cross P.C., Valeix M. (2017). Managing the Livestock–Wildlife Interface on Rangelands. In *Rangeland Systems* (395-425). Springer International Publishing.
- Frame J., Laidlaw A.S. (2011). *Improved Grassland Management*, 2nd ed. The Crowood Press Ltd., Ramsbury, UK.
- Gentner B., Tanaka J.A. (2002). Classifying federal public land grazing permittees. *Journal of Range Management*, 55(1), 2-11.
- Guevara J.C., Carlos R.S., Oscar R.E., Le Houerou H.N. (2000). N and P fertilization on rangeland production in Midwest Argentina. *Journal of Range Management*, 53(4), 410-414.
- Islam M.A., Adjesiwor A.T. (2005). Grass, legumes, and grass-legume mixtures: yield, nutritive value, and soil water use. *Western Alfalfa&Forage Symposium*. Reno, Nevada. <http://alfalfa.ucdavis.edu/+symposium/proceedings/2015/Islam.pdf> Accessed on 05/06/2017.
- Kohestani N., Yeganeh H. (2016). Study the effects of range management plans on vegetation of summer rangelands of Mazandaran province Iran. *Journal of Rangeland Science*, 6(3), 195-204.
- Louhaichi M., Salkini A.K., Petersen S.L. (2009). Effect of small ruminant grazing on the plant community characteristics of semiarid Mediterranean ecosystems. *International Journal of Agriculture and Biology*, 11(6), 681-689.
- Newman Y.C., Adesogan A.T., Vendramini J., Sollenberger L. (2014). *Defining Forage Quality*. UF/IFAS Extension, SS-AGR-322, 1-5.
- NRC (1996). *Nutrient Requirements of Beef Cattle* (7th Ed.). National Academy Press, Washington, D.C.
- Uzun F., Ocak N., Şenel M.Z., Karadağ Y. (2016). The rates of desirable grazing plant species in rangelands: Effect of different animal species and grazing pressures. *Options Méditerranéennes. Série A, Séminaires Méditerranéens*, A114, 83-86.



## **DETERMINATION OF YIELD AND TECHNOLOGICAL PROPERTIES OF EARLY MATURING COTTON GENOTYPES**

Emine KARADEMİR<sup>1\*</sup>, Cetin KARADEMİR<sup>1</sup>, Remzi EKINCI<sup>2</sup>, Ugur SEVILMIS<sup>3</sup>

<sup>1\*</sup>Siirt University, Faculty of Agriculture, Department of Field Crops, Siirt, Turkey

<sup>2</sup>Dicle University, Faculty of Agriculture, Department of Field Crops, Diyarbakir, Turkey

<sup>3</sup>Eastern Mediterranean Agricultural Research Institute, Adana, Turkey

\*Corresponding author: eminekarademir@siirt.edu.tr

### **Abstract**

The objective of this study was to determine yield and quality parameters of some early maturing cotton genotypes by comparing them with control cultivars. The study was carried out at the GAP International Agricultural Research and Training Center during 2013 and 2014 cotton growing season. Five advanced lines developed by breeding program and two control varieties namely Stoneville 468 and Fantom were used as material. The experiment was laid out as randomized complete block design with four replications. The results of statistical analysis indicated that there were significant differences among genotypes for investigated characteristics in terms of first picking percentage, fiber fineness, fiber strength, elongation, uniformity and short fiber index. There were significant differences between years for seed cotton yield, ginning percentage, first picking percentage, lint yield, fiber length, fiber strength, elongation, uniformity and short fiber index. All investigated characteristics had high values in 2013 except fiber length and fiber strength. Genotype x year interaction was significantly different only for fiber fineness. The results of research showed that the line coded as 9/8 had highest seed cotton yield, lint yield and first picking percentage, while 19/3, 9/1 and 9/8 lines had highest technological properties.

**Keywords:** *Cotton, Earliness, Maturity, Yield*

### **Introduction**

Cotton (*Gossypium hirsutum* L.) is an important fiber crop used in the textile industry in the world and also in Turkey. Turkey is the 7th largest cotton producing country in the world and 4th in world cotton consumption. Average cotton yield of Turkey is second rank after Australia. Cotton breeding program of Turkey mostly focused on the development of cultivars with high genetic potential for yield, high quality and earliness. Earliness is a primary breeding objective of cotton breeders (Braden and Smith, 2004; Hosseini, 2017). Earliness of the crop maturity is important in the avoidance of frost damage, insect and disease buildup, soil moisture depletion and weathering of the open cotton. Earliness also has other advantages, such as allowing rotation with a winter crop or extending the season for harvesting and ginning operations (Panhwar et al, 2002). Early maturing varieties increased the possibility that harvest can be completed before cold and rainy weather (Shakeel et al., 2012). Early maturity is the end result of several growth and fruiting processes, or components, which are interrelated, and which presumably can be manipulated separately in the breeding process (Godoy and Palomo, 1999). Therefore, in order to breed early maturing and good fiber quality cotton varieties through selection and breeding, it is necessary for cotton breeders to have knowledge about the inheritance of plant characteristics related to early maturing, good fiber quality and high yielding traits (Hajazi et al., 2014). Earliness trait in cotton is controlling by additive gene effects and this model of inheritance in cotton is

useful in the development of pure lines whereas dominance and epistatic effects can be used to exploit hybrid vigor (Hosseini, 2017). Earliness in cotton is a complex character which is assessed by measuring many plant traits. Plant breeders utilize mostly first picking percentage or percent open bolls technique to measure the relative maturity of cotton varieties (Guthrie et al, 1995). Several other parameters have been used as indicators or estimators of earliness, including rates of blooming and maturation, vertical and horizontal flowering intervals, mean maturity, production rate index and portion of crop harvested by specified dates (Godoy and Palomo, 1999), node of first fruiting branch, number of vegetative branches and etc. (Shakeel et al., 2012). Anjum et al., 2001, revealed that the characters attaining date of 5-NAWF and date of opening first boll were more reliable indicators of earliness as compared to others. The aim of this study was to establish the productive potential and quality fiber indexes of the new cotton cultivars in comparison with the standard cultivars, as well as the combination of other valuable properties.

### Material and Methods

The experiment was carried out at the GAP International Agricultural Research and Training Center's (GAPUTAEM) experimental area during 2013 - 2014 growing seasons in Diyarbakir, Turkey. The experiment was laid out as randomized complete block design (RCBD) with four replications. The materials used in the study were developed from cotton breeding program of the GAPUTAEM. In the study, 7 genotypes (5 advanced cotton breeding lines and 2 control) varieties were used as plant materials. Each plot consisted of four rows of 12 m length, between and within row spacing were 0.70 m and 0.15-0.20 m, respectively. Seeds were planted on 7<sup>th</sup> May 2013 and 5<sup>th</sup> May 2014 by experiment planting machine. All plots were treated with 20-20-0 composite fertilizer to provide 70 kg ha<sup>-1</sup> N and 70 kg ha<sup>-1</sup> P<sub>2</sub>O<sub>5</sub>. Just before the flowering, 70 kg ha<sup>-1</sup> N was applied as ammonium nitrate to the trial as an additional N source. Plants were grown under recommended cultural practices for commercial production. Experimental plots were irrigated for the first time, five weeks after sowing, and repeated seven times at ten to twelve-days interval in both years. Furrow irrigation was applied. Herbicides were used only once before sowing. In both years, insect were monitored throughout the experiment and in 2013 at early stage for thrips and at boll formation for red spider, in 2014 two times insecticide were used. Plots were harvested twice by hand and the harvests from the four rows of the plot were weighed and calculated for seed cotton yield and fiber yield. The first harvest was done on 12<sup>nd</sup> October, 2013 and 24<sup>th</sup> October 2014 and the second harvest was done on 7<sup>th</sup> November, 2013 and 13<sup>th</sup> November, 2014. After the harvest, seed cotton samples were ginned on a mini-laboratory roller-gin for lint percentage. Fiber samples were then analyzed for fiber quality properties by High Volume Instrument (HVI Spectrum). Statistical analysis were performed using JMP 5.0.1 statistical software (<http://www.jmp.com>) and the means were grouped with LSD (0.05) test. The climatical data was given in Table 1.

Table 1. Climatic data of experimental area during two years (2013 and 2014) and long term period.

Months	Minimum Temperature (° C)			Average Temperature (° C)			Maximum Temperature (° C)			Total Precipitation (mm)		
	2103	2014	Long term	2013	2014	Long term	2013	2014	Long term	2013	2014	Long term
April	6.9	6.9	7.1	14.4	14.7	13.9	21.9	22.0	20.3	39.4	39.9	73.5
May	11.4	11.1	11.3	19.1	19.8	19.3	27.3	28.1	26.5	98.0	48.8	40.8
June	17.1	17.6	16.4	26.8	26.6	25.9	34.9	34.1	33.2	2.8	21.4	8.2
July	22.8	21.9	21.6	31.3	31.6	31.0	38.4	39.3	38.2	0.0	0.6	0.7
August	21.4	21.2	20.9	30.5	31.1	30.3	38.1	39.6	38.0	0.0	0.0	0.6
September	15.9	16.5	15.9	24.4	24.7	24.9	32.1	32.2	33.3	0.0	27.4	2.6
October	9.0	11.0	9.8	16.9	17.5	17.1	25.0	24.2	25.2	0.0	34.2	30.8

Source: Turkish State Meteorological Service.

## Results and Discussion

The findings of experiment were given as tables. According means of two years results the yields of genotypes changed from 3907.1 to 4253.0 kg ha<sup>-1</sup> (Table 2). The highest yield was obtained from 9/8 (4253.9 kg ha<sup>-1</sup>) genotype the control variety Stv 468 followed this genotype (4114.3 kg ha<sup>-1</sup>). The differences between the genotypes and genotype x years with respect to seed cotton yield were non- significant, but year differences were highly significant ( $p < 0.01$ ) for this trait. The seed cotton yield of 2013 was higher than of that 2014 (Table 2). This differences may be stemmed from climate conditions and cultural practices. Previous researcher reported that 70% of the yield variation is stemming from environmental differences which are occurring year by years and the other 30% is stemming from management process differences (Krieg, 1997).

Table 2. Average values and statistical groups of seed cotton yield and ginning percentage

Genotype	Seed Cotton Yield (kg ha <sup>-1</sup> )		Mean	Ginning Percentage (%)		Mean
	2013	2014	2013-2014	2013	2014	2013-2014
1. 9/1	4312.4	3681.5	3996.9	42.62	38.44	40.53
2.15/3	4483.3	3331.1	3907.1	42.54	38.80	40.67
3.19/3	4401.5	3555.0	3978.2	42.97	38.89	40.93
4. 6/5	4349.7	3768.2	4058.9	41.13	38.59	39.85
5.9/8	4426.5	4079.7	4253.0	42.60	38.85	40.72
6.STV 468 (Control)	4515.9	3712.7	4114.3	42.74	39.62	41.18
7.FANTOM (Control)	4389.7	3613.8	4001.7	41.41	38.04	39.72
<b>Mean</b>	<b>4411.2 a</b>	<b>3677.4 b</b>		<b>42.28 a</b>	<b>38.75 b</b>	
CV (%)	9.84			2.81		
Genotype (LSD <sub>0.05</sub> )	ns			ns		
Year (LSD <sub>0.05</sub> )	43.50**			0.64 **		
Genotype x Year (LSD <sub>0.05</sub> )	ns			ns		

ns: non significant; \* and \*\*, significantly different from zero at  $P \leq 0.05$  and  $P \leq 0.01$ , respectively.

From Table 2, The differences between the genotypes and genotype x years with respect to ginning percentage were non-significant, but year differences were highly significant ( $p < 0.01$ ) for this trait. Ginning percentage of genotypes changed from 39.72 to 41.18%. The ginning percentage of 2013 was higher than that of 2014 (Table 2).

Table 3. Average values and statistical groups of first picking percentage and fiber yield

Genotype	First Picking Percentage (%)		Mean	Fiber Yield (kg ha <sup>-1</sup> )		Mean
	2013	2014	2013-2014	2013	2014	2013-2014
1. 9/1	98.14	94.85	96.50 a	1836.7	1409.6	1623.1
2.15/3	98.69	93.83	96.27 a	1911.8	1293.8	1602.8
3.19/3	97.73	92.62	95.18 ab	1891.0	1387.9	1639.5
4. 6/5	97.16	90.91	94.03 bc	1789.6	1454.3	1621.9
5.9/8	98.60	94.91	96.76 a	1885.2	1583.8	1734.5
6.STV 468 (Control)	96.69	88.11	92.40 c	1928.0	1474.1	1701.0
7.FANTOM (Control)	98.39	94.53	96.46 a	1820.7	1375.1	1597.8
<b>Mean</b>	<b>97.92 a</b>	<b>92.82 b</b>		<b>1866.1 a</b>	<b>1425.5 b</b>	
CV (%)	2.03			10.44		
Genotype (LSD <sub>0.05</sub> )	1.95**			ns		
Year (LSD <sub>0.05</sub> )	1.02**			18.47**		
Genotype x Year (LSD <sub>0.05</sub> )	ns			ns		

ns: non significant; \* and \*\*, significantly different from zero at  $P \leq 0.05$  and  $P \leq 0.01$ , respectively.

Table 4. Average values and statistical groups of fiber fineness and fiber length

Genotype	Fiber Fineness (mic)		Mean	Fiber Length (mm)		Mean
	2013	2014		2013-2014	2013	
1. 9/1	4.72	4.46	4.59 ab	28.41	28.99	28.70
2.15/3	4.72	4.72	4.72 a	28.45	28.35	28.40
3.19/3	4.49	4.35	4.42 bc	28.78	28.79	28.79
4. 6/5	4.16	4.16	4.16 e	27.72	28.93	28.32
5.9/8	4.17	4.55	4.36 cd	27.65	28.30	27.97
6.STV 468 (Control)	4.19	4.19	4.19 de	26.72	27.97	27.34
7.FANTOM (Control)	4.02	4.30	4.16 e	27.31	28.64	27.97
<b>Mean</b>	<b>4.35</b>	<b>4.39</b>		<b>27.86 b</b>	<b>28.57 a</b>	
CV (%)	4.11			3.22		
Genotype (LSD <sub>0.05</sub> )	0.18**			ns		
Year (LSD <sub>0.05</sub> )	ns			0.64*		
Genotype x Year (LSD <sub>0.05</sub> )	0.26*			ns		

ns: non significant; \* and \*\*, significantly different from zero at  $P \leq 0.05$  and  $P \leq 0.01$ , respectively.

Table 5. Average values and statistical groups of fiber strength and fiber elongation

Genotype	Fiber Strength (g/tex)		Mean	Fiber Elongation (%)		Mean
	2013	2014		2013-2014	2013	
1. 9/1	32.63	33.90	33.26 ab	7.70	6.07	6.88 a
2.15/3	32.58	32.47	32.52 a-c	7.33	5.60	6.46 ab
3.19/3	33.78	34.47	34.12 a	6.70	5.17	5.93 bc
4. 6/5	30.08	32.32	31.20 c	6.48	5.27	5.87 c
5.9/8	32.30	33.87	33.08 ab	7.25	6.02	6.63 a
6.STV 468 (Control)	29.85	32.10	30.97 c	7.18	5.72	6.45 ab
7.FANTOM (Control)	31.00	32.75	31.87 bc	7.03	5.75	6.38 a-c
<b>Mean</b>	<b>31.74 b</b>	<b>33.12 a</b>		<b>7.09 a</b>	<b>5.66 b</b>	
CV (%)	5.25			8.32		
Genotype (LSD <sub>0.05</sub> )	1.72**			0.54**		
Year (LSD <sub>0.05</sub> )	0.96*			0.43**		
Genotype x Year (LSD <sub>0.05</sub> )	ns			ns		

ns: non significant; \* and \*\*, significantly different from zero at  $P \leq 0.05$  and  $P \leq 0.01$ , respectively.

The first picking percentage is an important earliness criteria. The differences between the genotypes and years with respect to first picking percentage were highly significant ( $p < 0.01$ ), but genotype x years differences was non-significant for this trait (Table 3). According to means of two years first picking percentage of genotypes changed from 92.40 to 96.76%, the highest values were obtained from 9/8 (96.76%), 9/1 (96.50 %) and 15/3 (96.27%). These genotypes shared the same statistical group with control variety Fantom. The Stv 468 control variety had lowest value (92.40%) for this trait. Baloch et al. 2014 revealed that cotton earliness is a quantitative trait which is mainly affected by environment and crop genotype.

The fiber yield of genotypes changed from 1602.8 to 1734.5 kg ha<sup>-1</sup>. The differences between the genotypes and genotype x years were non-significant, but years differences were significant at 1% level (Table 3). The means of 2013 was 1866.1 kg ha<sup>-1</sup>, while it was 1425.5 kg ha<sup>-1</sup> for 2014. This differences may be stemmed from climate conditions and cultural practices. In 2013, in May, which is the planting month, the precipitation was 98 mm which is higher than year of 2014 and long term period.

The fiber fineness of genotypes changed from 4.16 to 4.72 micronaire. The lowest values were obtained from 6/5 genotype and Fantom control variety, while the highest value was obtained from 15/3 genotype. The differences between the genotypes and genotype x years were significant at 1% and 5%, respectively. Years differences were non-significant (Table 4).

High micronaire is an undesirable trait in a mature fiber, resulting in price discounts (Percy et al, 2006).

In terms of fiber length, the differences between the genotypes and genotype x years were non-significant, but years differences were significant at 1% level (Table 4). The fiber length of genotypes changed from 27.34 (Stv 468) to 28.79 mm (19/3 number line). The fiber length of 2014 (28.57 mm) was higher than that of 2013 (27.86 mm). Although fiber length is a genetic trait it is affected by crop management, soil moisture, the frequency of irrigation and amount of water and temperature variations (May, 2000).

From Table 5 it can be seen that the differences between the genotypes and years were significant at 1% and 5%, respectively. Genotype x years differences were non-significant (Table 5). The fiber strength of genotypes changed from 30.97 to 34.12 g tex-1. The highest values were obtained from 19/3 number genotype (34.12 g tex-1), to 9/8 number genotypes (33.08 g tex-1), while the lowest value was obtained from Stv 468 control variety (30.97 g tex-1). There was significant differences between years, the values of 2014 was higher than that of 2013. Previous researchers reported that the effect of genotypes more than environment (Bradow and Davidonis, 2000).

In terms of fiber elongation, differences between genotypes and years were significant at 1% level, while genotype x years interaction was non-significant for this trait. The fiber elongation of genotypes changed from 5.87 to 6.88%. The highest values were obtained from 9/1 (6.88%), 9/8 (6.63%), 15/3 (6.46%), while the lowest value was obtained from 6/5 number line. There was significant differences between years, the values of 2013 was higher than that of 2014. Campbell and Jones (2005) reported that elongation is affected from genotype, environment and genotype x environment interaction.

Table 6. Average values and statistical groups of fiber uniformity and short fiber index

Genotype	Fiber Uniformity (%)		Mean	Short Fiber Index (%)		Mean
	2013	2014	2013-2014	2013	2014	2013-2014
1. 9/1	85.45	82.35	83.90 a	8.67	9.00	8.83 d
2.15/3	82.88	81.10	81.98 abc	9.35	10.05	9.70 cd
3.19/3	85.28	82.05	83.66 ab	9.62	9.72	9.67 cd
4. 6/5	80.23	80.70	80.46 c	12.60	9.87	11.23 ab
5.9/8	82.38	82.07	82.22 abc	10.50	9.62	10.06 bcd
6.STV 468 (Control)	81.30	81.57	81.43 bc	12.30	10.42	11.37 a
7.FANTOM (Control)	82.78	81.60	82.18 abc	10.40	9.77	10.08 bc
<b>Mean</b>	<b>82.89 a</b>	<b>81.63 b</b>		<b>10.49 a</b>	<b>9.78 b</b>	
CV (%)	2.67			12.04		
Genotype (LSD <sub>0.05</sub> )	2.22*			1.23**		
Year (LSD <sub>0.05</sub> )	1.09*			0.48*		
Genotype x Year (LSD <sub>0.05</sub> )	ns			ns		

ns: non significant; \* and \*\*, significantly different from zero at  $P \leq 0.05$  and  $P \leq 0.01$ , respectively.

From Table 6 it can be seen that differences between the genotypes and years with respect to fiber uniformity were significant at 5% level. Genotype x years differences were non-significant (Table 6). The fiber uniformity of genotypes changed from 80.46 to 83.90%. The highest values were obtained from 9/1, while the lowest value was obtained from 6/5 number line. There was significant differences between years, the values of 2013 was higher than that of 2014.

In terms of short fiber index from Table 6 it can be seen that the differences between the genotypes and years were significant at 1% and 5%, respectively. Genotype x years differences were non-significant (Table 6). The short fiber index of genotypes changed from 8.83 to 11.37%. The highest values were obtained from Stv 468 control variety, while the

lowest value was obtained from line 9/1 (8.83%). There was significant differences between years, the values of 2013 was higher than that of 2014.

### **Conclusions**

The study was carried out to develop high yielding and early maturing cotton varieties. With this objective 5 advanced cotton lines and two cotton varieties were used as material. The results of statistical analysis indicated that there were significant differences among genotypes for investigated characteristics in terms of first picking percentage, fiber fineness, fiber strength, elongation, uniformity and short fiber index. There were significant differences between years for seed cotton yield, ginning percentage, first picking percentage, lint yield, fiber length, fiber strength, elongation, uniformity and short fiber index. All investigated characteristics had high values in year of 2013 except fiber length and fiber strength. Genotype x year interaction was significantly different only for fiber fineness. The results of research showed that the line coded as 9/8 had highest seed cotton yield, lint yield and first picking percentage, while 19/3, 9/1 and 9/8 lines had highest technological properties. The results of study indicated that 9/8 coded line is promising line for being nominate for registration.

### **Acknowledgement**

This study was supported by General Directorate of Agricultural Research and Policies (TAGEM). We would like to thank for supporting this study.

### **References**

- Anjum R., Soomro A. R., Chang M. A. (2001). Measurement of Earliness in Upland Cotton. *Pakistan Journal of Biological Sciences*. 4 (4), 462-463.
- Anonymous 2014. Diyarbakır Meteorological Records. <http://www.diyarbakir.mgm.gov.tr/>
- Baloch M. J., Khan N. U., Rajput M. A., Jatoti W. A., Gul S., Rind I. H., Veesar, N. F. (2014). Yield and Related Morphological Measures of Short Duration Cotton Genotypes. *The Journal of Animal & Plant Sciences*, 24(4): 1198-1211.
- Braden C.A., Smith C. W. (2004). Phenotypic measurements of fiber associations of near-long staple upland cotton. *Crop Sci* (44) 2032-2037.
- Bradow J. M., Davidonis G. H. (2000). Quantitation of fiber quality and the cotton production-processing interface: A physiologist's perspectives, *The Journal of Cotton Science* 4:34-64.
- Campbell B. T., Jones M. A. (2005). Assessment of genotype x environment interactions for yield and fiber quality in cotton performance trials. *Euphytica*, 144: 69-78.
- Godoy A. S., Palomo G. A. (1999). Genetic analysis of earliness in upland cotton (*Gossypium hirsutum* L.). I. Morphological and phenological variables. *Euphytica* 105, 155-160.
- Guthrie D., Banks J. C., Edmisten K., 1995. Capitalizing on Earliness. *Cotton Physiology Today*. Newsletter of the Cotton Physiology Education Program. National Cotton Council, 6 (6), 1-4.
- Hajazi M. Z., Shakeel A., Farooq J., Mahmood A., Saeed A., Saleem M. F., Azhar M. T. (2014). Genetic Basis for Earliness and Yield Contributing Traits in Cotton *Gossypium hirsutum* L. *J. Agric. Res.* 52(3), 293-302.
- Hosseini G. (2017). New Earliness Index and Integration of Earliness Additive Genes in the New Genotype of Cotton (*Gossypium Hirsutum* L.) *Int. J. Life. Sci. Scienti. Res.*, 3(3): 1016-1019.

- Hosseini G. (2017). Earliness and suppression of its additive genetic effects by environmental and management factors in cotton (*Gossypium Hirsutum* L.). *International Journal of Agricultural Policy and Research* .5 (7), 125-128.
- Krieg D. R. (1997). Genetic and environmental factors affecting productivity of cotton. *Proceedings of the Beltwide Cotton Conference, 7-10 January, National Cotton Council of America, New Orleans, LA, 2:1347.*
- May O. L. (2000). Genetic variation in fiber quality. p. 183-220. In A.S. Basra (ed) *Cotton fibers developmental biology, quality improvement, and textile processing* Food Products Press, New York.
- Panhwar G. N, Soomro A. R, Anjum R, Babar S. B, Memon A. M, Soomro A. W. (2002). Predicting Earliness in Cotton During Crop Development Stage-11. *Asian Journal of Plant Sciences*, 1: 37-38.
- Percy R. G., Cantrell R. G., Zhang J. (2006). Genetic Variation for Agronomic and Fiber Properties in an Introgressed Recombinant Inbred Population of Cotton. *Crop Science*. 46, 1311-1317.
- Shakeel A., Farooq J., Bibi A., Khan S. H., Saleem M. F. (2012). Genetic studies of earliness in *Gossypium hirsutum* L. *IJAVMS*. 6 (3), 189-207.

## EFFECT OF CROP ROTATION ON HAY YIELD AND PROFITABILITY

Erdem GULUMSER<sup>1\*</sup>, Zeki ACAR<sup>2</sup>

<sup>1</sup>Bozok University, Agriculture of Faculty, Department of Field Crops, Yozgat, Turkey

<sup>2</sup>Ondokuz Mayıs University, Faculty of Agriculture, Department of Field Crops, Samsun, Turkey

\*Corresponding author: erdem.gulumser@bozok.edu.tr

### Abstract

This study was conducted to determine total yield and profitability of legume x cereal mixtures and silage corn rotation during 2013-2014 and 2014-2015 growing seasons in Yozgat, Turkey. Firstly, Hungarian vetch (*Vicia pannonica* Crantz) and cereals (*Hordeum vulgare* L., *Triticum aestivum* L. and *Triticosecale* Wittmack) were sown as binary mixtures with different seed rates (100:0%, 70:30%, 60:40%, 50:50% 40:60%) and harvested at the flowering and milk dough stages. Then silage corn was sown. The experiments were arranged in split plot design with four replications. According to combined results the highest total hay and total crude protein yield were obtained from the Hungarian vetch + barley mixture with 70:30% seed rate cutting at flowering stage and fallowed by silage corn (32.4 t ha<sup>-1</sup> and 3.13 t ha<sup>-1</sup>, respectively) while they were the lowest in silage corn sowing over the fallow at the second sowing time (19.5 t ha<sup>-1</sup> and 1.44 t ha<sup>-1</sup>, respectively). Profitability analysis was performed in two ways; hay price and meat conversion of hay. The maximum profit was obtained from Hungarian vetch + barley mixture with 70:30% seed rates and first cutting time treatment as 4776.60 \$/ha and 13213.09 \$/ha, respectively based on hay price and meat conversion of hay methods. As a result, Hungarian vetch + barley mixture with 70:30% seed rate and cutting at flowering stage of barley may be the most appropriate treatment for both Hungarian vetch + cereal mixtures and silage corn in terms of yield and economic return in Middle Anatolian conditions.

**Keywords:** *Hungarian vetch + cereals mixture, silage corn, hay yield, crude protein yield, profitability.*

### Introduction

Crop rotation is the practice of growing a series of different types of crops in the same area in sequenced seasons (Tugay, 1988; Sencar *et al.*, 1994). Growing the same crop in the same field for many years in a row disproportionately depletes the soil of certain nutrients. With rotation, a crop that leaches the soil of one kind of nutrient is followed during the next growing season by a dissimilar crop that returns that nutrient to the soil or draws a different ratio of nutrients. In addition, crop rotation mitigates the buildup of pathogens and pests that often occurs when one species is continuously cropped, and can also improve soil structure and fertility by increasing biomass from varied root structures.

A great advantage of crop rotation comes from the interrelationship of nitrogen fixing-crops with nitrogen demanding crops. Legumes, like alfalfa and vetch, collect available nitrogen from the soil in nodules on their root structure (John *et al.*, 2010). When the plant is harvested, the biomass of uncollected roots breaks down, making the stored nitrogen available to future crops. So that the yield of the next product increases (Anonymous, 2016). In addition crop rotation systems have resulted to increase farm production and profitability per unit land area in selected crops (Anonymous, 2017).



The objective of this study was to determine hay yield and profitability of Hungarian vetch x cereals mixtures and silage corn rotation.

### Material and Methods

Experiments were conducted during the growth seasons of 2012-2013 and 2014-2015 in the Agricultural Research Station of Bozok University, Yozgat, Turkey, which is located at 34° 28' 0" E, 39° 37' 0" N. Soil properties of the experimental area of both year were clay-loam type with pH of 8.18-8.15 and 7.90-7.93% CaCO<sub>3</sub>, 82.0-85.2 kg ha<sup>-1</sup> phosphorus, and 1.85-1.91% organic matter at the depth of 30 cm (Table 1).

Table 1. Physical and Chemical Properties of Soil in Research Area\*

Properties	2013-2014	2014-2015
Structure	Clay-loam	Clay-loam
CaCO <sub>3</sub> (%)	7.90	7.93
Total salt (%)	0.020	0.018
P <sub>2</sub> O <sub>5</sub> (kg ha <sup>-1</sup> )	82.0	85.2
K <sub>2</sub> O (kg ha <sup>-1</sup> )	480.2	501.2
Ph	8.18	8.15
Organic matter (%)	1.85	1.91

\* Turkish chamber of agriculture cooperation.

The Table 2 shows the climatic conditions of the experimental area long-term and during the growth season, including monthly average temperature, monthly total precipitation and average moisture. Total precipitation of the long-term 574.4 mm and growing season was 568.4 mm for 2013-2014 and 717.1 mm for 2014-2015 (Table 2).

Table 2. Climatic conditions of during longterm and experimental years\*

Months	Long-term			2013-2014			2014-2015		
	Temp. (°C)	Moist. (%)	Precipt. (mm)	Temp. (°C)	Moist. (%)	Precipt. (mm)	Temp. (°C)	Moist. (%)	Precipt. (mm)
October	10.3	65.9	36.5	9.0	55.4	22.1	10.8	69.3	72.6
November	4.6	72.5	56.2	6.5	67.2	36.5	4.2	70.2	61.3
December	0.5	77.3	76.3	-2.9	71.0	25.1	4.1	77.9	53.3
January	-1.9	77.5	67.9	1.4	75.5	58.7	-1.0	76.7	54.5
February	-1.0	75.8	62.3	3.3	61.9	17.6	0.8	73.3	68.0
March	2.9	71.0	65.2	5.6	63.5	116.7	4.4	69.5	115.3
April	8.3	66.6	62.3	11.0	53.4	31.6	6.1	61.9	28.0
May	13.0	64.2	65.0	13.3	60.4	121.3	14.1	59.9	131.6
June	16.8	60.5	43.5	16.6	56.0	79.8	16.0	71.5	95.3
July	19.7	56.8	12.3	21.5	43.2	3.7	19.8	54.7	7.1
August	19.6	55.7	8.90	22.4	43.5	27.1	21.3	56.7	5.4
September	15.5	58.1	18.0	14.5	58.1	28.2	20.1	49.4	24.7
Average	9.0	66.82		10.18	58.65		10.05	65.91	
Total			574.4			568.4			717.1

\* Turkish State Meteorological Service

Firstly, Hungarian vetch (*Vicia pannonica* Crantz “Altinova 200”) and cereals (*Hordeum vulgare* L., “Tarm 92”, *Triticum aestivum* L. “Pehlivan” and *Triticosecale* Wittmack “Karma 2000”) were sown as binary mixtures with different seed rates (100:0%, 70:30%, 60:40%, 50:50% 40:60%) and harvested at the flowering and milk dough stages. Then silage corn (*Zea mays* L. “Cadız”) was sown. The experiments were arranged in split plot design with four replications, main plots were cutting times and sub plots were seed rates.

**Hungarian vetch+cereal mixtures:** The experimental plots had 8 rows with a row spacing of 20 cm and a row length of 5 m. The seed proportions were calculated on the basis of recommended sole seeding rate and barley 220 kg/ha<sup>-1</sup>, wheat 180 kg/ha<sup>-1</sup>, Triticale 200 kg/ha<sup>-1</sup>, Hungarian vetch 100 kg/ha<sup>-1</sup>. The P fertilizer 80 kg ha<sup>-1</sup> P<sub>2</sub>O<sub>5</sub> was uniformly applied to the soil during sowing. The plots were harvested on the basis of cereals that harvested at the flowering and milk dough stages.

**Silage corn:** Plot size was 5 x 1.5 m = 7.5 m<sup>2</sup> and distance between rows were 50 cm. Also Hungarian vetch + cereals mixtures were comparison stubble being control. Plant density was 120.000 seed for per hectare. The full dose nitrogen (50 kg N ha<sup>-1</sup>), phosphate (80 kg P<sub>2</sub>O<sub>5</sub> ha<sup>-1</sup>) were applied at sowing. Additional nitrogen fertilizer (50 kg N ha<sup>-1</sup>), was applied at the stage when the plants were 40-50 cm. In the study, five irrigation were applied and weeds were controlled by hoeing. Silage corn harvested in dough stage.

Plant samples were dried 65 °C until constant weight to determine their hay yield. Crude protein of hay was determined by using Near Reflectance Spectroscopy (NIRS, 'Foss 6500') with software package program 'IC-0904FE'.

Treatments of entries in the study were calculated separately and determined how much boned meat meets that total amount of protein obtained from silage corn with hungarian vetch + cereal mixtures (1.8 kg protein = 1 kg boned meat) (Aydın and Uzun, 2005). The amount of boned meat obtained was calculated by multiplying the price of boned meat. The amount of hay is multiplied by the price of hay and the income account is determined and, the input costs were deducted from the income of each process to determine profit. Profitability analysis were given Table 3.

Table 3. Values based on profitability analysis

2014 (\$/ha)	Hungarian vetch	Barley	Wheat	Triticale	Corn
Land preparation*	80.11	80.11	80.11	80.11	80.11
Seed fee *	44.20	62.15	62.15	55.24	96.68
Fertilizer fee*	41.44	93.92	124.30	110.50	193.37
Sowing*	27.62	27.62	27.62	27.62	27.62
Hoeing*	-	-	-	-	165.75
Irrigation*	-	-	-	-	207.18
Harvest*	99.69	99.69	99.69	99.69	248.61
Total	293.06	363.49	393.87	373.16	1019.32
Hay yield/silage (kg/\$)	0.151	0.151	0.151	0.151	0.035
Boned meat (kg/\$)**	4.55				
2015 (\$/ha)	Hungarian vetch	Barley	Wheat	Triticale	Corn
Land preparation*	80.11	80.11	80.11	80.11	80.11
Seed fee *	49.72	60.77	62.15	55.24	110.50
Fertilizer fee*	41.44	93.92	124.30	110.50	271.5
Sowing*	27.62	27.62	27.62	27.62	27.62
Hoeing*	-	-	-	-	179.55
Irrigation*	-	-	-	-	234.80
Harvest*	62.15	62.15	62.15	62.15	262.43
Total	261.04	324.57	356.33	335.35	1166.51
Hay yield/silage (kg/\$)	0.165	0.165	0.165	0.165	0.047
Boned meat (kg/\$)**	5.66				

\*Republic of Turkey Ministry of Food, Agriculture and Livestock, Yozgat Directorate of Provincial Food Agriculture and Livestock.

\*\*Free market values.

## Results and Discussions

Total hay yield, total crude protein yield and profitability analysis of Hungarian vetch + cereals mixture and silage corn were given Table 4, 5 and 6.

According to combined years, total hay yield was significantly ( $p \leq 0.01$ ) different between years, while it was not significant between harvesting and sowing times (Table 4). As a result of combined years, hay yield was the highest ( $28.1 \text{ t ha}^{-1}$ ) in Hungarian vetch + barley mixture with 70:30% seed rate and it was the lowest in stubble ( $20.8 \text{ t ha}^{-1}$ ). Hungarian vetch + cereal yield increased with delayed harvest, while silage corn yield decreased with delayed sowing time. Also, silage corn hay yield that obtained with the delayed sowing was more than Hungarian vetch + cereal hay yield that obtained at the second harvest time. So, Hungarian vetch + cereal and silage corn hay yield in the first harvest time was more than second harvest time. Silage corn that sowing after previous plant had more than hay yield stubble plots (Table 4). This may be due to the organic material at the soil that left by the pre-plant. Because, both mixtures and silage corn were been given at the same amount fertilizer. Also, in the second year total hay yield was more than first year. This may be due to the second year was more than rainy to first year. Because, Hungarian vetch + cereal hay yield obtained was more highset at the first year. Total crude protein yield was not significantly different among the treatments and years. (Table 4). As a result of combined years, the highest crude protein yield was  $2639.2 \text{ kg ha}^{-1}$  (Hungarian vetch + barley mixture 70:30% seed rate), the lowest was  $1613.1 \text{ kg ha}^{-1}$  (stubble). Total crude protein yield at the first harvesting time was more than second harvesting time (Table 4). This is due to the hay yield with crude protein ratio of silage corn determined at the first sowing time was more than second sowing time.

Table 4. Hungarian vetch+cereals and silage corn total hay and crude protein yield

Treatments	Total hay yield ( $\text{t ha}^{-1}$ )			Total crude protein yield ( $\text{kg ha}^{-1}$ )		
	1	2	Average	1	2	Average
100 <sub>HV</sub>	20.1	26.0	23.1	2187.8	2118.3	2153.1
100 <sub>B</sub>	27.9	25.6	26.8	2598.6	2101.5	2350.1
70 <sub>HV</sub> -30 <sub>B</sub>	32.4	23.7	28.1	3131.6	2146.8	2639.2
60 <sub>HV</sub> -40 <sub>B</sub>	29.8	23.1	26.5	2991.8	1917.8	2454.8
50 <sub>HV</sub> -50 <sub>B</sub>	29.4	24.8	27.1	2708.5	2084.1	2396.3
40 <sub>HV</sub> -60 <sub>B</sub>	28.1	24.8	26.4	2454.1	2031.3	2242.7
100 <sub>W</sub>	28.6	23.7	26.2	2180.0	1697.9	1939.0
70 <sub>HV</sub> -30 <sub>W</sub>	24.9	25.0	25.0	2393.4	2087.6	2240.5
60 <sub>HV</sub> -40 <sub>W</sub>	25.5	24.8	25.2	2255.6	2022.7	2139.2
50 <sub>HV</sub> -50 <sub>W</sub>	26.2	23.9	25.1	2265.9	1898.0	2082.0
40 <sub>HV</sub> -60 <sub>W</sub>	29.1	23.5	26.3	2649.8	1995.8	2322.8
100 <sub>T</sub>	24.1	25.9	25.0	2025.9	1950.8	1988.4
70 <sub>HV</sub> -30 <sub>T</sub>	21.2	28.9	25.0	2195.4	2393.8	2294.6
60 <sub>HV</sub> -40 <sub>T</sub>	25.8	29.7	27.7	2330.6	2548.3	2439.5
50 <sub>HV</sub> -50 <sub>T</sub>	24.9	26.9	25.9	2168.1	2243.0	2205.6
40 <sub>HV</sub> -60 <sub>T</sub>	22.5	29.9	26.2	2132.7	2504.4	2318.6
Stubble	22.1	19.5	20.8	1779.8	1446.3	1613.1
Average	26.0 A**	25.3 B**		2379.4	2069.9	
Years	2013-2014	22.9 B**		2011.6		
	2014-2015	28.4 A**		2437.7		

(\*) 0.05, (\*\*) 0.01; 1: Flowering stage; 2: milk dough stage; HV: Hungarian vetch; B: barley, W: wheat; T: Triticale

According to combined years result of, the lowest profit of hay yield with silage and boned meat was determined stubble plots ( $1439,81$  and  $4313,20$  \$/ha) at the second harvesting time, while the maximum profit was ( $4776,60$  and  $13213,09$  \$/ha) in Hungarian vetch + barley

mixture 70:30% seed rate at the first harvesting time (Table 5 and 6). The profit obtained at the first harvest time was higher than the second harvest time. This is due to the hay and crude protein yield of silage corn is higher at the first harvest time. Because, there is no differences in terms of input prices between harvesting or sowing times. In the analysis of profitability with hay and silage yields and boned meat, the highest profit was obtained from Hungarian vetch + barley mixture 70:30% plot at the first harvesting time (Table 5 and 6). This may be due to the input prices of Hungarian vetch and barley less than wheat and triticale and the hay yield of Hungarian vetch + barley mixtures was more than wheat and triticale mixtures.

Table 5. Comparative profit analysis of hay and silage yields (\$/ha)

Treatments	Flowering stage			Milk dough stage		
	2013-2014	2014-2015	Total	2013-2014	2014-2015	Total
100 <sub>HV</sub>	328,40	2183,48	2511,88	1093,65	1745,39	2839,03
100 <sub>B</sub>	1340,22	2564,12	3904,34	966,91	2005,77	2972,68
70 <sub>HV</sub> -30 <sub>B</sub>	1903,51	2873,09	4776,60	811,16	2083,26	2894,42
60 <sub>HV</sub> -40 <sub>B</sub>	1614,72	2318,84	3933,56	1075,50	1777,02	2852,51
50 <sub>HV</sub> -50 <sub>B</sub>	1717,10	2375,94	4093,04	1252,02	1876,66	3128,67
40 <sub>HV</sub> -60 <sub>B</sub>	1511,46	2459,36	3970,83	1357,13	1992,60	3349,72
100 <sub>W</sub>	1121,57	2625,66	3747,24	1084,42	1828,43	2912,85
70 <sub>HV</sub> -30 <sub>W</sub>	653,56	2682,04	3335,61	1186,38	1875,06	3061,44
60 <sub>HV</sub> -40 <sub>W</sub>	930,25	2716,77	3647,02	1024,83	2279,92	3304,75
50 <sub>HV</sub> -50 <sub>W</sub>	1182,46	2089,03	3271,49	837,57	2084,20	2921,77
40 <sub>HV</sub> -60 <sub>W</sub>	1254,12	2568,65	3822,76	845,17	2266,08	3111,24
100 <sub>T</sub>	1255,19	1909,45	3164,64	1534,39	2340,33	3874,72
70 <sub>HV</sub> -30 <sub>T</sub>	796,55	1931,74	2728,29	1552,68	2455,77	4008,45
60 <sub>HV</sub> -40 <sub>T</sub>	1027,24	2572,15	3599,39	1732,29	2523,43	4255,72
50 <sub>HV</sub> -50 <sub>T</sub>	1399,64	1794,14	3193,78	1282,93	2097,43	3380,36
40 <sub>HV</sub> -60 <sub>T</sub>	678,56	1856,82	2535,39	1894,94	2350,14	4245,08
Stubble	1287,76	1164,34	2452,10	687,62	752,18	1439,81

HV: Hungarian vetch; B: barley, W: wheat; T: Triticale

Table 6. Comparative analysis of the profitability levels of hay yield and silage on the conversion of boned meat (\$/ha)

Treatments	Flowering stage			Milk dough stage		
	2013-2014	2014-2015	Total	2013-2014	2014-2015	Total
100 <sub>HV</sub>	2412,65	7148,20	9560,86	2874,17	4558,76	7432,93
100 <sub>B</sub>	4210,99	6455,86	10666,85	3897,76	4210,44	8108,20
70 <sub>HV</sub> -30 <sub>B</sub>	5681,38	7531,71	13213,09	3040,03	5341,19	8381,22
60 <sub>HV</sub> -40 <sub>B</sub>	4711,57	7356,60	12068,18	2761,38	4239,23	7000,61
50 <sub>HV</sub> -50 <sub>B</sub>	5140,77	5817,60	10958,37	3223,70	4524,97	7748,67
40 <sub>HV</sub> -60 <sub>B</sub>	4256,82	5990,77	10247,60	3115,14	4569,70	7684,83
100 <sub>W</sub>	2939,83	5467,76	8407,60	2277,71	3821,82	6099,53
70 <sub>HV</sub> -30 <sub>W</sub>	2881,52	7114,09	9995,61	3296,55	4842,62	8139,17
60 <sub>HV</sub> -40 <sub>W</sub>	3525,61	6141,63	9667,24	2590,17	5758,54	8348,70
50 <sub>HV</sub> -50 <sub>W</sub>	3990,80	4867,02	8857,82	2609,36	4925,86	7535,22
40 <sub>HV</sub> -60 <sub>W</sub>	3221,41	7342,35	10563,76	2173,95	5890,25	8064,20
100 <sub>T</sub>	3982,65	3988,65	7971,30	3068,51	4264,94	7333,45
70 <sub>HV</sub> -30 <sub>T</sub>	3483,43	5856,80	9340,22	4105,97	5633,12	9739,09
60 <sub>HV</sub> -40 <sub>T</sub>	3582,87	6101,93	9684,81	4114,45	5873,18	9987,62
50 <sub>HV</sub> -50 <sub>T</sub>	4217,54	4434,67	8652,21	3976,82	4687,10	8663,92
40 <sub>HV</sub> -60 <sub>T</sub>	3169,34	5038,70	8208,04	3966,91	5448,34	9415,25
Stubble	3416,13	2866,13	6282,27	2366,96	1946,24	4313,20

HV: Hungarian vetch; B: barley, W: wheat; T: Triticale

As a result of, ‘Hungarian vetch + barley mixture with 70:30% seed rate and cutting at flowering stage of barley’ may be the most appropriate treatment for both Hungarian vetch + cereal mixtures and silage corn in terms of yield, quality and economic return in Middle Anatolian conditions.

### **Acknowledgement**

Thanks to Ondokuz Mayıs University project Management Office because of financially support the Project (Grant No: BAP PYO.ZRT.1904.14.002). Also, the study is a part of Dr. Erdem Gulumser's doctoral thesis.

### **References**

- Anon (2016). "Green Manures". Royal Horticultural Society. Retrieved May 4.
- Anon (2017). <http://www.cropsreview.com/crop-rotation.html>.
- Aydın I., Uzun F. (2005). Nitrogen and phosphorus fertilization of rangelands affects yield, nforage quality and the botanical composition. *Europ. J. Agronomy*, 29, 33-37.
- John L., Sheaffer, C., Moncada K. (2010). "Chapter 4 Soil Fertility". *Risk Management Guide for Organic Producers (Report)*. University of Minnesota.
- Sencar O., Gokmen S., Kandemir, N. (1994). Field crops. *Gaziosmanpasa University, Journal of Agriculture Faculty*, No: 3, pp: 302.
- Tugay M.E. (1988). Agriculture of field. *Cumhuriyet University, J. of Agriculture Faculty*, No:4, pp: 200.

## DETERMINATION OF APPROPRIATE SOWING DENSITY FOR THE FORAGE PEA IN SAMSUN (TURKEY) CONDITIONS

Ertan ÖZ\*, Zeki ACAR

Ondokuz Mayıs University, Agricultural Faculty, Department of Agronomy, Samsun, Turkey

\*Corresponding author: ertanz197@gmail.com

### Abstract

Forage pea is an important annual leguminous plant that can be grown solely or together with other cool season cereals as a hay, pasture or silage plants. It has huge potential in Turkey because of its ability to adapt to humid and cool climatic conditions. There is no research on forage pea sowing rates and frequency in Black Sea region of Turkey. The aim of this study was to determine the best sowing rate and sowing frequency by using Golyazi cultivar. The experiment was established in a split plot design with 3 replicates on 28 February 2017. The sowing rates were 80, 100 and 120 viable seeds  $m^{-2}$ ; inter row spacing distances were 20, 30 and 40 cm. The harvest was carried out on 8 June, when the legumes started to grow on the lowest nodes. During harvest, 500 g of sample was taken from each plot and dried in an oven at 70 °C until it reached a constant weight. Hay ratio and yield were calculated from the dry to fresh weight ratio. The samples were then ground and analyzed for protein, ADF, NDF and mineral content. The highest hay yield (708 kg  $da^{-1}$ ) was obtained from the crop sown by 120 seeds  $m^{-2}$  with 20 cm inter row spacing. The hay yield was significantly increased in 120 seed  $m^{-2}$  plots and there was no difference between 80 and 100 seeds  $m^{-2}$  plots. When observed by inter row spacing distance, the highest hay yield was obtained from the crop sown at the distance of 20 cm. The hay yield sharply decreased at 30 cm and slightly increased again at 40 cm. There were also some significant differences among the treatments in terms of other characteristics.

**Keywords:** *Forage pea, yield, quality, sowing rate.*

### Introduction

Pea (*Pisum sativum L.*) is an annual cool-season legume crop that can be grown as forage or pulse winter crop without irrigation in all coastal areas of Turkey (Sayar, 2007; Uzun *et al.*, 2017). Forage pea is usually grown solely or as a mixture with cool-season cereals for hay, pasture, green manure and silage production. Forage pea has high levels of quality protein (it is especially rich in the amino acid lysine) (Manga *et al.*, 2003), is rich in phosphorus and calcium, and is a good source of vitamins, especially A and D (Uzun *et al.*, 2017); thus it is used as an alternative protein source in the animal feed industry in Europa (Tan *et al.*, 2014). Additionally, forage pea is a very suitable crop in annual crop rotation, because its growing period is relatively short, its forage yield is high and it provides biological nitrogen for the plants after them. Determining the optimal sowing density is an important factor. Sowing density can affect crop yield, quality, evaporation, light interception and competitive ability with weeds (Yavuz *et al.*, 2011; Uzun *et al.*, 2017). Optimum sowing density in forage pea can range greatly depending on genotypes, growing purpose and climatic conditions (Uzun and Acikgoz, 1998). Some studies conducted in different regions on forage pea have shown that yield usually increases with an increasing sowing density until it reaches an optimum level and then decreases (Townley Smith and Wright, 1994; Jovaisiene *et al.*, 1998; Tan *et al.*,

2014; Uzun *et al.*, 2017). There is no research on forage pea sowing density in Black Sea Region of Turkey. The aim of this study was to determine the best sowing rate and sowing density by using Golyazi cultivar.

### Material and Methods

The experiment was conducted in the Agricultural Research Center of Ondokuz Mayıs University, Samsun, Turkey under rainfed conditions in 2017. Experiment soil is loamy-clay, slightly acidic (pH:6.45), without lime and salt, and poor in organic matter. Annual total precipitation is 706 mm and average temperature is 14.50 °C. Field experiment was established on 28th February, 2017 according to split plot design with 3 replicates by using Golyazi forage pea cultivar. In the experiment, sowing rates were 80, 100 and 120 viable seeds m<sup>-2</sup>; inter row distances were 20, 30 and 40 cm. Plot areas were 4 m<sup>2</sup>, 6 m<sup>2</sup> and 8m<sup>2</sup>. 3 kg da<sup>-1</sup> N applied just after seeding. There was no other fertilization or irrigation. Harvest was carried out on 8 June when the legumes started to grow on the lowest nodes. During harvest, 500 g samples were taken from each plot and dried in an oven at 70 °C until a constant weight. Hay ratio and yield were calculated from dry to fresh weight ratio. The samples were then ground and analyzed for crude protein, ADF, NDF and mineral content (Ca, Mg, K and P) with Near Infrared Reflectance Spectroscopy (NIRS Foss 6500) by using IC-0904FE program. Statistical analysis was performed with SPSS 17.0 program according to split plot design.

### Results and Discussion

Different seeding rates and row spaces had significant effects on hay yield of forage pea (Table 1 and figure 1,2). Increasing seeding rates and row spaces increased hay yield. When considering seeding rates, the highest hay yield was obtained from 120 viable seeds m<sup>-2</sup> (566 da<sup>-1</sup>) and 40 cm row spacing (531 kg da<sup>-1</sup>). The differences between 20 and 30 cm row spaces and between 80 and 100 viable seeds m<sup>-2</sup> were found to be statistically insignificant. In general, the hay yield obtained from forage pea is increases when row spacing is inclined until 40 cm (Tan *et al.*, 2014) and the highest hay yield can be taken from 150 viable seeds m<sup>-2</sup> (Turk *et al.*, 2011). Previous studies conducted with the same cultivar showed that average hay yields were 500 kg da<sup>-1</sup> (Turk *et al.*, 2011), 686 kg da<sup>-1</sup> (Uzun *et al.*, 2017). The different results amongst the studies can be attributed to different conditions. Comparing seeding rates and row spaces, the effect of seeding rates on hay yield is higher than row spaces (Table 1; Figure 1 and 2). As shown in Table 1, the effects of seeding rates and row spaces on crude protein yield obtained from forage of Golyazi pea variety were statistically significant. In terms of crude protein yield, effects of seeding rates and row spaces was similar to hay yield (Table 1; Figure 3 and 4).

The highest crude protein yield was obtained from 40 cm row spacing (127.4 kg/da1) and 120 viable seeds m<sup>-2</sup> (128.8 kg da<sup>-1</sup>). Narrowing row spaces and decreasing seeding rates decreased crude protein yield. Turk *et al.* (2011), reported that increasing seeding rates linearly increased crude protein yield of forage pea until 150 viable seeds m<sup>-2</sup> but Uzun *et al.*, (2017) found that though crude protein yield increased at 125 viable seeds m<sup>-2</sup>, it decreased after that level. Crude protein yield of Golyazi cultivar was observed between 94 and 160 kg da<sup>-1</sup> in previous studies (Turk *et al.*, 2011; Uzun *et al.*, 2017). The effects of different seeding rates and row spaces on crude protein ratios were found to be insignificant. Crude protein ratios of Golyazi forage pea cultivar grown at different seeding rates and row spaces varied between 20.11 - 25,91% (Table 1). Increasing seeding rates also increased crude protein ratios of forage pea until 125 viable seeds m<sup>-2</sup> (Uzun *et al.*, 2017), but Tan *et al.* (2014), reported

that there was no significant effect of seeding rates and row spaces on crude protein ratios of forage pea.

**Table 1.** Hay and crude protein yields, some chemical and mineral composition of forage pea grown different densities\*

Seeding rate	Inter row spaces							
	Hay yield (kg da <sup>-1</sup> )				Crude protein yield (kg da <sup>-1</sup> )			
	20	30	40	Mean	20	30	40	Mean
<b>80</b>	383,55	424,37	463,82	423,91 b	79,37	101,56	107,41	96,11b
<b>100</b>	445,71	465,32	491,42	467,48 b	104,32	93,57	127,31	108,40b
<b>120</b>	520,03	541,67	636,88	566,19 a	111,78	127,15	147,58	128,84a
<b>Mean</b>	449,76 b	477,12 b	530,71 a		98,49b	107,43b	127,43a	
	Crude protein (%)				K (%)			
<b>80</b>	20,69	23,93	23,16	22,59	2,67	3,24	3,17	3,02
<b>100</b>	23,40	20,11	25,91	23,14	3,15	2,57	3,45	3,06
<b>120</b>	21,49	23,47	23,17	22,71	3,19	3,27	3,34	3,27
<b>Mean</b>	21,86	22,51	24,08		3,01	3,02	3,32	
	Ca(%)				Mg (%)			
<b>80</b>	1,24	1,26	1,23	1,24	0,26	0,25	0,24	0,25
<b>100</b>	1,20	1,18	1,23	1,20	0,24	0,26	0,23	0,24
<b>120</b>	1,19	1,20	1,20	1,20	0,24	0,25	0,22	0,24
<b>Mean</b>	1,21	1,21	1,22		0,25	0,25	0,23	
	K/(Ca+Mg)				P (%)			
<b>80</b>	1,78	2,14	2,15	2,02	0,39	0,43	0,43	0,41
<b>100</b>	2,19	1,78	2,37	2,11	0,43	0,39	0,47	0,43
<b>120</b>	2,23	2,26	2,34	2,28	0,41	0,43	0,44	0,43
<b>Mean</b>	2,06	2,06	2,29		0,41	0,41	0,45	
	ADF (%)				NDF (%)			
<b>80</b>	27,94	21,83	24,06	24,61	43,46	36,10	37,92	39,16
<b>100</b>	21,70	25,98	23,74	23,81	35,93	40,82	37,48	38,08
<b>120</b>	23,83	22,71	24,37	23,64	38,37	37,07	38,90	38,12
<b>Mean</b>	24,49	23,50	24,06		39,25	38,00	38,10	

\*There are no significant differences amongst the number are shown with the same letter in the same line and column

Effects of seeding rates and row spaces on K, Ca, Mg, K/(Ca+Mg), P, ADF and NDF characteristics of forage pea were not significant (Table 1). K content of forage pea varied from 2,57% to 3,45%. These data are higher than values of maximum 0,8% suggested (NRC, 1996). High K concentration may cause Mg deficiency and as a result, tetany risk for ruminant increases (Loreda et al.,1986). Grass tetany or hypomagnesemic tetany in cattle is caused by an imbalance of K, Ca and Mg in the diet.

Mean Ca content of forage pea ranged between 1.18% - 1.26% (Table 1). Tajeda et al.(1985), reported that forage crops should contain Ca at least 0,3% for ruminants. The American National Research Council (NRC, 1984) recommended that forage crops should contain 0.31% Ca for beef cattle. Ca concentration of forage pea obtained from this study was enough for livestock. Mg content of forage pea ranged from 0,22% to 0,26%. There were few alterations. Recommended Mg concentrations for forage crops are 0,2% for ruminants (Tajeda et al., 1985) and 0,1% for beef cattle (NRC,1984). Mg content of pea forage was sufficient for ruminants. In order to maintain good animal health, the balance of mineral nutrient elements in forage or animal diets is very important and these elements should be in a certain ratio (



Abbasi et al., 2009). Ayan et al. (2010) reported that  $K/(Ca+Mg)$  ratio should not exceed 2.2 in forage. The value 2.2 or greater in forage can cause tetany (Jefferson et al., 2001). In this study  $K/(Ca+Mg)$  ratios varied between 1.78 - 2.37 (Table 1). Some of the data determined in this study are slightly higher than 2.2 (Table 1). It has been reported that P requirements of gestating or lactating beef are 0.18 - 0.39% (NRC,1996; Tekeli and Ateş,2005). P content of forage pea ranged from 0.39% to 0.47% (Table 1). Results obtained for P concentration in this study are slightly higher than requirements (Table 1).

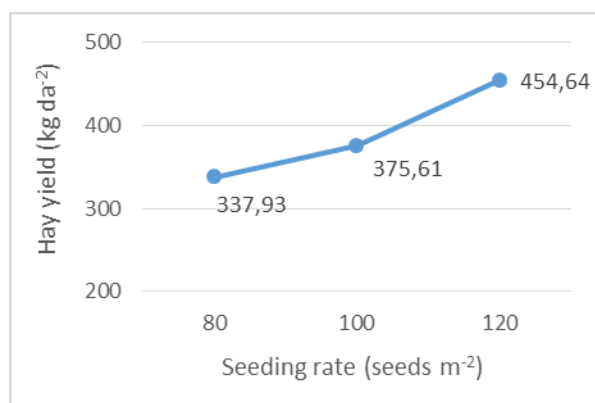


Figure 1. Effects of seeding rate on hay yield

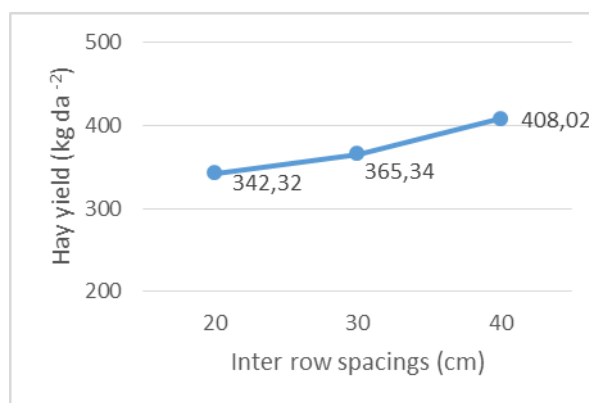


Figure 2. Effects of row spaces on hay yield

The ADF fraction includes cellulose with lignin and it is a slowly digestible material in forage (Acikgoz et al., 2013). As ADF increases, forage quality declines (Joachim and Jung,1997). In this study ADF contents of hay were under 30% and this value corresponded to prime quality according to forage standard (Yavuz et al., 2009). ADF ratios varied from 21 to 34% in previous studies (Tan et al., 2014; Uzun et al., 2017). These researchers reported that the effects of seeding rates on the ADF ratio of forage peas were significant. If the NDF value increases, dry matter intake generally decreases, and the rumination period increases (Van Soest et al.,1991). NDF contents of hay were between 36.10% - 43.46% in this study (Table 1). The NDF fraction includes cellulose, lignin and hemicellulose and as with ADF, this value is an important factor in determining forage quality. When NDF content decreases, dry matter intake will increase (Kebede et al., 2014). NDF results obtained from this study were similar to the NDF ratios reported by other researchers (Tan et al, 2014; Uzun et al., 2017).

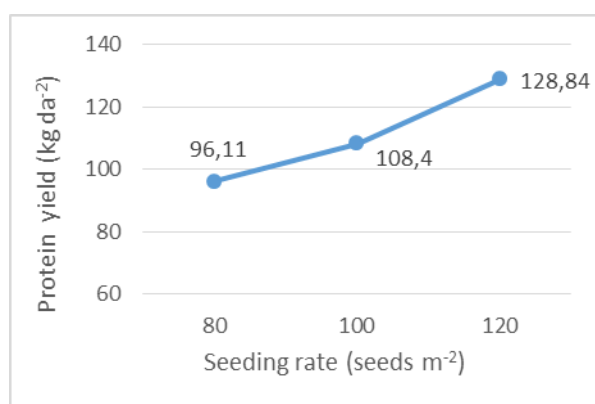


Figure 3. Effects of seeding rates on hay yield

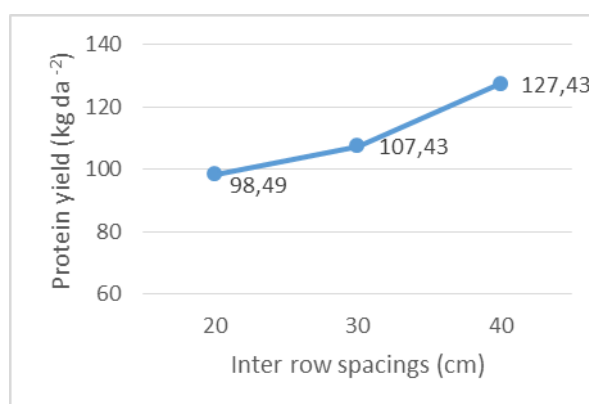


Figure 4. Effects of row spaces on hay yield

## **Conclusion**

Forage pea is an important annual winter forage crop in Turkey. Considering climatic conditions and other factors, it has a huge production potential in the Black Sea Region of Turkey. In light of the results obtained from this one year research, forage pea should be cultivated in 40 cm row spacing with 120 viable seeds per m<sup>2</sup>.

## **Acknowledgement**

This study was financially supported by Scientific Research Council of Ondokuz Mayıs University with a project number PYO. ZRT. 1904. 17. 020.

## **References**

- Abbasi, M.K, M.M. Tahir, A.S. Shah, F. Batool. 2009. Mineral nutrient composition of different ecotypes of white clover and their nutrient credit to soil at Rawalakot Azad Jammu and Kashmir. *Pak. J. Bot.*, 41(1):41-51,2009.
- Acikgöz, E., M. Sincik, G. Wietgreffe, M. Surmen, S. Cecen, T. Yavuz, C. Erdurmus and A.T. Goksoy. 2013. Dry matter accumulation and forage quality characteristics of different soybean genotypes. *Turk.J. Agric. For.* 37:22-32.
- Ayan, I., H. Mut, O. Onal-Ascı, U. Basaran, Z. Acar. 2010. Effects of manure application on the chemical composition of rangeland hay. *Journal of Animal and Veterinary Advances*, 9(13): 1852-1857.
- Jefferson, P.G., H.F. Mayland, K.H. Asay, J.D. Berdahl. 2001. Variation in mineral concentration and grass tetany potential among Russian Wildrye Accessions, *Crop Sci.* 41, pp. 543-548.
- Joachim, H. and G. Jung. 1997. Analysis of forage fiber and cell walls in ruminant nutrition. *Journal of Nutrition* 127:810-813.
- Jovaisiene, E., I. Bakstys and V. Jonusiene, 1998. The dependence of pea crop density and productivity on seed rate and sowing time in Western Lithuania. *Zemdirbyste Mokslo Darbia.* 63:156-165.
- Kebede, G., G. Assefa, A. Mengistu and F. Feyissa. 2014. Forage nutritive values of vetch species and their accessions grown under nitosol and vertisol conditions in the central highlands of Ethiopia. *Livestock Res. Rur. Develop.* 26(1):1-14.
- Loreda, C. M. A., G. A. Ardilla and V. J. Alvarez, 1986. Variation in mineral concentrations in grasses in the cattle farming are of the Caribbean. *Her. Abst.* 56:928.
- Manga, İ., Acar, Z., Ayan, İ., 2003. *Baklagil Yem Bitkileri.* OMÜ Zir. Fak. Yay. Ders Kitabı No: 7, (genişletilmiş 2. Baskı), Samsun, 451 s.
- NRC 1984. *Nutrient Requirements of Domestic Animals. Nutrient Requirements of Beef Cattle.* 6 th rev.edn. NAS-NRC, Washington.
- NRC (National Research Council), 1996. *Nutrient Requirements of Beef Cattle (7th Ed.)* National Academy Press, Washington, D.C.
- Sayar, M. S. 2007. Diyarbakır ekolojik koşullarında bazı yem bezelyesi (*Pisum arvense* L.) hat ve çeşitlerinin verim ve verim öğelerinin belirlenmesi üzerine bir araştırma, Çukurova Üniversitesi Fen Bilimleri Enstitüsü (Yüksek Lisans Tezi), Adana, 53s.
- Tajeda, R., L.R. McDowell, F.G. Martin and J.H. Conrad. 1985. Mineral element analyses of various tropical forages in Guatemala and their relationship to soil concentrations. *Nut. Rep. Int.*, 32: 313-324.

- Tan, M., K. Kursun Kircı and Z. Dumlu Gul. 2014. Effects of row spacing and seeding rate on hay and seed yield of Eastern Anatolian forage pea (*Pisum sativum* ssp. *arvense* L.) ecotype. *Turk. J. Field Crops*. 19(1): 96-100.
- Tekeli, A.S., E. Ates, 2005. Yield potential and mineral composition of white clover (*Trifolium repens* L.)-tall fescue (*Festuca arundinacea* Schreb.) mixtures. *J. Cent. Eur. Agric.*, 6:27-34.
- Townley-Smith, L. and A. T. Wright, 1994. Field pea cultivar and weed response to crop seed rate in Western Canada. *Can. J. Plant Sci.* 74: 387-393.
- Turk M., S. Albayrak and O.Yuksel. 2011. Effects of seeding rate on the forage yields and quality in pea cultivars of differing leaf types. *Turk. J. Field Crops*. 16(2): 137-141.
- Uzun, A. and E. Acikgoz, 1998. Effect of sowing season and seeding rate on the morphological traits and yields in pea cultivars of different leaf types. *J. Agron. Crop Sci.* 181:215-222.
- Uzun, A., B. A., Asik and E. Acikgoz, 2017. Effects of different seeding rates on forage yield and quality compenents in pea. *Turk J. Field Crops*, 22 (1): 126-133.
- Van Soest, P.J., J.B. Robertson and B.A. Lewis. 1991. Methods for dieatary fiber, neutral detergent fiber and nonstarch polysaccharides in relation to animal nutrition. *J. Dairy Sci.* 74:3583-3597.
- Yavuz, M., S. Iptas, V. Ayhan and Y. Karadag. 2009. Forage quality and nutritional problems caused by forage. 5.1. Quality analysis at forage and usage areas of forage. In: *Forage General Chapter I*, ed.. Avcioğlu, R., Hatipoğlu, R. and Karadağ, Y., 163-172. T.C. Ministry of Agriculture and Rural Areas General Directorate for Agricultural Production and Development Publication, Izmir.
- Yavuz, T., M. Surmen and N. Cankaya, 2011. Effect of row spacing and seeding rate on yield and yield components of common vetch (*Vicia sativa* L.). *J. food Agr. Environ.* 9 (1): 369-371.

## EFFICIENCY OF DIFFERENT CHEMOMETRIC METHODS FOR DETERMINATION OF OIL CONTENT IN MAIZE BY NIR SPECTROSCOPY

Fatih KAHRIMAN<sup>1\*</sup>, Fatih ÖNER<sup>2</sup>, Figen MERT TÜRK<sup>3</sup>, Ayşe Nur GÖKÇE<sup>4</sup>, Ebru DÜZEN<sup>4</sup>, İskender ONAÇ<sup>1</sup>, Cem Ömer EGESEL<sup>4</sup>

<sup>1</sup>Çanakkale Onsekiz Mart University, Faculty of Agriculture, Department of Field Crops, Çanakkale, Turkey

<sup>2</sup>Ordu University, Faculty of Agriculture, Department of Field Crops, Ordu, Turkey

<sup>3</sup>Çanakkale Onsekiz Mart University, Faculty of Agriculture, Department of Plant Protection, Çanakkale, Turkey

<sup>4</sup>Çanakkale Onsekiz Mart University, Faculty of Agriculture, Department of Agricultural Biotechnology, Çanakkale, Turkey

\*Corresponding Author: fkahriman@hotmail.com

### Abstract

In the process of developing calibration models, use of chemometric methods and data pretreatments help to improve the accuracy of estimation. The objective of this study was to compare five wavelength selection techniques and seven pretreatments for oil content estimation in NIR spectroscopy. Flour samples from 250 different maize genotypes were used as experimental material. Soxhlet extraction was performed to determine the oil content of the samples as a reference method. Derivatives (FD and SD), standard normal variate (SNV), and multiplicative scatter correction (MSC) were used as data pretreatment. To select informative wavelengths for improving the accuracy of the models developed, several techniques were used, such as MAXR, successive projections algorithm (SPA), uninformative wavelength elimination (UVE), competitive adaptive reweighted sampling (CARS) and random frog (RFROG) methodologies. Partial least squares (PLS) and multiple linear regressions (MLR) were used for model development. Full range of scanned interval (1200-2400 nm) and selected wavelengths by the chemometric techniques were designed as predictor variables in the models. Internal and external validations were performed to compare the robustness of the models developed. The best prediction performance (RMSEC=0.516, SEC=0.518,  $R^2_{\text{Cal}}=0.905$ , RMSEP=0.463, SEP=0.465,  $R^2_{\text{Val}}=0.823$  and RPD=2.37) was obtained from the FD-MSC-CARS-PLS model combination. Our results showed that the prediction accuracy of the NIR calibration models for oil content could be improved by using novel techniques of chemometrics. Three different wavelength intervals (1200-1400 nm, 1600-1800 nm and 2000-2400 nm) within the scanned region turned up to be effective in estimating oil content of maize grain.

**Keywords:** *Regression, Zea mays, wavelength, flour*

### Introduction

Plant oils have an important share in human nutrition as well as in industrial use. Increasing oil content has become one of the main breeding purposes in most agricultural crops. Although maize is not considered as an oil plant, it contributes a considerable portion of oil consumption in many countries. This brings about intensive studies to increase oil content of maize kernel. A main requirement of success in these breeding studies is an accurate and fast way of determination of the oil content in analysed samples.

Several apparatus have been used to determine the oil content of oil seeds such as Soxhlet, Goldfisch, Butt, and Bailey-Baker (Matthäus and Brühl, 2001). These systems are based on the use of organic solvents. There are also several solvent extraction systems such as Folch,

Bligh and Dyer, Sheppard methods for oil determination. The prevalent method in most laboratories for determining oil content in food and feed products is Soxhlet system. However, it requires large volume of organic solvents and excessive time for extraction (Matthäus and Brühl, 2001). Therefore, there is a need to develop alternative methods for analysing the oil seeds.

NIR spectroscopy offers an eligible alternative to estimate oil content, being a non-destructive and user friendly technique (Teye *et al.*, 2013). This technique entails a calibration model that could be developed by using standard chemical methods. In the process of developing calibration models, use of chemometric methods help to improve the accuracy of estimation. Different chemometric techniques are available (Reich, 2005; Roggo *et al.*, 2007), which can be viewed in three steps: data pretreatment, wavelength selection and model development/validation. Data pretreatment is commonly applied to reduce the unwanted effects such as nonlinearity, baseline effect and particle size. Derivatives, Multiple Scatter Correction (MSC), Standard Normal Variate (SNV) and detrending or combination of these are mostly used pretreatment methods in spectroscopic studies (Singh *et al.*, 2006).

The literature lacks publications that report the use of different pretreatment and wavelength selection techniques collectively in the estimation of oil content in maize. Therefore, it would be useful to reveal the possible effects caused by different combinations of spectral pretreatments and wavelength selections on oil content analysis.

From this point of view; this study aims to investigate the prediction potential of different chemometric method and pretreatment combinations for determination of oil content in maize kernel.

### **Material and Methods**

Two hundred and fifty maize samples were used as a plant material in this study; including breeding materials, open pollinated landraces and commercial hybrids. The experiment was conducted in the Agricultural Biotechnology and Field Crops Laboratories of Çanakkale Onsekiz Mart University in Turkey. Oil contents of maize samples were determined by Soxhlet extraction. For this purpose, kernel samples were grinded out with 0.5 mm sieve using laboratory mill (Fritsch pulverisette 14, Germany). Samples were extracted with diethyl ether for 6 hours using a commercial Soxhlet system (MXTOPS, Korea). Then, the solvent was evaporated under vacuum with diagonal rotary evaporator (Hahn Vapor, Korea). Crude oil samples were weighed with a laboratory balance (Denver Instrument, USA). In order to develop prediction models, spectra were taken from the ground samples within the interval of 1200-2400 nm in default mode of NIRS instrument (Spectrastar 2400D, Unity Scientific, USA). Rotating cup mode was used and spectra were taken from 24 different points of each sample. Then, all spectra were combined into one file for model development. Derivatives (FD and SD), standard normal variate (SNV), and multiplicative scatter correction (MSC) were used as data pretreatment. All pretreatment applications were performed in Unscrambler 10X software (Camo, Norway). Different techniques were used for elimination uninformative variable or informative ones before creating the prediction models, such as MAXR, successive projections algorithm (SPA), uninformative wavelength elimination (UVE), competitive adaptive reweighed sampling (CARS) and random frog (RFROG) methodologies. MAXR selection was performed in SAS statistical software as described in Abdel-Nour *et al.* 2009, SPA selection was applied using SPA-GUI toolbox of Matlab 7.0 (Galvão *et al.*, 2008), and uninformative wavelength elimination (UVE), competitive adaptive reweighed sampling (CARS) and random frog (RFROG) selection were performed using libPLS package (Li *et al.*, 2014) of Matlab 7.0 statistical software. Partial least squares (PLS) and multiple linear regressions (MLR) were used for model development. Sample set were divided into two parts using Kernard-Stone Algorithm, one of which for developing the prediction models and the

other for performing the external validation. Modelling studies was performed in Unscrambler 10X software for obtaining uniform output from different techniques. Prediction accuracy of the developed models was evaluated by RMSEP,  $R^2_{Cal}$ ,  $R^2_{Val}$ , r, and RPD values.

### Results and Discussion

Descriptive statistics for calibration (n=200) and external validation sets (n=50) are summarized in Table 1. Oil content values of the calibration set had a broad variation, with an average of 5.14%. The samples in external validation set had the range within the limit of calibration samples (Table 1). The range of the oil values in this study was quite wide compared to some previous studies. Fassio et al. (2015) used 128 maize samples having a range of 3.1-5.3% to develop a NIR prediction model for oil content. In another study, a PLS calibration was developed to predict the oil content of the samples (n=70) having a range of 2.62%-6.08% oil (Tallada *et al.*, 2009). Wider range could support the prediction accuracy of developed models.

Table 1. Descriptive statistics for the oil contents (%) of the samples used in calibration and validation sets.

	n	Mean	Minimum	Maximum	Standard Deviation
Calibration set	200	5.14	2.35	10.9	1.68
External validation set	50	4.79	3.07	9.54	1.10

n: Number of samples.

Results of the evaluation parameters for the developed models are summarized in Table 2. Full spectrum (1200-2400 nm) with no pretreatment yielded an acceptable prediction accuracy in the calibration (RMSEC=0.667, SEC=0.669,  $R^2_{Cal}$ =0.841) and validation sets (RMSEP=0.519, SEP=0.522,  $R^2_{Val}$ =0.784, RPD=2.11). Different pretreatment and wavelength selection combinations showed significant variability for prediction performance. However, it could be said that applying the spectral pretreatment and inclusion of informative variables to prediction models gave more robust prediction results. Nevertheless, transforming the second derivative spectra with SNV or MSC methods had lower RPD values compared to first derivative spectra. This implies that first derivative is a more suitable transformation for the spectra from maize flour samples. The best prediction performance (RMSEC=0.516, SEC=0.518,  $R^2_{Cal}$ =0.905, RMSEP=0.463, SEP=0.465,  $R^2_{Val}$ =0.823 and RPD=2.37) was obtained from the FD-MSC-CARS-PLS model combination. Wavelengths used in the prediction models can be seen in Figure 1. Additionally, the numbers of wavelengths used in the models are given in Table 2. A careful look into these outputs helps to understand that 3 different regions within the scanned area (1200-2400 nm) are important for the prediction of oil content: 1200-1400 nm, 1600-1800 nm and 2200-2400 nm. Numbers of wavelengths within this spectral region varied in the developed models. To be able to make estimation for a variable in NIR instrument, the energy carried by the electromagnetic spectrum should interact with the targeted variable. This interaction is based on the vibration of the chemical bonds found in the structure of the matter. The wavelengths determined to be related with oil content and included as predictors in the developed models seem to be located in the spectral regions where C-H and O-H bonds, related with oil, are interacted. Our study supports the earlier studies (Siesler *et al.*, 2002; Egesel and Kahrıman, 2012) reporting certain spectral intervals related with oil content.

Table 2. Evaluation statistics for the developed prediction models using different pretreatment and wavelength selection methods

Pretreatment	WN*	Calibration set (n=200)			External Validation Set (n=50)			
		RMSEC	SEC	R <sup>2</sup> <sub>Cal</sub>	RMSEP	SEP	R <sup>2</sup> <sub>Val</sub>	RPD
<b>Wavelength Selection-Regression Method: None-PLS</b>								
Raw	1200	0.667	0.669	0.841	0.519	0.522	0.784	2.11
FD	1200	0.674	0.676	0.838	0.515	0.520	0.786	2.12
SD	1200	0.722	0.725	0.814	0.511	0.516	0.787	2.13
FD-SNV	1200	0.695	0.697	0.828	0.535	0.538	0.765	2.04
SD-SNV	1200	0.690	0.691	0.831	0.568	0.567	0.738	1.94
FD-MSC	1200	0.694	0.696	0.828	0.534	0.537	0.766	2.05
SD-MSC	1200	0.689	0.690	0.831	0.575	0.572	0.734	1.92
<b>Wavelength Selection-Regression Method: MAXR-MLR</b>								
Raw	5	0.643	0.636	0.857	0.543	0.549	0.756	2.00
FD	5	0.643	0.635	0.857	0.485	0.490	0.813	2.25
SD	5	0.623	0.615	0.866	0.521	0.526	0.775	2.09
FD-SNV	5	0.612	0.604	0.871	0.509	0.511	0.787	2.15
SD-SNV	5	0.634	0.626	0.861	0.556	0.561	0.743	1.96
FD-MSC	5	0.732	0.722	0.815	0.537	0.542	0.761	2.03
SD-MSC	5	0.630	0.622	0.863	0.551	0.556	0.749	1.98
<b>Wavelength Selection-Regression Method: SPA-MLR</b>								
Raw	4	0.702	0.695	0.829	0.471	0.472	0.829	2.33
FD	2	0.721	0.718	0.818	0.543	0.548	0.764	2.01
SD	2	0.724	0.720	0.816	0.513	0.518	0.784	2.12
FD-SNV	2	0.714	0.710	0.821	0.563	0.567	0.738	1.94
SD-SNV	2	0.710	0.707	0.823	0.628	0.626	0.682	1.76
FD-MSC	2	0.715	0.711	0.821	0.561	0.565	0.739	1.95
SD-MSC	3	0.705	0.700	0.827	0.576	0.572	0.732	1.92
<b>Wavelength Selection-Regression Method: CARS-PLS</b>								
Raw	194	0.645	0.646	0.852	0.589	0.593	0.714	1.85
FD	8	0.708	0.709	0.822	0.500	0.505	0.799	2.18
SD	250	0.779	0.781	0.784	0.732	0.732	0.592	1.50
FD-SNV	40	0.844	0.846	0.747	0.707	0.693	0.614	1.59
SD-SNV	5	0.657	0.659	0.846	0.587	0.590	0.717	1.86
FD-MSC	20	0.516	0.518	0.905	0.463	0.465	0.823	2.37
SD-MSC	2	0.714	0.716	0.819	0.641	0.645	0.659	1.71
<b>Wavelength Selection-Regression Method: UVE-PLS</b>								
Raw	25	0.839	0.673	0.839	0.482	0.486	0.821	2.26
FD	23	0.610	0.612	0.868	0.541	0.546	0.761	2.01
SD	14	0.670	0.671	0.840	0.491	0.495	0.806	2.22
FD-SNV	22	0.596	0.597	0.874	0.441	0.445	0.841	2.47
SD-SNV	13	0.694	0.696	0.829	0.576	0.571	0.737	1.93
FD-MSC	21	0.632	0.634	0.858	0.510	0.513	0.793	2.14
SD-MSC	15	0.708	0.710	0.822	0.571	0.572	0.733	1.92
<b>Wavelength Selection-Regression Method: RFROG-PLS</b>								
Raw	10	0.721	0.722	0.815	0.546	0.551	0.751	2.00
FD	10	0.657	0.659	0.846	0.576	0.582	0.724	1.89
SD	10	0.718	0.719	0.817	0.547	0.552	0.778	1.99
FD-SNV	10	0.702	0.704	0.825	0.536	0.541	0.761	2.03
SD-SNV	10	0.676	0.678	0.837	0.575	0.570	0.735	1.93
FD-MSC	10	0.705	0.707	0.823	0.535	0.540	0.760	2.04
SD-MSC	10	0.655	0.656	0.848	0.561	0.562	0.742	1.96

\*WN is wavelength number in prediction models; Abbreviations are explained in material and methods

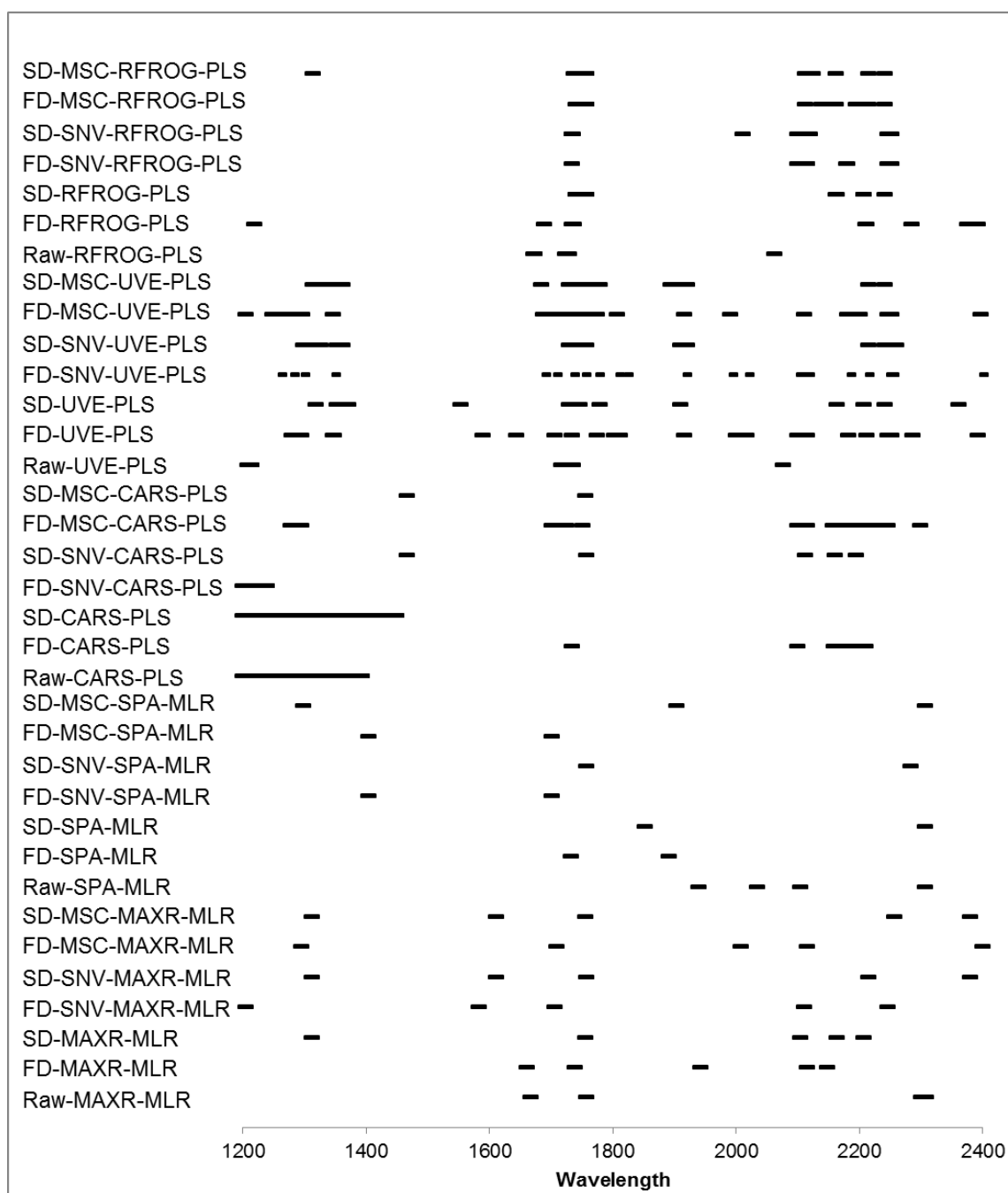


Figure 1. Wavelengths used in the developed models for prediction of oil content.

### Conclusions

In conclusion, chemometric applications used here improved the prediction ability of NIR calibration models for oil content. Inclusion of related wavelengths in the prediction models and exclusion of others provide a clear contribution to the model performance. Different pretreatment and wavelength selection methods may be applied to increase the robustness of the developed calibration models for NIR instruments. Unfortunately, most of the traditional softwares do not have effective wavelength selection and pretreatment methods. Inclusion of such techniques into the current softwares may possibly improve the robustness of the calibration models. Also, other model development techniques such as artificial neural network and support vector machines may be utilized in future studies with similar objectives.



## **Acknowledgement**

This study was supported by The Scientific and Technological Research Council of Turkey (TÜBİTAK Project Number: 215O867).

## **References**

- Abdel-Nour N., Ngadi M., Prasher S., Karimi Y. (2009). Combined maximum R2 and partial least squares method for wavelengths selection and analysis of spectroscopic data. *International Journal of Poultry Science* 8(2):170–78.
- Egesel C.Ö., Kahriman F., (2012). Determination of quality parameters in maize by NIR reflectance spectroscopy. *Journal of Agricultural Sciences*, 18: 43-53.
- Fassio A.S., Restaino E. A., Cozzolino D. (2015). Determination of oil content in whole corn (*Zea mays* L.) seeds by means of near infrared reflectance spectroscopy. *Computers and Electronics in Agriculture*, 110: 171-175.
- Galvão R. K. H., Araújo M. C. U., Frago W. D., Silva E. C., José G. E., Soares S. F. C., Paiva H. M. (2008). A variable elimination method to improve the parsimony of mlr models using the successive projections algorithm, *Chemometrics and Intelligent Laboratory Systems*, 92 (1) 83–91.
- Li H., Xu Q-S., Liang Y. (2014). libPLS: An integrated library for partial least squares regression and discriminant analysis. *PeerJ PrePrints* 2:e190v1.
- Matthäus B., Brühl L. (2001). Comparison of different methods for the determination of the oil content in oilseeds. *Journal of the American Oil Chemists' Society* 78(1): 95–102.
- Reich, G. (2005) Near-infrared spectroscopy and imaging: Basic principles and pharmaceutical applications. *Advanced Drug Delivery Reviews*, 57: 1109–1143.
- Roggo Y., Chalus P., Maurer L., Lema-Martinez C., Edmond A., Jent N. (2007). A review of near infrared spectroscopy and chemometrics in pharmaceutical Technologies. *J. Pharm. Biomed. Anal.* 44:683–700.
- Siesler H.W., Ozaki Y., Kawata S., Heise H.M. (2002). *Near-Infrared Spectroscopy. Principles, Instruments, Applications.* Wiley-VCH, Weinheim
- Singh C. B., Paliwal J., Jayas D.S., White N. D. G. (2006). Near-infrared spectroscopy: Applications in the grain industry. *The Canadian Society for Bioengineering*, Paper no: 06-189.
- Tallada J.G., Palacios-Rojas N., Armstrong P.R. (2009). Prediction of maize seed attributes using a rapid single kernel near infrared instrument. *Journal of Cereal Science*, 50(3): 381-387.
- Teye E., Huang X-Y., Afoakwa N. (2013). Review on the potential use of near infrared spectroscopy (NIRS) for the measurement of chemical residues in food. *American Journal of Food Science and Technology* 1(1): 1–8.

## EFFECT OF IODINE ON GERMINATION AND YIELD IN ROCKET (*Eruca vesicaria*) PLANT

Gizem AKSU\*<sup>1</sup>, Berat Sencer AKARSLAN<sup>1</sup>, Hamit ALTAY<sup>1</sup>

<sup>1</sup>Canakkale Onsekiz Mart University, Faculty of Agriculture, Department of Soil Science and Plant Nutrition, Turkey

\*Corresponding author: gizemaksu@comu.edu.tr

### Abstract

Iodine is an essential trace element for human health and is involved in the production of the thyroid hormone. Recently, a new idea has emerged: to meet people's need for daily iodine by increasing the iodine content of vegetables. This study was carried out with iodine foliar application and root application methods to determine which application was more appropriate and to see the effect of iodine on germination. Germination experiments were conducted in an incubator according to a random block design, with 5 doses of iodine and five replicates. The yield experiment was conducted according to the same design in a greenhouse, with 5 doses of iodine, two application methods and three replicates. At the end of the germination experiment, the germination rate, root fresh and dry weight and root length were determined and at the end of the yield experiment, the plant fresh and dry weights were determined. The germination rate was not affected by the application. Root fresh and dry weight decreased with application doses. Applications reduced the root length by 50%, compared to the control plants. According to the yield results, the plant fresh and dry weight decreased with the increase in doses in two applications. It is important that no loss of yield occurred with the applications to increase the iodine content of the vegetables. After comparing foliar and root application methods, it is thought to be more appropriate to apply iodine by foliar spraying. In addition, the application dose should be selected carefully in order to avoid harming the plant.

**Key words:** *Iodine, Rocket, Vegetable, Thyroid.*

### Introduction

Iodine is an essential element for humans and animals, while not necessarily a nutrient for plants. Iodine, which is involved in thyroid hormone production, is an essential element for normal growth and development and for brain and body functions (Erbaş, 2008).

The amount of iodine in rocks is generally low. Iodine concentrations are between 0.2 and 0.8 ppm in basic extrusive. In acid eruptive, metamorphic rocks and some sedimentary rocks, the amount of iodine varies from 1 to 2 ppm. The average iodine content of the soil surface is stated as 5  $\mu\text{g g}^{-1}$ . The iodine content of the soil is more than 20-30 times that of rocks (Halilova, 2004). According to Whitehead (1984), the basic source of iodine in the soil is atmospheric iodine and the main sources of atmospheric iodine are seas and oceans (Tsukada et al., 2008). Iodine can easily evaporate under the influence of daylight and temperature. Iodine, which is mixed with the atmosphere, reaches land with rain (Halilova, 2004). The losses which occur during the process of the iodine reaching the soil cause a small amount of iodine to be found in the soil and in the crops grown in these soils. According to the WHO, ICCIDD (International Council for the Control of Iodine Deficiency Disorders), Global Network and UNICEF, the daily amounts of iodine that people should take are as follows: 0-6 years - 90 micrograms ( $\mu\text{g}$ ), 7-12 years - 120  $\mu\text{g}$ , over 12 years - 150  $\mu\text{g}$  and pregnant and

lactating women - 250 µg. When the daily iodine requirement is not satisfied, a series of developmental and functional diseases known as Iodine Deficiency Disorders can occur. Although iodine deficiency can be cured, it remains a health problem for about 35% of the world's population (Pearce *et al.*, 2004; Winger 2008; Landini, 2011). According to recent WHO surveys, around 2 billion people in the world are still confronted with insufficient iodine intake. Compared with the WHO regions, the European continent has the highest rate of iodine deficiency, at 45% of the population (Anderson *et al.*, 2012; Daum *et al.*, 2013). In Turkey, iodine deficiency remains an important public health problem.

The visible sign of iodine deficiency is the goiter which is seen in all age groups. The total prevalence of goiter in Turkey is as high as 30.5% and the visible goiter rate is around 6.7% (Yordam *et al.*, 1999).

Iodine deficiency causes growth retardation, deafness, dwarfism and hypothyroidism in infants, growth retardation, school failure, difficulties in understanding and learning in children and adolescents, hypothyroidism, inadequate mental functioning, weakness and inefficiency in adults (Pekcan, 2008). At the same time, iodine deficiency was found to reduce IQ by 13.5 points (Pekcan, 2008; Zimmermann, 2012). There is an increased risk of death in newborns with a lack of iodine. The prevention of iodine deficiency in China and Zaire has been shown to reduce the risk of newborn mortality (Erbaş, 2008).

In the human body and animals, 80% of the iodine is naturally supplied by edible vegetables (Welch and Graham, 2005; Weng *et al.*, 2013) and the bioavailability of iodine in these vegetables is about 99%. The concentration of iodine in the soil in which vegetables are grown is usually too low to supply the needs of the human body (Weng *et al.*, 2013). The iodine content of the plant that grows in soil with a high amount of iodine is high.

Diet is the only way to take iodine into the body (Vitti *et al.*, 2001; Pekcan, 2008). The use of iodized salt is the most common approach for iodine supplementation (Delange and Lecomte, 2000; Andersson *et al.*, 2005). However, during activities such as cooking, storage and transportation, it is difficult to control the loss of iodine and iodine supplementation causes many problems during food processing (Winger *et al.*, 2008; Landini *et al.*, 2011). The level of iodized salt usage in our country is inadequate to control iodine deficiency (Özkan *et al.*, 2004). Increasing iodine levels in food with vegetables which have a high rate of bioavailability and assimilation is a more effective way of controlling iodine deficiency in a cost effective manner. (Dai *et al.*, 2004; Weng *et al.*, 2009; Landini *et al.*, 2011)

Food consumption in Turkey is largely composed of foods which are of cereal origin. In addition, leafy vegetables play an important role in the nutrition program. The rocket plant (*Eruca vesicaria*) is a vegetable with leaves consumed as a salad and recently its consumption has increased. The rocket plant is rich in vitamin C and also has antioxidant properties.

Considering that rocket production and consumption is increasing in Turkey, that it is consumed raw in salads daily, and that iodine can be accumulated in the leaves, this study aimed to determine which method is more appropriate to increase the iodine content of rocket plants, namely, spraying iodine on the leaves or applying it to the roots and to see the effect of iodine on germination.

### **Materials and Methods**

The yield experiment was developed under greenhouse conditions at Canakkale Onsekiz Mart University in Turkey. The rocket plant was chosen as study material because of its consumption as raw leaves. The experiment was conducted with a randomized block design with 5 doses of iodine in the form of potassium iodide (0, 1, 2, 4, 8 mM), two application methods (foliar and root application) and three replicates. The plants were grown with a Hoagland nutrient solution. At the end of the experiment, the plant's fresh and dry weights were determined. After harvesting, the fresh weight (FW) of leaves was directly determined.

For dry weight (DW) determination, the leaves were dried at 70°C for 48 h and weighed. Germination experiments were conducted in an incubator at 25°C according to a random block design, with 5 doses of iodine and five replicates. Fifty seeds sterilized with 10% hypochlorite were placed in each petri dish. At the end of the experiment, germination rate, root length, root fresh and dry weight were determined. The results were subjected to analysis of variance according to the randomized block experiment design using the MINITAB 17.0 statistical package program and the averages of the data with significant differences between them were compared with the LSD.

### Results and Discussion

The fresh weight data obtained from the soil and foliar iodine application to the rocket plant are given in Table 1. When Table 1 is examined, it can be seen that the highest fresh weight is 65.25 g and the lowest is 30.73 g. Interactions between the application form and the doses created a statistically significant difference ( $P < 0.01$ ) in plant fresh weight. In soil applications, the plant's fresh weight was reduced in parallel to the increasing dose of iodine. In foliar applications the change was not as great as in soil applications.

Table 1. Plant fresh weight (g) averages and multiple comparison results

Method of Application	Iodine application doses (mM)				
	0	1	2	4	8
Soil	65.25±0.68 A	46.95±3.82 BCD	41.07±0.77 CDE	35.88±0.72 DE	30.73±1.82 E
Foliar	55.02±2.04 AB	57.27±1.52 AB	53.35±11.9 ABC	55.75±5.2 AB	48.90±1.72 BCD

Mean values marked with the same letter in columns do not differ significantly ( $P < 0.01$ ) from each other.

The dry weight data obtained from the soil and foliar iodine application to the rocket plant are given in Table 2. When Table 2 is examined, it can be seen that the highest dry weight is 10.05 g and the lowest is 5.51 g. The highest weight was obtained in soil with 0 mM (control) iodine dose and the lowest weight was obtained in soil with 8 mM iodine dose. Interactions between the application form and the doses created a statistically significant difference ( $P < 0.01$ ) in plant dry weight. In a study carried out in lettuce, iodine (0.25 and 0.50 kg ha<sup>-1</sup>) applied to the leaves increased the content of iodine in the edible parts of the plant without reducing the yield and quality of the product (Daum *et al.*, 2013). The results of our study are not similar to this study, especially with the soil application reduced the yield.

Table 2. Plant dry weight (g) averages and multiple comparison results

Method of Application	Iodine application doses (mM)				
	0	1	2	4	8
Soil	10.05±0.36 A	6.90±0.30 CD	6.57±0.20 CD	5.77±0.40 D	5.51±0.16 D
Foliar	8.54±1.95 ABC	9.26±0.26 AB	9.58±0.66 A	8.43±0.70 ABC	7.35±0.12 BCD

Mean values marked with the same letter in columns do not differ significantly ( $P < 0.01$ ) from each other.

The seeds were placed in petri dishes and germinated seeds started to be counted one day after iodine application. The counting continued until the eighth day and the germination percentages of the seeds were calculated. Table 3 gives the number of germinated seeds in petri dishes with 0 (control), 1 and 2 mM iodine (I) applied.

Table 3. Number of germinated seeds in 0 (Control) 1 and 2 mM iodine applications

Replicate	1	2	3	4	5	Average	Rep.	1 mM I					Rep.	2 mM I							
								1	2	3	4	5		Avg.	1	2	3	4	5	Avg.	
0 mM I	1. Day	35	37	38	32	37	36	1 mM I	38	34	40	40	41	39	2 mM I	37	39	37	36	41	38
	2. Day	43	46	46	43	46	45		45	43	43	49	46	45		40	43	47	43	49	44
	3. Day	46	47	47	45	46	46		47	43	46	50	46	46		44	44	48	44	50	46

<b>5. Day</b>	47	49	47	46	46	47		47	45	47	50	47	47		45	45	48	45	50	47
<b>6. Day</b>	47	49	47	47	47	47		47	45	48	50	48	48		45	45	48	47	50	47
<b>7. Day</b>	47	49	47	48	47	48		47	45	48	50	48	48		45	45	48	47	50	47
<b>8. Day</b>	47	49	47	48	48	48		47	46	48	50	48	48		46	46	48	47	50	47

When Table 3 is examined, it can be seen that 48 seeds of 50 seeds in the control group were germinated at the end of the eighth day. The germination percentage was calculated as 96%. At the end of the eighth day, 48 seeds were germinated from 50 seeds which had been applied 1 mM iodine, and the germination percentage was calculated as 96%. In the group with 2 mM iodine applied, 47 seeds of 50 seeds were germinated and the germination percentage was found to be 94%. Table 4 gives the number of germinated seeds in petri dishes with 4 and 8 mM iodine (I) applied.

Table 4. Number of germinated seeds in 4 and 8 mM iodine applications

Replicate		1	2	3	4	5	Average	Rep.	1	2	3	4	5	Avg.
4 mM KI	<b>1. Day</b>	32	33	43	38	30	35	8 mM KI	40	33	34	38	29	35
	<b>2. Day</b>	42	41	47	44	42	43		47	46	46	47	45	46
	<b>3. Day</b>	43	45	48	45	45	45		47	49	46	47	46	47
	<b>5. Day</b>	45	46	48	46	47	46		48	49	46	47	46	47
	<b>6. Day</b>	45	46	49	47	47	47		48	49	46	47	46	47
	<b>7. Day</b>	45	46	49	47	47	47		48	49	46	47	46	47
	<b>8. Day</b>	45	46	49	47	48	47		48	49	46	47	46	47

When Table 4 is examined, it can be seen that 47 seeds of the 50 seeds in 4 mM iodine application had germinated by the end of the eighth day. Germination percentage was found to be 94%. It can be seen that 47 seeds of the 50 seeds in the 8 mM iodine application had germinated at the end of the eighth day. The percentage of germination was calculated as 94%. If we compare the germination percentages, it can be seen that the iodine application does not have a negative effect on germination. Root length data obtained from germinated seeds after iodine application are given in Table 5.

Table 5. Root length per plant (cm) averages and multiple comparison results

Root length (cm)						
Replicate	1	2	3	4	5	Average
<b>0 mM</b>	4.3	3.9	4.2	4.1	4.4	4.2 A
<b>1 mM</b>	3.5	3.4	3.3	3.3	3.7	3.4 B
<b>2 mM</b>	2.6	2.8	3.1	3.1	3.0	2.9 C
<b>4 mM</b>	2.9	3.2	2.5	2.7	3.0	2.9 C
<b>8 mM</b>	2.0	2.0	2.1	2.4	1.8	2.1 D

Mean values marked with the same letter in columns do not differ significantly ( $P < 0.01$ ) from each other.

When the table is examined, it can be seen that the iodine concentrations were determined to have no negative effect on germination, to adversely affect root development and to cause a decrease in root length. There was a 50% reduction in root length between the control group and the highest dose of 8 mM iodine. The doses applied created a statistically significant difference ( $P < 0.01$ ) in root length. Root fresh weight data obtained from germinated seeds after iodine application are given in Table 6.

Table 6. Root fresh weight per plant (g)

Root Fresh Weight (g)						
Replicate	1	2	3	4	5	Average
<b>0 mM</b>	0.0100	0.0114	0.0122	0.0071	0.0160	0.0114
<b>1 mM</b>	0.0114	0.0086	0.0105	0.0098	0.0100	0.0100

<b>2 mM</b>	0.0071	0.0103	0.0096	0.0095	0.0096	0.0092
<b>4 mM</b>	0.0089	0.0094	0.0078	0.0084	0.0097	0.0088
<b>8 mM</b>	0.0058	0.0055	0.0078	0.0076	0.0072	0.0068

When the table is examined, it can be seen that the iodine concentrations negatively affect root development without any adverse effect on germination. The highest weight was obtained with 0.0114 g in the control group, while the lowest weight was obtained with 0.0068 g in 8 mM iodine concentration. Between the control group and the highest iodine concentration, the root fresh weight was reduced by 40%. However, this change was not statistically significant. Root dry weight data obtained from germinated seeds after iodine application are given in Table 7.

Table 7. Root dry weight per plant (g)

Root Dry Weight (g)						
Replicate	1	2	3	4	5	Average
<b>0 mM</b>	0.000511	0.000531	0.000556	0.000463	0.000558	0.000524
<b>1 mM</b>	0.000395	0.000314	0.000409	0.000422	0.000400	0.000388
<b>2 mM</b>	0.000324	0.000378	0.000391	0.000390	0.000404	0.000378
<b>4 mM</b>	0.000324	0.000353	0.000375	0.000351	0.000382	0.000357
<b>8 mM</b>	0.000258	0.000273	0.000333	0.000310	0.000306	0.000296

When the table is examined, it can be seen that the root dry weight decreases in parallel with increasing iodine doses. Between the control group and the highest iodine concentration, the root dry weight decreased by 44%. However, this change was not statistically significant.

### Conclusions

Consequently, according to the germination experiment, the highest root fresh and dry weights were obtained in the control group and the lowest weight was obtained in 0.8 mM iodine dose. Applications also affected the root length and a difference of 50% was found between the control group and the highest dose. Iodine doses did not cause a difference in germination percentage. According to the results obtained from the yield experiment, plant fresh and dry weights were affected by the method of application. Plant fresh and dry weights decreased in parallel with increasing iodine doses in soil applications. In foliar applications, there was no significant decrease in plant fresh and dry weight compared to the control.

It is important that the method of application and the iodine concentration to be applied to increase the plant iodine content does not adversely affect the plant growth, or does not cause yield loss. Comparing soil and foliar applications, foliar application is considered more appropriate. In addition, the iodine concentration should be carefully selected so that root growth is not adversely affected.

### References

- Andersson M., Karumbunathan V., Zimmermann M.B. (2012). Global Iodine Status in 2011 and Trends over the Past Decade. *J. Nutr.*, 142: 744–750.
- Andersson M., Takko B., Egli I., Allen H. E., de Benoist B. (2005). Current Global Iodine Status And Progress Over the Last Decade Towards the Elimination of Iodine Deficiency. *Bull. World Health Organ.*, 83(7): 518–525.
- Dai J. L., Zhu Y.G., Zhang M., Huang Y.Z. (2004). Selecting Iodine-Enriched Vegetables and The Residual Effect of Iodate Application to Soil. *Biol. Trace Elem. Res.*, 101: 265–276.

- Daum D., Lawson P., Czauderna R. (2013). Enrichment of Field Grown Butterhead Lettuce with Iodine by Foliar Fertilization: Effect of Application Mode and Time. XVII. International Plant Nutrition Colloquium. 946–947.
- Delange F., Lecomte P. (2000). Iodine Supplementation: Benefits Outweight Risks, *Drug Saf.*, 22: 89–95.
- Erbaş T. (2008). Iodine Deficiency and Guatr. International Medical Geology Symposium. 94–95. Turkish.
- Halilova H. (2004). Biogeochemistry of Microelements (I, Zn, Co, Mn, Cu, Se). Ankara: İlke-Emek Publications. 9–23. Turkish.
- Landini M., Gonzali S., Perata P. (2011). Iodine Biofortification in Tomato. *J. Plant Nutr. Soil Sci.*, 174: 480–486.
- Özkan B., Olgun H., Ceviz N., Polat P., Taysi S., Orbak Z., Koşan C. (2004). Assessment of Goiter Prevalence, Iodine Status and Thyroid Functions in School-Age Children of Rural Yusufeli District in Eastern Turkey. *The Turkish Journal of Pediatrics*, 46: 16–21s.
- Pearce E. N., Pino S., He X., Bazrafshan H. R., Lee S. L., Braverman L. E. (2004). Sources of Dietary Iodine: Bread, Sow's Milk and Infant Dormula in Boston Area. *J. Clin. Endocrinol. Metab.*, 89: 3421–3424.
- Pekcan G. (2008). Iodine problem in Turkey. Sayfa 96–98. International Medical Geology Symposium. Ankara: YMGV Publications. Turkish.
- Tsukada H., Takeda A., Tagami K., Uchida S. (2008). Uptake and distribution of iodine in rice plants. *J. Environ. Qual.*, 37: 2243–2247.
- Vitti P., Rago T., Aghini-Lombardi F., Pinchero A. (2001). Iodine Deficiency Disorders in Europe. *Public Health Nutrition*. 4(2b): 529–535.
- Welch R.M., Graham R.D. (2005). Agriculture: The Real Nexus for Enhancing Bioavailable Micronutrients in Food Crops. *J. Trace Elem. Med. Biol.*, 18(4) 299–307.
- Weng H. X., Hong C. L., Xia T. H., Bao L.T., Liu H.P. (2013). Iodine Biofortification of Vegetable Plants—An Innovative Method for Iodine Supplementation. *Chin. Sci. Bull.*, 58(17): 2066–2072.
- Weng H. X., Yan A. L., Hong C. L., Qin Y. C., Pan L., Xie L. L. (2009). Biogeochemical Transfer and Dynamics of Iodine in a Soilplant System. *Environ. Geochem. Health*. 31: 401–411.
- Whitehead D. C. (1984). The Distribution and Transformations of Iodine in the Environment. *Environ. Int.*, 10(4): 321–339.
- Winger R. J., König J., House D. A. (2008). Technological Issues Associated with Iodine Fortification of Foods. *Trends Food Sci Technol.*, 19(2): 94–101.
- Yordam N., Özön A., Alikışıfoğlu A., Özgen A., Ceren N., Zafer Y., Şimşek E. (1999). Iodine Deficiency in Turkey. *Eur J Pediatr.*, 158(6): 501–505.
- Zimmermann M. B. (2012). "Iodine and Iodine Deficiency Disorders". Present Knowledge in Nutrition. Editör: Erdman, J. W., Macdonald, I. A., Zeisel. S. H. Wiley-Blackwell, Oxford, UK.

## EFFECTS OF HUMIC ACID APPLICATIONS ON LETTUCE GROWTH AND ON SOME PROPERTIES OF SOIL CONTAMINATED BY CADMIUM

Gizem AKSU\*

Canakkale Onsekiz Mart University, Faculty of Agriculture, Department of Soil Science and Plant Nutrition,  
Turkey

\*Corresponding author: gizemaksu@comu.edu.tr

### Abstract

This study investigated the effect of humic acid on the growth of lettuce and on some properties of soil under Cd pollution conditions. This work was carried out at the agriculture faculty of Canakkale Onsekiz Mart University in Turkey. An experiment was conducted according to a random block design, in a greenhouse with four doses of humic acid (0, 4, 8, 12 L da<sup>-1</sup>), three doses of Cd (0, 1.5 and 3 mg kg<sup>-1</sup>) and three replicates. The source of humic acid application was “TKİ-Humus”, a trademarked product, and the “Yedikule-5701” variety of lettuce was used. At the end of the experiment, the fresh weight (g) and dry weight (g) of the plants, leaf length (cm), leaf width (cm), soil reaction (pH), electrical conductivity (EC, μS/cm), and calcium carbonate (% of CaCO<sub>3</sub>) were determined. The results were subjected to a one-way ANOVA in the MINITAB 17.0 statistical package program. Differences which were statistically significant according to the results of variance analysis of the variables/elements were compared with an LSD test. The humic acid application showed a statistical difference (P>0.01) for leaf length. A statistical difference (P<0.05) was also observed in the plant’s fresh and dry weight and leaf width with regard to the interaction of the humic acid application and cadmium application. In contrast, no relationship was found between soil properties and humic acid except in the case of electrical conductivity. Humic acid and cadmium applications created a statistically significant difference (P<0.05) in electrical conductivity.

**Key words:** *Cadmium, Humic Acid, Lettuce, Soil*

### Introduction

The use of synthetic fertilizers has dramatically increased food production worldwide, but the unintended costs to the environment and human health have been substantial. Agricultural practice has changed a great deal in the last 30-40 years. Intensive farming techniques, especially aggressive N applications, have caused many environmental problems. Low-input and organic farming are two of the new challenging methods developing in agriculture all over the world (Rehber and Turhan, 2002). Many positive developments have been made to improve the quality and quantity of agricultural production. Unsuitable soil conditions for plant growth usually arise from the lack of organic content in the soil. The effect of organic matter on the physical, chemical, and biological properties of the soil has been well known for a long time. The organic matter content of soil in Turkey is generally low (Eyupoglu 1998). To solve this problem, additional humic substances have started to be applied to the soil, to improve the crop yield. Humic substances are derived from the breakdown of organic plant material, mainly by soil bacteria, and consist mainly of humus, humic acid, fulvic acid and trace minerals. Humic substances are usually applied to the soil, and favourably affect the soil structure and soil microbial populations. According to the International Humic Substances Society (IHSS), humic substances (HS) are complex and heterogeneous mixtures of



polydispersed materials formed in soils, sediments, and natural waters by biochemical and chemical reactions during the decay and transformation of plant and microbial remains (a process called humification). It was reported that humic substances affect physical and chemical properties of soils (Boyle et al. 1989; Schnitzer 1992). However, their effects on soil have not yet been clearly explained. Some reviews (Chen and Aviad, 1990; Varanini and Pinton, 1995) summarize the effects of humic substances on plant growth and the uptake of macro and micro elements. Another important aspect is the effect of heavy metals being present in the soil. Heavy metals are commonly defined as those having a specific density of more than 5 g cm<sup>-3</sup>. Heavy metals in urban soils may come from various human activities. Most heavy metals also pass through the food chain, which can damage human health. Although adverse health effects of heavy metals have been known for a long time, exposure to heavy metals continues and is even increasing in some areas. Exposure to cadmium (Cd) can have effects such as lung cancer, bone fractures, kidney dysfunction and hypertension. Humic substances with molecular weights ranging from several hundreds to millions constitute the bulk of natural organic matter and can appreciably affect the consequences of heavy metals in the environment (Davis and Bhatnagar 1995). The objective of this study was to study the effect of humic acid on the growth of lettuce and on some properties of soil under Cd pollution conditions.

### Materials and Methods

This study was carried out with the Yedikule 5701 lettuce variety (*Lactuca sativa L.*) in the greenhouse of the Soil Science and Plant Nutrition Department of the Agricultural Faculty, Canakkale Onsekiz Mart University. The soil characteristics are presented in Table 1.

**Table 1.** Physical and chemical properties of the soil

Texture	Electrical Conductivity (mS/cm)		Soil Reaction (pH)		Calcium Carbonate (%)	Organic Matter (%)	
Loamy	0.39		7.59		7.25	0.42	
Available P, mg kg <sup>-1</sup>	Available K, mg kg <sup>-1</sup>	Available Ca, mg kg <sup>-1</sup>	Available Mg, mg kg <sup>-1</sup>	Available Cu, mg kg <sup>-1</sup>	Available Zn, mg kg <sup>-1</sup>	Available Fe, mg kg <sup>-1</sup>	Available Mn, mg kg <sup>-1</sup>
6.65	7.91	4 097	251.80	0.10	0.41	1.96	1.65

For the analyses of soil, the texture was determined by the Bouyoucus (1951) hydrometric method, the pH by the Jackson (1958) 1: 2.5 soil-water suspension method, the lime content with 5 replicates by calcimetric methods (Allison & Moodie, 1965), the level of organic matter by the modified Walkley Black method (Walkey, 1947), the salt by the Richards (1954) method, and the soil samples were prepared by the wet digestion method and the plant nutrient contents were determined by ICP-MS. In the experiment, TKİ HÜMAS produced by Turkish Coal Enterprises was used as material. The humic acid used contained 5% total organic matter by weight and 2% water-soluble potassium oxide by weight and its pH was between 11-13. The experiment was conducted according to a random block design, in a greenhouse with four doses of humic acid (0, 4, 8, 12 L da<sup>-1</sup>), three doses of Cd (0, 1.5 and 3 mg kg<sup>-1</sup>) and three replicates. At the end of the experiment, the fresh weight (g) and dry weight (g) of the plants, leaf length (cm), leaf width (cm), soil reaction (pH), electrical conductivity (EC, μS/cm), and calcium carbonate (% of CaCO<sub>3</sub>) content were determined. The results were subjected to a one-way ANOVA in the MINITAB 17.0 statistical package program. Differences which were statistically significant according to the results of the variance analysis of the variables/elements were compared with an LSD test.

## Results and Discussion

The fresh weight data obtained from humic acid and cadmium applications to the lettuce plants are given in Table 2. When Table 2 is examined, it can be seen that the highest fresh weight is 74.71 g and the lowest is 25.68 g. Interactions between humic acid and cadmium applications created a statistically significant difference ( $P < 0.05$ ) in the plant fresh weight. The plants' fresh weight increased parallel to the increasing doses of humic acid applications until 12 L da<sup>-1</sup> and then decreased at this dose. The dry weight data obtained from humic acid and cadmium applications to the lettuce plants are given in Table 2. When Table 2 is examined, it can be seen that the highest dry weight is 4.36 g and the lowest is 1.57 g. The highest weight was obtained with the 4 L da<sup>-1</sup> humic acid and 0 mg kg<sup>-1</sup> cadmium application and the lowest weight was obtained with the 4 L da<sup>-1</sup> humic acid and 1.5 mg kg<sup>-1</sup> cadmium application. Interactions between the humic acid and cadmium created a statistically significant difference ( $P < 0.05$ ) in plant dry weight.

**Table 2.** Plant fresh weight and dry weight (g) averages and multiple comparison results

Cadmium Application (mg kg <sup>-1</sup> )	Humic Acid Application (L da <sup>-1</sup> )				Avg.
	0	4	8	12	
<b>Fresh weight</b>					
0	25.68 C	55.54 ABC	67.41 AB	50.25 ABC	49.72
1.5	34.56 ABC	30.29 BC	58.31 ABC	74.71A	49.47
3	43.09 ABC	31.85 BC	65.65 AB	40.32 ABC	45.23
<b>Average</b>	34.45	39.23	63.79	55.09	
<b>Dry weight</b>					
0	1.88 AB	4.36 A	3.59 AB	2.58 AB	3.10
1.5	2.30 AB	1.57 B	3.21 AB	3.07 AB	2.54
3	3.44 AB	1.64 B	3.65 AB	2.90 AB	2.91
<b>Average</b>	2.54	2.52	3.48 AB	2.85 AB	

Mean values marked with the same letter in columns do not differ significantly ( $P < 0.05$ ) from each other.

The leaf length data obtained from humic acid and cadmium applications to the lettuce plants are given in Table 3. When Table 3 is examined, it can be seen that the highest leaf length is 25.00 cm and the lowest is 15.00 cm. The humic acid application created a statistically significant difference ( $P < 0.01$ ) in leaf length. The leaf length increased parallel to the increasing dose of humic acid applications.

**Table 3.** Leaf length and width (cm) averages and multiple comparison results

Cadmium Application (mg kg <sup>-1</sup> )	Humic Acid Application (L da <sup>-1</sup> )				Avg.
	0	4	8	12	
<b>Leaf length</b>					
0	15.00	16.33	20.66	21.66	18.41
1.5	15.66	18.83	23.16	25.00	20.66
3	16.83	17.83	23.50	20.33	19.62
<b>Average</b>	15.83 B <sup>**</sup>	17.66 B <sup>**</sup>	22.44 A <sup>**</sup>	22.33 A <sup>**</sup>	
<b>Leaf width</b>					
0	7.16 C <sup>*</sup>	8.33 BC <sup>*</sup>	9.16 ABC <sup>*</sup>	9.83 ABC <sup>*</sup>	8.62
1.5	7.50 C <sup>*</sup>	8.47 ABC <sup>*</sup>	9.33 ABC <sup>*</sup>	12.22 A <sup>*</sup>	9.38
3	7.66 C <sup>*</sup>	8.00 BC <sup>*</sup>	11.16 AB <sup>*</sup>	8.39 ABC <sup>*</sup>	8.80
<b>Average</b>	7.44	8.26	9.88	10.14	

Mean values marked with the same letter in columns do not differ significantly ( $P < 0.01$  <sup>\*\*</sup>  $P < 0.05$  <sup>\*</sup>) from each other.

The leaf width data obtained from humic acid and cadmium application to the lettuce plants are given in Table 3. When Table 3 is examined, it can be seen that the highest leaf width is 12.22 cm and the lowest is 7.16 cm. The highest width was obtained with the 12 L da<sup>-1</sup> humic acid and 1.5 mg kg<sup>-1</sup> cadmium application and the lowest weight was obtained with the 0 L da<sup>-1</sup> humic acid and 0 mg kg<sup>-1</sup> cadmium application. Interactions between the humic acid and cadmium applications created a statistically significant difference ( $P < 0.05$ ) in leaf width. The soil reaction, electrical conductivity, and calcium carbonate content data obtained from humic acid and cadmium applications to the soil are given in Table 4. When Table 4 is examined, it can be seen that soil reaction varied between 8.69 and 8.93. This change was not statistically significant. When Table 4 is examined, it can be seen that the highest electrical conductivity was 232 EC,  $\mu\text{S}/\text{cm}$  and the lowest was 103 EC,  $\mu\text{S}/\text{cm}$ . The highest electrical conductivity was obtained with the 0 L da<sup>-1</sup> humic acid and 0 mg kg<sup>-1</sup> cadmium application and the lowest electrical conductivity was obtained with the 12 L da<sup>-1</sup> humic acid and 3 mg kg<sup>-1</sup> cadmium application. Humic acid applications and cadmium applications created a statistically significant difference ( $P < 0.05$ ) in electrical conductivity. The soil calcium carbonate content data are given in Table 4. When Table 4 is examined, it can be seen that the highest calcium carbonate content was 1.33 and the lowest was 0.88. Although the highest and lowest data showed a numerical difference, there was no statistical difference.

**Table 4.** Soil reaction, electrical conductivity (EC,  $\mu\text{S}/\text{cm}$ ), calcium carbonate (% of CaCO<sub>3</sub>) content averages and multiple comparison results

Cadmium Application (mg kg <sup>-1</sup> )	Humic Acid Application (L da <sup>-1</sup> )				Avg.
	0	4	8	12	
<b>Soil reaction</b>					
0	8.69	8.84	8.90	8.92	8.84
1.5	8.72	8.73	8.81	8.93	8.80
3	8.82	8.86	8.81	8.85	8.84
<b>Average</b>	8.74	8.81	8.84	8.90	
<b>Electrical conductivity</b>					
0	232	157	155	124	167 A
1.5	143	143	142	127	139 AB
3	139	139	123	103	126 B
<b>Average</b>	171 A	147 AB	140 AB	118 B	
<b>Calcium carbonate</b>					
0	1.30	1.15	1.33	1.18	1.24
1.5	0.90	1.15	1.19	1.30	1.13
3	0.92	1.20	0.88	1.13	1.04
<b>Average</b>	1.04	1.17	1.39	1.21	

Mean values marked with the same letter in columns do not differ significantly ( $P < 0.05$ ) from each other.

### Conclusions

Consequently, according to the experiment, the highest plant fresh weight and leaf length and width were obtained with the 12 L da<sup>-1</sup> humic acid and 1.5 mg kg<sup>-1</sup> cadmium application and the lowest fresh weight and leaf length and width were obtained with the 0 L da<sup>-1</sup> humic acid and 0 mg kg<sup>-1</sup> cadmium application. Applications also affected the plant dry weight. It was reduced by humic acid and cadmium applications. Humic acid and cadmium applications did not cause a difference in soil reaction and calcium carbonate content. According to the results, humic acid and cadmium applications reduced electrical conductivity. Humic acid applications increased the growth of lettuce under cadmium pollution conditions. Plant fresh weight, leaf length and width increased with the 12 L da<sup>-1</sup> humic acid application. It is thought that this situation is related to the uptake of plant nutrients. Humic acid could be used to

promote plant growth under cadmium pollution conditions, but the application doses should be determined by detailed studies.

### **References**

- Allison, L. E., & Moodie, C. D. (1965). Methods of Soil Analysis Part 2. Carbonate. In C. A. Black, et al. (Eds.), *Agronomy* (pp. 1379\_1400). Madison Wisconsin: American Society of Agronomy, Inc.
- Bouyoucos, G. D. 1951. A recalibration of the hydrometer method for making mechanical analysis of soil. *Agron. J.*, 43, 434\_/438.
- Boyle M., Frankenburger W.T., Stolzy L.H. (1989). The influence of organic matter on soil aggregation and water infiltration. *Journal of Production Agriculture*, 2: 290–299.
- Chen, Y. and T. Aviad. (1990). Effects of humic substances on plant growth, pp. 161-186. In: American Society of Agronomy and Soil Science Society of America (eds.), *Humic Substances in Soil and Crop Sciences; Selected Readings*. American Society of Agronomy, Madison, WI.
- Davis A.P. and Bhatnagar V. (1995). Adsorption of cadmium and humic acid onto hematite. *Chemosphere*, Vol. 30, No. 2, pp. 243-256, 1995.
- Eyupoglu F. (1998). Turkey's land vermiculite. Soil-Fertilizer Research Institute, Enst Yay Genel Yayin 220, Ankara.
- Jackson, M. (1958). *Soil Chemical Analysis*. New Jersey, USA: Prentice Hall, Inc.
- Rehber E. and Turhan S. (2002). Prospects and challenges for developing countries in trade and production of organic food and fibers: The case of Turkey. *British Food Journal*, Vol. 104 Issue: 3/4/5, pp.371-390.
- Richards, L. A. (1954). Diagnosis and improvement of saline and alkaline soils. *Handbook 60*, U.S. Dept. of Agriculture.
- Schnitzer M. (1992). Significance of soil organic matter in soil formation, transport processes in soils and in the formation of soil structure. *Soil Utilization and Soil Fertility*. Volume 4, *Humus Budget*, 206, 63–81.
- Varanini, Z. and R. Pinton. (1995). Humic substances and plant nutrition. *Prog. Bot.* 56:97-117.
- Walkey, A. (1947). A critical examination of a rapid method for determining organic carbon in soils: effect of variations in digestion conditions and inorganic soil constituents. *Soil Science*, 63, 251\_/263.
- Yıldırım E. (2007). Foliar and soil fertilization of humic acid affect productivity and quality of tomato. *Acta Agriculturae Scandinavica Section B-Soil and Plant Science*, 2007; 57: 182\_186.

## COMPOSITONS AND FEEDING VALUES OF SILAGE CORN (*Zea mays* L.) VARIETIES GROWN AS THE SECOND CROP

Hakkı AKDENİZ<sup>1\*</sup>, Süleyman TEMEL<sup>1</sup>, Bilal KESKİN<sup>1</sup>, İbrahim HOSAFLIOĞLU<sup>2</sup>

<sup>1</sup>Iğdır University, Agricultural Faculty, Department of Field Crops, Iğdır-TURKEY

<sup>2</sup>Department of Landscape Architecture, Faculty of Agriculture, Iğdır University, Iğdır-TURKEY

\*Corresponding author: hakkı\_akdeniz@hotmail.com

### Abstract

This investigation was carried out to determine the highest CP (Crude protein), NDF (Neutral Detergent Fiber), ADF (Acid Detergent Fiber), ADL (Acid Detergent Lignin), DMD (Dry matter digestibility), DE (Digestible energy), ME (Metabolizable energy), DMI (Dry matter intake), and RFV (Relative feed value) of silage corn varieties grown as the second crop under Iğdır ecological conditions. Ten corn hybrids (72 MAY 80, OSSK644, TK 6063, OSSK 596, TK 6060, HİDO, RX 9292, 71 MAY 69, SHEMALL and OSSK 602) were used. The completely randomized block design was set up with three replications in the experiment areas of the Agricultural Faculty of the Iğdır University in the 2015. According to results of the trial, the crude protein ratio (7.02-8.45%), NDF (40.24-54.16%), ADF (20.03-28.30%), ADL (1.76-2.93%), DMD (69.5-73.3 %), DE (3.13-3.40 Mcal/kg<sup>-1</sup>), ME (2.66-2.79 Mcal/kg<sup>-1</sup>), DMI (2.22-2.99 Mcal/kg<sup>-1</sup>), RFV (115.0-170.0) were ranged. The results showed that crude protein ratios were not statistically significant between corn varieties. It was concluded that TK 6060 corn variety was found to be more nutritious than other corns, as it was suggested NDF, ADF and ADL values are low and DMD, DE, ME, DMI and RFV values are high in terms of animal feeding.

**Keywords:** *Silage corn varieties, Crude protein, Fiber, Lignin, Dry matter digestibility, Digestible and metabolizable energy, Dry matter intake, Relative feed value*

### Introduction

Maize (*Zea mays* L.), which is a warm climate plant, has become the most important grain product with its versatile use in the modern world and it is the most used plant after the wheat and paddy in human nutrition and the majority of production in developing countries is for human consumption and in the developed world it is mainly used for industrial purposes and animal feed (FAO, 1992 and Kırtok Y, 1998). It ranks as the third most important cereal grain in the world and traditional criteria for selecting maize hybrids have been based primarily on agronomic factors, including grain production, disease resistance, drought tolerance (Zilic et al. 2011). The value of a good quality fodder for animal production depends upon the nutrient concentration as well as fodder intake by animals. Long-term research on corn production has emphasized the complex relationship between corn crop growth, grain yield, soil quality and its linkages with soil nutrients, especially nitrogen and phosphorus; soil organisms; and physical characteristics (Lal, 1998). Although many varieties have been cultivated in the region, comprehensive nutritional evaluation of maize cultivars as fodder has not been undertaken on the nutrient content in Iğdır region. Therefore, this investigation was made to determine the nutritive value of some corn plants with particular reference to cultivar differences.

## **Material and methods**

The ten corn cultivars used for this research were chosen on the basis of area with loam and sandy, in texture of the Agricultural Faculty of the Iğdır University in last week of June 2015. The experimental design was a randomized complete block with three replications. The soil lime with % 6.53, soil pH 7.98, soil electrical conductivity with  $1.8 \text{ dS m}^{-1}$ . The plots sizes were  $5 \text{ m} \times 3.5 \text{ m}$ , having a row spacing of 0.70 m and a within-row spacing of 0.20. Before planting, and half of the total nitrogen with 15 kg pure N (ammonium sulphate with 21% N) and all phosphorus with 10 kg  $\text{P}_2\text{O}_5$  were applied for all plots and the rest of nitrogen were applied the plants were reached to 40-50 cm height. The mean temperature from April to September was  $22.8 \text{ }^\circ\text{C}$ , relatively moisture 43.2, mean precipitations 23.8 mm and the lowest precipitation was 4.7 and 5 mm in August month of the 2015 and it seems to be ideal for growing corn in terms of temperature (Anonym, 2015). The corn of plants was harvested at the physiology stage at 25 August 2015. At harvest, 30 randomly selected corn cobs from each plot was stripped of ears by hand and then mixed. From this mixture about 0.500 g sample was subjected to chemical analysis for quality measurements by grinding to pass through a 1 mm screen. For the purpose of traits measurements such as CP, NDF, ADF, ADL, and DDM of corn varieties at each plot, ten corn were selected from each plot and then were ground with screen and analyzed. The total nitrogen was determined according to the method of Micro Kjeldahl in 0.3-0.5 g milled samples and then the nitrogen ratios were multiplied by a coefficient of 6.25 and the crude protein was determined according to Kacar, (1972) and Akyildiz, (1984). For analysis of NDF (Neutral Detergent Fiber), ADF (Acid Detergent Fibre and ADL (Acide Detergent Lignin) samples between 0.950 and 1.050 g were weighed on the sensitive scale together with the Filterbag weight, and analyzed with the ANKOM fiber analyzer using the method developed by Van Soest et al., (1991). DDM (Digestible Dry Matter) rate were determined by Oddy et al., (1983) formula=  $88.9 - (0.779 \times \% \text{ ADF})$ . DE (digestible energy,  $\text{Mcal kg}^{-1}$ ) was calculated using  $0.27 + 0.0428 \times (\% \text{ KMS})$  formulated by Foncesbeck et al., (1984). Metabolic energy ( $\text{Mcal kg}^{-1}$ ) =  $120/(\% \text{ NDF})$  was calculated according to the formula used by Khalil et al., (1986).

**Statistical analysis** The data on various parameters were subjected to statistical analysis using of variance technique and Duncan' multiply range test was applied to compare treatment means by using SPSS (17.0) package statistical program.

## **Results and discussion**

The corn varieties with the highest nutrient content in accordance with the regional conditions were crude protein (CP), Neutral Detergent Fiber (NDF), Acid Detergent Fiber (ADF), Acid Detergent Lignin(ADF) (digestible dry matter (DDM) were presented in Table 1. There were some significant differences between the varieties in terms of all traits examined. However, although the crude protein rate in grain ranged from 7.05% and 8.45% of silage corn plants, significant crude protein differences between hybrids were not found (Fig. 1). Carter et al. (1991) stated that protein is not considered a major factor for corn forage evaluation, due to the low protein concentration of corn compared with legume forages. The findings 6.21-8.65% by Vartanlı and Emekliler (2007) were compatible with this study, on the contrary, were low according to results by Sade et al. (2002), Ayrancı and Sade (2004) and Koca et al. (2006), Koca and Ereklül (2011). Öner (2015) suggested that crude protein rate in corn grain may change depends on locations Leno and Larkins (1991) and Uribelelarre et al. (2004) note that the composition of the grain can vary according to plant species, endosperm

genetic structure and environmental conditions. Julian et al. (2010) reported that the protein and starch concentrations of the grain could be changed depending on genotype or N applications. Because nutritive value of forages is variable, producer encouraged to submit samples to commercial feed test labs for chemical analysis. The ADF content can be used to predict the energy content of forage. While predictions of DMI from NDF are poor, the NDF are poor, the NDF content of forage should be used in diet formulation to ensure adequate fiber (Beauchemin, 1996). NDF, ADL, ADF, and DMD of rations of corn grain were significantly differences between hybrids found in Table 1, Fig 2, 3, 4 and 5. The highest and lowest NDF and ADF rates (54.16 and 40.24%) and (28.60 and 20.03%) was obtained from OSSK 644 and TK 6060 varieties, respectively. However, ADL concentrations of grain corn ranged from 1.76 to 2.93 percent and the highest value was OSSK 602 with 2.93% variety. Teke and Gül (2014) stated that the amount of NDF and ADF in ration or diet is important for some physiologic periods of ruminants in terms of preventing various the metabolic diseases such as acidosis, laminitis and rumen parakeratosis. Although ADF and NDF are good indicators of fiber contents in forages, they do not measure how digestible that fiber is. The reason for the lack of NDF in feeds is metabolic diseases caused by lack of energy due to the change in the rumen fermentation (Calsmiglia et al., 2008), so it is not desirable that the daily consumption of animals is 45.8% for the NDF content, 25% for the ADF content and 10% (NRC, 2001). DMD (%) of corn varieties were significantly significant and ranged from 66.8 % with OSSK 644 and 73.3% with TK 6060 varieties, respectively.

Digestible energy, Mcal kg<sup>-1</sup> (DE), metabolic energy Mcal kg<sup>-1</sup> (ME), dry matter intake (DMI %), Relative feed value (RFV) are given in Table 1, Fig.6, 7, 8, and 9. Although the energy values are very close to each other, there is a statistical difference between the varieties with small differences. The highest DE, Mcal kg<sup>-1</sup> value were obtained from TK 6060 and the lowest value was obtained from OSSK 644 with 3.13 value. Similarly, the highest values of ME, DMI and RFV values of hybrid maize varieties were 2.79 Mcal kg<sup>-1</sup>, 2.99% and 170.0, respectively, and the lowest values were 2.57 Mcal kg<sup>-1</sup>, 2.22 % and 115.0%, respectively. Although the energy values are very close to each other, there is a statistical difference between the varieties with small differences. The highest value was obtained from TK 6060 and the lowest value was obtained from OSSK 644 with a value of 3.13. Consequently, extensive variation was not observed indigestibility of energy DE, ME and DMI of corn hybrids and the less variation is explained by indifferences in these ingredients of grain of hybrids of commercial corn. These findings were not similar to previously described by Denek and Deniz (2004), stated that the organic matter digestibility of corn were 83.90%, Digestible energy 15.94 MJ/kg DM, metabolizable energy 8.41 MJ/kg DM, net energy 8.41 MJ/kg DM for content of grains. Differences were detected for quality, and were similar to previously described characteristics of the hybrids. This confirms earlier findings of hybrid differences for digestibility (Vattikonda and Hunter, 1983). Noblet and Perez (1993) reported that the DE and ME values increased with the concentration CP and EE and decreased with the concentrations of minerals, crude fiber, NDF, or hemicellulose. However, it is important to recognize that corn varieties has a higher concentration of crude protein, crude fat, and crude fiber than any of these alternative sources, which makes it the most valuable feed ingredient derived from ethanol production. Corn is a primary source of energy in dairy industry, and its nutritive value is related to digestibility (Carter et al., 1991). Forages with higher ADF are lower in digestible energy than forage with lower ADF, that means, as the ADF level increase, digestible energy levels decrease. In conclusion that TK 6060 corn variety had the lowest the ADF 20.03% among the varieties and therefore values of DM 3.40 Mcal kg<sup>-1</sup>, ME 2.79 Mcal kg<sup>-1</sup>, DMI 2.99 % and RFV with 170.0 was the highest in present trial. However, Deinum and Bakker (1981) found digestibility differences among corn hybrids and concluded that yield and quality should be taken in consideration when selecting hybrids for forage. Zilic

et al. (2011) nutritive and technological value of grains is of great interest for the use of corn in the diet. The highest nutritive value was recorded in sweet maize hybrids from ZemunPolje (ZP) and had the highest content of total protein, albumin, tryptophan, sugars and dietary fibres. According to Sosulski and Cadden (1984), lignin is the most chemically active component for the cell wall, being responsible for interactions with other dietary components. Generally, in this trial, the gain RFV was negatively correlated to the NDF content ( $r^2=-0.9875$ ,  $p<0.05$ ), the ADF content ( $r^2=-0.851$ ,  $p<0.05$ ), respectively.

Table 1. Properties of silage corn varieties

Corn variety	Silage corn properties*								
	Percent in dry matter						Mcal kg <sup>-1</sup>		RFV
	CP	NDF	ADF	ADL	DMD	DMI	DE	ME	
72 MAY 80	7.52	52.31 ab	24.73 bc	1.88 c	69.6 bc	2.30 bc	3.25 b	2.67 bc	124.1 bc
OSSK 644	7.48	54.16 a	28.30 a	1.76 c	66.8 d	2.22 c	3.13 c	2.57 c	115.0 c
TK 6063	7.23	49.78 ab	21.91 bcd	1.99 c	71.8 abc	2.41 bc	3.34 ab	2.74 abc	134.7 b
OSSK 596	7.63	49.04 ab	21.32 cd	1.81 c	72.3 ab	2.44 bc	3.36 a	2.76 ab	137.2 b
TK 6060	7.56	40.24 c	20.03 d	1.82 c	73.3 a	2.99 a	3.40 a	2.79 a	170.0 a
HIDO	8.07	52.00 ab	24.81 bc	2.59 ab	69.6 bc	2.31 bc	3.24 b	2.67 bc	124.5 bc
RX 9292	7.43	50.68 ab	25.29 ab	2.56 ab	69.2 cd	2.37 bc	3.23 b	2.65 bc	127.2 bc
71 MAY 69	7.02	47.94 b	22.28 bcd	2.23 bc	71.5 abc	2.51 b	3.33 ab	2.73 abc	139.4 b
SHEMALL	7.32	52.30 ab	24.95 b	2.04 c	69.5 c	2.30 bc	3.24 b	2.66 c	123.8 bc
OSSK 602	8.45	48.41 b	23.46 bcd	2.93 a	70.6 abc	2.48 bc	3.29 ab	2.70 abc	135.8 b

\* CP (Crude protein), NDF (Neutral Detergent Fiber), ADF (Acid Detergent Fiber), ADL (Acid Detergent Lignin), DMD (Dry matter digestibility), DE (Digestible energy), ME (Metabolizable energy), DMI (Dry matter intake), RFV (Relative feed value)

\*Values indicated the different letters are significantly different at  $P<0.05$ .



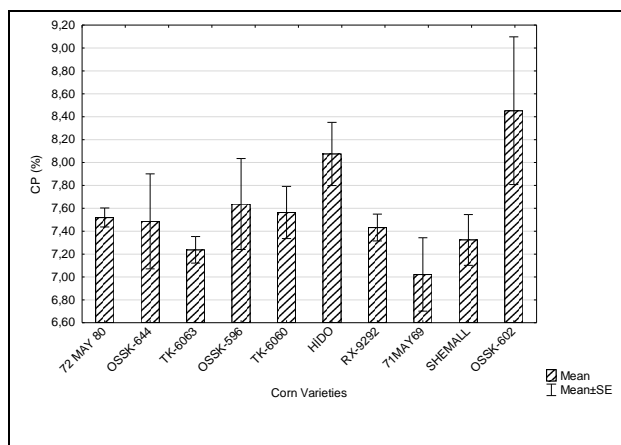


Figure 1. Crude protein of corn hybrids variations

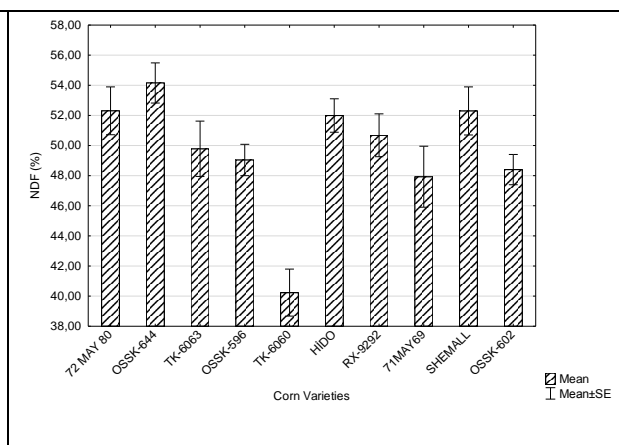


Figure 2. NDF rates of corn hybrids variations.

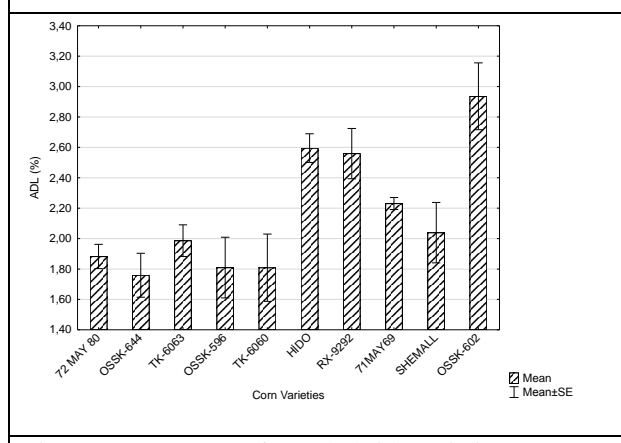


Figure 3. ADL rates of corn hybrids variations.

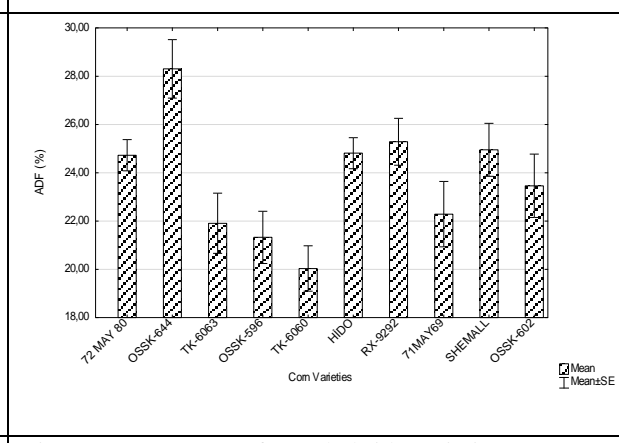


Figure 4. ADF rates of corn hybrids variations.

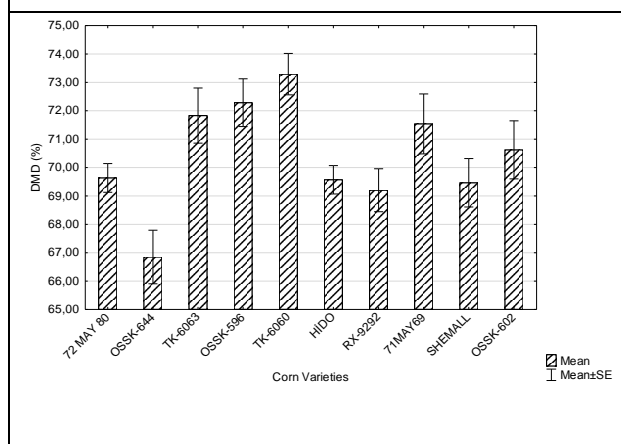


Figure 5. DMD rates of corn hybrids variations

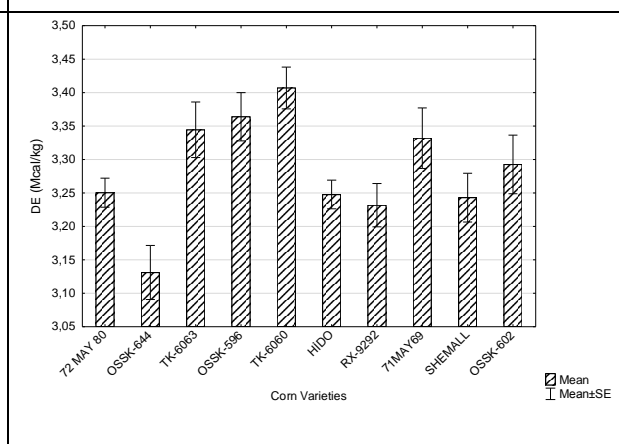


Figure 6. DE of corn hybrids variations.

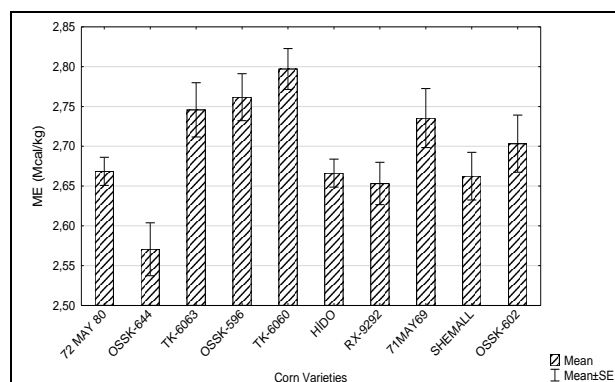


Figure 7. ME rates of corn hybrids variations

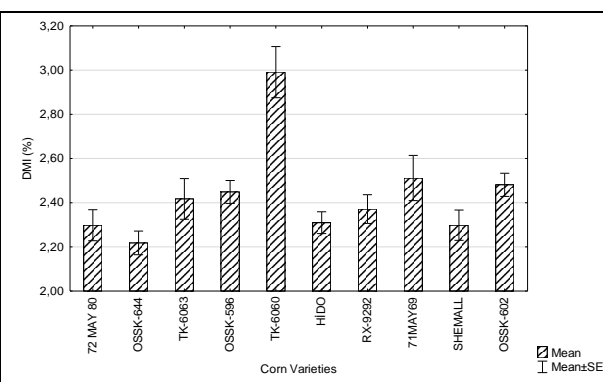


Figure 8. DMI rates of corn hybrids variations.

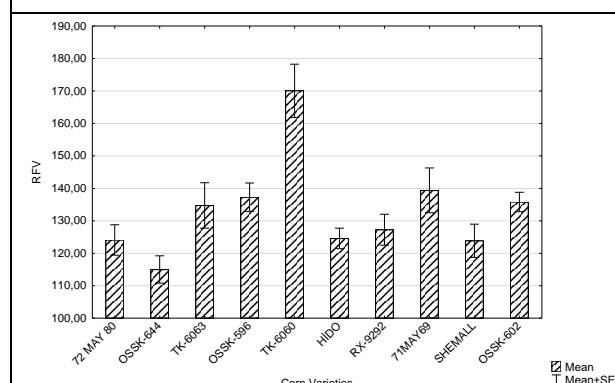


Figure 9. RFV rates of corn hybrids variations.

## Conclusion

From the results obtained, it can be concluded that TK6060 corn variety had the highest nutritious among the hybrid corns, as it was suggested NDF, ADF and ADL values are low and DMD, DE, ME, DMI and RFV values are high. Moreover, as a means of results of varieties, there were a negative and significant relationship between NDF and ADF with RFV values,  $r^2=-0.9875$  and  $r^2=-0.851$ , respectively. However, to make a final decision, it is concluded that the evaluation of varieties differences among corn hybrids and concluded that yield and quality should be taken in consideration when selecting hybrids for forage.

## References

- Akyıldız, AR, 1984: Yemler Bilgisi ve Laboratuvar Kılavuzu. Ankara Üniversitesi Ziraat Fakültesi Yayınları. Yayın No: 895, Uygulama Kitabı No: 213, 236 s, Ankara.
- Anonim, 2015. Iğdırın Coğrafi Özellikleri Iğdır'ın İklimi ve Bitki Örtüsü, <http://www.turksitesi.net/cografyasi-bitki-ortusu/igdirin-cografya-ozellikleri.html> (16.03.2016).
- Calsamiglia S., Cardozo PW, Ferret A, Bach A. 2008. Changes in rumen microbial fermentation are due to ac combined effect of type of diet and ph. J. Anim. Sci., 86,702-711.
- Carter, P.R., Coors, J.G., Undersander, D.J., Albrecht, K.A., and R.D. Shaver. 1991. Corn hybrids for silage: an update. p. 141–164. In Proc. of Annual Corn & Sorghum

- Research Conference, 46th Chicago, IL.American Seed Trade Association, Washington D.C.
- Denek N, Deniz S 2004. Ruminant Beslenmesinde Kullanılan Bazı Dane Yemlerin Enerji Düzeylerinin İn Vivo ve İn Vitro Metotlarla Belirlenmesi. *Turk J Vet Anim Sci.*185-193.
- FAO, 1992.Maize in human nutrition. Report series 25. Food and Agricultural Organization, Rome, Italy.
- Fonnesbeck PV, Clark DH, Garret WN, Speth CF, 1984.Predicting energy utilization from alfalfa hay from the Western Region.*Proc. Am. Animal Science, (Western Section)* 35: 305-308.
- Juliann R. Seebauer, George W. Singletary, Paulette M. Krumpelman, Matías L. Ruffo, and Frederick E. Below. 2010. Relationship of source and sink in determining kernel composition of maize. *J Exp Bot. Jan;* 61(2): 511–519.
- Kacar B, 1972. Bitki ve Toprağın Kimyasal Analizleri: II. Bitki Analizleri. Ankara Üniversitesi Ziraat Fakültesi Yayını. Yayın No:453, 464 s, Ankara.
- Khalil JK, Sawaya WN, Hyder SZ, 1986. Nutrient composition of Atriplex leaves grown in Saudi Arabia. *J. Range Manage.* 39: 104-107.
- Kırtok Y, 1998. Mısır Üretimi ve Kullanımı. Kocaelik BasımveYay., 1998, İstanbul.
- Koca Y, Ereku O. 2011. Bazı melez mısır çeşitlerinin performanslarının belirlenmesi. *ADÜ Ziraat Fakültesi Dergisi* 2011; 8(2) : 41 – 45.
- Lal, R., 1998. Soil erosion impact on agronomic productivity and environment quality. *Crit. Rev. Plant Sci.* 17, 319–464.
- Lopes MA, Larkins BA. 1991. Gamma-zein content is related to endosperm modification in quality protein maize. *Crop Science.*;31:1655–1662.
- NRC 2001. Nutrient Requirements of Small Ruminants: Sheep, Goats, Cervids, and New World Camelids. National Research Council of the National Academies, Washington DC.
- Oddy VH, Robards GE, Low SG, 1983. Prediction of in vivo dry matter digestibility from the fiber nitrogen content of a feed. In: Robards, G.E., Packham, R.G. (Eds.), *Feed Information and Animal Production*. Commonwealth Agricultural Bureaux, Farnham Royal, UK, pp. 395-398.
- SPSS Inc., 1991. *Statistical Package For The Social Sciences (SPSS/PC+)*. Chicago, IL.
- Tekce E, Gül M. 2014. Ruminant beslemede NDF veADF'nin önemi. *Atatürk Üniversitesi, Vet. Bil.Derg.* 9 (1): 63-73.
- UribeArrea M, Carcova J, Otegui ME, Westgate ME.2002. Pollen production, pollination dynamics, and kernel set in maize. *Crop Scienc*, 42:1910–1918.
- Van Soest PJ, Robertson JD, Lewis BA, 1991. Methods for dietaryfiber, neutral detergent fibre and non-starch polysaccharides in relation to animals nutrition. *Journal of Dairy Science*, 74: 3583-3597.
- Zilic S, Milasinovic, M Terzic D, Barac M, and Ignjatovic-Micic D. 2011. Grain characteristics and composition of maize.specialty hybrids. *Spanish Journal of Agricultural Research*, 9 (1), 230-241.

## THE YIELD AND SOME NUTRITIONAL COMPONENTS OF FOUR HAIRY VETCH (*VICIA VILLOSA* ROTH L.) VARIETIES

Ali KOÇ<sup>1</sup>, Hakkı AKDENİZ<sup>2\*</sup>

<sup>1</sup>General Directorate of Agricultural Affairs, AR-GE, Ankara, Turkey

<sup>2</sup>Iğdır University, Agricultural Faculty, Department of Field Crops, Iğdır, Turkey

\*Corresponding author: hakkı\_akdeniz@hotmail.com

### Abstract

The goal of this investigation was to assess yield, agricultural and nutritional components of four winter hairy vetch varieties (Aday (Ceylan), Efes-79, Menemen-79 and Selçuklu-2002) at Agricultural Station of Hatay province and Ceylanpınar district of Turkey, in 2012. The experiment was arranged as completely randomized block design with four replications. Experiment results indicated that all traits of hairy vetch varieties were highly significant, except for winter hardiness and plant height in Ceylanpınar, and winter resistance and main stem height in Hatay location. Aday (Ceylan) with hairy vetch had the highest green herbage and dry matter yield in both agricultural stations of Hatay and Ceylanpınar. Furthermore, it was concluded that Aday seemed to be the most suitable from agricultural point of view, erect growing, high-yielding and winter-hardness, as well as a promising variety regarding nutrient content for animal nutrition.

**Keywords:** *Hairy vetch, varieties, yield, nutritional values.*

### Introduction

Herbage and seeds of the vetch plant are high in protein, vitamins, minerals, and because they are delicious, they are used as animal feeds for agriculture, hay, silage and grain (Erdurmuş et al. (2010). The plant is enriched with nitrogen and organic matter. For this reason, the vetch under the fruit gardens is plowed during the flowering period and buried in the soil, contributing to the maintenance of soil fertility (Açıkgöz 2001). One of the most important way to increase the feed crop areas in order to provide quality feed to animals in Turkey and reduce extreme animal oppression on the grassland is to spread the cultivation of winter and summer second crops.

Vetch (*Vicia sativa* L.) is an annual leguminous plant that is grown in plant-animal production systems for agriculture and horticulture, green fertilization and grain production in many parts of the world and is widely used in ruminant feeding (Cabellero et al., 2001; Chowdhury et al., 2001). In addition, vetch is versatile in terms of its potential end use, producing hay/silage, grain, pasture or green manure (Matic et al., 2005; Jong et al., 2013). In recent years, many varieties have been developed in forage plants of vetches. However, the varieties developed up to this day were mostly developed taking into account the plant yield in the unit. However, it is known that herbaceous quality is very important in addition to yielding while growing varieties. In breeding studies to be carried out with feed plants, the development of varieties with high herb yield as well as high herbaceous quality and presentation of them to the service of the producer comes from the most important tissues. One of the most important problems encountered in vetch farming is the need for a company plant that will not grow up vertically due to the gentle and thin stem form.

Ünal et al. (2016) recommended that common vetch (*Vicia sativa* L.) is a spring crop and extensively grown in semiarid areas of Turkey. Its yield potential is strictly limited by short

growing season. For this purpose, this study was carried out to compare some agricultural characteristics, mainly yield Aday (Ceylan) widely used such as Menemen-79, Selçuk-2002 and Efes-79 varieties of in Ceylanpınar and Hatay locations, two different locations were used.

### **Material and method**

In the previous studies, Aday (Ceylan) compared to Menemen-79, Selçuk-2002 and Efes-79 varieties were used as standard varieties selected for the present study on dry matter production and herbage quality, which are hopeful in terms of herbage yield in both Ceylanpınar and Hatay conditions in 2011-2012. Flowers of vetches Aday (Ceylan) compared to Menemen-79, Selçuk-2002 and Efes-79 varieties were Rhs Colour Chart 81/a, Rhs Colour Chart 71/a, Rhs Colour Chart 80/a, and Rhs Colour Chart 71/a. The result of analysis of the soil sample taken at 0-30 cm depth in the experimental area in Hatay and Ceylanpınar; is as follows: soluble salts ( $EC=0.38$  and  $0.69$   $ds\ m^{-1}$ ), high  $CaCO_3$  (22.37% and 25.4%), organic matter (0.84% and 2.26%), and a pH value of 7.82 and 7.81 respectively. Available phosphorus ( $P_2O_5$ ) in Hatay and Ceylanpınar were 83.5 and 4.2 ( $kg/ha^{-1}$ ); potassium ( $K_2O$ ) 1381.3 and 1125.0 ( $kg/ha^{-1}$ ), respectively. The main air temperature of Hatay and Ceylanpınar was 13.7 °C and 10.9 °C, total precipitation was 705.8 mm and 179.5 mm; the humidity were 71% and 62.2%, respectively. The precipitation of January, February and March in the Hatay location were higher than in the other agricultural experiment (Anonymous 2015). The plot area was arranged as  $5 \times 1.5 = 7.5$   $m^2$ . Each plot was manually planted in 6 rows with 25 cm spacing, with 100  $kg\ ha^{-1}$  seeds. Before planting, 50  $kg\ N\ ha^{-1}$  and 100  $kg\ P_2O_5\ ha^{-1}$  were used as fertilizer. The study was carried out with 4 replications according to randomized blocks trial design. The material in the study was planted on 02 November 2011 and harvesting was from 26 April to 5 May 2007. After drying and weighing 500 g vetch samples taken from each parcel, all were prepared by grinding with a mill having a diameter of 1-2 mm. The nitrogen (N) content was determined using the Kjeldahl method. The crude protein (HP) was determined by the  $N \times 6.25$  formula (AOAC, 1995). Neutral detergent fiber (NDF) and acid detergent fiber (ADF) contents, which constitute the cell wall components of the feed, were obtained from Van Soest et al. (1991), using ANKOM 200 Fiber Analyzer (ANKOM Technology Corp). The number of days of flowering of vetch lines (day), main stem height (cm), main stem thickness (mm) and number of main stem (number), age and hay yield ( $kg\ da^{-1}$ ), physiological maturation ( $kg\ da^{-1}$ ), grain yield ( $kg\ da^{-1}$ ), 1000 grain weight (g) and harvest index (%), number of beans per day (number) have been studied in the present study.

#### **Experimental Design and Statistical Analysis**

The experimental design for the field experiment was a randomized completely block with four replications. Analysis of variance was used to analyze the data using PROC GLM (general linear models) procedure of the Statistical Analysis System (SAS Institute, 2002). Means were compared with LSD.

### **Results and discussion**

**The Number of flowering days:** Significant statistical differences were found in the combined average of both vetches and locations between the common vetch line and varieties in terms of flowering days number. Flowering times ranged 161.0-168.5 days in Ceylanpınar, 160.0-169.0 days in Hatay, and 151.0-168.0 days in the two location average. Aday (Ceylan) was found to be the earliest, while the Menemen-79 type was the latest both by locations and by the averages (Table 1, 2 and 3). These findings of flowering days number were much higher than results of flowering days with 144.2 days concluded by Çakmakçı et al. 1999); it

has been reported that it changed between 162.3-172.3 days (Albayrak et al., 2005) in Samsun conditions and between 132.3-164.3 days (Yücel et al., 2007; Yücel et al., 2008) in Adana conditions, and 194-198 day (Sayar ve ark., 2009) and Erdurmuş et al. (2010) between 126.4-133.5 days.

**Main stem height(cm):**The main stem heights of the varieties were not statistically important in the province of Hatay, but they were important in both in Ceylanpınar and as means of locations emerged as the highest type of Aday (Ceylan) with 101.4 cm main stem height. In studies conducted with different genotypes in different ecologies, the main stem height was 94.7-100.8 cm (Albayrak et al., 2005) in Samsun conditions were nearly similar to results of this present study and 97.8-136.3 cm in Adana conditions (Yücel et al., 2008) were higher and Erdurmuş et al. (2010) pointed out that main stem height with 58.4-81.1 cm were lower. However, Al-Doss A. A., (1996) stated that lines of vetch were highly significant for all traits, while the year effect was significant for days to flowering and highly significant for biological yield and harvest index. Year  $\times$  line interaction was also highly significant for all studied characters in both seasons except for plant height.

**Main Stem Thickness (mm):** Main stem thickness of vetch had statistically significant differences between both vetches and location. The main stem ranged 2.0-2.39 mm in Ceylanpınar, 2.33-2.79 mm in Hatay, and 1.66-2.0 mm in two location average. Aday (Ceylan) had the maximum main stem thickness (2.0 mm) in as a means of two location and Efes-79 vetch of lowest main stem thickness (1.66 mm) are presented in (Table 1, 2 and 3). Erdurmuş et al. (2010) found that main stem thickness, 2.98-4.29 mm. on different species was higher than our test results.

**Natural Plant Height (cm):** Although there were some slight differences between locations in terms of main stem height, it is not statistically significant between of vetch varieties. Sayar et al. (2009) pointed out that natural plant height was 27.0-44.3 cm, main stem thickness 1.53-2.26 mm and green herbage and dry matter yield were 668-2119 kg da<sup>-1</sup> and 211-584 kg da<sup>-1</sup> respectively, in Çukurova Agricultural Research Institute, Adana, Turkey.

**Number of Main Stem:** As are presented in Table 2, 3 and 4, significant statistical differences were found in the mean of both varieties and as means of locations in terms of main stems number. In addition, the vetch variety  $\times$  location of interaction was also found to be statistically significant. The highest number of main stems was found to be 3.3 in Ceylanpınar and 3.0 in Hatay province. In the two-year combined average, Menemen-79 with 1.8 had the highest number of main stem.

**Lodging:** In general, common vetches have a long, thin, easily lodging stem, therefore, it is of great importance for agricultural development to be upright without company plants. Although the vetch varieties differed according to the scale 1-5 and according to the locations in terms of lodging there was a clearer average. According to the average, Aday (Ceylan) had 2 values according to the average are promising in terms of agricultural development. Vetches are usually grown up without friends planting and always prone to lie down and the new breeding Aday (Ceylan) variety is very important in this respect.

**Winter Hardness:** Winter resistance of all vetch varieties ranged from 2 to 3 in Ceylanpınar, 2 to 4 in Hatay and there was no difference between the varieties despite different climatic conditions. Abd El-Moneim, (1993) stated that there was considerable variation among entries with the same species, entries of *V. ervilia* were the earliest in flowering and maturity, and *V. villosa* ssp. *dasycarpa* almost the latest by 45 days. *V. sativa*, was the most affected by frost whilst both *V. villosa* ssp. *dasycarpa* and *V. ervilia* proved to be winter hardy.

**Herbage Yields of Vetches:** The yields of particular forages varied with seasonal conditions, soil type, drainage and location. Vetch varieties in terms of herbage yields had significant differences that were statistically found in both location and varieties. The herbage yields of varieties examined in the study varied between 2543.3-2866.6 kg da<sup>-1</sup> in Hatay province,

1138.21354.9 kg da<sup>-1</sup> in Ceylanpınar district and 1938.3-2084.9 kg da<sup>-1</sup> in the combined average of the lo (Table 1, 3 and 3). The results of green herbage yields with (3686.3-5232.9 kg da<sup>-1</sup>) obtained by Mutlu Z. (2002) that were higher than yields of this present study. Hakyemez (2006) cited that no significant differences between winter dates in seed and seed protein yield and suggested common vetch should be sown during the winter period for seed and forage production. As are presented in Table 1, 2 and 3, the highest dry matter yields were from Aday (Ceylan) variety and others followed this vetch in both Hatay and Ceylanpınar locations. However, dry matter yields ranged from 553.4 and 638.5 kg da<sup>-1</sup> in Hatay, 323.4 kg da<sup>-1</sup> and 412.3 kg da<sup>-1</sup> in Ceylanpınar location. Yields of vetches in Hatay province were much 1.5 times more than the yields of Ceylanpınar. Depending on the genetic structure of the materials used and ecological factors and compound effects, different yields were obtained in different regions. Karadağ and Büyükburç (2001) green herbage yields of vetches were 2936.6-3965.2 kg da<sup>-1</sup>; dried herbage yields were 354.2-536.5 kg da<sup>-1</sup>. Yücel et al. (2007), dry matter yield in Adana base conditions is 576-801 kg da<sup>-1</sup>, 407-709 kg da<sup>-1</sup> in Çukurova base conditions. Numerous researchers reported that interactions of year x variety are important in common vetch, due to green weed yield, hay yield, flowering time and biological yield and harvest index (Yücel et al., 2006; 2008).

Table 1. Yield and Yield Components of vetches grown in Hatay Province

Cultivar name	Days to flowering	Plant height (cm)	Main stem thickness(mm)	Natural Plant height (cm)	Number of main stem	Logging (1-5)	Winter Hardnes (%)	Green forage yield (kg da <sup>-1</sup> )	Dry matter yield (kg da <sup>-1</sup> )
Aday (Ceylan)	160 d	123.5 a	2.79 a	60.4 a	3.0 a	2	90	2846.6 a	638.5 a
Efes-79	167 b	121.2 a	2.34 b	50.4	2.8 b	4	90	2866.6 a	598.2 b
Menemen-79	169 a	127.5 a	2.33 b	53.2 b	2.6 b	4	90	2643.3 b	560.0 c
Selçuk-2002	165 c	117.9 a	2.35 b	49.2	2.8 b	4	90	2549.9 b	553.4 c
CV, %	0.6	7.6	2.8	5.6	7.3			3.7	3.8
LSD	1.08	12.98	0.1	5.47	0.3			140.0	31
F	**	ns	**	**	**		ns	**	**
Means	165.3	122.5	2.45	53.3	3		90	2726.6	578.5

<sup>abc</sup> Means within a column with different superscript are very significant (P<0.05).

Table 2 . Yield and Yield Components of vetches grown in Ceylanpinar

Cultivar name	Days to flowering	Plant height (cm)	Main stem thickness(mm)	Natural Plant height (cm)	Number of main stem	Loging (1-5)	Winter Hardnes (%)	Green forage yield (kg da <sup>-1</sup> )	Dry matter yield (kg da <sup>-1</sup> )
Aday (Ceylan)	151	79.2 a	2.00 a	55.5 a	2.8 a	2	92 a	1323.3 a	412.3 a
Efes-79	165	56.0 b	1.66 c	50.6 a	2.4 ab	3	88 b	1138.2 c	323.4 c
Menemen-79	168	64.3 b	1.74 b	49.2 a	1.8 b	3	92 a	1233.3 b	350.8 bc
Selçuk-2002	157	59.7 b	1.78 b	52.7 a	2.2 ab	3	88 b	1354.9 a	387.0 ab
CV,%		7.6	2.8	5.6	7.3		3	6.6	8.2
LSD		12.6	3	9.2	21.3		3.81	115.5	41.9
F		**	**	6.6	0.67		ns	**	3.81
Means	160.2	64	1.79	52	2.3		89.5	1262.4	368.4

<sup>abc</sup> Means within a column with different superscript are very significant (P≤0.05).

Table 3. Yield and Yield Components of vetches grown in Ceylanpinar and Hatay

Cultivar name	Days to flowering	Plant height (cm)	Main stem thickness(mm)	Natural Plant height (cm)	Number of main stem	Loging (1-5)	Winter Hardnes (%)	Green forage yield (kg da <sup>-1</sup> )	Dry matter yield (kg da <sup>-1</sup> )
Aday (Ceylan)	155.5 d	101.4 a	2.39 a	57.90 a	2.9 a	2	92 a	2084.9 a	525.4 a
Efes-79	166.0 b	88.64 b	2.0 c	50.52 b	2.6 b	3	88 b	2002.4 ab	460.8 b
Menemen-79	168.5 a	94.4 ab	2.04 bc	53.20 b	2.6 b	3	89 ab	19383 b	455.4 b
Selçuk-2002	161.0 c	88.84 b	2.06 b	49.2	2.8 b	3	89 ab	1952.4 b	470.2 b
CV, %	0.4	9.4	3.1	8.4	14.3		3	4.7	5.6
LSD	0.63	8	0.059	4.05	0.35		3.81	85.9	24.5
F	**	**	**	**	**	ns	ns	**	**
Means	162.8	93.3	2.12	52.7	2.7				

<sup>abc</sup> Means within a column with different superscript are very significant (P≤0.05).

**Nutritive Value of Vetch Hay:** In the study, water content of vetch herbage ranged from 7.9 to 10.2%, dry matter of herbage ranged from 89.8 to 92.1%. The crude ash ranged from 9.76% to 13.04% with Aday (Ceylan) and Selçuk-2002 varieties, respectively (Fig 1). As seen in Table 4, there were statistically significant differences between varieties in crude protein ratios (CP, %) in the means of locations. CP ratios were found to be the highest CP ratios in Aday (Ceylan) and Efes-79 with 21.33% and 21.26 % and the lowest ratio of crude protein (14.89%) with Selcuk-2002 vetch variety in Table 4 and Figure 2. This difference in protein between genotypes may be related to the rate of leaf stalk and genotypes development status. Studies conducted in different genotypes and different ecologies have been reported by many researchers whose crude protein ratios vary between 9.08-22.30% (Karlı et al., 2005; Yolcu et al., 2009; Yücel and Ayaşan, 2010). On the other hand, crude oil ranged from 1.41 to



1.66%, the highest crude oil (CO) had 1.41% with Menemen-79 variety in Table 4 and Figure 3. However, there were statistically significant differences between the varieties in terms of neutral detergent fiber (NDF), ranged from 45.67 to 511.55 % as a means of locations. In similarly, ADF contents ranged from 37.42 to 45.53% of vetch varieties, the highest NDF and ADF content had Efes-79 with 51.55% and 45.53% between varieties. In Table 4 and Figure 5 and 6. ADL content of vetch was 7.27-8.39%. Common vetch may be harvested at different stages depending on the quality of the forage required. As the plant matures, dry matter digestibility (DMD), leaf matter and crude protein (CP) decrease, and neutral detergent fibre (NDF) and acid detergent fibre (ADF) increase. NDF values reported by many researchers vary between 34.97-66.7% (Karslı et al., 2005; Ammar et al., 2010; Parlak et al. 2011). Temel et al. (2015) cited that for hay yield ranged from 213.35 to 547.88 kg da<sup>-1</sup>, from 15.15 to 20.69% for CP, from 40.63 to 47.27% for NDF, from 28.94 to 35.71% for ADF, from 4.39 to 7.06% for ADL, from 61.08 to 66.35% for DMD.

It is known that ADF values vary between 18.6% and 41.8% in studies performed with different genotypes and different ecologies (Badrzadeh et al., 2008; 2010; Parlak et al., 2011). Ammar et al. (2010) reported that NDF and ADF values increased in parallel with the period of ripening in the vetch, and the quality decreased. Desalegn and Hassen (2015) highest crude protein (CP), acid detergent fiber (ADF) and acid detergent lignin (ADL) contents were recorded in *Vicia dasycarpa*, 18.9% DM, 37.3 %DM and 10.76% DM respectively. A strong positive correlation was found between NDF and ADF ( $r=0.977^{**}$ ). In addition, there were positive and significant relations between NDF and ADL ( $r=0.711^{**}$ ); ADL and CP ( $r=0.578^*$ ). Furthermore, there was a negative and significant relationship between crude cellulose and water, dry matter, crude ash. However, relationship between crude cellulose and crude protein was negative and very significant ( $r=-0.694^{**}$ ). These findings appear to be among the values mentioned in the studies. Many factors such as ripening period, vegetation type, harvesting and storage, climate and soil conditions and variety of feed crops in feed crops. However, Georgieva et al. (2015) stated that it could be concluded that vetch breeders should consider traits such as seed weight per plant, pod height, 1000 seed weight and seeds per plant when selecting high-yielding genotypes for seed yield. In addition, Lauk et al. (2007) suggested that legume-cereal mixes are particularly suited for the conditions of organic farming as they ensure a relatively good harvest and a high protein yield. Marley et al. (2017) indicated that common vetch has the potential to be used as a source of high-protein fresh forage in spring to support lactating ewes and their lambs. Lithourgidis et al. (2006) concluded that highest forage quality was achieved when common vetch was grown as a monoculture or when at a high proportion in mixtures, especially with oat.

Table 4. The nutrition of four vetch grown in as a means of location, Hatay and Ceylanpınar

Variety	W	DM	CA	CO	CP	CS	ADF	NDF	ADL
Aday (Ceylan)	9.9 a	90.0 c	9.76 c	1.57 b	21.3 a	17.62 b	37.42 c	44.89 d	7.79 b
Efes-79	10.2 a	89.8 c	11.60 b	1.42 c	21.3 a	22.30 a	45.53 a	51.55 a	8.39 a
Menemen-79	9.4 b	90.6 b	12.46 a	1.66 a	15.4 b	23.40 a	44.32 b	49.14 b	7.90 b
Selçuk-2002	7.9 c	92.1 a	13.04 a	1.41 c	14.9 c	23.65 a	38.33 c	45.67 c	7.27 c
Means	9.4	90.6	11.7	1.51	18.25	21.77	41.38	47.79	7.82

<sup>abc</sup> Means within a column with different superscript are very significant ( $P \leq 0.05$ ).

Table 5. Correlation coefficients between chemical nutrition of grown four vetches

Traits	W	DM	CA	CP	CO	CS	ADF	NDF
Water, (W)	1							
Dry matter, (DM)	-1.00**	1						
Crude ash, (CA)	-.019	.019	1					
Crude protein, (CP)	.814**	-.814**	-.294	1				
Crude oil, (CO)	.341	-.341	.286	-.100	1			
Crude cellulose, (CS)	-.513*	.513*	.555*	-.694**	-.247	1		
ADF	.438	-.438	.223	.036	.112	.448	1	
NDF	.470	-.470	.127	.159	-.045	.399	.977**	1
ADL	.776**	-.776**	-.178	.578*	.207	-.208	.666**	.711**

\* \*\* Significant at (P < 0.05) and (P < 0.01) respectively.

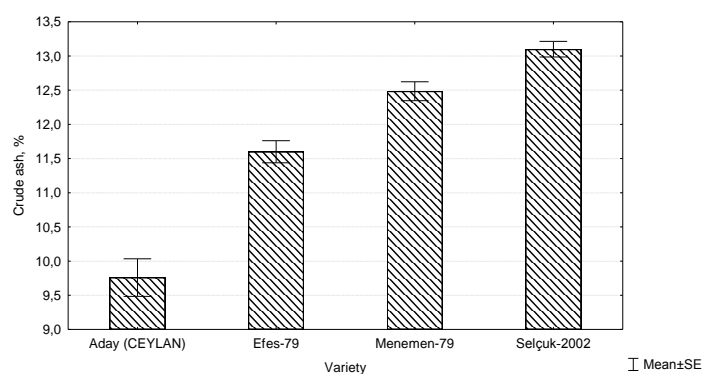


Figure 1. Crude ash content percent of vetch varieties

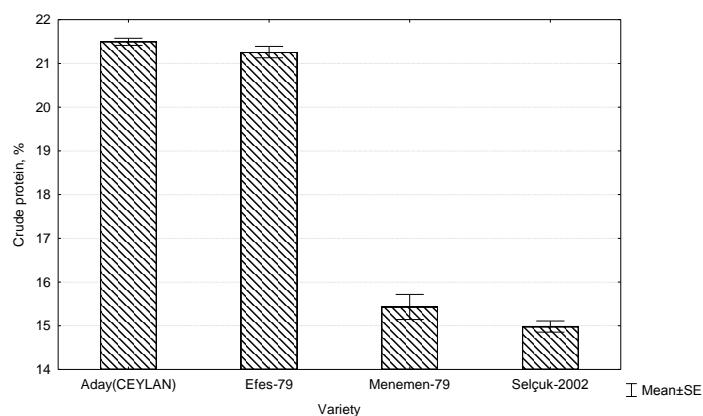


Figure 2. Crude protein percent of four vetch varieties

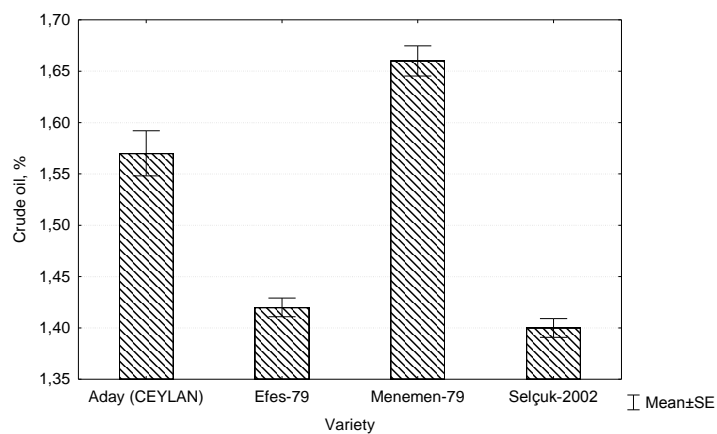


Figure 3. Crude oil percent of four vetch varieties

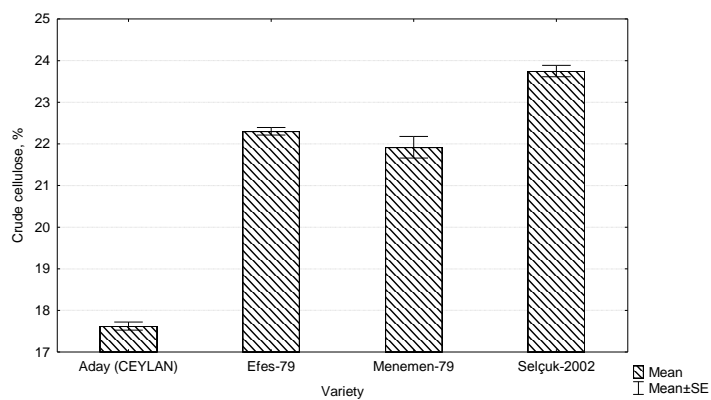


Figure 4. Crude cellulose percent of four vetch varieties

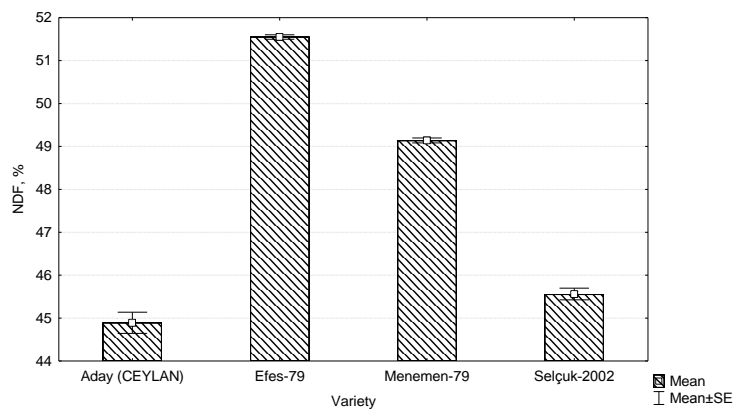


Figure 5. NDF contents of four vetch varieties

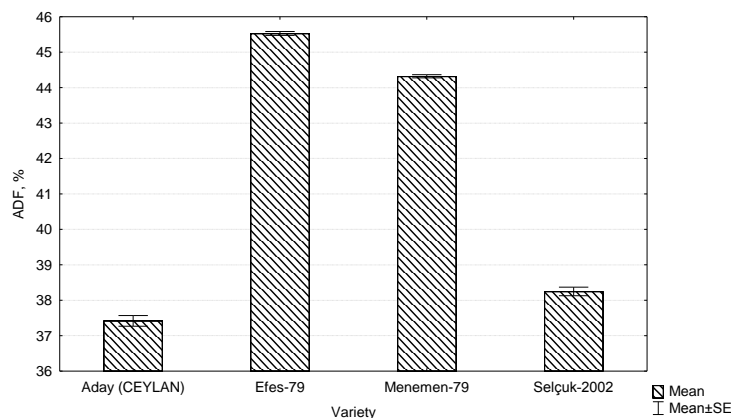


Figure 6. ADF contents of four vetch varieties

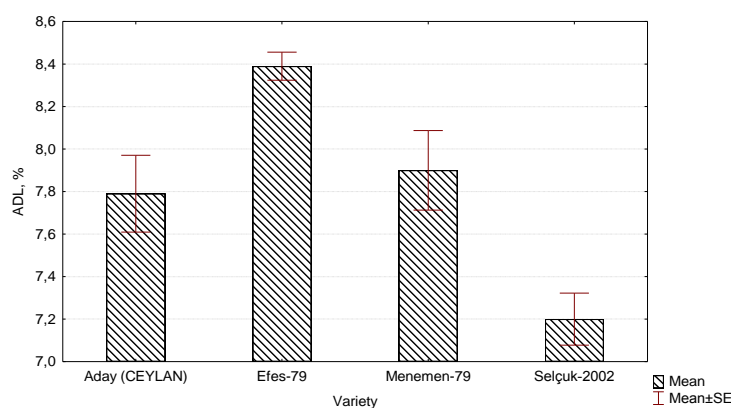


Figure 7. ADL content of four vetch varieties

## Conclusion

Aday (Ceylan) hairy vetch had the highest green herbage and dry matter yield in both agricultural stations of Hatay and Ceylanpınar. From agricultural and animal nutrition of point of view, Aday (Ceylan) seemed to be the best suitable in Hatay Province.

## References

- Abd El-Moneim, A.M.1993. Agronomic potential of three vetches (*Vicia* spp.) under rainfed conditions. *Journal of Agronomy and Crop Science*, 170, 113-120.
- Açıkgöz E, 2001. *Yem Bitkileri*. Uludağ Üniversitesi Ziraat Fakültesi Tarla Bitkileri Bölümü, 3. Baskı, Bursa.
- Albayrak S, O. Tongel ve M. Güler, 2005. Identification and stability analysis of seed yield and yield of vetch (*Vicia sativa* L.) varieties in the Central Black Sea Region. *Ondokuzmayıs Üniversitesi Ziraat Fakültesi Dergisi*. 20 (1): 50-55.
- Al-Doss A. A., 1996. Growth Characters and Yield of Some Selected Lines of Common and Narbon Vetch. *Res. Bull, No. (63), Agr. Res. Center, King Saud Univ., pp., (5-17)*.
- Anonymous, 2015. *Ceylanpınar and Hatay Meteorology Station Directorate Data*.
- AOAC: Official Methods of Analysis. Association of Official Analytical Chemists, Arlington, VA, 1995.
- Badrzadeh M, Zaragarzadeh F and Esmailpour B. 2008. Chemical composition of some forage *Vicia* spp. in Iran. *Journal of Food, Agriculture & Environment* Vol.6 (2): 178-180.

- Caballero R, C. Alzueta, L.T. Ortiz, M.L. Rodriguez, C. Barro and A. Rebole, 2001. Carbohydrate and protein fractions of fresh and dried common vetch at three maturity stages. *Agron, J.* 93: 1006-1013.
- Chowdhury D, Tate M.E., McDonald G.K., and Hughes R, 2001. Reducing Seed Toxing Levels in Common vetch (*Vicia sativa* L.). [www.regional.org.au/au/asa/2001/5/c//chowdury.htm](http://www.regional.org.au/au/asa/2001/5/c//chowdury.htm).
- Chung W.J, Kim T.S, Suresh S, Lee S.L, Cho G.T, 2013. Development of 65 Novel Polymorphic cDNA-SSR markers in common Vetch (*Vicia sativa* subsp. *sativa*) using next generation sequencing. *Molecules*, 18, 8376-8392.
- Desalegn K and Hassen W. 2015. Evaluation of biomass yield and nutritional value of different species of vetch (*Vicia*). *Academic Journal of Nutrition* 4 (3): 99-105.
- Erdurmuş C, Çeçen S, Yücel C. 2010. Determining yield and yield components of some common vetch (*Vicia sativa*) cultivars and lines in Antalya conditions.
- Georgieva N, Nikolova I, Kosev V. 2015. Relationships among Quantitative Traits and Seed Yield in Vetch (*Vicia sativa* L., *Vicia villosa* Roth.). *Columbia International Publishing American Journal of Agricultural Science and Technology* .Vol. 3 No. 1 pp. 24-32.
- Hakyemez B.H, 2006. Effect of Sowing Dates on Forage and Seed Yields in Common Vetch (*Vicia sativa* L.). *Uludag Üniv. Zir. Fak. Derg.*, 20 (1): 47-55.
- Karadağ Y and Büyükburç U. 2011. A research hay and seed yield of some common vetch cultivars under Tokat Conditions. *GOÜ, Ziraat Fakültesi Dergisi* 18 (1), 81-87.
- Karlı MA, Akdeniz H, Levendoğlu T, Terzioğlu Ö. 2005. Evaluation of the nutrient content and protein fractions of four different common vetch varieties. *Turk J. Vet. Anim. Sci.* 29: pp.1291-1297.
- Lauk R, Lauk E, Lauringson E & Talgre L. 2007. Vetch-wheat crops are superior to vetch-oat crops in terms of protein yield. *Acta Agriculturae Scandinavica Section B-Soil and Plant Science*, 57: 116-121.
- Lithourgidis A.S., Vasilakoglou I.B, Dhima K.V, Dordas C.A, Yiakoulaki M.D, 2006. Forage yield and quality of common vetch mixtures with oat and triticale in two seeding ratios. *Field Crops Research* 99, 106–113.
- Marley C.L, Theobald V.J, Fychan R., Thomas B, Gethin A., Scott M.B., Sanderson R. and Mc Calman H.M. 2017. Utilising Common Vetch as A Source of Forage Protein for Grazing Ewes. [http://sustainableforageprotein.org/uploads/IBERS\\_Vetch\\_Research\\_Poster.pdf](http://sustainableforageprotein.org/uploads/IBERS_Vetch_Research_Poster.pdf)
- Matic R., Nagel S., Young I., Kirby G. (2005). Vetch breeding in Australia and the effects of varying levels in grain mixes on lamb growth. *Proceedings of the 13th Australasian Conference, New Zealand.*
- Mutlu Z. 2002. The Effect of various harvesting in some winter vetch species on herbage yield. Master Thesis. Ankara University, Graduate School of Natural and Applied Sciences, Department of Field Crops.
- SAS, 2002. SAS Institute Inc., SAS/STAT® User's Guide, Version 8, SAS Institute Inc., Cary, NC.
- Sayar MS, Yücel C, Tekdal S, Yasak Ş, Yıldız E, 2009. Researches on Determination Yield and Yield Components of Some Common Vetch (*Vicia sativa* L.) Genotypes in Ecological Conditions of Diyarbakır. *Türkiye VIII. Tarla Bitkileri Kongresi, Hatay*, s. 518-521.
- Temel S, Keskin K, Yıldız V, Kır A.E, 2015. Investigation of Dry Hay Yield and Quality Characteristics of Common Vetch (*Vicia sativa* L.) Cultivars for in Iğdır Plain Download Conditions. *Iğdır Univ. J. Inst. Sci. & Tech.* 5(3): 67-76.

- Ünal S, Fırıncıoğlu H.K, and Mutlu Z. 2016. Improvement of winter hardiness in common vetch lines for semi-arid conditions. *Bulgarian Journal of Agricultural Science*, 22 (No 5) 756–766.
- Van Soest, P.J., Robertson, J.B., Lewis, B.A. 1991. Methods for dietary fiber, neutral detergent fiber, and non-starch polysaccharides in relation to animal nutrition. *J Dairy Sci*, 74, 3583-3597.
- Yücel C, Ayaşan, T. 2010. Effect of different incubation times on in vitro digestibility of some common vetch (*Vicia sativa* L.) cultivars grown in Çukurova conditions. *Gaziosmanpaşa Üniv Zir Fak Derg*, 28 (2): 1-8.
- Yücel C, Çil A, Çil AN, 2006. The determining of the forage and seed yield of some common vetch (*Vicia sativa* L.) cultivar and lines under the Harran Plain Conditions. *Harran Üniversitesi Ziraat Fakültesi Dergisi* 10: 63-71.
- Yücel C, Gültekin R, İnal İ, Avcı M, 2007. Yield and important agricultural characteristics of common vetch lines. *Türkiye VII. Tarla Bitkileri Kongresi Cilt 2, Erzurum*, s. 285-288.
- Yücel C, Gültekin R, İnal İ, Avcı M, 2008. Determination Yield and Yield Components of Some Common Vetch (*Vicia sativa* L.) Genotypes in Ecological Conditions of Çukurova. *Anadolu, Ege Tarımsal Araştırma Enstitüsü Dergisi* 18: 38-54.

## AGRONOMIC PERFORMANCES AND NUTRITIONAL VALUES OF FOUR HAIRY VETCH (*VICIA VILLOSA* ROTH L.) VARIETIES GROWN IN DIFFERENT LOCATIONS

Hakkı AKDENİZ<sup>1\*</sup>, Ali KOÇ<sup>2</sup>

<sup>1</sup>Iğdır University, Agricultural Faculty, Department of Field Crops, Iğdır-TURKEY

<sup>2</sup>General Directorate of Agricultural Affairs, AR-GE, Ankara-TURKEY

\*Corresponding author: hakki\_akdeniz@hotmail.com

### Abstract

The objective of this study was to compare performances of four winter vetch varieties (Aday (Ceylan, Efes-79, Menemen-79 and Selçuklu-2002) subjected to different locations of Agricultural Station of Hatay and Ceylanpınar of Turkey in 2012. Seeds of four winter vetches species were sown in plots in complete randomized block with four replications in both Ceylanpınar district and Hatay province. The experiment results indicated that all traits of winter hairy vetch varieties except for winter hardiness and plant length in Ceylanpınar and winter hardiness and length of the main stem in Hatay location were highly significant. Aday (Ceylan) with winter hairy vetch had the highest dry matter yield in both agricultural stations of Hatay and Ceylanpınar. Furthermore, it was concluded that Aday (Ceylan) seemed to be the most suitable for agricultural point of view, erect growing, high-yielding and winter-resistant, as well as a promising variety regarding nutrient content for animal nutrition.

**Keywords:** *Vicia sativa*, varieties, agronomic traits, nutritional values

### Introduction

All efforts made in animal husbandry are aimed at increasing the efficiency to be provided from the unit head or animal group in spite of unit production. This, on the one hand, is dependent on the use of high yielding/qualified animal breeds, and on good care and nutrition. Making a good feed can be accomplished by the fact that feed or feedstuffs used are adequate and balanced in the field. The chemical composition of legume feeds varies according to species, variety, geographical area and agricultural practices, and the protein content varies between 20-45% (Abreu and Bruno-Soares, 1998). Grain of leguminous is used as alternative protein sources in areas where the production of oilseed crops is low or expensive due to high crude protein content. Lauk R and Lauk E. (2009) stated that Vetch-cereal intercrops produced considerably higher protein yields on the soil without any N-fertilizer than sole cereal crops and were regarded as highly suitable for organic farming. Common vetch (*Vicia sativa*) seed has been used in animal feed as an alternative source of protein in poultry diets (Darre et al., 1999). In identifying the differences between feeds, it is important to identify the chemical composition of feed and energy and digestible nutrients. This study was carried out in order to compare the quality of the genotypes with the yield and yield components of vetch widely used in the growing season of 2012.

## Material and Methods

Four vetch varieties Aday (Ceylan), Efes-79, Menemen-79 and Selçuklu-2002 were compared for growth yield traits in a field trial in two separate locations Ceylanpınar and Hatay in Turkey. The experiment was carried out in an experimental field in both Ceylanpınar and Hatay Agricultural Experimental Enterprise in 2010-2011. The sites of the experiment in Hatay and Ceylanpınar; soluble salts (EC=0.38 and 0.69  $\text{dsm}^{-1}$ ), high  $\text{CaCO}_3$  (22.37% and 25.4%), organic matter (0.84% and 2.26%), and a pH value of 7.82 and 7.81 respectively. Available phosphorus ( $\text{P}_2\text{O}_5$ ) in Hatay and Ceylanpınar was 83.5 and 4.2 ( $\text{kg ha}^{-1}$ ); potassium ( $\text{K}_2\text{O}$ ) 1381.3 and 1125.0 ( $\text{kg ha}^{-1}$ ), respectively. Plot size was 7.5  $\text{m}^2$ , with 0.25 m spacing distance and 5 m plot length. The plot was arranged in a completely randomized block design with four replications. Sowing rate was 100  $\text{kg ha}^{-1}$ . The four genotypes of vetch were ridge-sown in 0.7 m interval on 2 November 2011 and fertilized basically with 50  $\text{kg ha}^{-1}$  for each of N,  $\text{P}_2\text{O}_5$  and  $\text{K}_2\text{O}$  by a chemical compound fertilizer. Each plot was fertilized with 100  $\text{kg ha}^{-1}$  each of  $\text{P}_2\text{O}_5$  and  $\text{K}_2\text{O}$  with top dressing of some fertilizers. Weed control was performed manually several times as required by workers. Vetch genotypes were harvested at 5 cm above the ground level 24 May 2012. Total nitrogen was determined by Kjeldahl method AOAC (1990). Crude protein (CP) was calculated as  $\text{Nx}6.25$ . Ash was determined by complete burning of the feed samples in a muffle furnace at 500 °C overnight according to the procedure of AOAC (1990). Neutral detergent fiber (NDF), acid detergent fiber (ADF) and acid detergent lignin (ADL) was analyzed using ANKOM Analyzer (Van Soest et al. 1991).

### Statistical analysis

The obtained data of Ceylanpınar and Hatay locations was evaluated separately and combined using SAS statistical package program. The LSD test was used to compare the difference between the averages (SAS Institute, 1999).

Table 1. Some characteristics of soil experiment during the growing year 2010-2011 year.

Table 2. Some climatic data of Ceylanpınar and Hatay Agricultural Enterprises in 2010-2011

Months	Mean Temperature (°C)				Rainfal (mm)				Humidity (%)			
	Hatay		Ceylanpınar		Hatay		Ceylanpınar		Hatay		Ceylanpınar	
	2011-2012	Long years (5)	2011-2012	Long years (5)	2011-2012	Long years (5)	2011-2012	30 years	2011-2012	Long years (5)	2011-2012	Long years (5)
November	9.8	14.9	9.1	13.2	83	60.6	38.2	35.9	75	72.3	61.7	55.6
December	6.9	8.3	5.9	8.1	143	112.2	19.7	43.2	83	71.9	70.7	66.4
January	6.4	6.8	5.1	4.8	239.4	90.9	66	47.5	89.4	74.2	82.8	68.3
February	8.5	9.3	6.1	7.5	164.8	87.2	26.8	43.8	75.1	73.8	66.7	70.7
March	10.4	13.2	9.1	12.2	55.6	75.2	16.4	46.1	65.4	70.7	56.6	63.8
Aprile	18.2	16.5	18.6	16.2	2.2	49.6	7.2	47.2	60.9	69.2	50.9	57.3
May	21.9	21.3	22.7	22.8	17.2	30.9	5.2	19.3	62.2	62.1	49.2	44.4
June	27.4	26.3	29.1	29.6	0.6	2.1	0	3.9	56.8	53	31.5	31.7
Total/Mean	13.7	14.6	10.9	12.1	705.8	508.7	179.5	286.9	71	68.4	62.7	60.9

## Results and discussion

### Climatic Conditions

The main air temperature of Hatay and Ceylanpınar in the experiment period was 13.7 °C and 10.9 °C; a total precipitation was 705.8 mm and 179.5 mm; the humidity was 71% and 62.2%, respectively (Table 2). The precipitation in January, February and March in the Hatay location were higher than in other agricultural experiments. Although precipitations of Hatay were higher than in both Ceylanpınar and long years, the plants were not observed in either location (Anonymous, 2012).

### Number of flowering day of the Four Vetch (*Vicia*) varieties



Flowering days for varieties in Ceylanpınar ranged from 151.0 to 168 day; from 160 to 169 day in Hatay; Aday (Ceylan) had early flowering genotype in both locations as is presented in Table 2 and 3 and 4. That is why Aday (Ceylan) genotype seen to be earliest among varieties of vetch. According to the quotation by Fırıncıoğlu (2009) from Turner (1997), early flowering can be able to permit a long grain-filling time during, and early flowering and podding combined with vigorous early growth resulted from rapid canopy development and dry matter production, which laid the potential for a larger total biomass and higher seed yield. Therefore, selection for more rapid crop growth in spring is likely to increase the common vetch yield. Color of all the varieties used in the study was RHS.

#### **Number of Physiology Maturing Day of the Four Vetch (*Vicia*) varieties**

A number of Physiology Maturing Day in Ceylanpınar and Hatay ranged from 187 to 202; 195 to 204; means of locations were 191 and 203 days. Selçuk-2002 variety in both places and means of locations were the earliest variety that reached physiological maturing (Tables 2, 3 and 4). These of a number of Physiology maturing days were quietly close together results of Sayar et al. (2009) cited that days to physiological seed maturity (194.0-198.4 days).

#### **Lodging of Vetch Varieties of the Four Vetch (*Vicia*) varieties**

Growing form of vetch varieties was observed from different scale; Efes-79, Menemen-79 and Selçuk-2002 had the semi-erecting growing. In contrast to these varieties Aday (Ceylan) had the highest erect form among the varieties as was presented in Tables 2, 3 and 4. In generally, common vetches have a long, thin, easily lodging stem. Therefore, it is of great importance for agricultural development to be upright without company plants. Lodging was not prominent in any of the four cultivars and did not affect forage yields. It is seen that the average value of 2 points according to Candidate (Ceylan) 1-5 scale in varieties and two values according to the average are promising regarding agricultural development.

#### **Winter Hardiness of the Four Vetch (*Vicia*) varieties**

Winter resistance of all vetch varieties in Hatay and Ceylanpınar was found to be the quite high performance in addition to there was no the difference between the varieties despite different climatic conditions. However, studies of winter hardiness on common vetch in Turkey is very limited. To improve winter hardiness and adaptation in common vetch, it is imperative to know the magnitude of genotypic variability present, as this will provide the basis for efficient selection (Fırıncıoğlu et al. (2009).

**The Number of Pod per Plant of the Four Vetch (*Vicia*) varieties** In Ceylanpınar, the number of pod per plant ranged from 17.3 to 33 with the highest value Aday (Ceylan) and pod/plant were between 46.6 to 60.4 in Hatay, there was a statistically significant difference between both locations regarding this feature. These differences can be attributed to amount of precipitation in Hatay was higher than Ceylanpınar (Table 1). The number of pod per plant were between positive and significant correlation Seed/pod (S/P) and on the contrary, was negative between Lodging (L).

#### **The Number of Seed per Pod of the Four Vetch (*Vicia*) varieties**

The number of seed per pod is a crucial yield character of the plant as well as all other in both cereal and forage crops as a yield parameter. Seed number per plant in Ceylanpınar and Hatay, 3.2-4 and 4.4-5.6 was measured. However, the highest seed number per plant of four vetches according to locations had Aday (Ceylan) and followed the variety Menemen-79, Efes-79 and lowest seed per pod were Selçuklu-2002. However, a strong positive correlation was found between seed number/pod (SN/P) and seed/pod (S/P) ( $r=0.685^{**}$ ). Similarly, Sayar (2014) showed that pod numbers per plant were significantly and positively correlated with SDY. The yield component traits were highly significantly positively correlated with seed yield.

**Biological Yield of the Four Vetch (*Vicia*) varieties** Regarding biological yield, vetch varieties showed different groups according to their locations. In Ceylanpınar, yielding of

Aday (Ceylan) were higher than the other varieties and on the other hand, Selçuk 2002 showed lower yields than the other varieties. As a mean of locations, Aday (Ceylan) with 50.5 t ha<sup>-1</sup> played prominent genotype among varieties in respect of biomass/biological yield in Table 2, 3 and 4. Environmental conditions such as precipitation and temperature and cultivars in the field experiments could cause such a difference. Also this, biomass were in both positive and significant correlation between seed/pod (S/P), seed number/pod (SN/P). However, Tamkoç and Avci, (2004a) are thought biological yields depends on a wide range of agronomic applications with ecological and climatic factors as well as genotypic differences. Similarly, Moneim (1992) also stated that most of the lines had wide adaptation to dry areas in terms of both grain yield and stability. Climate, except early spring rains, had little effect on biological and grain yields.

#### **The Seed Yield of the Four Vetch (*Vicia*) varieties**

The observed seed yield of vetches, Aday (Ceylan) vetch genotype did not show significant differences in terms of seed yield except for Selçuklu-2002 in Hatay location. However, there were significant differences on seed yield between the locations. Aday (Ceylan) and Menemen-79 varieties were the almost the same according to as a means of locations. The results seed yields of the present were higher than findings by Desalegn and Hassen (2015) found that the average grain yields were varied ranging from 12.16 t ha<sup>-1</sup> to 14.29 t ha<sup>-1</sup> in *Vicia purpurea* and *Vicia sativa* respectively. Albayrak et al. (2005) found that the seed yield in common vetch genotypes was between 980-1600 kg ha<sup>-1</sup> in a different ecology in the black sea region. Nizam et al. (2012) found that genotype x environment interaction was statistically significant in hay yield and seed yield of common vetch genotypes. However, correlations between seed yield and seed/pod (S/P), seed number/pod (SN/P) and biomass (B) were both positive and significant as have been confirmed by Çakmakçi et al. (2004) stated that positive correlation was observed between seed yield and number of seeds per plant, and number of pods per plant. However, Zaman et al. (2012) stated that high seed density resulted in the greater dry matter and seed yield than the low seed density.

#### **The Straw Yield of the Four Vetch (*Vicia*) varieties**

The straw yields of vetch ranged from 29.5 to 36.9 in Ceylanpınar; from 51.7 to 54.9 t ha<sup>-1</sup> in Hatay location and as a means of results, from 42.9 to 45.6 t ha<sup>-1</sup>. Although the vetch varieties in the locations have some irregularities in the straw yields, the highest straw yields were obtained from according to the average the varieties and locations in Table 2, 3 and 4. The straw yield was a positive and strong correlation between seed/pod, seed number/pod and biomass. These findings were verified by Aydoğdu and Açıkgöz (1995), Çakmakçi et al. (2003) and concluded that seed yield strongly correlated with straw yield.

#### **1000-Seed Weight of the Four Vetch (*Vicia*) varieties**

Concerning 1000 seed weights (39.3-40.0 g), there was no a statistically significant difference among the varieties in the mean, although there were some irregularities in the locations in Table 2, 3 and 4. Orak and Nizam (2004) concluded that 1000-seed weight of genotypes (31.92- 63.52 g) was higher than findings of the present study. On the contrary, Uzun et al. (2004) and Zaman et al. (2012) based on the 2-year results, no significant differences were found among two cultivars in any of the measured characteristics except 1000- seed weight.

#### **Harvest Index of the Four Vetch (*Vicia*) varieties**

The statistical analysis showed the significant difference among the vetch (*Vicia*) species as prepared in Table 5. The highest harvest index was recorded in Aday (Ceylan) in both Hatay and Ceylan location, but there were no significant differences between vetch species according to as a means of location in Table 5. Findings of harvest index (15.8-18.3) were lower than results by Sayar et al. (2009) harvest index 33.92-47.41%. However, the results of the Orak and İlker (2004) verified the results of the 1000-piece weight we obtained in separately obtained at both sites except for as a means of locations.

Table 3. Yield and some agronomic traits of four vetch varieties grown Ceylanpınar Agricultural enterprises in 2010-2011 year.

Variety	Days to flowering	Days to maturity	Lodging (1-5)	Winter Hardness (%)	Pods/Plant	Seed/ Pod	Biomass Yield (t/ha)	Seed yield (t/ha <sup>-1</sup> )	Straw yield (t/ha <sup>-1</sup> )	1000-seed weight (gr)	Harvesting index
Aday (Ceylan)	151 d	187 d	2.0	90	33.0 a	4.0 a	55.9 a	77.0 a	36.9 a	38.0 b	17.4 a
Efes-79	165 b	199 b	3.6	90	21.4 c	3.6 ab	50.6 b	52.8 c	29.5 b	42.0 a	15.2 b
Menemen-79	168 a	202 a	3.8	90	25.0 b	4.0 a	52.6 b	56.4 bc	31.6 b	38.0 b	15.3 b
Selçuklu-2002	157 c	195 c	4.0	90	17.4 d	3.2 b	51.0 b	61.1 b	33.7 a	42.0 a	15.2 b
CV %	0.35	0.35			5.6	8.1	6.7	8.8	6.3	4.2	2.5
LSD	0.78	0.95			1.87	0.52	36	7.5	28.6	2.35	0.54
F	**	**	ns	ns	**	*	**	**	**	**	**
Mean	160.3	195.7	3.35	90	24.2	3.7	38.2	61.8	32.3	40.0	15.79

abc = means with different superscripts within row are significantly different p (0.05).

ns: not significant; \* significant at P < 0.05; \*\* significant at P < 0.01.

Table 4. Yield and some of vetch varieties to have been grown in Hatay Agricultural enterprises in 2010-2011 year.

Variety	Days to flowering	Days to maturity	Lodging (1-5)	Winter Hardness (%)	Pods/Plant	Seed/ Pod	Biomass Yield (t/ha)	Seed yield (t/ha <sup>-1</sup> )	Straw yield (t/ha <sup>-1</sup> )	1000-seed weight (gr)	Harvesting index
Aday (Ceylan)	160 d	195 c	2	90	60.4 a	5.6 a	67.7 a	12.9 a	54.8 a	40.9 a	19.1 a
Efes-79	167 a	201 a	4	90	49.0 bc	5.2 ab	66.4 a	11.5 b	54.9 a	38.0 b	17.3 c
Menemen-79	169 a	204 a	4	90	55.0 ab	4.4 b	68.9 a	12.5a	56.4 a	40.5a	18.0 b
Selçuklu-2002	165 b	199 b	4	90	46.6 c	4.4 b	61.9 b	10.2 c	51.7 b	37.5 b	16.4 d
CV %	0.6	0.5			8	11.8	3.2	4.5	3.1	1	2.6
LSD	1.08	99.8			5.83	0.8	29.4	7.38	23.4	0.56	0.63
F	**	**			**	**	**	**	**	**	**
Mean	165.2	199.7		90	52.8	4.9	66.2	11.6	54.7	39.2	17.69

abc = means with different superscripts within row are significantly different p (0.05).

ns: not significant; \* significant at P < 0.05; \*\* significant at P < 0.01.

Table 5. Agronomic traits of vetch varieties grown in Ceylanpınar and Hatay Agricultural enterprises 2010-2011 growing season

Variety	Days to flowering	Days to maturity	Lodging (1-5)	Winter Hardness (%)	Pods/Plant	Seed/ Pod	Biomass Yield (t/ha)	Seed yield (t/ha <sup>-1</sup> )	Straw yield (t/ha <sup>-1</sup> )	1000-seed weight (gr)	Harvesting index
Aday (Ceylan)	155.5 c	191.0 d	2.0 c	90	46.7	4.8 a	55.9a	10.3 a	45.6 a	39.5	18.3 a
Efes-79	166.0 a	200.0 b	3.6 b	90	35.4	4.4 ab	50.6 b	8.3 c	42.3 b	40.0	16.3 ab
Menemen-79	168.5 a	203.0 d	3.8 ab	90	40.0	4.2 ab	52.7 b	9.1 b	43.6 b	39.3	16.7ab

Selçuklu-2002	161.0 b	197.0 c	4.0 a	90	32.0	3.8 b	51.0 b	8.1 c	42.9 b	39.3	15.8 ab
CV %	0.4	0.3			8.1	11.4	4.5	6	4.3	3.1	2.6
LSD	0.63	0.65			2.9	0.45	22.04	5	17.5	1.13	0.4
F	**	**			**	**	**	**	**	ns	**
Location (L)	**	**			**	**	**	**	**	ns	**
Variety (LxV)	**	**			**	*	**	**	*	ns	**
L xV int.	**	**			ns	*	**	**	**	**	*
Means	162.8	198.7		90	38.5	4.3	52.3	89.7	43.6	39.6	16.7

abc = means with different superscripts within row are significantly different p (0.05).

ns: not significant; \* significant at P < 0.05; \*\* significant at P < 0.01.

### The Chemical Composition (%) of the Four Vetch (*Vicia*) varieties

The Chemical Composition (%) of the four vetch (*Vicia*) varieties varied from water content (7.9-12.3%), dry matter (87.7-92.6), crude ash (3.60-4.35 %), crude protein (26.27 -28.17%), crude oil (0.30 -0.51%), crude cellulose (0.19-0.23) in Fig. 1, NDF (34.78-40.09), ADF (12.22 -15.16% ) and ADL (2.813.65%) of four vetch (*Vicia*) species Table 6 in Fig.2. Among the evaluated four vetch (*Vicia*) variety found to be the promising one in terms of its water content 12.3% with Aday (Ceylan) dry matter 92.6% with Menemen-79, crude protein 28.17 % with Selçuk-2002, Crude Oil 0.51%, with Aday (Ceylan), Crude cellulose 0.23% with Efes-79, NDF 40.09 % with Efes-79, ADF 15.16% with Aday (Ceylan) and ADL 3.65 and 3.48 % with Aday (Ceylan) and Menemen-79 respectively. Numerous authors have reported that among the varieties of common vetch crude protein ratios vary between 9.08-22.30% (Yücel et al., 2013; Yılmaz and Erol, 2015). Karslı et al. (2004) the concentrations of DM and ADIN-N did not differ, concentrations of organic matter (OM), CP, NDF, and ADF varied significantly among different vetch varieties. Karadağ and Yavuz (2010) Seed yields ranged from 1160 to 1459 kg ha<sup>-1</sup>, CP content ranged from 24.94 to 27.86%, ADF content ranged from 5.81-8.45%, NDF ranged from 9.89 to 11.42% and CF content ranged from 1.16 to 3.23% based on the averages of the two years results. These results of ADF was positively correlated to NDF ( $r = 0.850$ ) in the present study were consisted of findings by Badrzadeh et al. (2008). The results of ADF was negatively correlated to CP ( $r = -0.99$ ) and DDM ( $r = -0.98$ ) and positively to NDF ( $r = 0.96$ ) Yılmaz and Erol, 2015, genotypes differences were determined to significant in terms of other characters except for ADF ratio. Therefore, year x genotype interaction was also found to be significant for most of the characteristics except for crude protein ratio, NDF ratio and crude ash ratio. Maršalkienė N. (2015) suggested that according to the crude protein content in the plant above ground mass, the stem, leaf and inflorescence ratio in the plant mass of *V. villosa* and some samples of *V. angustifolia* were more valuable than in that of cultivated *V. Sativa*. On the other hand, Moneim et al. (1990) concluded that as plants matured IVDMD, CP and leafiness decreased, and NDF and ADF increased. For all the genotypes maximum digestible dry matter (DDM) and CP yields were more or less attained at 50–100 % podding. In addition to these findings, seed yield and chemical compounds of common vetch lines can be affected by adverse agricultural conditions (Milczak et al., 2001). Contrary to results of the present, Temel et al. (2015) concluded that crude protein ranged from 15.15 to 20.69 %, 40.63 to 47.27% for NDF, from 28.94 to 35.71% for ADF, from 4.39 to 7.06% for ADL. Kebede et al.(2013) indicated that forage dry matter yield was positively associated with days to forage and seed harvests, plant height, crude protein and digestibility.

Table 6. Chemical Composition (%) of the four vetch (*Vicia*) species to have grown in Hatay and Ceylanpınar

Variety	Water content	Dry matter	Crude ash	Crude protein	Crude oil	Crude cellulose	NDF	ADF	ADL
Aday (Ceylan)	12.3 a	87.7 c	3.60 c	26.27 b	0.51 a	0.19 b	38.85 b	15.16 a	3.65 a
Efes-79	10.2 b	89.3 b	4.35 a	26.27 b	0.43 b	0.23 a	40.09 a	11.97 b	2.81 b
Menemen-79	7.9 c	92.6 a	3.90 b	26.42 b	0.30 c	0.19 b	37.97 b	12.22 b	3.48 a
Selçuklu-2002	10.2 b	89.3 b	3.87 b	28.17 a	0.30 c	0.22 ab	34.78 b	11.55 b	3.02 b
Means	10.2	89.7	3.9	26.83	0.39	0.21	37.92	12.73	3.24

abc = means with different superscripts within row are significantly different p (0.05).

Table 7. Simple correlation coefficients (*r*) among yield and yield component of vetch varieties

	NFD	PN	L	S/P	SN/P	B	SY	SY	SW	HI
Number of flowering day (NFD)	1									
Pysiology number (PN)	.982**	1								
Lodging (L)	.604**	.675**	1							
Seed/pod (S/P)	.248	.199	-.311*	1						
Seed number/pod (SN/P)	.191	.120	-.309*	.685**	1					
Biomass (B)	.281	.265	-.139	.940**	.668**	1				
Seed yield (SY)	.209	.189	-.261	.960**	.699**	.986**	1			
Straw Yield (SY)	.299	.285	-.106	.930**	.656**	.999**	.978**	1		
1000-Seed weight (SW)	-.075	.013	.066	-.193	-.176	-.160	-.121	-.169	1	
Harvest Index (HI)	-.108	-.146	-.608	.857**	.673**	.796**	.880**	.770**	-.087	1

\*. Correlation is significant at the 0.05 level.

\*\*. Correlation is significant at the 0.01 level.

Table 8. Simple correlation coefficients (*r*) among some chemical contents of vetch varieties

	W	DM	CA	CP	CO	CC	ADF	NDF	ADL
Water (W)	1								
Dry matter (DM)	-.912**	1							
Crude Ash (CA)	.591	-.512	1						
Crude Protein (CP)	.838**	-.783*	.608	1					
Crude oil (CO)	-.068	.290	-.351	-.340	1				
Crude Cellulose (CC)	-.388	.356	-.186	-.686	.224	1			
ADF	.354	-.397	.416	.086	-.106	.641			
NDF	.421	-.495	.111	.143	.025	.459	.850**	1	
ADL	.788*	-.834**	.641	.666	-.528	-.093	.574	.442	1

\*. Correlation is significant at the 0.05 level.

\*\*. Correlation is significant at the 0.01 level.

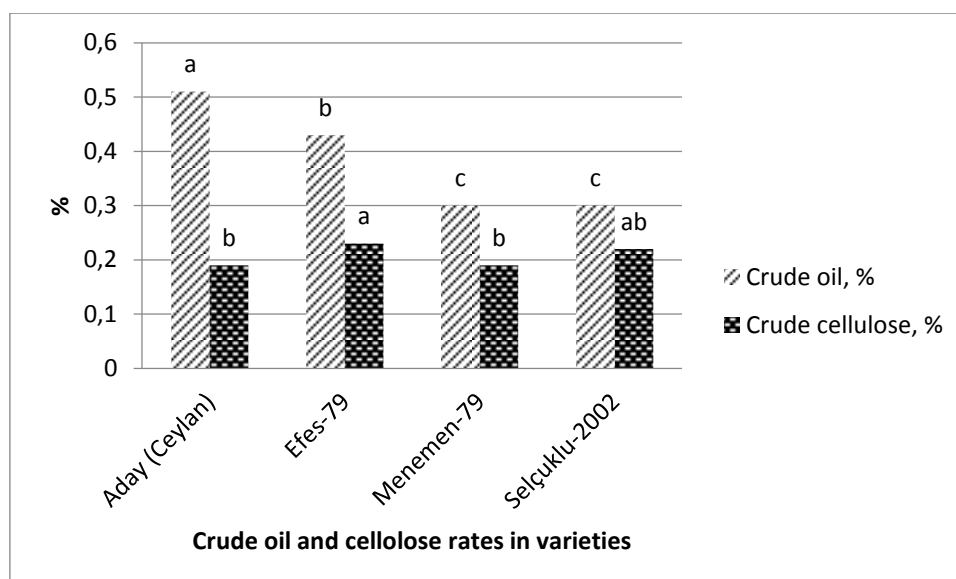


Figure 1. Crude oil and cellulose ratios of vetch varieties (%).

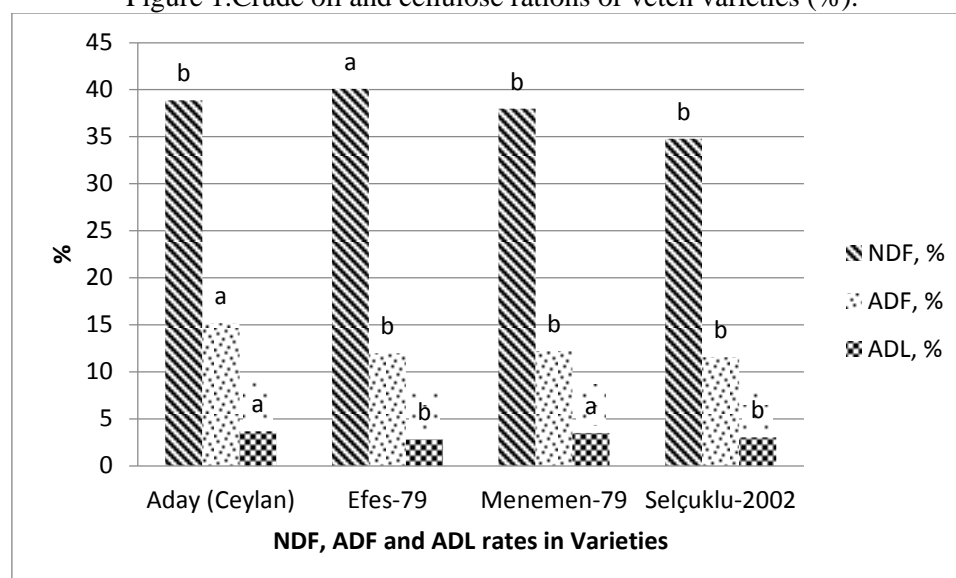


Figure 2. NDF, ADF and ADL ratios of vetch varieties (%).

### Conclusion

On the basis of these results, it is concluded that most of the tested vetch varieties are adapted to the region of Ceylanpınar and Hatay conditions in terms of both agricultural traits and chemical analysis. Leguminous grain foods are used as alternative protein sources in areas where the production of oilseed crops is low or expensive due to high crude protein contents. The best variety was Aday (Ceylan) with winter hairy had the highest and dry matter yield in both agricultural stations. Furthermore, Aday (Ceylan) seemed to be the best suitable for agricultural from the stand point of view, erect growing, high-yielding and winter-hardiness, as a grain variety regarding nutrient content animal nutrition.

### References

- Moneim A. M. Abd El M. Khair A., Rihawi S. 1990. Effect of genotypes and plant maturity on forage quality of certain forage legume species under rainfed conditions. *J. Agronomy & Crop Science* 164, 85-92.

- Abreu J.M.F and Bruno-Sores A.M. 1998. Chemical composition, organic matter digestibility and gas production of nine legume grains. *Anim. Feed Sci. Techno.*, 70:4957.
- Albayrak S, O. Tongelme M. Güler, 2005. Stability analysis and determination of seed yield and yield components of candidate vetch (*Vicia sativa* L.) Varieties in Middle Black Sea region. *Ondokuzmayıs Üniversitesi Ziraat Fakültesi Dergisi*. 20(1): 50-55.
- Albayrak S, Sevimay C.S., Töngel Ö. 2004. Effects of inoculation with rhizobium on forage yield and yield components of common vetch (*Vicia sativa* L.). *Turk J Agric For* 28; 405-411.
- Anonymous 2012. Ceylanpınar and Hatay Meteorology station directorate data.
- AOAC 1990. Official methods of analysis of the Association of Official Analytical Chemists, 15th end. Association of official analytical chemists, Washington, Dc.
- Aydoğdu L. and E. Açıkgöz 1995. Effect of seeding rate on seed and hay yield in common vetch (*Vicia sativa* L.). *J. Agronomy and Crop Sci.*, 174: 181 - 187.
- Badrzadeh M, Zaragarzadeh F and Esmailpour B. 2008. Chemical composition of some forage *Vicia* spp. in Iran. *Journal of Food, Agriculture & Environment* Vol.6(2) : 178-180. 2008.
- Cakmakci S., B. Aydinoglu and M. Caraca, 2003. Determination the relation among yield and yield components using correlation and path analyses in summer sown common vetch, *Vicia sativa* L. Genotypes. *Pakistan J. Bot.*, 35: 161-165.
- Darre M. J., D. N. Minior, J. G. Tatake and C. Ressler. 1999. Nutritional evaluation of detoxified and raw common vetch seed (*Vicia sativa* L.) using diets of broilers. *J. Agric. Food Chem.* 47:352-361.
- Desalegn K. 2015. Evaluation of biomass yield and nutritional value of different species of vetch (*Vicia*). *Academic Journal of Nutrition* 4 (3): 99-105.
- Fırıncioğlu H.K, Erbektaş E, Doğruyol L, Ünal S and Menteş Ö. 2009. Enhanced winter hardiness in common vetch (*Vicia sativa* L.) for autumn-sowing in the Central Highlands of Turkey. *J. Cent. Eur. Agric.* 10:3, 271-282.
- Karadağ Y. and Yavuz M. 2010. Seed yields and biochemical compounds of common vetch (*Vicia sativa* L.) lines grown in semi-arid regions of Turkey. *African Journal of Biotechnology* Vol. 9(49), pp. 8334-8338, 6 December, 2010.
- Karslı MA, Akdeniz H, Levendoğlu T, Terzioğlu Ö. 2005. Evaluation of the nutrient content and protein fractions of four different common vetch varieties. *Turk J. Vet. Anim. Sci.* 29: pp.1291-1297.
- Kebede G, Assefa G, Mengistu A, Mohammed H. 2013. Evaluation of vetch species and their accessions for agronomic performance and nutritive value in the central highlands of Ethiopia. *Ethiop. J. Agric. Sci.* 24:99-121 (2013)
- Lauk R and Lauk E. 2009. Dual intercropping of common vetch and wheat or oats, effects on yields and interspecific competition. *Agronomy Research* 7(1), 21-32.
- Maršalkienė N. 2015. Investigation of some wild annual vetch (*Vicia* L.). *Biologija*. 2015. Vol. 61. No. 1. P. 15–24.
- Milczak M, Pedzinski M, Mnichowska H, Szwedurbas K, Rybinski W (2001). Creative breeding of grasspea (*Lathyrus sativus* L.) in Poland. *Lathyrus Lathyrism Newsletter*, 2: 85-88.
- Moneun AA.E. M.A. Khair, P.S. Cocks, 1990. Growth analysis, herbage and seed yield of certain forage legume species under rain fed conditions. *J. Agron. Crop Sci.* 34-41.
- Nizam İ, Orak A, Kamburoğlu İ, Çubuk M.G. Moralar E. 2012. Trakya Bölgesi'nde bazı adi fiğ (*Vicia sativa* L.) genotiplerinin genotip x çevre interaksiyonları ve ot ve tohum verimi stabilitesinin belirlenmesi. *Tarım Bilimleri Araştırma Dergisi* 5 (2): 43-46, 2012.

- Orak A, Nizam İ. 2004. Agronomic and morphological characters of some common vetch (*Vicia sativa* L.) genotypes under Trakya region conditions. *Journal of Agronomy* 3 (2): 72-75.
- SAS, 1999. SAS Institute Inc., SAS/STAT® User's Guide, Version 8, SAS Institute Inc., Cary, NC.
- Sayar M.D, Yücel C, Tekdal S, Yasak M.Ş. Yıldız E. 2009. Researches on Determination Yield and Yield Components of Some Common Vetch (*Vicia sativa* L.) Genotypes in Ecological Conditions of Diyarbakır Türkiye VIII. Tarla Bitkileri Kongresi.
- Sayar M.S. 2014. Path Coefficient and Correlation Analysis Between Seed Yield and Its Affecting Components in Common Vetch (*Vicia sativa* L.). *Turkish journal of agricultural and natural sciences, Special Issue: 1, 2014.*
- Tamkoç A., Avcı M. A., 2004a. The determination of some variations among common vetch (*Vicia sativa* L.) Lines selected from nature. *Selçuk Üniversitesi Ziraat Fakültesi Dergisi, Konya, 18(34): s.114-117.*
- Temel S, Keskin B, YıldızV, Kır A.E.. 2015. Investigation of dry hay yield and quality characteristics of common vetch (*Vicia sativa* L.) cultivars for in Iğdir plain conditions. *Iğdir Univ. J. Inst. Sci. & Tech. 5(3): 67-76.*
- Turner N.C., Further progress in crop water relations, *Advances in Agronomy. (1997) 58:293-338.*
- Uzun A, Bilgili U, Sincik M, Acıkgöz E, 2004. Effects of Seeding Rates on Yield and Yield Components of Hungarian Vetch (*Vicia pannonica* Crantz. *Turk J Agric For* 28 (2004) 179-182.
- Van Soest PJ, Robertson JD, Lewis BA, 1991. Methods for dietary fibre, neutral detergent fibre and non-starch polysaccharides in relation to animals nutrition. *Journal of Dairy Science, 74: 3583-3597.*
- Yılmaz MF and Erol A. 2015. Determination of Forage Yields and Quality Characteristics of Some Common Vetch (*Vicia sativa* L.) Genotypes. *Türk Tarım ve Doğa Bilimleri Dergisi, 2(2): 142-151.*
- Yücel C, Avcı M, Kılıçal N, Gültekin R, 2013. Evaluation of some common vetch (*Vicia sativa* L.) Lines for forage yield and quality in Çukurova conditions. *Anadolu Tarım Bilim., Derg., 28 (3): 134-140.*
- Yücel C, Yücel D, Akkaya MR, Anlarsal AE, 2014. Relation of the Quality and Nutrient Content in Some Hopeful Common Vetch (*Vicia sativa* L.) Genotypes. *KSÜ Doğa Bil. Derg., 17 (1): 8-14.*
- Zaman S, Irannejad H, Alahdadi I, Bahrami S, Amiri R, Zaman K. 2012. Effects of seed density on yield and yield components of vetch in dry lands condition northwest of Iran. *Technical Journal of Engineering and Applied Sciences. TJEAS Journal-2012-2-2/35-38.*



## HAY YIELD AND SOME QUALITY TRAITS OF ALFALFA CULTIVARS IN THREE YEARS OLD STAND

Hanife MUT<sup>1\*</sup>, Erdem GULUMSER<sup>1</sup>, Ugur BASARAN<sup>1</sup>, Medine COPUR DOGRUSOZ<sup>1</sup>, Ilknur AYAN<sup>2</sup>

<sup>1</sup>Bozok University Faculty of Agriculture Department of Field Crops, Yozgat, Turkey

<sup>2</sup>Ondokuz Mayıs University Faculty of Agriculture Department of Field Crops, Samsun, Turkey

\* Corresponding author: hanife.mut@bozok.edu.tr

### Abstract

This research was conducted to determine hay yield and some quality traits of alfalfa cultivars at the three years old stand. The experiment was established in 2013 autumn and the data were collected in the third year after planting (2016). As plant material Bilensoy, Kayseri, Verko, Gea, Plato, Victoria, Emiliano, Sunter, Nimet and Basbag cultivars of the alfalfa was used. The study was conducted as a randomized complete block design with 3 replicates. Plant height (PH), dry matter yield (DMY), protein yield (PY), ADF, NDF, phosphorus, potassium, calcium and magnesium content of alfalfa cultivars were determined in the study. All data was calculated as a mean or total of four cuttings. As a result of this study, among the cultivars, plant height ranged between 53.9 (Verko) and 72.8 cm (Sunter). The highest and lowest hay yield was obtained in Bilensoy (9.8 t ha<sup>-1</sup>) and Victoria (1.5 t ha<sup>-1</sup>). The CP content of cultivars varied from 22.2 to 23.8 %. The highest total protein yield was determined in Victoria and Sunter (3.3 and 3.2 t ha<sup>-1</sup>), while the lowest Bilensoy (2.3 t ha<sup>-1</sup>). ADF, NDF, phosphorus, potassium, calcium and magnesium ratio of cultivars varied from 27.8 to 31.0 %, 39.0 to 42.6 %, 0.36 to 0.39 %, 2.20 to 2.41 %, 1.45 to 1.54 % and 0.26 to 0.29 %, respectively. In the third year of the establishment, Victoria and Sunter cultivars kept high performance with regard to hay and protein yield, and the other traits.

**Key words:** ADF, alfalfa, hay yield, protein yield

### Introduction

Forage crops are reliable and continuous roughage sources for livestock (Akman et al., 2007). They have a significant place in agricultural activities and constitute a sort of insurance for agricultural and livestock activities. Since forage crops are cheap feed sources, contain required nutrients for ruminants, rich in vitamins and minerals, improve reproduction power of the animals and provide high-quality animal products, they have quite significant place in animal nutrition. Turkey has quite high deficit in roughage and the greatest reason of such deficit is not to place forage crops in cultural activities sufficiently (Ayan et al., 2006). Forage crops are cultivated only over 8% of agricultural fields. Natural pastures and meadows are other sources of roughage, but they are exposed to heavy grazing and turned into sources unable to meet roughage needs because of low yield levels (Soya et al., 2004). Efficient management strategies should be implemented to reduce heavy grazing pressure, to improve the yields and to meet roughage needs. Forage crops should also be incorporated into cropping patterns both as a main and second crop. Alfalfa is the queen of forage crops. It has quite high adaptation capacity, can be harvested several times in a vegetation period. It is a perennial high yield crop, rich in various nutrients and some cultivars can be grazed. Therefore, it has a special place among forage crops. Turkey is the gene source of alfalfa and

the oldest records indicate that alfalfa was cultivated in Turkey as a forage crop almost 3300 years ago. In Yozgat province of Turkey, agricultural fields are mostly used for cereal cultivation (about 59.5% of total agricultural lands) and cereals are respectively followed by industrial crops (4.8% of agricultural lands), legumes (3.6% of agricultural lands) and forage crops (2.79% of agricultural lands) (Anonymous, 2015). Among the forage crops, mostly vetch, alfalfa and trefoil are cultivated in the province. Among the alfalfa cultivars, Bilensoy and Kayseri alfalfa cultivars are commonly grown. Forage crops are not sold or exported. Farmers grow forage crops just to meet their own needs. However, current productions are not sufficient to meet the existing roughage deficits, thus producers have various problems in their livestock activities. In this sense, it was targeted to increase and improve alfalfa cultivated lands. In this study, yield and quality parameters of different alfalfa cultivars were determined for two years under ecological conditions of Yozgat province. The primary objective was to determine appropriate alfalfa cultivars for Yozgat province.

### **Material and Methods**

Experiments were conducted over the experimental fields of Bozok University Agricultural Faculty located in Yerköy town of Yozgat province in 2016. Ten different alfalfa cultivars (Bilensoy, Kayseri, Verko, Gea, Plato, Victoria, Emiliano, Sunter, Nimet and Başbağ) were used as the plant material of the present study. Yerköy town in which experiments were conducted is 40 km away from Yozgat province. Long-term annual average precipitation of the experimental site is 574.2 mm and the precipitation in 2016 was 564.2 mm. Long-term average temperature is 9.0 °C and average temperature in 2016 was 9.67 °C. Long-term average relative humidity is 66.8 % and average relative humidity in 2016 was 62.5 %. Experimental soils have clay-loam texture. Soils were poor in organic matter, medium in phosphorus, rich in potassium and medium in lime. Soils had unsaline and alkaline structure. Experiments over the experimental fields of Bozok University Agricultural Faculty were conducted in randomized blocks design with 3 replications. Experimental plots were 5 m long and each plot had 8 rows with 20 cm row spacing. Sowing was performed in autumn (9 October 2013) as to have 20 kg seeds per hectare with a plot seeder. Soil analyses were performed before sowing and 40 kg N /hectare and 80 kg P<sub>2</sub>O<sub>5</sub>/hectare were applied at sowing. DAP (Di Ammonium Sulfate) was used as the phosphorus source and Ammonium Sulfate was used as the nitrogen source. The data presented in this study were obtained from the third year of alfalfa facility. Cuttings were performed at 10% flowering stage and a total of 4 cuts were performed (Manga et al., 2003). Irrigation was performed after each cutting. Randomly 10 plants were selected from each plot and plant height was measured from the soil surface of main shoot to the tip of the plant. Average of 10 measurements was taken as the plant height. About 50 cm sections from the top and bottom of the plots and one row from each side were omitted as to consider side effects. The remaining part was cut and resultant green herbage was weighted. Resultant weights were then converted into green herbage yield per hectare. Then, 500 g samples were taken from each plot and samples were dried at 60°C until a constant weight. Dried samples were weighted to get % dry matter ratios. Dry matter ratios were multiplied by green herbage yields to get dry herbage yield (kg) per hectare. Dried samples were ground in hand mills and made ready for further analyses (Hoy et al., 2002). Crude protein, ADF, NDF, K, P, Ca and Mg contents of ground samples were determined in a Foss NIR System (Model 6500, Win ISI II v1.5) by using IC-0904FE calibration program. Resultant crude protein ratios were multiplied by dry herbage yields to get crude protein yields. Resultant data were subjected to statistical analyses in accordance with randomized blocks design. Duncan's multiple range tests was used to compare and group the treatment means (Gulumser et al., 2006).

## Results and Discussion

Average plant heights of each alfalfa cultivar obtained from 4 cuts of the third year are provided in Table 1, dry herbage yields are provided in Table 2 and crude protein yields are provided in Table 3. Highly significant differences were observed in plant heights, dry herbage and protein yields of the cultivars ( $p < 0.01$ ).

Table 1. Variation of plant height in alfalfa cultivars by cuttings at the third year after planting.

Cultivars	Plant Height (cm)				
	1 <sup>th</sup> Cut**	2 <sup>th</sup> Cut**	3 <sup>th</sup> Cut**	4 <sup>th</sup> Cut**	Mean**
Bilensoy	59.5 abc	92.7 a	53.3 c	46.7 f	63.0 cde
Kayseri	65.9 a	76.7 cd	44.7 d	46.3 f	58.4 e
Verko	55.7 bc	61.3 e	53.3 c	45.0 f	53.9 f
Gea	63.7 ab	65.0 e	59.7 bc	52.0 e	60.1 de
Plato	50.2 cd	88.0 ab	66.7 ab	62.0 d	66.7 bc
Victoria	60.4 ab	83.0 bcd	67.3 a	63.3 cd	68.5 ab
Emiliano	45.2 d	74.3 d	68.7 a	67.3 bc	63.9 bcd
Sunter	64.1 ab	85.0 abc	70.3 a	71.7 b	72.8 a
Nimet	56.1 abc	62.0 e	54.7 c	71.7 b	61.1 de
Başbağ	43.4 d	78.0 cd	73.3 a	77.0 a	68.0 b
<i>Mean</i>	<i>56.4</i>	<i>76.6</i>	<i>61.2</i>	<i>60.3</i>	<i>63.4</i>

\*\*Mean values within same columns with different letters are statistically different  $p < 0.01$

Plant heights varied between 43.4 – 65.9 cm in the first cut, between 62.0 – 92.7 cm in the second cut, between 53.3 – 73.3 cm in the third cut and between 45.0 and 77.0 cm in the fourth cut. As the average of cuts, the greatest plant height (72.8 cm) was obtained from Sunter cultivar and the cultivar Victoria with an average plant height of 68.5 cm was placed in the same statistical group. As the average of cultivars, the greatest plant height (76.6 cm) was obtained from the second cut (Table 1). Present findings were higher than the plant heights reported by Şeker (2003); but complying with the findings of Töngel and Ayan (2010). Besides environmental factors, plant heights mostly depend on plant genetics.

As the total of 4 cuts, dry herbage yields varied between 9.8 – 14.9 t ha<sup>-1</sup> with the greatest yield (14.9 ton) from Victoria cultivar. As the average of the cultivars, the greatest dry herbage yield (4.5 t ha<sup>-1</sup>) was obtained from the first cut. The dry herbage yields decreased in each cut and the lowest value (2.1 ton) was obtained from the fourth cut (Table 2). In previous studies, dry herbage yields were reported as between 1.0 – 1.7 t ha<sup>-1</sup> under Diyarbakır conditions by Başbağ et al. (2002). Those values were lower than the present ones. Current hay yields were complying with the ones reported by Kavut et al. (2013).

Table 2. Variation of hay yield in alfalfa cultivars by cuttings at the third year after planting.

Cultivars	Hay Yield (t ha <sup>-1</sup> )				
	1 <sup>th</sup> Cut**	2 <sup>th</sup> Cut**	3 <sup>th</sup> Cut**	4 <sup>th</sup> Cut**	Total**
Bilensoy	2.8 f	4.1 a	1.6 e	1.4 e	9.8 e
Kayseri	4.6 bcd	3.3 b	1.6 e	1.5 e	11.0 d
Verko	4.8 bc	2.9 bc	1.8 e	1.6 e	11.2 d
Gea	5.3 b	2.9 bc	1.7 e	1.9 d	11.9 cd
Plato	4.0 cde	3.3 b	3.1 b	2.1 cd	12.6 c
Victoria	6.8 a	3.2 bc	2.8 c	2.2 bc	14.9 a
Emiliano	3.3 ef	2.5 d	3.7 a	2.4 b	11.9 cd
Sunter	4.9 bc	3.3 b	2.9 c	2.6 a	13.8 b
Nimet	4.9 bc	3.0 bc	2.3 d	2.3 bc	12.5 c
Başbağ	3.6 def	2.8 cd	2.9 bc	2.6 a	11.9 cd
<i>Mean</i>	<i>4.5</i>	<i>3.1</i>	<i>2.4</i>	<i>2.1</i>	<i>12.2</i>

\*\*Mean values within same columns with different letters are statistically different  $p < 0.01$

Protein yields of alfalfa cultivars varied between 0.65 – 1.33 t ha<sup>-1</sup> in the first cut, between 0.51 – 0.95 t ha<sup>-1</sup> in the second cut, between 0.30 – 0.81 t ha<sup>-1</sup> in the third cut and between 0.30 – 0.68 t ha<sup>-1</sup> in the fourth cut. As the total of four cuts, the greatest protein yields were obtained from Victoria (3.31 t ha<sup>-1</sup>) and Sunter (3.19 t ha<sup>-1</sup>) cultivars. Since these varieties have higher protein contents than the other varieties, protein yields are also higher. As the average of cultivars, the greatest protein yield (0.98 t ha<sup>-1</sup>) was obtained from the first cut and the lowest value (0.51 t ha<sup>-1</sup>) was obtained from the second cut. Present findings on protein yields comply with the values reported by Töngel and Ayan (2010) for alfalfa cultivars grown in Samsun provinces. Since protein yields are obtained by multiplying hay yields with crude protein ratios, the changes in those values also influence protein yields.

As the average of four cuts, the lowest ADF ratio (27.8%) was obtained from Kayseri cultivar and the greatest value (31.0%) was obtained from Victoria and Nimet cultivars. As the average of cultivars and cuts, the average ADF ratio was calculated as 29.1%. ADF ratio of the hay is a significant indicator of energy in ruminant rations (Tekçe and Gül, 2014). According to alfalfa hay quality directive of Western America Hay Center present ADF ratios revealed that alfalfa herbage of the present study was in good and very good quality. In previous studies, ADF ratios of alfalfa hays were reported as between 31.97 - 41.55% by Güngör et al. (2008); as between 16.8 - 33.3% by Başbağ et al. (2009); as 34.3% by Gündel et al. (2014); and as 31.86% by Çaçan et al. (2015). Present findings were complying with all those earlier ones.

The greatest NDF ratio (42.6%) was observed in Nimet cultivar and the lowest NDF ratio (39.0%) was observed in Sunter cultivar. As the average of cultivars and cuts, the average NDF was calculated as 40.8%. NDF ratio indicates how much of the cell wall could be digested (Marsalis et al, 2014) and digestion of NDF components (cellulose, hemicellulose and lignin) is quite difficult (Mertens, 2009).

Table 3. Variation of protein yield in alfalfa cultivars by cuttings at the third year after planting.

Cultivars	Protein Yield (t ha <sup>-1</sup> )				
	1 <sup>th</sup> Cut**	2 <sup>th</sup> Cut**	3 <sup>th</sup> Cut**	4 <sup>th</sup> Cut**	Total**
Bilensoy	0.65 d	0.95 a	0.36 e	0.30 f	2.25 e
Kayseri	1.19 ab	0.86 b	0.30 e	0.34 ef	2.68 cd
Verko	0.95 bcd	0.78 cd	0.37 e	0.39 e	2.49 de
Gea	1.17 ab	0.74 de	0.30 e	0.48 d	2.68 cd
Plato	0.93 bcd	0.74 de	0.68 b	0.59 bc	2.95 bc

Victoria	1.33	a	0.85	bc	0.56	c	0.57	c	3.31	a
Emiliano	0.71	d	0.51	f	0.81	a	0.63	abc	2.66	cd
Sunter	1.08	abc	0.72	de	0.71	b	0.68	a	3.19	ab
Nimet	1.03	abc	0.73	de	0.46	d	0.57	c	2.79	cd
Başbağ	0.78	cd	0.67	e	0.57	c	0.66	ab	2.69	cd
<i>Mean</i>	<i>0.98</i>		<i>0.75</i>		<i>0.51</i>		<i>0.52</i>		<i>2.77</i>	

\*\*Mean values within same columns with different letters are statistically different  $p < 0.01$

Minerals have significant effects on both plant and animal metabolisms (Eğritaş and Aşçı, 2015). Calcium, phosphorus, magnesium, potassium, sodium, chlorine and sulphur are the most important macro minerals with significant roles in animal feeding (Kutlu et al., 2005). Phosphorus (P) contents varied between 0.363 – 0.390%, potassium (K) contents between 2.203 – 2.413%, calcium (Ca) contents between 1.453 – 1.547% and Magnesium contents between 0.257 – 0.290%. Calcium has a significant place in animal nutrition (Ayaşan, 1998). Insufficient calcium nutrition results in poor general appearance, poor bones and low live weights. Rickets may be seen in cattle, bone weakness can be seen in cows, milk yield may decrease and milk fever may be seen in dairy cows. In ruminants freely consuming legume roughages, both survival and yield Ca needs could be met (Kutlu et al., 2005; Ayaşan et al., 2012). Present Ca values were higher than the needs of ruminants (Tajeda et al., 1985). Magnesium exists in several tissues of the body. Half presents in bones and the other half presents in soft tissues and body fluids. Mg performs its function in bone formation together with Ca. Majority of animal feeds contain sufficient amount of Mg. To secure the animal needs, Mg is also supplemented at certain portions in mineral mixtures. Mg content of roughage should be between 10-15% (Kutlu et al., 2005). Phosphorus needs of cows and sheep respectively vary between 0.17 – 0.39% and between 0.16 – 0.38%. Considering these values, present phosphorus contents were found to be sufficient. Potassium deficiency is a rare case, but may be observed in beef cattle primarily fed by concentrate feed (Kutlu et al., 2005). Alfalfa hay is quite rich in Ca, Mg, K and beta carotene (Alp et al, 2016). Çaçan et al. (2015) also reported lower Ca (0.90%) and Mg (0.20%) contents and higher P (0.69%) and K (5.14%) contents than the present values.

Table 4. Variation of some quality traits in alfalfa cultivars by cuttings at the third year after planting.

Cultivars	Some Quality Traits (%)					
	ADF	NDF	P	K	Ca	Mg
Bilensoy	28.4	40.3	0.373	2.260	1.480	0.273
Kayseri	27.8	40.6	0.383	2.240	1.487	0.287
Verko	29.3	41.8	0.377	2.207	1.497	0.290
Gea	28.6	40.1	0.390	2.307	1.527	0.287
Plato	28.0	40.4	0.377	2.313	1.467	0.287
Victoria	31.0	42.2	0.373	2.303	1.473	0.267
Emiliano	28.8	41.3	0.370	2.220	1.500	0.280
Sunter	28.6	39.0	0.390	2.413	1.483	0.273
Nimet	31.0	42.6	0.377	2.403	1.453	0.257
Başbağ	29.5	39.9	0.363	2.203	1.547	0.273
<i>Mean</i>	<i>29.1</i>	<i>40.8</i>	<i>0.377</i>	<i>2.287</i>	<i>1.491</i>	<i>0.277</i>

## **Conclusions**

Alfalfa is the most commonly grown perennial forage crop in Yozgat province and Bilensoy and Kayseri are the most common cultivars produced in the province. Of the 10 experimented alfalfa cultivars in this study, Victoria and Sunter cultivars with quite higher yields were found to be quite available to be produced under ecological conditions of Yozgat province. It was also concluded that all of the experimented cultivars were sufficient in ADF, NDF and minerals.

## **References**

- Akman N., Aksoy F., Şahin O., Kaya Ç., Erdoğan Y. (2007). Turkey's animal production in the 100th year of our Republic. Turkey Breeding Cattle Breeding Association Publications No: 4, 116 s.
- Alp M., Kocabağlı N., Kahraman R., Bilal T., Akbaş İ., Demirel G., Pekel A.Y. (2016). Feed Materials and Feed Technology Book, İstanbul University, Veterinary Faculty.
- Anonymous (2015). Yozgat Provincial Directorate of Food, Agriculture and Animal Husbandry Briefing.
- Ayan İ., Acar Z., Başaran U., Önal Asçı Ö., Mut H. (2006). Determination of forage and grain yields of some (*Vicia ervilia* L.) lines in Samsun ecological conditions. *J. of Fac. of Agric.*, 21(3): 318 – 322.
- Ayaşan, T. (1998). The Effects of Dietary Calcium and Phosphorus Levels on Egg Production Traits and Egg Shell Quality in Japanese Quail. Cukurova University, Faculty of Agricultural, Department of Animal Science, Msc Thesis, Adana, TURKEY.
- Ayaşan, T., Gök, K., Asarkaya, A., Hızlı, H., Görgülü, M., Karakozak, E., Coşkun M.A., Seğmenoğlu, M.S. (2012). The effects of corn silage and sugar beet pulp on fattening performance, blood parameters and carcass characteristics of beef male calves. *Suleyman Demirel University Agricultural Faculty Journal*, 7(1): 64-73.
- Başbağ M., Demirci R., Avcı M. (2009). Determination of some agronomical and quality properties of wild alfalfa (*Medicago sativa* L.) clones in Turkey. *Food, Agriculture and Environment*, 7(2): 357 – 359.
- Başbağ M., Gül İ., Saruhan V. (2002). An investigation project on yield and adaptation of alfalfa and clover cultivars under irrigated conditions in Diyarbakır. Final Report of the TÜBİTAK-TARP-2261 Project, Ankara, 32 p.
- Çaçan E., Aydın A., Başbağ M. (2015). Determination of quality characteristics of some grasses forage crops in Bingöl University Campus. *Turkish Journal of Agricultural and Natural Sciences*, 2 (1): 105 – 111.
- Egritas O., Onal Aşçı, O. (2015). Determination of some mineral matter contents in common vetch - cereals mixtures. *Academic Journal of Agriculture*, 4(1):13 – 18.
- Gülümser A., Bozoğlu H., Pekşen E. (2006). Research and Trial Methods. Ondokuz Mayıs University Agricultural Faculty Lesson Book, Book Number, 48, 264 s, Samsun.
- Gündel F.D., Karadağ Y., Çınar S. (2014). A research on yield, quality and adaptation of some warm season perennial legumes under Çukurova ecological conditions. *Journal of Agricultural Faculty of Gaziosmanpaşa University*, 31(3): 10 – 19.
- Güngör T., Başalan M., Aydoğan İ. (2008). The determination of nutrient contents and metabolizable energy levels of some roughages produced in Kirikkale region. *Journal of Ankara Univ. Faculty of Veterinary*, 55(2): 111 – 115.

- Kavut Y.T., Çelen A.E., Demiroğlu Topçu G., Kır B. (2013). An investigation on yield and some yield characteristics of different alfalfa genotypes grown in different locations. *Ege Üniv. Ziraat Fak. Derg.*, 51(1): 23 – 29.
- Kutlu H.R., Gorgulu M., Celik L.B. (2005). *Animal Feed*. <http://www.muratgorgulu.com.tr/ckfinder/userfiles/files/GENEL%20HAYVAN%20BE%20SLEME.pdf>.
- Manga I., Acar Z., Ayan I., (2003). *Legume Forage Crops*. Ondokuz Mayıs University, Faculty of Agriculture, Lesson Book Number: 7, Turkey.
- Marsalis M.A., Hagevoart G.R., Lauriault L.M. (2014). Hay quality, sampling and testing. NM State Universty, ([http://aces.nmsu.edu/pubs/\\_circulars/CR-641.pdf](http://aces.nmsu.edu/pubs/_circulars/CR-641.pdf)).
- Mertens, D.R. (2009). Impact of NDF content and digestibility on dairy cow performance. (<http://www.wcds.ca/proc/2009/Manuscripts/ImpactOfNDFContent.pdf>)
- Soya H., Avcioğlu R., Geren H. (2004). *Yem Bitkileri, Hasad Yayıncılık*, 223 s.
- Şeker, H. (2003). Adaptation and yield trial of some new alfalfa cultivars to Erzurum Ecological condition. *Journal of Ankara Univ. Faculty of Agriculture*, 34(3): 217 – 221.
- Tajeda R., Mcdowell L.R., Martin F.G., Conrad J.H. (1985). Mineral element analyses of various tropical forages in Guatemala and their relationship to soil concentrations. *Nut. Rep. Int.* 32: 313 – 324.
- Tekçe E., Gül M. (2014). The Importance of NDF and ADF in ruminant nutrition. *Atatürk Univ. Journal of Veterinary Sciences*, 9(1): 63 – 73.
- Töngel M.Ö., Ayan İ. (2010). Nutritional content and yield performances of lucerne (*Medicago sativa* L.) cultivars in Southern Black Sea Shores. *Journal of Animal and Veterinary Advances*, 9(15): 2067 – 2073.

## EFFECT OF VARIETY AND SOWING DENSITY ON SOME MICROELEMENTS CONTENT AND GRAIN YIELD OF CHICKPEA (*Cicer arietinum* L.)

Hasan KILIÇ<sup>1\*</sup>, Mohammed Hussein AZIZ<sup>2</sup>

<sup>1</sup>Bingol university Faculty of Agriculture Field crops Department, Bingöl, Turkey

<sup>2</sup>Predatory School of Education Ministry, Halebja, Iraq

\*Corresponding author: hkilic@bingol.edu.tr

### Abstract

The objective of this study was to determine the effects of cultivars in different sowing densities on microelements iron (Fe), nickel (Ni), zinc (Zn) and sodium (Na) and grain yield of chickpea (*Cicer arietinum* L.). Field experiment was performed in research farm at the University of Bingol (Turkey) in 2016. A complete blocks design in two varieties i.e. Arda and ILC-482 were in main plots, whereas five chickpea seeding density (20, 30, 40, 50 and 60 seed m<sup>-2</sup>) were in sub plots. The results indicated that seeding densities significantly affected grain yield and Ni content while Fe, Ni and Zn were not affected significantly. Variety ILC-482 produced the maximum grain yield (86,26 kg/da) by 60 seed/m<sup>-2</sup> and Arda gave the lowest grain yield (19,80 kg/da) by 30 seed m<sup>-2</sup>. The highest Ni content has been obtained from ILC482 variety (6.66 ppm) and the lowest Ni content has been obtained from Arda variety (6.20 ppm).

**Keywords:** Chickpea, microelements, seeding density, variety

### Introduction

Chickpea (*Cicer arietinum* L.) is an annual grain legume or pulse crop sold into human food markets. Chickpea is the third most important food legume crop and India is the largest producer contributing to 65% of world's chickpea production (FAOSTAT, 2012). According to Akhtar and Siddiqui (2009) during last decade the production of chickpea have declined. Its foundation is believed to be in south-eastern Turkey neighboring Syria and Iran (Ladizinsky, 1975). The earliest residue of chickpea seeds date back to around 7000 B.C in Syria and Turkey. In Turkey, it occupies about 388.518 hectare area with production of 450.000 tonnes and an average productivity of 1158.2 kg ha<sup>-1</sup> (TUIK 2014). In spite of the importance of this crop in human daily diet and in agricultural production, productivity of this crop is low in Turkey. Hulse (1991) reported that legume is one of the oldest groups of agricultural plants and food legumes are the second most important human's food supply after the cereal grains, which their grain contain 38 to 59% carbohydrate, 4.8 to 5.9% oil, 3% ash, 3% fiber, 0.2% calcium, and 0.3% phosphorus. In general, pulse crops contain a range of nutrients including low digestible carbohydrates, protein, essential amino acids, fatty acids, and a range of micronutrients (Bhatty, 1988). Bueckert et al (2011) reported that chickpea seeds contained from 29 to 52 mg/kg Zn, 77–112 mg/kg Fe, 1,448–2,457 mg/kg Mg, 1,211–2,457 mg/kg Ca, to 3.8–9.0 mg/g phytic acid. Cereals like wheat and rice combined with pulses are major dietary components for billions of people, and the potential for microelement biofortification of pulses is high. Chickpea is an important source of microelements like Fe, Zn, Mg, and Ca in vegetarian diets (Abbo et al., 2000; Ereifej et al., 2001). Whereas, limited information is available on chickpea (*Cicer arietinum* L.) mineral biofortification. Micronutrient concentrations in the pulse lentil may vary depending on the geographical location, plant genotype, soil factors, temperature, and other growing season conditions (Thavarajah et al.,



2010; Bueckert et al., 2011). The use of high plant density in chickpea production decreases soil water evaporation late in the growing season when plant cover closure is low. In difference, low plant density may allow weeds to grow more aggressively and limit crop yield possible. Plants grown at lower plant density are usually shorter and branchy, which increases losses during combine harvest (Turner et al., 2001). In a study in Canada, a plant population density of 55 plants m<sup>-2</sup> produced a 23% to 49% seed yield above that of the recommended plant population density of 44 plants m<sup>-2</sup> (Vanderpuye, 2010). Plant population is a type component of the production of chickpea. The yield of chickpea can be improved by planting of best density of chickpea cultivars. The objectives of this study were to determine the effect of plant density and varieties on grain yield and some microelemnts characteristics of chickpea under agro-climatic conditions of Bingol, Turkey.

### Materials and Methods

The present study was conducted throughout spring season in 2016 at the research experiment field of the Bingol University (Turkey) located at 38° 48 N latitude and 40° 32 E longitude (10 km South Bingol) and at an altitude of 1090 m. Experimental field location receives annual rainfall of 938 mm. During the study in 2016, the lowest minimum temperature was fell down below to -5.6 °C in January. Total rainfall level of 2016 is lower than the total precipitation level of previous years. But during the first half of 2016, the total of precipitation was higher than the previous years. The amount of rainfall on the chickpea products was 98.4 mm (Figure 1, Figure 2 and Figure 3). The soil of experiment field is loamy, with contents of organic matter of around 1.9% and pH 6.57. Microelement values were taken from Demir (2016). The soil analysis result for physical and chemical characteristic of the study area are given in Table 1.

Table 1. Soil analysis result for physical and chemical characteristic of the study area

Soil depth	Soil texture	pH	Salt Content	Organic Matter	P <sub>2</sub> O <sub>5</sub>	K <sub>2</sub> O	Lime	Fe	Zn	Na
Cm			%	%	Kg/ha		%	ppm		
0-30	Loam	6.57	0.0315	1.905	7.91	24.51	0.36	14.15	0.33	0.78

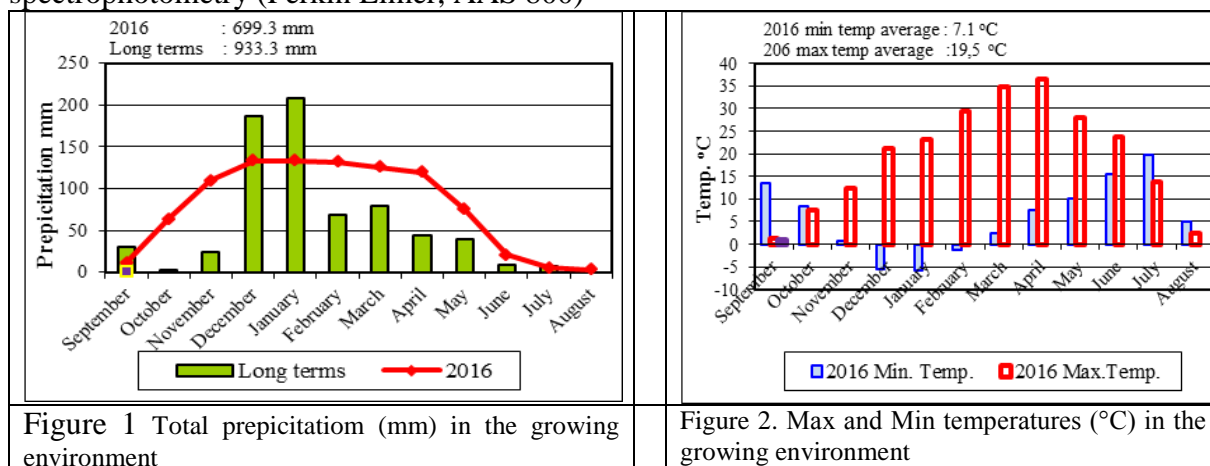
Two registred cultivars kabuli type(Arda and ILC-482) , adapted to South Eastern Anatolia Turkey were chosen with a morphological traits (Table 2). The seeds were drilled 5-8 cm deep in previously opened furrows on 05th April 2016. In this study, the whole dose of P (6 kg P da<sup>-1</sup>) with half of dose of nitrogen (5 kg N da<sup>-1</sup>) were applied at sowing time and the remaining nitrogen (5 kg N da<sup>-1</sup>) was top-dressed as Ammonium nitrate (%33) with flowering time on 26 July.2016. Rhizobium bacteria nodules were not observed in the roots of chickpea parsels. Weeds were controlled by hand after germination.

Table 2. Name and geographical origins of investigated cultivars

Cultivar	Plant height cm	First pod height cm	100 kernel wight g.	Plant type	Origin
Arda	64-85	33-37	34-40	Erect	GAPUTAEM
ILC-482	40-45	20-26	28-31	Semi-prostrate	GAPUTAEM

**Experimental design and management:** Two factorial trial was set up as a split-plot design (RCBD) with two comparing chickpea varieties (Arda and ILC-482) as main plots and fiwe seed densities (20, 30, 40, 50 and 60 seed m<sup>-2</sup>) as split-plots. The main plots were randomised in a block design with three replications. The density treatments were randomised in the main plots. Each variety was sown in four-row plots of 5 m length with between- and within-row spacing of 30 cm. Plot size was 1.2 m x 5 m (6 m<sup>2</sup>). Spacing of 0.4 m and 1 m were allocated between plots and blocks, respectively

**Microelemnts analysis:** Fe, Ni, Zn and Na compositions of whole chickpea flour were determined by the method of Hwang et al.(1997) and; Choi et al. (2013) with slight modifications. One gram of chickpea flour was wet-digested in a mixture solution of HNO<sub>3</sub>(10 ml) and H<sub>2</sub>SO<sub>4</sub> (10 ml) with heating on a hot plate. After extraction cooled, in hood opening carefully to pass the gas and put it to another tub that contain nearly 5ml of distilled water slowly and completed to 25ml by distilled water. This solution was ready for using to determine elements. Fe, Ni and Zn minerals determined by atomic absorption spectrophotometry (Perkin Elmer, AAS 800)



**Statistical Data Analysis:** Results were evaluated to analysis of variance SAS (Statistical Analysis Systems) program (SAS Institute 1999) and mean separation was performed by Fisher’s least significant difference (LSD) test when F test was significant at P<0.05. Regression analysis was conducted to estimate linear and quadratic effects of plant density when results of the analysis of variance indicated these effects were significant at P<0.05.

### Results and Discussion

Table 3. Analysis of variance of grain yield (kg/da) of different chickpea varieties and densities.

Sources	DF	Mean Squares				
		Grain yield	Fe	Ni	Zn	Na
Replication	2	15.2629	4,6972	0,1256	0,8051	1,6032
Variety	1	8768 *	25,5948 ns	1,6147*	2,0981 ns	2,5667 ns
Replication*variety&Random (Error1)	2	90.035	6,8840	0,0045	1,3785	4,54870
Density	4	958.483**	2,4586 ns	0,0753 ns	0,7354 ns	0,3814 ns
Variety*density	4	407.078**	1,4538 ns	0,0994 ns	1,7764*	0,5810 ns
Error-2	16	61.24	2,5505	0,0896	0,5715	1,8078

\*: Significance at 5 % probability, \*\*Significance at 1 % probability, ns = non-significant

**Grain yield (kg/da):** Table 3 and Table 4 revealed that there were highly significant (P<0.01) differences among the varieties and seed densities. The interaction between the two factors was, however, significant. Variety ILC-482 produced the maximum grain yield (86,26 kg/da) by 60 seed/m<sup>2</sup> and Arda gave the lowest grain yield (19,80 kg/da) by 30 see/m<sup>2</sup>. Gan *et al.* (2003) concluded that increasing yield of chickpea at high density and they found strong positive relationship between seed yield and plant population densities. Bahr (2007) also noticed that high plant density (50 plants m<sup>-2</sup>) gave higher seed yield as compare to low plant density (26 plants m<sup>-2</sup>) in chickpea. Grain yield was increased with increasing in seed density

was presented by regression equation in Figure 4 and Figure 5. These results were in line with those of Valimohammadi et al. (2007) reported that plant density has no significant effect on yield. While, Shamsi (2011) and Gana et al. (2007) reported that density does not have a significant effect on yield of chickpea. Regression analysis revealed that the grain yield increased linearly ( $R^2 = 0.48, 0.82$ ) with seed rate for Arda and ILC-482 (Figure 4 and Figure 5).

Table 4. Effect of planting density and variety on the grain yield, Fe, Ni, Zn and Na contents of chickpea

Traits	Cultivars	Densities (Seeds m <sup>-2</sup> )					Means
		20	30	40	50	60	
Grain yield kg/da	Arda	22.48 de	19,80 e	24,43 de	25,69 de	33,41cd	<b>25,16 B</b>
	ILC-482	32.71 cde	46,02 c	62,86 b	68,93 b	86,26 a	<b>59,36 A</b>
	Means	<b>27.59 C</b>	<b>32.91 C</b>	<b>43.64 B</b>	<b>47.31 B</b>	<b>47,31 B</b>	<b>59,84 A</b>
Fe (ppm)	Arda	3.73	3.78	3.14	5.99	4.31	<b>4.19</b>
	ILC-482	5.82	5.62	6.00	6.20	6.53	<b>6.03</b>
	Means	<b>4.77</b>	<b>4.70</b>	<b>4.57</b>	<b>6.09</b>	<b>5.42</b>	
Ni (ppm)	Arda	6.30	6.21	5.85	6.1 5	6.48	<b>6.19 B</b>
	ILC-482	6.56	6.63	6.69	6.73	6.69	<b>6.66 A</b>
	Means	<b>6.43</b>	<b>6.42</b>	<b>6.27</b>	<b>6.44</b>	<b>6.59</b>	
Zn (ppm)	Arda	3,57 ab	3,56 ab	1,91 b	3,32 ab	3,84 ab	<b>3.24</b>
	ILC-482	4,30 a	3,17 ab	4,08 ab	3,98 ab	3,30 ab	<b>3.76</b>
	Means	<b>3.94</b>	<b>3.37</b>	<b>2.99</b>	<b>3.65</b>	<b>3.57</b>	
Na (ppm)	Arda	3.67	3.7 8	3.85	4.25	4.67	<b>4.04</b>
	ILC-482	4.73	5.03	4.10	4.89	4.38	<b>4.62</b>
	Means	<b>4.20</b>	<b>4.40</b>	<b>3.96</b>	<b>4.57</b>	<b>4.53</b>	

\*:Means within columns or rows with the same letters are not significantly different at 5% level.

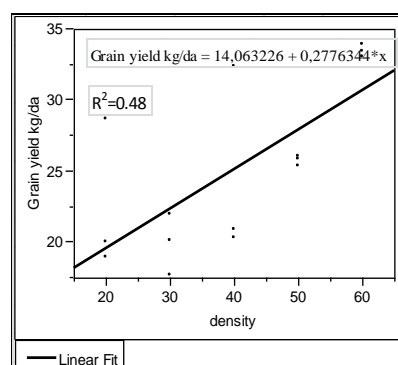


Figure 4. Regression of grain yield of variety Arda with different seed on densities

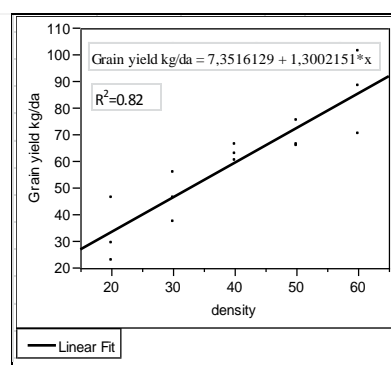


Figure 5. Regression of grain yield of variety ILC-482 with different seed on densities

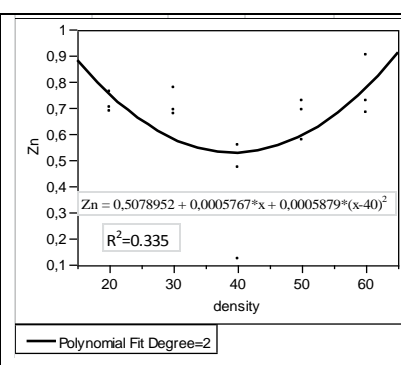


Figure 6. Regression of Zn content of variety Arda with different seed on densities

1

**Extraction minerals seeds component:** Chickpea (*Cicer arietinum* L.) belonging to the family Leguminosae, is one of the world's most important pulse crops. Chickpea seeds are nutrient-dense foods providing rich content of protein and certain dietary minerals such as iron and phosphorus, thiamin, vitamin B6, magnesium and zinc contents are also present in Khatoon and Prakash (2004). The chickpea is a good source of protein and carbohydrate and its protein quality is better than other legumes such as pigeon pea, black gram and green gram. It also supply some minerals (Ca, Mg, Zn, K, Fe, P) and vitamins like thiamine and niacin (Vilche et al. 2003). In our study researched and foundation percentage of (ppm) some metal such as (Fe, Ni, Na and Zn).

**Iron (Fe):** In this study, variety, density and interaction ( $P < 0.05$ ) had non significant effect on Fe elemen. The summerised Fe values are showed in Table 3 and Table 4. It was observed

that the concentration and peak intensity value of iron (Fe) element. The highest value has been obtained from ILC-482 (6.53 ppm) by 60 seed m<sup>-2</sup>. The lowest value of Fe has been obtained from Arda variety (3.14 ppm) by 40 seed m<sup>-2</sup>. Haytowitz and Matthews (1983) reported that cooking in boiling water caused great losses of K (24%), Cu (15%) and Fe (8%). According to regression analyses, there was neither linear nor quadratic relationship between Fe content and seed rate for both cultivars.

**Nickel (Ni):** The results of the (Ni) element are presented in Table 3 and Table 4. The main effect of variety was significant ( $P < 0.05$ ) but density and interaction had non significant. In our study was working in laboratory center in Bingol university to finding coverage of Ni element contain. The highest value has been obtained from ILC-482 (6.73 ppm) by 50 seed m<sup>-2</sup>. The lowest number has been obtained from Arda variety was (5.85 ppm) by 40 seed m<sup>-2</sup>. Micronutrient availability for the plant depends, among other factors, texture organic matter and mainly soil (Ali et al., 2002). According to regression analyses, there was neither linear nor quadratic relationship between Fe content and seed rate for both cultivars.

**Zinc (Zn):** The results of variance analysis of Zn element value of different sample chickpea seed varieties are given in Table 3 and Table 4. The main effects of variety and the interaction effects of variety x density had non-significant influence on the Zn element. Table 39 and Table 40 suggests that the highest average of Zn has been obtained ILC-482 variety (4.30 ppm) by 20 seed m<sup>-2</sup>. Whereas, the lowest value was obtained Arda variety (1.91 ppm) by 40 seed m<sup>-2</sup>. Zn plays an important role in plant reproductive development for initiation of flowering, floral development, male and female gamete genesis, fertilization and seed development (Liu et al., 2005). (Khan, 1998; Ahlawat et al., 2007). A comparison between several crop species has shown that chickpeas more sensitive to Zn deficiency than cereal and oil seeds. Arda showed a quadratic trend ( $R^2 = 0.335$ ) for Zn content for the different seeding rates. while regression equation was not significant in ILC-482 (Figure 6)

**Sodium (Na):** The results of the Na element are presented in Table 3 and Table 4. The main effect of variety, density and interaction had nonsignificant effect by ( $P < 0.05$ ). The highest Na value of chickpea has been obtained from ILC-482 variety (5.03 ppm) in 30 seed m<sup>-2</sup>. While, the lowest value of Na has been obtained from Arda variety (3.67 ppm) by 20 seed m<sup>-2</sup>. (Ali et al., 2002). Micronutrient availability for the plant depends, among other factors, texture, organic matter and, mainly, soil pH. Micronutrient availability for the plant depends, among other factors, texture, organic matter and mainly soil pH. According to regression analyses, there was neither linear nor quadratic relationship between Fe content and seed rate for both cultivars.

### **Conclusion**

The results of the present research showed that maximum yield of grain was observed with ILC-482 related to 60 seed/m<sup>-2</sup> density. The main effects of variety and the density had non significant influence on the Fe, Zn and Na elements, except Ni. However, density x variety interaction was significant only in Zn element.

### **References**

- Akhtar, M. A. and Siddiqui, Z. A. (2009). Effects of phosphate solubilising microorganisms and Rhizobium sp. On the growth, nodulation, yield and root rot disease complex of chickpea under field condition. *African Journal of Biotechnology*. 8 (15): 3489-3496.
- Bhatty, R. S. (1988). Composition and quality of lentils (*Lens culinaris Medik*): A review. *Canadian Institute of Food Science and Technology Journal*, 21(2), 144-160.

- Bueckert RA., Thavarajah D., Thavarajah P and Pritchard J. (2011). Phytic acid and mineral micronutrients in field-grown chickpea (*Cicer arietinum* L.) cultivars from western Canada. *Eur Food Res Technol.* 233:203–212.
- Thavarajah D, Thavarajah P, See C-T, Vandenberg A (2010) Phytic acid and Fe and Zn concentration in lentil (*Lens culinaris* L.) seeds is influenced by temperature during seed maturation period. *Food Chem* 122:254–259
- Ereifej KI, Al-Karaki GN, Hammouri MK (2001) Seed chemical composition of improved chickpea cultivars grown under semiarid Mediterranean conditions. *Int J Food Prop* 4:239–246
- Abbo S, Grusak MA, Tzuk T, Reifen R (2000) Genetic control of seed weight and calcium concentration in chickpea seed. *Plant Breeding* 119:427–431
- SAS Institute (1999). SAS/STAT user's guide. 8. Version. SAS Institute Inc. Cary. NC.
- Ahluwat, I.P.S., Ganiyah B., ASHRAF Zadid M, (2007). Nutrient management in chickpea. In: Chickpea breeding and management (Yadav S.S., Redden R., Chen W., Sharma B., eds). CAB International, Wallingford, Oxon, United Kingdom. pp. 213-232..
- Ali, M,Y, Krishnamurthy L, Saxena N.P, Rupelao.P, Kumar J, Johansen C. (2002). Scope for genetic manipulation of mineral acquisitions in chickpea. *Plant Soil* 245:123-134.
- Bahr, A.A. (2007). Effect of Plant Density and Urea Foliar Application on Yield and Yield Components of Chickpea (*Cicer arietinum*). *Research Journal of Agriculture and Biological Sciences*, 3(4): 220-223.
- Choi, I, Kang, C.S, Hyun, J.N, Lee and Park. (2013). Mineral Compositions of Korean Wheat Cultivars *Prev Nutr Food Sci.* Sep; 18(3): 214–217.
- Demir, Y. (2016). The hydraulic properties determination and soil classifying of formed soils on different physiographic units of Bingol plain PH Thesis. Atatürk University Institute of Sciences, Soil Science department Erzurum.
- FAOSTAT (2002). Statistical data bases and data-sets of the Food and Agriculture Organization of the United Nations. <http://faostat.fao.org/default.aspx>
- Gana, D. Bruce, L. Gossenb, F. Greg orda, B. Sabine, Cultivar type, plant population, and ascochyta blight in Chickpea, *Agron. J.* 99 1463-1470 , 2007.
- Haytowitz DB, Matthews RH (1983) Effect of cooking on nutritive retention of legumes. *Cereal Food World (USA)* 28: 326–364.
- Hulse JH (1991) Nature composition and utilization of grain legumes. p11-27 In Uses of tropical Legumes Proceedings of a Consultants' Meeting 27-30 March 1989 ICRISAT Center. Patancheru, India. Institute pp. 50-51
- Hwang JB, Yang MO, Shin HK (1997) Survey for approximate composition and mineral content of medicinal herbs. *Korean Jour. of Food Science and Technology* 29(4):671-679
- Khan, H.R. (1998). Responses of chickpea *Cicer arietinum* L. to zinc supply and water deficits. PhD thesis. Department of Plant Science, University of Adelaide, Osmond, South Australia, Australia.
- Khaton, N, and Prakash, J. (2004). Nutritional quality of microwave-cooked and pressure-cooked legumes, *Int J Food Sci Nutrition*, 55 (6): 441-448.
- Ladizinsky, G. A (1975). New *Cicer* from Turkey. *Notes from the Royal Botanic Gardens, Edinburgh*, 34:201–202.
- Liu PP, Koizuba N, Martin RC Nonogaki H (2005) The BME3 (Blue Micropylar End 3) GATA zinc finger transcription factor is a positive regulator of Arabidopsis seed germination. *The Plant Journal* 44(6): 960-971
- Shamsi, K, Kobraee, S, Rasekhi B (2011). The effects of different planting densities on seed yield and quantitative traits of rainfed chickpea (*Cicer arietinum* L.) varieties. *Afr. J. Agric. Res.*, 6(3): 655-659.

- Turner, N.C, Wright G.C. Siddique, K.H.M. (2001). Adaptation of grain legumes (pulses) to water-limited environments *Adv .Agron* 71:193-231.
- TUIK, (2014). Turkish Statistical Institute. Date of acces: 21.01.2017.[http://www.tuik.gov.tr/PreTablo.do?alt\\_id=1001](http://www.tuik.gov.tr/PreTablo.do?alt_id=1001)
- Vanderpuye, A.W. (2010). Canopy architecture and plant density effect in short-season Chickpea *Cicer arietinum*. A Thesis submitted to the College of Graduate Studies and Research for the Degree of Doctor of Philosophy, University of Saskatchewan.
- Valimohammadi F. Tajbakhsh M and Saed A. (2007). Comparison winter and spring sowing dates and effect of plant density on yield, yield components and some quality, morphological traits of chickpea (*Cicer arietinum* L.) under environmental condition of Uremia, Iran. *J. Agron.* 6:571-575.
- Vilche, C, Gely, M., Santall, E. (2003). Physical properties of quinoa seeds. *Biosys. Eng.* 86:59-65

## PRODUCTION POTENTIAL AND DEVELOPMENT OPPORTUNITIES OF HAZELNUT (*Corylus avellana* L.) IN TURKEY

Mikdat ŞİMŞEK<sup>1\*</sup>, Abdurrahman KARA<sup>2</sup>

<sup>1</sup>Department of Horticulture, Faculty of Agriculture, Dicle University, Diyarbakir, Turkey

<sup>2</sup>Department of Soil Science and Plant Nutrition, Faculty of Agriculture, Dicle University, Diyarbakir, Turkey

\*Corresponding author: mikdat.simsek@dicle.edu.tr

### Abstract

Hazelnut (*Corylus avellana* L.) is one of the oldest cultivated agricultural products. Anatolia is the gene centre of hazelnut. The richness of our country on genetic variation of this species provides facility for achievement in breeding studies in a short period of time. Because this fruit is cultivated on some regions of Anatolia, it is extremely important to develop cultivars proper for some regions. Turkey is the largest producer and exporter of hazelnut in the world. The world has 713.451 tons of total hazelnut production. According to 2015 statistics Turkey has 646.000 tons of total hazelnut production. Considering the total hazelnut production by the Regions in Turkey, East Blacksea and Marmara regions rank first and second with 353.427 and 161.905 tons of hazelnut productions respectively as West Blacksea Region is the third with a production of 130.114 tons. Considering the total hazelnut production of the provinces in the our country, Ordu and Giresun provinces rank first and second with 200.938 and 105.023 tons of hazelnut productions respectively as Kütahya province comes last with a production of only 2 tons. In this study, through presenting the existing status of the hazelnut production of Turkey, it was aimed to increase the awareness and set light to decision makers for making use of and directing the existing potential in future plans of our country.

**Key words:** *Hazelnut, Production potantial, Development opportunities, Turkey.*

### Introduction

Turkey has a large potential of fruit species and fruit production (Simsek and Kara, 2016). It is a gene centre for many fruit species such as apricots, figs, hazelnuts, almonds, walnuts, pomegranates, pistachio, apple and cherry. According to archaeological research, It has been known that many fruit species were grown in Anatolia a few thousand years ago (Ozbek, 1975; Bostan and Islam, 1999; Gercekcioglu *et al.*, 2014). The total annual world hazelnut production is about 736.946 tons (reference needed). Turkey is the most significant country of the world in terms of hazelnut production (450.000 tons). After Turkey, Italy, Georgia, USA, Azerbaijan and China produce 37.400, 32.659, 29.796 and 23.520 tons of hazelnut annually, respectively (FAO, 2014). But, according to the data of 2015, Turkey's hazelnut production is reported to be 646.000 tons (TUIK, 2015). Hazelnut (*Corylus avellana* L.) belong to order *Fagales* and family *Betulaceae*. This species can grow up to 6-7 meters in damp and cool ecological conditions but 2-2.5 meters in arid south-facing land (Doganay, 1991). Traditionally, hazelnut is one of the commercially important fruit species grown for domestic consumption as a food, raw material for industry and export (Dizdaroglu, 1985). This important nut has been grown for about 2500 years in Eastern Black Sea Region of Turkey (Kayalar and Ozcelik, 2012). In this study, through presenting the existing status of the hazelnut production of Turkey, it was aimed to increase the awareness and set light to decision makers.

### Some Important Hazelnut Cultivars in Turkey

Hazelnut cultivars such as Tombul, Palaz, Çakıldak, Foşa, Mincane, Sivri, Kalinkara, İncekara, [Allahverdi](#), [Acı](#), [Kan](#), [Yassı Badem](#) and [Yuvarlak Badem](#) are grown in Turkey (HRID, 2017). However, hazelnut production in Turkey is mostly based on cultivars such as Tombul, Palaz, Çakıldak, Foşa, Mincane, Sivri and Kalinkara (Balık *et al.*, 2015).



**Figure 1.** Kalinkara cultivar (Anonim, 2017a).



**Figure 2.** Tombul cultivar (Anonim, 2017b).





**Figure 3.** Allahverdi cultivar (Anonim, 2017c).

### Hazelnut Production Potential of Turkey by Regions

Hazelnut production potential of the regions was given in Table 1. According to this Table, climatic conditions of the Southeast Anatolia region is not suitable for hazelnut cultivation.

Eastern Black Sea was the most significant region of Turkey in terms of hazelnut production (353.427 tons). Marmara, Black Sea and Mediterranean regions produce 161.905, 130.114 and 376 tons of hazelnut, annually, respectively (TUIK, 2015) as Central Anatolia region ranks the last with respect to hazelnut production (17 tons).

On the other hand, Aegean was the most significant region of Turkey in terms of hazelnut yield (10.92 kg/tree). After Aegean, Mediterranean, and Central Anatolia and Eastern Anatolia regions have 10.20 kg/tree and 10.00 kg/tree of hazelnut, respectively (TUIK, 2015). Eastern Black Sea region is the last place with respect to hazelnut yield (1.61 kg/tree).

**Table 1.** Hazelnut trees' numbers and production of Turkey's regions (TUIK, 2015).

Regions	Area covered by bulk fruit (ha)	Production (ton)	Average yield per tree (kg)	Number of fruitful trees	Total number of trees
Aegean	4.5	51	10.92	4.670	6.650
Mediterranean	67.4	376	10.20	36.848	43.410
Central Anatolia	2.9	17	10.00	1.700	2.710
Eastern Anatolia	400	110	10.00	11.000	35.000
West Blacksea	132.195	130.114	1.94	67.232.447	72.067.621
Eastern Blacksea	422.718	353.427	1.61	219.632.423	222.371.260
Marmara	147.240	161.905	2.27	71.228.790	71.486.056
Turkey	702.628	646.000	1.80	358.147.878	366.012.707

### Hazelnut Production Potential of Some Important Provinces in Turkey

Hazelnut production is carried out in 29 provinces, which are Afyon, Antalya, Amasya, Artvin, Bitlis, Çanakkale, Bursa, Bilcik, Bolu, Bartın, Düzce, Giresun, Gümüşhane, Istanbul, Isparta, Kahramanmaraş, Kastamonu, Kütahya, Kocaeli, Sakarya, Sivas, Sinop, Samsun, Ordu, Rize, Yalova, Zonguldak, Tokat and Trabzon, of Turkey. Eleven province of Turkey have more than 5000 tonnes of hazelnut production capacities (Table 2). Ordu was the most significant province of Turkey in terms of hazelnut production (200.938 tons). After Ordu, Giresun, Samsun and Sakarya produce 105.023, 90.857 and 82.708 tons of hazelnut, annually, respectively (Table 2). Kütahya province is the last place with respect to hazelnut production (2 tons) (TUIK, 2015). Ordu was the most significant province of Turkey in terms of number of hazelnut's trees (121.514.355). Ordu province was followed by Giresun, Samsun and Sakarya provinces with 59.551.900, 42.994.955 and 35.910.420 trees of hazelnut, annually, respectively (Table 2). Afyon province is the last place with respect to hazelnut trees (250 trees) (TUIK, 2015).

**Table 2.** Hazelnut Production Potential of Some Important Provinces in Turkey.

Provinces	Area covered by bulk fruit (ha)	Production (t)	Average yield per tree (kg)	Number of fruitful trees	Total number of trees
Artvin	8.665	6.314	2.32	2.721.150	2.814.260
Bartın	6.000	6.765	1.82	3.720.000	3.810.000
Düzce	62.685	69.344	2.17	31.978.800	31.991.657
Giresun	117.111	105.023	1.76	59.551.900	60.540.595
Kastamonu	7.471	5.213	1.79	2.907.980	3.280.644
Kocaeli	8.062	7.530	3.74	2.015.756	2.035.894
Sakarya	72.598	82.708	2.30	35.910.420	36.063.420
Samsun	90.623	90.857	2.11	42.994.955	46.470.880
Ordu	227.183	200.938	1.65	121.514.355	121.556.855
Zonguldak	23.593	22.572	1.43	15.813.152	16.410.427
Trabzon	65.350	39.126	1.15	33.954.918	35.563.200

### Development Opportunities of Hazelnut in Turkey

1. Hazelnut producers need to develop policies to get the expected profit from shell nuts together with production plans for domestic consumption and exports
2. Hazelnut producers need to make regular cultural processes to reduce profit inefficiency
3. Authorized institutions need to reform nut subsidy purchases and subsidy pricing policies.
4. Nut yield and quality will increase in case of more contribution to scientific research and will made a positive contribution to the economy both hazelnut producers and the country
5. Hazelnut plantation owners at the active age and dependent on hazelnut for the livelihood, and resident in the village, should be given first priority in support payments to keep them in their own places.
6. It is necessary to speed up the breeding works to develop new hazelnut varieties to be suitable for different ecological conditions and breeding systems.
7. Excessive amounts of hazelnut production should be avoided and forest land should be protected.

8. Necessary measures should be taken and timely and regularly done to prevent *Xanthomonas arboricola* pv. *Corylina*, *Botrytis cinerea*, *Xyleborus dispar* (Fabricius), *Lymantria coryli* (Perris), and to control printer insects and aflatoxin in hazelnut.
9. Technical and scientific studies must be done to reduce input cost
10. In order to expand the use range of hazelnut products, exporters should support and encourage policies in export procedures.
11. Producer associations and cooperatives must be established and the existing ones need to be strengthened to sell their products properly of hazelnut producers.
12. In order to achieve good quality production, hazelnut producers should consider the quality certification.
13. Hazelnut producers have to make agricultural insurance for the loss of natural disasters.

### Conclusion

Supply-demand balance should be monitored in hazelnut potential production. Therefore, hazelnut producers should act in cooperation with other institutions and organizations, for example, faculties of agriculture and other colleges and institutes of the universities, under the coordination of provincial governors.

### References

- Anonymous, (2017a). Kalinkara cultivar. [https://www.google.com.tr/search?q=Kal%C4%B1nkara+f%C4%B1nd%C4%B1k+%C3%A7e%C5%9Fit&rlz=1C1CHWA\\_trTR616TR617&tbm=isch&imgil=t03VFgYQLXBIOM%253A%253BYfy2PFYvJOGkDM%253Bhttp%25253A%25252F%25252Ffarastirma.tarim.gov.tr%25252Ffindik%25252FSayfalar%25252FDetay.aspx%25253FSayfaId%2525253D10&source=iu&pf=m&fir=t03VFgYQLXBIOM%253A%252CYfy2PFYvJOGkDM%252C\\_&usg=\\_\\_Lb4\\_fzZ2rsQUKpzXcgF714Dwac%3D&biw=1366&bih=638&ved=0ahUKEwjHhJ7KvKvUAhWGIIAKHbW9CyMQyjcIQQ&ei=aM43WcewFIbFwAK1-66YAg#imgcr=t03VFgYQLXBIOM](https://www.google.com.tr/search?q=Kal%C4%B1nkara+f%C4%B1nd%C4%B1k+%C3%A7e%C5%9Fit&rlz=1C1CHWA_trTR616TR617&tbm=isch&imgil=t03VFgYQLXBIOM%253A%253BYfy2PFYvJOGkDM%253Bhttp%25253A%25252F%25252Ffarastirma.tarim.gov.tr%25252Ffindik%25252FSayfalar%25252FDetay.aspx%25253FSayfaId%2525253D10&source=iu&pf=m&fir=t03VFgYQLXBIOM%253A%252CYfy2PFYvJOGkDM%252C_&usg=__Lb4_fzZ2rsQUKpzXcgF714Dwac%3D&biw=1366&bih=638&ved=0ahUKEwjHhJ7KvKvUAhWGIIAKHbW9CyMQyjcIQQ&ei=aM43WcewFIbFwAK1-66YAg#imgcr=t03VFgYQLXBIOM)
- Anonymous, (2017b). Tombul hazelnut. [https://www.google.com.tr/search?q=Tombul+f%C4%B1nd%C4%B1k&rlz=1C1CHWA\\_trTR616TR617&espv=2&biw=1517&bih=708&source=lnms&tbm=isch&sa=X&ved=0ahUKEwim7\\_rst5rSAhVGAZoKHX1xAtAQ\\_AUIBigB#imgcr=ihc0sAoVvIwJPM](https://www.google.com.tr/search?q=Tombul+f%C4%B1nd%C4%B1k&rlz=1C1CHWA_trTR616TR617&espv=2&biw=1517&bih=708&source=lnms&tbm=isch&sa=X&ved=0ahUKEwim7_rst5rSAhVGAZoKHX1xAtAQ_AUIBigB#imgcr=ihc0sAoVvIwJPM)
- Anonymous, (2017c). Allhverdi cultivar. [https://www.google.com.tr/search?q=Allahverdi+f%C4%B1nd%C4%B1k+%C3%A7e%C5%9Fidi&rlz=1C1CHWA\\_trTR616TR617&tbm=isch&tbo=u&source=univ&sa=X&ved=0ahUKEwiQ9MaWu6vUAhXLJ1AKHetXBawQsAQIOA&biw=1366&bih=638#imgcr=ReM7xFCosdCeXM](https://www.google.com.tr/search?q=Allahverdi+f%C4%B1nd%C4%B1k+%C3%A7e%C5%9Fidi&rlz=1C1CHWA_trTR616TR617&tbm=isch&tbo=u&source=univ&sa=X&ved=0ahUKEwiQ9MaWu6vUAhXLJ1AKHetXBawQsAQIOA&biw=1366&bih=638#imgcr=ReM7xFCosdCeXM)
- Balık, H.İ., Balık, S.A., Okay, A.N. (2015). Yeni findık çeşitleri (Okay 28 ve Giresun Melezi). *Harran Tarım ve Gıda Bilimleri Dergisi*, 19 (2): 105-110.
- Bostan, S.Z., Islam, A. (1999). Determination of interrelationships among important nut quality characteristics on Palaz and Sivri Hazelnut cultivars by Path Analysis. *Tr. J. of Agriculture and Forestry*, 23 (4): 371-375.
- Dizdarogly, T. (1985). Economic evaluation of peach, apricot, and plum growing in Menemen district of Izmir (PhD Thesis). Aegean University Science Institute, Izmir-Turkey.
- Doganay, H. (1991). Agricultural Geography. Ata. U. Faculty of Science and Literature, Geography Department Lecture Notes, 23, Erzurum-Turkey.
- HRID, (2017). Hazelnut Research Institute Directorate <http://arastirma.tarim.gov.tr/findik/Menu/47/Findik-Cesitlerimiz>.

- FAO, (2014). Food and Agriculture Organization (FAO).  
<http://www.fao.org/faostat/en/#data/QC>.
- Gerçekcioglu, R., Bilgener, S., Soylu, A. (2014). General orcharding (Principles of Fruit Growing). NOBEL Academic Publishing, Improved 4th Edition, Istanbul, 498 p.
- Kayalar, S., Özçelik, A. (2012). The impact of supporting the increase of hazelnut production areas in Turkey. *Alinteri*, 23 (B): 1-11.
- Ozbek, S. (1975). General orcharding. C.U, Agricultural Faculty Publications, Adana, 386 p.
- Simsek, M., Kara, A. (2016). Diyarbakir fruit growing potential an overview. International Diyarbakir Semposium 2-5 October 2016, Diyarbakir-Turkey (in press).
- TUIK, (2015). Turkish Statistical Institute (TÜİK)  
<https://biruni.tuik.gov.tr/bitkiselapp/bitkisel.zul>.

## YIELD AND BIOCHEMICAL DIFFERENCES OF CAULIFLOWER (*Brassica oleracea* L. cv. *Botrytis*) UNDER DIFFERENT IRRIGATION LEVELS

Okan ERKEN\*, Murat YILDIRIM

Canakkale Onsekiz Mart University, Faculty of Agriculture, Department of Irrigation and Farm Structures,  
Canakkale 17100, Turkey.

\*Corresponding author: oerken@comu.edu.tr

### Abstract

Generally, winter vegetables are transplanted at the time when the irrigation water is deficit, so that, the plants may be exposed to drought stress at the beginning of development periods. For this reason, the effects of different irrigation applications on morphological and biochemical changes in cauliflower were investigated in the field conditions. Research was conducted in Dardanos research and application center at Canakkale Onsekiz Mart University in 2015 between July and October. Irrigation levels were applied at intervals of 4 days according to the changes determined from the class-A pan evaporation chamber. Irrigation levels are control (I1.0), which the amount of evaporation applied, mild stress which the 70% amount of evaporation applied (I0,70), severe stress which the 30% amount of evaporation applied (I0,70) and the waterless (I0) which no any irrigation applied to the plants until the harvest. The amount of seasonal irrigation water applied to treatments varied between 46.8 and 360.9 mm. The effects of irrigation water applied in different quantities on yield, some quality parameters and some physiological effects were evaluated statistically. According to the results obtained, reducing sugar and total sugar levels increased with the increasing stress. On the other hand, it has been determined that the changes in the amounts of some organic acids are significant statistically, depending on the stress conditions.

**Key words :** *Cauliflower, organic acids, drought, water stress, Class-A pan, drip irrigation*

### Introduction

*Brassica oleracea* is one of the versatile species (Ordas and Cartea, 2008). Cauliflower (*Brassica oleracea* L. cv. *Botrytis*) and broccoli (*Brassica oleracea* var. *italia*) are traditional European crops that have become widespread in Asia in recent decades whereas their presence in Europe has been quite stable (Branca, 2008).

Irrigation and fertigation have an extremely important effect on yield and quality in crop production. Water resources are decreasing in quantity and quality day by day. Increasing water demands are increasing because of the population growth, which creates heavy burden on existing water resources. Nowadays, research carried out on irrigation emphasizes the optimum water requirements during drought conditions rather than obtaining the highest yield for sustainable agriculture and also identification of drought resistance varieties of all crops for each climatic conditions has been becoming an important issue.

Cauliflowers (*Brassica oleracea* L. var. *Botrytis*) are a source of phytonutrients, acting as antioxidants, such as glucosinolates, ascorbic acid and polyphenols (Scalzoa et al., 2008). Violet cauliflower extracts show significant antioxidant properties, among which are the scavenging activity of the very reactive hydroxyl radical (Pizzocaro et al., 2000).

The health benefits of broccoli are derived from the unique mixture of nutrients, minerals and vitamins and organic compounds that are found in cauliflowers. Organic acids are a group of organic compounds containing carboxylic groups. Organic acids have important functions as

flavor enhancers and natural antimicrobial agents. Organic acids influence the color of vegetables since pigments are natural pH indicators. Ascorbic acid known as vitamin C is organic acid with antioxidant properties. Vitamin C is involved in the absorption of iron and calcium. It assists in the healing of wounds and burns, in preventing blood clotting and bruising and in strengthening the walls of the capillaries, since vitamin C is a biological antioxidant, is also linked to the preservation of cataract, certain cancers, and cardiovascular disorder. Plants are seriously affected by some environmental factors (climate, available organism, geologic materials, soil, atmospheric conditions and so on) during all phases of growth and development (Haferkamp, 1987). Sarah et al. (2011) observed green color and bioactive compounds of broccoli (*Brassica Oleracea* L.) under low and optimal soil water content in greenhouse conditions. Pek et al.(2012) reported that the contents of glucosinolate and flavonoids changed under different water applications, except for sulphoropane content, but the harvesting time has an effect on the amount of sulphoropane, especially harvesting in fall period increases the amount of it. The content of ascorbic acid in vegetables is strongly affected by growth conditions, application of nitrogen fertilizers, as well as by storage conditions and processing (Sinha et al., 2011).

Organic acids are used in food preservation because of their effects on bacteria, since they can penetrate the bacteria cell wall and disrupt the normal physiology of certain types of bacteria. Within the organic acids, the malic, tartaric, lactic, succinic acids and acetic acids prolong the shelf-life of fresh-cut broccoli (Irkin et al., 2015).

The main objectives of this research were to determine both the yield, optimum water requirement of cauliflowers and changes in plant development and quality parameters under different irrigation levels.

## Materials and Methods

### Experimental site and soil description

The field experiment was carried out at Dardanos Agricultural Research Station of Canakkale Onsekiz Mart University in 2015, near the Dardanelles straits in Canakkale province, Turkey. The location of the experimental area was 40.08° N, 28.20° E at an elevation of 3 meters. Dates of transplantation for the cauliflowers (*Brassica Oleracea* L. cv. *Botrytis*) were 10 July, 2015 at spacings of 0.6x0.4 m. The chemical characteristics of the soil are given in Table 1.

Table 1. Physical and chemical properties of soil in experiment.

Depth (cm)	Field capacity (%)	Wilting Point (%)	Bulk Density (g/cm <sup>3</sup> )	pH*	Total changeable sodium (mg/l)*	Cation Exchange capacity (me/100g)*	CaCO <sub>3</sub> (%)*	Organic matter (%)*
0-30	21.0	10	1.30	7.69	135	22.3	13.5	2.29
30-60	24.4	11	1.57	8.00	195	26.2	12.0	1.26
60-90	25.0	13	1.63	8.08	98.5	24.3	10.4	1.41

\*taken from Ozcan et al. [16]

Each plot was arranged in 4 rows including 120 plants per row. The experiment was laid out using a randomized complete block design with 3 replications.

Data were saved into the data logger at 1-hour intervals throughout the experiment. The electrical conductivity of the irrigation water (EC<sub>w</sub>), measured with an EC59 pyranometer (Milwaukee Instruments, Inc.), was 0.410 ds m<sup>-1</sup>, which is reported as no restriction on use by Ayers and Westcot (1985).

### Climate parameters

Climate parameters; temperatures (min., max., and mean), relative humidity and solar radiation at the site were measured by a mini climate station at 1.5 m above the canopy of the plants, and also prolonged temperature values are given in fig.1.

The climate parameters of solar radiation ( $W m^{-2}$ ), temperature ( $^{\circ}C$ ) and relative humidity (%) at the site were measured above the canopy of the plants All data were measured by a HOBO U12 data logger, including sensors.

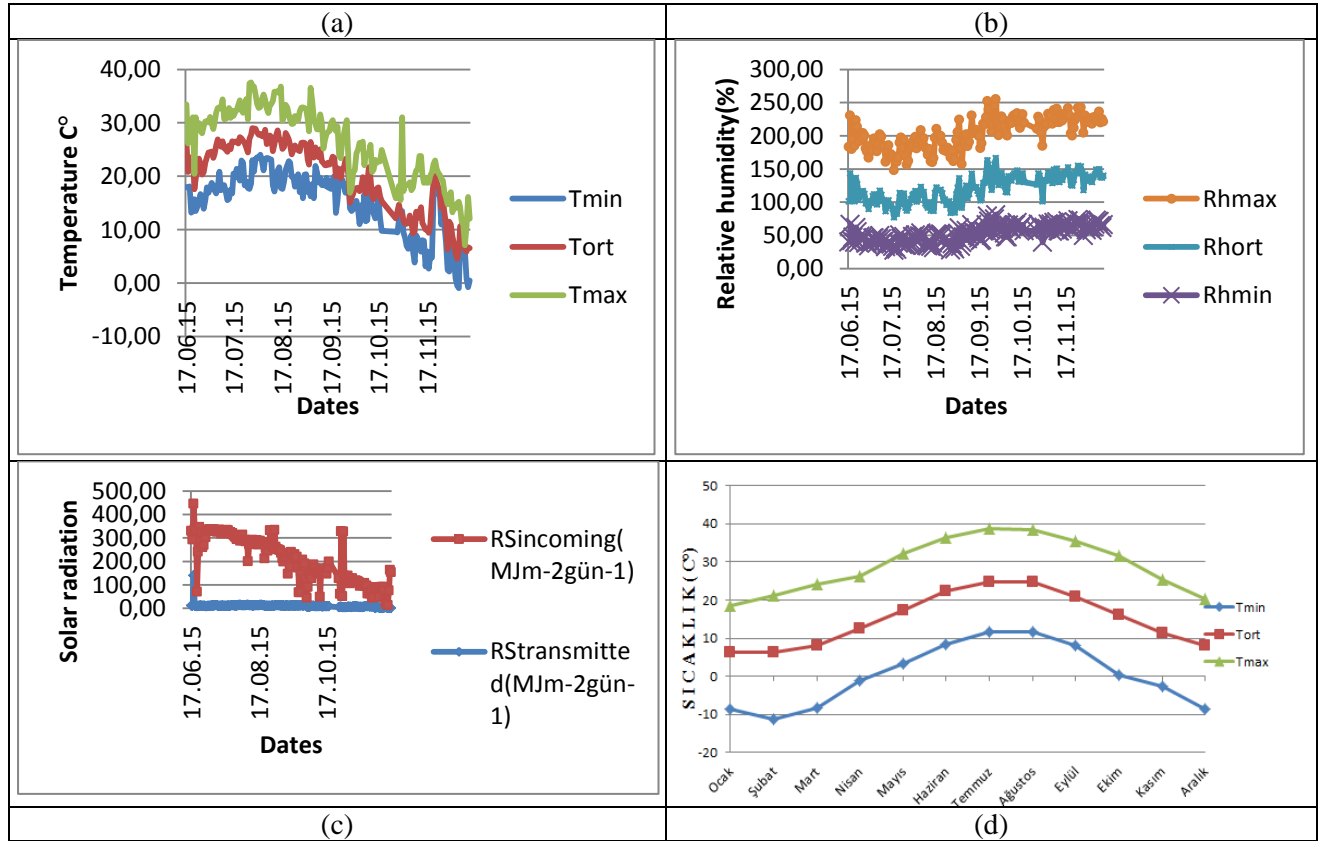


Figure 1. Meteorological data for period of experiment (a) Temperatures<sup>o</sup> C), (b) Relative humidity (%), (c) Solar radiation(MJm<sup>-2</sup>), (d) prolonged temperatures parameters (1975-2000)

### Irrigation practice

Each plot in the experiment took the same amount of fertilizer by the drip irrigation system. The total amount of fertilizer was applied three times, first at planting then at 15 and 20-day intervals. The irrigation program was run according to full irrigation ( $I_{1.0}$ ). Hence, the irrigation treatments included four gradient irrigation levels from full water to severe water stress. Only in the full irrigation (control treatment) was water refilled in the root zone up to field capacity at 4-day intervals. All treatments were equally irrigated for 20 days after transplanting in order to root development of all plants, then water was applied according to the irrigation treatments. Following this, they were then irrigated according to the irrigation treatments.

In the deficit treatments, water was applied at 70% ( $I_{0.7}$ ), at 30% ( $I_{0.3}$ ), and at 0% ( $I_0$ ) of full irrigation. Class-A Pan was located next to the experimental plot. All amounts of evaporation from the class-A pan throughout the whole growing season were measured every 4 days for all growing period. In calculation of the applied water in the full irrigation, pan evaporation was used according to the equation given by Kanber (1984).

$$I = A \times E_{pan} \times K_{pc} \quad (1)$$

where  $I$  is the amount of irrigation water applied (mm),  $A$  is the plot area,  $E_{\text{pan}}$  is the cumulative evaporation at irrigation interval (mm),  $K_{\text{pc}}$  is the pan coefficient ( $K_{\text{pc}}=1$  in the  $I_{1,0}$ ,  $K_{\text{pc}}=0.7$  in the  $I_{0,7}$ ,  $K_{\text{pc}}=0.3$  in the  $I_{0,3}$  and  $K_{\text{pc}}=0$  in the  $I_0$ ). Evapotranspiration (ET) was calculated by the water balance equation below:

$$ET = I + P \pm \Delta SW \quad (2)$$

where ET is evapotranspiration (mm),  $P$  is rainfall (mm) and  $\Delta SW$  is the change in soil water content (mm) at a depth of 60 cm from the soil surface, and soil water content was determined by the gravimetric method at 30 cm intervals.

### **Plant and fruit quality parameters**

All plant weights (stem, leaf and fruit) were determined using a digital balance ( $\pm 0.01$  g) and diameters were measured with a digital clipper ( $\pm 0.01$  mm). Fresh weights (stem, leaf and fruit) were determined separately by weighing. After that, they were all oven-dried to a constant weight at about  $65^\circ\text{C}$  for two days to determine the dry weight of whole plants in each treatment.

### **Leaf area**

Three plant samples from each plot were selected randomly for leaf area measurements. The green leaf portions were separated and leaf area was measured using a CI-202 Portable Laser area meter (CID, Inc., USA).

### **Organic acid extraction and analysis**

Cauliflowers pulp (3 g) was extracted by stirring with 30 mL of metaphosphoric acid for 15 minutes, then mixed with distilled water to 50 mL and subsequently filtered through Whatman no.4 paper (Vazquez et al., 1994). The volume was adjusted to 10 mL and passed through a  $0.45\mu\text{m}$  filter before examination. The process was performed for each sample using a HPLC system with a UV/VIS detector. The reagents used included chromatography-grade standards for ascorbic, oxalic, tartaric, malic, lactic, malonic and citric acids.

Statistical differences with  $p$ -values under 0.05 were considered significant and means were tested by Duncan's Multiple Range Test at the probability level of 1% and 5% ( $p < 0.01$ ,  $p < 0.05$ ).

## **Results**

### **Irrigation water, evapotranspiration (ET) and yield**

The irrigation events were performed successfully between 209<sup>th</sup> and 293<sup>th</sup> days of the year. Cauliflowers were harvested at the 325<sup>th</sup> day of the year, hence broccoli development period lasted 116 days. Different irrigation treatments in the experiment had a significant effect on the yield and vegetative development of cauliflowers. The irrigation amounts ( $I$ ), evapotranspiration (ET), WUE and IWUE values are given in Table 2.



Table 2. Measured irrigation depth (I), Evapotranspiration (ET) and Yield.

Treatments	Irrigation depth (mm)	Yield* (g plant <sup>-1</sup> )	Yield* (kg ha <sup>-1</sup> )	Evapo transpiration (mm)
I <sub>1.0</sub>	587,65	1415,3 ± 63,7 <sup>A</sup>	5892,08 ± 132,2 <sup>A</sup>	714,7 ± 32,2 <sup>A</sup>
I <sub>0.7</sub>	411,36	1138,5 ± 64,6 <sup>A</sup>	4743,75 ± 92,6 <sup>A</sup>	574,9 ± 32,6 <sup>A</sup>
I <sub>0.3</sub>	176,30	811,0 ± 104 <sup>B</sup>	3379,16 ± 52,8 <sup>B</sup>	409,5 ± 52,8 <sup>B</sup>
I <sub>0.0</sub>	65,00	179,4 ± 13,5 <sup>C</sup>	747,5 ± 16,83 <sup>C</sup>	90,59 ± 6,83 <sup>C</sup>

\*P<0.05, \*\*P<0.01, \*\*\*P<0.001

As seen in Table 2, evapotranspiration increased as the amount of applied water increased. The peaks of yield, 714.7 kg ha<sup>-1</sup> and 574.9 kg ha<sup>-1</sup> were obtained from the I<sub>1.0</sub> and I<sub>0.7</sub> treatments, respectively. Therefore, the applied water of 411.36 mm in the I<sub>0.7</sub> treatment produced the yield to 574.9 kg ha<sup>-1</sup>, which can be considered as the critical level for cauliflowers production (Table 2) since the lower than this amount causes plants to decrease the yield value. Therefore, the amount of water applied in the treatment of I<sub>0.7</sub> may be considered as a threshold value if water source is scarce.

Measurements of plant development parameters for the whole growing season are given in Table 3. Parameters related to plant development; plant height, diameters were negatively affected as the amount of water decreased from 411.4 to 65 mm. Plant sizes in terms of height and diameters were reduced by 30% ETc irrigation as compared to 100% ETc irrigation (Table 3). Therefore, deficit irrigation at 70% ETc can be considered as the threshold level in terms of both yield and quality to obtain an economical yield.

Table 3. Effect of different water levels on plant development parameters

Treatments	Diameter- x* (cm)	Diameter- y* (cm)	Height (cm)*	Leaf area (cm <sup>2</sup> )*
I <sub>1.0</sub>	19,01 ± 0,40 <sup>A</sup>	18,35 ± 0,49 <sup>A</sup>	14,89 ± 0,31 <sup>A</sup>	19523 ± 708 <sup>A</sup>
I <sub>0.7</sub>	17,64 ± 0,49 <sup>A</sup>	17,64 ± 0,38 <sup>A</sup>	13,61 ± 0,31 <sup>B</sup>	14430 ± 212 <sup>B</sup>
I <sub>0.3</sub>	14,34 ± 0,20 <sup>B</sup>	13,76 ± 0,34 <sup>B</sup>	11,08 ± 0,29 <sup>C</sup>	9279 ± 242 <sup>C</sup>
I <sub>0.0</sub>	8,59 ± 0,45 <sup>C</sup>	8,73 ± 0,29 <sup>C</sup>	8,73 ± 0,12 <sup>D</sup>	3942,1 ± 27,8 <sup>D</sup>

\*P<0.05, \*\*P<0.01, \*\*\*P<0.001

The various sugars perform different functions in the tubers, but they all can provide energy, glucose is the main source of energy because the most complex sugars and carbohydrates breakdown into glucose (Yildirim et al, 2009). The total and reduced sugar contents were the highest in the I<sub>1.0</sub> as 4.76 and 3.69 g/100g, respectively. Therefore, full treatment caused cauliflowers plants to store more energy.

Treatments	Reduced sugar (mg 100g <sup>-1</sup> )	Total sugar (mg 100g <sup>-1</sup> )	Sucrose
I <sub>1.0</sub>	3,693 ± 0,181 A	4,766 ± 0,023 A	1,020 ± 0,151 ns
I <sub>0.7</sub>	3,375 ± 0,202 AB	4,310 ± 0,142 AB	1,171 ± 0,160 ns
I <sub>0.3</sub>	3,343 ± 0,289 AB	4,559 ± 0,163 AB	1,439 ± 0,227 ns
I <sub>0.0</sub>	2,511 ± 0,091 B	4,210 ± 0,094 B	1,614 ± 0,176 ns

## Organic acids

The organic acids (ascorbic, tartaric, lactic, citric, malic, malanoic and oxalic acid) in cauliflower (*Brassica Oleracea* L. cv. Botrytis) are given in table 4. The organic acid contents in cauliflower varied from 52.4 mg g<sup>-1</sup> in the treatment that full water demand of cauliflower was met to 60.5 mg g<sup>-1</sup> in the severe stress treatment. As seen, the amount of total organic acid increased when the level of water stress increased.

The changes in the amount of organic acids are given in table 3. The dominant organic acids in cauliflower (*Brassica Oleracea* L. cv. Botrytis) were ascorbic, oxalic, and malic acid, respectively. The ascorbic acid content exhibited the highest content as compared with other organic acids given in table 3. The ascorbic acid ranged from 38.6 mg g<sup>-1</sup> in the full water application to 47.4 mg g<sup>-1</sup> in the stress treatment (I<sub>0,0</sub>), which was almost accounting of 76 % of the total organic acid content, oxalic and malic acid were 17.6 % and 4.42 % of total acid. The minor organic acids in cauliflower were citric (0.1 to 0.9 mg g<sup>-1</sup>), lactic (0.5 to 0.7 mg g<sup>-1</sup>), tartaric (0.3 to 0.4 mg g<sup>-1</sup>) and malanoic acid (0.2 to 0.3 mg g<sup>-1</sup>), and these accounted for very less amount of total acids. The content of each individual organic acid increased with increasing water stress, and the differences between the individual organic acids were significant.

Table 4. Organic acids (mg/g)

Treatments	Ascorbic	Tartaric	Lactic	Citric	Malic	Malanoic	Oxalic
I <sub>1,0</sub>	0,3858 ± 1,04 B	0,491 ± 0,005 ns	0,571 ± 0,084 ns	0,974 ± 0,110 A	2,315 ± 0,124 B	0,232 ± 0,012 C	9,240 ± 0,017 ns
I <sub>0,7</sub>	0,4177 ± 0,09 B	0,439 ± 0,018 ns	0,793 ± 0,042 ns	0,323 ± 0,179 B	2,945 ± 0,225 A	0,318 ± 0,007 A	9,128 ± 0,368 ns
I <sub>0,3</sub>	0,4291 ± 0,22 AB	0,393 ± 0,027 ns	0,550 ± 0,080 ns	0,124 ± 0,009 B	3,299 ± 0,062 A	0,330 ± 0,006 A	8,829 ± 0,736 ns
I <sub>0,0</sub>	0,4741 ± 1,81 A	0,377 ± 0,018 ns	0,543 ± 0,036 ns	0,172 ± 0,023 B	2,780 ± 0,018 AB	0,278 ± 0,001 B	8,979 ± 0,228 ns

Therefore, organic acid content in cauliflower (*Brassica Oleracea* L. cv. Botrytis) was higher than other fruits. Soyer et al. (2003) found that the dominant organic acid in the 11 different white grape cultivars was tartaric acid (4.07 to 4.92 g L<sup>-1</sup>) and citric acid (31 to 181 mg L<sup>-1</sup>), malic acid (1.36 to 3.47 g L<sup>-1</sup>), respectively. Sha et al. (2011) determined 10 organic acids in the pear fruit (*P. ussuriensis*) and the total organic acid content ranged from 3.04 to 9.13 mg L<sup>-1</sup>.

## Conclusion

Careful attention in irrigation must be paid to determine the optimum water requirements of all crops without causing too much loss in yield and nutritional contents of food.

In the experiment, cauliflower (*Brassica Oleracea* L. cv. Botrytis) exhibited to be a water-sensitive plant to water shortage, Yield of cauliflower was affected according to the different water levels and produced the highest yields in I<sub>1,0</sub> and I<sub>0,7</sub> treatments, in which the amount of water applied were 587.6 mm and 411.4 mm. These findings are well agree with the findings of Erken et al.(2013). Applying irrigation water for cauliflower between 411.4 and 587.6 mm seems to be more appropriate level for getting an economical yield.

An increment in the organic acid content was observed, as water stress level increased, and there was statistical differences in each organic acid content under different irrigation levels. Within the organic acids, ascorbic acid (Vitamin C) was dominant in cauliflower and also the content of it was very high as compared with many fruits. Therefore, cauliflower can be considered in terms of ascorbic acid as an important antioxidant in the foods.

## **Acknowledgements**

The authors wish to thank Canakkale Onsekiz Mart University Agricultural Experiment Station for their assistance in this research.

## **References**

- Ayers, R.S., Westcot, D.W., (1985). Water Quality for Agriculture, FAO Irrigation and Drainage Paper 29 rev 1. FAO, UN, Rome 174pp.
- Branca, F., (2008). Cauliflower and Broccoli. Vegetables I. Handbook of Plant Breeding, Vol. 1, p. 151-189.
- Erken,O., Kuzucu,C.O., Cakir,R., (2013). Impact of different water supply levels on yield and biochemical ingredients in broccoli. Bulgarian Journal of Agricultural Science, 19(No.5)2013, 1009-1017.
- Haferkamp,M.R., (1987). Enviromental factors affecting plant productivity, Fort Keogh Research Symposium, September, 1987, Miles City,MT. R.S..White&R.E.Short(Eds).Publ.by Montana Agr.Exp.Sta.,Bozeman,Feb.1988, 132 p.
- Irkin,R., Degirmencioglu, N., Guldas,M., (2015). Effects of organic acids to prolong the shelf-life and improve the microbial quantity of fresh-cut broccoli florets. Quality assurance and safety of crops&foods: 7(5)-p.737-745. DOI:<http://dx.doi.org/10.3920/QAS2014.0489>.
- Kanber, R., (1984). Irrigation of first and second crop peanut at Cukurova plain using class-a pan. Research Institute of Tarsus, Publication No. 114, Tarsus. (In Turkish)
- Ordás, A. and M. Cartea M.E., (2008). Cabbage and Kale. Vegetables I. Handbook of Plant Breeding, Vol. 1, p. 119-151.
- Pek,Z., Daood,H., Nagyne,M.G., Berki,M., Namenyi,A., Helyes,L., (2012). Yield and phytochemical compounds of broccoli as affected by temperature, irrigation and foliar sulfür supplementation. HortScience 47(11):1646-1652.
- Pizzocaro, F., Ferrari, V., Acciarri, N., Morelli, R., Russo-Volpe, S., & Prinzivalli, C., (2000). Antioxidant and antiradical activities in green and violet cauliflower ecotypes with different maturity stages. Workshop of VI Giornate Scientifiche SOI, Sirmione (pp. 34–35). AOAC Int 77:1056–1105.
- Sarah, L.P.C., Chaves,F.C., Schirmer,M.A., Zambiasi,R.C., Nora,L., Silva,J.A., Rombaldi,C.V., (2011). Low soil water content during growth contributes to preservation of green colour and bioactive compounds of cold-stored broccoli (*Brassica oleracea* L.) florets. Postharvest Biology and Technology 60(2011),p.158-163.
- Scalzo, R.L., Genna, A., Branca, F., Chedin, M., Chassaigne, H., (2008). Anthocyanin composition of cauliflower (*Brassica oleracea* L. var. botrytis) and cabbage (*B. oleracea* L. var. capitata) and its stability in relation to thermal treatments. Food Chemistry 107: 136–144.
- Sha,S., Li,J., Wu,J., Zhang,S., (2011). Characteristics of organic acids in the fruit of different pear species. African Journal of Agricultural Research. Vol.6(10),pp.2403-2410. DOI:10.5897/AJAR11.316.
- Sinha,N.K., Hui, Y.H., Evranuz,E.O., Siddiq,M., Ahmad,J., (2011). Handbook of vegetables and vegetable processing Willey-Black Well Publication, Edition First Published, 2011. Blackwell Publishing Ltd.p.35-36.
- Soyer,Y., Koca, N., Karadeniz, F., (2003). Organic acid profile of Turkish white grapes and grape juices. Journal of Food Composition and Analysis. 16(2003) 629-636.

- Vazquez, O.M.L., Vazquez, B.M.E., Lopez, H.J., Simal, L.J., Romero, R.M.A., (1994). Simultaneous determination of organic acids and vitamin C in green beans by liquid chromatography. *J AOAC Int* 77:1056–1105.
- Yidirim, M., Akcal, A., Kaynas, K., (2009). The response of *Cyclamen hederifolium* to water stress induced by different irrigation levels, *Afr.Journal of Biotechnology* Vol.8(6), pp.1069-1073.

## EFFECTS OF THE PICKING PEDICLE AT DIFFERENT STAGES ON TULIP GROWTH

Özgür KAHRAMAN\*

\*Canakkale Onsekiz Mart University, Faculty of Architecture and Design, Department of Landscape Architecture, Terzioğlu Campus, 17020 Canakkale, Turkey

\*Corresponding author: ozgurkahraman@comu.edu.tr

### Abstract

Tulip is one of the bulbous plants that show up with the beautiful flowers in the landscape areas and gardens in the winter months. The bulbs of the tulip must have over certain circumference of the bulbs to be able to bloom. The circumference of the bulb affects the flowering positively. This research was carried out to determine the effects of pedicle picking at different stages on plant growth and bulb parameters between November 2015 and May 2016 in pot culture. The bulbs of *Tulipa gesneriana* L. “Golden Parade” with 9 cm circumference were used as a plant material. After the bulbs were treated with fungicide, they were planted on November 23, 2015 in plastic pot filled with a mixture of peat (50%) and perlite (50%). The research was designed according to randomized plot design with 3 replications and each plot (plastic pot) had 5 tulip bulbs. Three different treatments were applied to the pedicle of tulip. The pedicle was picked as soon as it was seen in first treatment (T1). In second one (T2), the pedicle of the tulip was picked under its receptacle before blooming. The pedicle was not plucked in the control application (C). Some parameters such as bulb diameter, bulblet number, bulblet diameter, leaf number, leaf width, leaf length and leaf width were measured. As a result of statistical analyses, treatments have a significant effect on bulb diameter but there were no significant differences between the treatments for the other parameters. The highest bulb diameter was found in T1 (31.46 mm) and T2 (30.87 mm). The bulblet number was determined between 1.17 and 1.50 piece.

**Keywords:** *Tulipa gesneriana* L., picking pedicle, development of bulb, cultivation

### Introduction

Tulip is one of the natural flower bulb species and has ornamented with beautiful flowers in our garden over four centuries. Although tulips are native species to Central Asia, generally these are associated with the Netherlands (Tuyl and Creij, 2006). Turkey familiarised tulips to Europe and they started to be seen in the Netherlands in 1574. They become quite popular in 1630's. They were used extensively in the garden design during the Ottoman Empire. Tulips have been a source of inspiration for fine arts such as architecture, marbling art and glazed tile. The name was given to a period “Tulip Period”. They have been started to be used in parks and gardens by metropolitan municipalities such as İstanbul, Konya and district municipalities. They are also used for cut flowers and flowering potted plants in the ornamental plants sector. They have the most production area (122727 da) in the world and they are at the head of the bulbous flowers that are traded (Benschop *et al.*, 2010). The tulip production in Turkey is carried out by a private company in Çumra district, Konya. Tulip is one of the natural flower bulbs belonging to *Liliaceae* family. *Tulipa gesneriana* L. species is a bulbous plant having pear-shaped hard brown tunics. Tulips are commonly propagated with vegetative propagation methods. They need a low temperature period to bloom their

beautiful flowers (Rietveld *et al.*, 2000). In addition, the bulb of tulip must be in critical size (6-9 cm) to be able to bloom (Rees, 1966). Enlargement of bulbs is taking a long time. This research was conducted to determine the effects of pedicle picking at different stages on plant growth and development of bulb.

### Material and Methods

This research was conducted between November 2015 and May 2016 in pot culture in a private residential garden in Çanakkale, Turkey. In this research, the bulbs of *Tulipa gesneriana* L. “Golden Parade” with 9 cm in circumference were used as a plant material (Figure 1). These bulbs were treated in 1% Captan and 0.5 % Mancozeb for 20 minutes against fungal diseases. As a growing media, 50 % peat + 50 % perlite mixes were prepared (Figure 2). After plastic flowerpots were filled with growing media prepared as much as half of pot's depth, the bulbs of tulip were planted on November 23, 2015 (Figure 3). Later on, the bulbs were watered until drainage out. During tulip growing season, three different treatments were done. The first treatment (T1); the pedicle of tulip being picked as soon as it was seen. The second treatment (T2); the pedicle of the tulip being picked under its receptacle before blooming. The pedicle was not plucked in the control application (C) (Figure 4). The research was established according to randomised plot design with 3 replications and each replication had five tulip bulbs (Figure 3). From the study, parameters such as bulb diameter (mm), bulblet number (piece/bulb), bulblet diameter (mm), leaf number (piece/bulb), leaf width (cm), leaf length (cm) and leaf thickness (mm) were measured. Variance analysis with SPSS 23 statistical software and Duncan's multiple comparison test ( $p < 0.05$ ) were applied to this data.



Figure 1. The bulbs used in the experiment



Figure 2. Peat, perlite and 50% peat + 50% perlite mixture



Figure 3. Planting of tulip bulbs



Figure 4. The picking pedicle at different stages (T1, T2, C)

### Results and Discussion

According to the variance analysis, in this research, it was determined that picking pedicle at different stages had a statistically significant effect ( $p < 0.01$ ) on bulb diameter. The highest bulb diameter was determined in T1 (31.46 mm) and T2 (30.87 mm) treatments where the pedicle was picked (Figure 5). The lowest bulb diameter (27.78 mm) was in control treatment (Figure 6). However, picking pedicle treatments had any statistically significant effect on bulblet number and diameter. Bulblet number was between 1.17 piece (T1) and 1.50 piece (T2). The maximum result for bulblet diameter was found with an average value of 22.03 mm in C, also minimum value was found in T1 (21.60 mm). [Kahraman \(2016\)](#) also had similar results for bulb diameter and bulblet number in picking pedicle of Madonna lilly.



Figure 5. Effects of the picking pedicle at different stages on diameter of bulb (T1, T2, C)



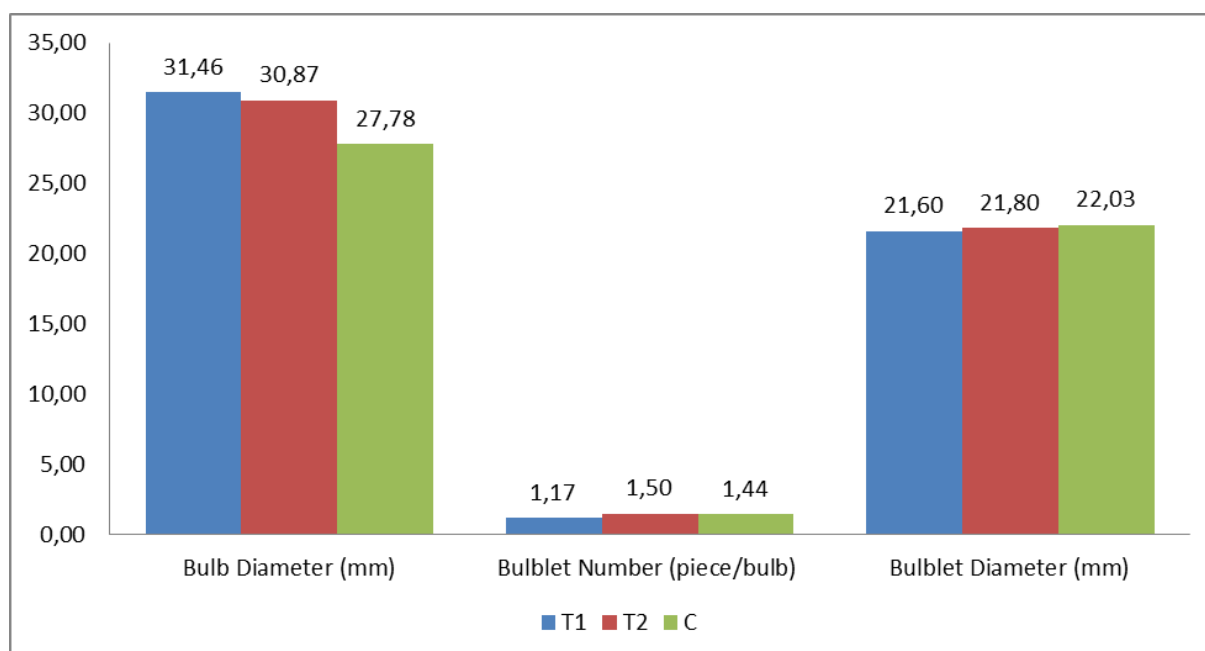


Figure 6. Effects of the picking pedicle at different stages on bulb parameters (T1, T2, C)

The effect of picking pedicle treatments on leaf number, leaf length, leaf width and leaf thickness was found to be insignificant. Leaf number occurred between 4.14 and 4.67 piece (Figure 7). The highest leaf length was found in control (13.08 cm). The leaf width was found between 6.63 cm (T1) and 7.19 cm (T2). Kottayam *et al.* (2014) found approximate value for leaf number (3.33-4.66 piece) in different two tulip cultivars (Apeldoorn and Golden Oxford).

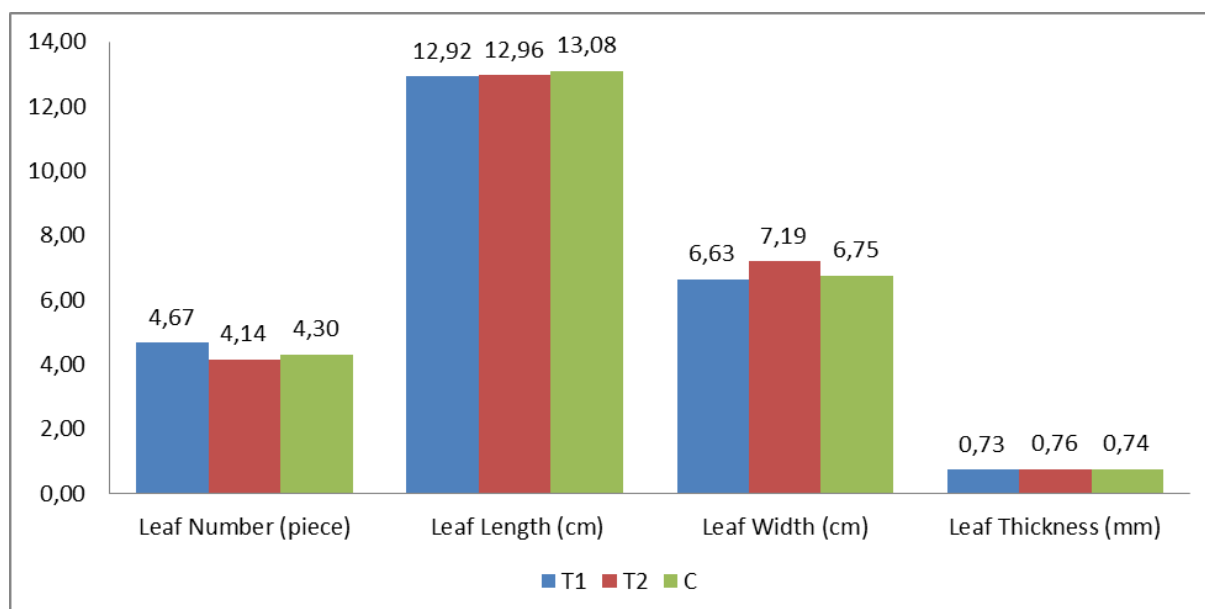


Figure 7. Effects of the picking pedicle at different stages on leaf parameters (T1, T2, C)

### Conclusions

The results showed that in *Tulipa gesneriana* L. cultivation, picking pedicle at different stages (T1 and T2) effect on bulb size. However, the effect of picking pedicle treatments on some

parameters such as bulblet number, bulblet diameter, leaf number, leaf length, leaf width and leaf thickness is insignificant. T1 and T2 treatments can be used in *Tulipa gesneriana* L. cultivation to enlarge the bulb size.

### References

- Benschop M., Kamenetsky R., Le Nard M., Okubo H., De Hertogh A. (2010). The Global Flower Bulb Industry: Production, Utilization, Research, in *Horticultural Reviews*, Volume 36, 1-115.
- Kahraman Ö. (2016). The Effects of Plucking Flower Bud on Madonna Lily Development. *Bahçe:Yalova Atatürk Bahçe Kültürleri Merkez Araştırma Enstitüsü Dergisi*, 45, 1035–1038.
- Kottayam S., Sartaj A., Ansari H. (2014). Advancing flower quality of tulip (*Tulipa gesneriana* Linn.) through application of plant growth regulators. *International Journal of Horticulture and Floriculture* Vol. 2 (2), pp. 046-051.
- Rees A.R. (1966). The Physiology of Ornamental Bulbous Plants. *Botanical Review*, 32(1), 1-23.
- Rietveld P.L., Wilkinson C., Franssen H.M., Balk P.A., Plas L.H.W.V., Weisbeek P.J., Boer A.D. (2000). Low temperature sensing in tulip (*Tulipa gesneriana* L.) is mediated through an increased response to auxin, *Journal of Experimental Botany*, Volume 51, Issue 344, pages 587–594.
- Tuyl J.M.V., Creij M.G.M.V. (2006). Tulip: *Tulipa gesneriana* and T. hybrids, N.O. Anderson (ed.), *Flower Breeding and Genetics*, 623–641, The Netherlands.

## THE EFFECT OF DIFFERENT NATURAL FERTILIZATION TECHNIQUES ON SOIL CHARACTERISTICS IN DRIED FIG (*Ficus Carica* L. Cv. Sarilop) PRODUCTION

Saime SEFEROĞLU<sup>1\*</sup>, M. Ali KAPTAN<sup>1</sup>, Seçil KÜÇÜK KAYA<sup>1</sup>, Nilgün TAN<sup>2</sup>, Ferit ÇOBANOĞLU<sup>2</sup>, Hilmi KOCATAŞ<sup>2</sup>

<sup>1</sup>Adnan Menderes University Agricultural Faculty Soil Science and Plant Nutrient Department Aydın/Turkey

<sup>2</sup>Fig Research Institute Erbeyli/Aydın/Turkey

\*Corresponding author: sseferoglu@adu.edu.tr

### Abstract

Turkey is ranked first regarding dry Fig production in the world. In terms of organic farming, Turkey is ranked second regarding dry Fig production after olive production. Main aim of the project was to determine impacts on soil characteristic parameters of 'Sarilop' dried fig variety applying different natural fertilization techniques on organic agriculture system. That research was carried out in a farmer orchard which consisted of Sarilop dried fig variety, located in Isafakilar village, Incirliova, Aydın in Turkey, in the period 2002-2005. This experiment was designed in completely randomized blocks with four replications and each replication was comprised of one tree. Totally six applications were applied: (control, vetch, natural vegetation, 20, 40 and 60 kg farmyard manure applications respectively). Soil samples were taken after harvest for three years. In this soil samples, soil texture, pH, CaCO<sub>3</sub> (%), total salt (%), organic matter (%), N, P, K, Ca, Mg analyses were done. According to analysis results, natural fertilization applications increased total salt and pH contents in the second year. Organic matter and N contents increased among the years. The highest organic matter was obtained by application of farmyard manure. P, K, Ca and Mg contents increased as parallel with increasing doses and reached the highest values by application of 40 kg farmyard manure.

**Keywords:** *dried fig, organic fertilization, soil properties*

### Introduction

Ecological agriculture (=biological agriculture, organic agriculture) is designated as the most important and effective alternative in the solution of the environmental problems caused by the use of agricultural inputs getting intensified year by year in the present day. When studied over years, ecological agriculture containing eco-credential production techniques and targeting the enhancement of welfare from producer to consumer dates back to the first half of the 1900s when the use of chemicals started in agriculture. The pioneers in the matter in Europe displayed different approaches to the soil fertility concept and thus constituted the foundation of ecological agriculture (Aksoy, 2001).

Worldwide, Australia occupies the first place with 11300000 ha of organic agricultural production area and it is followed by such countries as Argentina (2800000 ha) and Italy (1052000 ha) respectively. Organic agricultural production area is 103190 hectares in Turkey. It was determined that the share of these organic production areas in the total agricultural land of each country varied between 0.22% and 6.86 percent. Organic agricultural production area is 103190 hectares in Turkey and its share in the total agricultural land (26000000 ha) is 0.39 percent (SOEL, 2005).

In a study in which the effect of soil characteristics on the fresh and dried fruit properties in fig trees, it was determined that the nitrogen content of the soil had an affirmative effect on the number of sound fruits and reduced the sun blight. It was reported that there was a positive relationship between the phosphorus content of the soil and the number of leaves not affected by blight (Anac et al., 1991).

In a study carried out in order to identify the nutritional status in the fig orchards in the vicinity of Germencik, the researchers determined that the potassium contents of the leaf blade and stalk were effective on the fruit quality and that it increased the rate of split fruit while reducing the rate of sun-blighted fruit and stated that the same relationship was also valid for calcium in the reverse way (Aksoy et al., 1987).

In a study they carried out in the vicinity of Germencik, Aksoy et al. (1987) stated that the nitrogen contents of the leaf blade and stalk affirmatively affected the vegetative growth and number of fruits of fig trees but reduced the fruit size in dried fruits and increased the number of sun-blighted and dark-coloured fruits and reduced the quality of dried fruit. They further determined that phosphorus also affirmatively affected the fresh and dried fruit size.

In a study in which the effect of potassium nitrate and calcium nitrate applications via leaves in figs on some nutrient contents and fruit quality properties were studied, it was stated that potassium applications had an affirmative effect on the fruit colour and hardness as well as fruit size.

Anac et al. (1991) stated that there was an affirmative relationship between the potassium content of the soil and the number of sound fruits not showing sun blight in fresh and dried figs. It was further reported that the calcium content of the soil reduced the fruit size and that there was a significantly affirmative relationship between the calcium carbonate content of the soil and the number of non-split sound fruits.

In a study in which the effects of organic fertilization on the leaf and fruit quality in figs, it was stated that fertilization was effective on the Ca and Zn contents of the leaf stalk and that animal manure applications was effective on the Fe content of the leaf stalk and the fruit. Further, it was reported that organic fertilization increased the vegetative growth and was effective on shoot length, width and node number (Mordogan et al., 2002).

The objective of this study is to study the effect of the use of different doses of different organic matters and cattle manure used in organic agriculture as fertilizing material in organic fig growing on the physical and chemical properties of the soil.

### **Material and Method**

The study material is comprised of the grower orchard cultivated with the Sarilop fig variety in the Isafakilar village of the township of Incirliova (Turkey) The study was carried out by applying three different doses of cattle manure and spring vetch (*vicia sativa*) in the fertilization of figs, and mulching was made by mowing weeds and leaving them on the soil surface.

The trial was set up by the random blocks trial pattern and the applications consisted of 4 repetitions and each repetition consisted of one tree. Applications were six in number and they were:

Control (C): Methods being used by the grower were maintained.

Natural Vegetation (NV): Natural vegetation on the soil was mowed and left on the soil.

Spring Vetch (SV): 12 kg/da spring vetch was calculated and sown in October and November and mixed into the soil at the beginning of blossoming.

20 kg manure/tree (20 CM): Cattle manure to the projection of the tree's crown.

40 kg manure/tree (40 CM): Cattle manure to the projection of the tree's crown.

60 kg manure/tree (60 CM): Cattle manure to the projection of the tree's crown.

Soil samples used in the study were taken from a depth of 0-30 cm and analysed three times, i.e. prior to trial, in the year when the trial was applied and after trial. Chemical analyses were carried out on the organic fertilizer used in the trial (Table 1). In the soil samples, composition was analysed by Bouyoucos (1951) method; pH by Jackson (1958) method; % total salt by US Salinity Staff (1951) method; % CaCO<sub>3</sub> by Caglar (1958) method; % organic matter by Walkey-Black (Anonymous, 1980) method; variable K, Ca, Mg, Na by Kacar (2009) method; obtainable P by Olsen et al. (1965) method. Statistical analyses of the data obtained in the study were carried out by the randomized plots trial pattern and SPSS package programme was employed.

Table 1. Results of analysis of the organic fertilizer used in the trial

Organic fertilizer properties*											
Percent			pH	mg kg <sup>-1</sup>							
Salt	OM	N		P	K	Ca	Mg	Na	Fe	Zn	Mn
0.0365	23.9	1.20	8.84	248	342	2560	1241	282	111.9	210.1	81.7
SL	VH	H	SA	VH	VH	M	VH	H	H	H	H

\* OM = organic matter; interpretation of the results: SL = saltless, SA = strong alcalic, VH = very high, H = high, M = medium

### Results and Discussion

Evaluation of the changes in the physical and chemical properties of the soil samples taken from the plots where application was made prior to trial and for 3 years afterwards is given in Table 2. It is observed that different organic matters applied to the soil have changed the % total salt content of the soil as compared to the control. According to the limit values by Soil Survey Staff, 1951, while it was not salty in terms of % total salt in the 1<sup>st</sup> and 3<sup>rd</sup> years, a danger of slight salinity appeared in the 2<sup>nd</sup> year. When the averages of the three years are examined in Table 2, a danger of slight salinity is involved in spring vetch and 20-40 kg organic fertilizer applications and that there is no problem in terms of salinity in the other applications. In the statistical evaluation made, it was determined that there was difference between the applications and years but that the interaction of year\*application was not significant (Table 2).

Table 2. Impacts of organic fertilizer on total salt and pH in soil

Treatment*	Cattle manure (CM) property							
	Total salt (%)				pH			
	Year				Year			
	2003	2004	2005	Mean	2003	2004	2005	Mean
C	0.012	0.020	0.010	<b>0.014 ab</b>	7.78	8.31	8.16	<b>8.08</b>
NV	0.011	0.013	0.007	<b>0.010 c</b>	7.58	8.21	7.98	<b>7.92</b>
SV	0.015	0.023	0.011	<b>0.016 a</b>	7.50	8.30	7.95	<b>7.92</b>
20 CM	0.015	0.023	0.012	<b>0.016 a</b>	7.68	8.36	8.21	<b>8.08</b>
40 CM	0.014	0.023	0.010	<b>0.015 a</b>	7.81	8.38	8.17	<b>8.12</b>
60 CM	0.010	0.018	0.007	<b>0.011 bc</b>	7.95	8.17	7.96	<b>8.03</b>
Mean	<b>0.013 b</b>	<b>0.020 a</b>	<b>0.010 c</b>	<b>0.014</b>	<b>7.71 c</b>	<b>8.29 a</b>	<b>8.07b</b>	<b>8.02</b>
LSD	Year		Fertil.	Interaction	Year		Fertil.	Interaction
	0.003		0.004	ns	0.14		ns	ns

\* C = control; NV = natural vegetation; SV = spring vetch; CM (kg/tree)

While the pH content of the soil was of slightly alkali reaction at control, natural vegetation (NV), spring vetch (SV) and 20 kg fertilizer (20 kg) in the 1<sup>st</sup> year by Kellog, 1952 and in Table 2, it was determined to be of alkali reaction at 40 kg fertilizer (40 kg) and 60 kg fertilizer (60 kg) doses. Looking into the average of the years, it was determined that there was no difference between the applications but there was difference between years. No statistical relationship could be identified in year\*application.

Organic matter contents of the soil are at a low level for all applications according to Schlichting and Blume, 1962. The applied materials increased the organic matter content of the soil but did not change the limit values. Differences were obtained between the applications in statistical terms and the best result was obtained in the 60 kg fertilizer application. Organic matter contents were determined to be higher than the control every year but no significant statistical relationship was identified between the years and in the year\*application interaction. Çelik et al. 2004, the compost and manure-treated plots significantly decreased soil bulk density and increased soil organic matter concentration compared with other treatments.

Table 3. Impacts of organic fertilizer on organic matter and N in soil

Treat- ment*	Cattle manure (CM) property							
	Organic Matter (%)				N (%)			
	Year				Year			
	2003	2004	2005	Mean	2003	2004	2005	Mean
C	1.09	1.16	0.79	<b>1.01 d</b>	0.04 b	0.05 c	0.13 ab	<b>0.07 c</b>
NV	1.17	1.07	1.30	<b>1.18 cd</b>	0.06 b	0.06 bc	0.17 ab	<b>0.10 bc</b>
SV	1.64	1.69	1.45	<b>1.59 ab</b>	0.10 a	0.09 ab	0.20 a	<b>0.13 a</b>
20 CM	1.62	1.46	1.70	<b>1.59 ab</b>	0.11 a	0.08 ab	0.18 ab	<b>0.12 a</b>
40 CM	1.09	1.64	1.27	<b>1.33 bc</b>	0.10 a	0.09 ab	0.17 ab	<b>0.12 ab</b>
60 CM	1.51	2.14	1.85	<b>1.83 a</b>	0.11 a	0.10 a	0.11 b	<b>0.11 ab</b>
Mean	<b>1.35</b>	<b>1.52</b>	<b>1.39</b>	<b>1.42</b>	<b>0.09 b</b>	<b>0.08 b</b>	<b>0.16 a</b>	<b>0.11</b>
LSD	Year		Fertil.	Interaction	Year		Fertil.	Interaction
	ns		0.29	ns	0.02		0.02	0.04

\* C = control; NV = natural vegetation; SV = spring vetch; CM (kg/tree)

Applied organic materials increased the N % content of the soil despite the absence of changes in the organic matter content of the soil Table 3. Increases caused the limit values to change, i.e. to rise from the very low level to the medium level. Differences were identified between years, applications and year\*applications. The highest value was obtained by spring vetch in the 20-40-60 kg fertilizer applications. The highest year was the 3<sup>rd</sup> year in natural vegetation. Hernandez et al. (1994) explained in a research which was made to determine 6 different irrigation and 6 different nitrogen levels on quality and nutrient contents of fruits in fig trees, nitrogen affected positive direction on total soluble solids of fruits in only one season, but nitrogen declined calcium (Ca) content of leaves.

When evaluated according to Olsen et al. (1965), P contents of the soil are at sufficient levels. Only in the 1<sup>st</sup> year, the limits values changed and became high. In the applications, the highest P value was obtained in the 40-60 kg fertilizer applications in Table 4. The lowest value was determined in the natural vegetation. All others were higher than the control and at sufficient limits. Aksoy et al. (1987) declared in the research paper which was conducted to determine nutrition status of fig orchard located in Germencik province, average dried fruit weight which was dried in natural conditions and methods, was 16.3 g and it was explained phosphorous nutrient matter increases dried and fresh fig weight and impacts positive approaches.

Table 4. Impacts of organic fertilizer on P and K in soil

Treatment*	Cattle manure (CM) property							
	P (mg kg <sup>-1</sup> )				K (mg kg <sup>-1</sup> )			
	Year				Year			
	2003	2004	2005	Mean	2003	2004	2005	Mean
C	9.75 b	4.31 c	9.26 bc	7.77 bc	227.50 c	192.25 b	309.75 b	243.17 c
NV	9.50 b	7.31 c	3.08 c	6.63 c	238.25 bc	162.25 b	174.25 c	191.58 d
SV	15.50 b	8.23 c	7.54 bc	10.42 bc	325.50 a	301.75 a	324.00 b	317.08 b
20 CM	19.75 b	11.94 c	11.12 ab	14.27 b	303.75 ab	344.00 a	354.75 ab	334.17 b
40 CM	35.25 a	31.07 b	17.06 a	27.79 a	348.00 a	390.00 a	416.25 a	384.75 a
60 CM	36.50 a	48.04 a	6.02 bc	30.19 a	364.75 a	352.00 a	214.25 c	310.33 b
Mean	21.04 a	18.48 a	9.01 b	16.18	301.29	290.38	298.88	296.85
LSD	Year		Fertil.	Interaction	Year		Fertil.	Interaction
	4.60		6.50	11.26	ns		42.76	74.07

\* C = control; NV = natural vegetation; SV = spring vetch; CM (kg/tree)

According to Pizer (1967), K content of the soil was increased by the applications and difference were identified between applications and year\*applications. The highest K value was obtained in the 40 kg fertilizer application. Considering in terms of limit values, the soil was determined to be at high level in terms of K and increased as compared to the control (Table 4). It was determined that there was no difference between years. It was indicated in a research study which was made by Aksoy et al. (1987) on ‘Sarilop’ dried fig cultivar, potassium content of leaf impacts sunburn damages of the fruits significantly and there are positive correlations with potassium content of leaf and good fruit rate. Aksoy et al. (1991), (1992) reported that the K/Ca ratio was so important and that it had a negative effect on sun blight.

Evaluating according to Loue (1968), it was determined that the applied organic matters were effective on the Ca contents of the soil, that 2005 was the year in which they were most effective on the Ca content and that there were differences between the years, applications and year\*application. The highest Ca value was obtained in the applications other than the natural vegetation. There are also differences between years and the applications. It was reported that CaCl<sub>2</sub> applications increased the sun blight in fruits but it was not significant in statistical terms. Aksoy and Anac (1994) reported that CaCl<sub>2</sub> applications were effective on the fruit split percentage; Raese (1989) and Klein et al. (1990) reported in their studies on Bursa Siyahi, Sarilop and Goklop varieties that Ca did not affect the fruit quality. Shear (1975) determined deficiency of calcium was caused cracking on apple, cherry, dried plums and carrot.

According to Loue (1968), there are differences in Mg contents of the soil as in the case of Ca contents. In terms of applications, the highest Mg content was obtained in the 20-40-60 kg fertilizer applications. Differences were determined between years, applications and year\*applications. The highest Mg content was obtained in 2004.

Table 5. Impacts of organic fertilizer on Ca and Mg in soil

Treat- ment*	Cattle manure (CM) property							
	Ca (mg kg <sup>-1</sup> )				Mg (mg kg <sup>-1</sup> )			
	Year				Year			
	2003	2004	2005	Mean	2003	2004	2005	Mean
C	2639.50 a	1928.00 ab	3516.00 a	2694.50 a	318.75 bc	319.00 c	281.25 abc	306.33 b
NV	2467.50 a	1664.00 b	2148.50 b	2093.33 b	276.00 c	364.25 bc	182.25 c	274.17 b
SV	2466.50 a	2210.00 ab	3060.00 ab	2578.83 a	265.25 c	377.00 bc	224.25 bc	288.83 b
20 CM	2636.25 a	2626.00 ab	3589.25 a	2950.50 a	343.75 b	474.50 ab	357.75 ab	392.00 a
40 CM	2590.50 a	2496.00 ab	3321.00 ab	2802.50 a	359.00 b	557.25 a	389.00 a	435.08 a
60 CM	2607.50 a	2970.00 a	2221.75 b	2599.75 a	449.00 a	555.00 a	200.00 c	401.33 a
Mean	2567.96 b	2315.67 b	2976.08 a	2619.90	335.29 b	441.17 a	272.42 c	349.63
LSD	Year		Fertil.	Interaction	Year		Fertil.	Interaction
	338.78		479.11	829.84	46.48		65.74	113.86

\* C = control; NV = natural vegetation; SV = spring vetch; CM (kg/tree)

Table 6. Impacts of organic fertilizer on Na in soil

Treat- ment*	Cattle manure (CM) property			
	Sodium (mg Na kg <sup>-1</sup> )			
	Year			
	2003	2004	2005	Mean
C	29.00	84.50	101.00	71.50 bc
NV	31.50	76.00	74.00	60.50 ab
SV	24.25	59.50	76.75	53.50 a
20 CM	31.50	76.25	82.00	63.25 ab
40 CM	39.00	63.75	74.00	58.92 ab
60 CM	46.50	93.00	99.50	79.67 ab
Mean	33.63	75.50	84.54	64.56
LSD	Year		Fertil.	Interaction
	9.24		13.07	ns

\* C = control; NV = natural vegetation; SV = spring vetch; CM (kg/tree)

According to Pizer (1967), Na content of the soil was determined to be different with the applications as compared to the control but not to be significant. Differences were identified between applications and between the applications and year\*applications. The highest Na value was obtained in the 60 kg fertilizer application. It was determined that there were no differences between the years.

### Conclusion

In terms of the effect of the organic matters applied to the fields where fig is grown on the physical and chemical properties of the soil, the total salt content of the soil increased as compared to the control but it was at the lowest level in 2005 in terms of years. While the



relationship between the applications and between year\*applications was insignificant in terms of pH value of the soil, the relationship between the years was found to be significant. Organic matter content of the soil increased with the applications and the best increase was obtained in the case of 60 kg cattle manure application. The highest N content was obtained in the spring vetch and cattle manure applications. In the case of years, the highest N content was obtained in 2005, i.e. in the third year and this shows us that the organic matter turned to nitrogen. While the highest P and K amounts were obtained in the cattle manure applications, it was determined that the year and applications had a significant effect in the case of P and the applications were effective in the case of K. In the case of Ca and Mg contents, it was determined that the cattle manure applications were more effective in Mg content but spring vetch applications in N value and that years were effective on all three elements. In consequence, it was determined that what increased the nutrient content of the soil in fig growing was 60 kg cattle manure, followed by 40-30 kg cattle manure and spring vetch.

### References

- Aksoy U., Seferoglu G., Mısırlı A., Kara S., Sahin N., Bülbül S., Düzbastılar M. (1992). Selection of the table fig genotypes suitable for Egean Region. I. In: Proceedings of the First National Hortic. Congress. (in Turkish) pp. 545-548.
- Aksoy U., Anaç D. (1994). The effect of calcium chloride application on fruit quality and mineral content of fig. Postharvest 93 Int. Symp., Hungary. Acta Horticulturae 368, pp. 754-762.
- Aksoy U., (2001). Ecological Agriculture: An Overview, Turkey 2. Ecological Agriculture Symposium,s:3-10, Antalya.
- Aksoy U., Anaç D., Seferoğlu H.G. (1991). Differences in soil characteristics in fig trees improve shoot quality and fruit quality (in Turkish). Soil Science Association Symposium, oral presentation.
- Aksoy U., Anaç D., Hakerlerler H., Düzbastılar M. (1987). Nutritional Status of Germencik Region Sarılop Figs Gardens and Their Relations Between Some Nutrient Elements and Some Yield and Quality Characteristics, Tarış -Arge P. No: 006.
- Anaç D., Aksoy U., Hakerlerler H., Düzbastılar M. (1991). Nutritional Status of İncir Gardens in Küçük Menderes Basin, Relationships Between Some Soil and Leaf Nutrient Elements and Some Yield and Quality Characteristics, Tarış-Arge. Anonymous (1980). Soil and plant Testing and Analysis as a Basis of Fertilizer Recommendations, F.A.O Soils Bültein, 38/2 p 95.
- Çağlar K.Ü. (1958). Soil. Ankara Üniversitesi Publications, No: 10.
- Hernandez F.B.T., Modesto J.C., Suzuki M.A., Corrêa L.S., Reichardt K. (1994). Effects of irrigation and nitrogen levels on qualitative and nutritional aspects of fig-trees (*Ficus carica* L.). Sci. agric. (Piracicaba, Braz.) vol.51 no.2.554.
- Jackson M.L. (1958). Soil Chemical Analysis. Prentice-Hall, Inc., Englewood Cliffs, N.J.
- Kacar B. (2009). Soil analysis. Nobel publication Distribution, Ankara.
- Kellog C.E. (1952). Our garden Soil. The Macmillan Company, New York.
- Klein J.D., Lurie S. (1990). Prestorage heat treatment as a means of improving postharvest quality of apples. J. Amer. Sot. Hort. Sci. 115:265-269.
- Loue A. (1968). Diagnostic Petiolaire De Prospection. Etud Sur La Nutrition et. La Fertilisation Potasiques De La vigne. Societe Commerciale Des Potasses d'Al sace services Agronomiques, 31-41.
- Olsen S.R., Dean L.A. (1965). Phosphorus (Ed. C. A. Black) Methods of Soil Analysis. Part 2. American Society of Agronomy. Inc. Publisher Madison Wisconsin U.S.A. 1965, 1035-1049.

- Pizer N.H. (1967). Some Advisory Aspects Soil Potassium and Magnesium. Tech. Bult. N. 14-184.
- Raese J.T. (1989). Physiological disorders and maladies of pear fruit. Hortic. Rev. 11:357-411.
- Schlichting E., Blume H.P. (1960). Bodenkundliches Praktikum. P. 209. Series No:9. ASA Inc. Pub. Madison, Wisconsin. USA. Pp. 1179-1237.
- Shear C.B. (1975). Calcium-related disorders of fruits and vegetables. Hort. science 10 (4):pp. 361-366.
- SOEL (2005). SOEL (Fondation for Ecology and Agriculture) Survey, February.
- U.S.Salinity Laboratory Staff (1951). "Diagnosis and Improvement of Saline and Alkaline Soils" Handbook 60, Washington, D.C.

## **THE QUALITY CHARACTERISTICS OF INDUSTRIAL TOMATO AND THE NUTRITIONAL STATUS OF THE LEAVES IN INDUSTRIAL TOMATO GROWN IN THE MEANDER BASIN**

Saime SEFEROGLU\* Nur OZDOGAN

Adnan Menderes University Faculty of Agriculture Soil Science and Plant Nutrition Department -  
Aydın/TURKEY

\*Corresponding author: sseferoglu@adu.edu.tr

### **Abstract**

This research was carried out to investigate the nutritional status of industrial tomato in the lower basin of Great Meanderos. For this reason, soil, leaf and fruit samples were taken from 39 different areas where industrial tomato was grown. N, P, K, Ca, Mg, Fe, Zn, Mn, Cu and B in the leaf as well as width, length, weight, hardness, brix, pH and titratable acidity analyses in the fruit were done. The macro nutrients contents of the leaves were examined. While 76.92 % of total lands for N, 48.72% of total lands for P, and 56.41 % of total lands for K and Ca levels were found as low, Mg values were sufficient. When the contents of micro-elements of leaves were examined, in all samples, Fe contents were found at low levels. Mn levels of 61.54% of leaves were found as insufficient, but Cu, Zn and B elements were determined as sufficient. According to results of fruit morphological analysis, it was observed that fruits had the desired quality criteria for industrial tomato.

Keywords: *Industrial tomato, plant nutrient content, fruit quality*

### **Introduction**

Homeland of tomato is the narrow western coast of America extending from the equator to Chile and it spread all over the world from Mexico. Tomato growing which first started in Adana and Thrace in our country after the World War I spread throughout the country over time (Bayraktar, 1970). A significant part of world's tomato paste production takes place in Spain, Italy, Turkey, Chile, Portugal, Greece and Brazil as well as USA and China. Turkey occupies the fourth place with 11.350.000 tons of production over an area of 300.000 hectares in the world (FAO, 2013). When tomato growing is studied by regions, the top three places are occupied by the Mediterranean, Aegean and Western Black Sea regions.

In tomato growing, higher water retaining capacity of the soil has an affirmative influence on the plant growth and yield. The soil should have a pH value between 5.5 and 7.0. Nutritional element need of industrial tomato through its vegetative organs is 35-50 kg nitrogen, 10-13 kg phosphorus, 60-85 kg potassium, 75-90 kg calcium and 22-30 kg magnesium over an area of one hectare. For one ton of tomato fruits, 1.5-2.5 kg nitrogen, 0.6-1.0 kg phosphorus, 3.5-5.0 kg potassium, 0.20-0.25 kg calcium and 0.25-0.40 kg magnesium are needed (Colakoglu, 1985).

A plant nutrition should be provided at a balanced and sufficient amount in order to obtain crops of high quality and yield. For the enhancement and maintenance of soil productivity, plant nutritional elements removed from the soil together with the crop and lost through different ways should be added to the soil again. In this way, the amount of plant nutritional elements in soil may be maintained at a level which may satisfy the requirements of the plants grown.

The objective of this study is to determine the nutritional statuses of the fields of industrial tomato which has recently started to be grown in the Lower Meander Basin of Aydin. It is to determine whether or not the plots of land are suitable for industrial tomato growing and the shortages of nutritional element through the analyses carried out on the plant samples taken from these plots.

### **Material and Methods**

Samples of soil, leaf and fruit comprising the research material were taken from 39 sampling plots to represent the areas where industrial tomato is grown in the Lower Meander Basin in 2012 and sample leaves were taken at the leaf harvest time and fruit samples at harvest time appropriate for tomato. Analyses were carried out in the Soil Science and Plant Nutrition Laboratory of the Faculty of Agriculture of the Adnan Menderes University.

Upon the suggestion of ZER Tomato Paste Factory, the growers applied 30-100 kg/da of 15:15:15 composed fertiliser; 20-50 kg/da of 21% ammonium sulphate fertiliser; 20-40 kg/da of 33% ammonium nitrate and, in addition to all these, 10-20 kg/da of potassium nitrate or complex liquid fertiliser made from leaves (mixed micro element fertiliser) to the plots of study.

The total nitrogen content of the leaf samples was measured by modified Kjeldahl method; phosphorus by the vanadomolybdo phosphoric yellow colour method on samples made ready for analysis by applying wet decomposition; K, Ca and Na contents in plant extract in a flame photometer and Mg, Fe, Zn, Mn and Cu in an Atomic Absorption Spectrophotometer (AAS) (Kacar and Inal, 2008).

On fruit samples, fruit width-length, fruit weight, hardness (hand-held penetrometer), water soluble dry matter (Brix), pH, titratable acidity analyses were carried out on 25 fruits selected from each plot at random (Karacali, 2009).

### **Results and Discussion**

Minimum, maximum and average values concerning the analysis results of the plant samples taken from the plots where industrial tomato is grown in the Lower Meander Basin are given in Table 1 and Table 2. The limit values of the tomato plant are evaluated according to Jones et al. (1996).

As given in Table 1, it was determined that the total nitrogen values of the leaves varied between 1.747% and 4.637 percent. In the study carried out on industrial tomato seedlings by Guler (1990), it was determined that the N values of the seedlings varied between 0.18% and 0.76 percent. In the study carried out on greenhouse tomato prior to the first harvest by Kaplan et al. (2004), it was determined that the nitrogen values of the plants were 2.79-4.99% at Kumluca and 2.82-4.36% at Finike. When classified according to Jones et al. (1996), it was determined that the 76.92% of the plots was at deficient and 23.08% sufficient level by the plant nitrogen values. Importance should be placed on nitrogenous manure for quality tomato growing on these plots. Plant phosphorus values are between 0.151% and 0.429% in Table 1. In Guler's study (1990) tomato's P value was determined to be 2.04-4.26% and in that of Kaplan et al. (2004), to be 0.21-0.49% at Kumluca and 0.18-0.48% at Finike. Phosphorus values of the tomato plants were at a deficient level by 48.72% and sufficient level by 51.28% according to Jones et al. (1996). It will be therefore better for the nutrition of the tomato plants to add phosphorous fertiliser in the soil of the basin.

It was determined in Table 1 that the plant potassium values varied between 0.655% and 3.580 percent. In the study carried out on industrial tomato seedlings by Guler (1990), it was determined that K value was 0.29-1.88% and in that of Kaplan et al. (2004), it was determined

that it was 1.69-4.11% at Kumluca and 1.32-3.80% at Finike. When K values were classified according to Jones et al. (1996), it was determined that 56.41% of the plots was at a deficient level and 43.5% at sufficient level. Importance should be placed on using potassium fertiliser in the deficient plots in order to be able to obtain fruits of better quality.

Table 1. Plant Macro Nutritional Element Contents (%)

Samples No	N(%)	P (%)	K (%)	Ca (%)	Mg (%)	Na(%)
1	2.37	0.17	1.91	4.86	1.14	0.09
2	2.42	0.18	0.88	5.35	1.76	0.38
3	1.85	0.16	1.20	4.46	1.66	0.15
4	1.98	0.22	2.39	3.67	1.68	0.09
5	2.60	0.15	0.94	4.86	1.74	0.05
6	2.49	0.17	1.76	4.16	1.78	0.15
7	2.09	0.19	1.33	4.16	1.75	0.08
8	3.00	0.23	1.40	4.76	1.73	0.17
9	2.50	0.26	1.01	5.95	1.73	0.16
10	2.83	0.23	1.68	3.96	1.76	0.10
11	2.56	0.22	1.61	3.37	1.73	0.10
12	2.37	0.18	0.66	7.93	1.69	0.21
13	3.25	0.23	1.99	2.97	1.77	0.10
14	3.23	0.16	1.54	6.64	1.67	0.14
15	1.75	0.42	1.40	7.33	1.05	0.03
16	2.24	0.25	1.61	7.83	1.67	0.10
17	1.79	0.23	1.20	6.05	1.66	0.05
18	2.87	0.21	2.48	3.57	1.04	0.14
19	3.99	0.27	2.92	2.58	1.7	0.13
20	4.47	0.32	3.29	1.88	1.09	0.13
21	3.85	0.23	2.06	2.18	1.63	0.19
22	4.64	0.33	3.10	3.96	0.82	0.21
23	2.83	0.25	2.56	2.18	0.75	0.06
24	3.49	0.30	2.74	2.97	1.49	0.09
25	3.43	0.26	2.83	2.08	1.36	0.25
26	4.07	0.32	2.83	1.49	1.65	0.26
27	4.08	0.27	2.74	2.87	1.63	0.21
28	4.10	0.23	2.56	1.98	1.24	0.16
29	3.62	0.32	3.19	2.08	0.72	0.06
30	4.30	0.25	3.58	1.49	1.15	0.07
31	3.38	0.22	3.01	1.78	1.48	0.10
32	4.38	0.25	3.10	1.39	1.63	0.13
33	3.16	0.31	2.23	2.97	0.6	0.09
34	2.56	0.16	0.77	5.45	1.65	0.27
35	3.57	0.26	2.83	3.57	1.08	0.10
36	4.12	0.26	2.83	4.36	0.58	0.17
37	4.22	0.43	3.01	2.58	0.42	0.17
38	3.77	0.26	2.06	4.86	0.47	0.25
39	3.99	0.36	3.10	2.38	0.35	0.06
Opt.	3.19	0.25	2.16	3.82	1.00	0.14
Max.	4.637	0.429	3.580	7.930	1.78	0.383
Min.	1.747	0.151	0.655	1.388	0.35	0.033
std deviation	0.846	0.066	0.823	1.784	0.46	0.074
std error	0.135	0.011	0.132	0.286	0.073	0.012

Calcium values of the plants vary between 1.388% and 7.390% in Table 1. Guler (1990) found the Ca value as 0.20-0.83% and Kaplan et al. (2004) as 3.01-5.45% at Kumluca and 2.77-5.88% at Finike. When classified according to Jones et al. (1996), 56.41% of the plots were determined to be at a deficient and 43.59% at a sufficient level. Therefore, attention should be paid to calcium fertilising of the tomato plants included in the calcium-philic plants group, and foliar fertilising may be preferred so that the plant may take in calcium better in cases where deficiency is too severe.

As given in Table 1, magnesium values of the plants vary between 0.35% and 1.78 %. Guler (1990) determined the Mg value as 0.26-1.22% and Kaplan et al. (2004) as 0.71-2.26% at Kumluca and 0.80-2.07% at Finike in the study he carried out on greenhouse tomatoes. When classified according to Jones et al. (1996), it was determined that 2.56% of the plots was at deficient level, 17.95% at sufficient and 79.49% at high level in terms of magnesium values. No significant problem was observed in terms of magnesium nutrition. Ca and Ca+Mg were applied to the tomato plants growing in soil with a slightly acidic character and it was determined that the total yield and amount of water-soluble dry matter per unit area increased. It was found out that calcium has an affirmative effect on blossom-end rot (Candilo, 1993). As given in Table 1, the plant sodium values vary between 0.033% and 0.383%. Guler (1990) determined the Na of the leaves to be 1.67% and 4 %.

Table 2. Plant Micro Nutritional Element Contents

Samples No	Fe (ppm)	Mn (ppm)	Zn (ppm)	Cu (ppm)	B (ppm)
1	16.13	27.3	36.54	21.7	59.66
2	11.13	27.4	24.73	160.9	73.57
3	8.92	21.4	34.86	45.9	68.06
4	9.76	36.5	23.75	22.3	54.06
5	18	46.7	23.28	22.2	71.51
6	9.43	82.4	25.05	21.3	57.32
7	5.61	26.7	20.95	25.7	73.29
8	4.4	29.4	26.24	25	70.02
9	11.53	29.2	30.55	51.9	109.44
10	12.91	55.7	21.24	13	64.04
11	9.55	46.3	37.01	19.7	67.13
12	20.43	70.5	29.4	56.9	68.25
13	12.77	51.4	20.62	56.6	63.67
14	9.54	47.8	33.9	26.7	61.90
15	23.03	52.2	29.97	62.5	114.55
16	12.45	56.7	27.04	19.3	50.88
17	15.42	40.1	16.91	14	71.89
18	7.88	27.3	33.1	24.5	49.57
19	7.71	43.7	23.34	18.2	54.90
20	10.06	30.6	27.15	18.9	55.64
21	10.04	28.9	24.42	17.8	62.36
22	22.06	42.5	24.77	17.1	134.19
23	14.48	41.9	25.78	14.9	51.72
24	6.71	37.2	20.76	14.6	64.04
25	3.47	25.8	39.02	28.8	254.32
26	7.83	23.1	31.07	22.2	243.63
27	19.89	37.4	27.99	21.2	65.91
28	26.05	32.6	30.29	35.8	237.01
29	8.26	23.7	28.68	15.4	55.92
30	18.72	24.8	33.56	31.1	67.85
31	18.57	23.2	28.19	23.1	67.22
32	8.31	21.3	36.12	65.1	147.32
33	3.94	32.8	27.92	15.8	81.56
34	8.38	31.3	27.61	91.6	115.95
35	6.16	25.6	26.97	18.6	55.64
36	5.97	21.9	36.64	23.3	52.84
37	3.2	30.9	34.26	19.5	41.45
38	17.43	58	26.96	18.9	43.41
39	6.46	70.8	39.28	16.8	40.89
Opt.	12	38	29	31.76	83.14
Max.	26.05	82.40	39.28	160.90	254.32
Min.	3.20	21.30	16.91	13.00	40.89
std deviation	5.88	15.14	5.56	27.45	52.97
std error	0.94	2.42	0.89	4.40	8.48

As given in Table 2, the plant iron values were determined to vary between 3.20 and 26.05 ppm. In the study carried out on in the seedling period of the industrial tomatoes by Guduk (1990), he determined that Fe contents were 340-1660 ppm. As a result of the study which Kaplan et al. (2004) carried out on greenhouse tomatoes in the towns of Kumluca and Finike, they found the plant Fe contents to be 54.80-79.60 ppm at Kumluca and 55.00-84.00 ppm at Finike. When classified according to Jones et al. (1996), iron values of the plants show deficiency in all of the plots. While 2.56% of the plots was deficient, 5.13% critical, 79.49% sufficient, 7.69% high and 5.13% toxic by the soil iron values, the fact that all plots are at an insufficient level by plant limit values constitutes a contradiction (Ozdogan and Seferoglu, 2015). The reason for this situation may be considered to be the fact that the high pH and calcium levels of the soil prevents the plant from taking in iron.

Manganese contents of the plants were determined to be 21.30-82.40 ppm given in Table 2. While it was determined in the study carried out by Guduk (1990) that the Mn content of the leaves was 54-350 ppm, it was determined to be 92.4-426.60 pm at Kumluca and 61.00-304.00 at Finike by Kaplan et al. (2004). It is in consistence with the indicated values.

Manganese values of tomato plant are classified according to Jones et al. (1996) and it was determined by the manganese values of the plants that 61.54% of the plots was at deficient level and 38.46% at sufficient level.

As given in Table 2, it was determined that the zinc values of the plants varied between 16.91 ppm and 39.28 ppm. In the study which Guduk (1990) carried out on industrial tomatoes, he determined that the zinc values of the plants varied between 21 ppm and 97 ppm. Kaplan et al. (2004) determined that the plant zinc values varied between 20.60 ppm and 183.40 pm at Kumluca and 21.60 ppm and 164.20 ppm at Finike. According to Jones et al. (1996), zinc values of the plants were at a deficient level in 2.56% of the plots and sufficient level in 97.44% thereof. It was determined that there was no significant problem with zinc.

As given in Table 2, the copper values of the plants vary between 13.00 ppm and 160.90 ppm. In the study carried out by Guduk (1990), Cu values in the seedling period were found to be between 10 ppm and 348 ppm. Kaplan et al. (2004) determined that the Cu values were 12-328 ppm at Kumluca and 6-382 ppm at Finike. According to Jones et al. (1996), it was determined that 38.46% of the plots was at a sufficient level and 61.54% thereof was at an excessive level and that there was no problem in terms of copper.

When one examines the boron values of the plants in Table 2, they vary between 40.89 ppm and 254.32 ppm. In the study he carried out, Guduk (1990) determined the B values of the leaves varied between 17 ppm and 45.5 ppm. According to Jones et al. (1996), 76.92% of the plots were determined to be at a sufficient level and 23,08% at a high level in terms of boron. In the plots with a high boron level, irrigation water analyses must be definitely carried out.

Analysis results of the fruits picked from the plots selected to represent the Lower meander Basin and taken in a manner which will represent each plot best are given in Table 3.

As given in Table 3, according to the physical fruit analysis results, fruit length were found as 47.77-72.46 mm and fruit width as 43.25-66.07 mm. Fruit weight was determined as 54.78-170.56 g and 92.59 g on average and fruit hardness between 1.95-3.83 kg/cm<sup>2</sup> and 2.41 kg/cm<sup>2</sup> on average. In the study carried in the Lower Meander Basin by Dura (2001), he determined the fruit weight of industrial tomato as 53.94 g on average and the hardness value as 1.811 kg/cm<sup>2</sup> on average, and they show similarities to those values.

In tomato fruits, pH analysis results were found to be between 4.16 and 4.63 and 4.35 on average and the industrial tomatoes grown in the area were determined to have proper pH values. The average pH value of the industrial tomato had been determined as 4.61 in a study carried out in the region earlier (Dura, 2001). pH value of the tomato fruits varies between 4,0 and 4.5 (Jones, 2008). pH is required to be between 4.2 and 4.4 in industrial tomatoes (Diez et al., 2008).

Table 3. Fruit Morphological Analysis Contents

Samples No	Size (mm)	Most (mm)	Weight (g)	Hardness (kg/cm <sup>2</sup> )	pH	WSDM (%)	Titrateable Acidity (%)
1	59.73	50.82	92.92	3.83	4.31	5.8	0.448
2	60.16	49.63	90.28	2.52	4.16	5.8	0.449
3	59.01	51.74	95.18	1.97	4.4	5	0.378
4	53.66	50.43	69.46	2.45	4.29	5	0.362
5	63	56.67	105.77	2.29	4.23	5.6	0.455
6	58.14	47.92	79.86	2.05	4.47	4.6	0.333
7	61.81	52.2	91.92	2.94	4.31	5.4	0.413
8	72.46	56.97	129.5	2.16	4.28	5	0.402
9	70.27	60.35	137.16	2.17	4.26	4.6	0.388
10	59.05	51.18	102.94	2.17	4.37	4.8	0.424
11	65.62	56.52	117.37	2.57	4.22	5.2	0.482
12	57.56	49.52	90.4	2.35	4.31	4.8	0.343
13	65.29	51.43	104.84	2.82	4.63	5	0.365
14	54.76	46.95	70.11	2.9	4.28	5.4	0.53
15	69.68	54.88	116.33	2.54	4.49	4.4	2.432
16	61.97	57.16	108.06	2.1	4.43	4.6	0.315
17	61.68	51.83	96.25	1.98	4.36	4	3.328
18	68.85	66.07	170.56	1.96	4.39	5.2	0.349
19	61.63	53.31	90.14	2.05	4.57	6	0.364
20	59.2	51.19	87.61	2.29	4.24	5.8	0.518
21	57.45	51.5	84.53	2.48	4.3	5	0.401
22	62.83	53.67	99	2.24	4.3	5.2	0.501
23	61.78	53.85	98.26	2.05	4.45	4.6	0.321
24	60.24	54.65	97.81	1.95	4.47	4.4	0.331
25	58.92	49.13	77.39	2.3	4.43	5.8	0.414
26	56.4	46.9	70.87	2.85	4.38	5.6	0.439
27	55.23	51.2	80.4	2.12	4.35	5	0.356
28	58.98	50.79	84.84	2	4.55	5.4	0.347
29	58.02	46.95	70.76	2.18	4.33	6.2	0.471
30	60.85	50.41	85.43	2.74	4.24	5.4	0.546
31	66.52	53.16	102.78	2.22	4.35	5	0.421
32	56.88	46.51	70.98	2.94	4.22	6	0.596
33	66.6	53.54	103.64	2.3	4.31	5.4	0.38
34	59.49	49.48	78.06	2.42	4.26	5.4	0.498
35	61.97	49.42	81.33	2.56	4.29	5.3	0.443
36	56.26	49.91	84.65	2.61	4.33	5	0.417
37	48.62	43.25	54.78	2.6	4.29	5	0.577
38	54.96	46.35	78.48	2.54	4.43	5.2	0.39
39	47.77	44.98	60.47	2.7	4.27	5.8	0.434
Opt.	60.341	51.601	92.593	2.408	4.347	5.197	0.548
Max.	72.460	66.070	170.560	3.830	4.630	6.200	3.328
Min.	47.770	43.250	54.780	1.950	4.160	4.000	0.315
std deviation	5.301	4.327	21.703	0.378	0.104	0.500	0.563
std error	0.849	0.693	3.475	0.061	0.017	0.080	0.090

Water soluble dry matter values were found between 4.00% and 6.20% and 5.20% on average. In the industrial tomato variety study he carried out in the Lower Meander Basin, Dura (2001) found the highest brix value as 5.60% in the Sun-8687 variety. Yoltas et al. (1993), found the highest brix value as 5.36% in the Shasta variety as a result of their studies in the basin. Five percent and higher WSDM is required in industrial tomato varieties (Diez et al., 2008). In the varieties developed in industrial tomato breeding by Francis et al. (2002), they found the WSDM value between 4.65% and 5.32 % When compared with other studies, the average of the brix values so determined is observed to be good.

According to the results of the titrateable acidity analysis carried out on industrial tomatoes, a value between 0.32% and 3.33% and 0.55 on average was obtained. The titrateable acid amount is approximately 0.6% in tomato fruits (Karacali, 2009).



## **Conclusions**

In the plots of land where industrial tomato is grown in the Lower Meander Basin in Aydın, according to the results obtained upon the examination through plant and fruit analyses, nitrogenous fertilisation was found to be insufficient in a majority of the plots by the leaf analysis results while the 48.72% of plots was found to be deficient and 51.28% thereof sufficient in terms of P contents. In 56.41% of the plots, potassium values show deficiency and attention should be paid to fertilisation. Despite the soil contains Ca at a sufficient level, the Ca contents of the leaves were found to be deficient and Mg contents to be sufficient. Importance should be placed on Ca fertilisation.

In terms of micro nutritional elements, Fe was found out to be low in all plots and Mn, Zn and Mg to be at sufficient level. And B content was found out to be usually at a sufficient level, but to be high in very few plots. Irrigation water analysis should be carried out in those plots with high B content.

Looking into the values of the fruit analyses carried out on the fruit samples taken from the study plots, it is determined that the results have proper values in terms of width, length and weight measurements as well as pH, brix and acidity which are important fruit quality criteria for industrial tomato. Nutritional problems experienced in the plant do not reduce the quality criteria in the fruit, but increase varying between 7 tons and 9 tons per decare may be achieved in yield by overcoming the nutritional problems.

Selection of proper variety as well as nutritional element requirement of industrial tomato should be taken into consideration according to the results of the soil analysis to be carried out prior to sowing. First of all, that farmers should be made conscious on fertilisation and that necessary importance should be placed on the addition of organic matter and other technical practices along with well-balanced fertilisation are included in the most important issues for quality and highly efficient production in tomato cultivation.

## **References**

- Bayraktar K. (1970). Vegetable growth. Ege Uni. Agricultural Faculty Press No; 169, Izmir.
- Candilo M., Silvestri G.P. (1993). Calcium and magnesium fertilization of processing tomatoes in Basilicata and Puglia. Hort. Sci. 7(1993): 3-6.
- Çolakoğlu, H.1985. Fertilizer and fertilization. Ege Uni. Agricultural Faculty Press No: 17, İzmir.
- Diez M.J., Nuez F. (2008). Handbook of Plant Breeding, (Edit by: Prohens, J., Nuez F.) Vol:II. ISBN: 978-0-387-74108-6 e-ISBN: 978-0-387-74110-9, p:249-327.
- Dura S. (2001). Studies on determination of industrial tomato varieties suitable for growing at different periods in Büyük Menderes Basin (Aydın). Adnan Menderes Uni. Agricultural Faculty PhD thesis. BB-DR-2001-0004.
- FAO (2013). [www.fao.org](http://www.fao.org) (erişim 30.05.2013).
- Francis D.M.,Berry S.Z., Aldrich T., Scaife K., Bash W. (2002). Ohio OX150 Hybrid Processing Tomato, Report of Tomato Genetics Cooperative, Number:52, September 2002, University of Florida, USA, pp:36-37.
- Güdük S. (1990). Determination of soil and plant micro nutrient conditions in industrial tomato seedlings. Ege University Institute of Science and Technology, Master Thesis.
- Jones J.B. (2008). Tomato plant culture: in the field, greenhouse, and home garden, CRC Press, Boca Raton, 339p.
- Jones J.B., Mills H.A. (1996). Plant Analysis Handbook II. ISBN1-878148-052. Printed in the United States of America.

- Kacar B., İnal A. (2008). Bitki Analizleri. Nobel Yayın Dağıtım, Ankara.
- Kaplan M., Orman Ş. (2004). Determination of the nutritional status of tomato plants grown in the greenhouses of Kumluca and Finike regions. Journal of Akdeniz University Agricultural Faculty, 2004, 17(1), 19-29.
- Karaçalı İ. (2009). Storage and Marketing of Horticultural Products Ege Uni. Agricultural Faculty Press, Izmir, 494s.
- Özdoğan N., Seferoğlu, S. (2015). The soil properties of the agricultural land on industrial tomato cultivated in the Lower Menderes basin. Journal of Adnan Menderes University Agricultural Faculty, 12(2): 109-115.
- Yoltaş T., Baş T., Duman İ., Dura S. (1995). Determination of industrial tomato varieties with superior yield and technological properties suitable for growing in the Menderes Basin (Aydın). SANDOM Project. Publication No: 9 Pp: 114-119.
- Yoltaş T., Vural H., Duman İ., Hepaksoy S. (1993). Determination of the Effects of Different Planting Spaces on Yield and Quality Properties in Industrial Tomato Production in Biga Region. SANDOM Project. Publication No: 7, Pp: 25-33.

## EFFECT OF PHOSPHORUS FERTILIZER AND SOIL BORON STATUS ON YIELD AND QUALITY OF SOYBEAN

Mehmet AYDIN, Seçil KÜÇÜK KAYA\*, Mustafa Ali KAPTAN

Department of Soil Science and Plant Nutrition, Adnan Menderes University Faculty of Agriculture, Turkey

\*Corresponding author: secilkucuk@adu.edu.tr

### Abstract

Irrigation water is one of the main sources of high soil B levels resulting in toxicity. Thermal water containing high level boron; may be used as irrigation water. This study has been carried out based on previous experiment in which different levels of boron contained irrigation water on the cotton cultivation in 2011 and 2012 as the same coordinates were used. The aim of this study was to determine the effect of phosphorus fertilizer in different levels of boron contained soil conditions on yield and quality of soybean. The study was conducted as a split plot experimental design. The main plots were different level B contained soil (1.45, 3.26, 6.64 and 13.28 mg B kg<sup>-1</sup>), sub plots were phosphorus applications (0 and 7 kg P<sub>2</sub>O<sub>5</sub> da<sup>-1</sup>). Soybean (*Glycine max* L. Umut 2002) cultivar was used. As the soil B level reach the toxic level, seed yield, plant height, 1000 seed weight, number of pods per plant and first pod height decreased. On the other hand, protein content of seed, leaf P and B contents increased under B toxic conditions. Phosphorus application resulted in increase in seed yield and plant height, while leaf B content resulted in decrease under B toxic conditions. Its effect on the other observed parameters were not important. In terms of decreasing plant B content in high/toxic level B contained soil, phosphorus applications were effective and may be used to increase the yield.

**Keywords:** *Glycine max*, boron toxicity, phosphorus, seed yield

### Introduction

Soybean has been the most valuable food source of Asian countries for thousands of years (Hymowitz and Newell 1981, Singh 1992). It is consumed mostly in Asia, and it is regarded as a source of protein and fat in more industries in the west (Singh, 1992). Soybean is one of the most important agricultural products in the world because of rich nutritional value, minerals and vitamins (Stauffer, 2003). Soybean is an important leguminous plant, both production and international trade (Denis, 1994), it has high protein content. Additionally, its oil is the most produced and consumed oil in the world and its custard is the most used raw material in the feed industry (i.e. milk, cheese, sauce, ice cream etc. productions) (Stauffer, 2003). It is also used extensively in biofuel production. Soybean is used mainly in the feed industry as well as the food industry in Turkey. However, its production is insufficient for all of consumption and which imported every year in varying amounts. Phosphorus is an important macro element in the structure of nucleoproteins that plays a role in cell division and increases the resistance in plants by potassium uptake, root development and maturation (Brohi and Aydeniz, 1994). Depending on the application of phosphorus, the root development is increased and the root surface of the root is enlarged so that the utilization rates of other nutrients of the plants are increased (Marschner, 1995). Phosphorous fertilizers are highly effective in increasing seed yield and quality (Arıoğlu, 1994). However, the yield of seed may vary according to the variety of soybean used (Önder, 1987). Furthermore, the

seed yields in soybean varieties depend on the genotypic properties, but also influenced by differences in environmental conditions (Yaman and Cinsoy, 1997). On the other hand, many researchers indicated that phosphorus application into the soil could be sufficient to economic soybean seed production and growth (Çetin and Öztürk, 2012; Malik et al. 2006). Boron toxicity, which is one of the environmental factors, has a negative impact on the soybean growth and seed yield. Boron is a micronutrient element that is essential for good plant growth and good yield when evaluated in terms of plant nutrition. In addition, it is the only non-metallic element in micronutrients. Its deficiency or toxicity, leads to significant yield loss in plant. Due to its deficiency and toxicity range is very low in plants, the management of the boron in soil is very difficult (Nable, 1988). The main sources of boron toxicity are irrigation water, well water, application of drainage water to the soil, surface fertilization and industrial wastes and chemicals. However, the effects of boron toxicity are observed in the soil accumulation and dissolution of the soil (Shani and Hanks, 1993). The most important effect of irrigation water is that it causes soil boron content to increase in all of the potential sources. The boron concentration is generally high in salty soils or in saline well waters (Dhankhar and Dahiya, 1980). There is a high amount of boron in the water coming from the geothermal sources in Aydin (western Turkey). A significant part of these waters contaminate to irrigation water. The effect of the boron level on soybean development is not well known. The aim of this study was to investigate the effects of different levels boron-contained soil and phosphorus application in the soil on soybean plants growth morphological characters, yield and some quality parameters of the seed.

## Material and Methods

### *The Climatic Conditions*

Monthly average temperature, relative humidity and precipitation and long-term (1975-2013) values of experimental site were given in Table 1. The average temperature in august was higher than long term mean. Moreover, there was no precipitation observed in august.

Table 1. Some climatic parameters of experimental site in 2013 and long term

Years	Climatic Parameters	May	June	July	August	September	October	November
2013	Average Temperature (°C)	20.3	24.0	27.2	28.2	23.6	19.5	14.4
	Relative Humidity (%)	65.4	55.1	54.5	55.4	62.1	66.0	64.6
	Precipitation (mm)	17.8	44.8	0.6	0.0	36.8	37.0	78.5
Long Term	Average Temperature (°C)	20.9	25.9	28.4	27.5	23.4	18.4	13.3
	Relative Humidity (%)	74	49	47	48	52	60	66
	Precipitation (mm)	34.3	12.6	4.0	1.8	12.9	42.1	80

### *Soil Material*

At the beginning of the study, some physical and chemical properties of the soil from the control plot were given in Table 2.

Table 2. Some physical and chemical properties of soil

Texture <sup>1</sup>	Sand	Clay	Silt	Saturation	pH <sup>2</sup>	Salinity	Organic Matter <sup>3</sup>	CaCO <sub>3</sub>	N <sup>4</sup>
	%	%	%	(ml)		%	%	%	%
SL	72.90	10.10	17.00	39.4	8.35	0.0178	1.68	4.48	0.09
P <sup>5</sup>	K <sup>6</sup>	Ca <sup>6</sup>	Mg <sup>6</sup>	Na <sup>6</sup>	Fe <sup>7</sup>	Zn <sup>7</sup>	Mn <sup>7</sup>	Cu <sup>7</sup>	B <sup>8</sup>
					mg kg <sup>-1</sup>				
12	127	2502	202	75	7.96	0.41	2.79	1.23	1.45

1 Bouyoucos; 2 1:2.5 Saturasyon; 3 Walkley-Black; 4 Kjeldahl; 5 Olsen; 6 A. Asetat; 7 DTPA; 8 Azomethin-H

As a results of soil analysis, texture sandy loam, pH alkali, % total organic matter low and high CaCO<sub>3</sub> were found. In terms of soil nutrients was assessed, potassium, magnesium and zinc values were found deficient and boron, phosphorus, calcium, sodium, manganese and copper values were found sufficient. Additionally, soil Fe content was found critical.

#### **The Previous Experiment**

This research had been carried out at Adnan Menderes University Agricultural Faculty, in 2011-2012. The study had been designed in a split plot experimental design with four replications. In this study four different levels of boron (B) (0.6- 1.8- 5.4- 16.2 mg l<sup>-1</sup>) contained irrigation water had been used on the cotton cultivation. During the two years experiment, the total amount of applied water by drip irrigation had been 1039.9 mm. Sodium octaborate had been used as source of boron. After this experiment, barley had been cultivated at same coordinates in winter period 2012 to 2013.

#### **The Current Experiment**

This study was started after the barley harvest in 2013. Soybean (*Glycine max* L. Umut 2002) was used as a test species in this experiment. The amounts of soil available boron, accumulated in the soil at previous study, were evaluated as the boron levels in this experiment. The main plots were different level B contained soil (1.45, 3.26, 6.64 and 13.28 mg B kg<sup>-1</sup>) and sub plots were phosphorus treatments (0 (control) and 70 kg P<sub>2</sub>O<sub>5</sub> ha<sup>-1</sup>). The Boron levels were called B1-B2-B3-B4 and phosphorus also called P1-P2 respectively. As a source of phosphorus, triple super phosphate fertilizer was used and applied into soil before sowing. The other nutrients were kept on same levels.

#### **Observations and Plant Analyzes**

Before the plant nutrients analysis, when all the plants were harvested, developed leaves were collected from the middle of plant (neither young nor old leaves) for each replicate in all cultivars from both treatments. All leaves were immediately settled in an ice box for transfer to laboratory. All samples were washed twice with distilled water, dried at 70°C for 48 h. Leaf B concentration determinations were made by dry ashing 0.5 g of dry tissue material, placed in porcelain crucibles and heated a muffle furnace at 500°C for 6 h (Kacar and İnal, 2008). The ash was dissolved in 0.1 N H<sub>2</sub>SO<sub>4</sub> and B was determined colorimetrically (430 nm) by the Azomethine-H method (Wolf, 1974). P was determined by spectrophotometry (Shimadzu UV-160 A) (Kacar, 1972). 50 gram of seed were taken from each plots, and they were burned at 420 °C for 30 minutes. Nitrogen contents were determined by using Kjeldahl apparatus, protein content of seed was calculated as% by multiplying the resultant nitrogen amount by the coefficient of 6.25. The results were analyzed using the SPSS statistical software system (PASW Statistics, Ver.: 18.0). Mean separations were performed by the LSD-test at a significance level of P<0.05.

## Results and Discussion

It was determined that phosphorus fertilizer had a statistically significant impact on the soybean which cultivated in boron contaminated soil in Table 3 (ANOVA table).

Table 3. Results of variance analysis and LSD values for each characteristic examined for different boron and phosphorus

Variation Source	FD	SY	PH	TSW	NPPP	FPH	SPC	LPC	LBC
B	3	**	**	*	**	*	ns	**	**
P	2	*	**	ns	ns	ns	ns	**	**
B x P	3	ns	**	ns	ns	ns	ns	*	*
LSD <sub>0.05 B</sub>		23.12	6.17	7.6	14.3	0.28	-	1.95	8.9
LSD <sub>0.05 P</sub>		11.54	5.15	-	-	-	-	-	12.1
LSD <sub>0.05 BxP</sub>		-	14.29	-	-	-	-	-	-

B: Boron, P: Phosphorus, SY: Seed yield, PH: Plant height, TSW: 1000 seed weight, NPPP: Number of pods per plant, FPH: First pod height, SPC: Seed protein content, LPC: Leaf phosphorus content, LBC: Leaf boron content.

Seed yield, plant height, 1000 seed weight, number of pods per plant, first pod height, leaf P contents, leaf B contents were found statistically significant in terms of boron application. Regarding the application of phosphorus, seed yield, plant height, number of pods in plant, leaf P and B contents were found statistically significant but other characteristics were not significant. In terms of boron×phosphorus interaction, only plant height was found statistically significant and other features were found insignificant.

Table 4. The residual effects of different boron applications and the effect of phosphorous fertilizer on some properties of soybean

Treatments	Seed Yield (kg da <sup>-1</sup> )	Plant Height (cm)	1000 Seed Weight (g)	Number of Pods per Plants (piece plant <sup>-1</sup> )	First Pod Height (cm)	Seed Protein Content (%)	
P1	B1	321	98.2	156	79.1	13.12	30.3
	B2	322	97.4	155	78.0	13.32	31.5
	B3	251	76.7	147	65.6	10.40	32.2
	B4	145	65.4	139	45.2	9.89	32.1
Mean	260	84.4	149	66.9	11.68	31.5	
P2	B1	335	101.3	154	81.1	13.24	33.2
	B2	336	103.4	153	82.0	12.56	32.7
	B3	265	82.2	148	67.5	10.78	31.8
	B4	158	71.0	138	44.1	9.76	32.5
Mean	274	89.5	148	68.6	11.59	32.5	

Seed yield was decreased while soil B content was increased (Table 4). Average seed yields were found 328, 329, 258 and 152 kg da<sup>-1</sup> in applications B1, B2, B3 and B4, respectively. According to B1, the yield of seed was decreased by 21.3% in B3 and 53.8% in B4. Phosphorus application caused a slight increase in seed yield. The average seed yields in control and 7 kg P<sub>2</sub>O<sub>5</sub> da<sup>-1</sup> applications were 260 and 274 kg da<sup>-1</sup>, respectively. Many researchers have also reported that soybean plants are adversely affected by boron toxicity (Schon and Blevins, 1990, Nable et al., 1997, Oluk and Latif, 2008). Many researchers have also reported that seed yields are increased by phosphorous fertilizers (Bhangoo and Albritton, 1972; Atakis and Arıođlu, 1983; Dadson and Acquah, 1984; Mercado Pineda et al., 1991; Çetin and Öztürk, 2012). On the other hand, this study is consistent with the finding that phosphorus fertilizer is effective in reducing plant B concentration in boron-high soils and therefore the yield can be increased (Soy and Güneş, 2003; Kaya et al., 2009). Plant

height, 1000 seed weight, number of pods per plant and first pod height were decreased while soil B content was increased, especially in B3 and B4 treatments (Table 4). Compared to B1, plant height decreased by 17.6% in B3 and by 28.9% in B4. Phosphorus application caused a slight increase in plant height. Similarly 1000 seed weight decreased by 4.8% in B3 and by 10.3% in B4. Phosphorus application was determined that no significant effect observed on 1000 seed weight. Number of pods per plant were decreased by B3 and B4 treatments 16.9% and 44.2% respectively under the B toxicity conditions. Similarly, first pod height was decreased in B3 (19.7%) and B4 (25.4%) under the B toxicity conditions. The protein contents of seed were not affected significantly under the both B and P treatments conditions. B toxicity has reduced plant weight has also been reported by different researchers (Nable et al., 1997; Sutton et al., 2007). Phosphorous fertilization which have increased has also been reported by many researchers who have increased plant height (Atakişi and Arıoğlu, 1983, Dadson and Acquah, 1984). It's known that, B toxicity reduced seed size also seed weight. Therefore, 1000 seed weight values was found similar to the findings of Torun et al., 2001; Bakoğlu and Ayçiçeği, 2005; Reid, 2010. The number of pods is closely related to the variety, our findings were found similar to Yetim (2008) findings, but higher than findings of Bakoğlu and Ayçiçeği (2005). Our first pod height values were found similar to Yetim (2008) findings, but lower than values of Sincik et al. (2005) findings. Soybean protein content is usually high and can vary according to many factors. Mercado Pineda et al. (1991) found no significant effect on seed protein content of phosphorus fertilization in field trials in Mexico. Our protein content values was found slightly below than the findings of Yılmaz and Efe (1998).

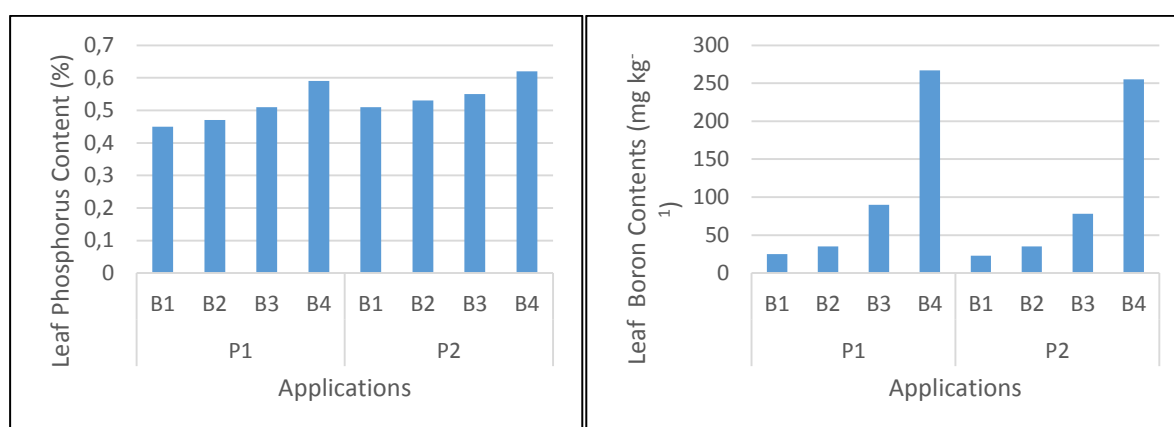


Fig 1. The effect of phosphorus application on the leaf phosphorus (left) and leaf boron (right) content in different soil B content conditions

Leaf P concentration values of B1, B2, B3 and B4 applications were 0.48, 0.50, 0.53 and 0.61% respectively (Fig 1). These values are higher than the critical P concentration of 0.25% (Jones et al., 1991) determined for soybean. This indicates that there is no P inadequacy in this study. The effect of phosphorus application on leaf P content was found significantly. Leaf P contents can vary depending on the available P content of the soil, fertilization and soil characteristics (pH, lime, Zn, etc.). Bhangoo and Albritton (1972) reported that phosphorus fertilizer effects on leaf P content were significant in studies conducted for three years in the USA.

The B1, B2, B3 and B4 applications and leaf B concentration values were found to be 24, 35, 85 and 261 mg B kg<sup>-1</sup>, respectively (Fig 1). These values are higher than the critical boron concentration of 21 mg B kg<sup>-1</sup> determined for soybean (Jones et al., 1991). B3 and B4 treatments were found toxic levels for soybean in particularly B4 treatment. The effect of phosphorus application on leaf B content was found significant. Leaf B content was decreased by an average of 104 mg B kg<sup>-1</sup> to 98 mg B kg<sup>-1</sup> by phosphorus application. Leaf B content is

more likely to vary depending on the B content of the soil, the irrigation water content of the irrigation water. Buyer and Öncel (2008) investigate the possible antagonistic activity of boron against boron toxicity in bread-borers (*Triticum aestivum* L. cv. Kirac 66) and susceptible pasta (*Triticum durum* Desf (cv. Kunderu 1149)). A similar finding has been reported by Kaya et al., 2009. A similar finding has been reported by Kaya et al., 2009. Güneş and Alpaslan (2000) stated that phosphorous fertilizer in corn production may be effective in reducing leaf B content.

### Conclusion

With this study, the use of phosphorous fertilizer has been discussed in the effect of high boron content of the soil, which continues to be a problem in the region, and the removal of this negative effect. It has been found that phosphorus fertilizers are effective in reducing plant B concentration in soil containing B in the high-toxic level, and thus the yield can be increased.

### Acknowledgement

This study was supported by a grant from Research Fund of University of Adnan Menderes, Aydın, Turkey (ZRF-14028).

### References

- Arıoğlu H. (1994). Oil Plants (Soybean and Peanut). CU Agricultural Faculty Textbook No: 35, p.1, Adana.
- Atakişi İ., Arıoğlu H.H. (1983). A study on the effect of fertilizer and bacterial applications on the yield and yield components of Calland soybean variety. Çukurova University Agricultural Faculty Yearbook, 14 (1): 28-41.
- Bakoğlu A., Ayciçeği M. (2005). Agricultural characteristics and seed yield of soybean (*Glycine max* L.) in Elazığ conditions. Firat University Bingol Vocational School, Field Crops Program, F. Ü. Journal of Science and Engineering Sciences, 17 (1), 52-58.
- Bhango M.S., Allbritton D.J. (1972). Effect of fertilizer nitrogen, phosphorus, and potassium on yield and nutrient content of Lee soybeans. *Agronomy Journal*, 64(6), 743-745.
- Brohi A., Aydeniz A. (1994). Plant nutrition. Gaziosmanpaşa Univ. Faculty of Agriculture, Yay. No; 4, Tokat.
- Çetin H., Öztürk Ö. (2012). Effect of Different Phosphorus Doses on Yield and Yield Components in Soybean. *Agricultural Science Research Journal* 5 (1): 157-161, 2012
- Dadson R.B., Acquah G. (1984). *Rhizobium japonicum*, nitrogen and phosphorus effects on nodulation, symbiotic nitrogen fixation and yield of soybean (*Glycine max* (L.) Merrill) in the Southern Savanna of Ghana. *Field Crops Research*, 9(2), 101-108.
- Denis J.M. (1994). Designer oil crops. *Breeding, Processing and Biotechnology*, 15-21. VCH, Weinheim.
- Dhankhar D.P., Dahiya S.S. (1980). The Effects of Different Levels of Boron and Soil Salinity on the Yield of Dry Matter and Its Mineral Composition in Ber (*Zizyphus rotundifolia*). *International Symp. On Salt Affected Soils*. Karnal, India. pp: 396-403.
- Hymowitz T., Newell C.A. (1981). Taxonomy of the genus *Glycine*, domestication and uses of soybeans. *Economical Botany*. 35: 272-288.
- Güneş A., Alpaslan M. (2000). Boron uptake and toxicity in maize genotypes in relation to boron and phosphorus supply. *Journal of plant nutrition*, 23(4), 541-550.



- Jones J.B., Wolf B., Mills H.A. (1991). Plant analysis handbook. Micro-Macro Publishing Inc., 213 p., USA.
- Kacar B. (1972). Chemical analysis of plants and soil. Bikki Analyzes. Ankara: Ankara University, Faculty of Agriculture Publications, 453.
- Kacar B., İnal A. (2008). Plant analysis. Nobel Publishing Distribution. Ankara.
- Kaya C., Tuna A.L., Dikilitas M., Ashraf M., Koskeroglu S., Guneri M. (2009). Supplementary phosphorus can alleviate boron toxicity in tomato. *Scientia Horticulturae*, 121(3), 284-288.
- Malik M.F.A., Qureshi A.S., Ashraf, M., Ghafoor A. (2006). Genetic variability of the main yield related characters in soybean. *Int. J. Agric. Biol.*, 8(6): 815-819.
- Marschner H. (1995). Mineral Nutrition of Higher Plants. 2nd Edition. Academic Press, Inc. London, G.B., p.446.
- Mercado-Pineda J., Marquez-Berber S.R., Sevilla P.E. (1991). Fertilizer use on three soybean cultivars (*Glycine max* (L.) Merrill) at Venta de Palula, Guerrero,. *Field Crop Abstracts*, 44(1): 42.
- Nable R.O., (1988) Resistance to boron toxicity amongst several barley and wheat cultivars: a preliminary examination of the resistance mechanism. *Plant and Soil* 112: 45-52.
- Nable R.O., Bañuelos G.S., Paull J.G. (1997). Boron toxicity. *Plant and Soil*, 193(1-2), 181-198.
- Oluk E.A., Latif N. (2008). The Effects of Boron Feasibility on the Growth and Development of Soybean Candy (*Glycine Max* (L) Merrill). *Erzincan University Institute of Science and Technology*, 1 (1), 27-38.
- Önder M. (1987). Relations between grain, fat and protein yield and yield components in soybean varieties with different levels of nitrogen combinations with nodosite bacteria (*Rhizobium japonicum*) in coniferous ecological conditions (Ph.D. thesis, Selcuk University Institute of Science and Technology).
- Reid R. (2010). Can we really increase yields by making crop plants tolerant to boron toxicity? *Plant Science*, 178(1), 9-11.
- Schon M.K., Blevins D.G. (1990). Foliar boron applications increase the final number of branches and pods on branches of field-grown soybeans. *Plant physiology*, 92(3), 602-607.
- Shani U., Hanks R.J. (1993). Model of Integrated Effects of Boron, Inert Salt, and Water-Flow on Crop Yield. *Agronomy Journal*, Vol: 85; 3 Pages: 713-717.
- Sincik M., Göksoy A.T., Turan Z.M. (2005). A research on the determination of the yield and yield components of some soybean (*Glycine max* (L.) Merrill) varieties in Bursa conditions. Turkey VI. Field Crops Congress, 5-9.
- Singh U.B. (1992). Tropical seed legumes as important human foods. *Singh. Economical Botany*. 46:310-321.
- Soy M., Güneş A. (2003). Effect of phosphorus on tomato (*Lycopersicon esculentum* L.) plant to prevent boron toxicity. *Journal of Agricultural Sciences*, 9 (3), 273-277.
- Stauffer C. (2003). Soy flour; applications and advantages. Preference for quality in soy flour. *Soybean Soup and Soya Unu Seminar Notes*. Adana.
- Sutton T., Baumann U., Hayes J., Collins N.C., Shi B.J., Schnurbusch T., Langridge P. (2007). Boron-toxicity tolerance in barley arising from efflux transporter amplification. *Science*, 318(5855): 1446-1449.
- Torun A., Gültekin I., Kalayci M., Yilmaz A., Eker S., Çakmak I. (2001). Effects of zinc fertilization on seed yield and shoot concentrations of zinc, boron, and phosphorus of 25 wheat cultivars grown on a zinc-deficient and boron-toxic soil. *Journal of plant nutrition*, 24(11), 1817-1829.

- Yaman M., Cinsoy A.S. (1997). The effect of bacterial inoculation and different nitrogen doses on yield and seed weight at soybean (*Glycine max* l. Merr.). Journal of Aegean Agricultural Research Institute, AARI, 7(1): 21-29.
- Yetim S. (2008). The second crop of nitrogen and iron fertilizer in the Gap region harran oil conditions affected the soy yield and some quality criteria. Doctoral dissertation. Ankara University Institute of Science and Technology. P. 173.
- Yılmaz H.A., Efe L. (1998). Some soybean (*Glycine max* L. Merrill) varieties in Kahramanmaraş conditions II. Possibility to be trained as a product. Tr. J. of Agriculture and Forestry, 22: 135-142.

## **NUTRIENT CONTENT OF SOME SILAGE SORGHUM VARIETIES GROWN AS SECOND CROP UNDER IGDİR ECOLOGICAL CONDITION**

Suleyman TEMEL<sup>\*</sup>, Bilal KESKİN, Hakki AKDENİZ, Baris EREN

Igdir University, Faculty of Agriculture, Department of Agronomy, Igdir, Turkey

<sup>\*</sup>Corresponding author: stemel33@hotmail.com

### **Abstract**

The research was conducted to determine feed quality of three Sorghum varieties (Rox, Early sumac and Leoti) two Sorghum bicolor x Sorghum sudanense varieties (Nutri honey and Hayday) and one Sudan grass variety (Gozde 80) grown as second crop under Igdir ecological condition. This research was established according to randomized complete blocks experimental design with three replications. In this study, Crude protein (CP), Neutral detergent fiber (NDF), Acid detergent fiber (ADF), Acid detergent lignin (ADL), Dry matter digestibility (DMD), Digestible energy (DE), Metabolizable energy (ME), Dry matter intake (DMI), and Relative feed value (RFV) of sorghum varieties was determined. According to results; The CP, NDF, ADF, ADL, DMD, DE, ME, DMI and RFV contents of some silage sorghum varieties ranged from 5.93 to 8.88%, 51.98 to 65.64%, 27.94 to 40.44%, 4.73 to 7.07%, 57.39 to 67.13%, 2.72 to 3.14 Mcal kg<sup>-1</sup>, 2.23 to 2.58 Mcal kg<sup>-1</sup>, 1.83 to 2.31%, 81.82 to 120.16, respectively. The highest DMD (67.13%), DE (3.14 Mcal kg<sup>-1</sup>), ME (2.58 Mcal kg<sup>-1</sup>), DMI (2.31%) and RFV (120.16), and the lowest NDF content (51.98%), ADF (27.94%) and ADL (4.73%) were determined in Rox variety. In the present study, it was found that Rox variety was suitable for animal feeding in terms of all desirable quality parameters examined except for CP. According to the results, Rox variety was suggested as second crop under Igdir province and similar ecological conditions.

**Key words:** Sorghum species and hybrids, second crop, feed quality, Igdir

### **Introduction**

All plants used for the aim of silage take an important place in animal feeding as it provides animal succulent feed especially in winter season. For this purpose, plant that is grown mostly for silage in the world is maize (Geren and Kavut, 2009; Ozata et al., 2012). But in the lands that unfavorable climatic conditions prevail for maize farming and are irrigation-free and nutrient-poor, alternative plant is undoubtedly the species of Sorghum (Barnes et al., 1995; Tiryaki 2005; Marsalis, 2011). Because the types of Sorghum, according to maize especially used as a silage are preferred as they are much more durable to hot and dry periods and dry matter yield is high (Cigdem and Uzun, 2006; Macedo et al., 2012). In field agriculture, the species of Sorghum with a short growth period provide important source for roughage for animals by being grown as second crop. Such environment conditions are too high in Turkey, alternative for maize, besides sugar beet leaves, various cereals, legume-cereal blends and sunflower plants, sorghum species are used as silage if less.

Sorghum, sudanese and Sorghum x Sudanese hybrids are C4 plant, thanks to their morphological and physiological properties especially during the summer when the temperatures are suppressed by continuing their growth and development produce a feed of higher quality and higher quality compared to cool-season forage crops. Generally these species produced for silage and green hay during the summer season, meet the agricultural

establishments' need for fresh feed and provide the animals with a delicious, succulent feed during this winter period. In addition, as Sorghum species and hybrids form more than once a year and after the form, they grow fast and gain importance in the provision of emergency feed needs (Grant et al., 1995; Acar et al., 2001; Ozaslan Parlak and Sevimay, 2007). In particular, the feed Sorghum when compared to other materials used for silage purposes; are preferred as they have a higher dry matter content, a lower milk acid formation, a lower undesirable butter and vinegar acid formation and pH values at desired levels (Baytekin et al., 1991; Uzun and Cigdem, 2006; Getachew et al., 2016). Therefore, the species of Sorghum have great precaution in animal feeding for reasons such as silage can be made without any additives.

In the types of Sorghum that have an important area use in the production of meat, and in particular in dairy farming enterprises, rotation pasture, daily green feedstuffs and silage production and the investigation of their ability of being grown especially while being considered as a silage bait, the knowledge of nutrient values such as crude protein, dry matter digestibility and energy content has great importance (Baytekin et al., 1996; Pedersen, 1996; Getachew et al., 2016). Additionally, after the harvest in early summer of the crops grown in the autumn, in giving birth to production of the not-used agricultural areas, identification of suitable forage crops species and varieties is important. Therefore, when a feed based on qualified roughages is intended, for high and high quality animal products (Pimentel et al., 2013), determination of high varieties of nutrient content suitable for regional ecology is seen as a great advantage. For this purpose, with this present study; types of fodder Sorghum and determination of nutrient contents of hybrids that are being examined in the province of Iğdir which is located in the east of Turkey and is different from region's areas due to climate and soil structure has been aimed.

### Materials and Methods

This study was carried out in the trial field of Iğdir University Agricultural Application and Research Center in 2015 with 3 stages according to the Randomized Blocks Experiment Design. The height of the test area from the sea level is 876 m. As plant material, 3 types of fodder (silage) Sorghum (Rox, Early sumac and Leoti) registered in Turkey 2 Sorghum x sudan grass hybrid (Nutri honey and Hayday) and a sudan grass (Gozde 80) are used. With the year of 2015 when the experiment was conducted and long-term average climate data are given in Table 1. Accordingly, the total amount of rainfall measured during vegetation (June-September) and average relative humidity values are lower than the average for many years, average temperatures are high. According to these results, the period during which the test was conducted was drier than the average for many years.

Table 1. Some climate features of Iğdir province for long years and growing season of 2015\*

Months	Temperature (°C)		Rainfall (mm)		Relative humidity (%)	
	Growing season	1950-2014	Growing season	1950-2014	Growing season	1950-2014
<b>June</b>	28.50	20.10	27.80	36.70	40.00	47.30
<b>July</b>	31.80	23.60	0.30	14.20	33.60	44.70
<b>August</b>	30.20	23.40	14.30	10.90	40.70	46.70
<b>September</b>	27.20	18.80	1.40	18.70	42.40	51.00
<b>Mean/Total</b>	<b>29.43</b>	<b>21.48</b>	<b>43.80</b>	<b>80.50</b>	<b>39.18</b>	<b>47.43</b>

\*MGM, 2015

Soil samples have been taken 0-20 cm deep from the area where the experiment was performed and some physical and chemical properties of the surveyed land have been determined. According to the results of analysis on the soil sample done by Soil Science and Plant Feeding Laboratory of Iğdir University, the soils in the test area; in alkali reaction (pH = 8.32) that has clay-loam and non-saline feature, the amount of organic matter is low (0.77%) and it is rich in lime content (20 and 34 %). Favorable phosphorus and potassium content in the soil have been determined to be 50.57 ppm and 544.80 ppm, respectively (Erdogan, 2013).

Sowings were manually done to the draws opened with marker for all varieties, for the decare 9523 pieces of seeds in 70 cm row spacing with 15 cm intra row on trial plots prepared in 5 m x 3.5 m dimensions after the harvest of barley on 24<sup>th</sup> of June 2015. In research, the plot length is 5.00 m, the width is 3.50 m and the plot area is 17.5 m<sup>2</sup>. After sowing, sprinkler irrigation was done to provide the germination and seedling emergence. Irrigation periods of plants were determined by soil water potential measuring device. Irrigation, when 50% of the useful water in the soil was consumed, was made with rain until plants reached 1.5 m length, after that it was made by flooding irrigation method. In the present study, 160 kg N and 80 kg P<sub>2</sub>O<sub>5</sub> were used each hectare for together with planting. All of the phosphorous fertilizer that was used and half of nitrogen fertilizer was used with planting and the other half of the nitrogenous fertilizer was given when the plants reached 50 cm. Ammonium sulphate (21% N) was used as a nitrogen fertilizer and triple super phosphate (40% P<sub>2</sub>O<sub>5</sub>) was used as a phosphorus source in the research. During the growing season of plants, the weeds emerged between the rows and above were controlled by the mechanical method of struggle.

The harvests of the plants were done manually during the hard dough stage. In each parcel one row from the edges and 50 cm from both sides were taken as edge effect and the remaining 8.4 m<sup>2</sup> (4.00 x 2.10 m) area was harvested. Then, a representative sub-sample (0.5 kg) of the cut material was dried at 78 °C in an oven for 48 h. Later, dried samples ground in a Wiley mill to pass through a 1 mm screen prior to analyses. All analyzes belonging to quality parameters were performed in double recurrence. The nitrogen content (N) of the samples was determined by the Kjeldahl method and the resulting N% value was multiplied by a factor of 6.25 to calculate the crude protein (HP) ratio (AOAC, 1997). NDF, ADF and ADL were measured by Van Soest et al. (1991) using the specified method. Rates of plants' % dry matter digestible (DMD) was determined by Sheaffer et al. (1995) with using the formula developed (DMD% = 88.9 – (0.779 x ADF%). Then the DMD values, digestible energy (DE) values of feeds were estimated with using the regression equation notified by Fomnesbeck et al. (1984). (SE = 0.27 + 0.0428 \* DMD%). Then SE values were converted to metabolic energy (ME) with using equation developed by Khalil et al. (1986). (ME Mcal kg<sup>-1</sup> = 0.821 \* SE (Mcal kg<sup>-1</sup>)). After that, by using the equations developed by Sheaffer et al. (1995) (DMI = 120 /% NDF), firstly dry matter consumption (DMI = 120 /NDF%) after that relative feed values (RFV) were calculated (RFV = DMD \* DMI/1.29). Data obtained in the study were subjected to analysis of variance according to the randomized blocks design of experiment using the SPSS statistical package program and in the comparison of the significant averages Duncan test was used (SPSS, 1991).

## Results and Discussions

In this study that aims to determine the varieties of sudanese, sorghum and hybrids that can be grown as second crop in Igdır geography that has microclima feature, it was determined that there were significant differences among the varieties in terms of CP (Table 2). According to these results, while the highest HP ratio was determined in the varieties of Nutri Honey and Hay Day that belong to Sorghum x Sudanese hybrids, the lowest values were obtained from Rox that belongs to Sorghum and Gozde 80 species that belongs to sudanese species. In a study on this subject, it was revealed that the Rox (%8.98) variety harvested during the hard drought stage has a lower HP ratio than early sumac (%10.20) and Gozde 80 (%10.10) species (Atis et al., 2012). Similar findings have been reported by Cigdem and Uzun (2006) in their study that related to some silage Sorghum varieties which can be grown as a second crop in order to determine nutritional content and they were determined that Rox varieties (8.98%) have a lower HP ratio than Early sumac (10.20%) and 80% (10.10%) varieties. This change between varieties in CP terms shows similar results to ours. Again, in second crop study conducted in Samsun, Aydın and Albayrak (1995) determined that 4 Sorghum (Fs 25E, Early Sumac, Leoti, Rox), 1 Sudan grass (Gozde-80) and 1 Sorghum x sudanese hybrid (Sugar Leaf) harvested in the period of soft dough stage had 8.3%, 8.9, 8.6, 6.9, 7.6 and 8.5 crude protein ratios, respectively. The CP content obtained in both studies was higher than our results; this may be due to the harvesting of varieties during early soft drought stage. With regard to the subject, Salman and Budak (2015) found that Nutri Honey variety had the mean 8.52% CP content in a study conducting in Bayındır and Odemis districts of İzmir. These results are slightly lower besides similar to our findings.

Table 2. CP, NDF, ADF, ADL, and DMD values of sorghum varieties

Varieties	CP (%)	NDF (%)	ADF (%)	ADL (%)	DMD (%)
Rox	5.93 <sup>c</sup>	51.98 <sup>b</sup>	27.94 <sup>b</sup>	4.73 <sup>d</sup>	67.13 <sup>a*</sup>
Early Sumac	8.12 <sup>ab</sup>	64.75 <sup>a</sup>	38.43 <sup>a</sup>	5.71 <sup>bcd</sup>	58.95 <sup>b</sup>
Leoti	7.90 <sup>ab</sup>	65.20 <sup>a</sup>	37.86 <sup>a</sup>	6.73 <sup>ab</sup>	59.40 <sup>b</sup>
Nutri Honey	8.88 <sup>a</sup>	65.64 <sup>a</sup>	37.95 <sup>a</sup>	6.39 <sup>abc</sup>	59.33 <sup>b</sup>
Hay Day	8.74 <sup>a</sup>	64.97 <sup>a</sup>	37.60 <sup>a</sup>	5.53 <sup>cd</sup>	59.60 <sup>b</sup>
Gozde 80	6.66 <sup>c</sup>	65.26 <sup>a</sup>	40.44 <sup>a</sup>	7.07 <sup>a</sup>	57.39 <sup>b</sup>

\*Values indicated with different letters are significantly different at P<0.01.

NDF ratios of Sorghum, Sorghum x sudan grass hybrid and sudan grass varieties grown as second crop showed statistically significant (Table 2). When Table 2 was examined, all of the other varieties except the Rox variety were included in the same statistical group and these varieties had the highest NDF ratio. This value obtained from the Rox variety is similar to the findings of Atis et al. (2012). The NDF content reflects the chemical quality of the herb and for this reason it is used in quality determinations (Kutlu, 2008). That NDF content is high in roughage reduces animal consumption (Yavuz, 2005). NDF ratios of the Sorghum obtained in the study are similar to the findings of Carmi et al. (2005) and Mwangi (2016), they are not similar to the results of Karadag and Ozkurt (2014). This can be said to be due to the

different ecological conditions, variety and agronomic practices in which the experiment was conducted. On the other hand, Uzun and Cigdem's (2005) study on the different Sorghum x sudan grass, they determined the mean NDF ratio of the varieties as 68.0% and these ratios are higher than our findings. It is thought that this may be caused as the used varieties are different and the agronomic applications are different.

Significant differences were found statistically in terms of ADF ratio among Sorghum, Sorghum x sudan grass hybrids and sudan varieties grown as second crop, in between Sorghum x sudan grass hybrids and sudan varieties (Table 2). While the lowest ADF ratio according to these results was determined in the Rox variety, all of the other varieties had a higher ADF ratio than the Rox and these took part in the same statistical group. The ADF content is an indication of the quality criteria of the grass chemically and has a feature that reduces the quality as it increases (Kutlu, 2008). As ADF ratio is inversely proportional to digestibility the varieties with a low ADF ratio are more important for animal feeding (Balmuk, 2012). In studies carried out with different types of Sorghum in different ecological conditions of Turkey, Atis et al. (2012) found that the lowest ADF ratio among varieties was 32.44% in Rox variety and also in Karadag and Ozkurt (2014) 39.46% in Rox variety, but these results were found higher than our results. Mwangi (2016) also found that the varieties of Sorghum harvested during the hard drought stage had a 41.98% ADF ratio in Kenya. This can be said to be due to the different ecological conditions and breeding techniques in which the experiments were conducted. In a study conducted again with x Sorghum x sudan grass hybrids, the varieties that are harvested during the spike season, they found the average ADF content was 42% (Uzun and Cigdem, 2006) and these values were higher than our findings. This is thought to be originated from differences of varieties that are used and their being harvested at different times

The ADL ratio of Sorghum, Sorghum x Sudanese grass hybrid and Sudanese grass varieties used in this study have been found important statistically and the ADL ratio of varieties has varied between 4.73% and 7.07% (Table 2). The highest ADL ratio was found in Gozde 80 and the lowest value was found in the variety of Rox. As related to the subject, Atis et al. (2012), in a study carried out in Antalya, found ADL ratios of Rox, Early sumac and Leoti Sorghum varieties as 4.62%, 4.62% and 4.86%, respectively and these values were higher than our results. Again, in a study conducted with three different varieties of Sorghum, Mahanta and Pachauri (2005) found that the average ADL content of the varieties was 4.21%, Mwangi (2016) found that the types of Sorghum had an ADL of 7.38% during the hard drought stage and these results are not compatible with the values obtained in our current study. This can be said to be due to the different ecological conditions, from variety, care and practice under which the tests were conducted.

Sorghum, Sorghum x sudan grass hybrid and sudan grass varieties examined in terms of DMD showed very important differences statically and the Rox variety has a higher dry matter digestibility (DMD) than the other varieties (Table 2). In a study conducted in Antalya with four types of Sorghum, the highest DMD ratio was determined in the Rox variety (63.92%), but these values were lower than our findings. It can be said that this is due to the difference in ecological conditions and agronomic work carried out by the experiment. On the other hand, the mean DMD ratio of examined Sorghum varieties in our study was determined as 61.82% and while these results are similar to findings of Carmi et al. (2005), but with the findings of Mwangi (2016). In another study conducted on the subject, Uzun and Cigdem (2006) have found the DMD ratio of Sweetreat, Sorgo 10, and Pioneer 931 big maize x sudan grass hybrids as 57.06% in the period of harvested spike season, but these results are lower than our findings. It is thought that this may be due to differences in used types and applied agronomic processes.

The digestible energy (DE) and metabolic energy (ME) values of the sorghum varieties used in the present study showed statistically significant differences and the highest values for both parameters were obtained from the Rox variety (Table 3). As seen in Table 3, SE and ME values of other varieties except for the Rox variety showed similarity and these five varieties had the same statistical group. Related to the subject, Sohail et al. (2011) have determined the mean ME value of sorghum varieties harvested during the soft drought stage as 2.08 Mcal kg<sup>-1</sup> and these values were lower than our findings. This can be said to be due to the different ecological conditions and varieties in which the experiments were conducted.

Among Sorghum varieties examined for dry matter intake (DMI), there was significant differences statistically and DMI ranged from 1.83% to 2.31% (Table 3). When looked at Table 3, it can be seen that the Rox variety has a higher DMI value than the other varieties. As related to the subject, Atis (2012) were found that the highest DMI among four Sorghum varieties was in the Rox variety with 2.32% and these results were similar to our findings.

Table 3. DE, ME, DMI and RFV values of sorghum varieties

Varieties	DE (Mcal kg <sup>-1</sup> )	ME (Mcal kg <sup>-1</sup> )	DMI (%)	RFV
Rox	3.14 <sup>a</sup>	2.58 <sup>a</sup>	2.31 <sup>a</sup>	120.16 <sup>a*</sup>
Early Sumac	2.79 <sup>b</sup>	2.29 <sup>b</sup>	1.85 <sup>b</sup>	84.68 <sup>b</sup>
Leoti	2.81 <sup>b</sup>	2.31 <sup>b</sup>	1.84 <sup>b</sup>	84.65 <sup>b</sup>
Nutri Honey	2.80 <sup>b</sup>	2.30 <sup>b</sup>	1.83 <sup>b</sup>	84.38 <sup>b</sup>
Hay Day	2.82 <sup>b</sup>	2.31 <sup>b</sup>	1.84 <sup>b</sup>	85.32 <sup>b</sup>
Gozde 80	2.72 <sup>b</sup>	2.23 <sup>b</sup>	1.83 <sup>b</sup>	81.82 <sup>b</sup>

\*Values indicated with different letters are significantly different at P<0.05.

Sorghum, Sorghum x Sudan grass hybrid and Sudanese varieties examined in relation to relative feed value (RFV) has shown important differences statically (Table 3). While the highest RFV in the study was found in the Rox range with 120.6, the RFV of the other five varieties were similar and it was included in the same statistical group. Atis et. al. (2012) determined the highest RFV in the Rox variety (114.6) among the four Sorghum types harvested during the hard drought stage, but this value was lower than our findings. This can be said to be due to the different ecological conditions, care and practice under which the tests were carried out.

### Conclusions

In this study, which is aimed to determine Sorghum, Sorghum x Sudanese grass hybrid and sudanese varieties which can be grown as second crop in Igdır geography, it has been revealed that the Rox variety was appropriate in terms of all quality parameters examined and it can be grown in similar ecologies in terms of animal nutrition.



## References

- Acar R., Akbudak M.A., Sade B. (2001). Sorghum-sudangrass hybrid. Konya Commodity Exchange Journal, 4(9):18-23.
- AOAC 1997. Official methods of analysis. Association of official analytical chemists. 16 th ed. 3rd revision. Arlington, VA, USA. p 125.
- Atis İ, Konuskan O, Duru M, Gozubenli H, Yilmaz S. (2012). Effect of harvesting time on yield, composition and forage quality of some forage sorghum cultivars. International Journal of Agriculture and Biology, 14 (6): 879-886.
- Aydın İ., Albayrak S. (1995). A study on yields of grass and crude protein in different shape times of some plants grown as second crops in Samsun ecological conditions. Journal of Agricultural Faculty of Ondokuz Mayıs University, 10 (3): 71-81.
- Balmuk Y. (2012). Determination of yield and yield characteristics of silage maize (*Zea mays* L.) varieties which can be grown as second crop in Konya Yunak conditions. Gaziosmanpasa University, Master's Thesis, Tokat, p.62.
- Barnes R.F., Miller D.A., Nelson C.J. (1995). Forages. An Introduction to Grassland Agriculture. Fifth Ed. Iowa State University Pres. Ames. Iowa. U.S.A.
- Baytekin H., Sağlamtimur T., Tansı V. (1991). Growing possibilities of species and varieties of sorghum as a second crop in the irrigation conditions of Cukurova region. Cukurova I. Agriculture Congress Proceedings Book, pp 114-152.
- Baytekin H., Tansı V., Sağlamtimur T. (1996). The effect of the seeding ration on the herbage yield and some agricultural characters of silage sorghum cultivars grown as second crop under irrigation conditions of harran plain. Türkiye III. Meadow-Rangelands and Forage Plants Congress, pp 753-760, Erzurum.
- Carmi A, Umiel N, Hagiladi A, Yosef E, Ben-Ghedalia D and Miron J. (2005). Field performance and nutritive value of a new forage sorghum variety 'Pnina' recently developed in Israel. Journal of the Science Food and Agriculture, 85(15): 2567-2573.
- Cigdem I., Uzun F. (2006). A study on some silage sorghum cultivars which can be cultivated as second crop at plains in Samsun. Journal of Agricultural Faculty of Ondokuz Mayıs University, 21(1): 14-19.
- Erdogan H.E. (2013). Soil Definition Guide., ISBN: 978-605-4672- 20-2.
- Fonnesbeck PV., Clark DH., Garret WN., Speth CF. (1984). Predicting energy utilization from alfalfa hay from the Western Region. Proceeding American Animal Science, 35: 305 - 308.
- Geren H., Kavut Y.T. (2009). An investigation on comparison of Sorghum (*Sorghum* sp.) species with corn (*Zea mays* L.) grown under second crop production. Journal of Agriculture Facult of Ege University, 46 (1): 9-16.
- Getachew G., Putnam D.H., De Ben C.M., De Peters E.J. (2016). Potential of Sorghum as an Alternative to Corn Forage. American Journal of Plant Sciences, 7: 1106-1121.
- Grant R.J., Haddad S.G., Moore K.J., Pedersen J.F. (1995). Brown midrib sorghum silage for midlactation dairy cows. Journal of Dairy Science, 78: 1970-1980.
- Karadag Y., Ozkurt M. (2014). Effect of different row spacings on the yield and quality of silage sorghum (*Sorghum bicolor* (L.) Moench) cultivars to be second crop grown. Journal of Agricultural Faculty of Gaziosmanpasa University, 31 (1): 19-24.
- Khalil JK., Sawaya WN., Hyder SZ. (1986). Nutrient composition of Atriplex leaves grown in Saudi Arabia. Journal of Range Management, 39: (2):104-107.
- Kutlu HR, 2008. Feed Evaluation and Analysis Methods (Course Grade). Adana, 2008, s.65.
- Macedo C.H.O., Andrade A.P., Santos E.M., Silva D.S., Silva T.C., Edvan R.L. (2012). Perfil fermentativo e composição bromatológica de silagens de sorgo em função da adubação nitrogenada. Revista Brasileira de Saúde e Produção Animal, Salvador, 13(2): 371-382.

- Mahanta S.K., Pachauri V.C. (2005). Nutritional evaluation of two promising varieties of forage sorghum in sheep fed as silage. *Asian-Australas Journal of Animal Sciences*, 18(12): 1715-1720.
- Marsalis M.A. (2011). Advantages of silage crops for quality: What is most important? *Western Alfalfa & Forage Symposium, Las Vegas, 11-13 December 2011*, 69-74.
- MGM. (2015). Prime Ministry DMI General Directorate Meteorological Newsletters. Ankara, Turkey.
- Mwangi P.G. (2016). Effect of stage of growth on nutritional value of dual purpose sorghum. Department of Animal Production Faculty of Veterinary Medicine College of Agriculture and Veterinary Sciences University of Nairobi, Master Thesis, p.67.
- Ozaslan Parlak A, Sevimay C.S. (2007). Possibilities of growing some forage plants as second crop after barley and wheat harvest. *Journal of Agricultural Sciences*, 13 (2): 101-107.
- Ozata E, Oz A, Kapar H, (2012). Determination of yield and quality traits of candidate silage hybrid maize. *Research Journal of Agricultural Sciences*, 5(1): 37-41.
- Pedersen J.F. (1996). Annual Forages: New Approaches for C-4 Forages, pp 246-251. In: J. Jannick (ed.), *Progress in new crops*. ASHS Press, Alexandria, VA.
- Pimentel J.J.O., Lana R.P., Oliveira A.S., Teixeira R.M.A., Abreu D.C. (2013). Dairy cows feeding with sorghum silage supplemented with concentrate. *Pesq. Agropec. Trop.*, Goiânia, 43(3): 255-261.
- Salman A., Budak B. (2015). A study on yield and yield properties of different varieties of hybrid sorghum x sorghum sudan grass (*Sorghum bicolor* x *Sorghum sudanense* stapf.). *Journal of Adnan Menderes University Agricultural Faculty*, 12(2): 93-100.
- Sheaffer C.C., Peterson M.A., Mccalin .M, Volene J.J., Cherney J.H., Johnson K.D., Woodward W.T., Viands D.R. (1995). Acide detergent fiber, neutral detergent fiber concentration and relative feed value. *North American Alfalfa Improvement Conference, Minneapolis*.
- Sohail H.K., Azim A., Sarwar M., Khan A.G. (2011). Effect of maturity on comparative nutritive value and fermentation characteristics of maize, sorghum and millet silages. *Pakistan Journal of Botany*, 43 (6): 2967-2970.
- SPSS Inc. (1991). *Statistical Package For The Social Sciences (SPSS/PC+)*. Chicago, IL.
- Tiryaki I. (2005). Sorghum: genetic origin, utilization, cultivation techniques and biotechnological advances. *Kahramanmaraş Sutcu Imam University Journal of Science and Engineering*, 8(1): 84-90.
- Uzun F., Cigdem I. (2005). Forage sorghum and sorghum –sudangrass hybrids. *Journal of Agricultural Faculty of Ondokuz Mayıs University*, 20 (2): 66-72.
- Van Soest P.J., Robertson J.B., Lewis B.A. (1991). Methods for dietary fibre, neutral detergent fibre and nonstarch polysaccharides in relation to animals nutrition. *Journal of Dairy Science*, 74 (10): 3583-3597.
- Yavuz M. (2005). Detergent fiber system. *Journal of Agricultural Faculty of Gaziosmanpaşa University*, 22 (1): 93-96.

## EFFECTS OF VARIETIES AND HARVESTING DATES ON YIELD, YIELD COMPONENTS AND TECHNOLOGICAL CHARACTERISTICS OF SUGAR BEET IN KAHRAMANMARAŞ CONDITIONS

Süreyya Gülfem ALTUNBAY\*

Sugar Institute, Department of Plant Breeding, Ankara, Turkey

\*Corresponding Author: sureyyagulfem@hotmail.com

### Abstract

The purpose of this study was to investigate the effects of different varieties and harvesting dates on yield, yield components and technological characteristics of sugar beet in Kahramanmaraş, Turkey. The experiment was conducted according to split plot experimental design with three replications 2011 and 2012. Sugar beet varieties (Dozer, Dioneta, Cassandra, Leila, Agnessa) in main plots and harvesting dates (8<sup>th</sup> September 2011, 27<sup>th</sup> September 2011, 10<sup>th</sup> October 2011, 1<sup>st</sup> November 2011; 12<sup>th</sup> September 2012, 1<sup>st</sup> October 2012, 20<sup>th</sup> October, 8<sup>th</sup> November 2012) in the sub-plots were placed. The variety x harvesting date interactions was significant, the investigated characters were changed according to variety, harvesting date. The highest sugar yield (9660.10 kg ha<sup>-1</sup>) were obtained from Agnessa, the highest root yield (60.05 ton ha<sup>-1</sup>),  $\alpha$ -amino N (0.062 mg 100 g<sup>-1</sup>), ash ratio (3.335 %), clear juice purity (87.25 %), dry matter percentage (23.22 %) were obtained from Leila variety. According to harvesting date for the highest root yield (50.88 ton ha<sup>-1</sup>), sugar yield (9570.15 kg ha<sup>-1</sup>) were obtained from third harvesting date,  $\alpha$ -amino N (0.06 mg 100 g<sup>-1</sup>), dry matter content (% 23.13) were obtained from fourth, the highest sugar content (16.44 %) were obtained from second harvesting date.

**Key Words:** *Sugar beet, variety, harvesting dates, root yield, sugar content.*

### Introduction

Sugar beet producing roots in first year and seeds in second year is a biennial herb grown. Sugar Beet is a major source of sugar in temperate countries. The crop matures in April-May. Original forms of sugar beet derived white Silesian beet, which are used as a fodder, contained only 4 % sugar. Repeated selection and breeding have raised the sugar content to its present level. Sugar beet is grown between 35 °N to 60 °N latitudes. It can be grown successfully in any region with temperature ranging from 12 to 45 °C during the crop season (October-May). The favourable soil temperature for the germination of sugar beet seed is around 15 °C. An average temperature for proper growth of the plants and sugar accumulation is about 20-22 °C. Temperatures above 30 °C retard sugar accumulation because of high respiration rate. Sugar beet prefers well-drained loam to clay loam fertile soil. The acidic soils are not suitable for raising sugar beet. Sugar beet profits are based on three key factors: sugar beet yield, sucrose content, sucrose recovery efficiency. Sugar beet yield include biomass, root and sugar yield, economic characters are storable root and percentage of sugar (Koocheki et al., 1996). Time of harvest is one of the factors that affects on yield and quality of sugar beet crop. The root dry matter percentage, increases with passing growth period of plant and amount of sugar reaches to 20-26 % at the time of harvest. Delay in sugar beet harvest till the end of autumn leads to decrease in sugar beet root and sugar yield and white sugar content (Laurer, 1995). The highest root yield (52.53 t ha<sup>-1</sup>) was obtained from early sown (5 April)

and late harvested (1 November) beet, while highest sugar content (% 17.4) was obtained from late sown and late harvested (1 November) beet (Akınerdem et al., 2008).

Sugar beet pre-harvest begins anytime from 1 September through 15 September whose purpose is to bring the processing factories into sugar production efficiently before full harvest begins. Full harvest usually begins about 1 October. Significant differences between harvest dates were determined for all measured traits (root yield, sugar content and raw sugar yield) in 2008 and 2010. With the delay of harvest date, root yield and raw sugar yield increased in 2008 and 2010. Sugar content was dependent on climatic conditions between two harvest dates. Heavy rainfall immediately before harvest date would lead to decrease of sugar content (Curcic et al., 2012). Selecting the proper time of harvesting is necessary to obtain the maximum yield, many investigators reported that delaying harvest date of sugar beet up to 200 or 210 days after sowing improved significantly the individual root characters and juice quality, as increased significantly root and sugar yields (Abd El Razek 2006). During harvest time, sugar beet growing degree days continue to accumulate, as does change, usually positive, in harvest weight (Draycott, 2006). Delaying harvest date up to 210 days from sowing gave the highest root dimension (length and diameter), root yield the best quality and root , sugar yields compared with harvesting at 180 days from sowing (Al-Sayed et al., 2012). Research determined that impurities within the root decreased between early and late harvest in each year of the trial; thus, sucrose concentration increased (Eckhoff, 1995).

### **Material and Method**

The study was established as 3 repetitions according to experimental design of split plot in growing season of 2011–2012 in Kahramanmaraş conditions in Turkey with five sugar beet species. The species (Dozer, Dionetta, Cassandra, Leila, Agnessa) were placed into main parcels, while harvest seasons (8<sup>th</sup> September 2011, 27<sup>th</sup> September 2011, 10<sup>th</sup> October 2011, 1<sup>st</sup> November 2011; 12<sup>th</sup> September 2012, 1<sup>st</sup> October 2012, 20<sup>th</sup> October 2012, 8<sup>th</sup> November 2012) were placed into sub-plots. Seed sowing was applied in 10<sup>th</sup> March by beet seeder of 5-rows, 80 kg N and 60 kg P<sub>2</sub>O<sub>5</sub> for each hectare and the plants were grown with irrigation. Irrigation was performed 5 times in 2011 (22<sup>th</sup> June, 6<sup>th</sup> July, 16<sup>th</sup> July, 27<sup>th</sup> July, 4<sup>th</sup> August) and in 2012 6 times (1<sup>th</sup> June, 19<sup>th</sup> June, 4<sup>th</sup> July, 17<sup>th</sup> July, 11<sup>th</sup> August, 27<sup>th</sup> August). In the study, root yield (ton ha<sup>-1</sup>), head+leaf yield (ton ha<sup>-1</sup>), root diameter (cm), root length (cm), bifurcated root ratio (%), head+leaf weight (g plant<sup>-1</sup>), root weight (g plant<sup>-1</sup>), sugar content (%),  $\alpha$ -amino N (mg 100 g<sup>-1</sup>), ash ratio (%), clear juice purity (%), dry matter percentage (%), marc content (%), sugar yield (kg ha<sup>-1</sup>), harvest index (%), leaf area index were investigated. Data regarding investigated features was analysed by using MSTATC statistical program package.

### **Result and Discussion**

It can be seen in the table 1 the highest root yield was obtained from Agnessa (57.50 ton ha<sup>-1</sup>) and Leila (56.92 ton ha<sup>-1</sup>) in the 2011, in 2012 respectively Cassandra (68.08 ton ha<sup>-1</sup>), Leila (64.17 ton ha<sup>-1</sup>). The lowest root yield were obtained from Dozer and Dionetta in both years. A similar result was seen in the both years and both years ratio. The lowest root yield was obtained Dozer (48.04 ton ha<sup>-1</sup>) and Dionetta (48.50 ton ha<sup>-1</sup>); the highest root yield was obtained from respectively Leila (60.54 ton ha<sup>-1</sup>) and Cassandra (59.08 ton ha<sup>-1</sup>) varieties in the both years ratio. There is a important differences among varieties in terms of years and year x variety interaction was obtained important.

The highest root yield was obtained from third harvest date (H<sub>3</sub>) (56.27 ton ha<sup>-1</sup>) in 2011, in the second year the highest root yield was obtained from (62.67 ton ha<sup>-1</sup>) last harvest date. In

the both years ratio the highest root yield obtained from third harvest date (58.87 ton ha<sup>-1</sup>). As harvest date was delayed, root yield increased; in the both years ratio even there is no important differences between harvest dates, there was insignificant decrease in the fourth harvest date.

The values regarding root yield in the study and formed groups are given in Table 1.

Table 1. Different Varieties and Harvesting Dates Values Regarding in Sugar Beet Root (ton ha<sup>-1</sup>)Yield and Formed Groups

Variety	2011	2012	Both Years Ratio
Dozer	44.67c	51.42c	48.04b
Dionetta	46.67bc	50.33c	48.50b
Cassandra	50.08b	68.08a	59.08a
Leila	56.92a	64.17ab	60.54a
Agnessa	57.50a	58.92b	58.21a
LSD (% 5)	0.43	0.62	0.35
Harvest Date *			
H <sub>1</sub>	49.00b	52.07b	50.53b
H <sub>2</sub>	48.13b	58.13ab	53.13b
H <sub>3</sub>	56.27a	61.47a	58.87a
H <sub>4</sub>	51.27b	62.67a	56.97a
LSD (% 5)	0.33	0.68	0.37
Years	51.17b	58.58a	Year LSD (%5):0.30
(*) 2011	8 <sup>th</sup> September (H <sub>1</sub> ) , 27 <sup>th</sup> September (H <sub>2</sub> ), 10 <sup>th</sup> October (H <sub>3</sub> ), 1 <sup>st</sup> November (H <sub>4</sub> );		
(*) 2012	12 <sup>th</sup> September (H <sub>1</sub> ), 1 <sup>st</sup> October (H <sub>2</sub> ) , 20 <sup>th</sup> October (H <sub>3</sub> ), 8 <sup>th</sup> November (H <sub>4</sub> )		

The values regarding to sugar content and formed groups are given Table 2.

Table 2. Different Varieties and Harvesting Dates Values Regarding in Sugar Content (%) and Formed Groups

Variety	2011	2012	Both Years Ratio
Dozer	16.86a	16.53a	16.69a
Dionetta	16.25a	15.17b	15.71b
Cassandra	15.53b	15.14b	15.33b
Leila	16.21ab	15.28b	15.74b
Agnessa	16.66a	16.52a	16.59a
LSD (% 5)	0.69	0.70	0.45
Harvest Date *			
H <sub>1</sub>	16.50b	16.09a	16.29a
H <sub>2</sub>	16.67b	16.20a	16.44a
H <sub>3</sub>	17.13a	15.64a	16.38a
H <sub>4</sub>	14.91c	14.97b	14.94b
LSD (% 5)	0.39	0.59	0.35
Years	16.30	15.73	Year LSD(% 5):0.39
(*) 2011	8 <sup>th</sup> September (H <sub>1</sub> ) , 27 <sup>th</sup> September (H <sub>2</sub> ), 10 <sup>th</sup> October (H <sub>3</sub> ), 1 <sup>st</sup> November (H <sub>4</sub> );		
(*) 2012	12 <sup>th</sup> September (H <sub>1</sub> ), 1 <sup>st</sup> October (H <sub>2</sub> ) , 20 <sup>th</sup> October (H <sub>3</sub> ), 8 <sup>th</sup> November (H <sub>4</sub> )		

In the two years and both years ratio the highest sugar content (%) was obtained from Dozer and Agnessa; the lowest sugar content was obtained from Cassandra variety. The low sugar content of Dionetta, Cassandra and Leila varieties is due to the high ash content of these varieties. In 2011, the highest sugar content was obtained from third harvest date (% 17.13), in 2012 was obtained from second (% 16.20) harvest date. In the both years sugar content decreased at last harvest date. Harvest date had greater effect than variety on yield, sucrose content, juice purity.

It seems that since 75 % of root dry matter includes sucrose (Tognetti et al. 2003), the reason for the higher sugar content at delayed harvest is the increase of the root dry matter percent. Postponing harvest time improved sugar beet quality but sugar content loss and technical quality of sugar beet after harvest and during storage (Malec, 1992). According to average values for two years, variety affected all traits except for marc content, while harvesting dates affected all traits except for harvest index, sugar yield, marc content, clear juice purity, and root weight. Interaction between variety and harvesting date was significant for all the investigated traits except for root height, marc content, sugar yield, harvest index, leaf area index. Biomass yield in 2012 increased due to the advances in harvest time, the highest biomass yields were obtained from fourth, in 2011 were obtained from third harvest date. In 2011, the lower biomass yields were obtained from fourth harvesting date, which can conclude that complete physiological maturity period. In 2012, compared to 2011 to obtain a higher yield of biomass and body, receiving more rainfall than in 2012, is said to be effective. The values regarding to  $\alpha$ -amino N and formed groups are given Table 3.

Table 3. Different Varieties and Harvesting Dates Values Regarding  $\alpha$ -amino N (mg/100g) and Formed Groups

Variety	2011	2012	Both Years Ratio
Dozer	0.037b	0.066ab	0.051c
Dionetta	0.043ab	0.061b	0.052c
Cassandra	0.045ab	0.068ab	0.057b
Leila	0.050a	0.073a	0.062a
Agnessa	0.046ab	0.074a	0.060a
LSD (% 5)	0.0094	0.0094	0.002
Harvest Date *			
H <sub>1</sub>	0.038b	0.068ab	0.053c
H <sub>2</sub>	0.035b	0.072a	0.054c
H <sub>3</sub>	0.039b	0.072a	0.056b
H <sub>4</sub>	0.065a	0.062b	0.064a
LSD (% 5)	0.075	0.0075	0.002
Years	0.044b	0.069a	Year LSD(% 5):0.015
(*) 2011	8 <sup>th</sup> September (H <sub>1</sub> ) , 27 <sup>th</sup> September (H <sub>2</sub> ), 10 <sup>th</sup> October (H <sub>3</sub> ), 1 <sup>st</sup> November (H <sub>4</sub> );		
(*) 2012	12 <sup>th</sup> September (H <sub>1</sub> ), 1 <sup>st</sup> October (H <sub>2</sub> ) , 20 <sup>th</sup> October (H <sub>3</sub> ), 8 <sup>th</sup> November (H <sub>4</sub> )		

Sugar beet quality is important issue, the main purpose to cultivate sugar beet is production of a maximum amount of white sugar. The sucrose content in the beet is a major factor affecting white sugar yield. The composition of sugar beet root affects the recovery of crystalline sugar in the factory considerably. Root impurities especially  $\alpha$ -amino N are important factors, which influence the production of white sugar yield. According to Table 3, in the first year of the trial the highest  $\alpha$ -amino N was obtained from Leila variety (0.050 mg/100g); the lowest was obtained from Dozer variety (0.037 mg/100g); in the second year the highest  $\alpha$ -amino N level

was obtained from Agnessa (0.074 mg/100g) variety. According to harvest date, in 2011 last harvest date gave the highest  $\alpha$ -amino N (0.065 mg/100g) level. In 2012 the highest  $\alpha$ -amino N was obtained from second and third harvest date (0.072 mg/100g). The harvest dates had significantly influenced on  $\alpha$ -amino N levels, the interaction year x harvest date and variety x harvest date had significant at the level of 5 % probability. Generally, the delay harvest date increased  $\alpha$ -amino N level.

### **Conclusion**

Since sugar beet variety trials are usually harvested at the end of the growing period, information about the effect of harvest date on yield and quality of sugar beet root can be very valuable.

In 2011, the highest sugar content was obtained from third harvesting date, 2012 was obtained from second harvesting date, sugar content decline in both years was observed. The most suitable sugar beet harvesting date should be done in the physiological maturity period, in the next period spend respiratory beet sugar produced from sugar can be concluded to be lower.

In 2011 and 2012, the fourth lowest sugar content at harvest began in this period of obtaining sugar content in rainy and cold weather and it can be stated that there was no adverse effect on the yield. In rainy and cold weather, excess water in the soil is absorbed by the sugar beet root; therefore beet-root sugar content decreased.

In the light of the results obtained in this study, delaying the harvest time in Kahramanmaraş conditions to increase the sugar content, it can be concluded that the optimal harvest date would be October 10<sup>th</sup> and 20<sup>th</sup> October.

### **References**

- Abd El-Razek, A.M. (2006). Response of sugar beet to planting date and number of days to harvest under North Sinai conditions. *Egypt. J. Agric. Res.* 84 (3).
- Akinerdem, F., Öztürk, Ö., Topal, A., Akgün, N. (2008). Effects on sowing and some quality characteristics of crop in sugar beet/Cereal rotation system. Volume 88, Issue 1, pages 141-150, January 2008.
- Al-Sayed, M.H., Abd El-Razek, U.A., Sarhan, H.M. and Fateh, H.S. (2012) Effect of harvest dates on yield and quality of sugar beet varieties. *Australian Journal of Basic and Applied Sciences*, 6(9), 525-529.
- Curcic, Z., Donojevic, D., Cacic, N., Nagl, N., Taski-Ajdukovic, K, Kovacev, L., (2012). Influence of Harvest Dates on Sugar Beet Quantitative Traits. *Nssem Journal*. 49:2141-145.
- Draycott, A.P. (2006). *Sugar Beet*. Blackwell Publishing Professional, Ames, IA.
- Eckhoff, L.A. (1995). Split application of nitrogen on irrigated sugarbeet. *Sugar Beet Res.* 32: 175-183.
- Koocheki, A., M. Hosieni and M. Nasiri Mahallati, (1996). *Relation of Water and Soil in Crops* Publications of Agriculture Science, Iran
- Lauer, J.G., (1995). Sugar beet performance and interactions with planting date, genotype and harvest date. *Agron. J.*, 89: 469–75
- Malec, J., (1992). Influence of sowing and harvesting dates on quality changes during storage. *Proc. Of the Meet. Of the Scient. Comm. Bratislava, Slovakia.* 15-17 June.
- Tognetti, R., Palladino, M., Minnocci, A., Delfie, S., Alvino, A., (2003). The response of sugar beet to drip and low-pressure sprinkler irrigation in southern Italy. *Agric. Water Manag.* 60: 135-155.

## WALNUT PRODUCTION IN TURKEY FROM PAST TO PRESENT

Yaşar AKÇA<sup>1\*</sup>, Sebahattin YILMAZ<sup>2</sup>

<sup>1</sup>Horticulture Department, Agriculture Faculty of Gaziosmanpaşa University, Tokat, Turkey

<sup>2</sup>Horticulture Department, Agriculture Faculty of Ahi Evran University, Kırşehir, Turkey

\*Corresponding author: akca66@gmail.com

### Abstract

Turkey is one of the main walnut producer countries in the world. In 2015, Turkey ranked fourth in world production with 180,807 tons of production. It can be said that main part of walnut trees in Turkey have been grown without using of pesticides and chemical fertilizers, so that production shows organic qualifications. Continuous seed propagation in Turkey has given rise to a great number of seedling walnut trees, which represent valuable walnut gene resources. The number of native trees is estimated to be over 9 million and they possess large genetic variability in yield, nut and kernel characteristics, late bud breaking, late flowering, winter hardiness, tolerance to diseases. Thousands of walnut trees had been cut down in the eastern part of Turkey and sold abroad after the 1980's. After recognition of the importance of propagation by grafting and budding by growers in recent years, the orchards are being established with standard cultivars. These standard walnut orchards are generally established with Californian and French cultivars. The Ministry of Food, Agriculture and Livestock and The Ministry of Forestry and Water Affairs of Turkish Republic have important new policy on walnut development program in Turkey. The most important climate restrictions for walnut production are spring frosts in Turkey. Turkish walnut breeding program is abounding with cultivar breeding. There are no adequate studies on rootstock breeding. Harvesting cannot be made mechanically because native trees are large in size. Turkey's walnut production is expected to increase about 40,000 tons in the next 10 years with the initiation of production from newly established orchards.

**Keywords:** *Walnut production, import, marketing.*

### Introduction

Turkey is one of the important gene resources of the world due to its position on Silk Road throughout the ancient ages. The history of walnut in Turkey is very old. In the tomb of King Midas in Gordion, near Polatlı in Turkey, it is determined by wood analyses that furniture embedded with King Midas had been made from *J. regia* L., *Taxus baccata* L., *Cedrus libani* Loud., *Juniperus foetidissima* Willd., *Buxus sempervernis* L. and *Pinus sylvestris* L. Members of the *Juglandaceae* family have been founded in Konya-Süber from Neolithic ages (Aytuğ, 1967). In the Akçaabat county of Trabzon province, a fossil walnut fruit was founded in the Plio-Quaternary sediment. The fossil had been completely and well protected (Aytuğ, 1987). In Turkey, many fruit species (walnut, almond, apricot, chestnut, and rosehip) have been propagated from seed over centuries. In this species, rich genetic resources occur throughout the country because of seed propagation. There are 4 districts, 12 towns and 40 quarter named with 'ceviz' means walnut in English in Turkey (Şen, 2005). Due to more suitable ecological conditions such as average temperatures, precipitation and soil characteristics and especially the interest of local peoples, walnut trees are spread almost in all regions of Turkey. The aim of this paper is to reveal the current situation of Turkey's walnut growing activities in different aspects and with changes that occur over time.



### Position of Turkey in production and trade

The most commonly grown walnut species in Turkey for fruit production is *Juglans regia* (Şen, 1986). Recently, *Juglans nigra* and *Juglans hindsii* are also being grown only for personal forestation and personal arboretum (Akça and Polat, 2017). But in recent years, timber walnut plantations have been established with *J. nigra* and *J. hindsii*.

Walnuts are generally grown in USA, Europe and Asia. Over 3.5 million tons shelled walnut are produced annually in the world (FAO, 2013). According to the FAO statistics, China leads production with 1.7 million ton, followed by the USA (425,000 t), Iran (454.000 t) and Turkey (212,000 t) (Table 1).

Table 1. Production area and production of countries

Countries	Production area (.000 ha)				Countries	Production (.000 ton)			
	2010	2011	2012	2013		2010	2011	2012	2013
China	350	420	425	425	China	1284	1665	1700	1700
EU-27	102	100	90	123	USA	456	418	425	425
USA	96	99	99	113	Iran	433	489	450	454
Turkey	91	93	99	108	EU-27	176	186	176	349
Mexican	69	68	69	72	Turkey	178	183	194	212
Iran	62	63	64	57	Ukraine	87	113	97	115
Indiana	31	31	32	32	Mexican	76	96	110	106
France	18	19	19	20	Indiana	38	36	40	36
Chili	15	16	18	19	Romania	34	35	31	32
Ukraine	14	14	14	14	Chili	32	37	38	43
Serbia	13	15	10	14	France	31	38	36	33
Greece	10	11	11	10	Greece	22	23	24	19
Egypt	4	3	4	4	Egypt	21	18	20	22
Romania	1	1	1	1	Serbia	21	24	15	22
Other	149	154	154	109	Other	269	186	298	115
World	911	990	995	999	World	2946	3312	3418	3445

According to the agricultural statistics of 2015 year in Turkey, walnut plantation area is around 86,853 ha, and the annual production is around 180,807 tons and the average yield is about 25 kg/tree, and the total number of walnut tree is 15,044,456. Turkey's annual shelled walnut import value is 34,285 ton and export values are significantly lower. (Turkstat, 2016) (Table 2).

Table 2. The value of Turkey walnut production and trade

Years	Production (ton)	Imports (ton)	Exports (ton)	Per person consumption (kg)
2007/2008	172 572	39 572	2 915	2.8
2008/2009	170 897	35 018	3 859	2.7
2009/2010	177 298	46 004	6 383	2.9
2010/2011	178 142	31 076	7 309	2.6
2011/2012	183 240	46 338	13 711	2.8
2012/2013	203 212	40 009	11 998	2.9
2013/2014	212 140	30 479	14 171	2.8
2014/2015	180 807	34 285	8 407	2.5

Government supported projects are being implemented to reduce walnut imports. The Ministry of Food, Agriculture and Livestock and also The Ministry of Forestry and Water Affairs of Turkish Republic have important new policy on walnut development in Turkey (OGM, 2012). Ministries give financial supports to the farmers who will establish walnut orchard. However, other regular orchards have been established by using Californian and French walnut cultivars without government support in the last 15 years.

### **Usage of walnut**

Walnut is named ‘Ceviz’ or ‘Koz’ in Turkish. Walnut has an important place in Turkish culture (Şen, 2005). The walnut tree is known as the protein tree in Turkey, with its fruit known to be an aphrodisiac and source of energy. Turkish people use the fruits, leaves, green husks and roots of walnut trees. Turkish people in undeveloped regions and rural areas get a large portion of their protein needs from walnut fruits. Bread with walnut is an indispensable nutrient for people in rural areas (Şen, 1986).

Turkish people use medicines from walnut foliage to prevent hair loss, in the treatment of pimples, in skin care, as a bath lotion and to fight parasites (Şen et al., 2006). Teas made from leaves are used for reducing triglyceride and cholesterol levels. Also, Turkish people believe that walnuts can strengthen the liver. It is believed that eating a preparation of walnut with fig, garlic and flower of rue (*Ruta graveolens* L.) prevents food poisoning. It is known that a little walnut foliage used in beach oils and perfumes ensure a good sun tan. However, there is no study, to our knowledge, reporting such an effect. In Turkish culture, it is believed that walnut fruit brings abundance and luck. Traditionally, meals have been made with walnut on holidays and special days. Nutritious and energizer meals especially for proteins and fats have been made by using walnuts in sweets. In Turkish cuisine, ‘kek’, ‘batrak’, ‘aşure’, ‘kek’, ‘cevizli helva’, ‘cevizli ekmek’, ‘baklava’, and ‘kadayıf’ are important meals made with walnut. In short, walnuts are multipurpose fruits in Turkish cuisine (Şen et al., 2006).

### **Propagation of walnut in Turkey**

In Turkey, walnut had been propagated only by seeds until 1970. The numbers of grafted saplings have increased to 2,5 million in 2016. Most commonly, the patch budding method is used for propagation of walnut in Turkey. Generative rootstocks of *J. regia* are used for budding (Ertürk and Akça, 2012). But, in recent years, Paradox and *Juglans hindsii* generative rootstocks have been started to use. Many studies on the propagation walnut plants with tissue culture continue in a lot of laboratories. Saplings are marketed potted or bare root. The price of the grafted walnut sapling is 4-5 Euro. In 2016, 250,000 grafted walnut saplings are exported to Spain, Bulgaria and Greece from Turkey (Various nurseries, personal comm.)

### **Breeding studies**

Walnut breeding studies are abounding with cultivar breeding. There are no adequate studies on rootstock breeding. Turkey is one of the important genetic resources of walnut and has been offering important opportunities to plant breeders with its genetical potential. Even so, there are many walnut types that are late leafing, resistant to diseases and insects and highly laterally fruitfull, and have good fruit quality. Especially, types that are resistant to bacterial blight (*Xanthomonas campestris* pv. *juglandis*), codling moth (*Cydia pomonella*), and anthracnose (*Gnomonia leptostyla*) are interesting (Akça, 2016).

The important problem of walnut production in Turkey is the damage of spring frosts. Turkish walnut cultivars are considerably early leafing and they bear fruits on terminal buds. The selection breeding method was the most widely used in walnut variety breeding of Turkey. Great number of selection study has been done among the rich native populations

(Akça and Şen, 2001; Akca and Ozongun, 2004; Karadağ and Akça, 2011; Simsek et al., 2011; Asma, 2012; Kirca et al., 2014; Akça et al., 2015). Superior walnut varieties that have high fruit quality were selected from native walnut populations of Turkey and then these selections have been released to use. All Turkish walnut cultivars were selections from native walnut populations until 2016. A few new cultivars obtained from crossing were released at the end of the 2016 year (TTSM, 2016). In initial breeding studies, breeders had mostly focused on fruit quality characters and chose large fruited trees. Other characteristics such as late leafing, lateral fruitfulness and resistance to disease and insects had been omitted. The walnut varieties with lateral fruiting and late leafing walnut types same as Californian cultivars have not been found from seedling population of Turkey by selection. And it is understood that it is hardly possible to found late leafing and also lateral bud fruitful genotypes in seedling walnut populations due to the degree of heritability and contraindications of these two characteristics.

Cross breeding method was used in only fourth studies until today (Akça, 2001; Sütyemez, 2008; Anonymous, 2012; Akça et al., 2016). Breeding efforts was focused to provide new walnut cultivars by crossing for the Turkish walnut industry. The primary objective of Turkish walnut scion breeding program was to develop new cultivars with late leafing, lateral bud fruitfulness, disease resistance, high yield, and good kernel quality (Anonymous, 2012). In walnut breeding program, late leafing parents were crossed with lateral bearing parents. In regions with late spring frosts in Turkey, late fruiting walnut varieties can be used economically. Therefore, new varieties are required with high fruit quality and yield that will not effected by spring frosts.

During 1998 and 2015 years, fourth main different variety breeding programs were made to find new walnut genotypes with late leafing, lateral bud fruitfulness and high nut quality. In first variety breeding program, Turkish walnut selections were crossed with Payne and between them in 1998-1999: ‘Niksar 1’ × ‘Niksar 2’, ‘Niksar 1’ × ‘Payne’, ‘Niksar 1’ × ‘Şebin’, ‘Turhal 1’ × ‘Niksar 2’, ‘Şebin’ × ‘Niksar 2’. 757 seedlings from controlled crosses were obtained in 1998 and 624 seedlings were obtained in 2000 (Akca, 2001). In second study conducted in Kahramanmaraş Sütçü İmam Üniversitesi in Turkey, 7239 F1 walnut plants had been obtained from 56 different crossing combinations (Sütyemez, 2008). In third variety breeding program, ‘Niksar 1’, ‘Şebin’, ‘Hartley’, ‘Topak’, ‘Chandler’, ‘Akça 2’, ‘Oğuzlar 77’, ‘Franquette’, ‘Sütyemez 1’, ‘Sütyemez 2’ and ‘Maraş 12’ walnut standard cultivars and selections were used between 2008-2012 by the support of TUBITAK. 1340 seedlings under evaluation from this breeding program (Anonymous, 2012). In fourth variety breeding program, between 2012-2015, the following controlled crosses were made to found the new walnut genotypes with tolerant to bacterial blight, late leafing and lateral bud fruitfulness, high nut quality: ‘Pedro’ × ‘Chandler’, ‘Pedro’ × ‘Fernette’, ‘Pedro’ × ‘Midland’, ‘Fenor’ × ‘Pedro’, ‘Fenor’ × ‘Chandler’, ‘Fenor’ × ‘Fernette’, ‘Fenor’ × ‘Howard’, ‘Fenor’ × ‘KZK1’, ‘Howard’ × ‘Fenor’, ‘Howard’ × ‘Chandler’, ‘Fernette’ × ‘Howard’, ‘Fernette’ × ‘Chandler’, ‘Fernette’ × ‘KZK 1’, ‘Chandler’ × ‘Kaman 1’, ‘Chandler’ × ‘KZK1’. A total number 1633 F1 seedling were obtained (Akça et al., 2016).

### **Genetic erosion**

In Turkish tradition, chests made of walnut wood have been gifted to girls to get married. Also an important portion of home furniture have been veneered with walnut wood. Villagers in rural areas that earn little money from walnut fruits have been cutting trees to sell as timber. Thousands of walnut trees had been cut down in the eastern part of Turkey and sold abroad after the 1980’s (Şen, 1986). Old and healthy trees were logged because of high timber prices that caused important genetic erosion and a decreased nut production. Recently, the

number of logged trees has decreased under pressure by the Civil Society Associations and legalities.

Due to regulations in acts, the preliminary condition to get a cutting license is the property of the land where the trees are needs to be belonging to someone other than state and non- forest area. Cutting of walnut trees in these properties needs a positive report that is given by a commission established by a forest engineers and an agronomists. A cutting license is issued after approval of the positive report of the commission by authorized offices. Unavoidable conditions of destruct are looked for giving a cutting license to walnut trees; these trees should not yield due to disease and age, trees should be damaged from natural disasters (flood, wind, strike, etc.), dried, left in compulsory construction and establishments like road, dam, etc, damage neighbor's property. Otherwise cutting of these trees are not permitted (Akça, 2016). However, genetic erosion has continued as a result of imported late leafing and laterally fruitful cultivars such as 'Chandler', 'Pedro' and 'Fernor', and senseless and unrestrained logging of native trees.

### **Important diseases and pests**

Most common diseases and insect pests observed in Turkey are anthracnose (*Gnomonia leptostyla*), bacterial blight (*Xanthomonas campestris* pv. *Juglandis*), root rot (*Phytophthora* spp.), codling moth (*Cydia pomonella*), and walnut aphids (*Chromaphis juglandicola*). In Turkey, there is no spraying against diseases and pests on the seedling-grown old walnut trees. However in walnut newly-established orchards, there are methodical spraying programs against to pests and diseases. Biological agents are not commonly applied. CLRV was determined in some walnut growing regions (Ozturk et al., 2008).

### **Harvest and post-harvest**

Harvesting cannot be made mechanically because native trees are big but rather with long sticks by hitting the branches. This operation affects and limits the following year's yield, and because of the long harvest time the kernel quality can decrease. In recent years, studies have been attempted to adapt shaker machines used in olive trees to walnut harvest.

Harvested fruits with a green husk are usually clumped together and kept for a long time for separation of the husk itself. This process causes darkening of the shell and kernel (Ünal, 2005). But, in the recent years, green husks of fruits are skinned with machine. Harvested walnuts must be dried as soon as possible and moisture content must be decreased to 4-5 %. Problems with the drying process of fruits in Turkish walnut production cause a loss of quality. Mechanically skinned walnuts are dried in shadow for 5-7 days. However, in recent years growers have been using drying machines in big orchards (Yalçın et al., 2012).

### **Organic walnut production**

It can be said walnut trees in Turkey have been grown without the use of pesticides and chemical fertilizers so that production shows organic qualifications (Ozkan, 2005). Furthermore, in recent years, in appropriate areas and policies have started to organic walnut production.

### **Processing of walnut and walnut industry**

Mechanization is not used in the cracking process of shelled walnuts but is rather done manually, in general, by women workers. Shelled walnuts are stored in cool storage and presented for consumption throughout the year. If the temperature can be dropped down to 3 °C, quality losses drop down to a minimum. Nuts can be stored between -15 °C to -20 °C without quality losses. Kernels are marketed in vacuum packages. Walnuts are commonly used in the dessert production industry. Also, by using mulberries and grapes special products such as ‘pestil’ and ‘köme’ are made. Walnuts also are used in ice cream and halva production, and in the dried fruit industry.

### **Marketing**

Marketing channels of walnut have been developed in Turkey. There is a lot of different walnut company. There are grower unions that marketed in local bazaars, markets and gather growers to market their production.

### **Conclusion**

Each year 2.5 billion grafted saplings have being produced by which thousands of hectares of walnut orchards have been planted in Turkey. As a result of newly established orchards, Turkey has started to produce standard walnuts. In orchards, 8×4, 7×7, 7×6, and 7×5 m planting distances are used. Unfortunately, the walnut growers indicate that important tree deaths in orchards with a Chandler cultivar. Drip and mini spring irrigation systems have been used in this orchard. Contestation with diseases and insects is being made well. Product of these orchards is being sold at 3 times higher prices than products of native trees.

Turkey’s walnut production is expected to increase about 40,000 t in the next 10 years with the initiation production of newly established orchards. Turkey will have exported walnuts and became an important producer.

### **References**

- Akca Y. (2001). Breeding of walnut varieties by cross breeding. (In Turkish). I. National Walnut Symposium. 5–8 September, Tokat-Turkey, pp. 53–63.
- Akça Y. (2005) Determination an overview of selection breeding studies carried out in Turkey and definition of characteristics for selection breeding of walnut. *Bahçe* 34, 29-34.
- Akça, Y. (2016). *Ceviz Yetistiriciliği (Walnut Cultivation)*. 9. Baskı. ISBN: 975-97498-07. Anıt Matbaası. Ankara, Turkey. (In Turkish)
- Akca Y., Bilgen Y., and Ercisli S. (2015). Selection of superior Persian Walnut (*Juglans regia* L.) from seedling origin in Turkey. *Acta Sci. Pol. Hortorum Cultus*. Vol. 14. No 3, pp. 103-114.
- Akca Y., Ertürk Ü., Yılmaz S., (2016). The improvement of walnut cultivars tolerant to bacterial blight. Unpublished dataset, cited with permission.
- Akça Y., Polat A. (2007). Present status and future of walnut production in Turkey. *The European Journal of Plant Science and Biotechnology*, (57-64).

- Akça Y, Özongun S. (2004) Selection of late leafing, late flowering, laterally fruitful walnut (*Juglans regia* L.) types in Turkey. *New Zealand Journal of Crop and Horticultural Science* 32(4), 337-342.
- Anonymous (2012). Studies on the development of walnut industry in Turkey. Project report of TÜBİTAK KAMAG 106-G 152. (In Turkish).
- Asma, B.M., (2012). Pomological and phenological characterization of promising walnut (*Juglans regia* L.) genotypes from Malatya, Turkey, *Acta Sci. Pol., Hortorum Cultus*. Vol. 11. No 4, pp. 169-178.
- Aytuğ B. (1967) A Study on the determination of the flora of Neolithic time in Konya-Süber, Istanbul University. *The Journal of Forestry*, 17, 2-13
- Aytuğ B. (1987) Le mobilier funéraire du roi midas. I. *Pact* 22, 357-368.
- Ertürk Ü, Akça Y. 2012. Overview of walnut culture in Turkey, *ISHS Acta Horticulturae* 1050: VII International Walnut Symposium
- FAO (2016) <http://www.fao.org/Statistical Databases>. Accessed on 05/03/2017
- Karadağ H, and Akça Y. (2011). Phenological and pomological properties of promising walnut (*Juglans regia* L.) genotypes from selected native population in Amasya Province *African Journal of Biotechnology*. Vol. 10, No 74, pp. 16763-16768.
- Kırca S., Yarılgaç T., Kırca L., Bak T. (2014). Study on the selection of walnut (*Juglans regia* L.) in Trabzon, *Turkish Journal of Agricultural and Natural Sciences*. Special Issue No 1, pp. 835:841.
- OGM (2012). <https://www.ogm.gov.tr/ekutuphane/yayinlar/ceviz%20eylem%20plan%C4%B1.pdf>  
Accessed on 05/03/2017
- Ozkan Y. (2005). Organic culture of walnut and the importance for Turkey. *BAHÇE*, 41 (2): 13 – 21.
- Ozturk, M. O., Sipahioglu, H. M., Ocak, M., & Usta, M. (2008). Cherry leafroll virus in *Juglans regia* in the Lake Van Basin of Turkey. *Journal of Plant Pathology*, 75-79.
- Simsek M., Uguz M.U., Erdogan M. K., Gul A., Karakoc S., and Digrak M. (2011). Selection studies on high quality walnut types and their antibacterial properties, *Journal of Medicinal Plants Research* Vol. 5, No 14, pp. 3269-3276.
- Sütyemez M. (2008). Research on developing new walnut (*Juglans regia*) cultivars by crossings among high yielding and high quality walnut types selected in the Kahramanmaraş province. Project report of TÜBİTAK No: 104 0 318. (In Turkish)
- Şen S. M. (1986) *Walnut Growing (Ceviz Yetiştiriciliği)*. Eser Printed Office. Samsun, Turkey, 229 pp. (In Turkish)
- Şen S. M. (2005) The past, present and future of walnut in Turkey. *Bahçe* 34, 15-22.
- Şen S. M., Kazankaya A, Yarılgaç T, Dogan A (2006) *Walnut from Orchard to Kitchen*. Maji Publications I. Ankara, 233 pp. (In Turkish)
- TTSM (2016). *Tescilli Çeşitler Listesi (Registered varieties)*. <http://www.tarim.gov.tr/BUGEM/TTSM/Sayfalar/Detay.aspx?SayfaId=87> Accessed on 05/03/2017
- Turkstat (2016). [http://www.turkstat.gov.tr/PreTablo.do?alt\\_id=1001](http://www.turkstat.gov.tr/PreTablo.do?alt_id=1001) Accessed on 05/10/2016
- Ünal H. (2005). Mechanization practices in the harvest and post-harvest stages in walnut growing. *BAHÇE Ceviz*, 34 (1): 193 – 203.
- Yalçın M., Acıcan T., Alibaş K., Ertürk Ü., Soylu A., & Yaşar A. (2012). Comparison of using different methods on walnut's (*J. regia* L.) fruit harvesting. *BAHÇE*, 41 (2): 13 – 21.

## DETERMINATION OF ADAPTATION AND QUALITY TRAITS OF SOME COOL SEASON TURF GRASSES IN SAMSUN CONDITIONS

Zeki ACAR\*<sup>1</sup>, Sedat ARSLAN<sup>1</sup>, Zeynep MALKOÇ<sup>1</sup>, Ertan ÖZ<sup>1</sup>, İlknur AYAN<sup>1</sup>

OMU Agricultural Faculty, Atakum, Samsun, Turkey

\*Corresponded author: zekiacar@omu.edu.tr

### Abstract

This study was carried out in order to determine adaptation and some quality traits of some cool season turf grass cultivars at randomized plot design with 4 replicates in Ondokuz Mayıs University Experimental Area during 2010-2012 years. Plot size was 2 m<sup>2</sup> (1×2 m). In the research 5 cultivars of *Festuca arundinacea* (FA), 6 cultivars of *Lolium perenne* (LP), 5 cultivars of *Festuca rubra commutata* (FRC), 6 cultivars of *Festuca rubra rubra* (FRR), 5 cultivars of *Festuca ovina* (FO), 7 cultivars of *Poa pratensis* (PP), 2 cultivars of *Poa trivialis* (PT), 1 cultivar of *Agrostis stolonifera* (AS), 2 cultivars of *Agrostis capillaris* (AC), 1 cultivar of *Agrostis tunius* (AT) and 1 cultivar of *Festuca rubra trichophylla* (FRT) were used. Time to emergence (day), time to covering (day), winter hardiness (1-9), covered ratio (1-9), regeneration trait (1-5), tiller number (1-5), general appearance (1-9), weed ratio (1-5), sparsely ratios (1-9) were investigated. In terms of time to emergence and time to cover the earliest values were obtained from LP cultivars (16.12 and 42.66 days, respectively), the latest values were observed to FRR and FO cultivars. When consider together with winter tolerance, covered ratio and regeneration traits, cultivars of FA were the best. The highest tiller number and the least sparsely ratios were determined to FA cultivars. Weed problem was not observed for all cultivars but PP and PT. There were no differences in terms of general appearance among the cultivars except for PP and PT cultivars. Consider the all investigated characteristics of cultivars, price and abundance of seed and cultivation process, *F. arundinacea*, *Lolium perenne* and some *Festuca rubra* cultivars are very suitable in order to use green areas in Black Sea Region of Turkey.

**Key words:** Turf grass, adaptation, quality, winter hardiness

### Introduction

In the contrary of urbanization and industrialization, recreation area is decreasing day by day. In order to supply human shelter requirement concrete apartment building increased, view of the cities changed and consequence of those issues. Life quality decreased while stress of humanity is rising. Human is trying to live in congested areas, started to create small green areas inside the cities. After that researches on grass species that can be used in green areas increased (Avcıoğlu, 1997).

Turfgrass have important functions on sports areas, in addition to around the houses. Turfgrass species and cultivars selected for sports areas should be resist to pressing on. This trait is crucial for a turfgrass, if it is used in sport areas (Yazgan *at al.*,1992). Before establish a sport or recreation area, turfgrass cultivars should be suitable to climatic conditions of the region. To know the adapted cultivars in the region is definitely necessary. Cool season grass are suitable to North, East and Central part of Turkey, however warm season grass are more common in South and South-West regions.

Turfgrass plants, in addition to climatic adaptation, should satisfy expectations in terms of harmony of each other, persistence, appearance and aesthetic. Indicator of satisfaction is evaluated as turfgrass quality. Quality of turfgrass is divided two parts. The first one is individual quality of plants like as; colour, growing speed, growing structure, root growing, resistance to cutting depth and frequency, pressing on, drought, heat, disease and insects. The second one is general characteristics like as; harmony each other, uniformity, appearance, smoothness, density and hay yield (Beard, 1973; Altan, 1989; Uzun, 1989; Acikgoz, 1994; Avcioglu, 1997). Aim of this study was to determine adaptation and some quality traits of some cool season turf grass cultivars.

### Material and Methods

In this study 41 cool season grass cultivars (5 FA, 6 LP, 5 FRC, 6 FRR, 5 FO, 7 PP, 2 PT, 1 AS, 2 AC, 1 AT, 1 FRT) were used. The experiment was established according to randomized block design with four replicates in Samsun Conditions in Turkey in November, 2010. Plot sizes were 2x1=2 m<sup>2</sup>. Seeding rate was altered 25-90 g/m<sup>2</sup> according to 1000-seed weight and plant characteristics. The seeds scattered with hand on plots and compressed. Time to emergence (day), time to covering (day), winter hardiness (1-9), covered ratio (1-9), regeneration characteristic (1-5) tiller number (1-5), general appearance (1-9), weed ratio (1-5), thinning ratio (1-9) were investigated. The average temperature of Samsun was 13.9<sup>0</sup>C in long-time period, while in 2011 and 2012 it was measured as 14.2<sup>0</sup>C and 15.2<sup>0</sup>C, respectively. For many years, the total annual rainfall of Samsun was 707.0 mm as the average while in 2011 and 2012, this value was determined to be 671 and 999 mm, respectively. Statistical analysis was performed with SPSS 17.0 program according to randomized plot design.

### Result and Discussion

#### Time to emergence

There are highly significant differences amongst the species regard time to emergence. Average time to emergence was 16.1 days for *Lolium perenne*, 19.5 days for *Festuca arundinacea*, 25-27 days for *Festuca rubra* and *Agrostis* sp., 31.6 days for *Poa trivialis*, 33.7 days for *Festuca ovina* and 34.8 days for *Poa pratensis* (Table 1 and Figure 1).

Table1. Some characteristics of the cultivars\*

Species	Traits				
	Time to emergence (day)	Time to cover (day)	Winter hardiness (1-9)	Covered ratio (1-9)	Regeneration characteristic (1-5)
FA	19.50 (b)	45.60 (b)	6.60 (ab)	8.60 (a)	2.10 (ab)
LP	16.12 (a)	42.66 (a)	5.25 (c)	7.25 (bc)	2.50 (ab)
PP	34.83 (c)	69.33 (c)	3.33 (d)	6.99 (c)	4.66 (c)
PT	31.62 (d)	59.50 (d)	3.75 (d)	5.00 (d)	5.00 (c)
AG	25.66 (e)	66.08 (e)	7.33 (a)	7.33 (bc)	2.66 (ab)
FRT	25.25 (e)	66.25 (e)	7.50 (a)	7.00 (c)	1.50 (a)
FRR	25.50 (e)	64.85 (f)	5.80 (bc)	6.80 (c)	2.70 (b)
FO	33.65 (f)	56.25 (g)	5.90 (bc)	8.30 (a)	2.80 (b)
FRC	26.90 (g)	63.90 (f)	6.10 (bc)	7.70 (b)	2.20 (ab)

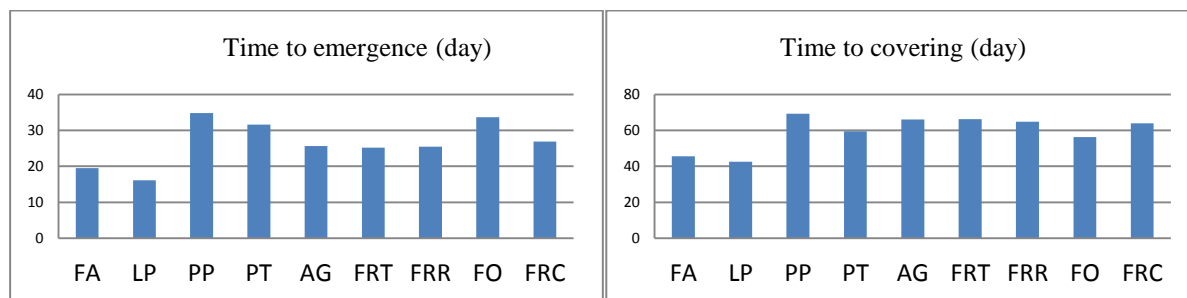
\*There is no difference amongst the number indicated same letter in the same column

#### Time to covering

There was a partly similarity between time to emergence and time to covering values of the species. In term of time to covering highly significant differences were found amongst the



species. The earliest time to covering values were obtained from *Lolium perenne* Topgun and Eveningshade cultivars (41 days) and this species followed by *Festuca arundinacea* (46.6 days), *Festuca ovina* (56.3 days), *Poa trivialis* (59.5 days), *Festuca rubra commutata* (63.9 days), *Festuca rubra rubra* (64.9 days), *Festuca rubra trichphyla* (66.3 days) and *Poa pratensis* (69.3 days), respectively (Table 1 and Figure 2).



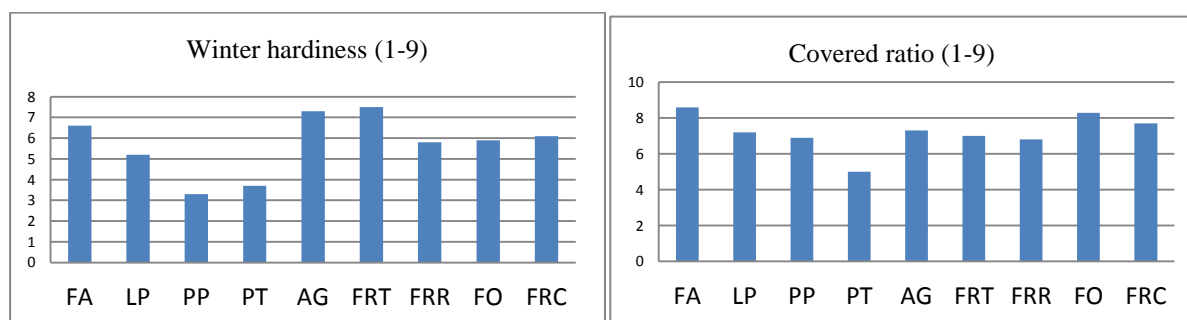
Figures 1 and 2. Time to emergence and time to covering days of the cultivars

### Winter hardiness

Winter hardiness values of cultivars were evaluated according to 1-9 scale (Table 1 and Figure 3). There were significant differences amongst the species and cultivars, regard the winter hardiness and the first rank was occupied by all *F. arundinacea*, *Agrostis* sp. and some *F. rubra* (Zamboni and Cassanova) and *F. ovina* (Bornito and Nordic) cultivars (6.5-7.5). The worst winter hardiness values were obtained from *P. pratensis* and *P. trivialis* cultivars (3.4). Winter hardiness values of species has similarity with the other researchers results, except for *P. pratensis* (Uzun,1992; Altan,1989; Arslan and Cakmakci, 2004; Cockerham *et al.*,1989). When we consider literature information, winter hardiness value of *P. pratensis* would be higher than it is. Probably, higher summer temperature and rust disease declined resistance of plants.

### Covered ratio

According to statistical analysis, there were highly significant differences amongst the cultivars. The highest covered ratio value was obtained from 4 *F. arundinacea*, 2 *F. ovina* and 1 *F. rubra commutata* cultivars as 9 point. The cultivars Starlite and Cypress of *P. trivialis* (5), Gondolin of *F. rubra rubra* (5) have the lowest covered ratio (Table 1 and Figure 4).

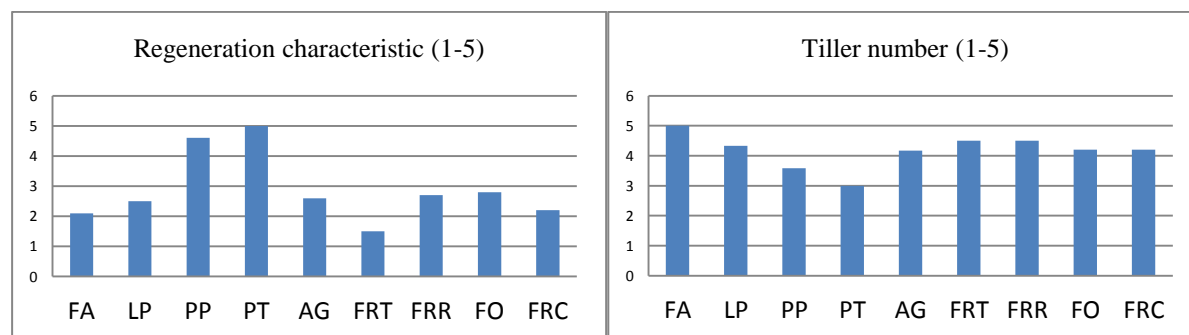


Figures 3 and 4. Winter hardiness and covered ratio values of cultivars

### Regeneration characteristic

In the consideration of regeneration characteristics that was made before second cutting in the spring, there were highly significant differences amongst the cultivars. The cultivars Jaguar

and Apachi of *F. arundinacea* and Zamboni of *F. rubra trichophyla* performed the highest regeneration with 1.5 point. The lowest regeneration values were obtained from *Poa* sp. cultivars (4.5-5.0) (Table 1 and Figure 5).



Figures 5 and 6. Regeneration characteristics and tiller numbers of cultivars

### Tiller number

Tiller numbers of the cultivars were observed just after the second cut and are given at Table 2 and Figure 6. 11 different cultivars tiller very densely and their mark was 5. Especially tiller numbers of all FA cultivars were higher and their appearance was very frequent. Tillering value of all perennial ryegrass and other fescue cultivars were altered between 3.5 and 5.0. The least tillering was observed on the cultivar Compact of *Poa pratensis*.

### General Appearance

General appearance of the plots was evaluated according to uniformity, colour, texture, liveliness, weeds ratio, damage of the insects and disease in four seasons as using 1-9 scale. Jaguar of *F. arundinacea* and Highlanbent of *Agrostis tenius* were rewarded 8 points over 9 and their general appearance was the best. The worst general appearance was observed on *Poa* cultivars (Table 2 and Figure 7). In this case general appearance of *Poa* cultivars were evaluated as bad, and the others as good or very good.

Table 2. Some other traits of the cultivars\*

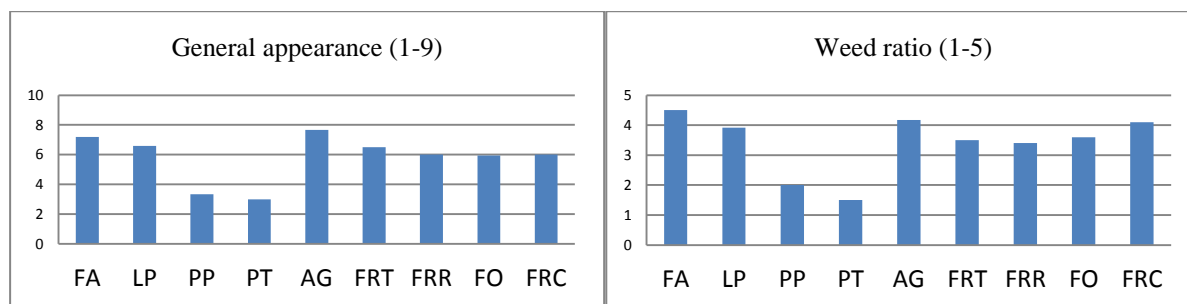
Species	Traits			
	Tiller number (1-5)	General Appearance (1-9)	Weed Ratio (1-5)	Thinnig Ratio (1-9)
FA	5.00 (a)	7.20 (a)	4.50 (a)	8.20 (a)
LP	4.33 (abd)	6.58 (a)	3.91 (a)	5.91 (b)
PP	3.58 (bc)	3.33 (b)	2.00 (bc)	4.91 (c)
PT	3.00 (c)	3.00 (b)	1.50 (c)	1.50 (d)
AG	4.16 (bd)	7.66 (a)	4.16 (a)	5.16 (bc)
FRT	4.50 (ad)	6.50 (a)	3.50 (ab)	3.50 (e)
FRR	4.50 (ad)	6.00 (a)	3.40 (ab)	3.50 (e)
FO	4.20 (bd)	5.95 (a)	3.60 (a)	5.50 (bc)
FRC	4.20 (bd)	6.00 (a)	4.10 (a)	4.70 (c)

\*There is no difference amongst the number indicated same letter in the same column

### Weed ratio

Weed ratio of the plots were determined after the last cut in the second year as using 1-5 scale. The differences amongst the cultivars were found as highly significant in terms of weed ratio. The highest weed ratio was determined into cultivars of *Poa* sp. (1.5-2.5). Weeds had no chance to grow into cultivar Jaguar of *F. arundinacea* that its regeneration characteristic and

tiller number were high (Table 2 and Figure 8). In fact weed ratio of all cultivars was acceptable, except for *Poa* cultivars and Redskin cultivar of *F.rubra rubra*.



Figures 7 and 8. General appearance and weed ratios of cultivars

### Thinning Ratio

Thinning ratio of the plots was observed at the end of the vegetation period in the second year and was appreciated as using 1-9 scale. The results are given at Table 2 and Figure 9. There were significant differences amongst the cultivars at the end of the second year, thinning ratio of cultivars were appreciated as follow: Cultivars of *F. arundinacea* were dense/highly dense, cultivars of perennial ryegrass were dense, cultivars of *Poa pratense*, *Agrostis* sp. and the other fescue were middle dense, but cultivars of *Poa trivialis* were very thin.

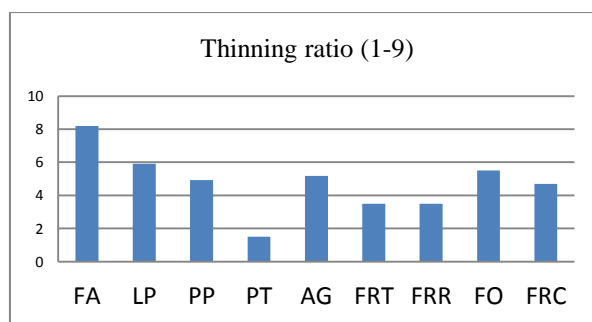


Figure 9. Thinning ratios of cultivars

### Conclusion

Consider the all investigated characteristics of cultivars, price and abundance of seed and cultivation process, *F. arundinacea*, *Lolium perenne* and some *Festuca rubra* cultivars are very suitable in order to use green areas in Black Sea Region of Turkey.

### References

- Açıkgöz E., 1994. Establishment and Nursing Techniques of Green Areas. Çevre Peyzaj Mimarlığı Yayınları, No:4, Bursa, 204 ss.
- Altan, S., 1989, Cover Crops. Çukurova Univ. Agric. Faculty Pub. No:108, Adana.
- Arslan M., Cakmakci S. 2004. Determination of adaptation ability and performances of different grass species and cultivars in coastal conditions of Antalya province. Akdeniz University, Journal of the Faculty of Agriculture. 17(1):31- 42.

- Avciođlu, R., 1997. Turfgrass techniques. Ege Univ. Pub. Bornova, İzmir, 271 p.
- Bread, J.B., 1973. Turfgrass Science And Culture. Englewood Cliffs, N. J. Pointice Hall, London.
- Cockerham, S. T., Gibeault, V. A., Dam, J. V. and Leonard, M. K., 1989. Tolerance of Cool Season Turfgrasses to Sports Traffic, Turfgrass-Culture, University of California, Riverside, CA 92521, USA.
- Uzun, G. 1992 Turfgrass in Sport Areas. Çukurova Univ. Agric. Faculty Pub. No. 20, Adana, p.170
- Yazgan, E., Ekiz, H., Karadeniz, N. ve Kendir, H. 1992. A study on the some morphological and phenological characters for determination of the grass species can be used in green areas in Ankara conditions.. Ankara Univ. Agric. Faculty Pub. 1277, Ankara, pp. 37.

## PERFORMANCE OF LOCAL OAT GENOTYPES AT DIFFERENT LOCATIONS

Zeki MUT<sup>1\*</sup>, Hasan AKAY<sup>2</sup>, Özge Doğanay ERBAŞ KÖSE<sup>1</sup>

<sup>1</sup>Bozok University, Faculty of Agriculture, Department of Field Crops Yozgat 66100, Turkey

<sup>2</sup>Ondokuz Mayıs University, Faculty of Agriculture, Department of Field Crops Samsun 55130, Turkey

\*Corresponding author: zeki.mut@bozok.edu.tr

### Abstract

The aim of this study was to define grain yield and the quality traits of local oat cultivars grown in different region of Turkey. Fourteen oat genotypes were evaluated in a randomized block design with four replicates over the three locations for two consecutive years. Effects of genotype, location, year, genotype × location and genotype x year interaction on grain yield and quality traits were statistically found important. The oat genotypes showed variations for grain yield (2.39–4.65 t ha<sup>-1</sup>), test weight (41.26–45.59 kg), groat percentage (70.02–74.44 %), protein (11.40–13.11 %), ash (2.41–2.90 %), starch (42.40–52.69 %), β-glucan (2.99–3.52 %), ADF (14.16–17.78 %), NDF (32.54–36.69 %), and fat (5.50–6.83). Linoleic, oleic, palmitic, stearic and linolenic acid contents of the genotypes varied between 35.20 to 38.98 %, 37.15 to 41.30 %, 17.54 to 19.26 %, 2.53 to 2.76 % and 1.23 to 1.46 %, respectively. According to the average of locations, the genotype G8 had the highest grain yield. Also, this genotype had high values for the desired quality traits.

**Keywords:** *Avena sativa*, grain yield, quality, protein, oat.

### Introduction

Oat grown for food, feed and forage in several regions of the world is an important grain cereal. Its production for food is gradually increased due to its unique nutrition content for healthy diets. Oat as human food is used mostly in hot and ready-to-eat cereals, and some in granolas, cookies, breads and other cereal products (Özcan et al., 2006). The use of oat grain relies on its agronomic characteristics, physical traits and chemical composition features (Peterson et al., 2005). Hectoliter weight, kernel weight, groat percentage, milling yield, protein, oil and β-glucan concentrations determining the quality of oat grain are the most important physical and composition traits (Doehlert et al., 2001; Peterson et al., 2005). All these characteristics are affected by the growing condition, genetic factors as well as by interactions between them (Peterson et al., 2005; Hırsır et al., 2012). Oat grains contain about 12.4 to 24.4% protein, 3 to 11% oil, 1.8 to 7.5% β-glucan. Oats are a rich source of soluble fiber, well-balanced proteins, several vitamins and minerals essential for the human health (Charalampopoulos et al., 2002; Demirbas, 2005). Oats also include comparatively high amounts of lipids compared with other cereal grains, with a substantial level of essential linoleic acid (Hareland and Manthey, 2003). A number of studies indicate that oat oil content is under genetic control, thus it is possible to alter oil content via breeding (Holland et al., 2001). Oat oil is generally good for human nutrition due to a high percentage of unsaturated fatty acids such as oleic acid and linoleic acid. The success of plant breeding in the last century has mainly depended on the utilization of natural or mutant modified genetic variation accompanied with efficient selection and suitable methods in target environments. Local cultivars, is a significant natural genetic source, provide a many opportunities to breeders for developing a new varieties with a high yield and quality. Due to the climatic and geographic location, Turkey is the origin of many wild and cultivated plants. So the genetic diversity is

very high. There are many different local and wild oat varieties in Turkey. Therefore, Turkey is considered to be one of the important origin centers of the oat (Dumlupinar et al., 2011). Plant breeders have been endeavoring to improve genotype with higher grain yield, quality and other suitable traits for different environmental conditions. In the present study, various physical and chemical properties of local oat genotypes were evaluated.

### **Material and Methods**

In this study, a total of 14 oat genotypes (12 local cultivars and 2 registered varieties) were included. This study was performed in two successive years (2011-2012 and 2012-2013) at three different locations, namely Amasya, Samsun-Bafra and Samsun (Table 1) in Turkey. Fourteen genotypes of oat were grown in a randomized complete block design with four replications at each site under rain fed conditions. Sowing was done with plot size of 7.2 m<sup>2</sup>, wherein 6 rows were sowed within the plot, with 20 cm row spacing, with 550 seeds m<sup>2</sup>. In this study grain yield, some physical (test weight, groat percentage) and some chemical properties (protein, starch, ash, fat,  $\beta$ -glucan, acid detergent fiber (ADF), and neutral detergent fiber (NDF), and fatty acid composition) were determined. A Grain yield (GY) per hectare was calculated from the harvested area of each plot. Physical and chemical analyses were carried out according to Buerstmayr et al. (2007) and Mut et al., (2016a). Some climatic data and soil characteristics of the experimental areas are given in Table 1. Analysis of variance (ANOVA) of the phenotypic data was performed using GLM procedure of the statistical analysis System (SAS Version 6, 1990). Where ANOVA indicated significant treatment affects, the means were separated by the least significant difference (LSD) at the 0.05 probability level.

### **Results and Discussion**

The effects of year, genotype, location, and genotype  $\times$  location interaction (except for  $\beta$ -glucan) were found to be statistically significant ( $P < 0.01$ ) for all traits, namely grain yield, test weight, thousand grain weight, groat percentage, protein content, ash, starch content,  $\beta$ -glucan content, acid detergent fiber (ADF), neutral detergent fiber (NDF) and fat content (Table 2 and 3). The significant  $G \times L$  interaction demonstrated that the answers of the genotypes altered depending on environments. Grain yield of genotypes averaged over all locations ranged from 2.39 t ha<sup>-1</sup> for genotype G1, to 4.65 t ha<sup>-1</sup> for genotype G8; the overall mean was 3.39 t ha<sup>-1</sup>. The highest grain yielding was Bafra location (4.23.8 t ha<sup>-1</sup>), followed by Samsun and Amasya (3.67 t ha<sup>-1</sup> and 2.28 t ha<sup>-1</sup>), respectively (Table 2). Grain yield in the first year (3.64 t ha<sup>-1</sup>) was also higher than that of the second year (3.14 t ha<sup>-1</sup>). The variation in grain yield of genotypes may be attributed to genetic characteristics and adaptability of these varieties to different environmental conditions. The influences of genotype and climate conditions are significant parameters affecting yield and quality of oat (Burstmayer et al., 2007). Factors determining yield and quality in field crops can be categorized into several groups: genotype efficiency, soil fertility, agricultural practices, and meteorological conditions (Abunyewa et al., 2017). According to the average of the tested locations, the groat percentage varied from 70.02 to 74.44 %, and G6, G8 and G9 numbered genotypes had the highest groat percentage (Table 2). The highest groat percent was Bafra location (73.58 %), followed by Samsun and Amasya locations (Table 2). Groat percentage in the first year (75.30 %) was also higher than that of the second year (69.81 %). Low hull content is particularly important for the achievement of high milling yield, which is an important criteria for hulled food oat (Cowan and Valentine, 2004). Mut et al. (2016b) stated that groat percentage varied from 70.4 to 76.6 % in different oat genotypes.

Table 1. Some climatic values, physical and chemical characteristics of experiment soils of the study area

	Samsun- Bafra		Samsun- Kurupelit		Amasya	
	2011-2012	2012-2013	2011-2012	2012-2013	2011-2012	2012-2013
Geographic coordinates	41°34' N 35°55' E	41°34' N 35°55' E	41°21' N 36°15' E	41°21' N 36°15' E	40°50' N 35°39' E	40°50' N 35°39' E
Elevation (m)	20	20	195	195	495	500
Soil Properties	pH=7.15 clayey loam	pH=6.95 clayey loam	pH=6.75 clayey	pH=7.10 clayey	pH=7.45 clayey loam	pH=7.65 clayey loam
Precipitation (mm)	945.6	671.2	804.2	620.0	415.0	571.6
Aver.air temp. (°C)	12.7	14.8	13.2	15.3	17.0	19.3
Sowing date	3 November 2011	6 November 2012	7 November 2011	8 November 2012	16 October 2011	14 October 2012
Harvest date	27 June 2012	26 June 2013	30 June 2012	2 July 2013	29 June 2012	6 July 2013
Fertilizer (kg ha <sup>-1</sup> )	80 N 80 P <sub>2</sub> O <sub>5</sub>	80 N 80 P <sub>2</sub> O <sub>5</sub>	80 N 80 P <sub>2</sub> O <sub>5</sub>	80 N 80 P <sub>2</sub> O <sub>5</sub>	70 N 80P <sub>2</sub> O <sub>5</sub>	70 N 80 P <sub>2</sub> O <sub>5</sub>

Table 2. Mean values, for grain yield and grain quality traits for 14 oat genotypes in three environments during two years

Gen./Loc.	GY (t ha <sup>-1</sup> )	GP (%)	TW (kg)	PC (%)	ST (%)	βG (%)	ADF (%)
<b>G1</b> Düzce-Merkez <sup>1</sup>	2.39 g	70.02 d	43.55 a-d	11.40 e	42.41 f	3.42 ab	17.33 ab
<b>G2</b> Bolu-Mengen <sup>1</sup>	3.61 cde	72.74 abc	44.70 ab	12.29 cd	45.87 cde	3.16 def	16.04 b-e
<b>G3</b> Zonguldak-Merkez <sup>1</sup>	3.48 de	71.85 bcd	42.44 bcd	12.65 a-d	44.84 e	3.32 b-e	16.44 a-d
<b>G4</b> Zonguldak-Ereğli <sup>1</sup>	3.76 bcd	71.76 bcd	42.17 cd	12.19 d	44.41 ef	3.16 def	17.78 a
<b>G5</b> Zonguldak-Beycuma <sup>1</sup>	2.42 g	73.03 abc	43.51 a-d	12.36 bcd	45.26 de	3.34 a-d	15.86 b-e
<b>G6</b> Karabük-Merkez <sup>1</sup>	3.89 bc	74.44 a	45.59 a	12.67 a-d	45.94 cde	3.13 ef	15.32 def
<b>G7</b> Karabük-Safranbolu <sup>1</sup>	2.94 f	73.33 abc	44.87 ab	12.51 bcd	45.29 de	3.17 def	15.74 cde
<b>G8</b> Rize-Merkez <sup>1</sup>	4.65 a	74.23 a	43.31 a-d	13.11 a	49.23 ab	3.52 a	14.55 ef
<b>G9</b> Muğla-Datça <sup>1</sup>	3.99 b	73.78 a	44.31 abc	12.30 cd	47.53 bcd	2.98 f	15.07 def
<b>G10</b> Bahıkesir <sup>1</sup>	3.03 f	73.02 abc	41.26 d	12.41 bcd	49.03 ab	3.41 abc	15.23 def
<b>G11</b> Karaman <sup>1</sup>	2.49 g	70.45 d	43.07 bcd	12.54 a-d	45.08 e	3.22 cde	17.11 abc
<b>G12</b> Kütahya <sup>1</sup>	3.85 bc	72.90 abc	43.23 a-d	12.80 abc	48.07 bc	3.29 b-e	15.32 def
<b>G13</b> Seydişehir <sup>2</sup>	3.54 de	73.57 ab	43.08 bcd	12.94 ab	50.69 a	3.26 b-e	14.16 f
<b>G14</b> Y330 <sup>2</sup>	3.42 e	71.62 cd	41.90 cd	12.14 d	48.39 ab	3.14 def	15.24 def
Overall Mean	3.39	72.62	43.36	12.45	46.57	3.25	15.80
Locations	Bafra 4.23 a	73.58 a	43.60 b	11.63 c	41.53 b	3.60 a	16.78 a
	Samsun 3.67 b	71.76 b	41.39 c	12.39 b	49.14 a	3.14 b	15.63 b
	Amasya 2.28 c	72.53 b	45.07 a	13.33 a	49.05 a	3.02 c	14.98 b
Years	First year 3.64 A	75.30 A	42.01 B	11.93 B	45.08 B	2.89 B	17.38 A
	Second year 3.14 B	69.81 B	44.70 A	12.97 A	48.06 A	3.60 A	14.22 B
Year (Y)	**	**	**	**	**	**	**
Location (L)	**	**	**	**	**	**	**
Genotype (G)	**	**	**	**	**	**	**
G × L	**	**	*	*	**	NS	*

<sup>1</sup> -cultivar, <sup>2</sup> -landraces, GY; grain yield, GP; groat percentage, TW; test weight, PC; protein content, ST; starch content, βG; β-glucan, ADF; acid detergent fibre, NDF; neutral detergent fibre, \*Significant at P<0.05, \*\*Significant at P<0.01, NS: Non Significant

Test weight of genotypes averaged over all locations ranged from 41.26 kg for genotype G10, to 45.59 kg for genotype G6; the overall mean was 72.62 (Table 2). The highest test weight was Amasya location (45.07 kg), followed by Bafra and Samsun (43.60 and 41.39 kg), respectively (Table 2). Test weight in the first year (42.01 kg<sup>1</sup>) was also higher than that of the second year (44.70 kg). The results obtained in this study were in agreement with those acquired in previous studies on the quality of oat grain, which also showed that the quality of oat grain depended on the genetic factors and environmental conditions throughout the growing season (Rhymer et al., 2005; Buerstmayr et al., 2007; Mut et al., 2016b).

Table 3. Mean values, grain quality traits for 14 oat genotypes in three environments during

two years

Gen./Loc.	NDF (%)	ASH (%)	FAT (%)	18:2 (%)	18:1 (%)	16:0 (%)	18:0 (%)	18:3 (%)	
<b>G1</b>	36.11 ab	2.73 a-d	6.28 cde	35.93 f	41.22 ab	17.54 f	2.57 d	1.34 cd	
<b>G2</b>	34.69 a-e	2.71 a-d	5.76 gh	36.92 bcd	38.64 de	18.69 cde	2.66 bc	1.44 ab	
<b>G3</b>	35.39 abc	2.71 a-d	5.92 fg	37.98 a	37.15 f	19.05 a-e	2.62 cd	1.46 a	
<b>G4</b>	36.54 a	2.90 a	5.97 efg	36.64 cde	38.56 de	19.13 a-d	2.61 cd	1.37 bc	
<b>G5</b>	34.99 a-d	2.59 b-f	5.98 efg	36.68 cde	39.15 cd	18.66 de	2.64 bc	1.37 bc	
<b>G6</b>	33.04 de	2.66 b-e	6.83 a	35.20 g	41.30 a	18.57 e	2.70 ab	1.41 abc	
<b>G7</b>	34.04 b-e	2.74 abc	5.99 efg	36.36 def	39.54 cd	18.89 a-e	2.70 ab	1.34 cd	
<b>G8</b>	33.13 de	2.45 ef	6.35 bcd	36.54 def	39.41 cd	18.70 b-e	2.69 ab	1.36 bc	
<b>G9</b>	32.54 e	2.55 c-f	6.80 a	36.04 ef	40.04 bc	18.92 a-e	2.75 a	1.35 cd	
<b>G10</b>	34.09 b-e	2.61 b-f	6.58 abc	36.57 def	38.83 cd	19.22 ab	2.74 a	1.27 de	
<b>G11</b>	36.69 a	2.79 ab	5.50 h	37.41 ab	37.56 ef	19.19 abc	2.66 bc	1.38 bc	
<b>G12</b>	33.69 cde	2.62 b-f	6.22 def	36.70 cde	39.08 cd	18.92 a-e	2.70 ab	1.39 abc	
<b>G13</b>	32.56 e	2.41 f	6.65 ab	37.29 bc	38.34 def	18.92 a-e	2.76 a	1.40 abc	
<b>G14</b>	33.87 cde	2.53 def	6.80 a	36.71 cde	38.90 cd	19.26 a	2.71 ab	1.23 e	
Overall Mean	34.39	2.64	6.26	36.64	39.12	18.83	2.68	1.37	
Locations	Bafra	36.01 a	2.96 a	6.31	36.58 ab	38.85 b	18.79 b	2.64 b	1.30 c
	Samsun	33.89 b	2.49 b	6.27	36.47 b	39.65 a	18.47 c	2.65 b	1.43 a
	Amasya	33.25 b	2.48 b	6.21	36.88 a	38.86 b	19.24 a	2.76 a	1.36 b
Years	First year	35.71 A	3.12 A	6.41 A	36.77 A	37.2 B	21.05 A	2.77 A	0.81 B
	Second year	33.06 B	2.17 B	6.11 B	36.51 B	41.1 A	16.61 B	2.59 B	1.91 A
Year (Y)	**	**	**	*	**	**	**	**	
Location (L)	**	**	**	**	**	**	**	**	
Genotype (G)	**	**	**	**	**	**	**	**	
G × L	*	**	**	*	**	**	**	**	

ASH; ash content, FAT; crude fat, 18:2; Linoleic, 18:1; Oleic, 16:0; Palmitic, 18:0; Stearic, 18:3; Linolenic, \*Significant at P<0.05,\*\*Significant at P<0.01.

Protein content of the grain is one of the basic parts which report the usage of grain. Grain crude protein content was significantly affected by genotypes, locations, years and genotype × location interaction (Table 2). According to the average of the tested locations, the protein content varied from 11.40 (G1) to 13.11 % (G8), and G3, G6, G8, G11, G12 and G13 numbered genotypes had the highest protein content (Table 2). The highest protein content was Amasya location (13.33 %), followed by Samsun and Bafra locations (12.39 and 11.63 %), respectively (Table 2). Protein content in the second year (12.97 %) was also higher than that of the first year (11.93 %). Australian genotypes of husked oats varied from 10.0 to 18.0 % of CP (Farrell et al., 1991). Yanming et al. (2006) and Mut et al. (2016b) showed that genetic variation was important for protein content. Starch content of genotypes averaged over all locations ranged from 44.84 % for genotype G3, to 50.69 % for genotype G13; the overall mean was 46.57 (Table 2). The highest starch content was Samsun location (49.14 %), followed by Amasya and Bafra (49.05 and 41.53 %, respectively) (Table 2). Starch content in the second year (48.06 %) was also higher than that of the first year (45.08 %). Environment was the dominant factor contributing to the total variation of starch content (Rhymer et al., 2005). Mut et al. (2016b) reported that starch ranged from 34.85 kg to 47.72 % in different oat genotypes.

β-glucan concentration was significantly affected by genotypes, locations, years and genotype × location interaction (Table 2). According to the average of the tested locations, the β-glucan concentration varied from 2.98 (G9) to 3.52 % (G8), and G1, G5, G8 and G10 numbered genotypes had the highest β-glucan concentration (Table 2). The highest β-glucan concentration was Bafra location (3.60 %), followed by Samsun and Amasya locations (3.14 and 3.02 %), respectively (Table 2). β-glucan concentration in the second year (3.60 %) was also higher than that of the first year (2.89 %). β-glucan aids to decrease blood glucose and cholesterol (Demirbaş, 2005). Mut et al. (2016b) indicated that starch ranged from 1.33 to 2.58 % in different oat genotypes. ADF and NDF content of genotypes averaged over all



locations ranged from 14.16 to 17.78 % and 32.56 to 36.69 %, respectively. ADF and NDF values in the first year were higher than that of the second year. Both ADF and NDF values of 1, 2, 3, 4, 5 and 11 numbered genotypes were higher than overall means. The highest ADF and NDF values were Bafra location (16.78 and 36.01 %), followed by Samsun and Amasya locations (15.63 and 33.89 %, 14.98 and 33.21), respectively (Table 2). ADF and NDF values in the first year (17.38 and 35.71 %) were also higher than that of the first year (14.22 and 33.06 %), respectively. NDF content of oat may be in excess of 30 % of dry matter similarly, ADF comprises 10 to 15% of oat grain (National Research Council, 2001). Ash content of genotypes averaged over all locations ranged from 2.43 % for genotype G13, to 2.90 % for genotype G4; the overall mean was 2.64 (Table 3). The highest ash content was Bafra location (2.96 %), followed by Samsun and Amasya (2.49 and 2.48 %, respectively) (Table 3). Ash content in the first year (3.12 %) was also higher than that of the second year (2.17 %). Owing to the valuable fatty acid composition of oat grain fat, the oat has a high nutritional potential. Oat genotypes usually include more fat than other small cereal grains. In this study, fat concentration in oat genotypes varied between 5.50 to 6.83 %, the overall mean was 6.26 %. Ash content in the first year (6.41 %) was also higher than that of the first year (6.11 %) (Table 3). Mut et al. (2016b) reported that fat concentration ranged from 5.86 to 8.47 % in twenty-five oat genotypes. In a study of more than 4000 oat genotypes, the fat content of the genotypes ranged from 3.1 to 11.6 % (Martinez et al., 2010). Linoleic acid content of the genotypes varied between 35.20 % (G6) and 38.98 % (G13), oleic acid content varied between 37.15 (G3) and 41.30 % (G6), palmitic acid content varied between 17.54 % (G1) and 19.26% (G14), stearic acid content varied between 2.53 % (G1) and 2.76% (G13) and linolenic acid content varied between 1.23 (G14) and 1.46% (G3). Linoleic, palmitic and stearic acids were found to be higher in the Amasya location while oleic and linolenic acids were higher in the Samsun location. Linoleic, palmitic and stearic acids in the first year (36.77, 21.05 and 2.77 %) were also higher than that of the second year (36.51, 16.69 and 2.59 %), respectively. acid profile of oat is quite remarkable for both human and animal nutrition. Oleic and linoleic acid contents designate oil quality and final use of the products (Özcan et al., 2006). High oleic and linoleic acid contents were also reported by Zhou et al. (1999).

### **Conclusions**

There were significant differences in grain yield, test weight, groat percentage, starch, protein,  $\beta$ -glucan, ADF, NDF ash and fat contents among different oat genotypes, years and locations. Also, fatty acids were significantly different from genotypes, locations and years. According to the combined results of location and years, G8 (4.65 kg ha<sup>-1</sup>) numbered genotype had the highest grain yield. In addition, this variety was found above the overall mean in terms of quality traits such as protein, groat percentage, starch, and  $\beta$ -glucan contents.

### **References**

- Abunyewa A. A., Ferguson R. B., Wortmann C. S., Mason S. C., 2017. Grain sorghum nitrogen use as affected by planting practice and nitrogen rate. *Journal of Soil Science and Plant Nutrition*, 17/1: 155-166.
- Buerstmayr H., Krenn N., Stephan U., Grausgruber H., Zechner E. (2007). Agronomic performance and quality of oat (*Avena sativa* L.) genotypes of worldwide origin produced under central European growing conditions. *Field Crops Research*, 101: 343–351.

- Charalampopoulos D., Wang R., Pandiella S. S., Webb C. (2002). Application of cereals and cereal components in functional foods: a review. *International Journal of Food Microbiology*, 79: 131–141.
- Demirbaş A. (2005).  $\beta$ -Glucan and mineral nutrient contents of cereals grown in Turkey. *Food Chemistry*, 90: 773–777.
- Doehlert D. C., McMullen M. S., Hammond J.J. (2001). Genotypic and environmental effects on grain yield and quality of oat grown in North Dakota. *Crop Sci.* 41: 1066-1072.
- Dumlupınar Z., Meral H., Kara R., Dokuyucu T., Akkaya A. (2011). Evaluation of Turkish oat landraces based on grain yield, yield components and some quality traits, *Turkish Journal of Field Crops*. 16/2: 190-196.
- Hareland G. A., Manthey F. A. (2003). Oats in: *Encyclopedia of food sciences and nutrition*. 7. (1st ed.). Oxford, UK, p. 4213–4220.
- Hısır Y., Kara R., Dokuyucu T. (2012). Evaluation of oat (*Avena sativa* L.) genotypes for grain yield and physiological traits. *Zemdirbyste-Agriculture*, 99/1: 55–60.
- Holland J. B., Frey K. J., Hammond E. G. (2001). Correlated responses of fatty acid composition, grain quality, and agronomic traits to nine cycles of recurrent selection for increased oil content in oat. *Euphytica*, 122/1: 69–79.
- Martinez M. F., Arelovish H. M., Wehrhahne L. N. (2010): Grain yield, nutrient content and lipid profile of oat genotypes grown in a semiarid environment. *Field Crops Research*, 116: 92–100.
- Mut Z., Erbas Kose O. D., Akay H. (2016a). Grain yield and some quality trait of naked oat cultivars. *Anadolu Journal of Agricultural Sciences*. 31, 96-104.
- Mut Z., Erbas Köse Ö. D., Akay H. (2016b). Grain Yield and some quality traits of different oat (*Avena sativa* L.) genotypes. *International Journal of Environmental & Agriculture Research*, 2/12: 83-88.
- NRC (National Research Council). 2001. *Nutrient Requirements of Beef Cattle*. National Research Council, 7th Rev. Edn. National Academy Press, NAS-NRC, Washington, DC, USA.
- Özcan M. M., Özkan G., Topal A. (2006). Characteristics of grains and oils of four different oats (*Avena sativa* L.) cultivars growing in Turkey. *International Journal of Food Sciences and Nutrition*, 57/5–6: 345–352.
- Peterson D. M., Wesenberg D. M., Burrup D. E., Erickson C. A. (2005). Relationships among agronomic traits and grain composition in oat genotypes grown in different environments. *Crop Science*, 45/4: 1249–1255.
- Rhymer C., Ames N., Malcolmson L., Brown D., Duguid S. (2005). Effects of genotype and environment on the starch properties and end-product quality of oats. *Cereal Chemistry*, 82/2: 197–203.
- SAS Institute Inc. 1990. *SAS-procedures guide*, version 6 (3rd ed.). Cary, USA.
- Yanming M., ZhiYong L., YuTing B., Wei, W. Hao W. (2006): Study on diversity of oats varieties in Xinjiang. *Xinjiang Agricultural Sciences*. 43/6: 510-513.
- Zhou, M., Robards, K., Glennie-Holmes, M., Helliwell, S., 1999. Oat lipids: a review. *Journal of the American Oil Chemists' Society*, 79: 585-592.

## THE EFFECT OF DIFFERENT SOWING DATES AND SOWING DENSITIES ON GRAIN YIELD AND SOME YIELD COMPONENTS OF DIYAR-95 CHICKPEA VARIETY UNDER DRY CONDITIONS IN DIYARBAKIR (TURKEY)

Zubeyir TURK

Dicle University, Agricultural Vocational High School, Diyarbakır, Turkey

\*Corresponding author: zubeyirturk@gmail.com

### Abstract

This study was carried out to determine the effect of different sowing date and sowing density on the yield and yield components of chickpea during 1995-96 and 1996-97 growing seasons in Diyarbakır rainfed conditions (Turkey). In the experiment, Diyar-95 chickpea variety was used, and it was sown at five sowing times (15 November, 15 December, 15 January, 15 February and 15 March) and five sowing densities (22.2, 27.7, 33.3, 38.8, 44.4 plant m<sup>-2</sup>). The result of this study indicated that the grain yield was significantly influenced by the different sowing dates and sowing densities. According to average two years grain yield changed from 1092 to 2193 kg ha<sup>-1</sup> with respect to sowing date. The highest grain yield was observed in 15<sup>th</sup> December sowing date (2193 kg ha<sup>-1</sup>), whereas the lowest grain yield was observed in 15<sup>th</sup> March sowing date (1092 kg ha<sup>-1</sup>). The grain yield varied with the different sowing density. According to average two years grain yield changed from 1464 to 1997 kg ha<sup>-1</sup> with respect to the different sowing density. The highest grain yield was obtained with the most density (44.4 plants m<sup>-2</sup>), whereas the lowest grain yield was obtained with the most widely space (22.2 plants m<sup>-2</sup>).

**Keywords:** *Cicer arietinum L.*, Sowing Date, Sowing Density, Yield, Yield Components.

### Introduction

The chickpea grain is of great importance in human nutrition due to its high percent and valuable protein content. In protein content of chickpea are found valuable aminoacids for human nutrition such as, leucine, lysine, isoleucine, phenylalanine, threonine. Protein content of chickpea genotypes can be ranged from 16.4% to 31.2% depending on genotypes, growing techniques and environmental conditions (Beech, 1977, Sehirali, 1988). Also chickpea has importance in terms of reducing fallow lands in plant rotation systems in dry conditions. Thanks to its short growing season and its resistance against drought, high temperatures, poor soil conditions and the other adverse conditions (Eser, 1978). Due to these superior properties, the chickpea is shown among the important crops that can be grown organically in the region as well (Cetinkaya et al 2013).

Chickpea (*Cicer arietinum L.*) is the second most important edible legume plant in the world. And, it is grown worldwide in at least 33 countries, including South Asia, West Asia-North Africa (WANA) region, East Africa, Southern Europe, South America and Australia. Percentage of chickpea cultivation area and production amount in edible legume plant of the world account for 14.8% (10.2 million Ha) 13.4% (7.9 million tonnes) respectively (Singh and Saxena, 1996). Annually, 429.132 tons chickpea crop is produced in Turkey in 347.337 hectares land size. Average chickpea grain yield in the country is 1260 kg ha<sup>-1</sup>. Southeastern Anatolia Region of Turkey, including Diyarbakır province, is shown among the places of Motherland of Kabuli type, coarse grained, chickpeas. However, average chickpea

yield in the region is higher than the average yield of the country, 1460 ha<sup>-1</sup>. Currently, chickpea cultivation area is 32.494 hectares, and its production is 44.609 tons in the region (Anonymous, 2016).

In the region generally chickpea is grown for human nutrition by using kabuli type, yet in some places of the region desi type chickpea, with black seed coat, is grown for using in animal nutrition (Sayar, 2014). Chickpea is cultivated without using any fertilization and irrigation in the Southeastern Anatolia region, Moreover, as a legume species, chickpea contributes to increased nitrogen content in the soil for subsequent crops in crop rotation systems.

The aim of this study was to determine effects of different 5 sowing dates (15 November, 15 December, 15 January, 15 February and 15 March) and 5 sowing densities (22.2, 27.7, 33.3, 38.8 and 44.4 plants in m<sup>2</sup>) on the yield and yield components of Diyar-95 chickpea variety in order to increase the productivity and prevent the waste of seed input in chickpea.

### **Material and Methods**

This study was carried out in the experimental areas of the Southeastern Anatolia Agricultural Research Institute in Diyarbakır (Turkey) for two years in 1995-96 and 1996-97. In the experiment, “Diyar-95” chickpea variety was used. In this study, the effect of five different sowing dates (15 November, 15 December, 15 January, 15 February and 15 March) and five different sowing density (22.2, 27.7, 33.3, 38.8 and 44.4 plants in m<sup>2</sup>) on yield and the yield properties of Diyar-95 chickpea variety were investigated.

#### **Soil and Climatic Conditions of Experimental Area:**

The research fields were flat, or nearly flat, with very little erosion, with a deep or relatively deep soil profile. According to the soil analysis, the experimental area soils had a clay loam texture, and were red-brown in color. The soils were rich in terms of calcium and potassium contents, whereas organic matter and phosphorus contents of soil were poor.

Continental climate prevails in the experimental area, where summers are dry and hot and winters are moderately cool and rainy. The total rainfall amount for long years average was 496.8 mm. On the other hand, it was recorded as 557.8 mm and 343.3 mm for 1995-96 and 1996-97 growing seasons respectively. Mean relative humidity values varied between 82-38% in the first year and 86-26% in the second year, respectively, and the relative humidity ratios of the two years were higher than those of the long years average (77-24%). The average temperature in the first year of the experiment was recorded as 15.5 °C and the average temperature in the second year was 15.9 °C. The average temperature for long years was 15.9 °C. As can be understood from this, the average temperature for the test years has been similar to the average temperature for many years.

#### **Experimental Design**

The trial was set up according to Split Plots Trial Design with four replications. In the experiments, sowing times were located in the main parcels and sowing frequency were located in the sub-parcels. Each plot consisted of 5 rows 5 m in length with 30 cm spacing between rows. So each plot size was 7.5 m<sup>2</sup> (5 row x 5 m x 0.30 m = 7.5 m<sup>2</sup>). In taking experimental data, a half-meter at the beginning and end of each plot, side rows were neglected to avoid edge effects. And the evaluations were made over the area of 4 m x 0.9 m = 3.6 m<sup>2</sup>. 25 kg of N and 60 kg of P<sub>2</sub>O<sub>5</sub> as Diammonium Phosphate fertilizer together with the planting were given. As the parcels got thicker, they were harvested by hand.

#### **Investigated Traits**

The plant yield (g), plant height (cm), height of first pod (cm), were investigated. The investigated traits were determined according to Tosun and Eser, (1975).

### Statistical Analysis

The values obtained from the study were subjected to variance analysis in the MSTAT-C statistical package program according to the "Split Plots Trial Design", the differences between means were compared using the least significant difference (LSD) test at the 0.05 probability level.

### Results and Discussion

Average values of grain yield ( $\text{kg ha}^{-1}$ ), plant height (cm) and first pod height (cm) obtained from different sowing time and sowing densities, LSD values (%) and CV values (%) are given in Table 1 and Table 2.

#### Grain yield ( $\text{kg ha}^{-1}$ )

When effect of sowing time and sowing density was examined on the grain yield trait in Table 1, highly significant ( $P < 0.01$ ) differences were found among sowing dates and sowing densities of each year separately, and among the two years averages. As expected, grain yield determined from sowing dates generally were found higher, when sowing date was made earlier. However, the highest grain yield was obtained in the first year from three earlier sowing dates, 15 November, 15 December, 15 January, and it was obtained in second year and the two year average from the first two sowing dates, 15 November, 15 December. In accordance with our findings, Dennis (1980), Haddad (1983) and Bennet and Mcneil (1985) reported that early sowing dates extends the vegetative period of chickpea, and this leads to obtaining higher grain yield from chickpea genotypes. On the contrary, Chowdhury et al (1982), Kaiser and Hannan (1985), Arvadia and Patel (1990) reported that they found insignificant differences for grain yield among sowing dates in chickpea. The views are in conflict with our results. This probably stemmed from differences among the environmental conditions and the used genotypes.

For all of the planting times, the grain yield of the first year was found higher than those of second year (Table 1). This probably caused by from differences of precipitation amount among the growing years. Precipitation amount in the first year was higher than from second year rainfall amount. And this caused obtaining higher grain yield in first year. On the other hand, anthracnose disease occurred during the first year due to excessive rainfall and this prevented the grain yield from increasing at the first sowing date. With late sowing dates adverse effect of anthracnose disease on chickpea decreased in first year. In the second year, although the seed yield dropped from the first sowing date, the grain yield in the first year began to fall after the second sowing date.

The most grain yields were obtained from the highest density ( $44.4 \text{ plants m}^{-2}$ ) sowing treatment in the two years and the two year average. And, as plant density declined, linearly grain yield of chickpea was decreased. In other words, in the both years, grain yield increased regularly as the planting density increased (Table 1). Similarly, many researchers cited that grain yield of chickpea were increased, with increasing plant density (Bascur, 1980; Singh, 1981; Photiodes, 1984; Abdul-Aziz, 1990; Aydın, 1988; Sarawgi et al., 1990; Yadav et al., 1990).

#### Plant Height (cm)

When effect of sowing time and sowing density in chickpea for plant height trait was examined on Table 1, highly significant ( $P < 0.01$ ) differences were determined among sowing dates and sowing densities of each year separately, and among the two years averages in terms of plant height. The highest plant height was recorded from the earliest sowing date, 15 November, in first year, second year and the two years average respectively as; 62.35 cm; 49.90 cm and 56.13 cm. Similarly, the lowest plant height was determined in the latest sowing date, 15 March, for first, second year and the two years average respectively as; 43.05 cm; 37.00 cm and 40.03 cm. Similar findings reported by Poma et al. (1983) and Photiodes

(1984). They reported that plant height of chickpea genotypes were longer in early and winter sowings due to longer vegetation period in the sowings.

Table 1. Effect different sowing dates and sowing densities on grain yield (kg ha<sup>-1</sup>), plant height (cm) and first pod height (cm) of chickpea

Application	Grain Yield (kg ha <sup>-1</sup> )						Plant Height (cm)					
	I. Year		II. Year		Two-Year Average		I. Year		II. Year		Two-Year Average	
Sowing Date (A)	**		**		**		**		**		**	
15 November	2262	a	1995	a	2128	a	62.35	a	49.90	a	56.13	a
15 December	2431	a	1954	a	2193	a	57.00	b	47.60	b	52.30	b
15 January	2388	a	1350	b	1869	b	53.90	bc	43.70	c	48.80	c
15 February	1718	b	1176	c	1447	c	51.00	c	42.35	d	46.68	c
15 March	1219	c	965	d	1092	d	43.05	d	37.00	e	40.03	d
LSD (%5)	18.25		12.29		10.42		4.752		1.286		2.331	
Sowing Density (B)	**		**		**		**		**		**	
22.2 plant/m <sup>2</sup>	1674	e	1254	e	1464	e	51.30	e	42.10	e	46.70	e
27.7 plant/m <sup>2</sup>	1831	d	1408	d	1620	d	52.35	d	42.90	d	47.63	d
33.3 plant/m <sup>2</sup>	2013	c	1505	c	1759	b	53.15	c	43.85	c	48.50	c
38.8 plant/m <sup>2</sup>	2184	b	1595	b	1890	c	54.65	b	45.15	b	49.90	b
44.4 plant/m <sup>2</sup>	2315	a	1679	a	1997	a	55.85	a	46.55	a	51.20	a
LSD (%5)	5.215		2.258		2.812		0.716		0.603		0.463	
CV (%)	4.12		2.40		3.64		2.12		2.16		2.15	
AxB Int.	**		**		**		ns		ns		ns	

Statistically significant according to \*: p≤0.05, \*\*: p≤0,01, ns: not significant

In the study positive relation was observed between plant height and plant sowing density. In the first year, second year and the two years average the highest plant height were recorded in the densely sowing treatment, (44.4 plants m<sup>-2</sup>). The highest plant heights were determined as 55.85 cm, 46.55 for first year and second year respectively. The lowest plant heights were recorded in the sparsest sowings, (22.2 plants m<sup>-2</sup>) both in the first (51.30 cm) and in second (42.10 cm) year. Our findings confirmed by findings of Hussain (1980), Kamel et al. (1980) and Aydın (1988). They reported that in densely sown plants, plant have higher plant heights, this is due to the competition among the plants to reach the sunlight. On the other hand, Tosun and Eser (1975) and Hadjichristodoulou (1984) expressed opposing views on this matter. They reported that effect of sowing density hadn't on the plant height. Contrary; plant height mostly affected by the climatic and soil conditions and plant genetic trait.

#### First Pod Height (cm)

An analysis of variance revealed that sowing date effect on first pod heights of the chickpea variety were highly statistically significant (P<0.01) for both of the years and the two years mean. On the other hand, effect of sowing densities on first pod heights of chickpea variety varied from sowing date effect. Even though sowing density effect on first pod heights of chickpea was found insignificant (P>0.05) in the first year, the effect were found were highly statistically significant (P<0.01) in the second year and the two year averages (Table 2). The first pod height of the chickpea variety ranged from 23.70 cm to 32.70 cm among the sowing dates in the growing years. The highest first pod heights were recorded in the early sowing dates, 15 November, 15 December, in both of the years, whereas the lowest first pod heights were determined in the late sowing, 15 March, for the two years.

Plant first pod heights of the chickpea variety ranged from 23.35 cm to 30.95 cm among the sowing densities in the growing years. Additionally, the highest first pod heights recorded in the most densely sowing, 44.4 plants m<sup>-2</sup> for the two years. The lowest first pod heights were determined at the sparsest sowings, (22.2 plants m<sup>-2</sup> for the two growing years. In accordance our findings, researchers reported that densely sowings negatively affected the plants to reach sunlight, which affect the photosynthesis capacity of plants. As the number of plants in the unit area in this direction increases, it can be said that the first pod height increases due to the light insufficiency in photosynthesis even if the plant has sufficient water and nutrients in the medium (Hussain, 1980; Kamel et al., 1980). On the other hand, the findings of Tosun and Eser (1975) and Hadjichristodoulou (1984) indicated that the planting density does not have a significant effect on the first pod height indicates that the first pod height is influenced by climatic and soil conditions as well as the genetic characteristics of the pod.

Table 2. Effect different sowing dates and sowing densities on first pod height (cm) of chickpea

Application	First Pod Height (cm)					
	I. Year		II. Year		Two-Year Average	
<b>Sowing Date (A)</b>	*		**		**	
15 November	32.75	a	26.30	a	29.53	a
15 December	30.56	ab	25.70	a	28.13	ab
15 January	27.86	bc	24.45	b	26.15	bc
15 February	26.96	bc	24.00	b	25.48	c
15 March	25.51	c	23.70	b	24.60	c
LSD (%5)	4.283		1.128		2.098	
<b>Sowing Density (B)</b>	**		**		**	
22.2 plant/m <sup>2</sup>	26.40	e	23.35	e	24.88	e
27.7 plant/m <sup>2</sup>	27.65	d	24.25	d	25.95	d
33.3 plant/m <sup>2</sup>	28.60	c	24.80	c	26.70	c
38.8 plant/m <sup>2</sup>	30.00	b	25.60	b	27.80	b
44.4 plant/m <sup>2</sup>	30.95	a	26.15	a	28.55	a
LSD (%5)	0.763		0.352		0.416	
CV (%)	4.20		2.24		3.51	
<b>AxB Int.</b>	ns		**		**	

Statistically significant according to \*: p≤0.05, \*\*: p≤ 0,01, ns: not significant

### Conclusions

Results of the study showed that different sowing dates and sowing densities were highly effective on grain yield, plant height and first pod height traits of Diyar-95 chickpea variety. Accordingly, it was observed that when plant sowing date delayed and used seed amount per unit area in sowings is decreased, grain yield, plant height and first pod height fell in the chickpea variety. Therefore, when decided to grow chickpea in ecological conditions of Southeastern Anatolia Region, winter (autumn) sowing date and 44.4 plant m<sup>2</sup> plant density can be recommended.

### References

Abdul Aziz; Aslam Khan; Muhammad Salim.(1990). Chickpea seed yield influenced by seeding densities.Field Crop Abstr. 43 (5): 432.

- Ageeb, O.A.A. and Ayoub, A.T. (1976). Effect of sowing date and soil type on plant survival and grain yield of chickpeas (*Cicerarietinum L.*) J. Agric. Sci., Camb. 88: 521-527.
- Anonymous (2016). Crop Production Statistics, TUIK. ANKARA.
- Arvadia, M.K.; Patel, Z. G. (1990). Influence of date of sowing on the growth and yield of gram (*Cicerarietinum L.*) under different fertility levels. Field Crop Abstr. 43 (4):339.
- Aydın, N. (1988). Effects of sowing time and plant pleasure on yield, yield components and antracnose in Chickpea (*Cicerarietinum L.*) in Ankara Conditions. Ankara university. Institute of Natural and Applied Science, Doctorate Thesis.
- Bascur, B. G. (1980). Disinfection of seed and seed spacing in Chickpeas. Field Crop Abstr. 33 (1): 155.
- Bennett, D. ve Mcneil, D.L. (1985). Effect of time of planting on irrigated chickpea yield in Northern Australia. International Chickpea Newsletter. 12:19-21.
- Chowdhury, S.K., Shahi, V.K. ve Sharma, R.P.R. (1982). Performance of gram genotypes under late planting in Bihar. Plant Breeding Abstr. 52 (5): 400.
- Çetinkaya H., Kendal E. ve Sayar, M.S. (2013). In terms of ecological agriculture, the important of Southeastern Anatolia, Journal of Turkish Scientific Collections, 6(1): 195-198 - <http://www.nobel.gen.tr/Makaleler/Derleme-Issue%201-148494edcd1d46febdacb654a40b384d.pdf>
- Dennis, P. (1980). Chickpea response to sowing time. International Chickpea Newsletter. 3:8-9.
- Deore, B.P.; Bharud, R.W.; Kharde, V.N., (1989). Physiological basis for yield differences in chickpea under different seeding periods. Annals-of- plant Physiology. 3 (2):181-187.
- Eser, D. (1978). Grain Legumes. Ankara Univ. Faculty of Agriculture Lecture notes. 98.p. ANKARA.
- Haddad, N. (1983). Effect of date of planting and plant population on the yield of chickpeas (*Cicerarietinum L.*) in Jordan DIRASAT. 5 (1): 117-128.
- Hadjichristodoulou, A. (1984). New chickpea varieties for winter sowing and mechanical harvesting. Agricultural Research Institute Ministry of Agriculture and Natural Resources. Technical Bulletin. 58:1-6.
- Hussain, S.A. (1980). Relationship between sowing density and yield in chickpea (*Cicerarietinum L.*). (Doctoral Thesis), Ankara Univ. Faculty of Agriculture. ANKARA.
- Kaiser, W.J. and Hannan, R.M. (1985). Effect of planting date and fungicide seed treatments on the emergence and yield of kabuli and desi chickpeas in Eastern Washington State. International Chickpea Newsletter. 12:16-19.
- Kamel, M. S. Mahmoud, E.A. and Hassan, M. Z. (1980). Effect of plant density on growth attributes of two Egyptian chickpea varieties. Field Crop Abstr. 33 (2): 155.
- Kumar, R., Yadav, H. L. and Yadan, D. S. (1984). Comparative performance of promising gram (*Cicerarietinum L.*) varieties under different dates of sowing. Field Crop Abstr. 37 (12): 1001.
- Photiodes, I. (1984). The effects of sowing date and plant population on the performance of chickpeas. Miscellaneous Reports 14. Agricultural Research Institute Nicosia. 1-5.
- Poma, I., Sarno, R., Noto, F., Zora, D. (1991). Effects of sowing density and arrangement on quality and yield characteristics of chickpeas. Field Crop Abstr. 44 (9): 861.
- Sarawgi, S.K.; Singh, N.P. (1990). Response of chickpea varieties to plant population and diammonium phosphate under late sown condition. Field Crop Abstr. 43 (8): 767.
- Saxena, M.C. (1981). ICARDA Research Highlights. Page: 27-29.
- Sayar, M.S. (2014). Determination of the yielding performance of some single annual leguminous forage species under the ecological conditions of Çınar District Ecology and the possibilities of entering into the rotation. Dicle University, Institute of Natural and Applied Science Journal, 3(1): 19-28.



- Sehirali, S. (1988). Edible Grain Legumes, Ankara Univ. Faculty of Agriculture Publications Id: 1089. ANKARA.
- Shaktawat, M.S.; Sharma, R.K. (1986). Response of chickpea varieties to seed rate and phosphorus levels. *Field Crop Abstr.* 39 (11): 1003.
- Sharma, M.L.; Chauhan, Y.S.; Bharadwaj, G.S.; Sharma, R.K. (1990). Relative performance of chickpea varieties to sowing dates. *Field Crop Abstr.* 43 (3): 256.
- Singh, K.B., Saxena, M.C. (1996). Winter Chickpea in Mediterranean-Type Environments. A Technical Bulletin. International Center for Agricultural Research in the Dry Areas. Aleppo, Syria.
- Yadav, D.S.; Singh, V.K.; Verma, K.K. (1990). Effect of sowing dates and plant densities on the performance of kabuli chickpea genotypes. *Field Crop Abstr.* 43 (5):432.

## ESTIMATE OF QUANTITATIVE HERITABILITY IN SOME CHICKPEA GENOTYPES (*Cicer arietinum*L.)

Zubeyir TURK

Dicle University, Agricultural Vocational High School, Diyarbakır, Turkey

\*Corresponding author: zubeyirturk@gmail.com

### Abstract

This investigation was carried out to study of some agronomic characters (plant height, first pod height, 1000-seed weight and grain yield) and estimate genetic variability parameters for the studied traits of chickpea. The study was carried out as randomized block design with four replications in the research area of GAP International Agricultural Research and Training Center in Diyarbakır, during 2000, 2001 and 2002 growing seasons. In the study, eighteen chickpea advanced lines provided from ICARDA and two control cultivar (Diyar-95 and ILC-482) were used. According to the average of three years, plant height ranged from 45.3 to 56.6 cm, this character was exhibited high heritability (0.90). The mean first pod height of chickpea genotypes ranged from 24.2 to 34.5 cm, this character showed high heritability (0.85). The mean 1000 seed weight of chickpea genotypes ranged from 264.1 to 354.9 g, the 1000 seed weight showed high heritability (0.89). The grain yield varied from 1316.0 to 1851.0 kg ha<sup>-1</sup>, it showed moderate heritability (0.52). The study showed that some parameters (plant height and thousand grain weight) can be used as selection criteria in Chickpea, because of high heritability values.

**Keywords:** *Cicer arietinum*, Genetic Variability, Yield, Traits.

### Introduction

Chickpea (*Cicer arietinum* L.) is an annual, self-pollinated, diploid (2n=16) grain legume crop grown in a wide range of environments including the Mediterranean, South and West Asia, North America, and North and East Africa (Singh and Saxena, 1999). Vavilov (1926) recognised the Mediterranean, Central Asian, Near Eastern, Indian and Ethiopia as the probable centres of origin (diversity) of the chickpea. Turkey and India are two major centers of diversity.

Chickpea is valued for its nutritive seeds with high protein content, 25.3-28.9 %, after dehulling (Hulse, 1991). The basic information on heritability of various plant-parameters, along with genetic advance, are needed to decide about the breeding-strategy for development of appropriate genotypes. Chickpea has high variation for various qualitative and quantitative characters that can help breeders to release better and superior lines and varieties (Dasgupta *et al.*, 1987; Singh, 1997). For maintenance and efficient utilization of germplasm, it is important to investigate the extent of genetic variability and its magnitude for the determination of the success of a breeding programme (Smith *et al.*, 1991). The presence of genetic variability is of utmost importance for any breeding program and for that reason the plant breeders have emphasized the evaluation and characterization of germplasm for the improvement of crop yield (Virmani *et al.*, 1983; Bakhsh *et al.*, 1992) as well as for selection of core collection for utilization in breeding programs. Thus the evaluation of germplasm is not only useful in selection of core collection but also for its utilization in breeding programmes. An initial step in a breeding program is the assembly of germplasm with a wide

range of genetic variability. The utility of a germplasm collection would be enhanced if the unique features of each genotype were to be described and recorded, so that the researcher could choose those genotypes in the collection, which have the genetic characteristics, desired for his specific objectives (Shah, 1999). Ali *et al.* (2008) found high broad sense heritability coupled with high genetic advance for plant height and grain yield. The average yield of this crop is generally low, because of drought, susceptibility to disease and low yield potential of varieties. For improvement of this crop, knowledge on variability and heritability of various plant-parameters, along with genetic advance, is needed to decide about the breeding strategy for development of appropriate genotypes.

The aim of this study was to identify variability and heritability estimates of economically important grain yield and some important yield components in chickpea.

### Materials and Methods

The experiment was carried out in rainfall conditions at the GAP International Agricultural Research and Training Center's trial field in Diyarbakir, Turkey, during 2000, 2001 and 2002 growing seasons. Soil of experimental area was clay loam and 2.03% organic matter and with pH 7.9. Eighteen genotypes of chickpea which provided from ICARDA and two control cultivar (Diyar-95 and ILC-482) were used in this study.

The design of experiment was a randomized complete block design with four replications. Each of the 20 genotypes were sown in four rows plots, 4 m long. Row spacing was 0.45 m. The trials utilized 4 m x 4 rows x 0.45 m = 7.2 m<sup>2</sup> plots. Plants in the middle 2.7 m<sup>2</sup> of the plots were harvested at full maturity depending on the experiment. The sowing was carried out on March 01, February 02 and January 24 in 2000, 2001 and 2002 respectively. Fertilizer was applied basally at rate of 25 kg N and 60 kg P<sub>2</sub>O<sub>5</sub> ha<sup>-1</sup> at sowing time (Minhas *et al.*, 1987). Genotypes were evaluated for quantitative traits including plant height (cm), first pod height (cm), 1000 seed weight (g) and grain yield (kg ha<sup>-1</sup>).

The data were analyzed, through computer software MSTAT-C, for the analysis of variance (Steel and Torrie, 1960). Differences among means were separated according to LSD's Multiple Range Test. For all of the statistical analyses we used the procedures of Duzgunes *et al.* (1987) at 5 and 1% probability levels. The genotypic and phenotypic coefficient of variation and heritability were calculated as suggested by Comstock *et al.*, (1963).

### Results and Discussion

A combined analysis of variance on 20 chickpea genotypes over three years is given Table 1. The means of the studied plant height (cm), first pod height (cm), 1000 seed weight (gr) and grain yield (kg ha<sup>-1</sup>) characters of the chickpea genotypes and LSD groups showing the differences among means (means of three years) are shown in Table 2. Estimated of variances components and heritability of some characters on 20 chickpea genotypes over three years are given in Table 3.

#### Plant Height (cm)

Differences among genotypes and years with respect to plant height were significant. The genotype x year interaction was no significant; this result revealed that environmental effect with respect to this character was no significant (Table 1).

The means of genotypes for plant height trait ranged from 45.20 to 56.60 cm. Whereas the tallest plant height was recorded from F97-28C with 56.60, the shortest plant height was recorded from ILC-482, F97-221C, F97-123C as 45.3, 45.3 and 45.2 respectively (Table 2). Previously; ranging of plant height trait for chickpea genotypes were reported by researchers

from 29.5 cm to 67.67 cm (Turk, 1999; Akhtar *et al.* 2011, Khan *et al.* 2011). The difference in plant height may be attributed to genetic and climatic factors.

Plant height was exhibited high heritability with 0.90 (Table 3). It was found that the effect of phenotypic was higher than that of genotypic for this character. Khan *et al.* (2011), Saleem *et al.* (2008), Durga *et al.* (2007), Hakim *et al.* (2006), Ghafoor *et al.* (2004) found similar results and observed high heritability in chickpea for plant height. High estimates of heritability of the traits under study could be due to the greater genetic variability of the germplasm.

#### First Pod Height (cm)

Differences among genotypes and years with respect to first pod height were significant. The genotype x year interaction was significant; this result revealed that environmental effect with respect to this character was significant (Table 1).

The means of genotypes for first pod height trait ranged from 24.2 to 34.5 cm. Whereas the tallest first pod height was recorded from F97-28C, the shortest first pod height was recorded from F97-221C (Table 2). Similar findings were reported by Turk, (1999) and Turk *et al.* (1999). Furthermore, Yucel *et al.* (2006) reported a high first pod height as 54.2 cm. The difference in first pod height may be attributed to genetic and climatic factors.

First pod height was exhibited high heritability with 0.85 (Table 3). It was found that the effect of phenotypic was higher than that of genotypic for this character. High estimates of heritability of the traits under study could be due to the greater genetic variability of the germplasm.

#### 1000 Seed Weight (g)

Differences among genotypes and years with respect to 1000 seed weight were significant. The genotype x year interaction was no significant; this result revealed that environmental effect with respect to this character was no significant (Table 1).

The means of genotypes for 1000 seed weight trait ranged from 264.10 to 354.90 g. Whereas the highest 1000 seed weight was recorded from Diyar-95 cultivar, the lowest 1000 seed weight was recorded from ILC-482 (Table 2). Previously; ranging of 1000 seed weight trait for chickpea genotypes were reported by researchers from 130 to 390g (Khan *et al.* 2011, Yucel *et al.* 2006, Akhtar *et al.* 2011).

This character showed high heritability with 0.89 (Table 3); this finding indicated that both effect of phenotypic and genotypic was significant on this character. The differences between genotypic and phenotypic coefficient of variability was very small indicating negligible role of environment. The results are in accordance with the findings of Iqbal *et al.* (1994). Khan *et al.* (2011), Saleem *et al.* (2008), Durga *et al.* (2007), Hakim *et al.* (2006), Ghafoor *et al.* (2004) found similar results and observed high heritability in chickpea for 1000 seed weight. High estimates of heritability of the traits under study could be due to the greater genetic variability of the germplasm.

#### Grain Yield (kg ha<sup>-1</sup>)

Differences among genotypes and years with respect to grain yield were significant. Genotype x year interaction was significant; this result indicated that grain yield affected not only by environment but yield performance of genotypes is important (Table 1).

The means of genotypes for grain yield trait ranged from 1316.00 to 1851.00 kg ha<sup>-1</sup>. Whereas the highest grain yield was recorded from Diyar-95 cultivar, the lowest grain yield was recorded from ILC-482 (Table 2). Previously; ranging of grain yield trait for chickpea genotypes were reported by researchers from 495 to 2396 kg ha<sup>-1</sup> (Akhtar *et al.* 2011, Turk, 1999, Turk *et al.* 1999).

This character showed moderate heritability with 0.52 (Table 3). Khan *et al.* (2011), Saleem *et al.* (2008), Durga *et al.* (2007), Hakim *et al.* (2006), Ghafoor *et al.* (2004) found similar results and observed high heritability in chickpea yield plant<sup>-1</sup>.

Table 1. Analysis of variance of the studied characters

Variation Sources	D.F.	Plant Height		First Pod Height		1000 Seed Weight		Grain Yield	
Year	2	5911.913	**	558.050	**	134920.800	**	596071.810	**
Error	9	12.681		3.801		490.490		114.076	
Genotype	19	135.043	**	67.143	**	4044.771	**	1822.497	**
Genotype x Year	38	12.855	†	10.300	**	417.278	†	883.641	**
Error	171	10.072		5.620		340.100		410.973	

\*\* : Significant at the 0,01 probability level. † : NS, nonsignificant at the 0.05 probability level.

Table 2. The means of the studied character of the chickpea genotypes and LSD groups\*

Genotypes	Plant Height (cm)	First Pod Height (cm)	1000 Seed Weight (g)	Grain Yield (kg ha <sup>-1</sup> )
1 F97-217C	46.8 d-f	27.4 ef	321.0 d-g	1389 c-f
2 F97-197C	46.2 ef	27.8 ef	341.4 a-c	1490 b-f
3 F97-116C	47.6 c-f	27.5 ef	332.1 b-f	1552 b-d
4 F97-97C	46.3 d-f	27.4 ef	327.9 b-g	1329 Ef
5 F97-123C	45.2 f	28.3 d-f	319.3 e-g	1523 b-d
6 F97-114C	52.7 b	32.2 bc	335.3 b-e	1510 b-e
7 F97-111C	47.3 c-f	28.3 d-f	338.8 a-d	1499 b-f
8 F97-129C	48.7 c-e	28.7 d-f	329.5 b-g	1637 B
9 F97-184C	46.8 d-f	28.3 d-f	314.1 g	1316 F
10 F97-221C	45.3 f	26.8 f	316.9 fg	1369 d-f
11 F97-85C	49.9 c	30.3 cd	340.0 a-c	1544 b-d
12 F97-79C	54.6 ab	31.8 bc	335.8 b-e	1567 Bc
13 F97-28C	56.6 a	34.5 a	332.3 b-f	1603 B
14 F97-91C	49.3 cd	29.1 de	342.9 ab	1677 B
15 F97-134C	49.9 c	29.3 de	323.8 c-g	1555 b-d
16 F97-185C	47.2 c-f	28.0 ef	313.8 g	1521 b-d
17 F97-135C	46.4 d-f	27.7 ef	331.5 b-f	1569 Bc
18 F97-102C	45.9 ef	27.3 ef	338.5 a-d	1549 b-d
19 ILC-482	45.3 f	24.2 g	264.1 h	1851 A
20 Diyar-95	53.7 b	32.5 b	354.9 a	1618 B
Mean	48.6	28.87	327.70	1533
LSD (%5)	2.55	1.91	14.87	16.34
CV (%)	6.53	8.21	5.63	13.22

\*Means followed by different letter(s) differ significantly at p<0.05 level

Table 3. Variance components estimated from expected mean squares and heritability

Variance	Plant Height	First Pod Height	1000 Seed Weight	Grain Yield
Genotype	10.18	4.76	302.29	78.24
Genotype x Year	0.69	1.10	19.29	118.17
Phenotype	11.25	5.58	337.06	151.87
Heritability	0.90	0.85	0.89	0.52

### Conclusion

The present study concluded that there is a great amount of genetic diversity in the germplasm studied. Majority of traits revealed high heritability and low level of differences among PCV and GCV which indicate less environmental influence on these traits and showed that genotypes had more influential role in the expression of these traits. This suggests a great chance of genetic improvements of these traits in chickpea. Thus the variability found in the germplasm could be utilized successfully in different breeding programs for the betterment of existing genotypes and for the development of desirable genotypes through hybridization.

### References

- Akhtar, L.H., Pervez M.A. and Nasim, M. (2011). Genetic divergence and inter-relationship in chickpea (*Cicer arietinum* L.). Pak. J. Agri. Sci., Vol. 48(1), 35-39.
- Ali, M. A., Nawab, N. N., Rasool, G. and Saleem, M. (2008). Estimates of variability and correlations for quantitative traits in *Cicer arietinum*. J. Agric. Soc. Sci. 4:177-179.
- Bakhsh, A., Ghafoor, A. and Malik, B.A. (1992). Evaluation of lentil germplasm. Pak. J. Agric. Res. 12 (4): 245-251.
- Comstock, R.E., Moll, R.H. (1963). Genotype x environment interactions. In: W.D. Hanson, and H.F. Robinson, (Eds.) Statistical Genetics and Plant Breeding, NAS-NRC Publ. No. 982. Wash. D.C., pp. 164-198.
- Düzgüneş, O., Kavuncu, O., Kesici, T., Gürbüz, F. (1987). Research and Experimental Methods (Statistics-II), A.Ü. Faculty of Agriculture. Publications: 1021, 381. Ankara.
- Iqbal, J., Saleem, M., Khan, A.A. and Anwar, M. (1994). Genetic variability and correlation studies in chickpea. J. Anim. Pl. Sci., 4: 35-6.
- Dasgupta, T., Islam, M.O., Gayen, P. and Sarkak, K.K. (1987). Genetic divergence in Chickpea (*Cicer arietinum* L.). Exp. Genet., 3: 15-21.
- Durga, K.K., Muthy, S.S.N., Rao, Y.K. and Reddy, M.V. (2007). Genetic studies on yield and yield components of chickpea. Indian J. Agric. 27 (3):61-79.
- Ghafoor, A., Arshad, M. and Bakhsh, A. 2004. Path coefficient analysis in chickpea (*Cicer arietinum* L.) under rainfed conditions. Pak. J. Bot. 36 (1):75-81.
- Hakim, K., Ahmad, S.Q., Ahmad, F., Khan, M.S. and Iqbal, N. (2006). Genetic variability and correlation among quantitative traits in gram. Sarhad J. Agric. 22 (1):55-59.
- Hulse, J.H. (1991). Composition and utilization of grain legumes. In: Uses of tropical Legumes: Proceedings of a Consultants' Meeting, 27-30 March 1989, ICRISAT Center, India.
- Khan, R., Khan, F. and H. (2011). Dissection of genetic variability and heritability estimates of chickpea germplasm for various morphological markers and quantitative traits. Sarhad J. Agric. 27(1): 67-72
- Minhas, R.S., Jaggi, R.C., Harma, P.S. (1987). Response of Gram to NPK Application in the Wet Temperature of Himachal Pradesh. Indian Journal of Zo-Agricultural Chemistry. 20 (1): 95-99 India.

- Saleem, M., Arshad, M. and Ahsan, M. (2008). Genetic variability and interrelationship for grain yield and its various components in chickpea (*Cicer arietinum* L.). *J. Agric. Res.* 46 (2):109-116.
- Shah, G.S. (1999). Assessment of genetic variation and heritability of yield components in Mungbean (*Vigna radiata* L.) Wilczek), and Mode of inheritance of resistance to mymv in this crop. Thesis, Instt. of Pure & Appld. Biol. Bahauddin Zakariya Univ. Multan, Pakistan.
- Singh, K. B. (1997). In : *The Chickpea*, Saxena, M. C. and K. B. Singh (eds.). CAB Intl., UK.
- Singh, K.B. and M.C. Saxena. 1999. Chickpeas. *The Tropical Agriculturalist Series*. CTA/Macmillan/ICARDA. Macmillan Education Ltd., London, UK. p. 134.
- Smith, S. E., Singh, K. B. and Malhotra, R. S. (1991). *Crop Sci.*, 31 : 1150-1163.
- Steel R.G.D and Torrie, J.H. (1960). *Principles and procedures of statistics*. McGraw Hill Book Company Inc, New York.
- Turk, Z., Atikyılmaz, N. and Şakar, D. (1999). A study for determine high yielding and large seeded winter chickpea (*Cicer arietinum* L.) cultivars in Diyarbakır conditions. *J. Agric. Fac. HR.U.*, 1999, 3(1,2):21-380
- Turk, Z., 1999. A study for determine high yielding and large seeded spring chickpea (*Cicer arietinum* L.) cultivars in Southeastern Anatolia ecological conditions. *J. Agric. Fac. HR.U.*, 1999, 3(1,2):31-38.
- Vavilov, N.I., 1926. *Studies on origin of cultivated plants*. Institute of Applied Botany and Plant Breeding, Leningrad.
- Virmani, S.S., Singh, K.B. Singh K. and Malhotra, R.S. (1983). Evaluation of mungbean germplasm. *Indian J. Genet.* 43:54-58.
- Yucel D.O., Anlarsal, A.E., and Yucel, C. (2006). Genetic variability, correlation and path analysis of yield and yield component in chickpea (*Cicer arietinum* L.). *Turk J. Agric. For* 30 (2006) 183-188, TUBITAK.

## EFFECT OF HEXACONAZOLE ON THREE PURPLE SWEET POTATO VARIETIES IN THE MEKONG DELTA

PHAM Thi Phuong Thao\*, LE Van Hoa, PHAM Phuoc Nhan, LE Thi Hoang Yen, PHAN Huu Nghia, TRAN Nguyen

Plant Physiology and Biochemistry Department, College of Agriculture and Applied Biology, Can Tho University, Vietnam

\*Corresponding author: ppthao@ctu.edu.vn

### Abstract

Hexaconazole has been so far reported to show several properties in plant growth regulations. This study was conducted to evaluate the enhancement of hexaconazole on the growth, yield and quality of three purple sweet potato varieties (*Ipomoea batatas* (L.) Lam.) in Mekong Delta. The experiment layout was randomized completely block design, in factorial arrangement with three replications. Three purple sweet potato varieties used in the experiment were HL491 from Vietnam and two varieties imported from Japan (Lord) and Malaysia. Hexaconazole of 0, 10, 15, and 100 mg/L (farmers' practice) were sprayed at 40, 55, and 70 days after planting (DAP). The results showed that the fresh vine biomass/m<sup>2</sup> and the anthocyanin content of the HL491 variety were the highest, but the number of marketable tuberous roots and total tuberous yield were lower than the two imported varieties. Hexaconazole application inhibited some agronomical characteristics such as the total leaf area, internodal and leaf petiole length at 60 DAP and reduced the fresh vine biomass (kg/m<sup>2</sup>) at harvest. The highest marketable tuberous quantity, 21 tuberous roots/m<sup>2</sup>, was achieved when spraying hexaconazole at 15 mg/L while the marketable tuberous yield and anthocyanin content were 26 tons/ha and 16.2 mg/100g fresh weight (FW) equivalent to CGE, respectively. These values were higher than those counterparts of the control: 15 tuberous roots/m<sup>2</sup>; 8.05 tons/ha and 13.4 mg CGE/100 g FW.

**Key words:** *anthocyanin, hexaconazole, Ipomoea batatas* (L.) Lam., *tuberous quality, tuberous yield.*

### Introduction

In Vietnam, sweet potato is a very important agricultural products and the area for cultivating it has been increasing in recent days with nearly 150 thousands of hectares in the year 2011 (Faostat, 2012). In the year 2015, Mekong Delta area accounted for about 15% of planted area and nearly 35% of sweet potato production in Vietnam (General statistics office of Viet Nam, 2016). Among some sweet potato varieties, purple sweet potato (PSP) variety HL491 is the most popular variety in this region. Purple sweet potato has large amount of flavonoids and anthocyanins which have antioxidant and radical-scavenging activity (Steed and Truong, 2008). A lot of experimental results indicated that nutrient can also affect the yield and the quality of tuberous roots of some sweet potato varieties; besides, some plant growth regulators could improve the yield and the athocyanins in many tuber crops (Jaleel *et al.*, 2007; Johnson *et al.*, 2008). According to Fletcher *et al.* (2000), hexaconazole, belongs triazole group of fungicides, has plant growth regulating properties. It has been widely accepted that hexaconazole has a strong influence on tuberous root growth and it may affect to produce a better quality, for example, protein, amino acid, the sucrose, carotenoids and starch contents of a tuberous root such as cassava, sweet potatoes... (Gomathinayagam *et al.*, 2008; Sivakumar *et al.*, 2009). Jaleel *et al.* (2007) found that, the application of triazole



fungicides may be a useful tool to increase the tuber quality in yam plants by enhancing the accumulation of proline and total phenols in tubers. Similar results were reported by Gomathinayagam *et al.* (2008) that using 20 mg L<sup>-1</sup> triadimefon and 15mg L<sup>-1</sup> hexaconazole solution per plant on 25, 45, 65 and 100 days after planting (DAP) by soil drenching enhanced the chlorophyll, carotenoid, and anthocyanin contents of tapioca. Therefore, the objective of this study was designed to clarify the effect of hexaconazole on the growth, yield and quality of three purple sweet potato varieties (*Ipomoea batatas* (L.) Lam.) in Mekong Delta.

### Materials and methods

The effect of hexaconazole application on three purple sweet potato (PSP) varieties was studied during the cropping season from 7/2016 to 11/2016 in the experiment field at Thanh Loi ward, Binh Tan district, Vinh Long province in Mekong Delta, Vietnam. The soil of the experimental field used was alluvial soil. Its agrochemical properties of top soil (0-20 cm depth) were: a pH (water:soil, 1:2.5) of 6.19, total N of 0.154%, total P of 0.09%, K exchangeable bases of 0.228 meq/100g, calcium exchangeable bases of 11.35 meq/100g and organic matter of 2.49%.

The experiment was laid out as a Randomized Complete Block Design (RCBD) in a factorial arrangement with three replications. The treatments consisted of three purple sweet potato varieties (PSP HL491 from Vietnam and two varieties imported from Japan and Malaysia (PSP Lord and PSP Malaysia)) combined with four hexaconazole application levels: 0, 10, 15, and 100 mg/L (as farmers' practice). There were 45 experimental units. The treatments were assigned to each plot randomly. Each was 5 m<sup>2</sup> of 5 m in length, 0.7 m in width and 0.3 m in space between plots. Plant density was 150,000 cutting plants/ha. Each plot had three rows, and 25 cutting vines (with sprout) of each variety which are 30 cm in length with 5-7 stem nodes were transplanted per row. Hexaconazole [2-(2, 4-dichlorophenyl)-(1H-1,2,4-triazol-1-yl)-2-hexanol] (C<sub>14</sub>H<sub>17</sub>Cl<sub>2</sub>N<sub>3</sub>O) has been obtained from Hexaconazole PESTANAL<sup>®</sup> (Sigma Aldrich, 99.3%). The hexaconazole applications were sprayed at 40, 55, and 70 DAP. One liter of hexaconazole solution was used for each treatment per plot and one liter of irrigation water was treated for control at one time. The fertilizer was applied five times in the experiment at 1 day before planting, 7 DAP, 30 DAP, 60 DAP, 85 DAP and 110 DAP. Nitrogen (Urea 46%N), phosphorus (single super phosphate 18% P<sub>2</sub>O<sub>5</sub>) and potassium (KCl) at the rates of 100 kg N/ha, 80 kg P<sub>2</sub>O<sub>5</sub>/ha and 200 kg K<sub>2</sub>O/ha were used for the plots. We didn't use systemic pesticide or fungicide during the experiment.

Three plants per plot from each treatment were collected randomly at 30, 60, 90 and 120 DAP for determining some growth parameters: the stem length (was measured from the soil level to the tip of the main shoot and expressed in cm), number of branches and fully developed leaves per each main stem (were counted and expressed as number per each plant). Five fully developed leaves (from the fifth node to ninth node) were chosen for measuring the total leaf area (expressed in cm<sup>2</sup> per plant by Leaf area meter, Japan), internodal length, stem diameter and leaf petiole length (by measuring the average length of five internodal stems and five leaf petioles).

Harvesting was done about 150 days after transplanting. All of the plots were harvested and analyzed the yield components: fresh weight of vines/m<sup>2</sup>, number of marketable tuberous roots, total and marketable tuberous yield (whole tubers weighing at least 50 g). Storage roots were washed and cut fine before determining dry matter weight (were dried at 55°C in hot air oven until the weight unchanged) and analyzed some quality characters: crude starch and total sugar was determined as glucose by colorimetric method (Dubois *et al.*, 1956), total anthocyanins was estimated by a pH differential method (Moor *et al.*, 2005).

Statistical analysis: statistical analysis was performed using one way analysis of variance (ANOVA) followed by Duncan’s multiple range tests (at  $P < 0.05$ ) and regression analysis were performed by using the SPSS program.

### Results and discussion

Some growth characteristics of three PSP varieties were quiet resemblance at 30 DAP (Table 1). However, there was highly significant effect of hexaconazole upon the agronomical characteristics from 60 DAP. The mean values of the internodal length of three varieties treated with some hexaconazole treatments were lower than that of control values at 60, 90 and 120 DAP (Fig. 1).

Table 1: Effect of hexaconazole on stem length, stem diameter, number of branches and number of leaves of three PSP varieties at 30 DAP

Varieties (A)	Growth parameters			
	Stem length (cm)	Stem diameter (cm)	Number of branches/main stem	Number of branches/leaves/ stem
PSP HL 491	138.9 b	0.30 b	2.29 a	32.1 a
PSP Lord	129.4 b	0.41 a	1.63 b	25.5 b
PSP Maylaysia	158.5 a	0.29 b	1.50 b	27.3 b
Hex. treatments (B)				
Control	145.3	0.34	1.67 b	28.7 ab
Hexaconazole 10 mg/L	135.6	0.33	1.22 b	25.5 b
Hexaconazole 15 mg/L	148.6	0.34	2.56 a	32.5 a
Hexaconazole 100 mg/L	139.7	0.31	1.78 b	26.4 b
F Varieties (A)	ns	ns	**	**
F Hexaconazole (B)	ns	ns	ns	ns
F AxB	ns	ns	ns	ns
CV (%)	13.1	16.5	31.6	14.7

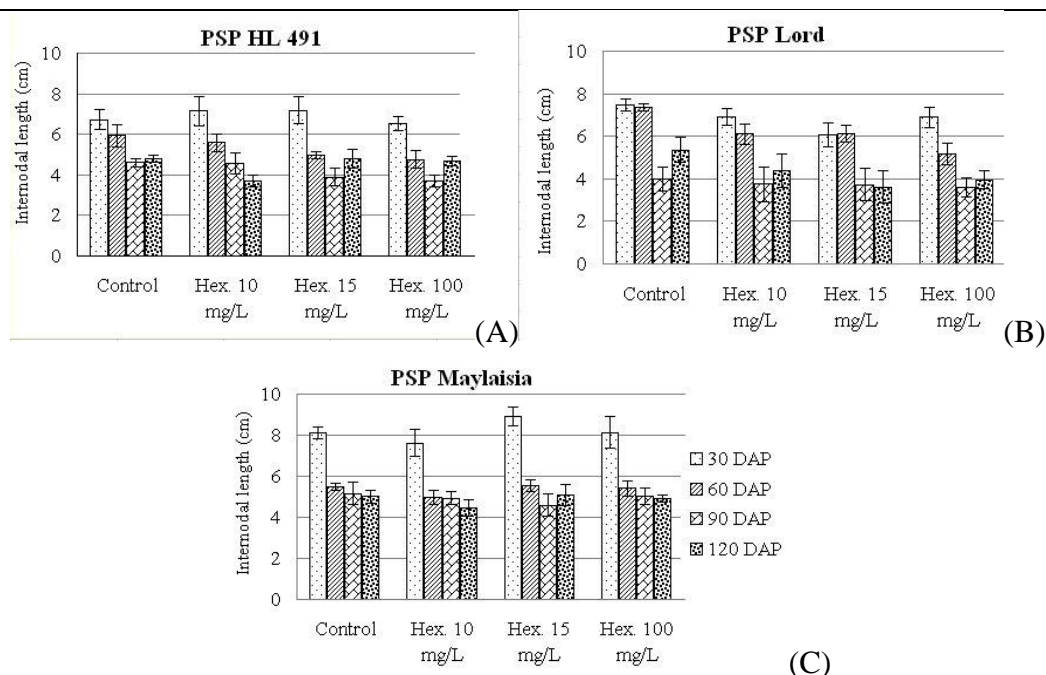


Fig. 1: Effect of hexaconazole on internodal length of three PSP varieties (PSP HL 491 (A), PSP Lord (B) and PSP Malaysia (C)) on different growth stages (DAP)

The leaf petiole length was highest at the early stage (30 DAP) and it gradually declined up to 120 DAP as shown in the Fig.2. During the period of tuber maturation (about 40 – 90 DAP), the agronomical characteristics such as shoot growth, stem length, number of branches, fully developed leaves, total leaf area, internodal length, stem diameter and leaf petiole length of all of the treatments declined (Fig.1, Fig. 2 and the data not shown).

This result confirms the results that were reported that hexaconazole inhibited some of the anatomical characteristics of plants including the retardation shoot growth, inhibition of gibberellins biosynthesis and enhancement of cytokinin and abscisic acid, increase the thickness of leaf, reduced stem elongation and plant height in some plants... (Fletcher *et al.*, 2000; Sivakumar *et al.*, 2010).

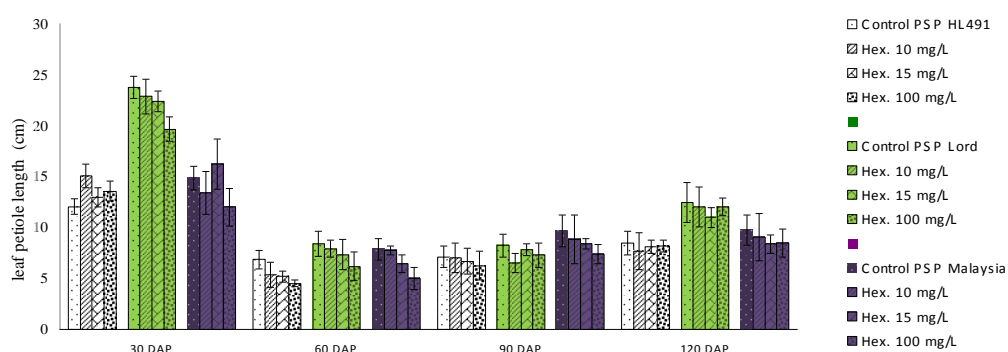


Fig. 2: Effect of hexaconazole (Hex.) on leaf petiole length of three PSP varieties (PSP HL 491 (white), PSP Lord (green) and PSP Malaysia (purple)) on different growth stages (DAP)

At harvest time, the highest fresh vine biomass was recorded from the variety PSP HL491 and it was 1.81 kg/m<sup>2</sup>. The fresh vine biomass reduced under treatments with hexaconazole at 15 and 100 mg/L when compared to control treatment (Table 2). In three PSP varieties, PSP Malaysia had significantly higher number of unmarketable and marketable tuberous roots as well as marketable and total tuberous yield than the other varieties. The marketable tuberous yield of PSP Malaysia could reach to over 25 tons/ha while the others just reached 15.6 tons/ha (PSP HL491) and 17.7 tons/ha (PSP Lord).

Table 2: Effect of hexaconazole on some storage parameters of three PSP varieties at harvest time

	Storage parameters				
	Fresh vine biomass /m <sup>2</sup> (kg)	Number of unmarketable tuberous roots	Number of marketable tuberous roots	Marketable tuberous yield (tons)	Total tuberous yield (tons)
<b>Varieties (A)</b>					
Tím HL 491	1.81 a	22.0 b	15.0 b	15.6 b	20.1 b
Tím Lord	1.65 b	17.8 c	16.1 b	17.7 b	22.1 b
Tím Maylaysia	1.55 b	25.6 a	26.4 a	25.5 a	30.6 a
<b>Hex. treatments (B)</b>					
Control	1.86 a	18.6 c	15.9 b	8.05 c	12.5 c
Hexaconazole 10 mg/L	1.72 ab	22.6 b	21.9 a	22.8 ab	27.3 b
Hexaconazole 15 mg/L	1.64 b	27.5 a	21.0 a	26.0 a	31.6 a
Hexaconazole 100 mg/L	1.46 c	18.5 c	18.0 ab	21.5 b	25.6 b
F Varieties (A)	**	**	**	**	**
F Hexaconazole (B)	**	**	*	**	**
F <sub>AxB</sub>	ns	ns	ns	*	ns
CV (%)	9.48	15.0	21.8	19.0	16.1

From Table 2, the hexaconazole treatments could increase all of storage parameters recorded in this experiment. The more increase of number of roots was prominent in spraying hexaconazole at 10 and 15 mg/L and they were more than 20 roots when compared to control with under 20 roots. The highest marketable tuberous quantity, 21 tuberous roots/m<sup>2</sup>, was achieved when spraying hexaconazole at 15 mg/L. Because of the higher number of roots, the application of hexaconazole at the concentration of 10, 15 and 100 mg/L could increase the yield over the zero application at harvest with the yield ranged from 21.5 to 26.0 tons/ha. There were highly significant effects of hexaconazole upon tuberous root yield. The result showed that, yield increased generally in three PSP varieties with different hexaconazole applications. Among the hexaconazole treatments, application of hexaconazole at 15 mg/L produced the highest marketable and total tuberous yield with 26 tons/ha and 31.6 tons/ha respectively over the control treatment. Some authors found that the cytokinin content induced by triazole may be the reason for increasing root growth because cytokinins are broadly used to induce bulb formation. A reduction in shoot growth related to the increase of root production so increase the yield (Fletcher *et al.*, 2000; Gomathinayagam *et al.*, 2008; Jaleel *et al.*, 2007; Sivakumar *et al.*, 2010).

The data presented in Table 3 are the results of some quality contents of tuberous roots at harvest time. In the field experiment involving four hexaconazole application concentrations, there was no significant variation in some quality characters of each PSP variety (Table 3). There was a slight increase in dry weight content from 36,5 to 37,5% over the control as a result of some hexaconazole applications recorded from the PSP Lord variation but the dry weight of the other varieties were unchanged with the affection of hexaconazole (Table 3).

Table 3: Effect of hexaconazole on the quality characters of three PSP varieties at harvest time

Varieties	Hexaconazole treatments	Dry weight (%)	Total sugar (mg/g FW)	Starch (mg/g FW)	Anthocyanin (mg/100g FW equivalent to CGE)
PSP HL491	Control	32.5 b	81.6 a	223.1 d	18.2 b
	Hexaconazole 10 mg/L	31.6 b	63.0 b	251.8 bc	21.1 b
	Hexaconazole 15 mg/L	31.2 b	72.9 ab	250.4 bc	25.3 a
	Hexaconazole 100 mg/L	31.5 b	62.7 b	236.0 cd	25.0 a
PSP Lord	Control	33.4 b	63.7 b	271.3 b	11.3 c
	Hexaconazole 10 mg/L	37.5 a	70.2 ab	304.5 a	9.76 c
	Hexaconazole 15 mg/L	36.1 a	74.2 ab	272.9 b	11.7 c
	Hexaconazole 100 mg/L	36.7 a	78.9 a	272.9 b	10.6 c
PSP Malaysia	Control	32.3 b	70.4 ab	257.8 bc	10.5 c
	Hexaconazole 10 mg/L	32.6 b	76.7 a	238.7 cd	9.85 c
	Hexaconazole 15 mg/L	33.2 b	73.6 ab	266.6 b	11.6 c
	Hexaconazole 100 mg/L	33.3 b	79.1 a	252.3 bc	12.0 c
F Varieties (A)		**	ns	**	**
F Hexaconazole (B)		ns	ns	ns	**
F AxB		*	**	**	*
CV (%)		3.44	8.62	5.05	13.3

In terms of total sugar content, there was the interaction between three varieties and four hexaconazole applications. The total sugar contents when applying hexaconazole at 100 mg/L of PSP Lord and PSP Malaysia were higher than recorded from PSP HL 491. The crude starch content of PSP Lord and PSP Malaysia tended higher than the crude starch content of the control treatment of PSP HL 491, but there was no significant variation in comparison to the other hexaconazole applications of PSP HL 491. Without hexaconazole supply, the crude starch of PSP Lord was highly significantly lower than that of tuberous roots in hexaconazole supplied plots (Table 3). According to Jaleel *et al.* (2008) and Gomathinayagam *et al.* (2007), the higher chlorophyll content in the leaves, leading to higher photosynthesis might have increased total dry weight in affection of triazoles.

It can be seen from the Table 3 that the variation HL 491 contained the highest anthocyanin content. The anthocyanin contents of PSP HL491 variety tended to increase when spraying hexaconazole at 15 and 100 mg/L with the anthocyanin contents achieved over 25 mg CGE/100 g FW. This is in accordance with the previous reports that triazole compounds could increase the contents of anthocyanin, carotenoid, dry weight, total phenol of bean, yam, tapioca, sweet potatoes (Jaleel *et al.*, 2007; Gomathinayagam *et al.*, 2008; Sivakumar *et al.*, 2009).

### Conclusion

This research showed that hexaconazole application inhibited some agronomical characteristics during the time of tuberous root performance (from 40 to 90 DAP). Spraying hexaconazole at 40, 55, and 70 DAP improved the number of roots as well as the tuberous root yield of three PSP varieties. PSP Malaysia proved superior over the other varieties in improving the tuberous yield. Application hexaconazole could increase the dry weight of PSP Lord. Using the application of hexaconazole at 15 mg/L appeared appropriate for optimum yield in our study area. This concentration could also enhance the dry weight of PSP Lord, the crude starch and anthocyanin content of PSP HL 491. It is suggested that hexaconazole at 15 mg/L concentration could be used on these PSP varieties in Mekong Delta.

## References

- Dubois, M., K.A. Gilles, J. K. Hamilton, P.A. Rebers and F. Smith. 1956. Colorimetric method for determination of sugars and related substances. *Anal.Chem.*, 28: 350 - 356.
- Faostat (2012), Food and Agriculture organisation of the United Nations – Statistics on-line website. <http://faostat.fao.org/beta/en/#data/QC>
- Fletcher R.A., A. Gilley, T.D. Davis and N. Sankhla. 2000. Triazoles as plant growth regulators and stress protectants. *Hort. Rev.*, 24:55-138.
- General statistics office of Viet Nam, 2016. <http://www.gso.gov.vn/>
- Gomathinayagam, M., C.A., Jaleel, G.M. A. Lakshmanan and R. Panneerselvam. 2007. Change in carbohydrate metabolism by triazole growth regulators in cassava (*Manihot esculenta* Crantz), effects on tuber production and quality. *C.R. Biologies*, 330: 644-655.
- Gomathinayagam, M., C.A., Jaleel, M.M. Azooz and R. Panneerselvam. 2008. Triadimefon and Hexaconazole enhances the photosynthetic pigment composition of tapioca, an important tuber crop. *Glo. J. of Mol. Sci.*, 4 (1): 23-28.
- Jaleel, C.A., A. Kishorekumar, P. Manivannan, B. Sankar, M. Gomathinayagam, R. Gopi, R. Somasundaram, and R. Panneerselvam. 2007. Alterations in carbohydrate metabolism and enhancement in tuber production in white yam (*Dioscorea rotundata* Poir) under triadimefon and hexaconazole applications. *J. Plant Growth Regul.*, 53, 7-16.
- Johnson, I., T. Marimuthu, R. Samiyappan and B. Cha. 2008. Influence of hexaconazole on biochemical constituents of groundnut, *Kor. J. Pesticide Sci.*, 12, 335-341.
- Moor, U., K. Karp, P. Pöldma and A. Pae. 2005. Cultural Systems Affect Content of Anthocyanins and Vitamin C in Strawberry Fruits. *Europ. J. Hort. Sci.*, 70(4): 195–201.
- Sivakumar, T., A. Sundaramanickam and R. Panneerselvam. 2009. Changes in growth and pigment content in sweet potato by triadimefon and hexaconazole. *J. of Phytology*, 1(5): 333–341.
- Sivakumar, T., G.M.A. Lakshmanan, P.V. Murali and R. Panneerselvam. 2010. Alteration of antioxidative metabolism induced by triazoles in sweet potato. *J. of Exp. Sci.*, 1(3): 10-13.
- Steed, L.E. and V.D. Truong. 2008. Anthocyanin content, antioxidant activity, and selected physical properties of flowable purple-fleshed sweetpotato Purees. *J. of Food Sc.*, (73): 215 -221.

## IMPACT OF SHEETING AND SHELF LIFE OF IBA 4000PPM ON PLANTING OF VEGETATIVE FRAGMENTS OF NATIVE AUTOCHTHONOUS OLIVE POPULATIONS

Rakip ILJAZI<sup>1</sup>, Adem SALILLARI<sup>1</sup>, Nikoll BARDHI<sup>1</sup>, Hekuran VRAPI<sup>2\*</sup>

<sup>1</sup>Department of crop Production, Faculty of Agriculture and Environment, Agricultural University of Tirana, Kodër Kamëz, Tirana, Albania

<sup>2</sup>Department of Plant Protection, Faculty of Agriculture and Environment, Agricultural University of Tirana, Kodër Kamëz, Tirana, Albania

\*Corresponding author: bardhi.nikoll@yahoo.com

### Abstract

Autochthonous cultures are an asset in the conservation, evaluation and use of native genetic resources. Especially for olive culture, where some of the native cultivars are regionalized and occupy entire masses, in thousands of acres, in areas different species of Albania, others are at risk of extinction due to genetic erosion. Many autochthonous olive populations retain special values that remain potential for exploitation by scientific research. These in general represent interest in research, biological, genetic and productive, to highlight their values. But its use, among other things, is related to the accelerated growth of forms that are of interest to either direct sowing or in the function of genetic improvement. This requires, among other things, the solution of some problems related to the addition, especially the use of phyto-hormones related to the rooting of vegetative fragments, in particular the use of IBA (Indole Butyric Acid). The use of plant hormones, which significantly increases the percentage of rooting and significantly shorten the time needed for the production of seedlings, provides healthy seedlings from phyto-sanitary side, etc. In the study are included 10 autochthonous cultivars which are the most widespread in Albania. The pieces obtained were treated with 4000 ppm solution of IBA (Indole Butyric Acid). These pieces are held in IBA (Indole Butyric Acid) solution for 5 seconds, 10 seconds, 15 seconds, and 20 seconds.

**Key words:** *cultivars, indole butyric acid, phyto-hormones, treatment, position*

### Introduction

The production of olive seedlings is implemented in various forms: generative and vegetative forms. Olive vegetative multiplication is accomplished with new methods. The fastest production of olive shoots and the highest yield is achieved by the rooting method with indole butyric acid (IBA). This method has been the subject of study and seedlings production and is being presented in this article. For over 20 years, over 40,000 olive seedlings have been produced by specialist Rakip Iljazi. The plots planted with these seedlings are in wide production, successfully.

The IBA regenerator (Indole Butyric Acid) provides a greater and faster rooting of plant fragments, both sleepy and vegetation (Chiancone et al., 2012). In this framework we have undertaken a study related to the rooting of vegetative pieces, such as time of the treatment of the position of receiving the piece on the sprout, on the top, middle and on the basis of the sprout, the time of holding the piece in phyto-hormone etc. These studies are carried out for the first time in Albania, as these are done with native variants. Multiplication with leafy pieces is a modern and widespread way at the level of industrial seedlings for olive multiplication (Di Vaio et al., 2009). Consequently, the intensification of olive production is

inseparably linked to the accelerated production of sowing and healthy material (Davison, 1997; Chaari et al., 2000).

### Materials and Methods

In this reference two aspects related to the use of IBA (Indole Butyric Acid) for the rooting of pieces are discussed: this is the effect of the picking position on the sprouts and the holding time in the solution.

Installation of the rootstock position in the rootstock percentage (top, center, and bushes) treated with IBA 4000 ppm of the 10 variations of the site and a variation introduced (Table 1).

Table 1. Indigenous variety taken in the study

1.Kalinjot	6.Nisjoti
2. Kokërr madhi i Beratit	7.I holli i Himarës
3.I bardhi i Krujë	8.I bardhi Tiranës
4.Kripës i Elbasanit	9.Mixan
5.Ullastra	10.Leçino (var. I itroduktura).

Of the ten native autochthonous varieties were taken into one-year branches in three positions at the base, mid and top of the branch. After treatment with IBA phytonutrient with a dose of 4000 ppm the pieces were put on the rooting bar. Experiments were raised in three replications with 50 pieces taken in 50 randomly selected individuals. Experiment data is subjected to statistical variance analysis. The database has been updated accordingly.

2. Influence of holding time in the IBA solution of vegetative fragments at root rate. Cows of 10 autochthonous olive cultivars after IBA 4000 ppm solution treatment were held in solution for a time: 5 seconds, 10 seconds, 15 seconds, 20 seconds. After that, they were put on the roots. Experiments were raised for each variation in three replications with 50 pieces taken in 50 randomly selected individuals. Experiment data is subject to statistical variance analysis. The database has been updated.

### Results and discussion

The results of the study of the impact of the stump position on the sprouts (tip, middle and base) in the percentage of rooting of vegetative fragments of native autochthonous cultivars.

The pieces for rooting can be in different parts of the branch, in its major part, in the middle of the branch or the base of the branch. It should be said that the emergence of adventive roots, which is at the root of the rooting capacity of a pile, is a complex phenomenon which is determined by four separate stages interdependent between them such as induction, differentiation, primordial neo-formation and emission of the roots (Chiari et al., 2000, Petrucelli et al., 2012, Ismaili, H., 2016, Rahman, N et al., 2014). Its success depends on a number of essential factors related to the vegetative state of the mother plant, the type of patch, the period of the patch preparation and the factors closely related to the effects of hormonal treatments, the temperature of the rooting ground, the intensity of the light, nebulization parameters, etc. According to Loret (2012) the rooting capacity varies between different cultivars based on the proportion of rootstocks (in the major, mid, or branch). But the variation observed in many studies does not allows above all to individualize the type of stalk that will be taken for rooting. In general, it can be assumed that, in line with vegetative growth, sub-major cuts are more susceptible to auxin treatments and have been equipped with a greater ability to root. Hartman H.Then.1975, Di Vaio C.etj. 2009. Di Vaivo, Nocerina and



Sorrentina in a 2014 study with Campanias olive cultivars observed changes where, according to them, the mid-sprouts and the tops had a higher rooting rate

But let's see how the percentage of rooting vegetative fragments of autochthonous varieties is presented, we refer to the average data of the experiments realized by us. From the data in Table 2 we note that the percentage of rooted pieces for the pieces obtained at the top of sprouts varies from 16.60 per cent to the variant of I Holli i Himarës in 90.60 of the Kalinjoti variant, with an average of 56.72 per cent. For the pieces taken from the middle of the sprout for this indicator varies from 14.60 per cent to the I Holli i Himarës variation at 82.60 per cent of the Kalinjoti variant, with an average of 55.08 percent. While for the pieces taken from the base of the branch range from 15.20 percent to the variety of I Holli i Himarës, to 80.6 percent of the Kalinjoti variety with an average of all varieties of 52.10 percent. As a conclusion, it is seen a decrease in the percentage of rooting by passing from the pieces obtained at the tip of the branch to these of the base of the branch. This is a general tendency since, if we refer to the average of all the varieties, we will see that the average of the pieces obtained at the tip of the branch has resulted 56.72%, whereas for the split pieces in the middle of the branch is 55.08% and the pieces obtained on the basis of the branch is 52.10%.

Table 2. Average data of the percentage of rooted vegetative fragments of 10 olive varieties. Pieces taken to the top, middle and base of the shoot after treatment with IBA 4000ppm.

Nr	Cultivars	Taken to the top, middle and base of the shoot		
		top	midle	base
1	Kalinjoti	90.6	82.6	80.6
2	KM Beratit	36	34	32
3	I bardhi i Krujes	38	35.4	32
4	Kripsi Elbasanit	52.6	50	48
5	Ullastra	81.4	79.4	79.4
6	Nisjoti	35.4	31.4	30
7	I holli Himarës	16.6	14.6	15.2
8	I bardhi Tiranes	64.6	63.4	62.6
9	Mixani	70	68.6	64
10	Leçino	82	80.6	78
<b>Average</b>		56.72	55.08	52.1

Source of information: The experiment results

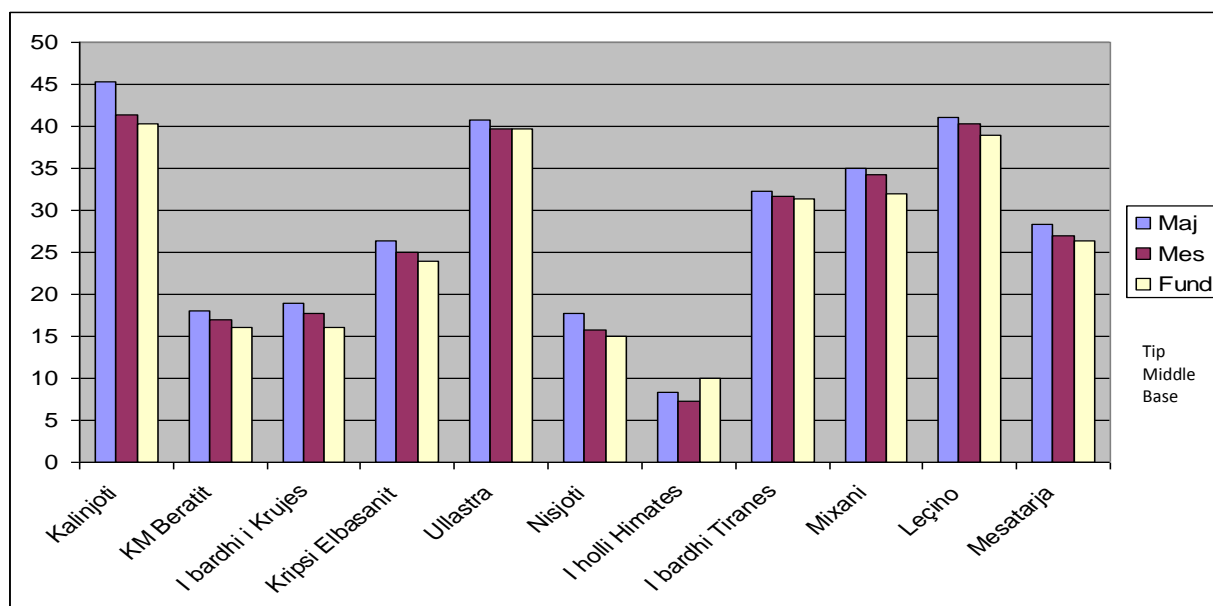


Figure 2. Graphical representation of the average number of roots, of the 10 olive varieties obtained (top, middle, and spinal base) after treatment with IBA 4000ppm.

Table 3 shows the variance analysis of the rootstocks data of 10 olive varieties obtained from the tip, the middle and the base of the seedlings after treatment with IBA 4000 ppm.

From the variance analysis data it can be seen that the variation on the percentage of vegetative rooting is significant for the variation coming from the varieties, and that from the position of the pieces picking to the spike is occasional.

Table 3: The variation analysis

Variation Source	Square Sum	Df*	Mean Square	F. actual	P-value	F-kritike
Cultivars	15908.86	9	1767.651	820.2134	1.20E-21	2.4563
replication	104.408	2	52.204	24.2233	7.86E-06	3.5546
Error	38.792	18	2.1551			
Total variation	16052.06	29				

\*Df = Degree of freedom \*\* Significant at a level of 1% of probability ( $p < .01$ ) \* Significant at a level of 5% of probability ( $.01 \leq p < .05$ ) ns Non-significant ( $p \geq .05$ )

In addition, two-factor analysis of the variance and interaction of the two variance factors and the position of receiving the part at their rooting was presented in Table 2. From the data of this table we see that the interaction between the factor variance and the position of the piece taken in the catch is random, that is not the same in all varieties.

Table 4. Two-factor variance analysis of roots of 10 olive cultivars taken at the top, middle and base of the shoot after treatment with IBA 4000 ppm.

Source of Variation	Square Sum	df	Mean Square	F. actual	P-value	F crit
Sample	12045.433	9	1338.381	<b>757.574</b>	2.64E-58	<b>2.0401</b>
Columns	84.689	2	42.344	<b>23.969</b>	2.24E-08	<b>3.1504</b>
Interaction	25.533	18	1.419	0.803	0.689067	1.7784
Within	106	60	1.767			
Total	12261.656	89				

\*Df = Degree of freedom \*\* Significant at a level of 1% of probability ( $p < .01$ ) \* Significant at a level of 5% of probability ( $.01 \leq p < .05$ ) ns Non-significant ( $p \geq .05$ )

## **Conclusions**

From the experiment data regarding the picking position in the shoots performed in 10 olive varieties from which 9 local varieties and one introduced we reach the following conclusions: The mean rooting percentage of the pieces obtained in tip, middle and the base of the sprout after treatment with phyto-hormone indicates the highest ability in the major part, which comes down to the base of the sprout. This phenomenon is generally the case for studied additions.

From the experimental data regarding the time of 10 olive cultivation solutions, differences between cultivators treated in terms of rooted pieces percentage are observed. The cultivar that provides a higher percentage of rooting is the cultivar Kalinjoti and the lower the I Holli i Himarës.

Data derived from these experiments can be used by specialized olive-seed producers when dealing with multiplication of these stages.

## **References**

- Chaari A., Chaabouni CH, Maalej M., Drira N. (2000): Meski olive varieties propagated by tissue cultur.Symposium on Olive, Meski olive varieties propagated by tissue culture.ISHSActaHorticulturae 586: IV International Symposium on Olive Growing.
- Chiancone B., German M.A., Di Marco L. (2009): Remarks on the genotype cuttings of Oleaeuropaea var. sylvestris. National Olive and Oil Covenant.1-2 October 2009 Session - Nursery and Defense 97 Poster-50.
- Di Vaio C., Nocerino S., Sorrentino C. (2009): Variability of the rhizogenic attitudes and effect of stimulation treatments to rooting cuttings of olive bellies varieties. National Olive and Oil Covenant.1-2 October VI Session - Nursery and Defense 98 Poster-51.
- Hartman H.T., Kester D.E. (1975): Plant propagation: principles and practices. Print. Hall. Inc. Englewood Clifts N.J., p.662.
- Ismaili H. (2016): Study of Some Forms of IBA in the Rooting Process of the Olive. Int.J.Curr.Microbiol.App.Sci.5 (3) 239-246.
- Loreti F., Morini S. (2012): Propagation techniques. Published online in March 2012. National Olive and Oil Academy - Unity DSpace.
- Petrucelli R., Micheli M., Primo Proietti P., TommasoGanino T. (2012): Multiplication of olive and olive cultivation in Italy. Review n. 16 - ItalusHortus 19 (1): 3-22.
- Rahman N., Ali Awan A., Nabi G., Ali Z. (2014): Root Initiation in Hard Wood Cuttings of Olive Cultivar Coratina Using Different Concentration of IBA. Research Article International Journal of Advanced Biological Research 2 (12) -1920-1924.

## STUDY OF FOLIAR FERTILIZERS IMPACT ON THE BIOMETRIC INDICATORS OF TWO COMMON WHEAT VARIETIES

Antoniya STOYANOVA<sup>1</sup>, Velika KUNEVA<sup>2</sup>

<sup>1</sup>Trakia University, 6000 Stara Zagora, Bulgaria

<sup>2</sup>Agricultural University, 4000 Plovdiv, Bulgaria

\*Corresponding author: toni\_1219@abv.bg

### Abstract

The purpose of the present research is to study the significance and impact of factors: *variety* and *treatment options*, and their interaction on the structural elements of *Enola* and *Illico* common wheat varieties. For this purpose, an experiment was conducted in the period 2014-2016 in the training experimental field of Trakia University, Faculty of Agriculture, Stara Zagora, Bulgaria. The experiment was performed by the method of fraction plots, with a crop plot size of 10 m<sup>2</sup>. It included two varieties of common wheat: *Enola* and *Illico*. The applied liquid fertilizer Lactifrost and Lactofol are special leaf fertilizers rich in macro and trace elements. The following test options were: 1. Control - zero fertilization; 2. Fertilization with N<sub>14</sub>; 3. Fertilization with N<sub>14</sub> + Lactifrost; 4. Fertilization with N<sub>14</sub> + Lactifrost + Lactofol base; 5. Fertilization with N<sub>14</sub> + Lactofol base. Foliar treatment was conducted in the morning hours at doses of Lactifrost - 1/da and Lactofol base - 0.5 l/da. Results of a two-factor dispersion analysis proved that A factor - *variety* had a dominant impact on *ear grains weight* indicator in 2014. It was statistically proven at  $p \leq 0.001$ . The lowest and mathematically unproven was B factor - *treatment options* and the interaction of both factors. The individual effect of the studied factors is much more expressed at the formation of the structural indicator for the examined wheat varieties.

**Keywords:** *Common wheat, yield, foliar fertilizers, ANOVA, Bulgaria.*

### Introduction

In the age of general globalization, agriculture must increase the yield of farming production because of the increasing demand and the reduced offer of food products. Yields increase can be obtained by agriculture intensification and soil fertility increase. One of the agro-technical measures leading to the increase of soil fertility is the application of fertilization with micro and macro-fertilizers. All fertility enhancers should be given a certain nutrient balance in the soil. Yields, as well as their structural elements, are strongly influenced by the year conditions and the variety plasticity, Georgieva and co. (2004). Late germination leads to the formation of a smaller number of ear-bearing stems for the conditions of the Upper-Trakia Plain. Climate anomalies reduce the coefficient of productive tillering. The main agrotechnical factors for the formation of biological and economic characteristics of 14 winter common wheat varieties are the annual weather conditions. The main factors for grain's yield is the norm of the mineral fertilization, according to Ivanova and co. (2009). Some authors' research shows that yield quantity is closely related to the variety, the level of applied agro-technology, and the soil and climatic conditions of the region (Cenov et al. 2009). Fertilization is a determining factor for obtaining high grain yields in the absence of another limiting factor, according to Gastol and Lemaize (2002). The unilateral application of mineral fertilizers leads to disturbance in the ecological equilibrium and lower production quality, according to Brzozowska I. (2008). An experiment has been conducted to study the effect of leaf zinc supply combined with nitrogen or phosphorus. It has been

established the element's availability in the grain at different levels of nitrogen supply (Meng et al., 2015).

The natural fertility of soils is not sufficient to ensure high and stable wheat yields. The main fertilization and foliar fertilization during the vegetation aim to obtain the maximum realization of the crop productive capacities and high quality production. Quality depends on the choice of variety and the applied cultivation technology. Qualitative indicators are external, physical, chemical, biochemical, technological, etc. It is important to explore and to distribute properly the nutrient macro and microelements, to create a strategy for yields increase without affecting nutritional qualities (Daniel and I. Ortiz-Monasterio, 2003, Ivanova, 2007, Yanchev, and K Ivanov, 2012; Valkova, E., 2015). The purpose of the present research is to study the significance and impact of the factors: A – “variety” and, B – “treatment options”, and their interaction (AxB) on the structural elements of *Enola* and *Illico* common wheat varieties.

### Material and Methods

For this purpose, an experiment was conducted in the period 2014-2016 in the training experimental field of Trakia University, Faculty of Agriculture, Stara Zagora, Bulgaria. The experiment was performed by the method of fraction plots, with a crop plot size of 10 m<sup>2</sup>. It included two varieties of common wheat: *Enola* and *Illico*. *Enola* is an early variety that is present in the official Bulgarian list of varieties. It is a fiery variety with red grains. Its advantages are: wide environmental plasticity, good cold resistance, tolerance to drought. *Illico* variety is implemented by Syngenta in Bulgaria. The introduced variety is a medium-sized, early-grain variety with large grains. It is well adapted due to its high plasticity in terms of climatic conditions; it gives high and stable grain yields (Dospatliev et al., 2015; Stoyanova et al., 2016). The Lactifrost and Lactofol base foliar fertilizers are the main specialized fertilizers of the company EcoFol. The applied liquid fertilizer Lactifrost and Lactofol base are special leaf fertilizers rich in macro and trace elements (table 1). The two formulations also contain physiologically active organic substances and natural binders.

**Table 1.** Composition of applied foliar fertilizers

Composition of the applied foliar fertilizers									
Foliar fertilizer	gram liter <sup>-1</sup>				mg liter <sup>-1</sup>				
	N*	P <sub>2</sub> O <sub>5</sub>	K <sub>2</sub> O	SO <sub>3</sub>	B	Cu	Mn	Mo	Zn
Lactofol base	101	29.4	50.9	1.36	305	203	226	23	452
Lactifrost	13.8	42.4	37.9	2.12	477	106	106	2120	64

\* NO<sub>3</sub>-N + NH<sub>4</sub>-N + NH<sub>2</sub>-N (g l<sup>-1</sup>): 22.6 and 13.8 + 11.3 and 6.4 + 67.8 + 0, for Lactofol and Lactifrost, respectively

The following test options were: 1. Control - zero fertilization; 2. Fertilization with N<sub>14</sub>; 3. Fertilization with N<sub>14</sub> + Lactifrost; 4. Fertilization with N<sub>14</sub> + Lactifrost + Lactofol base; 5. Fertilization with N<sub>14</sub> + Lactofol base. Foliar treatment was conducted in the morning hours at doses of Lactifrost - 1/da and Lactofol base - 0.5 l/da.

**Table 2.** Organic and mineral content in the soil horizon 0-60 cm

Indicators	pH (KCi)	Humus %	Mineral nitrogen mg/1000g soil	N-NH <sub>4</sub> , mg/1000g soil	N-NO <sub>3</sub> , mg/100g soil	Assimilate P, mg/100g soil	Assimilate K, mg/100g soil
Experimental values	5.73	3.93	40.78	0.45	40.33	3.27	34.17

Soil conditions are of primary importance for wheat growth: the environment in which wheat develops its root system and draws the necessary nutrients. The experimental field is characterized with a typical meadow cinnamon soil. The profile power is 103-105 cm, with well-formed horizons. The humus horizon is clearly expressed and has a range of 0-50 cm. The mechanical composition of the soil is sandy-clayey. Conservation of organic and mineral substances in the soil layer 0-30 cm is presented in Table 2. Soil in the region is slightly acidic. It is medium with humus - 3.93%. Soil is medium supplied with mineral nitrogen - 40.78 mg/1000g, weakly supplied with active phosphorus - 3.27 mg/1000g and well supplied with absorptive potassium - 34.17 mg/1000g. The amount of mineral nitrogen (NH<sub>4</sub> + NO<sub>3</sub>) was determined by the Parnas-Wagner apparatus; the mobile P<sub>2</sub>O<sub>5</sub> by the spectrophotometric method, and the mobile K<sub>2</sub>O-atomic absorption assay. The sowing was conducted in the optimum period for the region from 10 to 25 October. During the field survey, all the agro-technical requirements for a standard wheat breeding technology in Bulgaria were covered.

The mathematical processing of the results was performed by two-factor dispersion analysis (ANOVA).

### Results and Discussion

When taking into account the climate, the region of the experimental field refers to the European continental climate region, the Trans-Continental Sub-region, which includes the area of Eastern Central Bulgaria and the Trakia Plain. Stara Planina Mountain from the north and the Rhodope Mountain range from the south affect the climatic conditions and protect from winds. The winter season is relatively mild and warm.

Taking into account the meteorological factors, the field experiment years are characterized with significant differences in the measured average daily temperatures by months compared to the multiannual period (1930-2014). The experimental field altitude is 160 m. The terrain slope is flat, with an incline of 3%.

**Table 3.** Meteorological characteristics, by months, for the period of common wheat vegetation, 2013-2016 for the region of St. Zagora

Years	Precipitation, mm								
	10	11	12	1	2	3	4	5	6
2013/2014	75.3	49.3	8.6	58.6	1.1	133.7	64.5	110.2	51.3
2014/2015	109.2	38.0	168.8	21.8	63.3	95.2	31.8	57.8	121.8
2015/2016	69.0	70.2	1.3	68.0	19.6	43.2	68.0	95.7	58.8
<i>1930/2014</i>	<i>43.2</i>	<i>48.8</i>	<i>53.3</i>	<i>38.9</i>	<i>36.0</i>	<i>37.7</i>	<i>46.2</i>	<i>60.7</i>	<i>66.2</i>
<i>1961/1990</i>	<i>47,7</i>	<i>43,1</i>	<i>56,8</i>	<i>33,6</i>	<i>40,1</i>	<i>42,1</i>	<i>48,9</i>	<i>57,3</i>	<i>67,2</i>
	Temperature, C°								
2013/2014	11.6	9.4	1.3	3.2	5.7	9.5	12.7	17.0	21.2
2014/2015	12.8	7.4	4.5	2.7	4.2	7.2	11.9	19.1	21.1
2015/2016	12.9	10.3	3.7	-0.1	7.8	8.8	14.6	16.2	23.0
<i>1930/2014</i>	<i>13.3</i>	<i>7.5</i>	<i>3.0</i>	<i>1.9</i>	<i>3.1</i>	<i>6.4</i>	<i>12.0</i>	<i>17.1</i>	<i>21.0</i>
<i>1961/1990</i>	<i>12,9</i>	<i>7,4</i>	<i>2,9</i>	<i>1,7</i>	<i>3,1</i>	<i>6,5</i>	<i>12,0</i>	<i>17,1</i>	<i>20,7</i>

The period of wheat growth was characterized by the three experimental years with uneven distribution of precipitation (Table 3). In March 2014, there was a peak in rainfall of 133.7 mm. Sufficient moisture storage with easily accessible moisture provided optimal crop growth conditions that year and compensated for the rainfall in February. Temperature values did not have large deviations from the average, measured during the period 1930-2014. In the third year of experience, low average daily temperatures were recorded in January (-0.1 C°). Wheat survived successfully throughout the study period.

A two-factor dispersion analysis was performed to evaluate the significance and power of influence of the factors: A-variety, B-treatment variants and their interaction (AxB) on the structural elements of *Enola* and *Illico* wheat. The obtained experimental data was processed statistically by MS Excel computer software. Impact evaluation of the factors was calculated with the Plocksky method (Lakin, 1990). It is defined as part of the intergroup variation in the overall variation. The squares sums were calculated by the formula: where - is the squares sum of the factor x, - the total sum of the squares (SS). The dispersion analysis for the impact of the factors: *variety*, *treatment options* and their interaction are presented in Tables 4, 5, 6, 7 and 8. The objective of the two-factor dispersion analysis is to assess the significance and the impact of the factors *variety*, *treatment options* and their interaction on the biometric indicators of the studied common wheat varieties. This is the reason that the presented analysis was made for two distinct years with different rainfall and temperatures. The climatic features of each region leads the selection of cultivated varieties. In each experimental year, with 20 varieties of soft wheat Samodova (2008), it was proven the impact of climate change and the coincidence of the phases of plant development with the current climate conditions. The dispersion assays for the influence of factors: A – “variety”, B - "treatment variants" and their interaction (AxB) on the biometric "plant height" indicator for the varieties under consideration are shown in Table 4. In this indicator, the 48% chance factors for the variability of the feature most affected the year 2014 and 67% in 2016, followed by species varieties and treatment variants. The interaction of the two factors is less pronounced.

**Table 4.** Two-factor dispersion analysis of **plant height** of wheat varieties-Enola-Illico

Variation source	SS	df	MS	F	P-value	F crit	Influence of factor (%)
2014							
Wheat variety (A) ***	316.10	1	316.10	8.69	0.01	4.49	26
Treatment options (B) n.s.	216.83	3	72.28	1.99	0.16	3.24	18
Interaction (AxB) n.s.	107.39	3	35.80	0.98	0.43	3.24	9
Errors	582.33	16	36.40				48
2016							
Wheat variety (A) ***	45.93	1	45.9	3.6	0.08	4.49	15
Treatment options (B) n.s.	17.32	3	5.8	0.5	0.72	3.24	6
Interaction (AxB) n.s.	35.42	3	11.8	0.9	0.45	3.24	12
Errors	204.35	16	12.8				67

In this indicator, the option impact of the attribute has the highest influence on factor A with 76% effect in 2016, followed by 5% treatment options. The interaction of the two factors is less expressed (Table 5).

**Table 5.** Two-factor dispersion analysis of **wheat ear length** of varieties-Enola-Illico

Variation source	SS	df	MS	F	P-value	F crit	Influence of factor (%)
2014							
Wheat variety (A) ***	0.85	1	0.85	4.56	0.05	4.49	5
Treatment options (B) n.s.	9.15	3	3.05	16.33	0.00	3.24	57
Interaction(AxB) n.s.	3.02	3	1.01	5.39	0.01	3.24	19

Errors	2.99	16	0.19				19
2016							
Wheat variety (A) ***	81.98	1	81.98	74.44	0.00	4.49	76
Treatment options (B) n.s.	5.07	3	1.69	1.53	0.01	3.24	5
Interaction (AxB) n.s.	2.89	3	0.96	0.87	0.01	3.24	3
Errors	17.62	16	1.10				16

The *ear length* indicator is statistically proven with a very high degree of confidence ( $p \leq 0.001$ ) is the influence of the treatment variants and the variety, with a trend indicating the stronger influence of the variety, followed by the treatment options and the interaction of the Both factors. For the *number of spikes* in the first year of the study, the influence of factor A was greatest (39%), whereas the effect of treatment (factor B) was only 8%. In 2016, the impact of factor B is greater (19%). The results of the biometric indicator *number of spikes* are quite mixed. In 2014, the influence of the variety is dominated, followed by the unexplained impact due to random factors of 27% (Table 6). In 2016, the impact of random factors prevailed by 58%, followed by treatment options with an impact strength of 19%.

**Table 6.** Two-factor dispersion analysis of **spike number** for wheat varieties-Enola-Illico

Variation source	SS	df	MS	F	P-value	F crit	Influence of factor (%)
2014							
Wheat variety (A) ***	23.74	1	23.74	22.58	0.00	4.49	39
Treatment options (B) n.s.	5.20	3	1.73	1.65	0.22	3.24	8
Interaction (AxB) n.s.	15.53	3	5.18	4.92	0.01	3.24	25
Errors	16.83	16	1.05				27
2016							
Wheat variety (A) ***	5.26	1	5.26	3.41	0.08	4.49	12
treatment options (B) n.s.	7.96	3	2.65	1.72	0.20	3.24	19
Interaction (AxB) n.s.	4.92	3	1.64	1.06	0.39	3.24	12
Errors	24.65	16	1.54				58

For the *number of ear grains*, the power factor A (*treatment options*) is 20% and 25%, respectively, in the first and third years. The impact of the interaction of the studied factors has the same values during the two years of the field study (Table 7). For the *number of ear grains* indicator, for both years under review, the unexplained impact of accidental factors of 70% is again most strongly followed, followed by fertilization options.

**Table 7.** Two-factor dispersion analysis of **number of ear grains** in wheat varieties-Enola-Illico

Variation source	SS	df	MS	F	P-value	F crit	Influence of factor (%)
2014							
Wheat variety (A) ***	22.56	1	22.56	1.00	0.33	4.49	4
Treatment options (B) n.s.	103.50	3	34.50	1.52	0.25	3.24	20
Interaction (AxB) n.s.	32.13	3	10.71	0.47	0.71	3.24	6



Errors	362.58	16	22.66				70
2016							
Wheat variety (A) ***	0.06	1	0.06	0.00	0.96	4.49	-
Treatment options (B) n.s.	137.23	3	45.74	1.88	0.17	3.24	25
Interaction (AxB) n.s.	31.70	3	10.57	0.43	0.73	3.24	6
Errors	389.25	16	24.33				70

**Table 8.** Two-factor dispersion analysis of **weight of ear grains** in wheat varieties-Enola-Illico

Variation source	SS	df	MS	F	P-value	F crit	Influence of factor (%)
2014							
Wheat variety (A)***	0.355	1	0.35	45.45	0.00	4.49	69
Treatment options (B) n.s.	0.024	3	0.01	1.05	0.40	3.24	5
Interaction (AxB) n.s.	0.010	3	0.00	0.42	0.74	3.24	2
Errors	0.125	16	0.01				24
2016							
Wheat variety (A) ***	0.00	1	0.005	0.00	0.96	4.49	-
Treatment options (B) n.s.	0.33	3	0.11	5.43	0.01	3.24	39
Interaction (AxB) n.s.	0.18	3	0.06	2.89	0.07	3.24	2
Errors	0.33	16	0.02				39

The A-variety factor is more expressed with a 69% and 39% of impact strength, respectively, in 2014 and 2016, with the ear grains` weight.

Results for the parameters: *ear grains weight, number of grains, plant height*, reliable options for Factor A - *variety* were recorded, with an impact of 69% (*ear grains weight*). The treatment options were statistically unproven; the interaction of the two factors was statistically less expressed (2014).

The variety factors, treatment options and their interaction were statistically unproven: *the plant height, the number of grains and the number of ear grains*.

According to the one-way ANOVA, as well as the conducted analysis for the impact of the two factors (variety and options of treatment) separately, and their interaction, the impact on grain-yield index was statistically proven at a very high degree of reliability ( $p \leq 0.001$ ).

### Conclusions

According to the two-way analysis of variance, and considering the impact of the two factors (variety and variants of treatment) separately, and their interaction, it was statistically proven a very high degree of reliability ( $p \leq 0.001$ ) the impact of the variety on all the indicators under consideration. "Variety" had the greatest impact on the variation of the trait factor.

1) The results of a two-factor dispersion analysis proved that A factor - *variety* has a dominant impact on the *crop grains weight* indicator in 2014, which was statistically proven at  $p \leq 0.001$ .

2) The lowest and mathematically unproven was B factor - *treatment options*, as well as the interaction of both factors.

3) The individual effect of the studied factors was much more expressed in the formation of the structural indicator for the examined wheat varieties.

These data should be taken into account for their cultivation under different conditions.

## References

- Brzozowska I. (2008). Macroelement content in winter wheat grain as affected by cultivation and nitrogen application methods. *Acta Agrophysica*, vol: 11, number: 1, pages: 23-32.
- Dospatliev L.K., Stoyanova A.K., Zhelyazkova T.Z., Valchev N.Y., Delchev G.D., Ivanova M.T. (2015). Stability and technological value of common wheat varieties Enola, Illico and Ingenio treated with herbicide mixtures. *International Journal of Scientific and Research Publications*, Volume 5, Issue 11, ISSN 2250-3153, 373-380, India.
- Daniel F. Calderini and Ivan Ortiz-Monasterio. (2003). Grain Position Affects Grain Macronutrient and Micronutrient Concentrations in Wheat. *ACSESS DL. Crop Science Society of America*. Published in *Crop Sci.*43:141–151. doi:10.2135/cropsci2003.1410
- Georgieva, H., Tsankova D., Samodova A. (2004). Biological and economic qualities of some promising wheat varieties. *Research on Field Cultures*, 2004, Vol. I, 51-56, Bg.
- Gastal, F., Lemaire G. (2002). Nitrogen uptake and distribution in crops, an agronomical and ecophysiological perspective. *Jurnal of Experimental Botani*, Vol. 53, №370.
- Ivanova, A., Tsenov N. (2009). Biological and economic characteristics of varieties of common wheat according to the conditions of cultivation. *Field crop research*, vol. V-1, 173-182, Bg.
- Ivanova, A. (2007). Genotypic specificity in nutrient absorption in common wheat (*Triticum aestivum* L.). Autoreport for awarding a PhD degree and a scientific degree, Bg.
- Lakin D. (1990). *Biometrics*, High School, Moscow (RU).
- Meng Li, Shaoxia Wang, Xiaohong Tian, Jihong Zhao, Hongyun Li, Chunhui Guo, Yanlong Chen, Aiqing Zhao. (2015). Zn distribution and bioavailability in whole grain and grain fractions of winter wheat as affected by applications of soil N and foliar Zn combined with N or P. *Journal of Cereal Science*. Volume 61, 2015, Pages 26–32.
- Stoyanova A., Ganchev G., Kuneva V. (2016). Nutrition value of two grain common wheat. *Scientific Papers. Series A. Agronomy*, Vol. LIX, ISSN 2285-5785, 421-425, Romania
- Samodova, A. (2008). Test of varieties of ordinary winter wheat in the soil-climatic conditions of Pazardzhik. *International Scientific Conference June 5-6, Stara Zagora*, 9789549329445, 7.
- Tsenov, N., Kostov K., Todorov I., Panayotov I., Stoeva I., Atanasova D., Mankovski I., Chamurliiski P. (2009). Problems, Achievements and Perspectives in the Productivity Selection in Winter Wheat. *Field crop research*, vol. V-2, 261 – 273, Bg.
- Valkova, E. (2015). Comparative study of the levels of some heavy metals in the organism of heterotrophic hydrobiontes from reservoirs in Stara Zagora Region. Dissertation for awarding educational and scientific degree "PhD", 249 pp.
- Yanchev I. and Ivanov K. (2012). Comparative testing of physical, chemical and technological qualities of Bulgarian and Greek varieties of common wheat. *Field Crops Studies*, 2012, Vol. VIII - 2, 219-226, Bg.

## WATER USE EFFICIENCY AND LAND EQUIVALENT RATIO OF SOYBEAN AND CORN IN SOLID AND INTERCROPPING SYSTEMS IN EGYPT

Abd El-Alim Abdel-Rhman METWALLY<sup>1</sup>, Sayed Ahmed SAFINA<sup>1</sup>, Rushdy EL-KILLANY<sup>2</sup>, Neama Abd El-Salheen SALEH<sup>1</sup>

<sup>1</sup> Agronomy Department, Faculty of Agriculture, Cairo University, Giza, Egypt.

<sup>2</sup> Soil Department, Faculty of Agriculture, Cairo University, Giza, Egypt.

\*Corresponding author: drabdmewally.agric@hotmail.com

### Abstract

The present investigation was carried out at Giza Agricultural Experiments and Research Station, Faculty of Agriculture, Cairo University, (Egypt) during the two successive seasons 2015 and 2016 to determine productivity, water use efficiency (WUE), land equivalent ratio (LER) of intercropping soybean with corn in beds as compared with solid plantings in ridges. The experiment included eighteen treatments which were the combinations between three applied irrigation water (75, 100 and 125% of the recommended one, 8092m<sup>3</sup>/ha) and six cropping systems (intercropping 50% soybean + 100% corn and 100% soybean + 100% corn on beds, solid corn and soybean as 'mixed system', traditional solid soybean and corn on ridges). The experimental design was split plot design with four replications. The data indicated that soybean seed yields per plant and per ha were affected negatively by intercropping. Increasing soybean plant density per unit area in mixed culture from 50 to 100% of soybean increased soybean yield without reduction on corn grain yield. Soybean seed yield was not affected by water treatments; meanwhile the reverse was true for corn crop. LER was not affected by applied irrigation water treatments but it was affected significantly by cropping systems. LER ranged from 1.39 to 1.52. WUE was increased with decreasing applied irrigation water from 125 to 75% of the recommended one. High population densities of the intercrops with applied 100% water achieved the highest LER and WUE and could be recommended for Egyptian farmers.

**Keywords:** Intercropping, Soybean, Corn, WUE, LER.

### Introduction

Population growth always requires an increase in the use of available environmental resources around the world. It is considerable pressure on available environmental resources especially water that is one of the major factors in arid and semiarid regions (Zadeh and Mousavi, 1996). Moreover; the limited water resources in Egypt are most pressing factors of water issues. However, increased cropping systems to meet world demands will require an increase of 40% in the area of harvest major crops by 2030, and that the amount of water allocated to irrigation must increase correspondingly by 14% (UNESCO, 2006). Accordingly, insufficient food supply in the near future encourages intensification of the search for more productive agricultural techniques by increasing water use efficiency (WUE). Improving WUE is necessary for securing environmental sustainability of food production in semiarid areas with respect to population growth (Medrano *et al.*, 2015). The current population of Egypt is 94,779,988 based on the latest United Nations estimation.

Intercropping is one of the agricultural strategies for increasing water productivity to make maximum use of soil moisture (Alizadeh, 2001). In this concern, intercropping soybean with

corn was the successful example to save irrigation water (Ouda *et al.*, 2007) and increase each of land and net equivalent ratios (Metwally *et al.*, 2008; Metwally *et al.*, 2012).

In Egypt, there is a modern trend for growing crops on beds (100 – 140 cm width) according to population densities of field crops (wheat, corn, cotton, soybean, --etc.) to save irrigation water by about 15% compared by traditional practice on ridges 60-70 cm in width (Ouda *et al.*, 2007). Therefore, the objective of this investigation was to determine productivity, WUE and LERs of intercropping soybean with corn in beds as compared with traditional solid plantings on ridges.

## Materials and Methods

A two-year study was carried out at Giza Agricultural Experiments and Research Station, Faculty of Agriculture, Cairo University, Giza, Egypt during two successive summer seasons (2015 and 2016). The main factors were three levels of applied irrigation water (6069, 8092 and 10115 m<sup>3</sup>/ha) and six cropping systems of solid and intercropping corn and soybean. Eighteen treatments were the combinations of the previous factors (Figure 1) as follows:

### Intercropping systems

Corn plants were grown in both sides of beds 140 cm width by growing two plants/hill distanced 50 cm apart, meanwhile two rows of soybean were grown in middle of the bed (2 plants/hill distanced 15 cm apart). This pattern was expressed as 50% soybean + 100% corn plants as the previous pattern (Inter1).

Inter2, as that of pattern (Inter1) but four rows of soybean were grown in middle of the bed (2 plants /hill distanced 15 cm apart). This pattern was expressed as 100% soybean + 100% corn.

### 2. Solid systems:

a. Solid plantings of corn and soybean on beds as mixed (140cm).

b. Traditional solid plantings of both crops on ridges (70 cm).

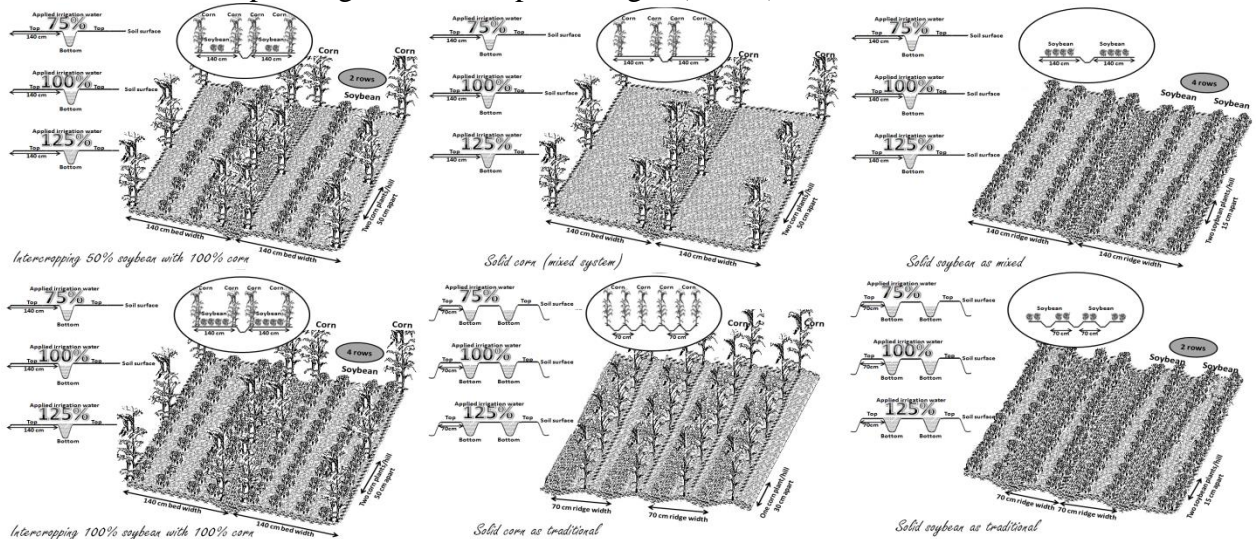


Figure 1. Intercropping soybean with corn and solid cultures of both crops.

### Studied characters:

#### A. Corn characters:

Ten guarded corn plants were taken at random from each sub plot at harvest were taken at random from each sub plot to determine corn grain yield per plant (g).

Corn grain yield per ha (ton) were determined from grain weight of each sub plot and converted to ton per ha.

#### B. Soybean characters:

Ten guarded soybean plants were taken randomly from each sub plot plants at harvest were taken at random from each sub plot to determine soybean seed yield per plant (g).

Soybean seed yield per ha (ton) were determined from seed weight of each sub plot and converted to ton per ha.

C. Land equivalent ratio (LER): Land equivalent ratio (LER): It defines as the ratio of area needed under sole cropping to one of intercropping at the same management level to produce an equivalent yield (Mead and Willey, 1980). It is calculated as follows:  $LER = (Y_{ab} / Y_{aa}) + (Y_{ba} / Y_{bb})$ ; where  $Y_{aa}$  = Pure stand yield of crop a (corn),  $Y_{bb}$  = Pure stand yield of crop b (soybean),  $Y_{ab}$  = Intercrop yield of crop a (corn) and  $Y_{ba}$  = Intercrop yield of crop b (soybean).

D. Water relations: Irrigation water use efficiency (IWUE) values were calculated according to Bhattarai et al. (2006) as follow:  $IWUE = (Ey / Ir)$ . Where IWUE is irrigation water use efficiency (kg/m<sup>3</sup>), Ey is the economical yield (kg/ha) and Ir is the amount of applied irrigation water (m<sup>3</sup>).

Mean comparisons were done using least significant differences (L.S.D) method at 5 per cent level of probability to compare differences between the means (Gomez and Gomez, 1984).

## Results and Discussion

Soybean seed yield:

Effect of applied irrigation water: Seed yields per plant and per ha were not affected significantly by levels of applied irrigation water (Table 1). These results could be attributed to canopy structure of soybean variety Giza 111 acclimated with the lowest applied irrigation water. In other words, shortage in applied irrigation water by 25% of recommended applied irrigation water did not reduce accumulation of dry matter in different organs of the plant during the early vegetative and development growth stages and consequently yield of the crop. These results are in accordance with those obtained by Aiken; Lamm (2012) who reported that the crop canopy shades soil and reduces evaporative water losses. Also, soybean have tap roots and tolerant to drought than corn. Increasing applied irrigation water to 25% over that of recommended applied irrigation water did not increase soybean yield. The highest applied irrigation water may have cooler canopy temperatures and retain moisture longer which increased the probability of foliage disease problems compared to others. Excessive irrigation water during the vegetative stage stimulates vegetative growth and dry matter and increase potentiality for lodging and may be increasing fungal diseases without an increase in yield (Kranz; Benham, 2003).

Effect of cropping systems: Seed yield per plant and per ha were affected significantly by cropping systems (Table 1). These differences depending on number of soybean plants per plot and shading effects by adjacent corn plants of intercropping systems. Traditional soybean solid culture had the highest values ( $P \leq 0.05$ ) for seed yields per plant and per ha as compared to those of intercropping systems. In general, intercropping soybean with corn decreased ( $P \leq 0.05$ ) seed yields per plant and per ha by about 47.94% and 55.76%, respectively, as compared with those of traditional solid system (Table 1). These results could be due to the adverse shading effects of adjacent corn plants which increase inter and intra-specific competition between plants as compared with those of traditional solid cultures, especially, during reproductive and seed filling stages (Metwally *et al.*, 2012; Nagasuga *et al.*, 2014).

Also, soybean plants of intercropping system which have low density (Inter1-50% soy) achieved higher seed yield per plant than that of intercropping system (Inter2-100% soy); but the converse was true with soybean yield per ha. These results are in the same context of those obtained by Metwally *et al.* (2012); Abdel-Wahab; Abd El-Rahman (2016) who showed

that soybean in solid planting had the highest seed yields per plant and per ha compared to those of intercropping.

The interaction between applied irrigation water levels and cropping systems did not affect significantly seed yields per plant and per ha (Table 1).

#### Corn grain yield

1. The highest applied irrigation water caused significant increments ( $P \leq 0.05$ ) in grain yields per plant and per ha as compared to those of the other treatments (Table 1). The highest applied irrigation water increased grain yields per plant and per ha by 11.82% and 14.26 %, respectively, as compared to those of the lowest applied irrigation water. This may be due to the excess irrigation water treatment (125%) enhanced efficiency of photosynthetic process of the plant especially corn which has high water requirements (Igbadun *et al.*, 2008) and thereby more dry matter accumulation in the different organs of the plant.

2. Grain yields per plant and per ha were not affected significantly by cropping systems in the combined data (Table 1). These results could be attributed to corn which have high ability for acclimation more light intensity of intercropping systems (Metwally *et al.*, 2012). These data suggest that corn plant had the same ability for convert more solar energy to chemical energy and more translocation of photosynthates metabolites to the ears under the studied cropping systems. These results are in agreement with those obtained by (Metwally, 1999; Undie *et al.* 2012) who indicated that intercropping soybean with corn had no significant reduction in grain yield of corn.

3. Applied irrigation water x cropping systems affected significantly grain yields per plant in the combined data (Table 1). Intercropping soybean with corn under application high level of water (125%) produced higher grain yield of corn per plant as compared with solid corn plantings. This may be attributed to wide spacing between corn plants in beds than those on traditional solid planting on ridges (70 cm). It is obvious that efficiency of photosynthetic process of the intercropped corn plant was enhanced with increasing applied irrigation water up to 125% of the recommended applied irrigation water. These results may be attributed to increase LA of the intercropped corn plant which increased surface absorbing sunlight and decreased evaporation rate from soil surface compared with the others (Andrade *et al.*, 2002; Metwally *et al.*, 2012). Increasing irrigation water level from 6069 to 10115 m<sup>3</sup>/ha had significant increments on grain yield per plant under intercropping systems more than that of traditional solid planting. Also, there were positive effects between corn plant and adjacent soybean plants due to beneficial effects of soybean residues under intercropping culture (Metwally *et al.*, 2008; El-Shamy *et al.*, 2015). Accordingly, intercropping soybean with corn increased light intensity and CO<sub>2</sub> concentrations around corn canopy and thereby this biological situation reflected on the developing ears.

Land equivalent ratio (LER) Effect of applied irrigation water:

1. LER was not affected by levels of applied irrigation water (Figure 2). These data show that yielding ability of the intercropping was not ( $P > 0.05$ ) likely to be much affected by applied irrigation water (Table 1) that contributed mainly in stability of the relative yield under intercropping with applied irrigation water.

2. LER was affected significantly by cropping systems in the combined data across the two seasons (Figure 2). Intercropping soybean with corn increased ( $P \leq 0.05$ ) LERs as compared to traditional solid cultures of both crops. The results showed that corn was superior in the intercrop pattern where relative yield increased; meanwhile, soybean was inferior companion crop where the relative yield was decreased in the combined analysis.

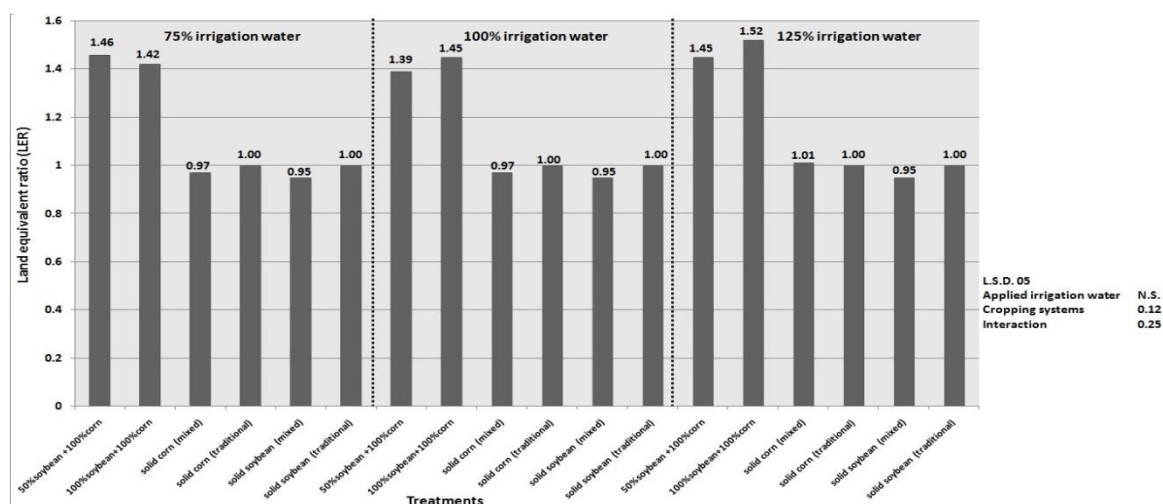


Figure 2. Effect of applied irrigation water, cropping systems and their interaction on LER, combined data across 2015 and 2016.

The advantage of the highest LER by intercropping soybean with corn over solid cultures of both crops could be due to their effects on intra-specific competition between plants of the same species for basic growth resources than those of traditional solid culture. These results are in accordance with those obtained by (Metwally *et al.* 2009) who found that intercropping patterns increased LERs as compared to solid cultures of both crops.

3. Applied irrigation water x cropping systems affected significantly LER (Figure 2). Intercropping soybean with corn (50% soybean + 100% corn) or (100% soybean + 100% corn) produced higher LER with regardless to applied irrigation water as compared with other treatments.

Water use efficiency (WUE):

1. WUE of economic yield was affected significantly by applied irrigation water, meanwhile WUE of biological yield was not affected (Figure 3). The lowest applied irrigation water caused significant increments ( $P \leq 0.05$ ) in WUE of economic yield as compared to those of the other treatments. However, there were no significant differences between 100% and 125% of applied irrigation water treatments. The highest applied irrigation water decreased WUE of economic yield by about 50% as compared to the lowest applied irrigation water.

2. Intercropping soybean with corn increased WUE of economic yield by 16.94% as compared to traditional solid plantings of corn (Figure 3). Also, intercropping soybean with corn increased WUE of biological yield by 9.33% as compared to traditional solid plantings of corn. With respect to intercropping patterns, increasing soybean plant density from 50% to 100% did not affect negatively WUE of economic yield (Figure 3). These results indicate that corn plants may grow larger and they may use more water and high CO<sub>2</sub> concentration as a result of intercropping with the C<sub>3</sub> plants. Despite WUE of C<sub>4</sub> crops often being higher than that of C<sub>3</sub> crops (Gowik; Westhoff, 2011), water availability still dictates the maximum yields achievable by the C<sub>4</sub> crop (Ings *et al.*, 2013).

3. WUE of biological yield was affected significantly by the interaction between applied irrigation water and cropping systems, meanwhile WUE of economic yield was not affected (Figure 3). Intercropping soybean with corn with the application of 75% of recommended applied irrigation water achieved the highest WUE of biological yield than other solid plantings.

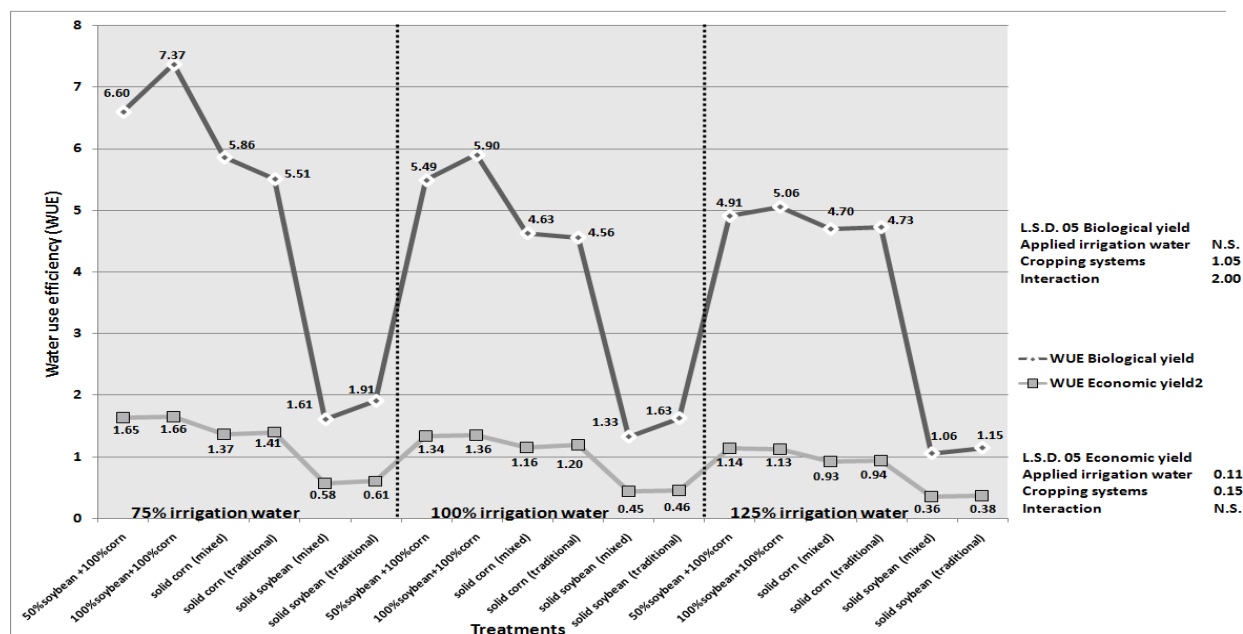


Figure 3. Effect of applied irrigation water, cropping systems and their interaction on water use efficiency (WUE), combined data across 2015 and 2016.

Table 1. Effect of applied irrigation water, cropping systems and their interactions on yield per plant and per ha for corn and soybean, (combined data across 2015 and 2016).

Cropping systems	Applied irrigation water(m <sup>3</sup> /ha)	Soybean seed		Corn grain	
		yield/plant (g)	yield/ha (ton)	yield/plant (g)	yield/ha (ton)
Intercropping systems	75% (6069)	7.6	1.14	205	6.83
50% soybean + 100% corn (Inter 1)	100% (8092)	9.1	1.41	215	7.36
	125% (10115)	10.4	1.36	241	7.76
Mean		9.0	1.30	220	7.33
100% soybean + 100% corn (Inter 2)	75% (6069)	5.4	1.34	202	6.66
	100% (8092)	6.8	1.64	210	7.16
	125% (10115)	6.3	1.64	230	7.56
Mean		6.2	1.54	214	7.13
Average of intercropping	75% (6069)	6.5	1.24	204	6.76
	100% (8092)	8.0	1.53	213	7.26
	125% (10115)	8.4	1.50	236	7.66
Mean		7.6	1.42	217	7.22
Solid systems (as mixed)	75% (6069)	14.4	2.99	195	6.66
	100% (8092)	15.4	3.07	208	7.49
	125% (10115)	15.1	3.07	216	7.66
Mean		15.0	3.04	206	7.26
Traditional solid systems	75% (6069)	15.1	3.16	209	6.79
	100% (8092)	14.4	3.23	220	7.59
	125% (10115)	14.4	3.23	221	7.73
Mean		14.6	3.21	217	7.36
Average of applied irrigation water	75% (6069)	10.6	2.16	203	6.73
	100% (8092)	11.4	2.34	213	7.39
	125% (10115)	11.6	2.33	227	7.69
L.S.D.0.05 Applied irrigation water		N.S.	N.S.	10.1	0.76
L.S.D.0.05 Cropping systems		2.5	0.16	N.S.	N.S.
L.S.D.0.05 Interaction		N.S.	N.S.	12.0	0.69

Note: \* Average of solid corn and soybean



## **Conclusion**

Productivity, land equivalent ratio (LER) and water use efficiency (WUE) were increased more under intercropping systems than those of solid ones. Also, the production of economic and biological yields, as well as, LER were increased more by increasing irrigation level of water from 75 to 125%, while the converse was true with WUE. It be concluded that applied irrigation water of 6069 and 8092 m<sup>3</sup>/ha were suitable for economic yield under solid and intercropping cultures in beds 140 cm, respectively.

## **References**

- Abdel-Wahab T.I., Abd El-Rahman R.A. (2016). Response of some soybean cultivars to low light intensity under different intercropping patterns with maize. *Int. J. Appl. Agric. Sci.*, 2 (2): 21 – 31.
- Aiken R., Lamm F. (2012). Irrigation guidelines for oilseed crops in the U.S. Central Great Plains. Kansas State Northwest Research – Extension Center, Kansas, pp. 14 – 24.
- Alizadeh A. (2001). Drought and necessity of increase in water productivity. *Quarterly Science-Extension of Aridity and Agricultural Drought*, 2: 3-8.
- Andrade F.H., Echarte L., Rizzalli R., Della Maggiora A., Casanovas M. (2002). Kernel number predication in maize under nitrogen or water stress. *Crop Sci.*, 42: 1173 – 1179.
- Camara G.M.S., Sediyaama T.; Dourado N.D., Bernardes M.S. (1997). Influence of photoperiod and air temperature on the growth, flowering and maturation of soybean (*Glycine max (L.) Merrill*). *Scientia Agricola*, 54 (special): 149 – 154.
- El-Shamy Moshira A., Abdel-Wahab T.I., Abdel-Wahab Sh.I., Ragheb S.B. (2015). Advantages of intercropping soybean with maize under two maize plant distributions and three mineral nitrogen fertilizer rates. *Adv. Biosci. and Bioeng.*, 3 (4):30 – 48.
- Gowik U., Westhoff P. (2011). The path from C3 to C4 photosynthesis. *Plant Physiol.*, 155: 56–63.
- Igbadun H.E., Salim B.A., Tarimo A.K.P.R., Mahoo H.F. (2008). Effects of deficit irrigation scheduling on yields and soil water balance of irrigated maize. *Irrigation Sci.*, 27 (1): 11–23.
- Ings Jennifer, Mur L.A.J., Robson P.R.H., Bosch M. (2013). Physiological and growth responses to water deficit in the bioenergy crop *Miscanthus x giganteus*. *Frontiers in Plant Sci.*, 4, Article 468: 1 – 12.
- Kranz B., Benham B. (2003). Does irrigation improve soybean yields?. *Nebraska Univ., Nebraska*, pp. 8 – 17.
- Medranoa H., Tomás M., Martorella S., Flexasa J., Hernández E., Rosselló J., Poub A., Escalona J., Botaa J. (2015). From leaf to whole-plant water use efficiency (WUE) in complex canopies: Limitations of leaf WUE as a selection target. *The Crop J.*, 3(3): 220–228.
- Metwally A.A. (1999). Intensive cropping system in the battle against food crises. In: *Proc. 1st Conf. in Recent technologies*, Fac. Agric., Cairo Univ., 27- 29 November, 11: 333 – 341, Egypt.
- Metwally A.A., Shafik M.M., Fayez M., Safina S.A. (2008). Performance of inoculated some soybean varieties under intercropping and solid plantings. *The 1st Int. Conf., on Environmental Studies and Research "Natural resources & Sustainable Development"*, 7 – 9 April, Minufiya Univ., P. 81.
- Metwally A.A., Shafik M.M., El-Habbak K.E., Abdel-Wahab Sh.I. (2009). Step forward for increasing intercropped soybean yield with maize. *The 4th Conf., Recent Technologies in Agric.*, 3 – 5 Nov. Cairo Univ.,2: 256 – 269.

- Metwally A.A., Shafik M.M., El-Habbak K.E., Abdel-Wahab Sh.I. (2012). Yield and soybean characters under some intercropping patterns with corn. *Soybean Res.*, 10: 24 – 42.
- Nagasuga K., Kadowaki M., Uchida Sh., Kaji H., Fukunaga A., Umezaki T. (2014). Effects of water condition on soybean (*Glycine max L.*) plant growth after flowering. *Environ. Control Biol.*, 52 (4): 221 – 225.
- Ouda S.A., Mesiry T.El., Abdallah E.F., Gaballah M.S. (2007). Effect of water stress on the yield of soybean and maize grown under different intercropping patterns. *Aust. J. Basic and Appl. Sci.*, 1(4): 578–85.
- Todorović M. (2006). An Excelbased tool for real time irrigation management at field scale. *Proceedings of International Symposium on “Water and Land Management for Sustainable Irrigated Agriculture”*, Adana, Turkey. 4–8 April 2006. Çukurova Univ., Adana, Turkey.
- Undie U.L., Uwah D.F., Attoe E.E. (2012). Growth and development of late season maize/soybean intercropping in response to nitrogen and crop arrangement in the forest agro-ecology of South Southern Nigeria. *Int. J. Agric. Res.*, 7(1): 1
- UNESCO. (2006). *Water, a shared responsibility*, Rep. 2, World Water Assess. Programme, Berghann, New York.
- Wright G.C., Smith C.J., Nelson I.B. (1988). Growth and yield of soybean under wet soil culture and conventional furrow irrigation in South-Eastern Australia. *Irrigation Sci.*, 9: 127 – 192.
- Zadeh M., Mousavi S.F. (1996). *Surface irrigation (theory and practice)*. Publications dictionary Tehran.

## THE SUM OF TEMPERATURE UNITS IN DIFFERENT PHENO-PHASES OF DEVELOPMENT OF SEED MAIZE REGARDING THE PRODUCTION YEAR

Marijenka TABAKOVIĆ<sup>1\*</sup>, Jasna VUJINOVIĆ<sup>1</sup>, Rade STANISAVLJEVIĆ<sup>2</sup>, Ratibor ŠTRBANOVIC<sup>2</sup>, Vera POPOVIĆ<sup>3</sup>

<sup>1</sup>Maize Research Institute, Zemun Polje, Slobodana Bajića 1, 11185 Belgrade-Zemun, Serbia

<sup>2</sup>Institute for Plant Protection and Environment, Teodora Drajzera 9, 11040 Belgrade, Serbia

<sup>3</sup>Institute of Field and Vegetable Crops, Maksima Gorkog 30, 21000 Novi Sad, Serbia

\*Corresponding author: mtabakovic@mrizp.rs

### Abstract

The aim of this study was to determine variability of temperature sums for the occurrence of pheno-phases of silking, tasselling and pollination of seed maize. Nine maize inbred lines were tested in two production years. Compatibility and overlapping of silking, tasselling and pollination of parental components in a seed crop are important for achieving high yields. According to obtained data, the degree of accumulation of temperature sums was higher in the first year than in the second production year for all stages, except for the beginning of tasselling. The differences were statistically significant: the greatest and smallest differences were obtained for tasselling (t2 - 70.9°C) and the beginning of silking (s1- 20.86°C), respectively. The effect of genotypes on differences in temperature sums was the greatest for all pheno-phases,  $p < 0.005$ . The effect of the production year on the number of temperature units necessary for silking and pollination was also high, but there was no high statistical effect on the beginning of tasselling. Since maize is a plant species that is grown in different regions, maize growing practices should be adjusted to the main aim of maize production, to achieving high and stable yields.

**Key words:** *grow degree units (GDU), maize, silking, tasselling, pollination*

### Introduction

According to its morphological, physiological and other traits, maize belongs to the most variable crop. There are several classifications related to maize, and one of them is the classification according to the duration of the growing season. The decision on the introduction of vegetative groups in Europe was made as long ago as 1954 and was based on the FAO regulations with the US hybrids used as checks (Derieux and Bonhome, 1982).

The classification of maize into maturity groups, as well as, the determination of the duration of the growing season are done based on temperature sums as the most reliable method. The establishing of pheno-phases according to temperature sums has initially applied to peas (Katz, 1952), and afterwards to maize with the application of various methods for calculation of heat sums (Marton *et al.*, 2007). The temperature, humidity and mineral nutrition affect the length of the growing season. The information about temperature sums of developmental pheno-phases provides the appropriate planning of the production for achieving high yields. In order to get high yields in seed production it is necessary to achieve full pollination and kernel filling. The kernel number per plant and their size, i.e. their weight, determines the grain yield. The kernel number per plant is a trait that varies and is more strongly related to the yield than to the kernel size is (Peltonen-Sainio *et al.*, 2007). The kernel size has a significant role in modulating genetic and external control of the kernel number, Egli (2006).

Otegui *et al.* (1995) have established that the kernel number per plant also affected the water deficit in the period of tasselling and silking of maize.

High temperatures affect production and pollen viability. Dry and warm weather postpones the occurrence of silk and increases the number of days between tasselling and silking. According to results gained by Chassot (2000) and Stone *et al.* (1999) temperatures of soil and air are the principal physiological stress factor in the early development of maize plants.

### Material and Methods

Nine maize inbred lines were used in the trail, which was set in the plots of the Maize Research Institute, Zemun Polje in the two production years (2013 and 2015). The plot size amounted to 0.09 ha. Each inbred was sown in three 50-m long rows with the inter-row distance of 70 cm. Standard growing practices for cultivating seed maize were applied during the growing season (the Regulation on control of the seed production, the content and the method of keeping records on production of seedlings of agricultural crops and the form on the report on the production of mycelia of edible and medicinal fungi, Official Gazette of RS 60/2006). Temperature sums were estimated based on meteorological data of the Maize Research Institute, Zemun Polje according to the GDU (Growing Degree Unit) method: mean daily temperature minus minimum maize growth rate ( $10^{\circ}\text{C}$ ), extreme values below  $10^{\circ}\text{C}$  and above  $30^{\circ}\text{C}$  (maximum maize growth rate), were calculated as  $10^{\circ}\text{C}$  and  $30^{\circ}\text{C}$  (Shaw, 1975; McMaster and Wilhelm, 1997).

$$\text{GDU} = (\text{T}_{\max} + \text{T}_{\min} / 2) - \text{T}_{\text{base}}$$

Where  $\text{T}_{\max}$  is the daily maximum air temperature,  $\text{T}_{\min}$  is the daily minimum air temperature and  $\text{T}_{\text{base}}$  is the minimum maize growth rate.

Based on visual observation, the dates of the beginning and ending of silking, tasselling and pollination were estimated. The first date was estimated when 5% of plants occurred in all three pheno-phases: beginning of silking (s1), beginning of tasselling (t1), and beginning of pollination (p1). The second date was when silk, tassels and anthers occurred on 100% of plants: end of pheno-phases of silking (s2), tasselling (t2) and pollination (p2).

Results were processed by the statistical program *IMB SPSS 2010*. The descriptive statistics was done for each parameter at the annual level; two factorial analysis of variance was performed to determine differences, while their significance was estimated by the t-test (Hadživuković, 1991).

Meteorological data in the trial period were equal regarding temperature sums and water regime. The average air temperatures during pollination (mid June - end of July) were approximately the same in both years of investigation (Table 1). Comparing with the official standard temperature period (1961-1990), we have an increase in temperature in both years of research, which is in line with climatic changes that move towards global warming.

Precipitation sums in 2015 were higher by  $60.9 \text{ L m}^{-2}$  than in 2013. During pollination (June-July) precipitation sums were almost equal (31 L in June, while there were a bit more precipitation in July of 2013 -  $16 \text{ L m}^{-2}$ ) (Table 1). As with temperature, changes in schedule and amount of precipitation were also determined. In the period of research, the amount of precipitation is less than the standard period (1961-1990). The visible decrease was in the period June-July, ie at the time of the observed pheno-phases.

Table 1. Monthly values of precipitation and mean air temperature (weather station Zemun Polje)

Year	Monthly mean air temperature (°C)							Average
	April	May	June	July	Aug.	Sept.	Oct	
2013	14.9	19.7	21.9	23.8	23.7	16.9	15.3	22.7
2015	12.9	19.1	22.1	26.4	25.7	20.2	12.4	23.1
61-90	12,3	17,1	20,0	21,7	21,3	17,6	12,4	20.4
Monthly sum of growing degree units (GDU)								Sum
2013	147.0	300.7	357.0	427.8	424.7	207.0	164.3	2028.5
2015	87.0	282.1	363.0	508.4	486.7	306.0	74.4	2107.6
Monthly sum of precipitation (mm)								Sum
2013	14.9	93.9	37.8	16.0	12.7	70.1	21.9	367.3
2015	19.7	97.8	31.1	7.2	56.0	73.6	65.1	350.5
61-90	57.6	69.3	89.3	70.0	54.3	51.3	41.0	433.0

\*61-90 (1961-1990)-official standard period,  $GDU = (T_{max} + T_{min}/2) - T_b$  (extreme values below 10°C and above 30°C, were calculated as 10°C and 30°C)

### Results and Discussion

Mean values of temperature sums were established over production years with the aim to observe variability of these sums. The lowest temperature sum was obtained in the first year (2013) at the time of tasselling, while the highest sum was detected also in the first year (2013) in the pheno-phase of pollination (p2) (Figure 1). In 2013, the temperature sums were higher for all pheno-phases. The exception was the beginning of tasselling in 2013, when values were a little bit lower than in 2015 (t1 in 2013 with GDU-621.23°C, t2 in 2015 with GDU-627.73°C). According to Çakir (2004), tasselling and ear formation were especially affected by soil water deficiency. A lower precipitation sum postponed tasselling in 2015. Tasselling (t1) expressed the greatest variability in performed trials, with the coefficient of variation of 7.04%. The smallest differences in means of coefficients of variation of temperature sums were detected in the pheno-phase of silking (s2 - CV 4.85%).

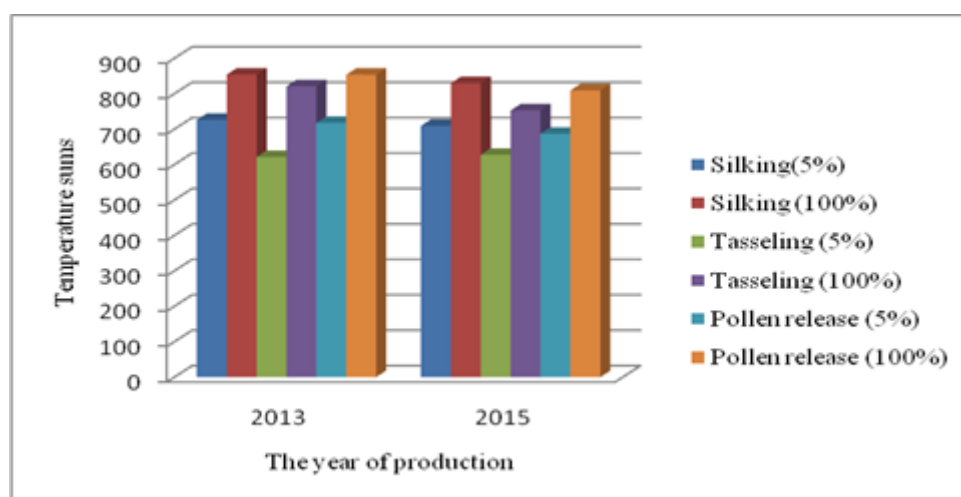


Figure 1. Temperature sums of phenol-phases over production years

According to the t-test, the differences in the time of the beginning of silking, tasselling and pollination over the two production years were significant (Table 2). The effect of the production year on the duration of the periods of silking (s2), tasselling (t2) and pollination

p(2) was significant. The beginning of the stated pheno-phase differed in the two production years, but with no statistical significance. The amount and distribution of precipitation during flowering and kernel filling have a significant role in the expressing of plant potential (Bello et al., 2014).

Table 2. The t-test for the significance of differences in temperature sums over production years

	t-test for Equality of Means						
	t	df	Sig.	Mean Difference	Std. Error Difference	95% Confidence Interval of the Difference	
						Lower	Upper
s1	1.67	16.16	0.11	20.86	12.50	-5.62	47.34
s2	3.26*	27.00	0.00	35.95	11.02	13.34	58.56
m1	-0.31	27.00	0.76	-5.19	16.84	-39.74	29.35
m2	5.58*	27.00	0.00	65.78	11.78	41.61	89.95
p1	1.68	20.37	0.11	25.29	15.08	-6.12	56.70
p2	2.58*	27.00	0.02	48.48	18.79	9.94	87.03

The pollination period in maize inbreds is a very specific trait and is attributed to genotypic structure,  $p < 0.05$  (Table 3). Whether any particular pheno-phase will vary more or less also depends on environmental conditions. According to presented results, the production year was significant for all pheno-phases except for the beginning of tasselling. The beginning and the duration of the tasselling period were not statistically significant even in the genotype  $\times$  production year interaction ( $p > 0.05$ ). On the other hand, silking and pollination depended on the interaction of both factors.

According to Kang (1998, 2004), the genotype by environment interaction implies the response of genotypes to conditions of the environment they are cultivated in. Since conditions under which the trials were carried out were similar, the effects of these two factors did not have any significant results for all studied traits.

Table 3. Two factorial analysis of variance

Source of variation	F					
	s1	s2	t1	t2	p1	p2
Genotype	35,03*	17,85*	4,06*	4,19*	3,51*	17,61*
Year	24,04*	35,82*	0,22	65,45*	5,99*	36,91*
Genotype $\times$ Year	19,82*	8,86*	0,88	2,01	1,2*	8,12*

### Conclusions

The temperature sums for seed maize inbreds during the two production years similar in temperature and humidity conditions, pointed out variations in all of three observed pheno-phases. The influence of factors on occurrence pheno- phasis was different which is also confirmed by coefficients of variation - the lowest (4.85%) and highest (7.04%) for silking and tasselling, respectively. Despite similar weather conditions over both production years, the year significantly affected only the beginning of tasselling (t1)  $p > 0.05$ . It is necessary to know about the degree of variability in occurrences in stages during pollination, and conditions under which the production is planned, so the probability of incongruity between tasselling and pollination will be lower.

Since maize is a crop grown in various regions, the maize growing practices should be adjusted to conditions under which the seed production will be performed.

### References

- Bello, B.O., Olawuyi, J.O, Ige A.S., Mahamood, J., Afolabi, S.M., Azeez, A.M., Abdulmalik, Y.S. (2014). Agro-nutritional variations of quality protein maize (*Zea Mays L.*) in Nigeria. *Journal of Agricultural Sciences*, 59(2), 101-116.
- Çakir, R. (2004). Effect of water stress at different development stages on vegetative and reproductive growth of corn. *Field Crops Research*, 89, 1-16.
- Chassot, A. (2000). Early growth of roots and shoots of maize as affected by tillage-induced changes in soil physical properties. Diss. ETH No. 13907, ETH Lybrari, Zurich.
- Derieux, M., Bonhomme, R., (1982). Heat unit requirements for maize hybrids in Europe. Results of the European FAO sub-network I, Sowing-silking period, *Maydica*, 27, 59–77.
- Egli, D.B. (2006). The role of seed in the determination of yield of grain crops. *Australian Journal of Agricultural Research*, 57, 1237–1247.
- Hadživuković, S. (1991). Statistički metodi s primenom u poljoprivrednim i biološkim istraživanjima. Drugo izdanje. Poljoprivredni fakultet, Novi Sad.( Statistical methods applied in agricultural and biological research. Second edition, Faculty of Agriculture, Novi Sad).
- IBM SPSS Statistics Version 19, SPSS, Inc, an IBM Company, Copiringht 1989, 2010 SPSS.
- Kang, M S (1998). Using genotype-by-environment interaction for crop cultivar development. *Advances in Agronomy*, 62, 199-252.
- Kang M S (2004): Genotype-by-environment interaction. *Encyclopedia of Plant and Crop Science*, Marcel Dekker, Inc., 218-221
- Katz, Y. H. (1952). The relationship between heat unit accumulation and the planting and harvesting of canning peas. *Agronomy Journal*, 44, 74–78.
- Marton, L. C., Kálmán, L., Árendás, T., Bónis, P., Szieberth, D. (2007). Comparison of some methods for estimating vegetation periods in maize. *Acta Agronomica Hungarica*, 55, 1–5.
- McMaster, G. S., Wilhelm ., W.W. (1997). Growing degree-days: one equation, two interpretations. *Agricultural and Forest Meteorology*, 87, 291-300.
- Ministarstvo poljoprivrede, šumarstva i vodoprivrede Republike Srbije (2006). Pravilnik o kontroli proizvodnje semena poljoprivrednog bilja. Sl. Glasnik RS, Beograd, br.60/2006. (Ministry of Agriculture, Forestry and Water Management of the Republic of Serbia (2006). Regulation on control of the seed production of the agricultural crops, Official Gazette of the Republic of Serbia, Issue 60/2006, Beograd).
- Otegui, M.E., Andrade, F.H., Suero E.E (1995). Growth, water use, and kernel abortion of maize subjected to drought at silking. *Field Crops Research*, 40, 87-94a.
- Peltonen-Sainio, P., Kangas, A., Salo, Y. and Jauhiainen L. (2007). Grain number dominates grain weight in temperate cereal yield determination. Evidence based on 30 years of multilocation trials, *Field Crops Research*, 100, 179–188.
- Shaw, R. H. (1975). Growing-degree units for corn in the north central region. *Iowa Agriculture and Home Economics Experiment Station*, 36 (581) , 795-805.
- Stone, P.J., Sorensen, I.B., Jamieson, P.D. (1999). Effect of soil temperature on phenology, canopy development, biomass and yield of maize in a cool temperature climate. *Field Crops Research*, 63, 169–178.

## INFLUENCES OF FOLIAR FERTILIZERS AND GENOTYPE ON POLYPHENOL AND ANTIOXIDANT STATUS OF YELLOW SOYBEAN SEEDS

Sanja ĐUROVIĆ<sup>1\*</sup>, Bogdan NIKOLIĆ<sup>1</sup>, Vesna DRAGIČEVIĆ<sup>2</sup>, Hadi WAISI<sup>3</sup>, Zorica KNEŽEVIĆ-JUGOVIĆ<sup>4</sup>

<sup>1</sup>Institute for Plant Protection and Environment, Belgrade, Serbia

<sup>2</sup>Maize Research Institute Zemun Polje, Zemun-Belgrade, Serbia

<sup>3</sup>Institute for the Development of Water Resources "Jaroslav Černi", Belgrade, Serbia

<sup>4</sup>Faculty of Technology and Metallurgy, University of Belgrade, Belgrade, Serbia

\*Corresponding author: stojakovicsm@yahoo.com

### Abstract

Polyphenols, compounds included in the composition of plants, are products of secondary metabolism and a significant component of the cell wall structure of plants. These bioactive compounds are synthesized by plants as self-defense under conditions of oxidative stress, and studies have shown that they can be attributed to a very strong antioxidant effect. Regular use of food rich in polyphenols in human nutrition improves the general condition of the body and reduces the risk of chronic diseases such as cancer, Alzheimer's disease, heart disease. Numerous studies have been carried out on soybean seeds different color layer, as a very important plant species that is used for human consumption and as animal feed. Antioxidant capacity of soybean can be improved by treating the plant material with nonstandard fertilizers based on plant extracts and trace elements. In this study, three varieties of yellow soy Nena, ZP015 and Laura were treated with nonstandard fertilizers during two growing seasons. Total phenols, after the extraction of the plant material (milled grain) were determined by the Folin Ciocalteu method, and results were expressed as mg GAE/g d.m. (milligram equivalent of Gallic acid per gram of dry matter). Depending on the genotype and treatment values vary from 9.62 to 15.74 mg GAE/g d.m. The antioxidant activity was determined by DPPH method and the results were expressed as  $\mu\text{mol TROLOX eq/g}$  of dry matter. Values vary from 192.58 to 245  $\mu\text{mol TROLOX eq/g d.m.}$  The total reducing capacity was determined by the FRAP assay, the results were expressed as  $\mu\text{mol FeSO}_4 \times 7 \text{ H}_2\text{O eq/g d.m.}$  Values vary from 83.62 to 208.61  $\mu\text{mol FeSO}_4 \times 7 \text{ H}_2\text{O eq/g d.m.}$

**Key words:** *polyphenols, soybean seeds, antioxidant capacity, foliar fertilizers.*

### Introduction

Soybean (*Glycine max* (L) Merrill) has been known and used in the East-Asian countries for centuries, but in the last few decades it has become one of the five most widespread cultures in the world. The significance of soybean originates from extremely favorable chemical composition of the grain. The grains have protein content from 36 to 42% and oil from 15 to 23%, which makes soybean not only extremely useful, but also very economical plant species. Soybean proteins are rich in essential amino acids, which are not found in animal proteins. Soybean contains vitamin B complex, beta carotene, and minerals, mostly Ca, Fe and K, and also contains small amounts of vitamins C, D, E and K. These natural antioxidants prevent the oxidation of LDL cholesterol. The soybean seeds contain polyphenols, which are one of the largest, most widespread and biologically (physiologically and medically) most important groups of secondary plant metabolites. Phenols represent an integral part of the structure of cell walls, mainly in the form of polymeric materials (e.g. lignin), making mechanical support



to plant cells and barrier to microorganisms (Wallace and Fry, 1994; Strack, 1997). Polyphenols participate in various biochemical processes related to photosynthesis, protect the plants from bacteria, fungi and viruses, as well as from mechanical damage. They are also important in the removal of oxygen radicals. The function of phenolic flavonoids, especially anthocyanins, flavones and flavonols, is also important as red, blue and purple pigments of fruits, leaves and petals of flowers (Harborne, 1994; Strack, 1997). The soybean seed contains high concentrations of phenolic compounds (Lee et al., 2011), phenolic acids and flavonoids, among them the most isoflavones. Soybean isoflavones can help reduce the risk of osteoporosis, heart disease and some types of cancer (e.g. breast, prostate, colon cancer, etc.) that are related to the level of human hormones (Potter et al., 1998). Soybean is one of the richest sources of the so-called phytoestrogens that interfere with estrogen receptors, induce the effects of true estrogen and reduce the symptoms of menopause (Potter et al., 1998). Soybean polyphenols increase the flexibility of blood vessels, lower triglyceride, reduce blood pressure (Sagara et al., 2004). Soybean is also a good source of protein and dietary fiber. The aim of this paper is to monitor changes in the total phenol content, antioxidant activity and antireducing capacity of soybean seed due to the treatment with nonstandard fertilizers.

### Materials and methods

Experiments were conducted in 2013. and 2014. in field condition, in Zemun Polje (Belgrade). Three genotypes of yellow soybean Nena, Laura and ZP015 were used. In the first year of the experiment (2013), the soybean genotypes Nena and ZP015, were treated with two foliar fertilizers (Speedy-17% Mo and 1.7% Co, pH = 7.1; Wuxal Extra CoMo-16.5% Mo and 1.65% Co, pH = 5.5), and in the second year (2014) the soybean genotype Laura was treated with five foliar fertilizers: 1) Vegard- extract of some Chinese medicinal plants (1-2% C<sub>org</sub>, 2-5% N<sub>org</sub>, 5% humic acids, 10% fulvic acid, 1% K<sub>2</sub>O, 1-2% amino acids); 2) Eco-Fus- algae fucus extract (*Fucus vesiculosus*), (1.8% N<sub>tot</sub>; 1% P<sub>2</sub>O<sub>5</sub> (water-soluble); 2% K<sub>2</sub>O (water-soluble); 0.5% MgO; 1.8% Fe); 3) Calbit-C- plant extract (wood chips treated with H<sub>2</sub>SO<sub>4</sub> and CaCO<sub>3</sub>; 15% CaO (water -soluble in Ca-lignosulphonate); 4.5% C<sub>org</sub>); 4) Cropmax- plant extract (sugar cane molasses and extract of other plants: 1.7% N<sub>tot</sub>, 2% total amino acids, 2% C<sub>org</sub>); 5) Zircon-extract of Echinacea (*Echinacea pallida*: 0,1 g/l polyphenolic acid: a) caffeic acid; b) chlorogenic and c) cichoric acid), twice in the season, initially at the beginning and during the flowering stage, in according to producers recommendation doses. After the harvest and yield assessments, soybean seeds from every genotype (100 g per treatment) were collected and stored in the freezer until analysis.

All samples were grounded and defatted in petrol ether before extraction. From each sample (0,5 g per sample) polyphenols were extracted with mixture of methanol and 10% HCl in a ratio of 85:15 v/v, for 30 minutes in ultrasound bath. Samples were centrifuged (15 min on 10 000 rpm). Compounds in supernatant are present in the soluble form ("free polyphenols"). Precipitate was subjected to alkaline hydrolysis (with 4M NaOH, 4h at 25°C), to separate polyphenols bound by ester bonds ("esterified polyphenols"). Separation of esterified polyphenols was carried out with the diethyl ether-ethyl acetate mixture (DE / EA = 1: 1). After centrifugation, DE / EA layer with isolated polyphenols is evaporated to dryness, then dissolved with 2 ml MeOH, and the lower aqueous layer is subjected to acid hydrolysis (with 6 M HCl, 30 min at 80°C), which aims to break the bonds and isolate the polyphenolic compounds bound to the cell wall structure ("bond polyphenols"). Separation of bound polyphenols was carried out with the diethyl ether-ethyl acetate mixture (DE / EA = 1: 1). After centrifugation, DE / EA layer with isolated polyphenols is evaporated to dryness, and then dissolved with 2 ml MeOH. From every fraction were analyzed total phenol content and antioxidant activity.

Total phenols content in grounded, defatted soybean seeds was determined by a Folin-Ciocalteu assay (Singleton and Rossi 1965; Singleton and Lamuela-Raventos 1999; Agbor et al., 2014) using gallic acid (GA) as the standard. The content of total phenols was expressed as mg GAE/g of d.m. Antioxidant activity was done by DPPH (2,2-difeny-1-picrylhydrazyl) method of Chen and Ho (1995). The values were expressed as  $\mu\text{mol TROLOX eq/g d.m.}$  The FRAP (Ferric Ion Reducing Antioxidant Power Assay) was done by Benzie and Strain (1996) method. The results were expressed as  $\mu\text{mol Fe}^{2+} \text{ eq/g d.m.}$  Analyses were done in three repetitions and presented results represent their mean value.

### Results and Discussion

The content of total phenols by fractions is shown in Figure 1. The content of the free fraction, depending on the genotype and treatment, is from 2.49 to 3.21 mg GAE / g d.m., which is in agreement with the results (Xu et al., 2007).

In genotype Laura there are small variations in the content of free polyphenols in the samples originating from treated plants compared to control. In contrast, content of the ester fraction of polyphenols in all samples originating from the treated plants is greater than that of control plants, except in the case of samples originating from plants treated with fertilizer Cropmax. In the case of content of bound polyphenol fractions do not have such regularity, except that their value is the highest in samples originating from plants treated with fertilizer Cropmax (Fig 1a).

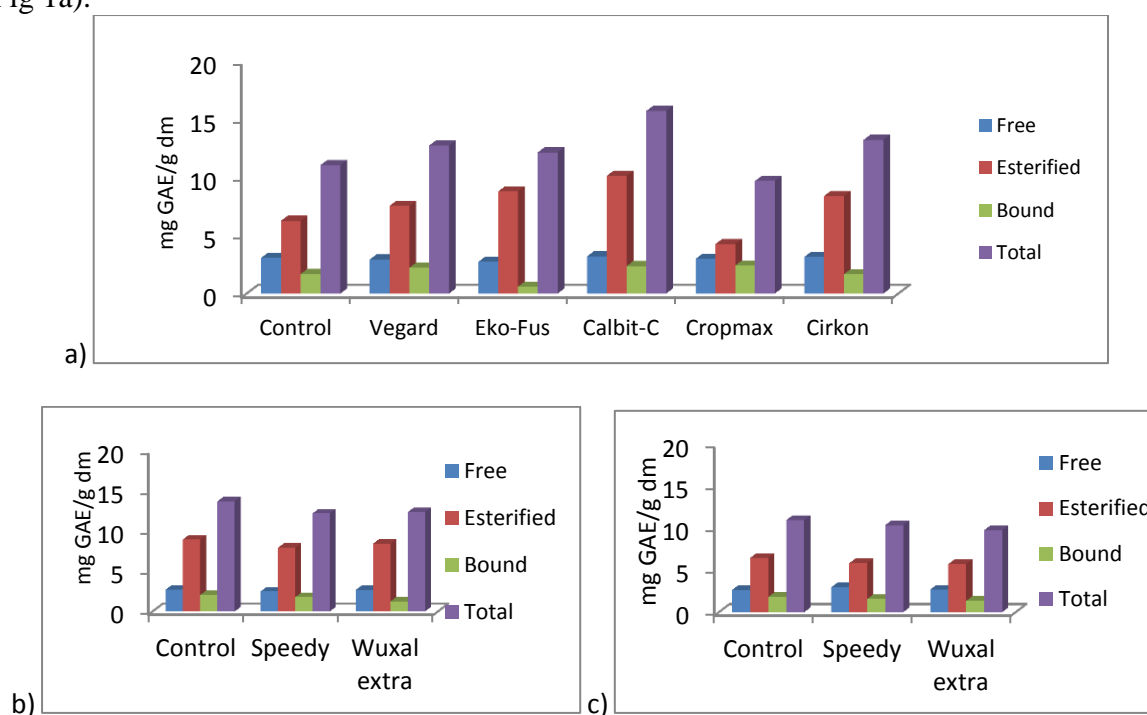


Figure 1: Content of polyphenols (mgGAE/g dm) per fractions: a) Laura, B) Nena, c) ZP 015

In total amount, content of polyphenols in all samples originating from the treated plants is greater than that of control plants, except in the case of samples originating from plants treated with fertilizer Cropmax (Fig 1a). Experiments done with plant extract and algae extract fertilizers (Kocira et al., 2016; Dragičević et al., 2015) show similar results. Depending of the treated culture, the content of polyphenols and other bioactive components can be affected by nonstandard fertilizers, but the crucial influence has genotype, climatic factors, soil type (Tawfeeq et al., 2016).

The content of total polyphenols for varieties Nena and ZP-015 is shown in Fig 1b, 1c. Although there is a certain influence of treatment with these two types of Mo-Co fertilizers, it is noticeable that the redistribution of polyphenol fractions is significantly more affected by the genotype of soybean plants.

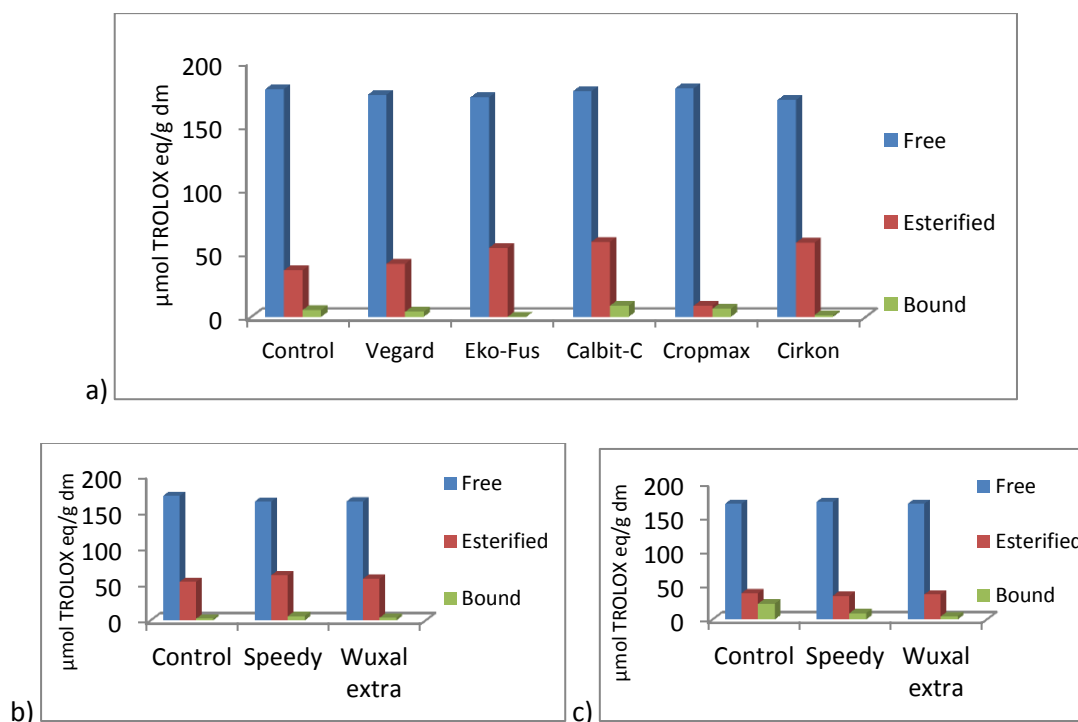


Figure 2: Antioxidant activity by DPPH (µmol TROLOX eq/g d.m.): a) Laura; b) Nena; c) ZP015

The total antioxidant activity of polyphenols via DPPH parameter, is given in Figures 2a,b and c. Results show that free polyphenol fraction most contributes to the antioxidant activity of total polyphenols, i.e. polyphenol fractions related to the vacuole (Nešković et al., 2003) contribute to the highest antioxidant activity of soybean seeds. In the soybean genotype Laura (Fig 2a), there is no regularity in treated samples, except that esterified polyphenol fraction from samples treated with fertilizer Cropmax show significantly less antioxidant activity comparing to control samples, what is consistent with the results for the total polyphenol content (Fig. 1a). In the soybean genotype Nena (Figure 2b), treatment of Mo-Co fertilizers reduces antioxidant activity of free soybean polyphenols relative to these values in control plants, while the treatment with the same fertilizers slightly increases antioxidant activity of free polyphenol fractions in genotype ZP015 (Figure 2c).

The reduction capacity via FRAP parameter, expressed in µmol equ Fe<sup>2+</sup>/g d.m. is given in Figures 3a, b, c. For genotype Laura (Figure 3a) values of FRAP parameter for free polyphenol fraction are smaller in the treated samples compared to control, except in the samples originating from plants treated with fertilizer Cropmax. In contrast, the value of the FRAP parameter of esterified polyphenols of all samples originating from treated plants is similar or greater than those of control plants, except in the case of plants treated with fertilizer Cropmax. In the case of bound polyphenol fractions, there is no such regularity, except that their value is the highest in samples originating from plants treated with fertilizer Cropmax. For varieties Nena and ZP015 (Figure 3b and 3c), obtained results have no such regularity, which means that in this type of experiments with Mo-Co fertilizers on the FRAP

value, the predominant influence has a genetic factor. That is in line with results of World and Opstad (2007) and Abd El-Razek et al., (2011), but opposite from Wang and Lin (2003).

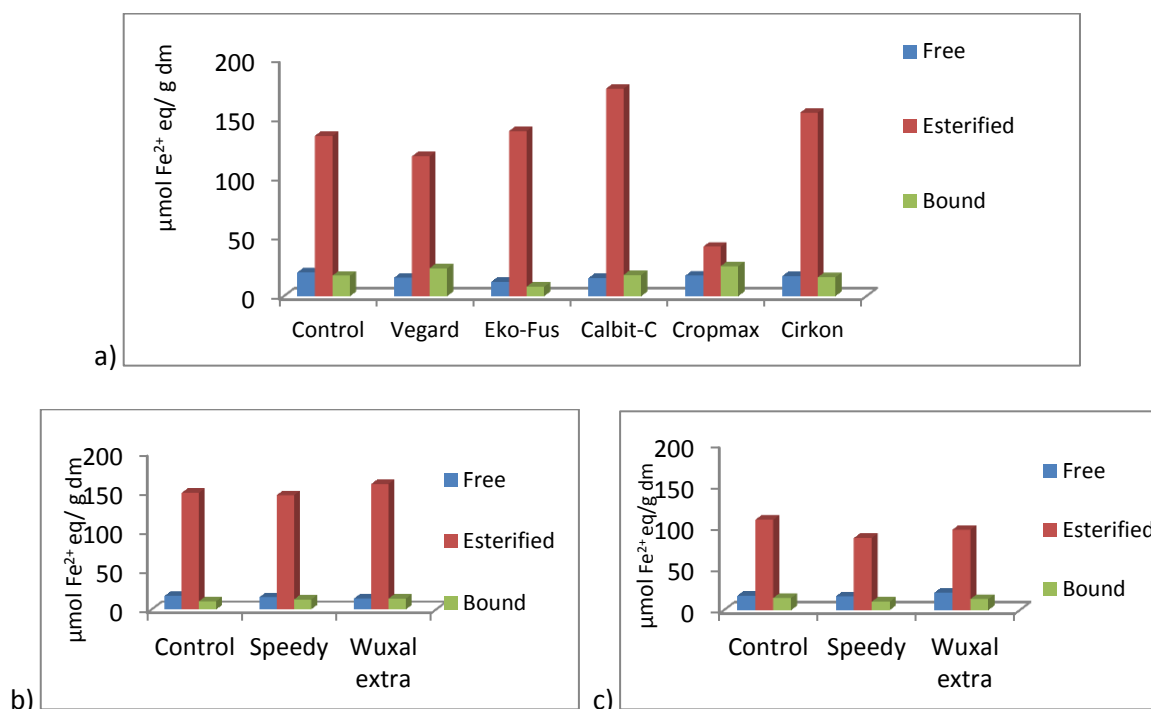


Figure 3. Reducing capacity (µmol Fe<sup>2+</sup> eq/g d.m.) via FRAP parameter: a) Laura; b) Nena; c) ZP015.

### Conclusions

According to the values of total phenols, DPPH and FRAP parameters we can conclude that various types of fertilizers can differently affect the amount, polyphenol distribution and antioxidant activity of soybean seeds. The results in this study show that foliar fertilizers based on plant extracts, have larger influence on polyphenol content and antioxidant activity than fertilizers based on trace elements. According to the values of control samples among different soybean genotypes, we can conclude that the soybean genotype has a greater impact than the treatment of the above mentioned fertilizers.

### Acknowledgment

This work was supported by the Ministry of Education, Science and Technological Development, projects No. TR 31018 and 31037.

### References

- Abd El-Razek, E., Treutter, D., Saleh, M.M.S., El-Shammaa, M., FouadAmera, A., Abdel-Hamid, N., (2011). Effect of nitrogen and potassium fertilization on productivity and fruit quality of ‘crimson seedless’ grape. *Agric. Biol. J. North Am.* 2 (2), 330–340.
- Agbor, AG, Vinson AJ, Donnelly EP. (2014). Folin-Ciocalteu Reagent for Polyphenolic Assay. *Int J Food Sci Nutr Diet.* 3(8), 147-156.
- Benzie, IFF, Strain, JJ. (1996). The ferric reducing ability of plasma (FRAP) as a measure of “antioxidant power”: the FRAP assay. *Analytical Biochemistry* 239, 70–76.

- Brand-Williams, W, Cuvelier, ME, Berset, C. (1995). Use of free radical method to evaluate antioxidant activity. *Lebensmittel Wissenschaft und Technologie* 28, 25–30.
- Chen CW, Ho CT. (1995). Antioxidant properties of polyphenols extracted from green and black teas. *J Food Lipids* 2, 35–46.
- Dragičević, V, Nikolić, B, Waisi, H, Stojiljković, M, Đurović, S, Spasojević, I, Perić, V. (2015). Alterations in mineral nutrients in soybean grain induced by organo-mineral foliar fertilizers, *Chemical and Biological Technologies in Agriculture*, 2:12
- Harborne, JB. (1994). *The Flavonoids: Advances in Research Since 1986*. London, UK: Chapman & Hall.
- Kocira, A, Świeca, M, Kocira, S, Złotek, U, Jakubczyk, A. (2016). Enhancement of yield, nutritional and nutraceutical properties of two common bean cultivars following the application of seaweed extract (*Ecklonia maxima*), *Saudi Journal of Biological Sciences*, (in press)
- Lee, JH, Choung, MG. (2011). Comparison of nutritional components in soybean varieties with different geographical origins. *Journal of the Korean Society for Applied Biological Chemistry*, 54, 254–263.
- Marschner, H. (1995). *Mineral nutrition of higher plants*. 2nd edition, Academic Press, Harcourt Brace & Company Publishers, London, New York, p. 889.
- Nešković, M, Konjević, R, Čulafić, Lj. (2003). *Plant Physiology* (in Serbian). NNK International, Belgrade, Serbia, p. 586.
- Potter, SM, Baum, JA, Teng, HY, Stillman, RJ, Shay, NF, Erdman, JW. (1988). Soy Protein and Isoflavones: Their Effects on Blood Lipids and Bone Density in Post-menopausal Women, *American Journal of Clinical Nutrition*, 68, 1375-1379.
- Sagara, M, Kanda, T, Njelekera, M, Teramoto, T, Armitage, L, Birt, N, Birt, C, Yamori, Y. (2004). Effects of Dietary Intake of Soy Protein and Isoflavones on Cardiovascular Disease Risk Factors in High Risk, Middle-Aged Men in Scotland, *Journal of the American College of Nutrition*, 85-91.
- Singleton VL, Lamuela-Raventos RM. (1999). Analysis of total phenols and other oxidation substrates and antioxidants by means of Folin-Ciocalteu reagent. *Methods Enzymol* 299:152-78.
- Singleton VL, Rossi JA. (1965). Colorimetry of total phenolic with phosphomolybdicphosphotungstic acid reagents. *Am J Enol Viticult* 16:144–58.
- Strack D,(1997). Phenolic metabolism. In: *Plant Biochemistry* (Dey, P. M, Harborne, J. B, eds.). London, UK: Academic Press, 387–416.
- Tawfeeq, A, Culham, A, Davis, F, Reeves, M, (2016). Does fertilizer type and method of application cause significant differences in essential oil yield and composition in rosemary (*Rosmarinus officinalis* L.)? *Industrial Crops and Products*, 88, 17-22.
- Wallace, G, Fry, SC. (1994). Phenolic components of the plant cell wall. *Int Rev Cytol*, 151, 229–267.
- Wang, S.Y., Lin, H.-S., (2003). Compost as a soil supplement increases the level of antioxidant compounds and oxygen radical absorbance capacity in strawberries. *J. Agric. Food Chem.* 51, 6844–6850.
- World, A-B, Opstad, N. (2007). Fruit quality in strawberry (*Fragaria x ananassa* Duch. cv. Korona) at three times during the season and with two fertilizer strategies. *J. Appl. Bot. Food Qual.* 81, 36–40.
- Xu, BJ, Chang, SKC. (2007). A Comparative Study on Phenolic Profiles and Antioxidant Activities of Legumes as Affected by Extraction Solvents, *Journal of Food Science* 72, Nr. 2, 159-166.

## SEED QUALITY OF THE FACELIA-VARIETY NS PRIORA GROWN IN SERBIA

Vera POPOVIĆ<sup>1\*</sup>, Vojislav MIHAILOVIĆ<sup>1</sup>, Sanja VASILJEVIĆ<sup>1</sup>, Biljana KIPROVSKI<sup>1</sup>,  
Vera RAJIČIĆ<sup>2</sup>, Marijenka TABAKOVIĆ<sup>3</sup>, Ljiljana ŠAŠIĆ ZORIĆ<sup>4</sup>, Mladen TATIĆ<sup>1</sup>

<sup>1</sup>Institute of Field and Vegetable Crops, Maksima Gorkog 30, Novi Sad, Serbia

<sup>2</sup>Center of Small Grains, Save Kovačevića 31, Kragujevac, Serbia

<sup>3</sup>Maize Research Institute Zemun Polje, S. Bajića 1, Zemun, Belgrade, Serbia

<sup>4</sup>BioSense Institute, Zorana Đinđića 1, Novi Sad, Serbia

\*Corresponding author: vera.popovic@nsseme.com

### Abstract

Phacelia has been used for seed production and as a forage crops, either on its own or in a mix with peas or vetch to provide forage and honey production as a source of high quality nectar and pollen. The experiment was carried out in 2016, in the fields of the Institute of Field and Vegetable Crops in Bački Petrovac, in Serbia, with variety NS Priora. NS Priora had plant flowering continually over 60 days and had high, good quality grain yield. NS Priora variety had average nitrogen content is 3.21%, protein content was 20.06% and the average thousand seeds weight was 1.42 g. Phacelia is presently very intensively used in organic agriculture and for sowing of arable land temporarily excluded from production which achieves high yields.

**Keywords:** *Phacelia, variety NS Priora, honey plant, seed quality, thousand seeds weight.*

### Introduction

Phacelia is annual plant, native to the south western United States and northern Mexico, where it is used as a cover crop and as bee forage. There are about 200 species in the *Phacelia* genera, some perennial and some annual (Cazzola, 1987). As a commercial species *Phacelia tanacetifolia* Bent. has long been recognised by beekeepers as a preferred foraging plant for honeybees (Teittinen, 1980) with a high potential for honey yield (Orsi and Bionoi, 1987). Phacelia has also been used as a green manure crop in Europe for a number of years (Anon, 1989). When ploughed as a green manure, increases carbon and nitrogen content in soil to a depth of over 80 cm (Beckmann, 1977). The crop is also reported to have nematicidal properties (Cazzola, 1987; Anon., 1989; Booker Seeds, 1990) although it was not clear whether this is by means of a damaged crop or whether the root system was actively nematicidal. Phacelia has also been used as a forage crop, either on its own (Danial and Zobelt, 1986) or in a mix with peas or vetch to provide forage and honey production (Petkov, 1966). Phacelia has been found to have high energy and protein content, but some questions were raised about possible allelo-chemical properties of the plant (Danial and Zobelt, 1986). Excess production of basic agricultural plants determines growers to cultivate alternative crops, which become a next source of income and may enrich soil with organic matter as a green fertilizer or to feed animals in the form of mixtures with fodder plants with simultaneous low work expenditure (Brzezowska and Dreszczyk 2009). Tansy phacelia is one of them. It has not been popular up until recently. However, in the recent years slowly but successively it has gained numerous followers. Due to possibility of using it as an intercrop in the agro-environmental program, farmers obtain additional aid from the Agency for Restructuring and Modernisation of Agriculture. The crop itself is great for non-plough cultivation which on account of economics gives a great advantage over other post-crop plants (Leszczyńska, 2012). Tansy phacelia is presently very intensively used in organic agriculture

and for sowing of arable land temporarily excluded from production (Ramenda, 2003, Popovic et al, 2016, 2017a, 2017b).

Phacelia has been recorded as being a host plant for aphid predators in sugarbeet and wheat. *Syrphidae*, *Carabids*, *Coccinellids* and *Chrysopids* (all aphid predators) were all encouraged by the planting of *P. tanacetifolia* (Senegonca and Frings, 1988). Thus there may be some potential as a biological refuge for predatory insects. Phacelia has a long fibrous root system as well as a main tap root. It is claimed to benefit soil structure and also to have nematicidal properties (Cazzola, 1987; Anon., 1989). MAF Technology Lincoln have included Phacelia in trials evaluating the restorative properties of a number of crops (Francis, 1991). However, for seed production in New Zealand, it would seem unwise to sow the crop in depleted, poorly structured soils. The speed of growth of the crop indicates that optimum soil conditions are required. Soil of poor structure and bad compaction has to be avoided, because it may, in fact, create problems with damp seedlings (Krober and Beckmann, 1975). Problem weeds, observed in the field, were fathen (*Chenopodium album*) and nightshade (*Solanum nigrum*) while wire weed (*Polygonum aviculare*) and willow weed (*Polygonum persicaria*) were seed dressing problems. Limited popularity of this plant depends on a low availability of its seeds on the market which results from difficulty in cultivation and price of seeds. Despite the fact that the plant has low soil, fertilization and climatic requirements, high yield may be obtained only with optimal moisture and thermal conditions. Plants which were negatively affected by weather may characterize with low yield and extension of flowering and seeds maturation. One of the grower's task should consist in maintaining high quality of seeds through their appropriate storage. The issue of the impact of long-term seeds storage on their sowing quality is very significant on account of economy and maintaining high germination ability of the investigated sowing material in the form of a specific species of crop. The indeterminate flowering, coupled with easily shattered pods, present a major harvesting problem with Phacelia. Aim of crop production is to establish uniform plant emergence, reasonably high plant populations and to attempt to compress the flowering as much as possible. The objective is to produce seed of even maturity. Pollination Bees are required for maximum seed set in Phacelia, however the crop is highly attractive to bees. About 2.5 hives per hectare should be provided if there is no bee source nearby (Ponichtera Piotr. 2016). According to Sulewska et al., (2005) during the so called farm storage of seeds, conditions and storage time should be absolutely considered, which affect germination ability, particularly when we plan the use of these seeds as sowing material.

The aim of this study was to examine the quality of seeds NS Priora grown in Serbia.

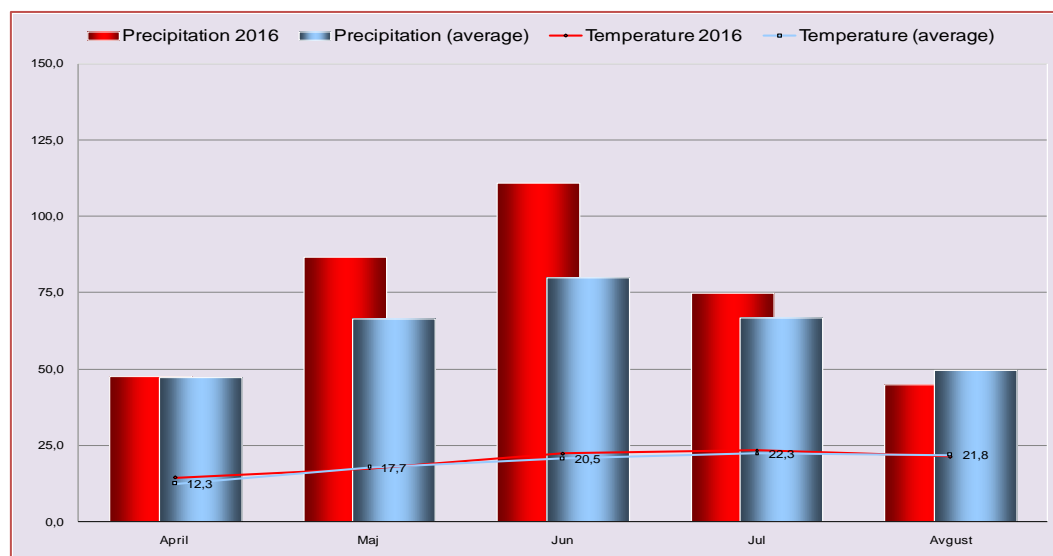
### Material and methods

The aim of this study was to examine the quality of new variety NS Priora produced in 2016, the plots of the Institute of Field and Vegetable Crops Backi Petrovac ( $\phi$ N 45 ° 20 'λE 19 ° 40' 89 m.s.l.). The basic plot amounted to 10 m<sup>2</sup> in three replications. The experiment was conducted according to a split plot. Preceding crop was buckwheat. The standard technology for crop cultivation phacelia was applied. Autumn ploughing is carried out to a depth of 25 cm, when the present one 200 kg ha<sup>-1</sup> of NPK nutrients. Sowing was done in late March 2016 at a depth of 2 cm. The general recommendation was to sow at a depth of 1-2 cm. It is recommended to use 8-10 kg ha<sup>-1</sup> for phacelia seed sowing. Harvest was carried out at technological maturity of plants (Popović et al., 2016, 2017b). After the harvest, samples from all replicates were measured and quality of the seeds were evaluated. From chemical analysis, nitrogen content and protein content in the grain, were determined, by methods of Kjeldahl, DM 05.10.03. The analysis of the experimental data was performed using descriptive statistics

and mediana using the statistical package STATISTICA for Windows 12 and all of the research results are presented in tables and graphs.

### Meteorological conditions

Precipitation in 2016 (April-August, 364mm) were higher than for the long-term average 54 mm, while the average temperature was 19.64 °C, Graph. 1.



Graph 1. Precipitation and temperature in Bački Petrovac, 2016

In the vegetation period 2016 were observed abundant rainfall, and that in May 86.6 mm, 110.9 mm in June, July, 75 mm, 44.8 mm and in August, graph. 1.

### Results and Discussion

Phacelia is used in our country as a post-crop and honey plant. Genetic potential seed yields of variety NS Piora is 1000 - 1500 kg ha<sup>-1</sup>, which would possibly be attainable if which would possibly be attainable if all seed could be harvested and losses through uneven maturity and/or shattering would be minimised. Grain yields of phacelia is 600-900 kg ha<sup>-1</sup>. Phacelia flowering plant continues over 8 weeks (50-65 days) period (Popović et al, 2016a, 2017a, 2017b). Phacelia seed traits depend on many factors: genotype, the moisture content in physiologically mature seeds at harvest time, the technological maturation of seed, seed infection pathogens, the presence of pests and others. Seed characteristics are changed and due to different agro-ecological conditions.

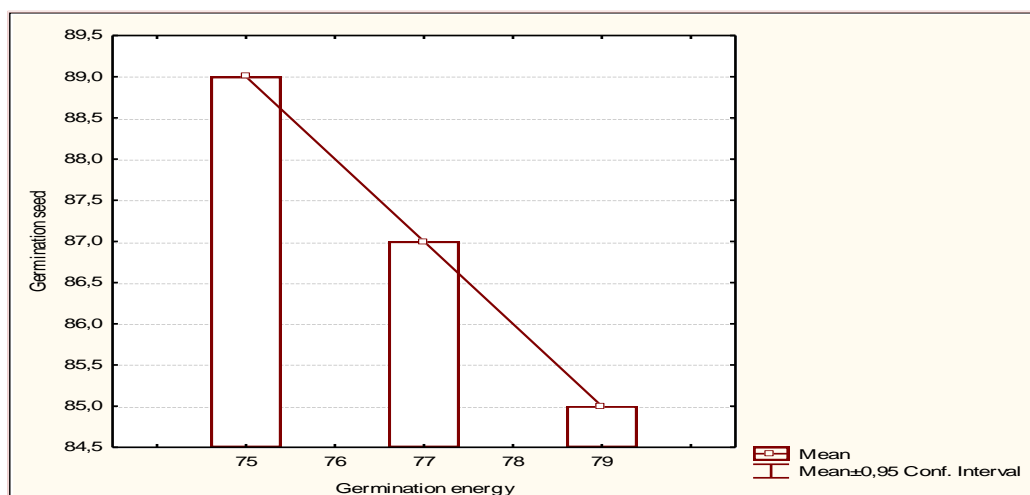
NS Piora had high grain yield good quality. Flowering plant continues over 60 days. Grain yields of NS Piora in 2016 was 902 kg ha<sup>-1</sup> (Popović et al, 2016, 2017a, 2017b). Average germination of seed, of NS Piora seeds harvested in 2016, was 87% and average germination energy was 77%, Table 1, Graph. 2.

The average thousand seeds weight was 1.42 g. The average cleanliness of seed, 98.28%, table 1. The standard error for thousand seeds mass was 0.02, Table 1, Graph. 3.



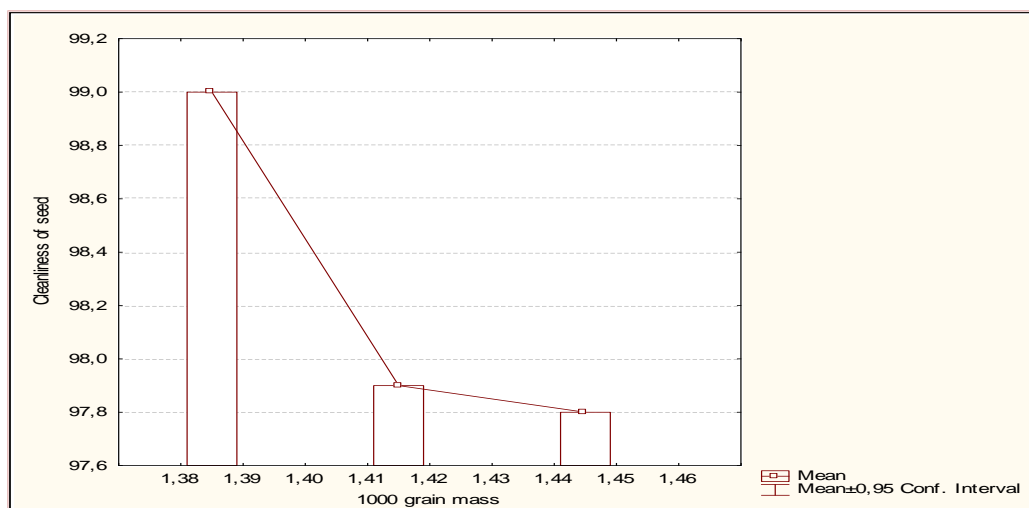
Table 1. The tested parameters of seed quality of variety NS Priora

Parameter	Average	Minimum	Maximum	St. Dev.	St. Error	Variance
Germination seed, %	87.01	86.00	88.02	2.00	1.15	4.00
Germination energy, %	77.01	75.05	79.00	2.01	1.16	4.00
Cleanliness of seed, %	98.23	97.8	99.00	0.66	0.38	0.44
Mass of 1000 seed,g	1.42	1.39	1.45	0.03	0.02	0.001
Nitrogen content, %	3.21	3.18	3.23	0.026	0.015	0.001
Protein content, %	20.06	19.85	20.19	0.18	0.11	0.04



Graph. 2. Germination seed and germination energy for seed NS Priora

Testing the quality of seeds shall be determined purity, germination, moisture, health, germination energy, 1000 seed weight and other properties. Determination of seed germination (viability of seed) presented the determination of maximum potential of germinated seeds of a single party. Filter paper can be used as a medium for testing the viability of seed. Inoculation is done in germination trays at a temperature of 20-30 °C, or at a constant temperature of 25 °C. After five days, reading is done of germination energy, and after 14 days viability is estimated, i.e., assessment of seedlings is performed. Germination energy represents the number of normal seedlings compared to the number of seed placed on germination determined after a expiry of time for the first assessment, i.e. the determining of germination energy. Germination energy and viability is expressed as a percentage of normal seedling, according to their number. Examination of the mass of 1000 of seed is carried out by taking a 1,000 seed from fractions "of pure seed" and their measurement determines 1000-seed weight average, expressed in grams. Length germination test was determined for each plant species. For phacelia smallest seed purity can be 94%, it can have up to 2% of other types, the lowest seed germination of 65, the maximum moisture content of 13% (Official Gazette of FRY 58/2002 - Rules on the quality of seed of agricultural plants).

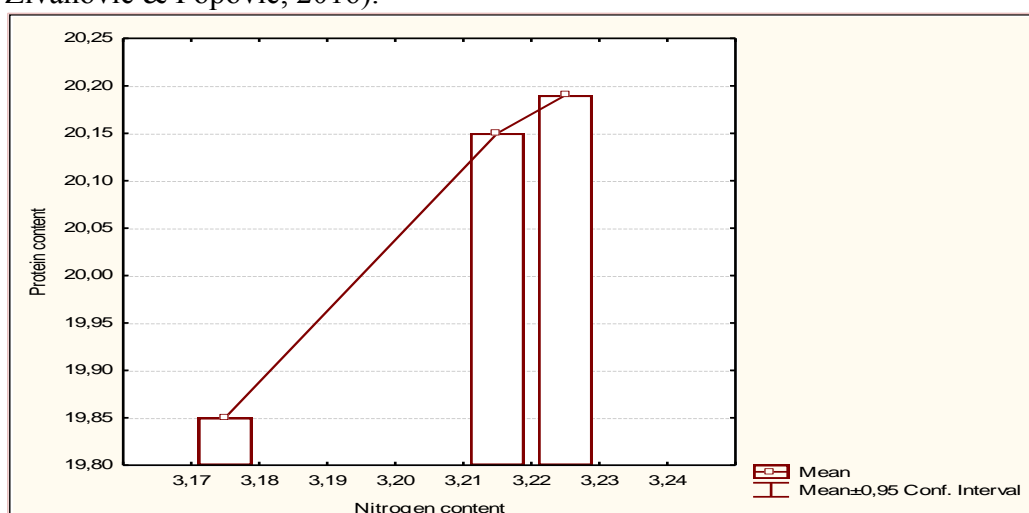


Graph. 3. Mass of thousand seeds and for cleanliness of seedv. NS Priora

NS Priora variety had average nitrogen content is 3.21% and protein content was 20.06%. The standard error for nitrogen content was 0.015, Table 1, Graph. 4.

One of the most important factors determining productivity is the photosynthesis process by which green plants accumulate organic matter and energy (Vasileva and Ilieva, 2017).

Agro ecological conditions depend on how many of the meteorological - edaphic conditions in an region of the same from the application agro-technical practices in the production of seed crops (Stevanovic et al., 2016). From above, it follows that properties of produced seed depend of procedures, totally controlled by human, from ecological conditions on which man can affects to some degree, on the genotype and on the interaction between all the above mentioned factors. By processing, seed materials eliminates the excess moisture and unwanted impurities and performs equalization of seed quality at condition suitable for sowing. During the processing procedures, properties of seed, in the natural seed material, are very important. Processing aim is to equalize usage characteristics of seed up to required agro-technology levels, regardless of production location and genotype (Popović, 2010; 2015; Glamočlija et al, 2015; Đekić et al., 2017; Terzić et al, 2016; Kresović et al, 2016; Živanović & Popović, 2016).



Graph. 4. Protein content and nitrogen content of seed for v. NS Priora

Phacelia is a hardy plant forage. It is grown for seed production, for obtaining green forage, silage, hay, as well as crop protection, crop of green fertilizers and as bee pasture (Popović et

al., 2017a). In Europe, it is grown in many countries as a forage and ornamental plant. Phacelia is exploited in the green state or as silage and it is used for green manure and as pasture for bees. It is grown for reduction of nitrate in the soil and the recycling of the nitrogen (Hulin, 1993). Phacelia can be used as green manure. Most of the plants for green manure are plowed after flowering by fragmentation of overground mass and entering into the soil two or three days before sowing the main crop. Siderats enriches the soil in organic matter, improves the biological activity of the soil, increases the capacity of soil for water, affects the soil-hygiene and biological drainage, improves use of the hard available nutrients, lessens leaching of nutrients and the nitrate and reduces the evaporation of the water from the soil (cover crops) that represents negative impact of drought. For the reason of better environmental adaptation and larger overhead and underground mass with more biologically-linking nitrogen may be combined in a mixture of legume and non-legume siderat. In the spring of a mixture of heartburn, phacelia and spring beans or in the autumn, vetch and peas in a mixture with oats or rye). Phacelia is useful for soil because with its good developed root system and a number of leaves that covers the soil and protect it from erosion. Spring sowing phacelia it is possible to suppress the competitive weeds such as ambrosia, sorrel etc. (Bogović, 2013, Popović, 2017b). The thick root of phacelia, who often penetrates soil to a depth of 70 cm improves soil structure (Čolaković, 2006). Phacelia population decreases cyst nematodes (*Globodera*) in soil (Šubic, 2016).

Beekeepers growing variety phacelia NS Piora will have a safe pasture and high quality honey yields, to over 1 t ha<sup>-1</sup>. Honey of phacelia has healing properties: has antibacterial, antifungal and anti-inflammatory, for inflammation of the mouth and throat. It is good for intestinal diseases, jaundice, as a diuretic, helps convalescent after surgery and diseases, slows aging and extends the life (Yashmak, 1980). Puškadija et al. (2004) says that the phacelia seeds used in pharmaceutical in making of drugs.

### **Conclusion**

Variety phacelia NS Piora, in 2016, achieved a high seed yield and excellent seed quality. The average protein content amounted of 20.06% while the nitrogen content of the grains was 3.21%.

Phacelia in Serbia it is grown as a forage and ornamental plant, are exploited in the green state or as silage. It is used for green manure, as cover crops and as bee pasture.

By growing of variety phacelia NS Piora, beekeepers will have a safe pasture and high yield of quality honey, of over 1 t.

### **Acknowledgments**

The work was created as a result of projects TR 31025 and TR 31024 funded by the Ministry of Education, Science and Technological Development of Republic of Serbia.

### **References**

- Anonymous A. (1989): German information leaflet on Phacelia.
- Bogović M. (2013): Green manure or sideration. <http://www.agroklub.com/ratarstvo/zelenagnojidba-ili-sideracija/9305/>
- Booker Seeds (1990): Information sheet on Phacelia.
- Brzezowska, J., Dreszczyk E. (2009): Ocena przydatności roślin do uprawy alternatywnej z wykorzystaniem typowych systemów technicznych. *Agricultural Engineering*, 1(110), 45-52.

- Cazzola, V. (1987): A discussion paper to the EEC on the inclusion of *Phacelia tanacetifolia* in the list of compulsory certifiable species. (Italian). *Senenti Elette* 33(6) : 7-10.
- Daniel, P., Zobelt, V. (1986): Investigations about feed intake of fodder rape and phacelia. *Inst. Pflanzenbau pflanzensuechtung* 11, Justus Liebig Univeristy, Giesen *Wirtschaftseigene Futter* 32 (2): 175-182.
- Čolaković E. (2006): California bluebell – the requested honey plant. *Green Garden* 43: 26
- Glamočlija Đ., Janković S., Popović V., Filipović V., Kuzevski J., Ugrenović V. (2015): Alternatively crop plants in conventional and organic growing systems. Monograph. Belgrade, 1-355;
- Đekić V., Popović V., Branković S., Terzić D., Đurić N. (2017): Grain yield and yield components of winter barley, 63 (1): 179-185. DOI: 10.17707/AgricultForest.63.1.21
- Hulina N. (1993). *Facelia - Phacelia tanacetifolia* Benth. Attracts the attention of scientists and farmers / *Facelija – Phacelia tanacetifolia* Benth. privlači pažnju znanstvenika i poljoprivrednika. *Agronomski glasnik* 1-2: 125-129.
- Jašmak K. (1980): Honey herbs. Nolit, Belgrade. / *Medonosno bilje*. Nolit, Beograd. In Serbian.
- Kresović B., Ikanović J., Rajić Z., Tapanarova A., Dražić G., Popović V. (2016): Canary Grass as a viable energy source and its future. *Energetika*. 141-146.
- Krober, H., Beckmann, E. (1975): Fungal damage on *Phacelia tanacetifolia*. *Rachrichtenblatt des Deutsi: hen Pflanzenschutz dienstes* 27 (12): 177-180.
- Official Gazette of FRY 58/2002 - Rules on the quality of seed of agricultural plants
- Orsi, S., Bionoi, A. (1987): *Phacelia tanacetifolia*: its honey potential. *Italia Informatore Agrario* 43(47): 53-51.
- Popović M. Vera (2010): Influence of agro-technical and agro-ecological practices on seed production of wheat, maize and soybean. Doctoral thesis, University of Belgrade, Faculty of Agriculture, 1-145. 22-40.
- Popović M. Vera (2015): The concept, classification and importance of biological resources in agriculture. Editor. Milovanovic J., Đorđević S.: Conservation and enhancement of biological resources in the service of ecoremediation. Monograph. Belgrade. ISBN 978-86-86859-41-9; 1-407. 29-51.
- Popović V., Sikora V., Vučković S., Mihailović V., Filipović V., Živanović Lj., Ikanović J., (2016a): NS Piora–high nectar variety of phacelia [*Phacelia tanacetifolia* Benth]. *Tehnološke inovacije–Generator privrednog razvoja*. Banja Luka, BiH.
- Popović V., Vidić M., Ikanović J., Đekić, V., Filipović V., Tabaković M., Veselić J. (2016b): Soybean oil yield as affected by the growing locality in agro-climatic divergent years." *Agriculture and Forestry*". Podgorica, Vol. 62, 1, 217-225.
- Popović V., Marjanović-Jeromela A., Sikora V., Vučković S., Mihailović V., Živanović Lj., Ikanović J., Merkulov Popadić L. (2017a): *Phacelia tanacetifolia* Benth - Honey plant. *Zbornik naučnih radova Instituta PKB Agroekonomik*. Beograd.
- Popović V., Sikora V., Živanović Lj., Čurović M., Terzić D., Kolarić Lj., Rajičić V., Ikanović J. (2017b): California bluebell. NS Piora for biomass production for obtaining the roughage. /Sorta facelije NS Piora za proizvodnju biomase u cilju dobijanja voluminozne stočne hrane. XXII Simposium on biotechnology. Book 1. 10.-11.3.2017. Čačak, 213-221.
- Petkov, V. (1966): Study on some legume-phacelia mixtures as forage plants and honey plants. (Bulgarian). *Rasterivudri Nauki* 3(8): 127-133.
- Ponichtera P. (2016): The sowing value of tansy phacelia (*Phacelia tanacetifolia* Benth.) seeds in the long-term storage. *Agricultural Engineering* No. 3 , pp. 153 -1 59 [www.wir.ptir.orgm](http://www.wir.ptir.orgm) ISSN 2083 -1587; e -ISSN 2449 -5999 2016, Vol. 20, 3, 153-159.

- Ramenda, S. (2003): *Facelia błękitna*. *Agrochemia*, 6, 25-28. Resolution of the Minister of Agriculture and Rural development as of 14th September 2010. (JoL No 183 Item 1230).
- Senegonca, C., Frings, B. 1988. The influence of *Phacelia tanacetifolia* to pests and beneficial insects in sugar beet plots. *Pedobiologia*'32 (5-6): 311-316.
- Stevanović P., Vučković S., Popović V., Ikanović J., Živanović Lj., Simić A., Rajičić V., Krsmanović, P. (2016): Influence of vegetation space, seeding rate and fertilization on the number of flowers and seed yield trefoil / Uticaj vegetacionog prostora, setvene norme i prihrane na broj cvetova i prinos semena žutog zvezdana (*Lotus corniculatus* L.). XXX Symposium of Institute of PKB Agro-economic. Belgrade. Vol. 22. 1-2, 1-10.
- Tabaković M., Jovanović S., Popović V., Ranković D., Stanisavljević R., Štrbanović R. (2016): Variability of hybrid maize seed traits of different locations. *Jornal of Institute of PKB Agro-economic. Pad. Skela. Belgrade*. Vol. 22,1-2, 135-172.
- Terzić D., Radović J., Marković J., Popović V., Milenković J., Vasić T., Filipović V. (2016): New technical-technological process of roughage production by combining an corn and soybean in double cropping. The technical solution. Belgrade. In Serbian.
- Teittinen, P. (1980): Observations of the food plants of the honeybee. *Annales Agriculturae Ferriae* 19 (2): 156- 163.
- Šubić M. (2016): Health safety potato tubers before planting. *Gospodarski list* br. 4: 60.
- Živanović Lj. & Popović V. (2016): Production of soybean (*Glycine max*) in the world and in Serbia. *Proizvodnja soje (Glycine max) u svetu i kod nas*. XXI Symposium on biotechnology, 11-12.03.2016., Čačak, vol. 21 (23), 129-135.
- Vasileva V. and Ilieva A. (2017): Some physiological parameters in mixtures of cocksfoot and tall fescue with subterranean clover. *Bulg. J. Agric. Sci.*, 23 (1): 71–75.

## EFFECTS OF DIFFERENT PLANTING TIME AND PLANT DENSITIES ON SOME PARAMETERS OF SECOND CROP SESAME

Ahmet YILMAZ<sup>1\*</sup>, Servet ABRAK<sup>2</sup>

<sup>1</sup>University of Harran, Faculty of Agriculture, Department of Field Crops, Şanlıurfa, Turkey

<sup>2</sup>GAP Agricultural Research Institute Directorate, Şanlıurfa, Turkey

\*Corresponding author: hayilmaz@harran.edu.tr

### Abstract

This research was conducted in order to determine the effects of different planting time and plant densities on some parameters of second crop sesame (*Sesamum indicum* L.) at the GAP Agricultural Research Institute Talat Demirören Research Station in 2015 and 2016 in Şanlıurfa province (Turkey). Trial was conducted according to randomized blocks split plots experimental design with 3 replicates. The main parcels planting times were 1 June, 15 June, 1 July, sub-parcels 2 different inter-row spaces were 35 cm, 70 cm, and 4 sub-sub plots 4 different intra-row spaces were 5 cm, 10 cm, 15 cm and 20 cm. In the conclusion of the two-year findings we found that; seed and oil yield were statistically significant in terms of planting time. Though seed and oil yield were found statistically significant in terms of different inter-row distances, the effect on the number of seeds per capsule was found insignificant. Seed and oil yield were found statistically significant in terms of intra-row distances as well. According to the results obtained from the study, the highest oil yield was obtained from the 35x5 cm planting density on June 15 with 60.64 kg/da, the lowest oil yield was obtained from the 70x20 cm planting density on July 1 with 28.79 kg/da. Interaction between planting times x inter-rows x intra-rows was found significant statistically at the level of 1% in terms of seed and oil yield.

**Keywords:** *Sesame, planting time, plant density, seed yield, oil yield*

### Introduction

Sesame, a warm climate plant, is able to grow in tropical, subtropical and temperate climates (moderate climate) zone and in suitable temperature and precipitation conditions. Sesame exhibits its ideal growing between 25° of North and South parallel, reaching 42° in the North and 35° in the South. In this context, Turkey is located on the northern border of the world sesame growing area. The sesame total temperature requirement is 2500-2800 °C. Temperature can shorten the vegetation period as the temperature increases as until the temperature conditions do not affect the natural development of the plant. The temperature for germination should not fall below 12 °C. It is a good indication that average monthly temperatures do not fall below 20 °C during the 90-120 day vegetation period in Turkey conditions (Tan, 2007). The world's sesame planting area is 10.8 million hectares, production of 6.2 million tons and yield 576 kg/ha (Anonymous, 2014). The total cultivation area of oilseed plants in Turkey is 1.36 million hectares and the production 3 million 442 thousand tons (Anonymous, 2015). This research is to provide positive contribution to sesame farming which has been traditionally carried out in low productivity and limited areas in the GAP region, with the aim of determining the most appropriate sowing time and plant density for the second crop sesame growing in Harran Plain which is located in Southeastern Anatolia Region, which is experiencing semi-arid climatic conditions. It is aimed to improve yield and quality of sesame seeds only by changing certain habits of producers, without the necessity of

using an additional input in the research. It is desirable to increase the producer income in parallel with the maximum yield that can be achieved per the unit area in terms of awareness and extension studies by medium and long term research results, application and transfer knowledge to the production. This will also contribute to the widespread and sustainability of oilseed crops at macro scale and sesame cultivation at micro scale. In addition, it is hoped that the results of the project will accelerate the production and reduce the dependency of our country on oilseed crops and the positive contribution to the economy of the country.

### **Material and Methods**

The research was carried out in the Harran series, which is widely found in the red brown soil group of Harran Plain. The serial soils that are alluvial main material and are deep and shallow slopes. Typical red colored profiles have a clayey texture. Upper soil is mid-cornered block, then granular; the bottom soil is strong, large prismatic and then strong mid-cornered block. It contains low density secondary lime pavers to the bottom. The slip surfaces begin in the B-horizon and increase significantly in the downward direction. The whole profile is very calcareous, the organic matter content of the serial soils is low, and the Cation Exchange Capacity are high. Organic matter decreases from surface to inferior, ranging from 0.9 % to 0.3 %. Cation Exchange Capacity clay depending on the content, increases towards the lower layers (Dinç et al., 1988). Şanlıurfa province is affected by the Mediterranean climate as well as the terrestrial climate zone. The summers are arid and warm, and the winters are warm and relatively rainy. In summer, it is mostly affected by arid and warm tropical air mass, which is located in the Basra low pressure center, and it is affected by semi-arid climatic conditions. Daytime temperature is above 44 °C. The very low relative humidity increases evaporation (Atalay et al, 2006).

This research was conducted so as to determine the effects of different planting times and plant densities on yield and yield components of second crop sesame (*Sesamum indicum* L.) under Harran Plain semi-arid climate conditions at the GAP Agricultural Research Institute, Talat Demirören Research Station in Şanlıurfa province in 2015 and 2016. Arslanbey middle branched sesame variety which was bred for GAP Region used as material and the trial was carried out with respect to randomized blocks split split plots experimental design with 3 replications. In the trial, the main parcels were planting times (1 June, 15 June and 1 July), sub-parcels were 2 different inter-row spaces (35 and 70 cm), and 4 sub-sub plots were 4 different intra-row spaces (5, 10, 15 and 20 cm).

### **Results and Discussion**

The second crop to be harvested in semi-arid climatic conditions in the light of the research findings will provide benefits to the following recommendations in sesame cultivation.

Excess seed use should be avoided,

In order to ensure the homogeneity of the seedlings, thinning must be done on time, pressurized irrigation systems should be used within the possibilities and soil preparation should be done properly.

Harvesting and threshing should be done at the most appropriate times and methods, not causing seed loss.

Planting must be done at the recommended date and density.

Also, when the research results are examined;

Table 1. Impact of Sowing Time x Inter Row x Intra Row Interaction on the Number of Seeds per Capsule for Sesame in 2015 and 2016 Years

Subjects		The 2015 growing season (Number of seeds per capsule - pieces/capsule)				The 2016 growing season Number of seeds per capsule - pieces/capsule)			
Sowing Time x Inter Row		Intra Row							
		5	10	15	20	5	10	15	20
1	35	46.67 d-f	53.67 ab	55.33 a	54.33 ab	46.67 e-h	56.00 a-c	55.00 a-d	59.33 a
2		38.00 hi	36.00 i	46.66 d-f	38.67 hi	41.00 ij	39.00 j	49.67 d-g	37.00 j
3		43.67 fg	47.00 c-f	46.67 d-f	48.33 c-e	48.67 e-g	49.67 d-g	46.00 f-i	52.00 b-e
Mean		42.78	45.56	49.56	47.11	45.45	48.22	50.22	49.44
1	70	54.33 ab	50.33 b-d	50.33 b-d	51.33 a-c	57.33 ab	50.33 d-g	48.00 e-g	50.33 d-g
2		41.33 gh	46.67 d-f	47.33 c-f	50.00 b-d	38.67 j	41.33 h-j	51.33 c-f	46.33 f-i
3		45.00 e-g	42.00 gh	40.67 gh	39.00 hi	49.33 e-g	45.67 g-i	46.00 f-i	41.00 ij
Mean		46.89	46.33	46.11	46.78	48.44	45.78	48.44	45.89
General Mean		46.39				47.74			
CV (%)		5.92				6.75			
LSD (Int.)		4.55**				5.34**			

importance at the level of \*:0.05, \*\*:0.01 1: 1 June 2: 15 June 3: 1 July

From the Table 1; in both years of the experiment, it is observed that the sowing time x inter row x intra row interaction was statistically effective at 1 % significance level for the number of seeds per capsule. The lowest number of seeds per capsule (36.00 pieces/capsule) from 35x10 cm planting density on June 15, the maximum number of seeds per capsule (55.33 pieces/capsule) were obtained from 35x15 cm on June 1 in the 2015 year, and the lowest number of seeds per capsule (37.00 pieces/capsule) from 35x20 cm planting density on June 15, the maximum number of seeds per capsule (59.33 pieces/capsule) were obtained from 35x20 cm on June 1 in the 2016 year. In both years of the experiment, close results for the number of seeds per capsule have been reached.

Table 2. Impact of Sowing Time x Inter Row x Intra Row Interaction on the Oil Yields for Sesame in 2015 and 2016 Years

Subjects		The 2015 growing season (Oil yields - kg/da)				The 2016 growing season (Oil yields- kg/da)			
Sowing Time x Inter Row		Intra Row							
		5	10	15	20	5	10	15	20
1	35	55.81 a	41.26 fg	41.70 e-g	45.99 b-d	63.97 a	54.24 cd	56.75 bc	58.13 b
2		56.30 a	53.94 a	44.71 c-e	55.89 a	64.98 a	67.26 a	45.70 h-j	60.03 b
3		48.28 b	44.62 c-e	43.18 d-f	47.26 bc	57.87 b	47.95 g-i	53.25 de	50.54 e-g
Mean		53.46	46.61	43.20	49.71	62.27	56.48	51.90	56.23
1	70	43.41 d-f	35.86 i	46.11 b-d	44.42 c-f	52.26 d-f	43.36 jk	48.95 f-h	49.90 fg
2		37.36 hi	35.60 ij	39.12 gh	41.68 e-g	44.80 ij	40.37 k-m	39.51 lm	40.29 k-m
3		32.21 k	32.46 jk	36.63 hi	27.45 l	39.29 lm	38.37 m	42.46 j-l	30.13 n
Mean		37.66	34.64	40.62	37.85	45.45	40.70	43.64	40.11
General Mean		42.97				49.60			
CV (%)		4.45				4.05			
LSD (Int.)		3.16**				3.32**			

importance at the level of \*:0.05, \*\*:0.01 1: 1 June 2: 15 June 3: 1 July

From Table 2; in both years of the experiment, it was observed that the sowing time x inter row x intra row interaction was statistically effective at the 1 % significance level for the oil yield. The lowest oil yield (27.45 kg/da) from 70x20 cm planting density on July 1, the maximum oil yield (56.30 kg/da) were obtained from 35x5 cm on June 15 in the 2015 year, and the lowest oil yield (30.13 kg/da) from 70x20 cm plant density on July 1, the maximum oil yield (67.26 kg/da) were obtained from 35x10 cm on June 15 in the 2016 year. The highest oil yields in both years of the experiment were taken from 35 cm inter row space on June 15.



The findings collected were compliance with the findings of Rahnama et al., (2006), Tahir et al., (2012) and Noorka et al., (2011) researchers, incompatible with the findings of Aghili et al., (2015) and Sögüt et al., (2009).

### **Conclusions**

According to the two-year average; the highest seed yield was obtained from the 35x5 cm planting density on June 15 with 143.42 kg/da, and the lowest seed yield was obtained from the 70x20 cm planting density on July 1 with 72.50 kg/da. According to the results obtained from the study; it is suggested that the most suitable sowing time as the second crop for medium-branched sesame variety with 3 flowers should be between 1-15 June and the most suitable planting density should be 35x5 and 35 x10 cm in GAP Region, which is located in semi-arid climatic conditions.

### **References**

- Aghili, P., Sinaki, J. M., and Nourinia, A. A., 2015. The Effects of Organic Fertilizer and Planting Date on Some Traits of Sesame Varieties. *International Journal of Biosciences (IJB)*, 6(5): 16-24.
- Anonymous, (2014). Food and Agriculture Organization of the United Nations. <http://www.fao.org/faostat/en/#data/QC>.
- Anonymous, (2015). Turkish Statistical Institute. <https://biruni.tuik.gov.tr/bitkiselapp/bitkisel.zul>
- Atalay, I., and Mortan, K., 2006. Regional Geography of Turkey. İnkılap Publications, İstanbul.
- Dinç, U., Şenol, S., Sayin, M., Kapur, S., Güzel, N., Derici, R., Yeşilsoy, M. Ş., Yeğingil, İ., Sari, M., Kaya, Z., Aydın, M., Kettaş, F., Berkman, A., Çolak, A. K., Yılmaz, K., Tunçgöğüs, B., Çavuşgil, V., Özbek, H., Gülüt, K. Y., Karaman, C., Dinç, O., Öztürk, N., ve Kara, E. E., 1988. Southeastern Anatolia Region Soils (GAT) Harran Plain, TUBITAK Agriculture and Forestry Group Guided Research Project Final Report, Project No: TOAG-534, Adana.
- Noorka, I. R., Hafiz, S.I., and El-Bramawy, M. A. S., 2011. Response of Sesame to Population Densities and Nitrogen Fertilization on Newly Reclaimed Sandy Soils. *Pakistan Journal of Botany*, 43(4): 1953-1958.
- Rahnama, A., and Bakhshandeh, A., 2006. Determination of Optimum Row Spacing and Plant Density for Uni-Branched Sesame in Khuzestan Province. *Journal of Agricultural Science and Technology*, (8): 25-33.
- SÖGÜT, T., 2009. Effect of Main and Second Cropping on Seed Yield. Oil and Protein Content of Sesame (*Sesamum indicum* L.) Genotypes. *Turkish Journal of Field Crops*, 14(2): 64–71.
- Tahir, M., Saeed, U., Ali, A., Hassan, I., Naeem, M., Ibrahim, M., and Rashad Javeed, H. M., 2012. Optimizing Sowing Date and Row Spacing for Newly Evolved Sesame (*Sesamum indicum* L.) Variety TH-6. *Pakistan Journal of Life & Social Sciences*, 10(1): 1-4.
- Tan, Ş., 2007. Sesame Agriculture. Aegean Agricultural Research Institute, Farmer Brochure No: 135, İzmir.

## THE EFFECTS OF DIFFERENT DWARFING APPLICATIONS ON BURSA BLACK FIG (*FICUS CARICA* L.) TREES IN TERMS OF YIELD AND QUALITY

Halil Güner SEFEROĞLU\*, Mehmet TOMAŞ

Adnan Menderes University, Faculty of Agriculture, Department of Horticulture, Aydın, Turkey

\*Corresponding author: gseferoglu@adu.edu.tr

### Abstract

The study to specify the effects of different applications for dwarfing, fruit quality and yield on Bursa Siyahı (Black Bursa) Fig Trees was performed between 2014-2015 in the parcel of Department of Horticulture, Faculty of Agriculture, Adnan Menderes University. In order to create artificial dwarfing on the fig nursery trees; Prohexadione-Calcium, a giberellin acid inhibitor, was used as 125 and 250 ppm. In addition, nursery trees were planted on 30° angle with ground level and were grown by strapping to galvanized wires. Two different dose applications of curving+Pro-cal were used and there have been 6 different applications in total including the control. The fig nursery trees were planted 1x1.5 m intrarow and above-row in parcels where branch bending applied and also 1x1 m intrarow and above-row in parcels where other applications made. Pro Ca applications were performed twice on vegetation period, by means of the period when new shoots are 5 cm tall on saplings. Morphological observations were performed to specify the effects of applications on dwarfing. Pomological observations were performed to specify the effects of applications on fruit quality and yield. Also, phenological effects of the application were observed. On Pro-Ca applications about the trunk development, node number increased while the trees with higher trunk length were obtained contrary to the expectations. On the applications where were not significant differences on the effects in fruit quality, the range of trunk cross-sectional area had the highest values in 125 ppm Pro-Ca application. Four old fig trees were observed phenologically and there were approximately a week delays in the development of trees with 30° sloping than standard trees.

**Keywords:** *Prohexadione Calcium, Pro-Ca, fig, dwarfing, fruit yield and quality, bending.*

### Introduction

One of the most significant aspects in pomiculture is the excessive vegetative growth of fruit trees grown. Less penetration of light through the tree corollas results in decreased yield of quality of fruits as well as increased cost of agricultural disinfection together with the increased cost of cultivation activities such as pruning. As the shortening of youth infertility is quite substantial in dwarf fruit growing, vegetative growth is deliberately required be taken under control because yield can regularly be obtained from trees each year with the vegetative and generative balance established appropriately and accurately from the early ages. (Ağça, 2008, referring Faust). The state of pudginess in fruit trees is caused by artificially created pudginess and hereditary environmental conditions (Özçağiran, 1974). Dwarfing is commonly ensured by the utilization of dwarf rootstock. Dwarf rootstocks are the rootstocks that grow trees that are substantially smaller than the trees growing on their own roots (Webster, 1995). The purpose of researchers and arboriculturists is to grow rootstock with the characteristics of economically reproduction on wide fields and special adaptation. (Demirsoy and Macit, 2007, referring Cummins and Aldwinckle). Apart from this, selection of spur types can be

performed (Tukey, 1964). Pinching, root pruning, ring removing, throttling, notching, tying tree branches by bending them down or obtaining wide angle branches instead of vertical growth help for dwarfing process. Apart from these methods, Benzyl Adenin, Paclobutrazol ve Prohexadione-calcium (Pro-Ca) are the most common used growth regulating agents assisting to the dwarfing can also be used (Ağca, 2008). It is not quite possible to mention about dwarf rootstock or hereditary dwarf fig growing related to the figs that are highly valuable and having strategic importance for our country. Cultivation is traditionally done in gardens constructed with 6x6 m distances. The increase in national and international transportation facilities within the recent years, technological advancements as well as developments reflecting on the chain after the harvest such as preparation for the market, packaging and warehousing has caused substantial increases in the demand for fresh fruits. 20%-25% of table figs produced in our country are exported and Bursa Black fig variety has the lion's share in exportation with a ratio of around 90%. In this sense, all sorts of activities and endeavours for developing and improving the cultivation of Bursa Black figs that has a substantial role in our table fig production and exportation shall be highly important and noteworthy. From this viewpoint, it is considered that it is appropriate and convenient to develop modern fruit cultivation practices in the cultivation of Bursa Black fig, which is an important table fig variety. Therefore, determination of effects on various dwarfing applications for the purposes of increasing of plant number on the unit area which is among the essentials of dwarf fruit growing, obtaining yield in early ages, facilitation of care and yield processes, improving the fruit quality in plants such as Bursa Black fig variety that has a high habitus in terms of tree growing on dwarfing, fruit yield and quality is aimed in the thesis subject.

### Material and Method

The research was conducted between the years of 2014-2015 on the field under the possession of Adnan Menderes University in Turkey, the Faculty of Agriculture, Department of Horticulture. The research was initiated after the performance of certain applications for 2 years upon the planting on Bursa Black fig saplings planted on February 17, 2012 on the field under the possession of Adnan Menderes University Faculty of Agriculture, Department of Horticulture.

Table-1. Applications performed on the materials used in the research pre and post-research period.

Application	2012	2013	2014	2015
U1 Group (Control)	Group with no applications performed			
U2 Group (125 ppm Pro-Ca)	125 ppm Pro-Ca (2 times)	125 ppm Pro-Ca (2 times)	125 ppm Pro-Ca (2 times)	125 ppm Pro-Ca (2 times)
U3 Group (250 ppm Pro-Ca)	250 ppm Pro-Ca (2 times)	250 ppm Pro-Ca (2 times)	250 ppm Pro-Ca (2 times)	250 ppm Pro-Ca (2 times)
U4 Group Pruning (30° bending)	Sapling within this group is secured by means of galvanized wires on August 6 after the planting with a pitch of 30° on March 26, 2012 and no further applications was performed accordingly.			
U5 Group Pruning (30° bending) + 125 ppm Pro-Ca	In addition to processes performed on U4 group saplings			
		125 ppm Pro-Ca (2 times)	125 ppm Pro-Ca (2 times)	125 ppm Pro-Ca (2 times)
U6 Group Pruning (30° bending) + 250 ppm Pro-Ca	In addition to processes performed on U4 group saplings			
		250 ppm Pro-Ca (2 times)	250 ppm Pro-Ca (2 times)	250 ppm Pro-Ca (2 times)

For the purpose of determination of the effects of the applications performed on the dwarfing process as well as the fruit quality and yield; phenological, pomological and biochemical data was collected during the period of vegetation and morphological data was obtained at the end of cultivation.

Table-2. Obtained data parameters

Pomological data	Phenological data	Morphological data
Fruit width	Foliation commencement date	Trunk length
Fruit length		Trunk diameter
Fruit height	Aftercrop generation date	Internode number
Ostirole	Full foliation date (Aftercrop generation date)	Length between internode
Neck length		Lateral branch number
Fruit length	Defoliation date	Longest lateral branch length
Brix, TA., pH and Hardness values		Length to the primary lateral branch

By means of applying TARIST statistical analysis program on the values obtained from the trial, variance analysis was made accordingly. LSD test with margin or error of 5% was applied for the purpose of revealing discrepancies upon comparing the means and the mean values are grouped based on the outcomes obtained from this.

### Findings

#### Findings on Trunk Development, Fruit Yielding and Fruit Quality

Table 3. Effect of various applications on fig trees on morphological and pomological parameters

Application	Trunk length (cm)	Trunk diam. (mm)	Numb.of internode (pcs.)	Length between internodes (cm)	Numb. of lateral branch (pcs.)	Longest lateral branch length (cm)	Number of internodes of lateral branch (pcs.)
Control	160.973 a	42.513 b	52.637 a	3.060 b	8.083 b	120.483 b	74.860 a
125 ppm Pro Ca	179.093 a	50.790 ab	56.760 a	3.177 ab	10.900 a	156.283 a	98.853 a
250 ppm Pro Ca	186.423 a	54.050 a	57.760 a	3.217 ab	11.187 a	161.040 a	98.187 a
125 ppm Pro Ca + Branch bending	75.947 b	24.797 d	21.640 bc	3.487 ab	1.277 c	13.017 c	20.540 b
250 ppm Pro Ca + Branch bending	73.513 b	27.450 cd	20.167 c	3.670 a	1.653 c	11.337 c	14.147 b
Branch bending	94.790 b	33.783 c	28.920 b	3.263 ab	2.910 c	28.873 c	26.560 b
LSD (%5)	28.339 **	8.378 **	7.542 **	0.516 ö.d.	2.006 **	34.141 **	28.725 **
Application	Distance to the primary lateral branch (cm)	Fruit weight (g)	Fruit width (mm)	Fruit length (mm)	Fruit height (mm)	Fruit ostirole (mm)	Fruit neck length (mm)
Control	55.530 a	80.700 a	54.043 a	56.730 a	51.097 ab	6.470 ab	9.437 b

125 ppm Pro Ca	51.713 ab	79.647 a	52.640 a	55.790 a	49.187 b	6.157 ab	9.137 b
250 ppm Pro Ca	57.233 a	80.893 a	53.187 a	55.520 a	50.073 b	6.263 ab	8.947 b
125 ppm Pro Ca + Branch bending	37.710 ab	0.000 b	0.000 b	0.000 b	0.000 c	0.000 c	0.000 c
250 ppm Pro Ca + Branch bending	31.167 b	0.000 b	0.000 b	0.000 b	0.000 c	0.000 c	0.000 c
Branch bending	37.950 ab	87.207 a	54.877 a	57.863 a	53.283 a	7.333 a	11.713 a
LSD (%5)	24.081 ö.d.	7.852 ö.d.	3.626 ö.d.	4.493 ö.d.	3.095 ö.d.	0.561 *	1.717 ö.d.

n.s. : Not significant \* : significant according to p=0.05 \*\* : significant according to p=0.01

Applications	Fruit Firmness	Fruit pH	BRIX	Yield (gr)
Control	0.338 a	4.866 a	17.758 a	60.007 ab
125 ppm Pro Ca	0.364 a	4.888 a	17.222 ab	72.787 a
250 ppm Pro Ca	0.380 a	4.865 a	16.878 ab	61.787 ab
125 ppm Pro Ca + Branch bending	0.000 b	0.000 b	0.000 c	0.000 b
250 ppm Pro Ca + Branch bending	0.000 b	0.000 b	0.000 c	0.000 b
Branch bending	0.380 a	4.857 a	15.950 b	29.093 ab
LSD (5%)	0.071n.s.	0.334n.s.	1.742n.s.	63.413n.s.

n.s. : Not significant \* : significant according to p=0.05 \*\* : significant according to p=0.01

### Findings on Phenological Observations

Bud blistering was formed within U1-U2-U3 group applications on March 9, and on March 15 within U4-U5-U6 group applications. The differences among the applications are formed between the plants of vertical growing and the plants growing with a 30° inclination.

When the effect of various applications performed on fig leaves on the foliation commencement time, Control indicating vertical growth on March 13, 125 ppm Pro Ca, 250 ppm Pro Ca groups; 125 ppm Pro Ca+Branch bending, Branch bending applications were initiated to foliate.

The date for occurrence of full foliation on fig leaves as a consequence of applications performed was May 25 in the control and 125 ppm Pro Ca applications and May 26 for 250 ppm Pro Ca application.

The application in where the latest full foliation was occurred was 125 ppm Pro Ca+Branch bending and 250 ppm Pro Ca+Branch bending.

The defoliation was occurred on 16-17 December in the plants with vertical growing (U1-U2-U3) and on December 24-25 in the plants with growth of 30° inclination (U4-U5-U6). The difference of 8-9 days occurred between was resulted from the fact the plants displayed a vertical and inclined growth instead of the Pro-Ca application.

## **Results and Discussions**

The morphological and pomological data obtained from the trial was subjected to variance analysis and the means were compared based on significance level for the purpose of determining the effect of the applications. When the findings obtained from Bursa Black fig trees related to lateral branch number and the longest lateral branch length were assessed, it was determined that Pro-Ca applications with the dosage of 125 and 250 ppm had the highest value. On another words, the effect of Pro-Ca is quite astonishing in terms of both lateral branch number and the longest lateral branch length. The fig trees having the most internodes were obtained from the applications of 125 and 250 ppm, whereas the lowest parameters of less distance between the internodes indicating weak growth were obtained from the control group fig trees. Hekimci (2013) stated with respect to Pro-Ca application realized for two years on the one year old fig trees that the lowest values were obtained for the distance between the internodes from the applications performed with the dosage of 125 and 250 ppm. It is observed that this situation ensured a decrease in the distances among the internodes as a consequence of application of Pro-Ca on elder saplings for the first two years; an increase of the distances among the internodes measured on the trees subject to the application of Pro-Ca upon the continuation of this application within the 3<sup>rd</sup> and the 4<sup>th</sup> year and even resulted in a situation in where the distance among the internodes were measured to be higher at the end of the 4<sup>th</sup> vegetation period.

Trunk diameter growth was determined to have the highest value on the trees with the application of 125 and 250 ppm Pro-Ca just like in the lateral branch number and longest lateral branch length. The application in where the trunk diameter growth was on the lowest value levels was obtained by combining the Pro-Ca with branch bending.

The values in where the distance up to the primary lateral branch was the lowest, just like in trunk diameter growth. It can be said that the primary lateral branching on the trees with low growth is an expected situation.

No yield could be obtained as a consequence of the applications in which 125 and 250 ppm Pro-Ca dosages were combined with branch bending on the fig trees with the age of 4 that were subject to certain applications. Comparisons of pomologic data obtained were performed among 4 applications as control, 125 and 250 ppm Pro-Ca and branch bending. According to the measurements conducted on the fruits obtained from Bursa Black fig trees; it was observed that no differences existed among the applications with respect to the parameters such as fruit width, fruit length, fruit height that determined the corpulence of the fruit. Smith et al. (2005), has stated that Pro-Ca applications has caused a decrease in fruit corpulence in pears whereas Gleen and Miller (2005) indicated that Pro-Ca applications has caused a decrease in fruit corpulence in apples. It was seen that the fruit corpulence, which is the most important factor of the quality criteria especially in table varieties has not caused a size reduction in Bursa Black fig fruits after the Pro-Ca application.

It was seen that no differences existed among the applications in terms of fruit weight, fruit length, fruit firmness, fruit Ph, brix amount and acid amount values that can be titrated.

When data for fruit weight per trunk cross-section area is analysed, the effect of Pro-Ca applied with the dose of 125 ppm is spectacular as the control and 250 ppm Pro-Ca applications produced approximate results, the highest values were obtained from Pro-Ca application applied with the dose of 125 ppm. In addition to this, it was observed that no apparent differences among the applications were formed in terms of istiole, yet slightly higher values were obtained from branch bending application when compared with other applications. When the phenological parameters such as bud blistering, foliation beginning, full foliation (aftercrop formation), defoliation timing are evaluated; it is seen that the differences among the applications are related to the vertical or inclined growth of the fig

trees. In another words, Pro-Ca application has no effect on phenological differences. Because; it is seen that no apparent differences are observed between 125 and 250 ppm Pro-Ca applications, 125 and 250 ppm Pro-Ca application is combined with branch bending and similar situation exists among the applications in where only branch bending application is performed. It is further observed that there are delays of around 1 week between the 125 and 250 ppm Pro-Ca combined with branch bending and only branch bending application; control, 125 and 250 ppm Pro-Ca applications. Again by means of a different explanation, it is observed that there are delays of 1 week in the fig trees with inclined growth when compared with the ones with vertical growth. As a conclusion, attempting of Pro-Ca with frequent intervals with the doses ranging from 125 and 250 is important in terms of obtaining different results. In the event of planting the trees with the intrarow and above-row and distances among each other to be 1.5 and 2.0 meters in a manner not prevent each other in the following periods, scrutinizing the yield values per decare is benefited accordingly.

### **References**

- Ağca Z. (2008). Effect of Pro-ca (Prohexadione-Calcium) application on tree growth and fruit characteristics in some dwarf fruit species. Kahramanmaraş Sütçü İmam University, Institute of Science, Department of Horticulture, Master Thesis, Kahramanmaraş.
- Demirsoy H., Macit İ. (2007). Mechanism of dwarfing in fruit trees. Ondokuz Mayıs University, Journal of Agriculture Faculty, 22(2):214-218.
- Faust M. (1989). Physiology of temperate zone fruit trees. John Wiley& Sons, NewYork, 338 s.
- Glenn D.M., Miller S.S. (2005). Effects of apogee on growth and whole-canopy photosynthesis in spur 'delicious' apple trees. HortScience, 40(2): 397-400.
- Hekimci B. (2013). Effect of different applications on dwarfing of fig nursery trees (*Ficus carica* cv. "Bursa black") seedling Adnan Menderes University, Institute of Science Department of Horticulture, Master Thesis. Aydın.
- Özçağırın R. (1974). Physiological relationships between rootstock and scion in fruit trees. Ege University, Faculty of Agriculture Publications No:243, Bornova, p:45.
- Smith M., Meintjes J.J., Jacobs G., Stassen P.J.C., Theron K.I. (2005). Shoot growth control of pear trees (*Pyrus communis* L.) with prohexadione-calcium. Scientia Horticulturae, 106: 515-529.
- Webster A.D. (1995). Rootstock and interstock effects on deciduous fruit tree vigour, precocity, and yield productivity. New Zealand Journal of Crop and Horticultural Science, Vol. 23: 273-382.

## **DETERMINATION OF DEVELOPMENT STATES IN AYDIN REGION OF SOME APRICOT SPECIES**

H Güner SEFEROĞLU\*, Ayşe Merve ARDIÇ

Adnan Menderes University, Faculty of Agriculture, Department of Horticulture, AYDIN, Turkey

\*Corresponding author: gseferoglu@adu.edu.tr

### **Abstract**

This study was conducted in 2012 and 2013 at the newly established fruit collection garden belonging to Adnan Menderes University Department of Horticulture, in order to determine the earliness and development performances of four domestic and foreign apricot species in the ecological conditions of Aydin. In the study, in addition to evaluating the phenological observations and morphological measurements of the species, it was tried to determine the necessity of chilling of Zaza species. There were differences in the phenological observations in both trial years. When morphological measurements were evaluated, it was seen that Iğdır (Aprikoz) and Roxana gave positive outcomes in both years. The chilling durations of the Zaza species were determined to be 697 cold unit value in 2012 and 685 cold unit value in 2013. Zaza was the earliest blossomed species, and Roxana was the species that needs chilling most, so it was the latest coming up species. This study will shed light on the coming years in terms of adaptation of the species tested in the light of the obtained data.

**Key words:** Chilling, apricot, adaptation, phenology, morphology

### **Introduction**

Fruit species can adapt to different ecological conditions. Particularly in countries and regions with similar ecologies, conducting of adaptation studies has been the primary research topic. This is even more important for apricots. Such that; the fact that the apricot, which has serious problems in terms of ecological adaptation ability among the fruit species, has only a few species that can completely adapt to every ecology and its other species cause serious problems was accepted as the most significant indicator of this situation (Gülcan, 1993). It is reported that in the regions where spring frosts are rare or not seen at all, it is possible to cultivate early ripe apricots easily. Countries such as Spain, Italy, France and Greece, which are neighboring to the Mediterranean, can generate significant income by selling the apricots they harvested by the end of May to foreign countries, making good use of their ecological advantages (Asma, 2000). The Aegean Region is an appropriate region for growing early and table apricots. The most important problems in this region are that there is low need for chilling and the absence of quality species suitable for transportation (Özkarakaş and Ercan, 2004). Although our country has much bigger advantages, it is not in a good position to produce and sell table apricots. However, in recent years, many adaptation studies have been conducted with early table apricot species in Mediterranean and Aegean regions (Yarılgaç and Kazankaya, 2002). Despite the large number of apricot species adapted to different ecological characteristics, the fact that many of them are evaluated as dried fruits, the table species are not put on markets outside the cultivation regions, reasons such as problems of cold chain and transportation expenses causes the need for cultivating some species with high market value in different regions of the country. The average duration of chilling in Aydin province is 1180 hours. In general, when the apricot-chilling needs are examined, it is seen that this duration varied between 550 - 1600 hours depending on the species. Considering the need for chilling,



the species to be used in the study are shown in Table 1. In choosing the species to be tested, besides the need for chilling, attention was paid to the presence of the species with high economic value, which can be put on markets in different times (Asma, 2000).

Table 1. Species used in the study and the chilling needs

Species	Chilling Need (hour)
Tyrinthe	445 – 520
Roxana	790 – 1005
Iğdir	800 – 975
Zaza	to be determined in the study

In the study, Aydin, Roxana, Zaza and Tyrinthe species, some of the important table apricot species, were used and their adaptability to Aydin ecological conditions and development performances were tested using 2 aged seedlings over wild rootstocks. In addition, the chilling time of the Zaza species, the chilling need is not exactly known, has been tried to be determined.

### Material and Method

The study was carried out at the fruit collection garden (37°45'44.7"N 27°45'27.0"E) of the Adnan Menderes University, the Faculty of Agriculture, Department of Horticulture.

In the study included 2 aged, Iğdir (Aprikoz), Zaza, Roxana and Prececo de Tyrinhte species with high table value, which were implanted on the wild apricot rootstock planted in the faculty collection garden in 2011-2012.

Onset Hobo data recorder device was used to record the meteorological data required for the calculation of the chilling requirement. The obtained meteorological data were evaluated by being processed with Onset Hobo Ware Pro software.

The climate chamber was used to determine the chilling needs of the Zaza species and to enable observation of the scions from the trees under controlled conditions. The climate chamber was kept constant at 24°C temperature and 80% humidity throughout the trial.

Accidental parcels were carried out according to the trial pattern. Each species included in the trial was set in a way to be 3 repetitions and 3 seedlings in each repetition.

In the trial, the seedling developments were investigated through the phenological and morphological observations. In addition, the need for chilling of the Zaza species, for which the need for cold weather is not known yet, has been tried to be determined by measurements made during 2 vegetation periods. The phenological observations of bud swell, bud bursting, flowering inception, full flowering, flowering end and defoliation were performed in the study. The phenological observations during the two vegetation periods in 2012-2013 were performed according to the criteria below stated by Özvardar et al. (1991).



Figure 1. Bud swell, coming up, flowering inception and full flowering in the phenologic observations of Zaza species

The shoot length and shoot diameter, stem diameter, petal height measurements and petal area calculations were made for each seedling included in the trial. The morphological

developments of the seedlings were determined by measurements made at the beginning and end of vegetation.

The vegetative period has been evaluated as the period from coming up of the buds to the defoliation (Guerriero and Watkins, 1984). For the Zaza species, the standard method and the Utah chilling unit (cold unit) method were used to calculate the chilling requirement.

The trial was established according to randomized trial pattern and carried out in 3 replications. In all species, the average of 3 trees was considered as a recurrence. The LSD values were used to compare the mean values of the data obtained at the trial.

### Results and discussion

In the period of 2012-2013, the species began to rest on 25.11.2012, and the date of 13.02.2013 was determined as the cease of resting, when 50% of coming up was observed in scions kept under observation in the climate room. In the period of 2013-2014, the beginning of resting period was determined to be 08.12.2013 and the cease of the resting period was determined to be 05.02.2014. The resting in the period of 2012-2013 in scions planted to the perlite environment ceased on the date of 13.02.2014. The rest in the scions observed in 2013-2014 ceased in the scions taken on 05.02.2014, and 50% bud coming up among all scions was seen on 20.02.2014 in the scions in this group.

Table 2. Phenolic observations in 2012

	Zaza	Iğdır	Roxana	Thyrinthe
Bud Swell	28.02 – 01.03	03.03 – 04.03	15.03 – 16.03	08.03 – 09.03
Bud Coming Up	06.03 – 08.03	09.03 – 11.03	19.3 -20.03	12.03 – 13.03
Foliation	15.03 – 17.03	18.03 – 19.03	23.03 – 24.03	19.03 – 20.03
Complete Flowering	-----	-----	-----	-----
End of Flowering	-----	-----	-----	-----
Harvest	-----	-----	-----	-----
Defoliation	31.12.2012 01.01.2013	03.01-04.01 2013	18.12 – 20.12	25.12 – 27.12
Bud Swell	28.02 – 01.03	03.03 – 04.03	15.03 – 16.03	08.03 – 09.03

Table 3. Phenolic observations in 2013

	Zaza	Iğdır	Roxana	Thyrinthe
Bud Swell	15.02-18.02	17.02–19.02	28.02–01.03	04.03–05.03
Bud Coming Up	22.02–24.02	25.02-27.02	10.03-12.03	14.03–15.03
Flowering Inception	03.03-05.03	05.03–06.03	14.03–15.03	-----
Complete Flowering	07.03-09.03	09.03–11.03	19.03–20.03	-----
End of Flowering	10.03–13.03	14.03–15.03	25.03–26.03	-----
Harvest	20.05.2013	30.05.2013	18.06-19.06	-----
Defoliation	06.12-08.12	12.12–14.12	03.12–05.12	10.12–12.12
Bud Swell	15.02-18.02	17.02–19.02	28.02–01.03	04.03–05.03

Table 4. Shoot length development in 2012-2013 (cm)

Species	Shoot length development (cm)	
	2012	2013
Iğdır	40.344 bc	57.829 ab
Zaza	67.167 b	31.231 c
Roxana	111.854 a	63.525 a
Tyrinthe	42.625 c	42.625 bc
LSD (%5)	23.407**	17.295**

n.i=not important \* : p= 0.05 important \*\* : p= 0.01 important

Table 5. Shoot diameter development in 2012-2013 (mm)

Species	Shoot diameter development (mm)	
	2012	2013
Iğdır	4.391 a	6.877
Zaza	3.250 b	6.062
Roxana	5.023 a	8.535
Tyrinthe	1.987 c	4.755
LSD(%5)	0.884**	2.700 (n.i)

n.i: not important \* : p= 0.05 important \*\* : p= 0.01 important

Table 6. Stem diameter development in 2012-2013 (mm)

Species	Stem diameter development (mm)	
	2012	2013
Iğdır	23.507 a	36.345
Zaza	19.553 ab	29.690
Roxana	18.355 b	31.032
Tyrinthe	12.687 c	28.747
LSD (%5)	4.672**	16.751 (n.i)

n.i: not important \* : p= 0.05 important \*\* : p= 0.01 important

Table 7. Petal height development in 2012-2013 (cm)

Species	Petal height development (cm)	
	2012	2013
Iğdır	206.333 a	330.000 a
Zaza	150.083 c	298.333 b
Roxana	176.167 b	280.000 bc
Tyrinthe	137.500 c	265.000 c
LSD (%5)	20.905**	23.104**

n.i: not important \* : p= 0.05 important \*\* : p= 0.01 important

Table 8. Petal area averages in 2012-2013 (m<sup>2</sup>)

Species	Petal Area (m <sup>2</sup> )	
	2012	2013
Iğdır	0.932 b	3.621
Zaza	0.477 b	3.165
Roxana	1.700 a	5.144
Tyrinthe	0.552 b	2.316
LSD (%5)	0.709**	2.592 (n.i)

## Findings about Determining the Chilling Requirement of the Zaza Species



Figure 2. Stages of coming up of the steels in the perlite environment

Table 9. Chilling periods calculated for the Zaza species

Measurement period	Standard Method	Utah Method
2012–2013	386 hours [ 25.12.2012 16.02.2013 ]	697 cold units [ 25.12.2012 13.02.2013 ]
2013–2014	677 hours [ 08.12.2013 14.02.2014 ]	685 cold units [ 08.12.2013 05.02.2014 ]

## Conclusion

Based on the data obtained as a result of this adaptation study carried out in Aydın province for two years; it was determined as a result of the statistical analyses, that the development performance of the Precoce De Tyrinthe species was lower than the other species when they are analyzed in terms of morphological characteristics. According to the averages of the measurements of petal height, petal area and the stem diameter under first branch, the morphological measurement criteria, the petal width development brought up the rear in both trial years. In the second year of the trial, it was observed that no flowering observed in Precoce De Tyrinthe as mentioned above, while flowering and even fruit set are observed in other species. The Roxana species gave more positive results in terms of morphological criteria than Zaza and Precoce De Tyrinthe species. Roxana attained the highest values in both trials years in terms of shoot length development, shoot diameter development and petal area development compared to other species included in the trial and took place on the top. It was the species that got out of the resting period due to having the highest chilling period. It entered the resting period much earlier than the other species. The average flowering time is 11 days. Since the duration of the chilling is higher than the other species, it can be considered as an important species for the region in terms of continuity in the market due to the late harvesting time. As is the case with the Roxane species the morphological measurement results of the Iğdir (Aprikozu) species have yielded positive results. It took place on the top in terms of the stem diameter under first branch, stem cross-sectional area and petal height in both years. Although it was in third place in the development of petal width during his first trial year, it took first place in the second trial year. The average flowering time is 9 days. Its coming up and flowering processes were more homogenous than other species. It is more likely than other species to reach the age of yield earlier and to be a valid species for our

region due to the fact that its fruits are large, taste and high in attraction. The Zaza species, which has not yet been registered and about the characteristics of which no data has been obtained yet, has provided a great advantage to our region in terms of earliness. However, when examined from the point of view of morphological characteristics, it is thought that the results over which clear interpretations can be made could not be obtained in the data belonging to both years. It was the species that came up the earliest in both trial years. The flowering period was more gradual compared to other species. The average flowering time was 7-8 days. The fruits were ready for harvesting in the last week of May. As a result of the calculation of the chilling period, the values of 386 hours and 697 cold units were found for the first year for the first, and the values of 677 hours and 685 cold units were found for the second year. Comparing the two methods, it is thought that the cold unit method has reached a more accurate result. It can be said that it is a promising species for the region in terms of earliness. In a subject that requires long years of work, such as adaptation, the results of two years of data should not be viewed with certainty. For this reason, it seems that such studies should be carried out in a wider scope in terms of time. It attracts attention that this kind of studies are more important especially when our region is less affected by late spring frosts and this advantage is considered to be the potential of providing early table apricot products to the market. In conclusion, the data are open to discussion at a given point since the varieties used in the trial cover a period in which they do not undergo complete yield. Therefore, by expanding these types of studies, health and affordability of the species suitable for Aydın ecology will be examined.

### **References**

- Asma B.M. (2000). *Apricot Cultivation*, 243 s. Malatya
- Guerriero R., Watkins R. (1984). Revised descriptor list for apricot (*Prunus armeniaca* L.) international board for plant genetic resources Rome, Italy.
- Gülcan R. (1993). Problems and solutions in apricot cultivation. Malatya Apricot Problems Panel, 5-11.
- Özkarakaş İ., Ercan N. (2004). Evaluation of some apricot (*P. armeniaca* L.) genetic resources material collected from Southeastern Anatolia region and their adaptation to Aegean region. *Anatolia, J. of AARI* 14 (1):1-15.
- Özvardar S., Önal K., Baldiran E. (1991). Selection of apricot species suitable for the Aegean Region. *Anatolian J. of AARI*, 1 (2): 36-52.
- Yarılgaç T., Kazankaya A. (2002). Investigations on the Adaptation of Some Apricot Species in Van Ecology. *KSU Science and Engineering Journal*. 5(1): 131-139.

## **CORRELATION BETWEEN SESAME YIELD AND YIELD PARAMETERS**

Servet ABRAK<sup>1\*</sup> Ahmet YILMAZ<sup>2</sup>

<sup>1\*</sup>GAP Agricultural Research Institute Directorate, Şanlıurfa, Turkey

<sup>2</sup>University of Harran, Faculty of Agriculture, Department of Field Crops, Şanlıurfa, Turkey

\*Corresponding author: servetabrak63@hotmail.com

### **Abstract**

This research was carried out in order to determine the correlation (that resulted from the applications of different sowing time and plant densities) between yield and yield components of second crop sesame under semi-arid climate conditions at the GAP Agricultural Research Institute Talat Demirören Research Station in Şanlıurfa province in 2015-2016 growing seasons. The parameters examined were: the number of capsules per plant, number of branches per plant, number of seeds per capsule, plant height, first capsule height, seed yield, protein ratio, oil ratio, oil yield and thousand seed weight. According to the findings of combined correlation analysis of two year; positive and significant relationships were identified between the number of capsules per plant and number of branches per plant, between number of seeds per capsule and plant height, between first capsule height and plant height, between thousand seed weight and plant height, number of branches per plant, between seed yield and plant height, thousand seed weight, between protein ratio and number of capsules per plant, number of seeds per capsule, first capsule height, and between oil ratio and thousand seed weight, seed yield, respectively. Negative and significant relationships were identified between the number of capsules per plant and plant height, between number of seeds per capsule and number of branches per plant, between thousand seed weight and first capsule height, between seed yield and number of capsules per plant. On the other hand, no correlation was found between seed yield and number of seeds per capsule, between number of seeds per capsule and number of branches per plant. According to the results of two years, the highest seed yield was obtained from the 35x5 cm planting density on June 15 with 143.42 kg/da, and the lowest seed yield was obtained from the 70x20 cm planting density on July 1 with 72.50 kg/da.

**Keywords:** *Sowing time, Plant density, Correlation, Yield, Yield parameters*

### **Introduction**

Sesame is an annual and herbaceous plant and can be grown easily in tropical-subtropical climate zones and micro-climate regions (2700-3500 °C). It can grow up to 80-180 cm in length, 40-50 cm in depth. The stems are flat and cornered. In the two carpels subspecies the stem is 4 corners, in the four carpels subspecies the stem is 6 or 8 corners. In normal sesame plant, the stem is angular, while in four carpel subspecies the stem is flattened at various grades and the flattening increases towards the tip of the stem (İlisulu, 1973). The world's sesame planting area is estimated 10.8 million hectares, production of 6.2 million tons and yield of 576 kg/ha (Anonymous, 2014). The total cultivation area of oilseed plants in Turkey is 1.36 million hectares and the production amount are 3 million 442 thousand tons (Anonymous, 2015). The reason for the low yields in sesame cultivation is that the necessary agricultural requirements (planting, cultural and chemical combat, certified seed use, irrigation, harvesting-threshing etc.) are not fulfilled and the agricultural characteristics of the grown seed are unknown. In order to make sesame growing more attractive, it is utmost

importance to determine the important parameters that contribute to breeding work and to put them together in the new sesame varieties to be improved. At the same time, high yields can only be achieved of sesame species and ecotypes that are currently being cultivated by determining the parameters that make up the yield and by accessing the agricultural activities to be applied. In the second crop sesame cultivation, it is considered that the relations between the yield and some yield parameters are determined and that they contribute to the solution of the bottlenecks for sesame cultivation which are cultivated in limited areas.

### Material and Methods

This research was planned and carried out in order to determine the effects of different planting times and plant densities on yield and yield components of second crop sesame (*Sesamum indicum* L.) under semi-arid climate conditions in Harran Plain at the Talat Demirören Research Station, which affiliated to GAP Agricultural Research Institute in Şanlıurfa province in 2015 and 2016 years. Arslanbey sesame variety which was bred for GAP Region in 2010 were used as material and the trial was carried out according to randomized blocks split split plots experimental design with 3 replications. In the trial, the main parcels were consisted of planting times (1 June, 15 June and 1 July), sub-parcels were divided into 2 different inter-row spaces (35 and 70 cm), and 4 sub-sub plots were divided into 4 different intra-row spaces (5, 10, 15 and 20 cm). The parcel area was arranged as 16.8 m<sup>2</sup> (6x0.7x4) for inter row spaces of 70 cm, 8.4 m<sup>2</sup> (6x0.35x4) for inter row spaces of 35 cm. The parcel lengths were 6 m. 3 m spaces between main parcels, 1 m between sub-parcels and 3 m between blocks were established. The research station where the experiment was conducted is at 36° 42' North latitude, 38° 58' East longitude and 410 m high from the sea level (Anonymous, 2003).

Soil specimens from 0-30, 30-60 and 60-90 cm deep were blended to represent the soil properties of the trial areas. The samples obtained were analyzed in the Soil Analysis Laboratory, which is located within the GAP Agricultural Research Institute (Turkey).

Table 1: Physical and chemical properties of experimental soil

Soil Depth (cm)	Structure	Volume weight (g/cm <sup>3</sup> )	Field Capacity (PW %)	Wilting Point (PW %)	Water Saturation (%)	EC (ds/m)	Lime (%)	pH	Phosphorus (kg/da)	Potassium (kg/da)	Organic Matter
0-30	Clayey	1.25	33.44	21.64	70	0.83	24.7	7.8	4.20	193.2	2.19
30-60	Clayey	1.30	32.34	21.99	64	0.99	24.7	7.8	3.13	180.6	1.78
60-90	Clayey	1.35	34.38	22.75	55	0.99	24.3	7.7	2.50	175.3	1.32

According to the analysis result; it was found that although the sample of the experimental site was taken from different depths, it was found to be the same in terms of lime and pH contents, and as the soil depth increases the phosphorus, potassium, organic matter and water saturation capacity decreased and EC value increased.

Table 2: Average, highest and lowest climatic values in long years (1950-2016)

<b>Şanlıurfa</b>	<b>1</b>	<b>2</b>	<b>3</b>	<b>4</b>	<b>5</b>	<b>6</b>	<b>7</b>	<b>8</b>	<b>9</b>	<b>10</b>	<b>11</b>	<b>12</b>
Average Temperature (°C)	5.6	6.9	10.9	16.2	22.1	28.1	31.9	31.3	26.8	20.1	12.6	7.5
Average Maximum Temperature (°C)	10.0	11.9	16.5	22.3	28.6	34.6	38.7	38.3	33.8	26.9	18.5	11.9
Average Minimum Temperature (°C)	2.2	2.9	6.0	10.5	15.4	20.7	24.3	24.0	20.0	14.6	8.4	4.1
Average Relative Humidity (%)	70.4	67.1	60.7	56.7	45.4	33.2	30.5	33.3	36.0	46.4	60.2	70.4
Monthly Average Total Rainfall (kg/m <sup>2</sup> )	84.8	70.5	65.9	49.6	29.4	4.0	0.6	0.8	2.9	25.3	46.0	79.6

1: January 2: February 3: March 4: April 5: May 6: June 7: July 8: August 9: September 10: October 11: November 12: December

Table 3: Average, highest and lowest climatic values in 2015

<b>Talat Demirören</b>	<b>1</b>	<b>2</b>	<b>3</b>	<b>4</b>	<b>5</b>	<b>6</b>	<b>7</b>	<b>8</b>	<b>9</b>	<b>10</b>	<b>11</b>	<b>12</b>
Average Temperature (°C)	6.3	8.2	11.7	19.6	22.9	28.7	31.1	30.2	27.7	21.3	13.2	7.9
Highest Temperature (°C)	17.1	17.2	24.1	31.2	35.9	37.8	41.4	40.5	37	32.9	23.7	18.4
Lowest Temperature (°C)	-3.8	0	-0.1	3.9	10	14.6	17.7	17.8	15.2	10.2	1.8	-0.9
Average Relative Humidity (%)	76.4	67.8	56.7	44.7	44.4	35.3	39.7	50.2	50.7	57.1	53.0	57.6
Monthly Average Total Rainfall (kg/m <sup>2</sup> )	29.0	50.8	87.4	17.5	7.4	2.0	0	0	0	22.4	10.4	6.5

Table 4: Average, highest and lowest climatic values in 2016

<b>Talat Demirören</b>	<b>1</b>	<b>2</b>	<b>3</b>	<b>4</b>	<b>5</b>	<b>6</b>	<b>7</b>	<b>8</b>	<b>9</b>	<b>10</b>	<b>11</b>	<b>12</b>
Average Temperature (°C)	5.03	11.3	13.2	15.5	22.6	27.1	30.6	29.1	26.9	20.8	14.0	7.0
Highest Temperature (°C)	13.3	24.6	23.1	30.3	34.4	36.0	40.2	39.2	36.2	31.0	22.4	18.0
Lowest Temperature (°C)	-7.9	-0.9	0.8	3.2	9.3	13.1	15.4	16.2	14.0	9.2	1.7	-0.8
Average Relative Humidity (%)	75.7	78.5	68.7	60.1	45.0	42.1	40.5	53.8	48.1	60.0	56.8	55.6
Monthly Average Total Rainfall (kg/m <sup>2</sup> )	75.8	24.2	16.6	28.7	16.4	0	0	0	1.0	15.8	26.4	63.8

Mediterranean climate is dominant in the area where the experiment was conducted and drought was observed between June and October. In the second crop of sesame growing season; the highest temperature for 2015 was observed in July with 41.4 °C and the average temperature in October with 10.2 °C. The highest temperature for 2016 was measured in July with 40.2 °C, the lowest temperature in October with 9.2 °C. During the sesame growing season (June-October), it is understood that the monthly temperature values for year 2015 are relatively higher than the year 2016 (Table 2). Monthly average relative humidity values for year 2015 are relatively low in the sesame growing season (June-October) of 2016 (Table 3), while monthly average relative humidity values for long years are observed to be low



compared to the years when the experiment was conducted. Almost no rainfall was detected during the sesame growing season (June-October) and the total rainfall amounts for the years 2015, 2016 and long years were 233.4, 268.7 and 459.4 mm, respectively. In recent years, precipitation has decreased by almost half compared to long years, that affecting agricultural production areas and causing yield reductions.

### Results and Discussion

Relations (correlation) between the yield and yield components of the second crop sesame were identified. The various correlation between yield and yield parameters were studied are given in the following.

Table 5. Correlation between yield and yield parameters (Combined)

	1	2	3	4	5	6	7	8	9	10
1	1									
2	-0.1375	1								
3	-0.2910**	0.2094*	1							
4	0.2801**	-0.2740**	0.0551	1						
5	0.3101**	-0.5891**	-0.0842	0.0354	1					
6	0.3514**	0.3718**	-0.1058	0.1804*	-0.4302**	1				
7	0.1644*	0.1109	-0.1961**	-0.0115	-0.1077	0.3220**	1			
8	-0.056	-0.3274**	0.1828*	0.2807**	0.1965*	0.0526	-0.0056	1		
9	0.0716	-0.0546	-0.2236**	0.1398	-0.1930*	0.2640**	0.3016**	0.0005	1	
10	0.1557	0.0832	-0.2317**	0.0233	-0.1506	0.3532**	0.9644**	0.0027	0.5384**	1

1:Plant height 2:Number of branches per plant 3:Number of capsules per plant 4:Number of seeds per capsule 5:First capsule height 6:Thousand seed weight 7:Seed yield 8:Protein ratio 9:Oil ratio 10:Oil Yield

According to the correlation analysis, the relationships between yield and yield parameters were determined by Shim et al. (2006), Sumathi et al. (2007), Gnanasekaran et al. (2008), and Ramazani (2016) found to be parallel to the findings obtained from the research.

### Conclusions

Increases in plant density and early planting can cause an increase in plant height, and thus appear to be a factor that increases the yield to a certain point. When Sesame is planted densely, the little branching appears. The Arslanbey sesame variety, which is forming 2-3 branches, is characterized as a medium branch, and it can also has branches 2 and 3 on side branches. The one thousand weight, one of the basic components of yield, may show an upward trend in early planting. Although the increases the plant density per the unit area decreases the number of capsules per plant but increases the total number of capsules and seeds per unit area. Thousand seed weight and total number of capsules and seeds per unit area were found to be an important factor in increasing yield. Positive and important relationships were determined between seed yield and plant height, thousand seed weight.

## References

- Anonymous, (2003). Village Services Şanlıurfa Research Institute. Şanlıurfa.
- Anonymous, (2014). Food and Agriculture Organization of the United Nations. <http://www.fao.org/faostat/en/#data/QC>.
- Anonymous, (2015). Turkish Statistical Institute. <https://biruni.tuik.gov.tr/bitkiselapp/bitkisel.zul>.
- Gnanasekaran, M., Jebaraj, S. and Muthuramu, S., (2008). Correlation and Path Co-efficient Analysis in Sesame (*Sesamum indicum* L.). *Plant Archives*, 8(1): 167-169.
- İlisulu, K., (1973). *Oil Crops and Breeding*, Çağlayan Bookstore, 366s, İstanbul.
- Ramazani, S., (2016). Surveying the Relations Among Traits Affecting Seed Yield in Sesame (*Sesamum indicum* L.). *Journal of Crop Science & Biotechnology*, 19(4), 303. Doi:10.1007/S12892-016-0053-0.
- Shim, K., Kang, C., Seong, J., Hwang, C., and Suh, D., (2006). Interpretation of Relationship Between Sesame Yield and Its Components under Early Sowing Cropping Condition. *Korean Journal of Crop Science*, 51(4): 269-273.
- Sumathi, P., Muralidharan, V., and Manivannan, N., (2007). Trait Association and Path Coefficient Analysis for Yield and Yield Attributing Traits in Sesame (*Sesamum indicum* L.). *Madras Agricultural Journal*, 94(7/12): 174-178.

## **CORRELATION OF PRECIPITATION WITH YIELD GRAIN AND VARIABILITY OF MAIZE PRODUCTION OF REPUBLIC OF SRPSKA (BOSNIA AND HERZEGOVINA)**

Goran OSTIĆ<sup>1</sup>, Novo PRŽULJ<sup>2</sup>, Slavko RADANOVIĆ<sup>1</sup>, Dejan SIMIĆ<sup>1</sup>, Dejan SUPIĆ<sup>3</sup>,  
Miroslav ŠTRBAC<sup>1</sup>

<sup>1</sup>Public Institution Agricultural Institute of Republic of Srpska, Banja Luka, Bosnia and Herzegovina

<sup>2</sup>Faculty of Agriculture, Universities of Banja Luka and East Sarajevo, Bosnia and Herzegovina

<sup>3</sup>Republic Hydrometeorological Institute, Banja Luka, Bosnia and Herzegovina

\*Corresponding author: goran.ostic@gmail.com

### **Abstract**

During the period from 2000 to 2016 the corn yield in the Entity of Republic of Srpska (RS) in Bosnia and Herzegovina varied, both by years and by individual production regions. According to data from the Institute of Statistics of Republic of Srpska, the lowest yield was 1,96 t/ha<sup>-1</sup> in the production area of Banja Luka in 2003, and the highest in 2016 in Novi Grad 6,76 t/ha<sup>-1</sup>. Numerous factors have the influence on the maize grain yield. The maize producers can not affect the climate conditions, from which the achievement of yields greatly depends. It is particularly reflected in the drought years. By using data of the distribution and amount of rainfall for the six municipalities in RS, correlation coefficients of precipitation and maize grain yield were calculated by Hartung. It was found that the good and positive correlation value was manifested near Bijeljina for the period July-August (0,749), and in the average for all places in the same period (0,709) and production year (0,711). The maximum value of the correlation of monthly precipitation was recorded in August (0,683), which was manifested in the drought years (0,789). By a comparison of the obtained results, it was noted that in the dry years the coefficient was adequately lower for production-year and July-August rainfall and also higher in August and during the interval from January to March. It can be concluded that the precipitations before and during fertilization had the greatest impact on the achievement of maize grain yield, as well as on the formation and initial maize grain filling.

**Keywords:** *maize, yield, precipitation, correlation, Republic of Srpska.*

### **Introduction**

During the period from 2000 to 2016 the maize yield in the Entity of Republic of Srpska (RS) in Bosnia and Herzegovina varied, both by years and by individual production regions. The lowest yields were 1,96 t/ha<sup>-1</sup> in 2003 in the production area of Banja Luka and 1,97 t/ha<sup>-1</sup> in 2000 in Bijeljina. The highest yield was in 2016 in Novi Grad and it amounted 6,76 t/ha<sup>-1</sup> and 6,32 t/ha<sup>-1</sup> in Bijeljina. Fertility of maize is affected by numerous factors, including climatic factors, because they represent a group of industrial risks that largely determine the size of the yield (Marković and Jovanović, 2011). After floods, droughts or storms always step up discussion on the provision of crops to compensate the production losses (Breustedt, 2003). Maize producers can not affect the climatic conditions, which greatly affect the realization of yield particularly in dry years. Based on the study of climate parameters in the RS, as a dry years were recorded: 2000, 2003, 2007, 2009, 2011, 2012, 2013 and 2015, when in average lower yields were realized compared to other production year. Some authors suggest the need for expansion of the insurance market of a number of risks and weather derivatives, which represent the more recent financial instruments for risk transfer and which compensation

depends on adequate time indicators (Berg, 2002). With weather derivatives can be traded on the stock exchange or OTC, and of utmost importance is the provision of crops that have a leading part in the sowing structure and a higher level of yield per hectare (Marković and Jovanović, 2011), as is the case with maize in Republic of Srpska. The aim of this paper is to examine the impact of annual, vegetative and monthly precipitation on maize yield in the major production regions of Republic of Srpska with the application of the coefficient of correlation analysis. Of particular importance is evaluated correlation in the specific production years, such as extremely dry or wet years. Also, aim of this study was maize yield and mean month air-temperature (Kovačević et al, 2016). By knowing the value of this correlation, production basis risk decreases and increases the effect of eliminating risks with applying the time derivatives. Also, the knowledge on expression of certain climatic factors over many years in specific regions of the production has an effect on the application of the adequate growing technology (Araus et al, 2012).

### **Materials and methods**

The basic data for this study were obtained from the Republic Hydrometeorological Institute in Banja Luka and refer to the schedule and the amount of rainfall for the six production regions in the RS, during the period 2000-2016. Also, data of the Institute for Statistics of RS on actual yield of maize grain during this period of Banja Luka, Prijedor, Novi Grad, Gradiška, Doboje and Bijeljina were used. The high degree of correlation between the total amount of precipitation and the resulting crop yield assume efficient application of the weather derivatives (Vedenov and Barnett, 2004). The weather derivatives are a product of the financial markets and are usually based on the amount of rainfall or an average temperature, and they need to determine the following parameters: type of derivative, the weather index, a weather station, the weather interval and the function of the payment, which involves determining the insurance premium, the threshold level and the monetary value of index (Mußhoff et al., 2005). Evidence of damage incurred as a result of adverse events such as drought, may not be needed at time derivatives, damage assessment does not carry out and producers are prevented that their actions affect the amount of damage and adverse selection at settling damages. In comparison to classical insurance, the biggest disadvantage is the distance of the production site and the reference meteorological station (more distance is greater and differences in the amount of rainfall). The relations between the meteorological conditions and the results of maize production are determined by correlation analysis using the assumption that the yield depends directly on the amount of precipitation in the growing season of the crop, so that each of the rainfall millimeters conditions the growth, development and yield of plants (Schmitz, 2007). The coefficients of correlation were calculated according to the appropriate mathematical form by Pearson (Hartung, 1998), using the software application Excel 2010. They are related to mentioned time interval from 2000 to 2016, as well as for drought years during this period. The degree of interdependence of the independent variable (the amount of precipitation) and the dependent variable (maize yield) is expressed by values from -1 to 1, so in the area from 0,1 to 1 is the positive correlation according to which with the increase of rainfall maize yield also increases. All of the values from 0,3 to 0,7 are considered for moderate correlation, while above 0,7 imply good or full correlation (0,9 to 1). In the case of a value of 0 there is no interdependence, a value of 0 to ± 0,3 show low interdependence (Kozak et al, 2012).

## **Results and discussion**

The analysis of the interdependence of rainfall and grain yield is possible only on the basis of multiannual data. The results of the analysis in this study show that maize is the most common crop in Republic of Srpska (Ostić and Radanović, 2012) and that the yield is very variable, as is the case for the weather during the past 17 years. Average maize yield of six major regions in the RS was  $4,05 \text{ tha}^{-1}$ , with a range of  $3,29 \text{ tha}^{-1}$  in Banja Luka to  $4,44 \text{ tha}^{-1}$  in Gradiška. Highest yielding regions along Gradiška are Bijeljina ( $4,38 \text{ tha}^{-1}$ ) and Novi Grad ( $4,33 \text{ tha}^{-1}$ ), where they were registered the highest differences in the realization of yield during the studied years (tab. 1). In Bijeljina the grain yield of maize ranged from  $1,97 \text{ tha}^{-1}$  in 2000 to  $6,32 \text{ tha}^{-1}$  in 2016 (range of  $4,35 \text{ ha}^{-1}$ ), in Novi Grad with the range of  $4,13 \text{ tha}^{-1}$ , and the smallest difference was recorded in Banja Luka ( $2,73 \text{ ha}^{-1}$ ) and Prijedor ( $2,84 \text{ ha}^{-1}$ ). On average, the highest maize grain yields in these regions were achieved in 2016 ( $5,56 \text{ tha}^{-1}$ ) and 2004 ( $5,29 \text{ tha}^{-1}$ ), and the lowest in 2000 ( $2,41 \text{ tha}^{-1}$ ) and 2012. ( $2,5 \text{ tha}^{-1}$ ). The lowest annual average temperature was in 2005, with the lowest of  $10,4 \text{ °C}$  in three regions, and the highest in Bijeljina ( $11,1 \text{ °C}$ ). The highest temperatures were in 2014 and 2015, with the highest value for Gradiška ( $13,3 \text{ °C}$ ) in 2015 and the lowest in Novi Grad ( $12,3 \text{ °C}$ ) in 2014 (tab. 2). Except in Bijeljina, the largest total annual precipitation in all regions, were registered in 2014, when there were floods in Srpska (in Banja Luka  $1.686,2 \text{ mm}$ , then in Novi Grad  $1.575,4 \text{ mm}$ ), and at least 2011, and the lowest in Gradiška ( $461,8 \text{ mm}$ ) and Bijeljina ( $467,4 \text{ mm}$ ). The average annual mean monthly temperature was  $12,1 \text{ °C}$  and above this average are temperatures for Bjeljina, Gradiška ( $12,5 \text{ °C}$ ) and Banja Luka ( $12,2 \text{ °C}$ ), while the total annual average precipitation amounted to  $911,9 \text{ mm}$  and above average were in Novi Grad ( $1035,2 \text{ mm}$ ), Banja Luka ( $1030,3 \text{ mm}$ ) and Doboj ( $978 \text{ mm}$ ). The highest difference between the maximum and minimum total annual amount of rainfall during the seventeen-year interval was recorded in Banja Luka ( $1.098 \text{ mm}$ ) in 2014 and 2011, and minimum for Bijeljina ( $622,5 \text{ mm}$ ), in 2001 and 2011. Also, the study of the same climatological parameters for vegetation period of maize (tab. 3) can only confirm the kind of difference in the aridity of Bijeljina and Gradiska, in relation to, the most humid Novi Grad, then Doboj and Prijedor. Thus, the highest mean monthly temperature of the air in the growing period of maize was registered in Bjeljina ( $19,3 \text{ °C}$ ) and Gradiška ( $19,2 \text{ °C}$ ), which is  $0,6 \text{ °C}$  or  $0,5 \text{ °C}$  higher than the average for the six measurement points. The lowest average air temperature for the interval april-september was in Novi Grad ( $17,9 \text{ °C}$ ) and Doboj ( $18,3 \text{ °C}$ ). The least variation was occurred in Novi Grad ( $1,7 \text{ °C}$ ), with a difference of  $18,8 \text{ °C}$  to 2003 and  $17,1 \text{ °C}$  in 2014. The highest difference was  $2,5 \text{ °C}$  at Banja Luka, Prijedor and Gradiška, in which the highest recorded temperature was in 2012, and the lowest in 2004 (Gradiška in 2014). When one look at vegetation precipitation (Table 3) an extremely wet year 2014 can be noticed, as well as already mentioned dry year. In relatively moist year we included 2001 and 2010. The greatest precipitation on average during the growing period of maize were in Banjaluka ( $564,7 \text{ mm}$ ) and Doboj ( $562,1 \text{ mm}$ ), and the lowest precipitation in Bijeljina ( $434,9 \text{ mm}$ ), respectively Gradiška ( $430 \text{ mm}$ ), with a maximum difference of  $134,7 \text{ mm}$ . The differences are much more drastic per year for each of the studied areas. So we have the highest difference in Banja Luka ( $943,2 \text{ mm}$ ) and Doboj ( $852,2 \text{ mm}$ ), because of  $1228,4 \text{ mm}$  and  $1115,2 \text{ mm}$  in 2014 and  $285,2 \text{ mm}$  or  $263 \text{ mm}$  in 2011. The smallest differences were in Bijeljina ( $519,8 \text{ mm}$ ) and Gradiška ( $612,4 \text{ mm}$ ), which almost always have the lowest rainfall and at the same time the highest air temperatures. Such variations in climate parameters and yields indicate the need to examine the correlation among the total amount and distribution of rainfall and grain yield per individual production locations. In simple interpretation of the obtained yields of maize per year and to production regions it can be seen that the higher yields were realized in arid Bijeljina and Gradiška, wherein not been investigated differences in the type and fertility of the soil, the applied agro-

technical measures breeders, the intensity of cultivation and others. Because of the need that given correlation be precisely examined, the numerous accounting of correlation coefficient were implemented, separately for the calendar (I-XII) and the so-called production year (from October last year to September of the current year), before the vegetation period (October prior to March of the current year) and the growing period (IV-IX), as well as subperiods such as: January-Mart (I-III), April-May, April-Jun, Jun- July, July-August, July to September, August-September, and every month in the growing season (tab. 4). Good correlation value for the seventeen-year interval was manifested only in Bijeljina, in the period July-August (0,749) and in average for all places in the same period (0,709) and the production year (0,711). Apart from the abovementioned, in average the largest value of correlation was recorded for August (0,683), and the values greater than 0,5 were observed for: calendar year, vegetation period, April-May and May (tab. 4). The most significant values of the tested correlations were obtained for Doboj and for April (0,693), July-August (0,641) and the production year (0,611), this is of minor importance for the vegetation (0,548) and August (0,502), with the largest central correlations in Bijeljina. In Banja Luka, largest interdependence of rainfall and maize yields was for the production year (0,648), which is the case for Prijedor (0,604). In Gradiška this correlation coefficient was highest in July and August (0,612) and for August in Novi Grad (0,671). When one look at certain periods, the highest correlation coefficients were for the production year, July-August and August. On average, the highest values of this coefficient were obtained in Banja Luka (0,47) and Bjeljina (0,465), and the lowest for Gradiška (0,264) and Prijedor (0,357). Also, in tab. 4, one can see that in average of all six regions for dry years is very good positive correlation between rainfall and maize yield in August (0,789). Slightly lower values were obtained for the production year (0,652), the period of July-August (0,639) and from January- March (0,616). It should be noted that a very good correlation during dry years (0,842) was established in pre-vegetation period for Novi Grad, which is primarily due to precipitation in the period January-March (0,719), which is all together in a good interdependence with a total annual precipitation (0,703). On the other hand, other periods are of negligible correlation, except for August (0,594). Rainfall for January-March are the most important for achieving maize yield in almost all regions in the dry years. There are an integral part of pre-vegetation period and total annual rainfall. The period January-March is of particular importance (tab. 4) not only for Novi Grad, but also Doboj (0,758), Bijeljina (0,671) and Banja Luka (0,592).

Tab. 1. Multi-year average grain yield in maize production in six regions in RS

Year	Average grain yield (t/ha)						Average
	Banja Luka	Doboj	Gradiška	Prijedor	Novi Grad	Bijeljina	
2000.	2,28	2,61	2,54	2,42	2,63	1,97	2,41
2001.	3,16	3,96	3,76	3,39	3,61	4,44	3,72
2002.	4,07	4,66	4,70	4,28	4,39	4,60	4,45
2003.	2,24	1,96	3,02	3,24	3,11	2,54	2,68
2004.	4,06	5,62	5,97	4,80	5,04	6,25	5,29
2005.	3,97	4,08	5,81	4,53	6,13	6,04	5,09
2006.	3,52	4,93	5,33	4,83	5,85	5,82	5,05
2007.	3,28	3,18	3,08	3,08	3,09	2,91	3,10
2008.	3,14	5,48	5,87	4,51	4,84	4,18	4,67
2009.	2,34	3,41	5,38	4,48	4,49	4,80	4,15
2010.	3,41	3,94	4,86	4,91	4,96	4,63	4,45
2011.	2,35	3,28	4,17	3,30	3,07	3,67	3,31
2012.	2,16	2,83	2,56	2,07	3,06	2,34	2,50
2013.	2,32	4,29	2,68	4,04	4,43	4,78	3,76
2014.	4,52	5,33	6,02	3,82	4,18	4,93	4,80

2015.	4,23	3,52	3,68	3,54	3,88	4,12	3,83
2016.	4,89	4,84	6,12	4,43	6,76	6,32	5,56
Average	3,29	3,99	4,44	3,86	4,33	4,38	4,05

Tab. 2. Average annual mean monthly air temperature (°C) and the amount of rainfall (mm) for the six regions in the RS

Year	Mean monthly air temperature (°C)						Precipitation (mm)					
	BL	DO	GR	PR	NG*	BN	BL	DO	GR	PR	NG*	BN
2000.	12,8	12,5	13,0	12,5	-	13,0	708,2	627,3	696,7	713,1	-	481,3
2001.	11,8	11,6	12,2	11,8	-	12,0	1263,2	1427,0	988,5	956,6	-	1089,9
2002.	12,3	12,1	12,9	12,0	-	12,8	1169,0	1058,0	872,0	1102,3	-	757,6
2003.	11,8	11,5	12,3	11,6	11,8	12,2	774,9	715,6	580,7	644,9	678,5	531,1
2004.	11,4	11,1	11,8	11,0	12,2	11,9	1120,1	1147,6	871,6	989,5	1098,6	924,0
2005.	10,7	10,4	10,9	10,4	10,4	11,1	1097,5	1162,8	742,3	972,6	1258,8	921,3
2006.	11,7	11,4	11,9	11,3	11,2	12,0	1034,0	870,6	647,1	975,7	990,6	747,5
2007.	12,8	12,2	13,1	12,3	11,9	12,9	1039,7	998,7	685,2	942,6	959,1	808,4
2008.	12,8	12,4	13,2	12,5	11,9	13,1	891,8	796,2	545,4	815,1	875,0	600,9
2009.	12,7	12,0	13,0	12,5	11,8	12,8	986,0	945,6	592,8	822,9	944,0	771,3
2010.	11,6	11,4	11,9	11,5	10,8	11,8	1395,8	1333,0	1037,0	1196,5	1318,3	1026,5
2011.	12,2	11,8	12,6	11,9	11,3	12,0	588,2	504,1	461,8	490,6	590,0	467,4
2012.	12,7	12,3	13,1	12,4	11,7	13,0	941,5	813,7	836,3	741,1	929,5	567,8
2013.	12,3	12,0	12,2	12,1	11,3	12,6	892,2	864,9	759,3	844,1	1059,6	702,4
2014.	13,0	12,7	13,0	13,0	12,3	13,0	1686,2	1494,5	1254,6	1463,4	1575,4	1016,7
2015.	12,7	12,5	13,3	12,1	11,7	13,1	868,3	906,2	1009,0	1022,4	1106,9	858,2
2016.	12,4	12,2	12,6	12,0	11,6	12,7	1058,3	959,6	938,8	1001,9	1108,6	839,4
Aver.	12,2	11,9	12,5	11,9	11,6	12,5	1030,3	978,0	783,5	873,3	1035,2	771,3

\* There is no recorded data in the Republic Hydrometeorological Institute of RS for Novi Grad 2000-2002

Tab. 3. The average mean monthly air temperature (°C) and the amount of rainfall (mm) in the vegetation period of maize for the six regions in the RS

Year	Mean monthly air temperature (°C)						Precipitation (mm)					
	BL	DO	GR	PR	NG*	BN	BL	DO	GR	PR	NG*	BN
2000.	19,1	18,7	19,6	19,1	-	19,9	326,1	326,3	353,6	301,3	-	228,6
2001.	17,6	17,3	18,4	17,8	-	18,2	752,3	964,1	617,0	557,9	-	766,5
2002.	18,0	17,9	19,2	17,9	-	19,0	753,7	670,7	588,1	744,6	-	418,8
2003.	19,5	19,1	20,5	19,5	18,8	20,3	360,1	328,4	283,2	281,0	270,8	211,9
2004.	17,5	17,3	18,6	17,3	17,9	18,2	594,4	702,0	458,8	516,7	583,5	538,0
2005.	17,6	17,4	17,9	17,5	17,3	18,3	629,6	752,8	400,7	551,6	709,5	584,7
2006.	18,0	17,7	18,5	17,9	17,4	18,9	720,6	572,3	396,7	656,9	629,0	458,5
2007.	19,3	18,6	19,9	18,8	18,0	19,6	434,1	452,9	297,3	499,9	405,7	337,6
2008.	18,7	18,2	19,4	18,5	17,6	19,2	469,6	453,1	294,2	380,9	365,9	363,8
2009.	19,6	18,8	20,2	19,5	18,5	20,1	456,1	398,8	229,2	335,1	381,5	278,4
2010.	18,2	17,8	18,9	18,2	17,2	18,7	803,0	836,9	606,6	700,0	723,3	612,3
2011.	19,5	19,2	20,3	19,3	18,2	19,8	285,2	263,0	274,2	303,2	348,9	266,7
2012.	20,0	19,6	20,5	19,8	18,5	20,6	487,6	407,4	435,7	367,2	483,6	282,3
2013.	18,9	18,3	18,8	18,9	17,6	19,1	370,2	400,2	278,9	343,7	397,1	372,1
2014.	18,0	17,7	18,0	18,2	17,1	18,5	1228,4	1115,2	841,6	967,7	1039,6	731,7
2015.	19,6	18,8	19,2	19,1	18,4	20,1	350,5	393,7	453,6	500,4	566,1	469,7
2016.	18,8	18,5	19,3	18,5	17,9	19,2	578,2	518,5	500,1	482,5	554,2	472,0
Aver.	18,7	18,3	19,2	18,6	17,9	19,3	564,7	562,1	430,0	499,4	532,8	434,9

\* There is no recorded data in the Republic Hydrometeorological Institute of RS for Novi Grad 2000-2002

Tab. 4. The coefficient of correlation (r) of maize yield and rainfall for the six regions in the RS for the period 2000-2016 or 2003-2016 for the Novi Grad and dry years during the seventeen-year intervals.

Period	Coefficient of correlation (r) 2000-2016							Coefficient of correlation (r) for dry years						
	BL	DO	GR	PR	NG*	BN	Aver.	BL	DO	GR	PR	NG*	BN	Aver.
Calendar Y.	0,599	0,403	0,196	0,449	0,460	0,596	0,555	0,271	0,377	-0,353	0,254	0,622	-0,147	0,473
Product. Y.	0,648	0,611	0,390	0,604	0,542	0,589	0,711	0,643	0,681	-0,436	0,528	0,703	0,465	0,652
Growing P.	0,588	0,548	0,344	0,401	0,391	0,578	0,561	-0,08	0,346	-0,583	0,022	0,184	-0,299	0,278
Before gr.	0,237	0,203	0,207	0,577	0,579	0,226	0,452	0,125	0,461	-0,262	0,587	0,842	-0,068	0,443
∑ I-III	0,491	0,156	0,123	0,451	0,549	0,548	0,482	0,592	0,758	-0,421	0,513	0,719	0,671	0,616
∑ IV-V	0,497	0,187	0,150	0,293	0,398	0,379	0,587	-0,054	0,348	-0,444	-0,315	0,367	0,166	-0,078
∑ IV-V-VI	0,518	0,381	0,178	0,420	0,430	0,548	0,485	-0,025	0,343	-0,361	-0,051	0,396	0,332	0,100
∑ VII-VIII	0,578	0,641	0,612	0,484	0,485	0,749	0,709	-0,386	0,055	0,372	0,533	0,268	0,392	0,639
∑ VII-IX	0,595	0,483	0,394	0,224	0,265	0,535	0,326	-0,016	-0,013	-0,282	0,094	-0,133	0,240	-0,394
∑ VI-VII	0,456	0,294	0,256	0,523	0,306	0,554	0,493	-0,346	-0,279	0,144	0,300	-0,211	0,432	0,155
∑ VIII-IX	0,412	0,440	0,342	0,258	0,148	0,390	0,434	0,199	0,193	-0,298	0,083	0,042	-0,096	0,210
IV	0,471	0,693	0,252	0,403	0,387	0,474	0,526	-0,364	-0,576	-0,589	-0,212	0,284	-0,209	-0,273
V	0,370	0,426	-0,02	0,159	0,293	0,162	0,237	0,173	0,555	-0,206	-0,268	0,407	0,356	0,125
VI	0,231	0,175	0,175	0,445	0,274	0,424	0,295	0,036	-0,049	0,056	0,505	0,041	0,624	0,478
VII	0,488	0,352	0,307	0,196	0,206	0,556	0,493	-0,511	-0,388	0,153	-0,036	-0,404	0,397	-0,185
VIII	0,498	0,502	0,594	0,236	0,671	0,586	0,683	-0,183	0,360	0,233	0,576	0,594	0,208	0,789
IX	0,318	0,121	-0,004	-0,044	-0,163	0,023	0,218	0,323	-0,08	-0,649	-0,234	-0,266	-0,183	-0,227
Average	0,470	0,389	0,264	0,357	0,365	0,465	0,481	0,023	0,182	-0,230	0,169	0,262	0,193	0,223

\* There is no recorded data in the Republic Hydrometeorological Institute of RS for Novi Grad 2000-2002

## Conclusion

By comparing the correlation coefficient value for the period from 2000 to 2016 and dry year during the seventeen-year interval, a certain similarity in the correlation of rainfall and corn yield was identified. It can be concluded that the greatest positive interdependence of these variables was in the period before and during hybridization, as well as in the formation and initial grain filling. The same can be applied to pre-sowing period and therefore production year, with an adequate schedule and amount at certain periods.

The difference is that in the dry years, compared to the entire seventeen-year period, the value of correlation coefficient for the production-year and the July-August period is somewhat lower, and slightly higher for August and January-March. The highest coincidence was expressed for the region Banja Luka, Doboje and Novi Grad, with somewhat higher values for dry years, when it comes to annual precipitation.

The highest values of positive interdependence between rainfall and maize yield were recorded for Novi Grad, in pre-vegetation period (0,842), and then to Doboje in the period January-March (0,758), also in dry years, while for the interval 2000-2016 in July-August (0,749) in Bijeljina. On average, for all production regions of maize in RS, greatest value of this coefficient was for August in dry years (0,789).

The obtained values of this correlation analysis can be of great importance in research about the possibilities of time derivatives in the production of maize, as in the Republic of Srpska, also in its specific production regions which differ in terms of humidity, the quality of soil resources and intensity of production and application of adequate agricultural practices and technologies for maize growing.

## References

- Araus, J.L., Serret, M.D., Edmeades, G.O. (2012): Phenotyping maize for adaptation to drought. *Frontiers in Physiology*, 3: 1-20.
- Berg, E. (2002): Das System der Ernte- und Einkommensversicherungen in den USA - Ein Modell für Europa? *Ber. Landwirtsch.* 80: 94-133.



- Breustedt, G. (2003): Subventionen für landwirtschaftliche Einkommensversicherungen - Nützlich und notwendig? [Elektronski izvor]. [8 str] dostupno na adresi <http://www.uni-hohenheim.de/i410b/download/gewisola/papers/breustedt.pdf> (citirano 10.03.2003, verifi kovano 06.07.2010). Proc 43. Jahrestagung der Gesellschaft für Wirtschafts- und Sozialwissenschaften des Landbaues, Stuttgart, Deutschland.
- Hartung, J. (1998): Statistik: Lehr- und Handbuch der angewandten Statistik, Oldenbourg Verlag, München, 73-74.
- Kovačević, V., Radić, V., Iljkić, D., Jović, J., Majdančić, M. (2016): Weather conditions in the 2013-2015 growing seasons for maize in Croatia and Bosna and Herzegovina. VII International Scientific Agricultural Symposium "Agrosym 2016", Jahorina, Book of abstracts, 116.
- Kozak, M., Krzanowski, W., Tartanus, M. (2012): Use of the correlation coefficient in agricultural sciences: problems pitfalls and how to deal with them. Anais da Academia Brasileira de Ciências, 84: 1147-1156.
- Marković, T., Jovanović, M. (2011): Uticaj količine padavina na prinose pšenice i kukuruza kao proizvodni bazni rizik. Ratar. Povrt. / Field Veg. Crop Res. 48: 207-212.
- Mußhoff, O., Odening, M., Xu, W. (2005): Zur Reduzierung niederschlagsbedingter Produktionsrisiken mit Wetterderivaten. In: Wirtschafts- und Sozial-wissenschaftliche Fachgebiete der Landwirtschaftlich-Gärtnerischen Fakultät der Humboldt-Universität 73, Working paper, 1-17.
- Ostić, G., Radanović, S. (2012): Irrigation – a Factor of Higher Yield and Sowing Model Selection for Maize Seed. Agro-knowledge Journal, University of Banjaluka, Faculty of Agriculture, 13: 267-276.
- Schmitz, B. (2007): Wetterderivate als Instrument im Risikomanagement landwirtschaftlicher Betriebe. Doktorarbeit im wissenschaftlichen Studiengang Agrarwissenschaften an der Rheinischen Friedrich-Wilhelms-Universität zu Bonn, Institut für Lebensmittel- und Ressourcenökonomik, Bonn, 67-68.
- Vedenov, D. V., Barnett, B. J. (2004): Efficiency of Weather Derivatives as Primary Crop Insurance Instruments. J. Agric. Resour. Econom. 29: 387-403.

## YIELD AND YIELD STRUCTURE OF DOMESTIC WHEAT VARIETIES DEPENDING ON SOWING RATES

Iskra ARAPOVIĆ<sup>1\*</sup>, Dragan MANDIĆ<sup>1</sup>, Goran ĐURAŠINOVIĆ<sup>1</sup>, Novo PRŽULJ<sup>2</sup>, Zoran JOVOVIĆ<sup>3</sup>

<sup>1</sup>Public Institution Agricultural Institute of Republic of Srpska, Banja Luka, Bosnia and Herzegovina

<sup>2</sup>University in Banja Luka, Faculty of Agriculture, Bosnia and Herzegovina

<sup>3</sup>University of Montenegro, Biotechnical Faculty of Podgorica, Montenegro

\*Corresponding author: iskra.mihic@gmail.com

### Abstract

In order to determine the effect of different sowing rates on yield and yield components of domestic winter wheat varieties used for the production of seed, the necessary research were conducted in 2015/16 on the experimental field of the Public Institution Agricultural Institute of Republic of Srpska, Banja Luka (in further text: Institute) in entity of Republic of Srpska, Bosnia and Herzegovina. The field trial has been conducted with the usual methodology inherent to the seed production in our agro-ecological conditions. The trial was designed in four replications and three seeding rates (500, 600 and 700 germinated seeds/m<sup>2</sup>) for the wheat varieties Nova Bosanka and Jelena. Optimum utilization of the genetic potential of these varieties and production capacity of soil with adequate agricultural technology largely depends on the number of plants per m<sup>2</sup>, as the main yield component. The optimum size of a vegetation area is the area that provides the highest yield per unit area. The different seeding rates have had different effects on the yield of the tested varieties, especially the yield components. This can be explained by the fact that this plant species has a great ability to compensate relationship among yield components and the yield. The highest average values of the number of productive spikes were implemented at the largest sowing rates. Neither one sowing rate showed significantly higher average values for grain weight per spike, mass of 1000 seeds, number of grains per spike and hectolitre weight. The highest average yield over 8 t/ha<sup>-1</sup> was achieved with sowing rate of 600 germinated seeds.

**Keywords:** *Yield, Variety, Sowing rates, Yield components.*

### Introduction

Wheat has a great influence on human life, so sometimes it is not realistic to see it as a common agricultural or commercial product. It is one of the basic food resources and has greatly influenced the development of man as a social being. Wheat is the most adaptable plant species. The existence of winter, facultative and spring varieties allows growing of this plant species in a significantly wide range, from the equator to near the Arctic Circle in the northern hemisphere and 40 degrees southern hemisphere. New varieties possess a significantly higher genetic potential from older varieties, or populations that have been grown long ago. The limiting factors are still agroecological conditions and the achieved level of technology. The potential number of grains/spike as a component of yield is formed 2 – 3 weeks before the blooming of which a relatively small number of initiated flower primordia survive and form a fertile flowers and grains (Kirby, 1988). The genetic potential of some of the world's wheat varieties is over 14 t/ha<sup>-1</sup>, but the percentage of utilization of this potential is only about 20% because the average world yield is around 2.5 t/ha<sup>-1</sup>. Breeders produce varieties targeted to specific areas of production with the particular production technology.

Multiannual yield analysis of several wheat varieties show different levels of variability among years, locations and varieties. Certain elements of production technology may have a decisive influence on the expression of genetic or production potential. Classic agrotechnic can reduce the variation to yield and yield components per year. Achieving extremely large yields, especially considerably higher than our multiannual averages, is the current trend of research among genotype – production technology – environmental factors. The most important elements of the production technology that are controlled by human (selection of varieties, sowing time, sowing rate, amount and type of mineral fertilizer) are designed to maximally adjust the environmental conditions to the genotype selected for production. Sowing rate, or the number of plants can not influence the increase of the yield in a significant percentage, if it is not in the corresponding correlations with other components of yield during the growing season (Tavčar, 1959, Đurić, 2001, Prodanović *et al.*, 2009).

The aim of this study was to determine the influence of different sowing rates on yield and yield components of domestic wheat varieties.

### Materials and methods

This paper analyzes the yield and some yield components of the domestic winter wheat varieties in the production (Nova Bosanka and Jelena) through field trials conducted on the experimental field of the Public Institution Agricultural Institute of Republic of Srpska (Bosnia and Herzegovina) during 2015/16. Trials were set up in four repetitions on brown - lowland soil. The land was cultivated in the traditional manner, the depth of plowing was about 20 to 25 cm, precrop was corn and sowing was carried out in 04.11.2015. In basic fertilization, 300 kg NPK 8:24:16 was incorporated into soil. Three sowing rates were tested, including 500, 600 and 700 germinating grains per m<sup>2</sup> for both wheat varieties.

### Results and Discussion

The yield is a complex trait determined by more simple features, which are determined by complex genetic systems. The yield is controlled by the factors responsible for the adaptation or tolerance to the factors that limit the realization of yield for each plant species and the factors under which control is productivity. This shows the current yield which is a part of the existing potential for yield in a given agro-ecological conditions and with appropriate production technology. Potential for yield is the grain yield produced by the variety in conditions to which it is adapted without limitation for the necessary nutrients and water, with successful control of other factors that may reduce the yield.

Table 1. Realized yields t/ha<sup>-1</sup> for the variety Jelena with different sowing rates

Repetition	Sowing rate, number of germinated seeds/m <sup>2</sup>					
	500		600		700	
	kg/5m <sup>2</sup>	t/ha <sup>-1</sup>	kg/5m <sup>2</sup>	t/ha <sup>-1</sup>	kg/5m <sup>2</sup>	t/ha <sup>-1</sup>
I	4,69	9,38	4,94	9,28	4,75	9,59
II	3,95	7,90	4,10	8,20	4,00	8,10
III	4,15	8,30	4,00	8,00	3,97	7,94
IV	4,18	8,36	4,23	8,46	4,70	9,40
Average	<b>4,24</b>	<b>8,48</b>	<b>4,31</b>	<b>8,48</b>	<b>4,35</b>	<b>8,75</b>

Table 2. Realized yields t/ha<sup>-1</sup> for the variety Nova Bosanka with different sowing rates

Repetition	Sowing rate, number of germinated grains/m <sup>2</sup>					
	500		600		700	
	kg/5m <sup>2</sup>	tha <sup>-1</sup>	kg/5m <sup>2</sup>	tha <sup>-1</sup>	kg/5m <sup>2</sup>	tha <sup>-1</sup>
I	5,46	10,52	5,63	11,26	5,75	11,50
II	5,06	10,12	4,90	9,80	4,90	9,80
III	4,97	9,94	5,11	10,20	5,08	10,16
IV	5,93	11,86	5,80	11,60	5,68	11,36
Average	<b>5,35</b>	<b>10,61</b>	<b>5,36</b>	<b>10,71</b>	<b>5,35</b>	<b>10,70</b>

The highest absolute grain yield per hectare of 9,59 t/ha<sup>-1</sup> had variety Jelena with a sowing rate of 700 germinated grains/m<sup>2</sup>. The average yield for the tested variants was almost identical and ranged from 8.48 t/ha<sup>-1</sup> to 8.71 t/ha<sup>-1</sup>, and the overall average was 8.65 t/ha<sup>-1</sup>, which is only about 0,9%, and it does not represent statistical significance. The lowest yield of variety Nova Bosanka of 9,80 t/ha<sup>-1</sup> was achieved with two different levels of sowing rates, respectively with 600 and 700 germinated grains per m<sup>2</sup>. The lowest yield of the variety Jelena of 7,90 t/ha<sup>-1</sup> was achieved with two different levels of sowing rates, respectively with 500 and 600 plants per m<sup>2</sup> and the overall average for the variety was 10.71 t/ha<sup>-1</sup>.

Nova Bosanka had the highest absolute yield per hectare of 11,86 t/ha<sup>-1</sup> with the sowing rate of 500 germinated grains/m<sup>2</sup>. The average yield for the tested variants was 10,71 t/ha<sup>-1</sup>. Uniform yield may be the result of good compensation or redistribution of assimilates from photosynthetic organs to grain.

The yield difference between the tested varieties was evident and it amounted to 2.06 t/ha<sup>-1</sup> with the same agrotechnic. Such significant difference under the same conditions of performing trials can certainly be attributed to the different genetic potential, primarily the current yields. One explanation may be that variety Jelena is significantly better than variety Nova Bosanka and for this reason the difference in yield is present. It is well known that, when it comes to a greater number of varieties, the quantity and quality have a negative correlation.

The effects of lower sowing rates are compensated by the formation of more large and productive spikes per plant, and also by the higher number of grains per spike. One of the consequences may be that the number of grains per spike determines the potential or actual yield. Agroecological conditions, which affect grain formation and grain yield have certainly played an important role in the formation of final yield in this variant. The number of spikes per unit area is usually in negative correlation with the number of grains in the spike and the yield. The variation in yield among different sowing rates is usually mitigated by various compensating relationships among the yield components.

The number of spikes per m<sup>2</sup> for three sowing densities for variety Jelena ranged from 516 to 720, more exactly 546 to 664, representing a significant difference of 18 % in percentage. The number of spikes per m<sup>2</sup> for three sowing densities for variety Nova Bosanka ranged from 544 to 721, more exactly 567 to 663 spikes, representing a significant difference of 15 % in percentage.

Table 3. Harvested number of spikes/m<sup>2</sup> for variety Jelena with different sowing rates

Repetition	Sowing rate, number of spikes/m <sup>2</sup> and number of grains/spike					
	500		600		700	
	spike/m <sup>2</sup>	number of grains/spike	spike/m <sup>2</sup>	number of grains/spike	spike/m <sup>2</sup>	number of grains/spike
I	562	41	608	34	622	33
II	528	36	636	36	720	34
III	580	38	680	33	667	28
IV	516	34	616	35	645	31
Average	<b>546</b>	<b>37,2</b>	<b>635</b>	<b>34,5</b>	<b>664</b>	<b>31,5</b>

The increased number of grains per spike or increased number of grains per unit area contributes to a positive correlation between the number of grains per unit area and yield (Shearman *et al.* 2005). Similar results have been obtained by other authors, who are dealing with the mentioned issue (Borojević 1992, Malešević 2004, Đurašinović 2009, Prodanović *et al.* 2009). Another important yield component is grain weight (1000 grains), and it is much more stable feature from the number of grains per unit area (Bingham *et al.* 2006, Peltonen *et al.* (2007).

Table 4. Harvested number of spikes/m<sup>2</sup> for variety Nova Bosanka with different sowing rates

Repetition	Sowing rate, number of spikes/m <sup>2</sup> and number of grains/spike					
	500		600		700	
	spike/m <sup>2</sup>	number of grains/spike	spike/m <sup>2</sup>	number of grains/spike	spike/m <sup>2</sup>	number of grains/spike
I	544	70	609	60	623	48
II	568	65	635	55	721	55
III	556	64	680	57	665	54
IV	604	66	616	53	643	46
Average	<b>567</b>	<b>66,2</b>	<b>635</b>	<b>56,2</b>	<b>663</b>	<b>50,7</b>

On the basis of sample, the average weight of spike of 1.65 g was recorded in variety Jelena. The average grain weight was 1.31 g, while the spike index was 0,79 % with 37,2 grains per spike with the sowing rate of 500 germinated grains/m<sup>2</sup>. Variety Nova Bosanka had spike weight 3.7 g, grain weight 2,55 g, harvest index 0,82 %, with an average of 66,2 grains per spike in the sowing rate of 500 grains/m<sup>2</sup>. These values, especially for variety Nova Bosanka, indicate a high genetic potential of over 15 t/ha, which is obtained by multiplying the number of spikes per m<sup>2</sup> with the average spike weight.

It is important that with the increase in the sowing rate there is usually a decrease in the number of grains per spike which is recorded in both varieties. It is important that with the increase in the sowing rate there is usually a decrease in the number of grains per spike which is recorded in both varieties.

### Conclusion

Based on the above, the following conclusions can be drawn:

The average lowest yield in the tested varieties was at the sowing rate of 500 germinated grains/m<sup>2</sup>, but it is important that this difference is only 1.03% in relation to the highest yield. The highest yield for both varieties was achieved at the sowing rate of 700 germinated grains/m<sup>2</sup>. For both tested varieties, the sowing rate of 600 – 700 germinated grains/m<sup>2</sup> should

be maintained, based on the parameters of seed quality, sowing time and soil preparation to determine the sowing rate.

From the research results can be seen how environment factors had a huge role in the formation of yield through the number of germinated grains or spikes as one of the main components of yield.

The expected differences in yield between the tested variants did not occur due to the favorable influence of agroecological factors throughout the year.

### **References**

- Tavčar, A. (1959): Plant breeding. Zagreb. Croatia.
- Borojević, S.(1992): Principles and Methods of Plant Breeding. Genuine Book, Belgrade.
- Đurić, N., Trkulja, Vesna (2005): The research of grain yield and flour quality of some winter wheat of PKB. Proceedings of scientific papers. 11 (1-2):27-31.
- Đurašinović, G. (2009): Influence of variety and sowing density on the quantitative/qualitative characteristics of spring oats (*Avena sativa*). Master thesis. Faculty of Agriculture, Banja Luka.
- Kirby, E. J. M. (1938): Analysis of leaf, stem and ear growth in wheat from terminal spikelet stage to anthesis. Field Crops Research,18: 127-140.
- Prodanović, S. Mandić D. Rajčević, B. Randelović V. Dimitrijević, B. (2009): Comparative values of wheat characteristics in individual plants and plants in the crop, Scientific Paper Proceedings, 15 (1-2), 27-31.
- Shearman et al .(2005): Physiological proces associated with recent genetic increases in grain yield in winter wheat in UK. CropScience, 45. 175-185.

## **INFLUENCE OF LOCALITY AND FERTILIZATION ON YIELD OF BUCKWHEAT**

Branka GOVEDARICA<sup>1</sup>, Igor DJURDJIC<sup>1</sup>, Tanja JAKISIC<sup>1</sup>, Milan JUGOVIC<sup>1</sup>, Ljubisa CVIJIC<sup>1</sup>, Goran KARADZIC<sup>2</sup>, Vesna MILIC<sup>1\*</sup>

<sup>1</sup>Faculty of Agriculture, University of East Sarajevo, Vuka Karadzic 30, East Sarajevo, Republic of Srpska, Bosnia and Herzegovina

<sup>2</sup>Municipality of Cajnice, Republic of Srpska, Bosnia and Herzegovina

\*Corresponding author: vesnamlc@yahoo.co.uk

### **Abstract**

Buckwheat is a plant which has been spreading in Bosnia and Herzegovina (BiH) in the last decade. Because of its brief vegetation period, this crop species is suitable for hilly-mountainous regions.

In 2015, the experiments were set in the three localities of Sarajevo – Romanija region (experimental field “Kula” of the Faculty of Agriculture, University of East Sarajevo; private economy “Sando” on the Nišići plateau; and private agricultural farm “Jugović” in Mokro village), and two variants of fertilization (control variant – without the use of organic and mineral fertilizers and the use of N<sub>60</sub>P<sub>60</sub>K<sub>70</sub>). The Slovenian variety “Darja” was used for the experiments. The highest yield of buckwheat grains was at Nišići plateau (1.95 t ha<sup>-1</sup>) and the lowest (1.24 t ha<sup>-1</sup>) in East Sarajevo. The highest absolute mass of a buckwheat grain (25.68 g) was at Nišići, and the lowest (18.59 g) in at “Kula” of East Sarajevo. The buckwheat grain grown in at “Kula” East Sarajevo had the smallest hectolitre mass (51.8 kg), while at the localities of Mokro and Nišići the hectolitre masses were almost identical (55.5 kg and 55.7 kg). The average shell content for all these localities and fertilization variants was 24%.

**Keywords:** buckwheat, locality, fertilization, agro-ecological conditions, yield.

### **Introduction**

Buckwheat is an old plant species native to mountain areas of Central and North Asia. Mongols brought it to Europe at the end of the 14<sup>th</sup> century. Today, buckwheat is fostered worldwide on about 2.3 million hectares, with an average yield of approximately 1.0 t ha<sup>-1</sup>.

After the World War II, the cultivation of buckwheat stops because of intensified production of other cereals grains, migration of rural population into industrial areas, but especially because of low yield and uneconomical production. Since 1995, buckwheat is fostered again on arable lands of BiH. The number of plots where the buckwheat is grown increases every year, and the reasons are: (i) buckwheat is suitable for growing in mountain areas that dominate in BiH, (ii) buckwheat has low need for fertilizers and pesticides; (iii) a significant number of producers that certify buckwheat as an organic. Because of its variety of use in nutrition and medical treatments, there is a great demand on the domestic and foreign markets for the buckwheat products. Thanks to simple agrotechnics which includes cultivating without the usage of chemical means, buckwheat can be cultivated as main or subsequent crop or as a part of eco-corridor between certain crops.

The objective of this work is to examine and compare the yield of buckwheat variety “Darja” in three different localities in Sarajevo-Romanija region (Bosnia and Herzegovina). These studies, although short-term, can contribute to spread the cultivation of buckwheat, and determine areas for production of high-quality buckwheat.

## **Material and methods**

In 2015, , some studies have been conducted in Sarajevo-Romanija region to determine which locality is suitable for growing buckwheat, and whether mineral nutrition influences the yield and components of yield of buckwheat. Experiments had been set and conducted in three different localities and for sowing was used buckwheat variety “Darja”.

Darja was developed by crossing black buckwheat and Russian buckwheat genotypes. The flowers are white, the seeds are dark-brown, with a higher percent of shell. This plant is diploid variety, its side flower branches end in flower buds, while the main flower branch has unlimited growth. It is resilient to drought and high temperatures as well as on lodging, but it is sensitive to low temperatures.

The extracts of soil were taken before the set of experiment with agrochemical probe that depth to 0-30 cm.

Chemical analysis has been made in the laboratory of the Faculty of Agriculture in East Sarajevo:

-pH value of soil: (I) in water (H<sub>2</sub>O) or active reaction of soil, (II) in solution 1M KCl or substitutional reaction of soil, electrometrically.

-Determination of humus, bichromatic method by TUJURIN

-Determination of phosphorus (P<sub>2</sub>O<sub>5</sub>) spectrophotometrically, and potassium (K<sub>2</sub>O), photometrically

-Determination of overall nitrogen according to the modified method by KJELDAHAL. This difactorial experiment (locality and fertilization) was set by random block system with four repetitions.

First factor - Locality (A):

- Experimental field of the Faculty of Agriculture in East Sarajevo, approximately 500m above the sea level (A<sub>1</sub>);
- Private agricultural farm “Jugovic”, in Mokro village, approximately 905m above the sea level (A<sub>2</sub>);
- Private agricultural farm “Sando” in Nisici, approximately 1000m above the sea level. (A<sub>3</sub>).

Second factor- fertilization (B):

- Control (B<sub>0</sub>)
- N<sub>60</sub>P<sub>60</sub>K<sub>70</sub> (B<sub>1</sub>)

The basic soil cultivation plowing was conducted in autumn to depth of 30 cm, and before sowing, during soil preparation, NPK fertilizer is added. The surface of elementary plot was 12 m<sup>2</sup>. Sowing was done manually to a depth of 4cm and a number of plants was 250 per m<sup>2</sup>.

In A<sub>1</sub> land the sowing of buckwheat was done manually on 08.05.2015, and the manual harvest took place on 18.09.2015. Experiment in A<sub>2</sub> was set on 25.05.2015 and harvest of 14.09.2015. On A<sub>3</sub> land buckwheat is sowed on 1.06.2015 and harvested on 22.09.2015.

Meteorological data (temperature and precipitation) were followed at the two registered weather stations (Butmir and Sokolac).

Studies included: grain yield (t ha<sup>-1</sup>), absolute mass (g), hectoliter mass (kg), percentage of shell.

Grain yield (t ha<sup>-1</sup>) was calculated based on randomly picked 20 plants in each parcel and locality and by analyzing the average yield by plant, and then recalculated to yield per hectare.

The mass of 1.000 seeds (g) was determined from the fraction of pure seed obtained from the analysis of purity. Authors manually counted 800 seeds (100 seeds in 8 different chambers). Seeds from each chamber were especially measured on analytical scale. Given the values, it is calculated an average mass of 100 seeds which then multiplied by 10 and got the average mass of 100 seeds.

The volume mass of seeds (kg) was determined using the hectoliter scale.



Obtained data were statistically analysed and processed using the program Sigma Plot Windows 2000 (Jandel Scientific, Erkhart, Germany) and Statistica for Window.

The differences between the certain localities for each examined parameter, as well as differences between the fertilizers were tested using the LSD test.

### Environmental conditions in 2015

**Experimental field „Kula“ of the Faculty of Agriculture in East Ilidza.** Experimental field „Kula“ is located 550m above the sea level. Climate in Sarajevo has strong influence of continental climate, with an average annual temperature of 12.5 °C, and average precipitation amounts to about 900 mm. The highest temperatures are August, and the lowest is January. In Sarajevo there are approximately 85 days per year with temperature above 30 °C.

**Table 1.** Meteorological conditions in 2015 and perennial averages for Sarajevo (Meteorological station in Sarajevo)

Month		I	II	III	IV	V	VI	VII	VIII	IX	X	XI	XII
Average (1961- 1990)	Temp.(°C)	-0.8	1.7	5.5	10	14.8	17.7	19.7	19.4	15.9	10.9	5.6	0.4
	Pptn. (mm)	74	69	73	76	85	94	83	73	73	79	98	88
Year: 2015.	Temp.(°C)	0.9	1.7	5.3	9.2	16.1	17.8	23.2	21.8	17.6	11.1	6	-0.5
	Pptn. (mm)	112.6	56.6	80.4	43.6	52.9	91	9.4	57.4	60.2	124	75	12.5

Comparison of the meteorological conditions during the time of research in 2015 in experimental field in East Ilidza with perennial average, showed higher monthly averages of temperature and lower amount of precipitation. In July there was only 9.4 mm of rainfall while perennial average for this month is above 83 mm.

Experiment was set in an alluvial soil (fluvisoil). Chemical analysis is shown in Table 2.

**Table 2.** Chemical characteristics of soil in experimental field in East Ilidza.

Depth(cm)	pH/H <sub>2</sub> O	pH/KCl	Humus	N	soluble mg/100g	
			%	%	P <sub>2</sub> O <sub>5</sub>	K <sub>2</sub> O
0-30	7.16	6,39	4,12	0,27	>40	36,41

### Private agricultural farm Jugovic (Mokro)

Experiment was set on private farm in Mokro village area. The average annual temperature amounts to 6.8°C, with absolute highest temperature 33.6°C and the lowest -30°C. According to Micevic (1979), Sarajevo-Romanija region has a harsh mountain climate with cold winters and cool summers. Vegetation starts on April 8<sup>th</sup> and lasts until October 22<sup>nd</sup>, or 197 days. This is the period of time when temperatures rise above 5°C and when the vegetation of woody plants starts. The vegetation growing season with temperatures above 10°C starts on May 6<sup>th</sup> and lasts until September 24<sup>th</sup>, or 141 day. Late spring frosts can appear by the end of May, but they're most frequent in the first decade of May. The intensity of frosts is weak to moderately strong, with temperatures from -1°C to -4,2°C. Annual precipitation amounts to 800mm, and in period of time from April to September it amounts to 430mm. August is a 'critical' month because the temperatures are high and precipitation is low. Meteorological conditions and perennial average for the private farms "Jugovic" and "Sando" are shown in Table 3.

**Table 3.** Meteorological conditions in 2015 and perennial averages for Sokolac municipality (Meteorological station in Sokolac)

Month		I	II	III	IV	V	VI	VII	VIII	IX	X	XI	XII
Average (1961-1990)	Temp.(°C)	-4.2	-2.6	2.2	5.7	11.5	14.6	16	15.7	12.2	7.7	2.8	-1.8
	Pptn. (mm)	51	45	63	71	81	96	67	76	75	86	80	57
Year: 2015.	Temp.(°C)	-2.5	-1.3	2.1	6.2	13.4	15.3	19.8	18.9	14.5	8.4	3.2	-1.6
	Pptn. (mm)	89.9	56.1	74.7	53.2	75.4	113.3	25.2	85.7	84.3	106.9	71.2	0.3

Comparison of the meteorological conditions during the time of experiment in 2015 on private farms in Mokro and Nisici with perennial average showed higher monthly averages of temperature, while the amount and distribution of precipitation varied. Compared to perennial average, in May there was less rainfall, in June there was 17.3 mm more rain, in July 41.8 mm less rain, and in August 10 mm more rain. According to the soil map of BiH (Resulović et al., 2008) the most common type of soil in Mokro is acidic brown soil (Dystric Cambisol), which is also the type of soil where we conducted our experiment. Acidic brown soil (Dystric Cambisol) is a Ah-Bv-Cn type of soil, and it's mostly found in mountain areas, 450-1.000m above the sea level. Dystric Cambisol forms itself on quartz-silicate substrates, compact rocks and loose sediments. It has high acidity and low content of bases. They are suitable for growing potatoes and some kinds of grains. When determining the suitability of land for irrigation and agricultural production, mechanical composition is analyzed as one of the most important physical properties, because the mechanical composition influences other physical properties of the land. Analysis of soil is shown in Table 4.

Table 4. Chemical analysis of soil.

Depth of taking samples (cm)	pH/H <sub>2</sub> O	pH/KCl	CaCO <sub>3</sub> (%)	Humus (%)	Overall N	P <sub>2</sub> O <sub>5</sub> (mg/100 g)	K <sub>2</sub> O (mg/100 g)
0-30	6,22	5,17	1,1	5,1	0,336	1,43	34,3

Chemical analysis of samples of acidic brown soil, taken at 0-30 cm depth, has shown that soil has acidic reactions, is well supplied with humus, well provided with potassium, but poor with Phosphorous. According to Resulović et al. (2008), this type of soil is poor in content with easily available phosphorus, and has very high scale of potassium, which author also recorded in analysis of acidic brown soil taken from two different depths.

**Private farm Sando (Nisici)**

Nisici plateau is located 950-1000m above the sea level. This area is dominated by continental and alpine climate, which are also characteristic for higher areas of Central Bosnia. The main characteristics of this type of climate are harsh winters with temperatures as low as -30°C and summers with temperatures rising above 35°C. Annual precipitation is around 1200 mm. The closest meteorological station is located in Sokolac municipality.

Table 5. Chemical analysis of soil

Depth of taking samples (cm)	pH/H <sub>2</sub> O	pH/KCl	CaCO <sub>3</sub> (%)	Humus (%)	Overall N	P <sub>2</sub> O <sub>5</sub> (mg/100 g)	K <sub>2</sub> O (mg/100 g)
0-30	5,00	3,89	<1	6,68	0,34	2,32	23,03

Soil at this parcel had strong acidic reactions with high content of humus (6,68%), is well provided with nitrogen and potassium, and has low content of phosphorous.

## Results and discussion

**Grain yield of buckwheat.** The grain yield of buckwheat is affected by environmental conditions, cultural practices and the genetic potential of varieties. According to *Bogadnovic* (1984) the most important components that affect the yield are number of plants per m<sup>2</sup>, number of grains per plant and the absolute mass of grain. Some authors consider that the yield is greatly affected by cultural practices (*Jevdjovic u cap*, 2012; *Popovic et al.*, 2011; *Kasajima et al.*, 2007) while others consider environmental conditions as the most influential factor (*Dolijanovic et al.*, 2013; *Dolijanovic et al.*, 2014).

Average grain yield of buckwheat, regardless of locality or fertilizers was 1.61 t ha<sup>-1</sup> (Tabel 6). Highest grain yield of buckwheat was at Nisici (1.95 t ha<sup>-1</sup>) and the lowest in East Sarajevo (1.24 t ha<sup>-1</sup>).

Determined differences were statistically highly important, as well as differences between localities in Mokro and Nisici. Grain yield of buckwheat in Mokro village had statistically higher yield compared to one in East Sarajevo. Similar results were found by *Vreva et al.*, (2012) and *Dolijanovic et al.*, (2013).

Table 6. The influence of locality and fertilization on grain yield of buckwheat (t ha<sup>-1</sup>)

Locality	Fertilization		Average
	B <sub>0</sub>	B <sub>1</sub>	
A <sub>1</sub>	1.15	1.32	1.24
A <sub>2</sub>	1.44	1.86	1.65
A <sub>3</sub>	1.74	2.15	1.95
Average	1.44	1.78	1.61
	A	B	AxB
LSD 5%	0.215	0.152	0.352
1%	0.296	0.241	0.428

In control variant, the yield of buckwheat was (1.44 t ha<sup>-1</sup>) and in variant where fertilization was done by mineral fertilizers (1.78 t ha<sup>-1</sup>). Identified differences were statistically highly significant.

In addition to the necessary assembly of plants, mineral nutrition of plants, good soil preparation, it was necessary to determine the optimal time of sowing for each parcel in order to avoid bad weather conditions (low or high temperatures, lack of moisture in soil and low relative humidity).

**Mass of 1000 seeds.** The mass of 1000 seeds highly depends on the external environment conditions and the ways of cultivation of buckwheat. It is the element of yield and along with number of seeds per plant it determines the productivity of the plant. Seeding date influences the mass of 1000 seeds. Most authors consider that the earlier the seeding takes place the higher the mass of 1000 seeds. (*Demidenko and Lebedov*, 1976; *Ovsejucuk*, 1980).

Average mass of 1000 seeds for all localities and variants of fertilization was 22.98 g (Tabel 7). The biggest mass of buckwheat seeds was in Nisici (25.68 g), and the smallest in East Sarajevo (18.59 g). Determined differences, as well as differences in seed mass between Mokro and East Sarajevo, were statistically higher important, and the results were influenced by the lack of moisture in soil at the time of forming seeds and the temperature that was higher for 3,4°C compared to other two localities.

Tabel 7. The influence of locality and fertilization on mass of 1000 seeds of buckwheat (g).

Locality	Fertilization		Average
	B <sub>0</sub>	B <sub>1</sub>	
A <sub>1</sub>	17.54	19.65	18.59
A <sub>2</sub>	23.74	25.61	24.68
A <sub>3</sub>	24.63	26.72	25.68
Average	21.97	23.99	22.98
	A	B	AxB
LSD 5%	2.254	1.321	3.743
1%	3.043	2.154	4.538

The yield of buckwheat was (1.44 t ha<sup>-1</sup>) and in variant where fertilization was done by mineral fertilizers (1.78 t ha<sup>-1</sup>). In control variant, the mass of 1000 seeds was 21.97g and in variant with fertilizers 23.99 g. Identified differences were statistically highly significant, and are in accordance with other author's results (Popović *et al.*, 2013). In Dolijanovic *et al.*, (2014) research, authors established statistically significant influence of locality on mass of 1000 seeds and fertilizer did not have statistical significance, while in our research both locality and mineral nutrition had great impact on the mass.

**Hectoliter mass.** Hectoliter mass has less importance in the evaluation of the quality, but is an important property in food industry, especially in the processing of grain. Lower hectoliter mass of grain indicates on lower quality. In less fertile years hectoliter mass is lower and it is an indicator of the STUROST of grains (Bogdanović, 1984).

Average hectoliter mass for tested localities and variants of fertilization was 54.3 kg (Tabel 8). The smallest hectoliter mass had buckwheat grains cultivated in East Sarajevo (51.6 kg), while hectoliter masses in Mokro and Nisici were almost identical (55.5 kg and 55.7 kg). Variant with the use of NPK (55.1 kg) compared to control variant (53.5 kg) had statistically higher hectoliter mass of grain.

Table 8. Influence of locality and fertilization on hectoliter mass of buckwheat grains (kg).

Locality	Fertilization		Average
	B <sub>0</sub>	B <sub>1</sub>	
A <sub>1</sub>	50.8	52.4	51.6
A <sub>2</sub>	54.7	56.2	55.5
A <sub>3</sub>	54.9	56.5	55.7
Average	53.5	55.1	54.3
	A	B	AxB
LSD 5%	1.285	0.854	2.147
1%	1.964	1.582	2.946

Percent of shell. This property depends on hereditary characteristics of the variety. Better varieties have higher percentage of core and less percentage of shell. Percentage of shell is an important indicator of quality of grain, and it depends on grain size and the percentage of fulfillment of grain (Sahov, 1982), but also on the use of mineral fertilizers (Riznicenko, 1976), and average temperature from 19.4 to 20.8°C at the time of germination grain (Fesenko and Dragunova, 1972). Our results are in accordance with these results (Table 9).

Table 9. The influence of locality and fertilization on the percentage of shell (%)

Locality	Fertilization		Average
	B <sub>0</sub>	B <sub>1</sub>	
A <sub>1</sub>	26.8	25.1	25.9
A <sub>2</sub>	23.5	22.1	22.8
A <sub>3</sub>	23.8	22.6	23.2
Average	24.7	23.3	24.0
	A	B	AxB
LSD 5%	0.529	0.431	0.753
1%	0.682	0.582	0.896

Average content of shell for all localities and variants of fertilization was 24%. Grains of buckwheat cultivated in East Sarajevo had statistically higher percentage of shell compared to grains in Mokro and Nisici. Compared to variants that used NPK fertilizers, variants without fertilization had significantly higher content of shell.

### Conclusion

Based on data obtained from cultivating buckwheat at three different locations (East Sarajevo, Mokro and Nisici) and two variants of fertilization (Control variant and N<sub>60</sub>P<sub>60</sub>K<sub>70</sub>) we have following conclusions:

- In our agro-ecological and soil conditions buckwheat has a high yield of grains, which are rich in overall proteins, mineral salts, oils and contains significant amounts of dietary carbohydrates and cellulose.
- Buckwheat cultivated in East Sarajevo had the highest percentage of shell, the lowest yield of grain, absolute mass and hectoliter mass, while buckwheat in Nisici had the highest yield and both, highest absolute mass and hectoliter mass.
- The usage of mineral fertilizers has positively influenced the most of tested quantitative characteristics of buckwheat.

### References

- Bogdanović M. (1984): Research on the effect of genotype varieties, fertilization and sowing date on the important morphological-biological, the productive and qualitative traits of buckwheat (*Fagopyrum esculentum* Moench), doctoral dissertation, Faculty of Agriculture, Sarajevo.
- Demidenko PM, Lebed LB (1976): Identities timing sowing buckwheat in the steppes of the USSR in on yield and chemical and composition of the grain. Genetics, Selektivacija, seed and buckwheat vozdelivanie. Kolos, Moscow.
- Dolijanović Ž., Oljača S., Kovačević D., S. Šeremežić, Jovovic Z. (2013): Productivity buckwheat depending on the locality of cultivation. VI Proceedings of the Symposium with international participation "Innovations in crop and vegetable production," p. 29th.
- Dolijanović Ž., Oljača Snezana Kovacevic, D., S. Šeremežić, Jovovic Z. (2014): Effect of breeding sites, microbiological fertilizers and soil productivity buckwheat (*Fagopyrum esculentum* Moench). Journal of Agricultural Sciences Vol. 59, No. 1 DOI: 10.2298 / JAS1401025D UDC: 633.12 (497.11) "2009/2010", 25-34, Belgrade.
- Fesenko NV, Dragunov VE (1972): Characteristics of the educational process of buckwheat grains. Scientific papers, the IV, Orel.

- Jevđović R., Filipović V., Marković J. (2012): Defining quality indicators of buckwheat seeds depending on the fraction size and the temperature regime. 47th Croatian and 7th Internat. Symposium on Agriculture. Opatija, Croatia, 284-288.
- Kasajima S., Inoue N., Veda Y., Mahmud R., Kitabayashi H. and Kurauchi N. (2007): Heritability and Variation of Fertilization Rate in Common Buckwheat. Nagano.
- Krupa-Kozak U., Wronkowska M., Soral-Šmietana M. (2011): Effect of buckwheat flour on microelements and proteins contents in gluten-free bread. Czech Journal of Food Science 29:103-109.
- Milić, V., Govedarica, B., Šilj, M., Jovović, Z., Vasković, S. (2013): Buckwheat production in Republic of Srpska XVIII Consultation about biotechnology, Cacak, Serbia.
- Ovsejuchuk EO (1980): How to improve the quality of crops buckwheat. and seed production Selekcija, N0 3, Kiev.international involvement, essay anthology,173-177, Faculty of Agronomy, Čačak.
- Popović V., Glamočlija Đ., Malešević M., Ikanović J., Dražić G., Spasić M., Stanković S. (2011): Genotype specificity in nitrogen nutrition of malting barley, Genetika, Belgrade, vol. 43(1), pp. 197-204, available at: [www.dsggenetika.org.rs](http://www.dsggenetika.org.rs).
- Popović Vera, V. Sikora, J Berenji. (2013a): The influence of environmental factors and foliar treatment, the yield of buckwheat in conventional and organic rearing systems. Institute of Field and Vegetable Crops, 21st.
- Popović Vera, V. Sikora, Berenji J., Glamočlija Đ., Marić V. (2013b): The influence of environmental factors on the productivity of buckwheat seeds in conventional and organic cropping system. Institut PKB Agroekonomik.
- Resulović H., H. Čustović, Čengić I. (2008): Systematics of soil / land - occurrence, properties and fertility.

## THERMAL INACTIVATION KINETICS OF PEROXIDASE IN GALEGA KALE (*Brassica oleracea* L. var. *acephala* CV. Galega)

Lucía GÓMEZ-LIMIA, Iria DACOSTA, Manuel ARIAS\*, Inmaculada FRANCO, Lorena PIÑEIRO, Sidonia MARTÍNEZ

Food Technology, Faculty of Science, University Campus As Lagoas s/n, 32004 Ourense, University of Vigo, Spain

\*Corresponding author: manuel@uvigo.es

### Abstract

The consumption of *Brassica* spp. is quite high and it represents an important part of a well-balanced diet in the northwest of Spain. Seasonality and perishability cause that some of these vegetables are in the necessity of applying preservation technologies. Some of these technologies are frequently preceded by blanching. In general, the blanching limits the losses of nutritive and organoleptic qualities during processing. Peroxidase is one of the most heat-resistant of vegetable enzymes, which has led to it being used as an indicator of the adequateness of the blanching process. This enzyme has also been associated with losses in the colour, flavour and nutritional values of raw and processed foods. The inactivation of peroxidase depends on the temperature of the blanching water and the type and size of the vegetable. Galega kales (*Brassica oleracea* var. *acephala*) are popular vegetables among people from Northwest Spain, which are easy to find among local markets. Blanching was applied in this study in order to examine the inactivation of peroxidase in Galega kales. The objective was to obtain kinetic parameters of peroxidase inactivation that can be used in further analyses. Inactivation experiments were carried out at five different temperatures ranging 75–95°C. The peroxidase activity was followed spectrophotometrically at 470 nm. Kinetic parameters, D and z values, were also determined. Fresh Galega kale had high initial peroxidase activity in this study. The enzyme inactivation was dependent on temperature and heating time. Peroxidase activity showed first-order kinetics with z values of 15.51°C.

**Keywords:** *Peroxidase, Galega kales, Blanching, Inactivation, Kinetic parameters.*

### Introduction

*Brassica* spp. are of great economic importance as vegetable crops. Their consumption is quite high and it represents an important part of a well-balanced diet in the northwest of Spain.

Kale (*Brassica oleracea* var. *acephala*) is a particular vegetable in this group, due to the presence of several beneficial compounds, such as vitamins, glucosinolates, phenolic compounds, carotenoids, etc.

The use of kale is limited by its seasonality and perishability; therefore, these vegetables are in the necessity of applying preservation technologies it is necessary. However, its industrial processing is until now low (mainly by freezing or canning).

Freezing or canning are frequently preceded by blanching. In general, the blanching limits the losses of nutritive and organoleptic qualities during processing. Peroxidase is one of the most heat-resistant of vegetable enzymes, which has led to it being used as an indicator of the adequateness of the blanching process (Goncalves *et al.*, 2009; Arnnok *et al.*, 2010).

Peroxidase has also been associated with losses in the colour, flavour and nutritional values of raw and processed foods (Fils *et al.*, 1985; Yemenicioğlu *et al.*, 1998; Polata *et al.*, 2009).

The inactivation of peroxidase depends on the temperature of the blanching water and the type and size of the vegetable. Selecting an appropriate time-temperature combination (TTC) is important for enzyme inactivation processes and maintaining.

Galega kales (*Brassica oleracea* var. *acephala* cv. Galega) are popular vegetables among people from Northwest Spain, which is easy to find among local markets.

The objective was to obtain kinetic parameters of peroxidase inactivation that can be used in further analyses

### Material and Methods

Fresh Galega kale plants were purchased at local markets supplied by different production areas in the province of Ourense (Galicia, northwest Spain). Samples were of uniform size, random appearance and defect free. The plants were transported to the laboratory, where they were washed with deionised water and inedible portions were discarded. Whole plants were analyzed (in this case, the ratio of leaves/stems was 75/25 [w/w]).

For heat treatments, kales were immersed in a thermostatic water-bath ( $\pm 1^\circ\text{C}$ ), at five temperatures (75, 80, 85, 90 and  $95^\circ\text{C}$ ), and collected after reaching pre-established time. After blanching, the samples were cooled in an iced water-bath for 2 min. Excess of moisture was removed before any further analysis.

A fresh sample was taken as a control.

Fresh and blanched samples (5 g) were homogenized with 25 mL Mili-Q water, and after they were centrifuged at 6,000 rpm for 15 min at  $4^\circ\text{C}$ . The mixture was filtered, and the supernatants were used for the determination of activity.

The filtrate was mixed with peroxidase (POD) substrate solution (0.1 mL guaiacol, 0.1 mL  $\text{H}_2\text{O}_2$  (33%) and 99.8 mL potassium phosphate buffer (0.1 mol/L, pH=6.5). POD assays were conducted by pipetting 0.1 mL of enzyme extract and 2.9 mL of substrate solution in a quartz cuvette. POD activities were measured from the increase in absorbance at 470 nm using spectrophotometer (UV-1800-VIS, Shimadzu, Singapore). The reaction was monitored for 20 min. All the experiments were replicated thrice and average values were used in analysis.

One unit of peroxidase activity (U) was defined as the amount of enzyme that caused the oxidation of 1.0  $\mu\text{mole}$  of guaiacol in 1 min. Total initial enzyme activities were expressed as specific activity (U/g)

The residual activity was determined as  $(A/A_0)$  where: A = mean enzyme activity (after blanching);  $A_0$  = mean initial enzyme activity (before blanching).

First-order inactivation constant ( $k$ ) was calculated from the slope of the natural logarithm ( $\ln$ ) of  $A/A_0$  vs. time graph. Decimal reduction time ( $D$  value) was estimated from the relationship between  $k$  and  $D$  value:  $D = \ln(10)/k$ . The  $z$  value, which is the temperature increase required for a one-log<sub>10</sub> reduction (90% decrease) in  $D$  value was determined from a plot of  $\log_{10} D$  vs. temperature.

### Results and Discussion

The fresh kales showed an initial peroxidase activity of  $109.70 \pm 17.86$  U/g.

Figure 1 presents the residual activity ( $P/P_0$ ) as a function of time for the different tested temperatures of blanching. The data was normalized in relation to the initial activity observed in the fresh product ( $A_0$ )

The enzyme inactivation was significantly affected ( $P < 0.05$ ) by the blanching time and temperature (the higher the temperature, the more efficient is the blanching process).



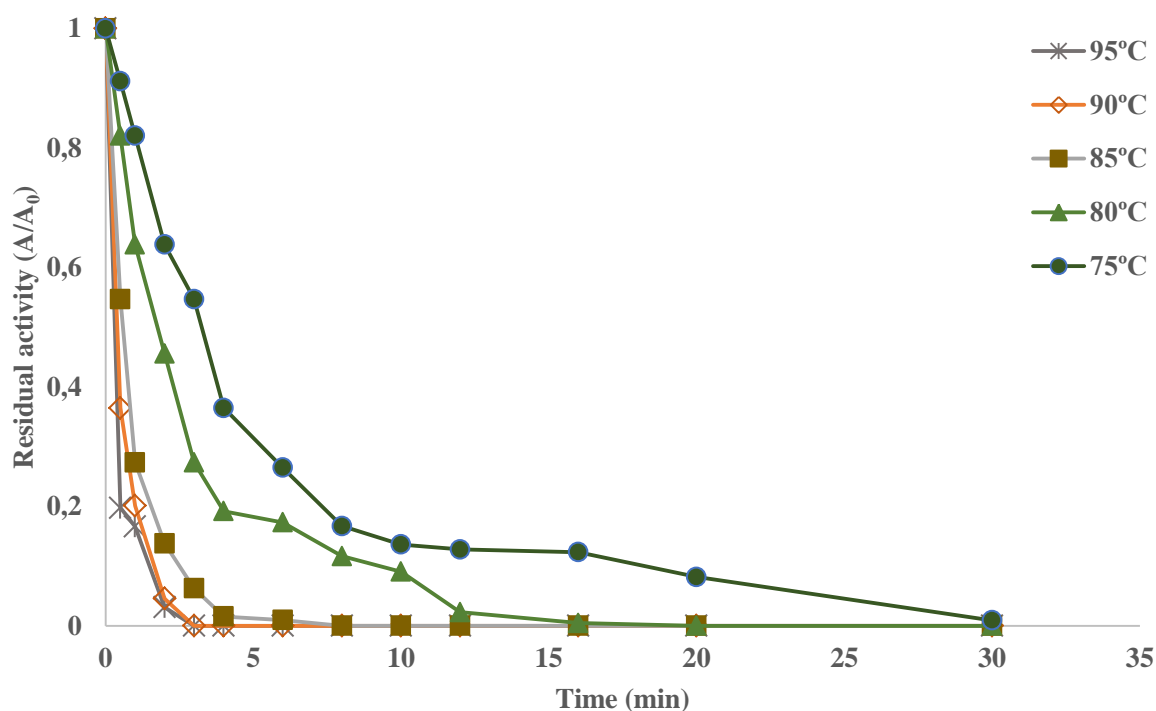


Figure 1.- Peroxidase activity of blanched Galega kale

The peroxidase residual activity at 6 min decreased a 73.54 % to 75 °C, 82.7 % to 80 °C and 99 % to 85 °C. On the other hand, no activity of peroxidase was detected after 3 min of thermal treatment at 90 °C, and after 2.5 min at 95 °C.

The initial heat inactivation of peroxidase enzyme is rapid followed by a much slower inactivation period.

It has been pointed out that quality the quality of blanched food is superior even if some peroxidase activity remains because high time for complete inactivation can result in undesirable nutritive and sensorial qualities (Böttcher, 1975; Aamir *et al.*, 2013). On the other hand, other problem associated with the complete inactivation of peroxidase is the presence of 1–10% of more heat-stable peroxidase isoenzymes in most vegetables, which are difficult to inactivate (Williams *et al.*, 1986; Güneş *et al.*, 1993).

An acceptable level of inactivation during blanching represents a 90% loss of original peroxidase activity (Williams *et al.*, 1986). Table 1 presents different time–temperature combinations required to achieve this objective.

Table 1.- Time–temperature combinations required to achieve an acceptable level of inactivation of peroxidase activity during blanching.

Temperature (°C)	Time (min)	% activity POD
75	16	10%
75	20	7%
75	30	2%
80	8	10%
80	10	8%
80	12	2%
80	16	0%
85	3	6%

85	4	1%
85	6	0%
90	2	4%
90	3	0%
90	5	0%
95	2	3%
95	3	0%
95	4	0%

An acceptable inactivation of kale peroxidase was accomplished at 75 °C with 16 min and at 80 °C with half the time (8 min). Complete inactivation of kale peroxidase required 16 min at 80°C, 6 min at 85 °C and less than 3 min at 90 and 95°C.

Mondragón-Portocarrero *et al.* (2006) reported that blanching of turnips for 2 min in steaming and boiling water. Gonçalves *et al.* (2009) observed that blanching of broccoli caused losses of 90% of peroxidase activity at 70, 75, 80, 85 and 90°C for 6.5; 2.7; 1.2; 0.7 and 0.4 min, respectively. Okoli *et al.* (1988) also reported that blanching of spinach and amaranth at 95 °C for 1 min was sufficient to inactivate the peroxidase.

Thermal resistance of enzymes is traditionally expressed in terms of *D*-values and *z*-values. The semi-logarithmic plot of the changes in peroxidase activity was presented in Figure 2.

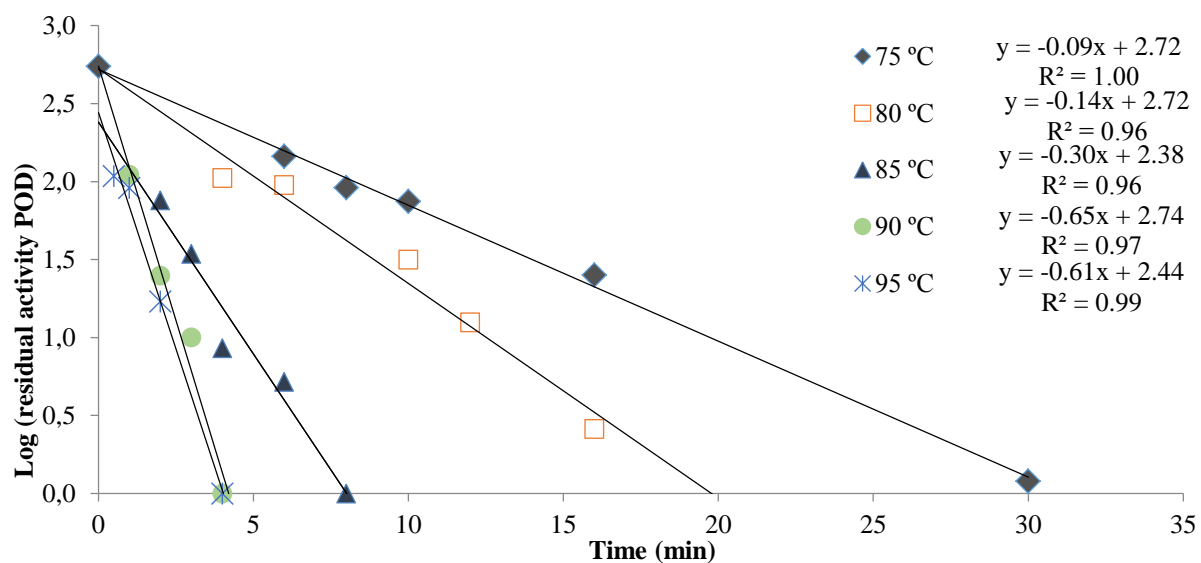


Figure 2.- Decimal reduction curve for peroxidase activity of kales.

Thermal degradation kinetic of peroxidase followed a first-order kinetics, with high  $R^2$  values (0.96-1.0). *D* values ranged between 11.28 and 1.24 at the temperatures studied. *z* value for thermal inactivation of peroxidase was 15.51 °C ( $R^2 = 0.97$ ). This result was in agreement with those reported by Rayan *et al.* (2011), who found that *z* values for POD from cauliflower was 15.27 °C, and it is in the range of those obtained for other vegetables, which ranged from 13.56 °C for turnip puree to 37 °C for corn-on the cub POD (Holdsworth, 1992).

The thermal sensitivity of an enzyme is affected by a number of different factors such as pH, ionic strength of the medium or type of vegetable.

## Conclusions

Kales peroxidase enzyme inactivation due to water blanching treatments follows first-order model kinetics. Six min at 85 °C and less than 3 min at 90 and 95°C are sufficient to inactivate 90% of the peroxidase activity. The kinetic parameters ( $D$  and  $z$ ) could be used to optimize the blanching process in kales, reducing the process time and thus minimizing the loss of nutritional and sensory properties.

## References

- Aamir M., Ovissipour M., Sablani S.S., Rasco B. (2013). Predicting the quality of pasteurized vegetables using kinetic models: a review. *International Journal of Food Science and Technology*, 29 pages <http://dx.doi.org/10.1155/2013/271271>.
- Arnnok P., Ruangviriyachai C., Mahachai R., Techawongstien S., Chanthai S. (2010). Optimization and determination of polyphenol oxidase and peroxidase activities in hot pepper (*Capsicum annuum* L.) pericarb. *International Food Research Journal*, vol. 17, pp. 385–392.
- Bifani V., Inostroza J., Cabezas M.J., Ihl, M. (2002). Determination of kinetic parameters of peroxidase and chlorophyll in green beans (*Phaseolus vulgaris* cv. Win) and stability of the frozen product. *Journal of Theoretical and Applied Chemistry*, vol. LIX, pp. 57–64.
- Böttcher H. (1975). Enzyme activity and quality of frozen vegetables. Part I. The residual activity of peroxidase. *Die Nahrung*, vol. 19, pp. 173-177.
- Fils B., Sauvage F.X., Nicolas, J. (1985). Tomato peroxidase, purification and some properties. *Sciences des Aliments*, vol. 5, pp. 217-232.
- Gonçalves E.M., Pinheiro J., Alegria C., Abreu M., Brandao T.R.S., Silva C.L.M. (2009). Degradation kinetics of peroxidase enzyme, phenolic content, and physical and sensorial characteristics in broccoli (*Brassica oleracea* L. ssp. *italica*) during blanching. *Journal of Agricultural and Food Chemistry*, vol. 57, pp. 5370-5375.
- Günes B., Bayındırlı A. (1993). Peroxidase and lipooxygenase inactivation during blanching of green beans, green peas and carrots. *Lebensmittel Wissenschaft und Technologie - Food Science and Technology*, vol. 26, pp. 406-410.
- Holdsworth S.D. (1992) *Aseptic processing and packaging of food products*. Elsevier Applied Science, London.
- Mondragón-Portocarrero A.D.C., Pena-Martínez B., Fernández-Fernández E., Romero-Rodríguez A., Vázquez-Odériz L. (2006). Effects of different pre-freezing blanching procedures on the physicochemical properties of *Brassica rapa* leaves (Turnip Greens, Grelos). *International Journal of Food Science and Technology*, vol. 41, pp. 1067-1072.
- Okoli E.C., Nmorka O.G., Unaegbum M.E. (1988). Blanching and storage of some Nigerian vegetables. *International Journal of Food Science and Technology*, vol. 23, pp. 639–641.
- Połata H., Wilińska A., Bryjak J., Polakovič M. (2009). Thermal inactivation kinetics of vegetable peroxidases. *Journal of Food Engineering*, vol. 91, pp. 387-391.
- Rayan A.M., Gab-Alla A.A., Shatta A.A., El-Shamei, Z.A. (2011). Thermal inactivation kinetics of quality-related enzymes in cauliflower (*Brassica oleracea* var. *botrytis*). *European Food Research and Technology*, vol. 232, pp. 319-326.
- Williams D.C., Lim M.H., Chen A.O., Pangborn R.M., Whitaker J.R. (1986). Blanching of vegetables for freezing: which indicator enzyme to choose. *Food Technology*, vol. 40, pp. 130–140.

Yemenicioğlu A., Özkan M., Velioglu S., Cemeroğlu B., (1998). Thermal inactivation kinetics of peroxidase and lipoxygenase from fresh pinto beans (*Phaseolus vulgaris*). *Zeitschrift für Lebensmitteluntersuchung und –Forschung A*, vol. 206, pp. 294–296.

## THE YIELD AND YIELD COMPONENTS OF SOME SILAGE MAIZE (*ZEAMAYS L.*) VARIETIES AS THE SECOND CROP

Bilal KESKİN\*, Hakkı AKDENİZ, Süleyman TEMEL, Barış EREN

Iğdır University, Agricultural Faculty, Department of Field Crops, Turkey

\*Corresponding author: bilalkeskin66@yahoo.com

### Abstract

The aim of this experiment was to assess yield and yield components of ten silage maize varieties (72 MAY 80, OSSK 644, TK 6063, OSSK 596, TK 6060, HİDO, RX 9292, 71 MAY 69, SHEMALL and OSSK 602) at the Agricultural Research and Extension Center, Iğdır University from North East Turkey, in 2015. The experimental design was the completely randomized block with three replications on the soils of a clay silt loam. Results of experiments indicated that the yield and yield components of silage maize varieties as second growing crop were significantly different. It was reported that highest plant height (271.5 cm, OSSK 644), forage yields (99.47 t ha<sup>-1</sup>, TK 6063), dry matter ratios (38.92%, HİDO), dry matter yields (31.49, 31.52 and 31.63 t ha<sup>-1</sup>, TK 6063, HİDO, TK 6060 respectively), leaf ratios (24.92%, RX 9292), stem ratios (49.49%, HİDO), cob ratios (49.58%, TK 6063), leaf number (13.23 pieces, HİDO) and plant weights (1044.58 g, TK 6063) were found. It could be concluded that TK 6063 maize variety seemed to be the best suitable for silage between examined maize varieties and based on forage yield, dry matter yield, cob ratio and plant weight in the region conditions.

**Keywords:** *maize, varieties, yield, second crop*

### Introduction

Maize (*Zea mays* L.) is one of the most important juices in animal feed, either green or as silage in the feed chain. The increase in the need for roughage in the livestock sector in recent years has naturally led to increased interest in silage maize varieties. Early maturing varieties are also very important so that they can be stored easily and do not create an extra drying cost (Vartanlı, 2006). Even though there is no serious hunger problem in our country today, an unbalanced feeding, especially based on cereals is seen. Most of the commonly used roughage feeds in our country constitute very low harvest residues in terms of animal feed known as straw. Maize has a great importance in terms of high yield from the unit area in summer grain types and especially in the short term because it is a product that can be grown in the year (Emeklier, 1990). As a result of the studies carried out numerously, it has been emphasized that the identification of genotypes suitable for ecological conditions in the plant species with such a wide varieties is vital (Sade et al., 2005). This research was carried out to determine performances of some silage maize varieties regarding yield and yield components as the second crop in 2015.

### Material and methods

The study was conducted on ten maize hybrids (72 MAY 80, OSSK644, TK6063, OSSK 596, TK 6060, HİDO, RX 9292, 71MAY69, SHEMALL and OSSK 602) and all the maize cultivars were sown in the experimental soil with clay-loamy texture, pH 8.6, lightly salted (EC 1.37 dS/m), organic matter content (1.20%) and lime content (CaCO<sub>3</sub>: 22.27%),

(Erdogan, 2013) 24 June 2015 at the Agricultural Research and Extension Center, Iğdır University from North East Turkey. The crop was sown in 3 replications using randomized complete block design. Ammonium sulphate half of the rate of 150 kg ha<sup>-1</sup> and triple super phosphate at the rate of 10 kg P<sub>2</sub>O<sub>5</sub> were applied for all plots as a fertilizer, and the rest of nitrogen were applied when the plants were reached to 40-50 cm height. The ten maize cultivars used for this research were chosen from the area with loam and sandy soil, in the texture of Agricultural Faculty of Iğdır University in last week of June 2015. The experimental design was a randomized complete block with three replications (the soil lime 6.53%, soil pH 7.98, soil electrical conductivity 1.8 dS m<sup>-1</sup>). The plots size was 5 m x 3.5 m, having a row spacing of 0.70 m and space between plants of 0.20 m. Before planting, half of the total fertilizer with 15 kg pure N (ammonium sulphate with 21% N) and all phosphorus with 10 kg P<sub>2</sub>O<sub>5</sub> were applied for all plots. The mean temperature from April to September was 22.8 °C, relatively moisture 43.2, mean precipitations 23.8 mm and the lowest precipitation was 4.7 and 5.0 mm (Anonym, 2015). Irrigations were applied by sprinkler system until the flowering, and then furrow irrigation were applied in all plots of the experiment according to the capacity of the soil. The two centered rows of each plot were harvested when the kernel was at the milk-dough stage for forage yield on 24 June 2015. The morphological fractions of the plant leaves (blade + sheath), cobs were separated from the stem from each plot manually.

### Statistical analysis

The data of the research were subjected to a variance analysis using analysis technique, and Duncan's multiple comparison tests was applied to compare treatments means (SPSS, 1991).

## Results and discissions

**Plant height (cm).** Forage plant height (cm), forage yield, dry matter ratio (%) and dry matter yield (t ha<sup>-1</sup>) of silage maize varied significantly by variety (Table 2). Plant height is an important component which helps in the determination of grow attained during the growing period. Plant height ranged from 206.7 to 271.3 cm with the trial average being as a means of maize varieties. Plant height was highest in the OSSK 644 variety (271.3 cm), though did not statistically differ from other varieties except from OSSK 602 variety (Table 1). The present results fit with the findings of Keskin at al. (2017). The results of the plant height were found to be partially similar to plant height ranged 250.8-291.8 cm by Atakul at al. (2016). Akdeniz and Koç (2017) reported that the plant length was 273.6-316.9 cm, Tantekin et al. (2017) that height of the plants was 263.33–314.66 cm.

However, there was a relationship between forage yield and plant height (Fig. 1).

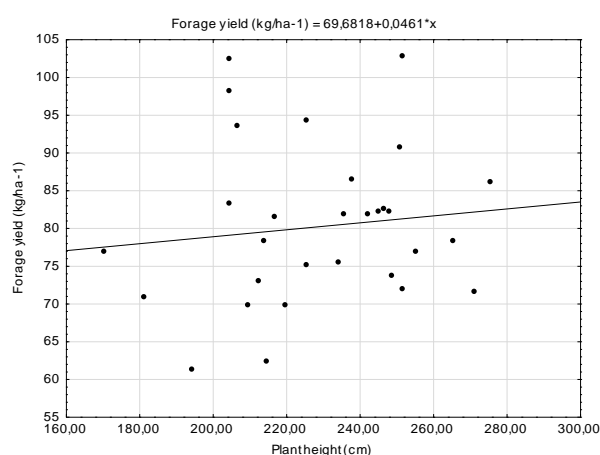


Figure 1. A relationship between forage yield and plant height

**Forage yield (t ha<sup>-1</sup>).** As is presented in Table 1, forage yield ranged from 64.16 t ha<sup>-1</sup> with OSSK 602 variety to 99.47 t ha<sup>-1</sup> with TK 6063 variety. The highest forage yields were obtained from TK 6063 and TK 6060 varieties in the present trial in Figure 2. These findings of forage yields were quietly consisted with some varieties although forage yields are lower than finding by Keskin et al. (2017). Atakul at al. (2016) green herbage yields maize, (55.92-80.87 kg ha<sup>-1</sup>), Akdeniz at al. 2004 found considerable differences among cultivars in green herbage 28.5-76.08 kg ha<sup>-1</sup> and hay 7.4-14.6 kg/ha-1, Akdeniz and Koç (2017) suggested that average yields of maize cultivars with 45.6-58.9 kg ha<sup>-1</sup> were higher than results of this trial. Also, Tantekin et al. (2017) cited that green herbage yield was 56.9-108.2 kg ha<sup>-1</sup>. These differences can be attributed agronomic, edaphic and environmental factors responsible for these differences yields

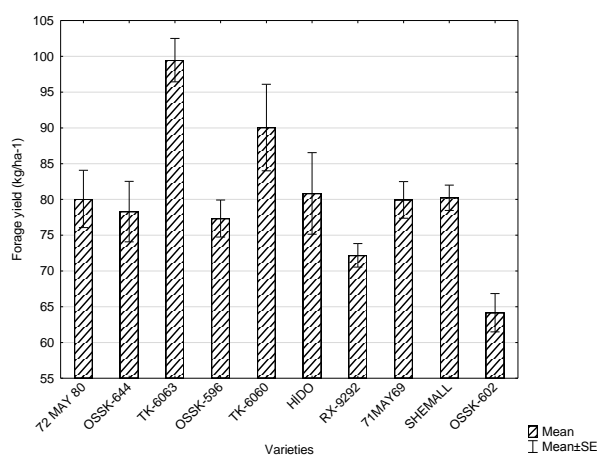


Figure 2. Forage yield of maize silage hybrids

**Dry matter ratio (%).** Whole-plant dry matter ratios (%) of hybrids had significant differences among maize hybrids. The highest and lowest dry matter content of maize varieties was obtained from the SHMALL variety with 31.12% and the HİDO with 38.92%, respectively. As all the varieties were harvested on the same date, the HİDO variety was the earliest growing variety. It may depend on the different stages of onset of these types. However, results of the investigation of present have also similar dry hay rates by Keskin et al. (2017). Akdeniz and Koç (2017) confirmed that according to the results of the trial, green silage yields were significant differences between of both maize varieties and localities.

**Dry matter yield (kg/ha<sup>-1</sup>).** As the stand point of view of dry matter yield of maize are significant differences between varieties, the highest dry matter yields were 72 MAY 80, OSSK 644, TK 6063, OSSK 596, TK 6060 and HİDO are the same group in respect of dry matter yield. However, the values of maize hybrids range from 21.84 to 31.63 t ha<sup>-1</sup>, OSSK 602 variety had the lowest value 21.84 (t ha<sup>-1</sup>). It is seen that researchers by Keskin at al.(2017), who finds the average results of hay yields higher than this study and is quietly compliance with the kind of OSSK 602 in particular, however, with 31.49 t ha<sup>-1</sup> of TK 6063 variety had the lowest yield. Coors et al. (1994) suggested that forage dry matter yield and quality traits are genetically variable in maize. Hybrids differences in dry matter yield have (Akdeniz at al. 2004; Atakul at al. 2016).

Table 2. Plant height, forage yield, dry matter ratio and dry matter yield of maize varieties

Variety	Plant height (cm)	Forage yield (t ha <sup>-1</sup> )	Dry Matter ratio (%)	Dry Matter yield (t ha <sup>-1</sup> )
72 MAY 80	223.0 bc	80.07 bc	37.83 ab	30.28 ab
OSSK 644	271.3 a	78.30 c	35.60 abc	27.88 ab
TK 6063	221.4 bc	99.47 a	31.66 d	31.49 a
OSSK 596	250.3 ab	77.33 c	34.42 bc	26.57 abc
TK 6060	214.9 bc	90.05 ab	35.06 abc	31.63 a
HIDO	223.1 bc	80.84 bc	38.92 a	31.52 a
RX 9292	235.9 abc	72.17 cd	34.22 bc	24.70 bc
71 MAY 69	226.6 bc	79.93 bc	37.75 ab	30.25 ab
SHEMALL	220.4 bc	80.23 bc	31.82 c	25.47 bc
OSSK 602	206.7 c	64.16 d	34.00 bc	21.84 c

\* There were not significant differences in P<0.05 level among averages shown with same letter.

**The leaf ratio (%).** The leaf ratio of maize varieties in the study was statistically significant among the cultivar, and the highest ratio (24.92 %) and the lowest ratio (14.23 %) were obtained from RX 9292 and TK 6063 varieties among cultivars, respectively, Table 2. However, there was a negative relationship between forage yield and leaf ratio (Fig 3.). In addition to these findings were higher than the value of leaf ratios cited by Keskin et al. (2017) and the leaf ratios of these two varieties were found to be quite similar to results of the trial. That is why the varieties are stable in similar ecologies.

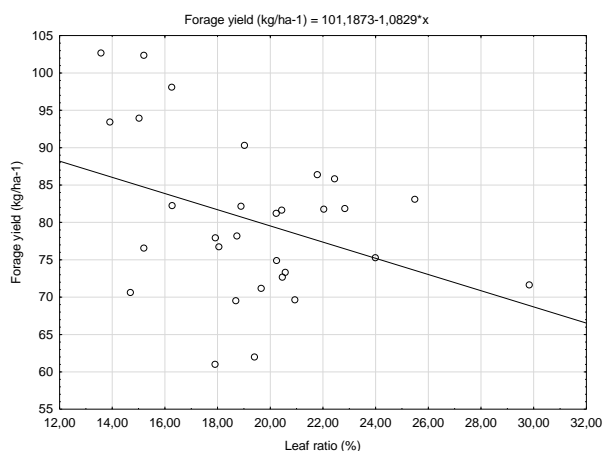


Figure 3. A relationship between forage yield and leaf ratio

**Stem ratio (%).** Stem ratios of maize ranged from 31.90% with 71 MAY 69 and 49.49% with HIDO variety. Table 2. As a means of the stem, ration does not consist of results pointed out by Keskin at al. (2017). Tantekin et al. (2017) stated that the range of the ratio of stem plant with 41.93-58.50 % was higher than our present study. Some of the differences are due to the genetic structure of the varieties, as well as the environmental factor, sowing time, irrigation, fertilization, hoeing and so on. However, as was seen in Fig. 4, a relationship between forage yield and stem ratio has not been very clear.



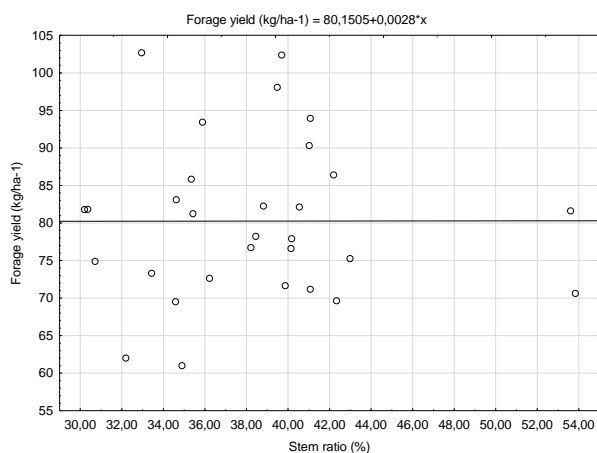


Figure 4. A relationship between forage yield and stem ratio

**Cob ratio (%).** The number of cobs per plant is a crucial yield parameter of maize. Cob ratio percentages had significant differences among maize hybrids. The highest cob ratio had 49.58% with TK 6063 variety. However, there were no differences between OSSK 596 and TK 6060. The lowest cob ratios 32.45% and 33.34 % were HÍDO and RX 9292 varieties, respectively. In general, varieties with high stalk ratios were observed to have low cob of maize ratios. In both results of cob/plant was 20.37-38.50 % by Tantekin et al. (2017) and the results of cob ratios (cob/plant (%27.3-%45.0) by Atakul et al. (2016) were higher than our values of cob percentages. These different results might be due to the changes in the genetic make-up of hybrid maizes. It is clearly seen that the cob (ear) ratio is positive on the herbage yield in figure 4, and that it is necessary to take into account the selection of varieties.

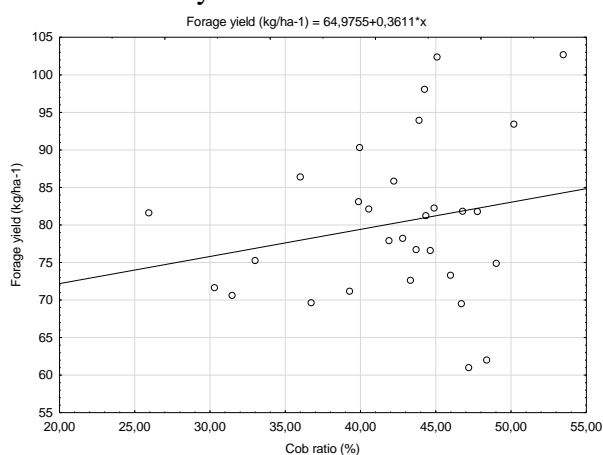


Figure 5. A relationship between forage yield and cob ratio

**The number of leaves per plant.** The number of leaves of silage maize ranged from 10.53 to 13.23, leaf numbers of HÍDO and 71 MAY 69 varieties was counted, respectively. In both numbers of leaves and leaf ratio on a relationship between on forage yield was the negative relationship. However, there was a slightly negative relationship forage yield and number of leaves per plant in Fig. 6.

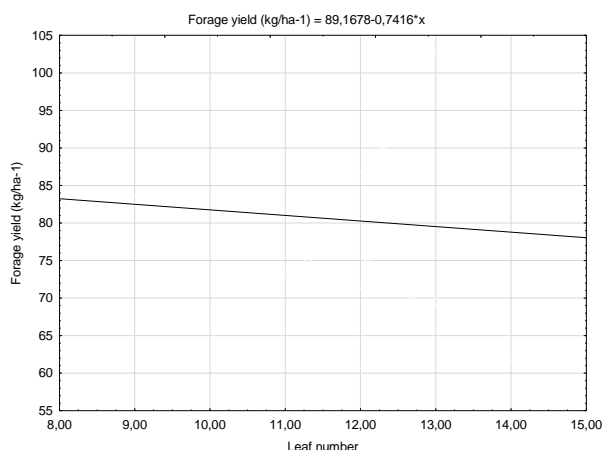


Figure 6. A relationship between forage yield and leaf number

**Weight per plant (g).** As regarded maize varieties showed in Table 2, plant weights (g) of maize hybrid had significant differences among maize hybrids, ranged from OSSK 602 with 673.80 g to TK 6063 variety with 1044.58 g. It is clear from the data the weight per plant was progressively increased with in herbage yield (kg/ha<sup>-1</sup>).

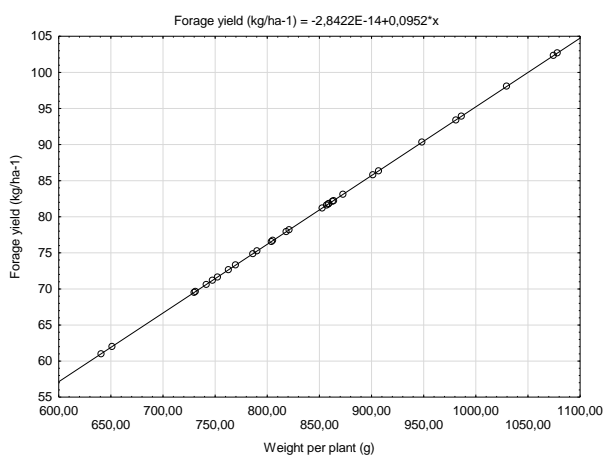


Figure 6. A relationship between forage yield and weight per plant

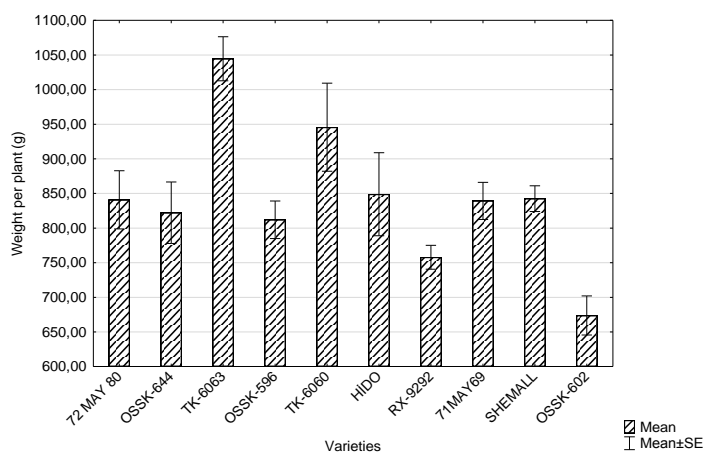


Figure 7. Weight per plant depends on maize varieties

Table 3. Leaf ratio, stem ratio, cob ratio, leaf number and plant weight of maize varieties

Variety	Leaf ratio (%)	Stem ratio (%)	Cob ratio (%)	Number of leaves per plant	Weight per plant (g)
72 MAY 80	20.82 abc	37.95 bcd	41.21 b	12.00 abc	840.80 bc
OSSK 644	20.00 bc	38.86 bc	41.12 b	12.43 ab	822.23 c
TK 6063	14.23 d	36.18 bcd	49.58 a	13.13 ab	1044.58 a
OSSK 596	18.22 bcd	38.04 bcd	43.73 ab	11.53 abc	812.06 c
TK 6060	16.67 cd	39.67 bc	43.66 ab	11.43 bc	945.64 ab
HİDO	18.05 bcd	49.49 a	32.45 c	13.23 a	848.94 bc
RX 9292	24.92 a	41.73 b	33.34 c	12.26 abc	757.94 cd
71 MAY 69	22.85 ab	31.90 d	45.23 ab	10.53 c	839.33 bc
SHEMALL	18.79 bcd	35.25 bcd	45.45 ab	10.56 c	842.53 bc
OSSK 602	18.67 bcd	33.90 cd	47.43 ab	13.00 ab	673.80 d

\* There were not significant differences in P<0.05 level among averages shown with same letter.

### Conclusion

It can be concluded that TK 6063 maize variety seemed to be the best suitable based on forage yield, dry matter yield, and cob ratio and plant weight between silage maize as a second crop in the local agro-ecological conditions. Yield and quality should be taken into consideration when selecting hybrids for forage. TK 6063 maize variety was the best suitable plant regarding the quality of the silage and green herbage.

### References

- Tantekin G.U and Turan N. 2017. Determination of Yield and Yield Components of Some Silage Maize (*Zea mays* L.) Varieties Under Diyarbakır Ecological Conditions. International Conferences on Agriculture, Fores, food science and Technologies (ICAFOF), 15-17 May 2017, Cappodia-Turkey
- Akdeniz H, Koç A. 2017. The Determination of Performance of Some Hybrid Maize Varieties Grown in Ceylanpınar Agricultural Enterprise. International Conferences on Agriculture, Fores, food science and Technologies (ICAFOF), 15-17 May 2017, Cappodia-Turkey
- Sade B., S. Soylu, Ç. Palta, 2005. Melez Mısır Çeşitlerinde Tane Verimi ve Verim Unsurları Arasındaki ilişkilerin Korelasyon Path ve Faktör Analizi Yöntemleri ile Değerlendirilmesi /Assessment of Relationships Between Grain Yield and Yield Components in Cornificated Maize Varieties by Correlation Path and Factor Analysis Methods/. VI. Tarla Bitkileri Kongresi Kitabı II: 989–994.
- Vartanlı, S. 2006. Ankara koşullarında hibrit mısır çeşitlerinin verim ve kalite özelliklerinin belirlenmesi /Determination of yield and quality characteristics of hybrid maize varieties in Ankara conditions/. A.Ü. Fen Bilimleri Enstitüsü Yüksek Lisans Tezi, Ankara.
- Deinum, B., and J.J. Bakker. 1981. Genetic differences in digestibility of forage maize hybrids. *Neth. J. Agric. Sci.* 29:93–98.
- Atakul Ş, Kahraman Ş, Kılınç S. 2016. Diyarbakır ikinci ürün şartlarında bazı silajlık mısır genotiplerinin verim ve verim unsurlarının belirlenmesi /Determination of the yield and yield components of some silage maize genotypes in Diyarbakır/. *DUFED* 5(2) (2016) 47-50.

- Akdeniz, H, Yılmaz İ, Andiç N, Zorer Ş, 2004. A Study on Yield and Forage values of Some Maize Cultivars. *Yuzuncu Yil University Journal of Agricultural Sciences (YYU J Agr Sci.)*, 14 (1):47-51.
- Erdogan H, E, 2013. *Soil Definition Guide.*, ISBN: 978-605-4672-20-2.
- Keskin B, Akdeniz H, Yılmaz İ.H, Turan N, 2005. Yield and Quality of Forage Maize (*Zea mays* L.) as Influenced by Cultivar and Nitrogen Rate. *Journal of Agronomy* 4(2):138-141.
- Sade B, 2002. *Maize Agriculture.* Konya Commodity Exchange Pub. No: 1. Konya.
- SPSS Inc., 1991. *Statistical Package For The Social Sciences (SPSS/PC+).* Chicago, IL.
- Coors, J.G., P.R. Carter, and R.B. Hunter. 1994. Silage maize. *In* A.R. Hallauer (ed.) *Specialty maizes.* CRC Press, Boca Raton, FL.

## THE EFFECT OF FERTILIZATION ON *LAVANDULA ANGUSTIFOLIA* L. YIELD IN NORTH GREECE

Elpiniki SKOUFOGIANNI, Kyriakos D. GIANNOULIS\*, Dimitrios BARTZIALIS, Dimitra TZOUVARA, Nicholas G. DANALATOS

University of Thessaly, Department of Agriculture, Crop Production & Rural Environment, Volos, Greece

\*Corresponding author: kyriakos.giannoulis@gmail.com

### Abstract

*Lavandula angustifolia* L. is a small orthodontic shrub with a dense branch. Spruces are of square cross-section, which quickly become woody. The leaves are about 5 cm long and linear. The color of the flowers is purple. Flowering shoots of this species contain 1.5-3% of essential oil. In this study we investigated the effect of four different fertilization types (F1: black, F2: organic, F3: 34.5-0-0 and F4: 10-20-0) on fresh and dry weight of the perennial *Lavandula angustifolia* L. during the establishment year and the 2<sup>nd</sup> year after establishment at an experimental farm at Kozani, North Greece in 2015 and 2016. It is well documented that the crop reaches its potential yield on the third-fourth year of cultivation and continues producing biomass for six to seven more years. Upon harvest (September 2015) during the establishment year, the crop reached a maximum dry yield of 0.22 tons per hectare and almost the double yield 0.74 t ha<sup>-1</sup> for the treatment of the organic fertilization which produced the higher yield. Therefore, the above data show that *Lavandula* cultivation could be a promising alternative crop, especially in case of the consideration that average selling price of dry drogue in Greece is 3.5-5 € kg<sup>-1</sup>, while the selling price of its essential oil is 100 € kg<sup>-1</sup>.

**Keywords:** *Lavandula angustifolia* L, fertilization, fresh yield, dry yield.

### Introduction

Lavender belongs to the family of the Lamiaceae (Order: Lamiales) and is mainly grown for essential oils. In the same family, there are also other crops such as basil, hyssop, marjoram, peppermint, oregano, rosemary, thyme etc., (Bruneton, 1999). The most well-known representatives of *Lavandula* are the genes *Lavandula angustifolia* (*L. officinalis*), *L. latifolia*, *L. stoechas*, *L. burnatii*, *L. dentata*, *L. canariensis*, *L. abrotanoides*, *L. lanata*, *L. multifida*, *L. pinnata*, *L. viridis*, *L. x Intermedia*, *L. luisierii*. *L. hybrida* (sin. *L. x intermedia*) is common in Romania and has a high productivity (Silvia Robu et al., 2015).

*Lavandula* species exhibit a variety of antimicrobial activity and some species also exhibit antifungal activity as well as antioxidant activity. *Lavandula* species contain low levels of toxicity, since the essential oil is used in burns with therapeutic effect even in insoluble form, which has not been proved medical and pharmaceutical, although allergic dermatitis has been reported as a case (Balchin, 2002).

Lavender is a perennial low shrub. The aromatic leaves have a length of 5 cm and the flowers are distinguished by cross peaks and the sweet aroma (Curtis, 2005). There are many varieties in the wooden shrubs form and a height higher than one meter (Balchin, 2002).

The plantation can take place from spring till autumn. Researchers have found that autumn plantation produces more flowers in the coming year (Kimbrough & Swift, 2009). Lavender can be a long-standing crop with a typical productive life of about 10 years, although plants are known to live for 20 years.

Lavender requires well-drained soil, sandy soils and full sunshine, and therefore areas with high altitudes are preferred. Low fertility soils are still appropriate. The soil pH should range between 5.8 and 8.3. Very wet soils will cause poor plant growth, diseases or total destruction of the crop. English lavender varieties prefer alkaline soils, while levantine varieties require slightly more acidic soils (Directorate Plant Production in collaboration with SAEOPA and KARWIL Consultancy, 2009).

Lavender can tolerate moderate frost and drought, while long-lipped lavender cannot tolerate frost. All lavender varieties are sensitive to high humidity. High summer temperatures adversely affect the quality of the essential oil (Directorate Plant Production in collaboration with SAEOPA and KARWIL Consultancy, 2009). Whole flowering plants can be used to produce essential oil (Adam, 2006).

In its natural state, narrow-leaved lavender is cultivated at altitudes of up to 1.700 meters, while long-leaved lavender is grown only in the lower regions and is indigenous in areas from 200 to 700 meters from sea surface. The yields of essential oil increase as the altitude rises because the plant blossoming in cold areas is more abundant (Directorate Plant Production in collaboration with SAEOPA and KARWIL Consultancy, 2009).

Lavender can produce a well yield with an annual precipitation of 300 to 1400 mm. Soil should be able to dry well between irrigations and is not allowed the irrigation to an excessive extent (Directorate Plant Production in collaboration with SAEOPA and KARWIL Consultancy, 2009).

Trace elements affect the final yield and the quality of aromatic-medicinal plants. In an experiment conducted to determine the effects of nitrogen (N: 150-175-200-225-250 mg/L) and phosphorus (P: 30-40-50-60-70 mg/L) on the morphological and Biochemical characteristics of lavender under hydroponic status, showed that P levels mainly affected plant growth, while lower levels of N (150 mg/L) reduced chlorophyll content. Essential oil performance remained unaffected and independent of N and P levels (Chrysargyris et al., 2016).

This study was conducted in an attempt to enrich the relatively few data on plant growth and productivity of *Lavandula angustifolia* L. in Greece. For the purposes of the study the effect of four different fertilization types (F1: black, F2: organic, F3: 34.5-0-0 and F4: 10-20-0) on fresh and dry weight of the perennial *Lavandula angustifolia* L. during the establishment year and the 2<sup>nd</sup> year after establishment at an experimental farm of Kozani, North Greece in 2015 and 2016 was investigated.

## Materials and Methods

*Lavandula angustifolia* L. was established in a Kozani region (Greece). The transplanting took place on 3/5/2015, at a distance of 0.6m on the line and 0.6m between the lines. Plants were irrigated with 1 liter of water/plant during establishment. The effect of four different fertilization types (F1: black, F2: organic, F3: conventional 20-10-10 and F4: N-NO<sub>3</sub> 46-0-0) on fresh and dry weight of the perennial *Lavandula angustifolia* L. was investigated during the establishment year and the 2<sup>nd</sup> year after establishment at an experimental farm of Kozani, North Greece in 2015 and 2016.

The application of the fertilizers took place by hand, while the quantities of each fertilizer type were 0 gr/plant for the F1 (blanc treatment), 60 gr/plant for the F2 (organic fertilizer 6-0.5-0.3 and 85% O.M.), 10.46 gr/plant for the F3 (34,5-0-0) and 36.1 gr/plant for the F4 (10-20-0).

The experiment had a randomized block design (Graph 1) and each block had an area of 48 m<sup>2</sup>, while 576 plants in total were planted. Flowers, leaves and shoots after harvesting were dried in a dark place at room temperature. The fresh and dry weight data were analyzed using the GenStat 7<sup>th</sup> Edition statistical package.

## Results and Discussion

### Soil Analysis

The soil used for the cultivation was a semi-fertile as it is presented in the following Table 1.

Table 1. Chemical properties of the field experiment.

Property	Soil depth (0-30) cm	Soil depth (30-60) cm
	Before transplanting	After harvest
Texture	Clay-Loam	Clay-Loam
pH (1part soil:5parts H <sub>2</sub> O)	7.6	7.6
Organic matter (%)	1.8	1.8
Sand (%)	29	29
Clay (%)	33	29
Silt (%)	38	42
CaCO <sub>3</sub> (%)	22.0	20.5

### Fresh Yield

In Figure 1 is illustrated the average fresh weight of lavender as it is affected from the four different used fertilizer types.

There was found statistical significant difference (Table 2) between the used fertilizer types and the zero fertilization (F1). It was found that the use of the F2 (organic) type produced almost higher fresh yield in both years (2 tha<sup>-1</sup> and 3 tha<sup>-1</sup> in 2015 and 2016 respectively). Specifically, the average yield for the F2 fertilizer type was higher than the double of the zero treatment.

Finally, as it was expected the total fresh yield increased in 2016 irrespective of treatment due to the perennial nature of the plant.

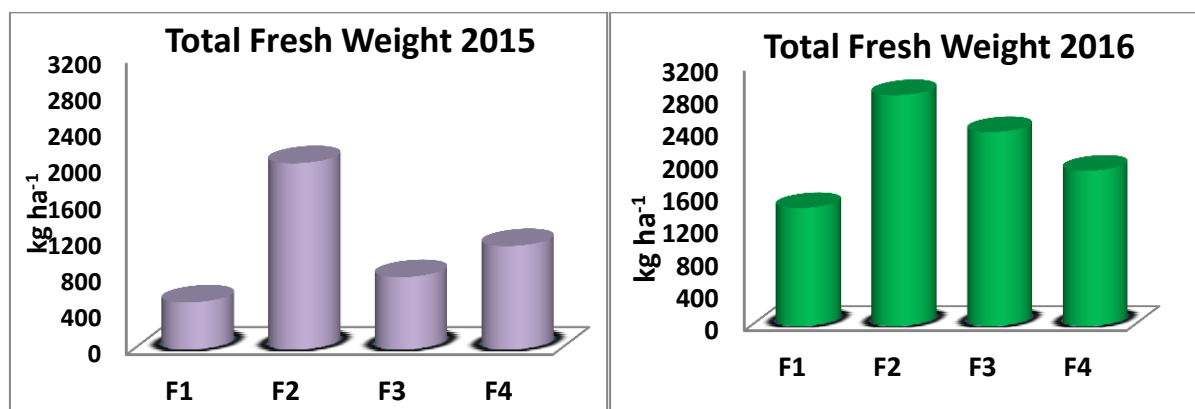


Figure 1. Total fresh weight of *Lavandula angustifolia* L. as affected by the four different fertilizer types (F1: Blanc, F2: organic, F3: 34.5-0-0 and F4: 10-20-0).

**Table 2.** Total fresh weight of *Lavandula angustifolia* L. under different fertilizer types.

<i>Lavandula angustifolia</i> L.	2015 (kg ha <sup>-1</sup> )	2016 (kg ha <sup>-1</sup> )
Fertilizer type		
F1: Blanc	519	1258
F2: organic	2048	2852
F3: conventional 20-10-10	797	2396
F4: N-NO <sub>3</sub> 46-0-0	1138	1919
LSD <sub>0,05</sub>	265.9	624.0
CV %	19,2	23,5

As it is illustrated in Figure 2 in both harvested years, the fertilizer type F2 prevails and produces a flower fresh weight greater than all the other treatments. Specifically, in 2015, the F2 treatment yields 372 kg ha<sup>-1</sup>, while in 2016 almost triple the yield 1176 kg ha<sup>-1</sup>. The above results are in agreement with experimental results carried out in Poland by testing flower productions with organic fertilization (Seidler-Łożykowska, et al., 2014).

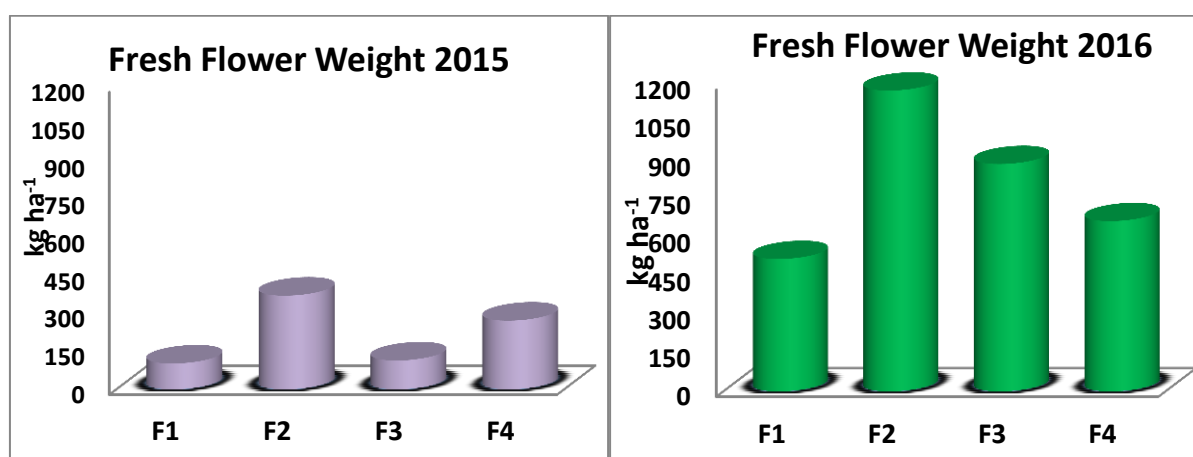


Figure 2. Fresh flower weight of *Lavandula angustifolia* L. as affected by the four different fertilizer types (F1: black, F2: organic, F3: 34.5-0-0 and F4: 10-20-0).

**Table 3.** Fresh flower weight of *Lavandula angustifolia* L. under different fertilizer types.

<i>Lavandula angustifolia</i> L.	2015 (kg ha <sup>-1</sup> )	2016 (kg ha <sup>-1</sup> )
Fertilizer type		
F1: Blanc	103	518
F2: organic	372	1176
F3: conventional 20-10-10	115	889
F4: N-NO <sub>3</sub> 46-0-0	273	666
LSD <sub>0,05</sub>	129.7	317.2
CV %	28.8	15,9

ns: non significant difference

### Dry yield

It is clearly shown in Figure 3 that the F2 treatment reached the amount of 737 kg ha<sup>-1</sup> total dry weight in the first year, yield which is almost the double comparing with the rest treatments. Similarly, in 2016 it is obvious that the organic fertilization (F2 treatment) maintains the higher total dry weight of 1227 kg ha<sup>-1</sup>, followed by slight non significant differences (Table 3) in the yields of F4 and F3 with 1130 and 1171 kg ha<sup>-1</sup> respectively. Finally, the zero fertilization (F1) produced 765 kg ha<sup>-1</sup> total dry weight.



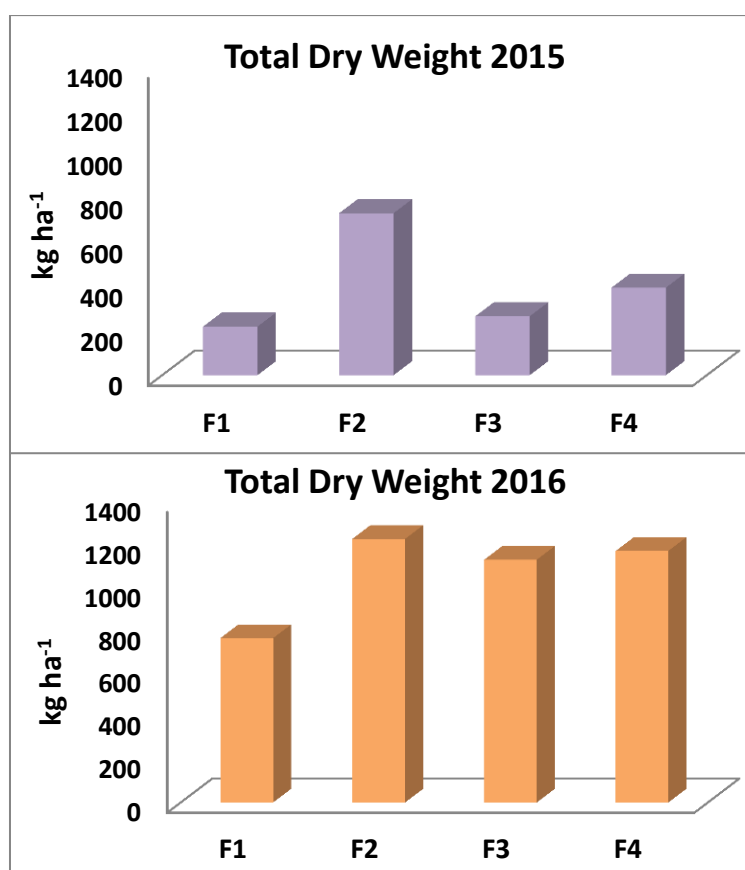


Figure 3. Total dry weight of *Lavandula angustifolia* L. as affected by the four different fertilizer types (F1: Blanc, F2: organic, F3: 34.5-0-0 and F4: 10-20-0).

Table 3. Total dry weight of *Lavandula angustifolia* L. under different fertilizer types.

<i>Lavandula angustifolia</i> L.	2015 (kg ha <sup>-1</sup> )	2016 (kg ha <sup>-1</sup> )
Fertilizer type		
F1: Blanc	221	765
F2: organic	737	1227
F3: conventional 20-10-10	268	1130
F4: N-NO <sub>3</sub> 46-0-0	397	1171
LSD <sub>0.05</sub>	108.3	ns*
CV %	21.7	15,0

ns: non significant difference

The fertilizer type F2 as shown in Figure 4 in both years 2015-2016 produced the higher yields of dry flower followed by F4 and F3. The commercial product of lavender is its flower and the essential oil. Therefore, it could be assumed that F2 type is delivering the best results, and lavender seems to be a plant of low nitrogen requirements.

Therefore, the above data show that lavender cultivation could be a promising alternative crop that could give to farmers an income of 1960-2800 € ha<sup>-1</sup>, in case of the consideration that average selling price of dry flower in Greece is 3.5-5 € kg<sup>-1</sup>.

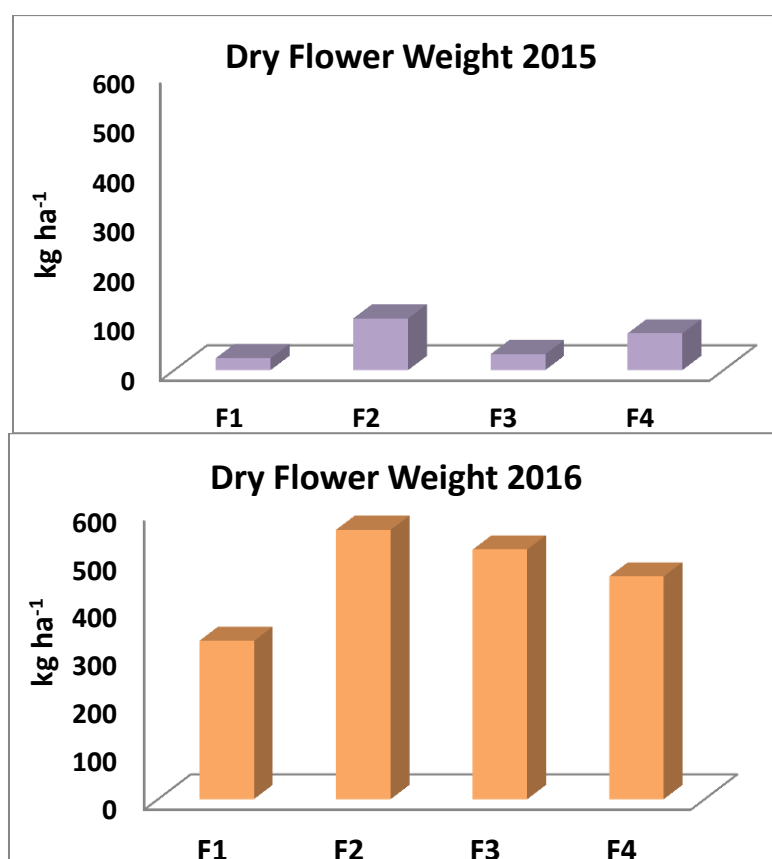


Figure 4. Dry flower weight of *Lavandula angustifolia* L. as affected by the four different fertilizer types (F1: Blanc, F2: organic, F3: 34.5-0-0 and F4: 10-20-0).

**Table 4.** Dry flower weight of *Lavandula angustifolia* L. under different fertilizer types.

<i>Lavandula angustifolia</i> L.	2015 (kg ha <sup>-1</sup> )	2016 (kg ha <sup>-1</sup> )
Fertilizer type		
F1: Blanc	24	329
F2: organic	104	560
F3: conventional 20-10-10	32	519
F4: N-NO <sub>3</sub> 46-0-0	74	463
LSD <sub>0.05</sub>	ns*	ns*
CV %	29,8	22,5

ns: non significant difference

### Conclusions

The general conclusion that was found from this study is that *Lavandula angustifolia* L is a low nitrogen requirement crop, where the organic fertilization triples the yield in comparison with the zero fertilization. Moreover, the organic fertilizer observed constant voltage supremacy of each tested fertilizer type, but a further economical analysis to the fertilizer type is necessary in case to be able to be assumed that the organic fertilization is the most financially advantageous. The organic fertilizer produced 560 kg ha<sup>-1</sup> dry flower setting this crop as a really attractive cultivation for farmers if someone will take in mind the selling price of the dry flower. Therefore, the above data show that lavender cultivation could be a

promising alternative crop, but further investigation is necessary to be conducted as to be able to lead to safer conclusions.

### **References**

- Adam Katherine., (2000). NCAT Trip Report: 15th Annual Conference of the International Herb Association, Saskatoon, Sask. Brian M. Lawrence described Avoca operations in some detail in the course of giving the Richter Memorial Lecture, “Which Essential Oil Crops Have Potential in North Carolina?” Of particular interest was the economic calculation in choosing to produce a raw material, rather than purchasing it.
- Balchin M.L., (2002). Lavender, The genus *Lavandula*. New York. Pages 296. Taylor & Francis . ISBN 9780415284868 - CAT# TF1514.
- Bruneton, J., (1999). Pharmacognosy , Phytochemistry, Medicinal plants. Pages 1119. Paris. Tec&Doc. ISBN 1898298637, 9781898298632
- Chrysargyris A., Panayiotou C. and Tzortzakis N., (2016). Nitrogen and phosphorus levels affected plant growth, essential oil composition and antioxidant status of lavender plant (*Lavandula angustifolia* Mill.) vol. 83. Pp 577-586.
- Curtis, B., (2005). Lavender production and marketing. Washington State University (WSU) Cooperative Extension Bulletin.
- Directorate Plant Production in collaboration with members of SAEOPA and KARWIL Consultancy., (2009). Lavender production.
- Kimbrough K. and Swift C., (2009). Growing Lavender in Colorado.
- Robu S., Chesaru B.I., Diaconu C., Dumitriubuzia O., Tutunaru D., Stanesku u. and Elena Lacramioara Lisa E., (2015). *Lavandula* *Hybrida*: Microscopic Characterization and the evaluation of the essential oil. *FARMACIA*. 64 (6): 914- 917
- Seidler-Łożykowska K., Mordalski R., Kucharski W., Kędzia B., Bocianowski J., (2014). Yielding and quality of lavender flowers (*Lavandula angustifolia* mill.) from organic cultivation. *Acta Sci. Pol., Hortorum Cultus* 13(6), 173-183.

## EFFECTS OF N AND P FERTILIZATION OF TRITICALE AND COMMON VETCH PLANTS IN PLANT HEIGHT WITH PLANTS DRY-FORAGE YIELD

Ayşe GÜNEŞ<sup>1\*</sup>, Mustafa KIZILŞİMŞEK<sup>2</sup>, Meryem KUZUCU<sup>3</sup>

<sup>1</sup>Harran University, Akçakale vocational college. Turkey

<sup>2</sup>Kahramanmaraş Sütçü İmam University Faculty of Agriculture Department of Field Crops. Turkey

<sup>3</sup>Kilis 7 Aralık University, vocational college. Turkey

\*Corresponding author: aysgns@yahoo.com

### Abstract

This study was conducted to determine the effects of Nitrogen and Phosphorus fertilizers on plant height and plants were Dry-forage yield ranged of intercropped common vetch and triticale in Şanlıurfa province in 2010 and 2012. The study was designed as split-plots where main plots were treated with different levels of phosphorous while split-plots (sub-plots) were treated with different levels of Nitrogen with three replications. 40 and 60% seed ratio for triticale and common vetch respectively was determined based on the available literature. Seed amount in the mixture of individual plants were determined as considering their sole crop seed amount which are 20 and 10 kg/da for triticale and common vetch respectively. Pure Nitrogen and Phosphorous were applied at rate of 0, 3, 6, 9 and 12 kg/da by using fertilizers in the forms of ammonium sulphate and triple super phosphate fertilizers. In the study, 5 different characteristics were investigated. Application of nitrogen and phosphorous fertilizers caused a significant increase in dry forage yields. The highest Tritacale 136.40 cm.. 6 kg/da Nitrogen and 6 kg/da phosphorous were applied. The highest common vetch 99.45 cm. 3 kg/da Nitrogen and 3 kg/da Phosphorous were applied. Dry-forage yield ranged from 762.81 to 1478.8 kg/da. The highest dry yields were 1545.3 kg/da when 9 kg/da Nitrogen and 6 kg/da Phosphorous were applied.

**Key Words:** *Common vetch, Triticale, Nitrogen, Phosphor, Fertilizing, Yield component.*

### Introduction

Balanced and regular feeding is indispensable; vitamins, minerals and fiber-containing foods, as well as protein and carbohydrate diet. For this reason, it is important to feed on animal products if it is important to feed on plant products in terms of human nutrition and health. One of the most important criteria when determining the level of development of the countries is the amount of consumption of animal products per capita. Due to the fact that our country has not developed as much as its breeding capacity in animal husbandry, the animals are fed on grassland basis or the quality of animal products is low because the concentrated feeds used for animal feeding are not in sufficient quality. Our mines, which meet a significant portion of our roughage needs and cover 1/5 of our country's agricultural land, have become irregular and overgrained for decades and become ineffective. For this reason, it is necessary to improve the pastureland by breeding and preservation of pastureland areas and to graze to the extent of their capacities. In addition, the feed value and the digestibility of the hay used in animal feed are low, which causes significant loss of yield in animals. For this reason, while increasing crude yield as a precondition for roughage production, animals are twice as likely to feed on high quality feed even in farmer conditions. In our country, the cultivation of feed crops, which are 6.3% in field agriculture, to 25%. Especially in recent years, animal production enterprises established with government support have increased the amount of

feed deficit which is present, and therefore the lack of feed plants in our region has made us more aware. Feed crops suitable for main and intermediate crops in field agriculture will be evaluated economically with the introduction of crop plants and plenty of good quality feed crops that our animals require. Wheatgrass and leguminous forage crops can be grown pure in agriculture for feed crops, and higher yields and quality crops can be obtained by cultivating these crops as a mixture. The characteristics of the mixtures to be formed should be such that at least one wheat and legume is arranged, the mixtures are suitable for weed or seed production, the ripening times of the plant species in the mixture are close to each other and soil and climate requirements are appropriate. The mixture of cereals such as triticale and barley, which contains vetch, can contribute to the improvement of the physical and chemical structure of the soil, while it can be used as a green fertilizer with grass and grains. In order to obtain the targeted high and high yield of herb by planting legumes and wheat as a mixture, it is necessary to determine the sowing rate of mixed species and the nitrogen and phosphorus fertilizers to be used.

### Material and methods

Özeren Adi vetch and Tacettinbey triticale varieties were used as plant material in the experiment. Özveren vet is a new variety that has been successfully cultivated for dry hay production. The optimum harvesting time for weed is the start of formation of the lower fruits. Tacettinbey tritikale variety is resistant to winter, constancy and laying; the fertilizer reaction and the ability to blend well, is a moderately resistant and early varieties to cast the grain. When triticale is harvested as a green feed during the milking period, it contains 22-24% protein; yield is significantly higher than other grains; dry matter production is high. Ammonium sulphate containing 21% Nitrogen with physiological acid character and triple superphosphate containing 42% P<sub>2</sub>O<sub>5</sub> as phosphorous fertilizer were used in consideration of regional soil. Sanliurfa is under the influence of the Mediterranean climate, including in the Southeast Anatolia climate region. The summers are hot and the arid winters are a mild climate. The experiment was carried out on 25 parcels with three replications according to the parcel trial design divided into random blocks with the phosphorus doses as the main parcel and the nitrogen doses as the sub parcels. In the lower parcels, the parcel size is set to 4 m, the parcel width is 2 m, and the distance between the blocks is 2.5 m. Fertilizer doses; Ammonium sulphate fertilizer at 0-3-6-9-12 kg / da pure N and TSP fertilizer at 0-3-6-9-12 kg / da pure P were used in the future. The total amount of P in the fertilizer and half of the amount of N were planted together with planting, while the other half was given in early seedling stage after emergence. The sides of the parcels were removed from the sides and the sides by 20 cm, and the remaining 5.6 m<sup>2</sup> area was harvested during the full flowering period of the vetch.

Table 1. Average Climate Values of Şanlıurfa Province (2010-2012) (DMİ, 2013)

		OCTB	NOVEM	DECEMB	JANUA	FEBRUA	MARCH	APRIL	MAY
2010-2011	Ort. Temperature (° C)	21.0	16.5	10.4	7.3	7.6	12.3	15.4	21.3
	Top Load. Temperature (° C)	32.1	28.5	26.0	14.6	17.8	25.2	28.5	34.9
	Most Dream. Warm. (° C)	9.8	8.5	3.0	0.3	-0.9	2.3	4.3	11.3
	Lowest Humidity (%)	10.0	10.0	21.0	41.0	30.0	26.0	28.0	24.0
	Precipitation Topl.Kg / m <sup>2</sup>	2.3	0.0	72.1	58.0	28.2	42.0	133.7	39.2
2011-2012	Ort. Temperature (° C)	19.3	9.4	7.4	5.5	5.8	9.7	19.3	22.4
	Top Load. Temperature (° C)	32.7	21.4	16.0	14.8	16.2	21.3	32.6	33.2
	Most Worst (° C)	8.8	-0.4	0.8	-4.3	-1.9	-1.7	6.6	13.0
	Lowest Humidity (%)	25.0	25.0	29.0	54.0	35.0	25.0	11.0	10.0
	Precipitation Topl.Kg / m <sup>2</sup>	12.3	62.1	47.1	170.9	95.8	35.8	23.3	42.3

The vertical distance between the soil surface and the extreme point was measured and the averages were taken in 10 vetch and Triticale plants that were randomly selected before planting (cm) in each plot (Anlarsal and Gülcan, 1988). Dry grass yield (kg / da), dry weed samples randomly taken from each plot were found in the drying cabinet until the weights were fixed at 70oC, then the dry grass weights were found as%. The annual yield of each plot is calculated by multiplying dry hay yield by calculated hay yield (Anlarsal and Gülcan, 1989). The results obtained from the experiments were subjected to analysis of variance according to the split plot design of random blocks and the differences between the experimental subjects were checked by F and LSD tests.



Graph 1. An overview of the experiment.

## Results and discussion

### Triticale plant height

In the first year of the experiment, the lowest triticale plant height value was obtained from the N0P0 plot with 88.13 cm, while the lowest value was obtained from the N6P0 plot with the lowest value of 97.58 cm. The highest triticale plant height values were obtained from N6P6 plots with 136.40 cm in the second year of experiment, while they were obtained in N9P6 plots with 132.64 cm in the first year, depending on years and fertilizer applications.

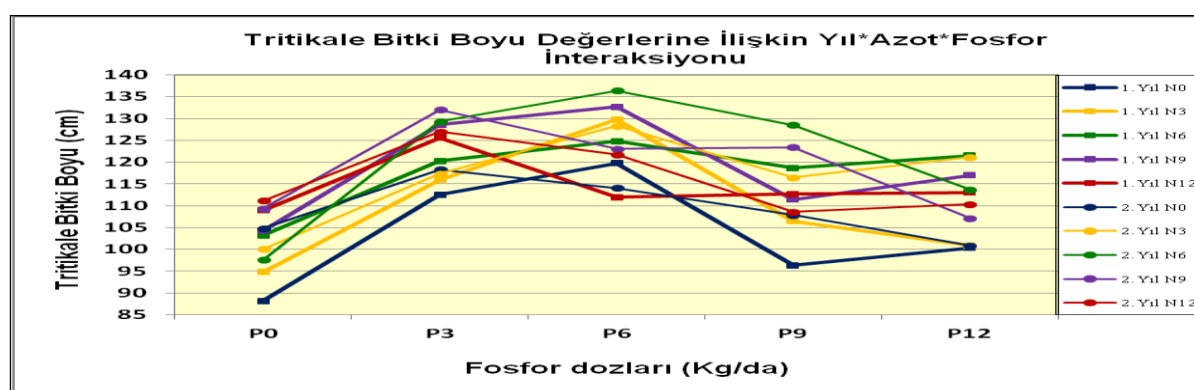
Table 2. Mean Values and Groups of Triticale Plant Height

	Applications	P <sub>0</sub>	P <sub>3</sub>	P <sub>6</sub>	P <sub>9</sub>	P <sub>12</sub>	Ort.
1. Year	N <sub>0</sub>	88.13 m	112.53 e-j	119.77 c-f	96.33 lm	100.37 kl	103.43
	N <sub>3</sub>	94.81 lm	115.96 d-h	129.72 ab	106.45 h-k	100.87 kl	109.56
	N <sub>6</sub>	103.20 j-l	120.27 b-f	124.80 a-d	118.62 d-g	121.50 b-e	117.68
	N <sub>9</sub>	104.27 i-l	128.55 a-c	132.64 a	111.43 f-j	116.97 d-g	118.77
	N <sub>12</sub>	108.95 g-k	125.60 a-d	111.93 e-j	112.64 e-j	113.01 e-i	114.43
	<b>Average</b>	99.87	120.58	123.77	109.09	110.54	112.77
2. Year	N <sub>0</sub>	104.81 j-m	118.31 c-g	114.03 e-i	107.89 i-m	100.83 k-m	109.17
	N <sub>3</sub>	100.03 lm	117.33 c-g	128.31 a-d	116.44 d-h	121.17 b-f	116.66
	N <sub>6</sub>	97.58 m	129.30 a-c	136.40 a	128.51 a-d	113.66 e-j	121.09
	N <sub>9</sub>	109.29 g-l	131.98 ab	123.05 b-f	123.42 b-e	107.16 i-m	118.98
	N <sub>12</sub>	111.11 e-i	126.96 a-d	121.69 b-f	108.55 h-m	110.36 f-l	115.73
	<b>Average</b>	104.56	124.78	124.70	116.96	110.64	116.33

1) The averages indicated by similar letters are not statistically different within the 5% error limits according to the F and LSD test.

According to the results of F and LSD tests, it was determined that the plant height in the N0P0 control plot in the planting of 40% triticale to 60% vetch mixture was found to be statistically significantly lower than the plant height in 5 different nitrogen and phosphorus

applied fractions. Alp (2009); in his work on different triticale varieties he reported that the plant length changed between 98.12-116.35 cm and that the production of Tacettinbey variety for this region would be suitable. The findings are in parallel with our plant height values.



Graph 2. Year Related to Triticale Plant Height Values \* Nitrogen \* Phosphorus Doses Interaction (cm)

Reductions in Triticale plant height were observed in more phosphorous fertilizers at 6 kg / da phosphorous doses, but these reductions were found to vary according to years and applied nitrogen doses. In the parasites where the highest dose of phosphorus is applied, triticale is observed to decrease in a similar tendency according to the previous phosphor dose every two years, but there is also a small increase in contrary to the decrease in the first year of testing in the N3 fertilized parcels. Thus, different effects of different doses of nitrogen and phosphorus on the triticide are caused by different dosages and years of reaction depending on the interactions.

#### Vetch Plant height

Nitrogen and phosphorus fertilizers were used to determine the total vetch plant height values between 50.93 cm and 99.45 cm for two years and the highest vet plant height value was obtained from 3 kg / da nitrogen and 3 kg / da phosphorous fertilizer application. In higher N and P fertilization applications, the shortening of the vetch neck was observed.

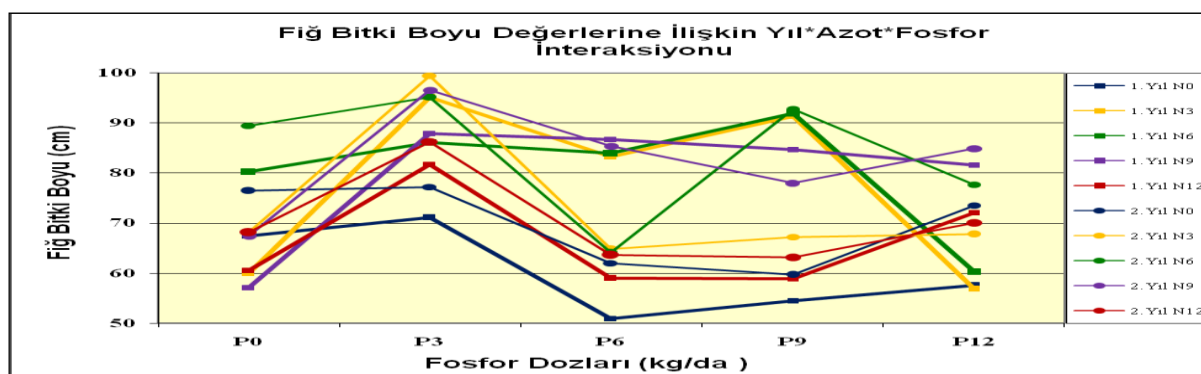
Table 3. Average Values and Groups of Vetch Crop Height

	Applications	P <sub>0</sub>	P <sub>3</sub>	P <sub>6</sub>	P <sub>9</sub>	P <sub>12</sub>	Ort.
1. Year	N <sub>0</sub>	67.47 e-g	71.09 d-f	50.93 h	54.53 h	57.52 gh	60.31
	N <sub>3</sub>	59.97 f-h	95.08 a	83.19 a-c	91.36 ab	56.81 gh	77.28
	N <sub>6</sub>	80.27 b-d	86.09 ab	83.99 a-c	91.91 ab	60.33 e-h	80.52
	N <sub>9</sub>	57.11 gh	87.94 ab	86.72 ab	84.67 ab	81.60 b-d	79.61
	N <sub>12</sub>	60.60 e-h	81.73 b-d	58.97 gh	58.93 gh	72.13 c-e	66.47
	Ort	65.08	84.39	72.76	76.28	65.68	72.84
2. Year	N <sub>0</sub>	76.45 d-g	77.21 d-f	62.00 h <sub>1</sub>	59.68 i	73.53 e-h	69.77
	N <sub>3</sub>	68.10 f-1	99.45 a	64.80 g-1	67.20 f-1	67.76 f-1	73.46
	N <sub>6</sub>	89.47 a-c	95.10 ab	64.07 h <sub>1</sub>	92.79 ab	77.68 c-f	83.82
	N <sub>9</sub>	67.47 f-1	96.50 ab	85.34 b-e	77.96 c-f	84.90 b-e	82.43
	N <sub>12</sub>	68.12 f-1	86.23 b-d	63.60 h <sub>1</sub>	63.20 h <sub>1</sub>	70.07 f-1	70.24
	Ort	73.92	90.90	67.96	72.17	74.79	75.95

1) The averages indicated by similar letters are not statistically different within the 5% error limits according to the F and LSD test.,

Karaca and Çimrin (2002); reported that phosphorous fertilizer applied at increasing doses did not have a significant effect on the plant height of Adi vetch plant, while nitrogen fertilizer increased the length of the common vetch plant statistically significantly. It was reported that the average length of the common vetch plant was 23.50 cm in the parcel without nitrogen

fertilizer (N0) and 28.48 cm in the 6 kg nitrogen application (N6), and this value was statistically significant ( $P < 0.01$ ). Arslan and Gülcan (1996) reported that they obtained the longest vetch plant with 75% vetch + 25% barley mixture in vetch + barley mixtures to be grown as winter crops in Southeastern Anatolia Region. Lithourgidis and Dordas (2010); they were found to be higher when compared to the pure planting of legumes in mixed sowing. Tan (1991); found that the nitrogenous fertilizer increased the plant height significantly. Keskin et al. (1996) reported that nitrogen tolerance and phosphorous fertilizer effect on the plant length has a positive effect in the vineyard conditions, in vineyard varieties and for three years. 4 kg N and 8 kg P<sub>2</sub>O<sub>5</sub> were applied in the experiment and they reported that the average length of the plant was 30.8 cm for the Adi vet D-120 line used in the experiment.



Graph 3. Year Related to Vetch Plant Height Values \* Nitrogen \* Phosphorus Doses Interaction (cm)

When examining Figure 3 for veterinary plant height values, in other applications, except for high nitrogen doses such as N9 and N12 in P12 application, veterinary plant height values showed an unstable result compared with years. This situation is thought to be caused by differences in climate conditions between years. In the case of high phosphorus dosimetry, higher values of vetch height were reached in the second year of the study, but only in the first year in which the highest nitrogen application N12 dose vet plant values were tested in all other nitrogen doses except for N12 dox. Different responses of vetch plant depending on years and applied fertilizer doses, Year \* Nitrogen \* Phosphorus doses caused interaction.

**Triticale Dry Grass Yields** The values of dry weaning values for tritical averages for two years are varied between 802.32 kg / da and 1226.2 kg / da in different nitrogen applications and between 1004.8 kg / da and 1193.6 kg / da in phosphorus applications. The highest tritical rate was taken from the N9P6 plot, which was applied at 1400.7 kg / da nitrogen at 9 kg / da and phosphorous at 6 kg / da. The obtained triticale yield values support the research findings of Öztürk ve Serin (1996), Bedir (2010), Çil (1998) and Karaca and Çimrin (2002). It has also been reported by many researchers that nitrogen and phosphorus fertilizer in the vetch + barley mixture increases green and dry yield (Sobkowicz and Sniady 1999).

Table 4. Triticale Related to Triticale Dry Grass Yield Average Values and Groups

	Applications	P <sub>0</sub>	P <sub>3</sub>	P <sub>6</sub>	P <sub>9</sub>	P <sub>12</sub>	Ort.
	<b>1. Year</b>	N <sub>0</sub>	751.62	832.05	916.22	773.79	756.37
N <sub>3</sub>		1010.2	1206.3	1268.3	1076.9	951.8	1102.7
N <sub>6</sub>		1109.0	1226.7	1277.3	1267.8	1168.2	1209.8
N <sub>9</sub>		1208.0	1339.7	1348.5	1261.01	1174.9	1266.4
N <sub>12</sub>		1058.2	1010.3	1023.7	890.91	1012.6	999.14
Ort		1027.4	1123.0	1166.8	1054.1	1012.8	1076.8
<b>2. Year</b>	N <sub>0</sub>	684.13	784.78	896.03	784.06	844.17	798.63
	N <sub>3</sub>	943.47	1096.9	1137.3	925.34	1217.8	1064.2
	N <sub>6</sub>	1160.62	1210.8	1356.2	1159.3	1153.6	1208.1
	N <sub>9</sub>	1061.20	1206.8	1452.8	1039.9	1169.0	1185.9



	<b>N<sub>12</sub></b>	1061.20	1074.9	1259.2	900.62	968.76	1052.9
	<b>Ort</b>	982.12	1074.8	1220.3	961.84	1070.7	1061.9

1) The averages indicated by similar letters are not statistically different within the 5% error limits according to the F and LSD test.

#### Vetch Dry grass yield

The average values of nitrogen and phosphorus application were found to be between 36.38-77.23 kg / da in the first year and 48.74-92.51 kg / da in the second year when the two years average values and groups in the vet hay yield in Table 5 were examined respectively.

Table 5. Mean Values and Generated Groups of Vetch Dry Yield

	<b>Applications</b>	<b>P<sub>0</sub></b>	<b>P<sub>3</sub></b>	<b>P<sub>6</sub></b>	<b>P<sub>9</sub></b>	<b>P<sub>12</sub></b>	<b>Ort.</b>
<b>1. Year</b>	<b>N<sub>0</sub></b>	39.63	39.90	41.11	43.19	41.71	41.11
	<b>N<sub>3</sub></b>	45.42	52.02	57.37	66.40	42.14	52.67
	<b>N<sub>6</sub></b>	65.41	60.56	60.52	71.88	54.11	62.50
	<b>N<sub>9</sub></b>	61.27	77.23	63.89	70.10	58.21	66.14
	<b>N<sub>12</sub></b>	51.34	56.12	38.75	41.03	36.38	44.72
	<b>Ort</b>	52.61	57.17	52.33	58.52	46.51	53.43
<b>2. Year</b>	<b>N<sub>0</sub></b>	50.23	50.88	57.25	50.48	48.74	51.52
	<b>N<sub>3</sub></b>	65.14	71.81	71.21	60.21	71.37	67.95
	<b>N<sub>6</sub></b>	75.19	76.95	84.04	69.53	70.53	75.25
	<b>N<sub>9</sub></b>	69.89	78.18	92.51	64.52	71.53	75.33
	<b>N<sub>12</sub></b>	69.89	70.59	68.97	48.99	58.89	63.47
	<b>Ort</b>	66.07	69.68	74.80	58.75	64.21	66.70

1) The averages indicated by similar letters are not statistically different within the 5% error limits according to the F and LSD test.

The vetch yield values for the two years ranged from 46.31 to 70.73 kg / da depending on the nitrogen application and the highest vetch yield was obtained from N9P6 plot with 9 kg / da nitrogen and 6 kg / da phosphorus, the lowest vetch yield were taken from the N12P9 parcels, which were treated with 12 kg / da nitrogen and 9 kg / da phosphorus. Girenko et al. (1986) found that 8 kg of nitrogen, 8 kg of phosphorus fertilizer could be given in the experiment to determine the need for fertilizer. Keskin et al. (1996) reported that some of the common vetch varieties were fed with 4 kg / da N and 8 kg / da P<sub>2</sub>O<sub>5</sub> and 98.1 kg / d of dry hay, respectively, and these values supported the results of our research. Yagodina and Trepachev (1989) reported that fertilization and nitrogen binding capacity of the vaginal vetch and vetch + oat mixture increased to 9.7 mg phosphorus and 18.7 mg phosphorus (18.7 mg), respectively. Panciera and Sparrow (1994) found that the nitrogen fertilizer increased the weed yield from 404 kg to 547 kg, while the amount of nitrogen removed from soil increased from 10.6 kg to 15.5 kg. Vigor hay yield values; Bedir (2010), Çil (1998) and Karaca and Çimrin (2002).

#### Dry grass yield

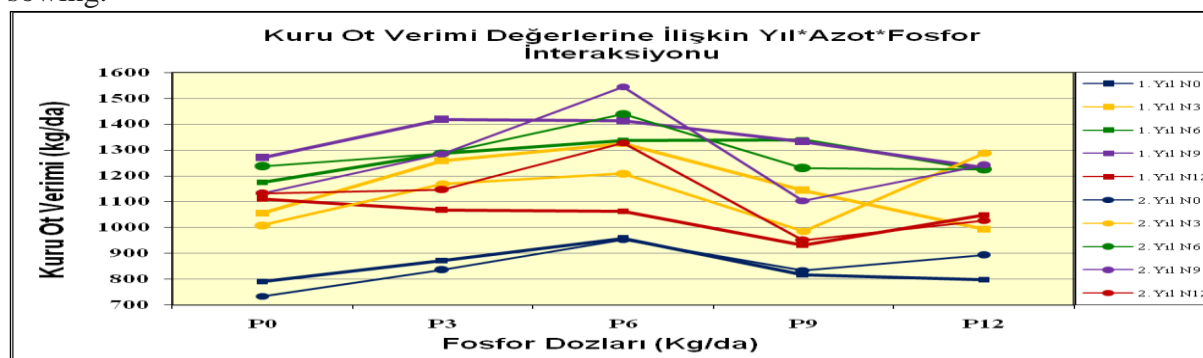
When the nitrogen and phosphorus values are plotted in Table 6, where the groups are composed of years with hay yield and two-year values, the lowest yield is 734.36 kg / da in N0P0 parcel without fertilizer in the second year, the highest yield is 9 kg / kg / da phosphorus-treated N9P6 plot at 1545.3 kg / da.

Table 6. Mean Values of Dry Grass Yield and Groups

Year	Applications	P <sub>0</sub>	P <sub>3</sub>	P <sub>6</sub>	P <sub>9</sub>	P <sub>12</sub>	Ort.
	1. Year	N <sub>0</sub>	791.25 j	871.95 g-j	957.3 f-j	816.99 h-j	798.07 ij
N <sub>3</sub>		1055.6d-g	1258.3a-d	1325.6a-c	1143.3b-e	993.95e-h	1155.3
N <sub>6</sub>		1174.4a-e	1287.3a-d	1337.8ab	1339.7 ab	1222.3 a-e	1272.3
N <sub>9</sub>		1269.2a-d	1416.9 a	1412.4 a	1331.1 ab	1233.2 a-e	1332.6
N <sub>12</sub>		1109.5b-g	1066.4c-g	1062.5d-h	931.95f-j	1049.0d-h	1043.9
Ort		1080.0	1180.17	1219.13	1112.61	1059.3	1130.2
2. Year	N <sub>0</sub>	734.36 i	835.66 hi	953.3 f-i	834.55 hi	892.91 g-i	850.15
	N <sub>3</sub>	1008.6e-h	1168.7c-f	1208.5b-f	985.5 e-i	1289.2a-d	1132.1
	N <sub>6</sub>	1235.8b-e	1287.8a-d	1440.3ab	1228.8b-e	1224.1b-e	1283.4
	N <sub>9</sub>	1131.1c-g	1284.9a-d	1545.3 a	1104.4c-g	1240.5b-e	1261.3
	N <sub>12</sub>	1131.1c-g	1145.5c-g	1328.2a-c	949.6 f-i	1027.6d-h	1116.4
	Ort	1048.2	1144.5	1295.1	1020.6	1134.9	1128.6

1) The averages indicated by similar letters are not statistically different within the 5% error limits according to the F and LSD test.

The highest total dry forage yield was obtained from the N9P6 plot with 1478.8 kg / da with 9 kg nitrogen and 6 kg phosphorus and the lowest total dry weight yield was taken from N0P0 plot with 762.81 kg / da without nitrogen and phosphorus. Aydın and Tosun (1961) reported that the blend of blend of 80% vetch and 20% triticza yielded a low value of hay yield of 221.0 kg / da, due to the high legume ratio in the mixture. In addition, Aydın and Tosun (1993) reported that the average hay yield was 245.4 kg and 271.5 kg, respectively, with 0 and 6 kg P<sub>2</sub>O<sub>5</sub> phosphorous fertilization in vetch and barley mixture, respectively, and phosphorus hay yield effect was realized in the presence of nitrogen. Kılıç (1999) found that the mixture ratio of 25% vetch + 75% tritikale was the most suitable mix ratio in terms of dry weed yield, whereas Damage and Tukul (1994) had the highest hay yield (846.4 kg / da), 25% vetch + 75% triticale from the mixture. The results support our research results. Arslan and Gülcan (1996) found that the highest dry matter yield was obtained from pure barley cultivation while the lowest dry matter yield was obtained from pure Adi vet cultivation in vetch + barley mixtures to be grown as winter intermediate crops in Southeastern Anatolia. Öztürk and Serin (1996); (0, 4, 8, 12 kg N / da) and phosphorous (0, 3, 6, 9 kg P<sub>2</sub>O<sub>5</sub> / da) in vetch + barley mixtures in the study they conducted; the highest dry weed yields were 4-12 kg N / da and 3-9 kg P<sub>2</sub>O<sub>5</sub> / da, Karaca and Çimrin (2002); Yaktubay (1998) found that the highest fertilizer yield was 6 kg N / da and 8-12 kg P<sub>2</sub>O<sub>5</sub> / da, the highest dry weed yield was 6 kg N at the reservoir and 291 kg / ha at the 12 kg P<sub>2</sub>O<sub>5</sub> doses. dry hay yield was found to be between 708-908 kg / da and total hay yield was higher in late sowing. Çil (1998) concluded that the highest yield of dry hay was obtained from a mixture of 40% vetch and 60% triticale, Vasilakoglu et al. (2008); the yield of dry hay in mixed sowing was reduced compared to pure sowing.



Graph 4. Year Related to Dry Matter Yield Values \* Nitrogen \* Phosphorus Doses Interaction (kg / da)

When Figure 4 is examined in which the interactions of the hay yield values are given, it is seen that the applications of the N0 doses are generally excluded from the interaction. However, with increasing nitrogen doses, it has been observed that there are differences in phosphorus doses and years, leading to significant changes in hay yield. As a matter of fact, stable doses of P0, P3, P6 and P9 were observed every two years in the N3 dose, but it was observed that there were differences in the dosage of P12 according to years. However, at doses of N6, N9 and N12, the interaction appeared even at the dose of P6 and appears to continue at higher doses of phosphorus. Different reactions depending on years of dry hay yield and applied fertilizer doses caused interactions.

### **Conclusions**

The nitrogen and phosphorus fertilizer doses applied to the mixture of 60% vetch and 40% triticale, triticale and vetch plant length, total dry matter the effect on the yield of grass was found statistically significant. When the two year average values are examined; Triticale plant height, 124.23 cm, vetch plant height, 87.64 cm were taken. The highest value was obtained at 1400.7 kg / ha, while the vetch yield was 70.73 kg / da, total dry matter yield was 1478.8 kg / da. The lowest values were obtained from N9P6 fertilizer doses and the lowest values were N0P0 with no fertilizer. It has been determined that it is taken from the control parcels. It has been determined that the most suitable fertilizer combination is 9 kg / da nitrogen (N) and 6 kg / da phosphorus (P), provided that at least 10 kg / ha of phosphorus is found in the soil in the mixed growing system to be built. It is thought that the amount of phosphorus to be applied and half of the amount of nitrogen should be given together with planting, while the other half of nitrogen is given in the early seedling stage of the plant after the emergence.

### **References**

- Alp, A. 2009. Determination of the Agricultural Characteristics of Some Registered Triticale (*Triticum secal* Wittmack) Cultivars in Diyarbakır Dry Conditions, *YYU Tar Bil Magazine (YYU J Agr Sci)*, 19 (2): 61 - 70.
- Anlarsal, A.E., Gülcan, H., 1988. Vetch (*Vicia Sativa L.*) Varieties in Cukurova Conditions A Study on the Determination of Genetic and Environmental Variability in Some Important Characters Research. *CU Journal of Agricultural Faculty*, 3(2):32-40.
- Anlarsal, A.E., Gülcan, H., 1989. Vetch (*Vicia sativa L.*) according to the conditions of Çukurova. Investigations on the Detection of Varieties. *CU Journal of Agricultural Faculty*, 4 (5): 57-68.
- Arslan, A. and Gulcan, H., 1996. As Winter Intermediate Product in Southeastern Anatolia Region Effect of Shape Time on Grass Utilization and Some Agricultural Characteristics in Different Vetch and Barley Mixtures Grown. *Turkey 3rd Congress of Meadow-Pasture and Forage Plants (17-19 June 1996): 341-347, Erzurum.*
- Aydin, I and Tosun, F., 1991. A Research on the Effects of Mixing Ratios of Common Vetch Some Grain Species Grown in Samsun Ecological Conditions on Dry Grass Yield, Raw Protein Ratio and Raw Protein Yield. *Turkey 2nd Congress of Çayır-Mera ve Yem Bitkari (28-31 May 1991): 322-340, Izmir.*
- Aydin, İ. and Tosun, F., 1993. Effects of fertilizer on dry hay yield, crude protein ratio and crude protein yield in common vetch and barley mixtures. *19th May University, Faculty of Agriculture. 8 (1): 187-198.*
- Bedir, S. 2010, A Study on the Determination of the Appropriate Mixing Ratio in Macaroni Fizu + Barley Mixture Authorized in Karaman Province. *CU Graduate School of Natural and Applied Sciences Field Crops Department, 49. Adana.*

- Çil, A., 1998. A Research on Determination of Weed Yield and Weed Quality of Vetch + Triticale Mixtures to be Cultivated in Diyarbakır Conditions, Cukurova University Graduate School of Natural and Applied Sciences, M.Sc. Thesis, Adana.
- DMI., 2013. Şanlıurfa Provincial Meteorology Data.
- Girenko, A. P., Livenski, I. I., Kulik, K.P. and Demidenko, K.P. 1986. Productivity and Nutritional Values of Winter Fodder Pigs in Pure and Mixed Stuffs, *Herb.Abstr.* 56 (11) Issue: 4271.
- Haser, E. and Tükel, T., 1994. Studies on the Effect of Mixture Ratio and Shape Time on Vetch (*Vicia sativa* L.) + Triticale (*Triticale x secale*) Mixture on the Seed Yield of Mixture and Mixture Elements. *Field Crop Congress 25-30 April 1994, Bornova, Izmir.*
- Karaca, S. and Çimrin, M. 2002. Nitrogen and Phosphorous Etiology in the Mixture of Common Vetch (*Vicia sativa* L.) and Barley (*Hordeum vulgare* L.) (1) *Yüzüncü Yıl University Agricultural Faculty Journal of Agricultural Sciences J.Agric.Sci.12(1): 47-52.*
- Keskin, B., İ. Yılmaz, M. Deveci, H. Akdeniz, N. Andinç, Ö. Terzioğlu and C. Andinç, 1996. A study on the yield and adaptation of some common vetch (*Vicia sativa* L.) varieties grown in Van barren conditions. *Turkey 3rd Meadow-Pasture and Forage Plants Congress, 17-19 June 1996, Erzurum.* 280-286.
- Kılıç, A., 1999. A Research on Horticulture and Herbage Quality of Vetch + Triticale Mixtures to be Cultivated in Afşin Conditions Cukurova University Institute of Natural and Applied Sciences - M.Sc. Thesis, Adana.
- Lithourgidis A. S. and Dordas C. A. 2010. Forage Yield, Growth Rate, and Nitrogen Uptake of Faba Bean Intercrops with Wheat, Barley, and Rye in Three Seeding Ratios. No. 50, 2148-2158. *Crop Science Society of America.*
- Öztürk, D. and Serin, Y. 1996. Effects of nitrogen and phosphorus fertilizers on yield and quality of vetch + barley mixtures. Graduate thesis. Ataturk University, Faculty of Agriculture, Erzurum.
- Panciera, M. T. and Sparrow, S. D. 1994. Effects of nitrogen fertilizer on dry matter and nitrogen yields of herbaceous legumes in interior Alaska. *Canadian Journal Of Plant Science.* 75 (1): 129-134.
- Sobkowicz, P. and Sniady, R. 1999. Performace of spring triticale commom vetch mixtures growing for seed as affected by sowing and nitrogen application method. Pt. 1. Yielding of common vetch, *Zeszyty Naukowe Akademii Rolniczej we Wroclawiu. Rolnictwo,* (no. 367 (74)) p. 167-180.
- Tan, M. 1991. A research on the effects of rhizobium inoculation and nitrogen fertilizer application on yield and some plant characteristics of common vetch (*Vicia sativa* L.) at different doses. *Atatürk University - Institute of Science Graduate Thesis Sy,* 46.
- Vasilakoglou, I.; Dhima, K.; Lithourgidis., A. and Eleftherohorinos, I., 2008. Competitive Ability of Winter Cereal-Common Vetch Intercrops Against Sterile Oat *Experimental Agriculture* 44: 4 Pages: 509-520.
- Yagodina, M. and Trepachev, E.P, 1989. Nitrogen-fixing capabilities and yield of vetch and vetch-oat mixture at various phosphate levels of soil. *Biology Bulletin of the Academy of Sciences of the USSR.* 16:2, 184-193,1989. Translated From *Izvestiyon Akademii Nauk SSSR, Seria Biologic Heskaya No:2, 274-284.*
- Yaktubay, Ş., 1998. A Research on Yield and Yield Characteristics of Different Barley (*Hordeum Vulgare* L.) and Some Ordinary Cattle (*V. Sativa* L.) and Hairy Cattle (*V. Villosa* Roth) Varieties. *CU Institute of Science and Technology.*

## INFLUENCE OF TILLAGE PRACTICES ON THE OIL YIELD OF SOYBEANS

Tunahan ERDEM<sup>1\*</sup>, Murat TURGUT<sup>2</sup>

<sup>1</sup>Cukurova University, Dept. of Agricultural Machinery, 01330, Adana, Turkey

<sup>2</sup>Dicle University, Dept. of Agricultural Machinery Diyarbakır, Turkey

\*Corresponding author: terdem@cu.edu.tr

### Abstract

Plant breeders continually generate ever-higher yielding cultivars, but also want to improve seed constituent value, which is mainly protein and oil, in soybean. But in the same time another works still continue in plant production period systems. The soybean (*Glycine max* (L.) Merrill) is an annual legume that is primarily produced as a source of edible oil for human consumption. Generating higher yielding soybean cultivars is an important issue, as well as improving the value of seed ingredients, which is mainly consisted of protein and oil. Therefore, soybean production plays an important role. The objective of this study was to determine the influence of various tillage practices on the oil yield of soybeans (*Glycine max* L.). The tillage treatments were conventional tillage with residues incorporated in soil (CT1), conventional tillage with residues burned (CT2), reduced tillage with a heavy tandem disc-harrow (RT1), reduced tillage with a rotary tiller (RT2), reduced tillage with a heavy tandem disc harrow followed by no-tillage (RNT), and no tillage (NT). The tillage plots were of 12 m width and 40 m length (480 m<sup>2</sup>). The applied treatments resulted in the soybean oil yield of 0.16; 0.18; 0.19; 0.18; 0.6 and 0.17, respectively.

**Key words:** Soybean, tillage, oil yield.

### Introduction

Soybean (*Glycine max* (L.) Merrill) is an annual legume that is primarily produced as a source of edible oil for human consumption. The protein and oil content of soybean makes it a major source in human and animal nutrition source for biofuels as an alternative of fossil fuels. Soybean seed quality is often determined by seed protein, oil, fatty acid, and mineral content. Soybean seed protein concentration ranges from 341 to 568 g kg<sup>-1</sup> of total seed weight, with a mean of 421 g kg<sup>-1</sup>. Oil concentration ranges from 83 g kg<sup>-1</sup> to 279 g kg<sup>-1</sup> with a mean of 195 g kg<sup>-1</sup> (Bellaloui et al., 2010). The composition of soybean oil comprises of 50-57% linoleic acid, 18-26% oleic acid, 7-14% palmitic acid, 6-10% linolenic acid, 3-6% stearic acid and trace amount of meristic acid, palmitoleic acid[2].

### Materials and method

#### *Experimental site*

The study was performed in 2014 at the Çukurova University Research Farm (Turkey) located between 37°00'54''N and 35°21'27''E on elevation ranging from 32 m above mean sea level. The experiment was carried out on the Arik clay soil series with a slope about 1%, and soils were classified as fine, smectitic, active, mesic TypicHaploxererts (Soil Survey Staff, 1999). The soil structures of the study area were 18% sand, 32% silt, 50% clay at the depth of 0-30 cm, pH 7.82 and organic carbon content 0.9%. The soil humidity was 13.45% ± 1.71. Study area has a Mediterranean climate characteristic. Summers are hot and dry, and winters are

mild and rainy. The annual average precipitation is 625 mm, temperatures differ between - 8.1°C and +45.6°C.

**Experimental design and tillage systems**

Soybean is cultivated as second crop between June 2014 and October 2014 following the harvest of winter wheat. The experiment was conducted on a randomized complete block design with three replications of conventional tillage with residue incorporated in the soil (CT1), conventional tillage with residue burned (CT2), reduced tillage with heavy tandem disc-harrow (RT1), reduced tillage with rotary tiller (RT2), reduced tillage with heavy tandem disc harrow followed by no-tillage (RNT), and no tillage (NT). The tillage plots were of 12 m width and 40 m length (480 m<sup>2</sup>). Details for tillage practices, order of the treatments within each practice and sowing methods were given in Table 1.

Table 1. Tillage practice of the treatments

Threat-ments	Winter wheat (November 2013)	Second crop soybean (June 2014)
<b>Conventional tillage with residue incorporated in the soil (CT1)</b>		
CT1	Stover chopping of second crop Mouldboard plough(30-33 cm) <sup>a</sup> Disc harrow (2 passes, 13-15 cm) Float (2 passes) Drill (4 cm) Stover burning of second crop	Stubble chopping of wheat Heavy tandem disc harrow (18-20 cm) Disc harrow (2 passes, 13-15 cm) Float (2 passes) Planter (8 cm) Stubble burning of wheat
<b>Conventional tillage with residue burned (CT2)</b>		
CT2	Mouldboard plough (30-33 cm) Disc harrow (2 passes, 13-15 cm) Float (2 passes) Drill (4 cm) Stover chopping of second crop	Chisel plow (35-38 cm) Disc harrow (2 passes, 13-15 cm) Float (2 passes) Planter (8 cm) Stubble chopping of wheat
<b>Reduced tillage with heavy tandem discharrow (RT1)</b>		
RT1	Heavy tandem disc harrow (2 passes, 18-20 cm) Float (2 passes) Drill (4 cm)	Rotary tiller (13-15 cm) Float (2 passes) Planter (8 cm)
<b>Reduced tillage with rotary tiller (RT2)</b>		
RT2	Rotary tiller (13-15 cm) Float (2 passes) Drill (4 cm)	Stubble chopping of wheat Rotary tiller (13-15 cm) Float (2 passes) Planter (8 cm)
<b>Reduced tillage with heavy tandem discharrow fallowed by notillage (RNT) for the second crop</b>		
RNT	Stover chopping of second crop Heavy tandem disc harrow (18-20 cm) Float (2 passes) Drill (4 cm)	Stubble chopping of wheat Herbicide application No-till planter (8 cm)
<b>No tillage (NT)</b>		
NT	Stover chopping of second crop Herbicide treatment No-till drill (4 cm)	Stubble chopping of wheat Herbicide treatment No-till planter (8 cm)

<sup>a</sup>Figures in parenthesis are average working depths of the equipment.

In the conventional tillage methods (CT1 and CT2), following wheat harvest, farmers burn the residues, and plough the soil to save time for the second crop soybean. In CT2, crop residues were burnt after the wheat harvest. In the CT1, RT1 and RT2 practices, the soil was tilled after

the first and second crop residues shredded on the plots. The residues of first and second crops were shredded and left on the soil surface in NT system. Whereas, the stover of the second crop were shredded, and soil was tilled in RNT where the stubble of the first crop were only chopped (Table 1). RT1, RT2, RNT and NT methods are thought to be possible alternatives to the conventional methods used in the region for a long time.

Two weeks prior to sowing, the total herbicide (500 g ha<sup>-1</sup> Glyphosate) was used to control weeds in the NT and RNT treatments. Compound NP fertilizers were applied in the seedbed at the rates of 172 kg N ha<sup>-1</sup> and 55 kg P<sub>2</sub>O<sub>5</sub> ha<sup>-1</sup> for wheat and 120 kg N ha<sup>-1</sup> and 40 kg P<sub>2</sub>O<sub>5</sub> ha<sup>-1</sup> for soybean. The seeding rate of soybean was 23.6 plants per m<sup>2</sup> and nine times irrigated by sprinklers in 13 day intervals. The amount of water applied each irrigation was identical for all treatments and no irrigation water was applied to the wheat.

### Results and discussion

The oil yield of soybean under different tillage systems is shown in Table 2. Comparing oil extracts in graphs below in each group max. oil yield was found at Reduced tillage system with 19.06 % of oil. This oil yield is nearly close to reported oil yield by Linda [4] at the condition of 4.5% moisture content extraction duration of 22 h (Isopropylalcohol and Petroleum ether). She reported that total oil yield of soybean is 22%. The cold press extracted oil from our experiment seems very high while the industrial application gets from the soybean seeds. Cold press application of oil remains some oil in cakes. It depends on oil extractor and application condition. In our experiment the screw rotation speed was 23 rpm.

Table 2. Oil yield and cake amounts of soybean seed as affected by tillage treatments

Sample ID	Applied Amount (g)	Oil Yield (g)	Cakes Amount (g)	Average Oil Yield (%)	
CT1	350	61,88	183,43	0,174704762	
	350	58,15	183,58		
	350	53,75	183,47		
	350	56,95	189,84		
CT2	350	70,44	180,97		
	350	65,71	188,12		
	350	67,68	186,91		
RT1	350	59,73	183,73		0,190319048
	350	73,1	183,14		
	350	65,48	192,64		
	350	77,08	181,18		
RT2	350	56,6	184,02		
	350	59,24	188,89		
RNT	350	57,13	183,73	0,170795238	
	350	57,69	188,93		
	350	55,48	184,7		
	NT	350	69,53		186,67
350		59,6	191,57		

On the other hand, the decrease in the oil yield observed at CT and NT systems were below 1.5 and 1.9%. These results give some idea about the tillage systems and its effects of one year application on oil yield. From the data it could be concluded that RT systems increase the oil yield of soybean by means of 1.7%.

### Conclusion

The obtained datum from our experiment was one year application. So that it is so hard to say tillage systems effect the oil yield of soybean. But here we see some results which lead us to study on different tillage systems on production and oil yield of soybean.

### **References**

- Bellaloui, N., Bruns, H. A., Gillen, A.M., Abbas, H.K., Zablutowicz, R.M., Mengistu, A., Paris, R.L., 2010. Soybean seed protein, oil, fatty acids, and mineral composition as influenced by soybean-corn rotation. *Agricultural Sciences*, Vol.1, No.3, 102-109.
- Azcan, N., Hoşgün, E.Z., Güvenir, B., Berberoğlu, M.A., Kara, M., 2006. Soya Yağı Ekstraksiyonu, Yağın Kompozisyonu Ve Protein Veriminin Belirlenmesi'nde Yöntem Karşılaştırılması / Soybean Oil Extraction, Fat Composition and Method Comparison in Determination of Protein Yield/. *Yedinci Ulusal Kimya Mühendisliği Kongresi*, 5-8 Eylül, Eskişehir.
- Soil Survey Staff, 1999. *Soil taxonomy: a basic system of soil classification for making and interpreting soil surveys*, 2nd edition. *Agriculture Handbook*, vol. 435. USDA, NRCS., US Government Printing Office, Washington DC.
- Dari Linda, 2009. *Effect Of Different Solvents On The Extraction Of Soya Bean Oil*. Bsc. (Hons.) *Agricultural Technology (Tamale)* A Thesis Submitted To The Department Of Agricultural Engineering, Kwame Nkrumah University Of Science And Technology, Faculty Of Mechanical And Agricultural Engineering College Of Engineering.



## **2. PLANT PROTECTION AND FOOD SAFETY**

## THE DAMAGE OF THRIPS (*FRANKLINIELLA OCCIDENTALIS*) ONGREENHOUSE PEPPER IN THE BEJAIA REGION (ALGERIA)

Aldjia OUDJIANE<sup>1\*</sup>, Atika BNRIMA<sup>1</sup>, Farid BOUNACEUR<sup>2</sup>, Fariza BOUSSAD<sup>3</sup>, Aldjia HMICHE<sup>4</sup>, Christian RALAHIMANA<sup>5</sup>

<sup>1</sup>\*University of Blida, Department of Agronomy, and Research laboratory at INRAA, Algeria

<sup>2</sup>University Tiaret, Algeria

<sup>3</sup>National Institute of Agronomy of El Harrach, Algeria

<sup>4</sup>University of Blida, Aromatic and Medicinal Plant Laboratory, Algeria

<sup>5</sup>University of Reims Champagne-Ardenne, France

\*Corresponding author: oudjianealdjia77@gmail.com

### Abstract

In Bejaia, the vegetable crop takes fourth place after the arboricultures, oleicultures, and the great cultures; Tomato, pepper, bean and cucumber are the crops most grown by farmers in the region to obtain and improve their income. Many factors contribute to low yields, diseases, nematodes, mites and insect pests. The thrips is the insect that caused more damage to the vegetable crops in Bejaia's region and the farmers find many difficulties to control and combat them. In the present study, in order to know this problematic, surveys were carried out on a farm on a peppery crop in 2014 due to a discharge by 15 days for 8 months. Two sampling methods were used, Trap and direct counting of number of the thrips. The Thrips were put in a flask containing an alcoholic solution at 70%. Thrips were sampled and identified under a microscope using morphological characteristics. To estimate the damage caused by the thrips, we take 60 plants randomly, they will be examined visually observed; And then the attack rate was calculated using the following formula:

Attack rate = (number of plants attacked and damaged / total number of plants examined) X100. The damage caused by thrips was estimated for the different stages of crop development, the majority of the thrips were found in the flowering stage. We observed significant declines in yield. In view of this situation, farmers use unchecked chemical control to stop this threat.

**Keywords:** *Thrips, damage, pepper, Bejaia.*

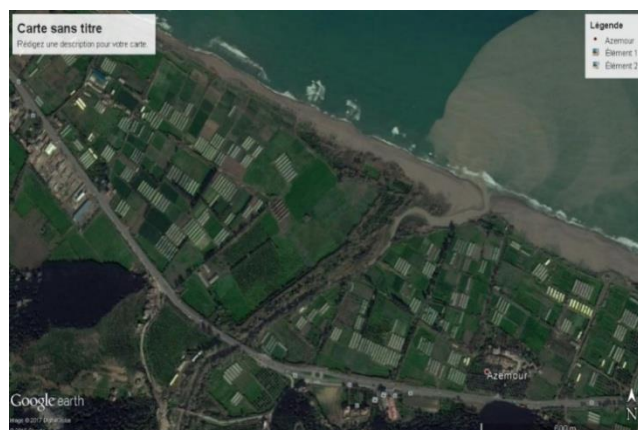
### Introduction

The vegetable crops of open field and under shelters occupied in Algeria an average of 88000000 ha. The areas under cover crops shelter (shelter greenhouses, greenhouses, multi-tunnel greenhouses and small tunnels) account for 30% of this area, so 16650 ha divided into; 2250 ha under unheated greenhouses: The tomato remains the main species grown under unheated greenhouse with 56% of the area, Followed by pepper which takes on average 26% of the area (Anonyme, 2013). Pepper is a group of cultivars of the species *Capsicum annum*, These are the mild varieties from this species by selection. The Mediterranean climate suits him well. Many factors contribute to low yields, diseases, nematodes, mites and insect pests. Thrips is the insect that caused more damage to the study site where farmers find enormous difficulties in controlling. Thysanoptera or thrips are insects that live in groups as their name always indicates in the plural (Duval, 1993). They are among the insects that have the smallest size often on the order of a millimeter. More than 50 species of thrips are harmful to crops and 10 species of tospovirus are transmitted worldwide (Mound, 2004). Among these

species, thrips californi in *Frankliniella occidentalis* and thrips from tobacco and onion Thrips tobacco are the most capable of transmitting TSWV (Tomato Spotted Wilt Virus or the Tomato Spotted Tomato Spot Virus) And the Impatiens Necrotic Spot Virus (Impatiens Necrosis Virus). The TSWV mainly affects vegetable crops (tomatoes, peppers) (Lambert, 1999). Some species are polyphagous: *Frankliniella occidentalis* (Alford, 1998) Contrary to what is observed in most biting insects, Thrips do not eat sap. The insect bites the plant with buccal styling and then injects its saliva, which produces an initial lysis of cell contents, then sucks the product with its powerful pharyngeal pump (Bournier, 1983). Lambert (1999), mentioned that the damage caused are of several types of thrips.. The main damage is due to the injection of saliva, the latter injected; Diffuses through the cell walls and destroys neighboring cells .The dead cells become dehydrated, lose their coloring, become silvered and then white pearly. Breeding also causes damage, especially on young fruits. The insertion of the eggs by the female in the plant causes the appearance of pits first clear that become progressively necrosed. The consequences of Thrips attacks vary according to the nature and the vegetative state of the affected organs (Moreau and Le teinturier, 1997). In fact thrips by their biting cause a reaction of the plant result in the induction of blistering and corky beaches of brownish gray color on the leaves, flowers, fruits, this depreciates strongly commercial value and can lead to falls Yields up to 30% of production (Hanafi and Lacham, 1999). Among the indirect damage, several species of thrips are involved in the transmission of the TSWV "Tomato Spot Ted Wild Virus". The species Thrips tabaci is the only Palearctic species, the clear forms of summer as well as the dark forms of winter are vectors of this virus. According to Lambert (1999), the thrips of the small fruits *Frankliniella occidentalis* and Thrips tabaci are able to transmit the Tomato Spotted Wilt Virus (TSWV) viruses and the INSV (Impatiens Necrotic Spot Virus) Impatiens necrosis virus. The TSWV can be very dangerous on several vegetable and floral species (tomato, sweet pepper, lettuce, chrysanthemum, anemone, impatiens, etc), some weeds can also harbor this virus, Symptoms of TSWV are very variable such as Necroses, Mosaic, etc., according to host plants, (Moreau and Le teinturier, 1997). Despite their economic importance, thrips are not well known in Algeria. However, fragmentary studies have been carried out recently on ornamental plants in Algiers by (Benmessoud et al., 2010), also on Mitidja vineyards with Bounaceuret al., (2010) and on the Biskra region on vegetable crops its doing by Houame (2013). For all these reasons, we considered it useful to undertake an exhaustive study of the main thysanoptera that are dependent on vegetable crops using an approach to study their damage.

### **Material and Method**

In order to study the damage caused by thrips, a study station was selected on a farmer's farmstead; This farm is located in the region of Baccaro which belongs to the littoral part of the wilaya of Béjaïa (36 ° 45 'N, 5 ° 04' E.). The latter is located in northern Algeria, in the region of Kabylie on its Mediterranean coast 241 km from Algiers. It extends over an area of 120, 22 km<sup>2</sup>. The station belong to the sub-humid bioclimatic stage in mild winter. The average annual of the temperature is 26.5 to 28.2 ° C. and the precipitation is between 600 and 900 mm all year round . .



**Fig.1. Study site**

Within the farm, a 400 m<sup>2</sup> greenhouse has been delineated, peppers are grown underground planting in January 6, 2014 at a density of 2.7 plants / m<sup>2</sup>, the trial lasted eight month. To track the flight of the Thrips, four blue slabs were stuck in a greenhouse. Every fifteen days, from planting to harvesting, the blue patches were changed and analyzed under a binocular microscope to note the presence of thrips. For monitoring the evolution the number of thrips, 20 to 30 plants, are taken at random, a count of thrips was made directly and each plant underwent a shaking over Japanese umbrella, in which fall adults and larvae . The Thrips are recovered in a flask containing 70% alcoholic solution,. This technique was performed once every 15 days. Sampled thrips were mounted and identified under a microscope using morphological characteristics. To estimate the damage caused by the thrips based on the method described by Arpaia et al., (1991), 60 plants were randomly taken, visually observed, and the attack rate was calculated using The following formula:

Attack rate = (number of plants attacked and damaged / total number of plants examined) X100.

## **Results and discussion**

*F. occidentalis* feeds on more than 250 plant species, but prefers those that favor its development. (Rahman et al .,2010). According to Hanafi and Lacham (1999) in Morocco, this pest is causing serious damage to greenhouse pepper crops. This phenomenon has spread to other horticultural crops, mainly cucumber and floral crops.

The damage of the thrips is direct, by the taking of food on all the plant organs, or indirectly by the transmission of viruses. Giving our study we are interested in the attic organs and the damage caused by these little insects.

### **1-Attack of thrips :**

The attacks are variable depending on the vegetative stage of the plant on leaves, flowers and fruits. The first flights of thrips were recorded on the blue trap engulfing (06/03/2014), and this insect on the plant. The observations of the period (06/04/014) found the presence of the thrips on leaf and flower but it is the most attacked flower has 3 to 5 thrips per flower.

The attack peak was recorded at the end of June and beginning of July more than 60 thrips on plant. The greenhouse is completely affected by 70% plant growth.



**Fig.2. Thrips of the thrips on the flower of sweet pepper.(original. 2014)**

In 1985, *Frankliniella occidentalis* was responsible for a 20% yield loss on greenhouse cucumbers in Canada (EPPO, 2002). According to the author, this thrips is the main vector of tomatospottedwilt virus (TSWV) on tomatoes in Canada. In the United States of America, TSWV is responsible for 50-90% of losses on lettuce.

### **2-Damage of thrips :**

Damage of the thrips causes several damage to the various organs of the plant.

Thrips of small fruits are the most common thrips on greenhouse cucumbers across Canada (ANONYMOUS, 2013). *Frankliniella occidentalis* has a several host plants. Young and adult feed on leaves and fruits, piercing the surface and sucking the contents of the cells of plants. This results are manifested in the formation of silver-white spots or strips on the surface of the leaves and fruits. In surface of leaves or flowers we can also found the excrement of this insect. Excessive infestation of *Frankliniella occidentalis* reduces the yield of the plant and may cause severe deformation or twisting of the fruit. Onion thrips usually occur in the lower stratum of cucumber crops and rarely cause fruit twisting or direct fruit depredation (ANONYMOUS, 2013).

#### **2.1- Damage to plant growth:**

The plant generally had a low growth, as the majority of the leaf is wound and dried. It has also been found that the distance between knots is short for the plants attacked.

#### **2.2.- Damage on leaf:**

The thrips feed on the epidermis of the leaf, this if leads to lesions of the leaf, the leaves overlap with silvered points and then brown beaches dried out what influences the reduction of photosynthesis and then the weakening of the plant.



**Fig.3. Thrips damage on pepper leaves (original, 2014)**

Larvae, like adults, feed on the underside of leaves, as well as on flowers, buds and fruits, penetrating the surface and sucking the contents of the plant cells. This activity creates streaks

or silver-white spots on the leaf or fruit. The feeding behavior of thrips on growing young shoots causes deformation of the leaves. Berry thrips is a vector of the Impatiens Necrotic Spot (INSV) virus, and the Tomato Tan Spot (TSWV) virus in peppers and tomatoes. Young and adults also feed on pollen. (ANONYMOUS,2013).

### **2.3. - Damage to the flowers:**

Thrips cause damage to different parts of the flower, in our study it has been noticed that either the larvae or the adults feed on pollen that cause to cause the fall of the flowers.



**Fig.4. Damage of thrips on the flowers and flower bud of pepper(original, 2014)**

Young and adults of thrips also feed on pollen (ANONYMOUS, 2013). for example 10 thrips per flower cause moderate damage to stamens;higher densities at early flower development may lead to dieback of the stamens before maturation and release of Pollen (Steiner and Medhurst, 2003). Heavy infestations can destroy buds and flowers (Hore, 2004).

### **II.2.3. - Observable damage to the fruit:**

For our test the thrips cause remarkable deformations for the fruit to the point that it becomes unsaleable.



**Fig.5 - Thrips damage on pepper fruits (original, 2014)**

The phytophagous thrips, larvae and adults, pierce the plant tissues to suck the sap. The presence of air bubbles and desiccation of the cells are responsible for the tanning and cracking of the fruits; Breeding also causes damage, especially to young fruits. The insertion of the eggs by the female into the vegetal, leads to the appearance of punctuation first clear that progressively necrosis (Moreau et al., 1997).

Egg laying and the trophic activity of larvae on young fruits change color and shape, making fruit unsaleable. The nymphs feed under the eye of the fruit. We can see black debris mixed with excrement (ANONYMOUS, 2013).

## Conclusion

Thrips are particularly important pests of vegetable crops because they are also vectors of viruses. Several damage is caused by this pest for the cultivation of sweet pepper on the different organs of the plant, which reduces the commercial value of the fruits; To deal with this pest a specific integrated control is recommended, monitoring the first thrip of thrips with the installation of blue sticky tape is advised.

## References

- Alford D. V., 2002- Pests of ornamental plants: trees, shrubs, flowers.. Ed., INRA, Paris, 464 p.
- Anonymousa, 2013 - National Investment Report in Algeria,, 20 pp.
- Anonymousb., 2013-Greenhouse Bell Pepper Production Profile in Canada2011.file:///C:/Users/Dream/AppData/Local/Temp/Profil\_culture\_poivron\_serre\_Canada\_2013-fra.p.
- Arpaia M. and Morse J.G.,1991- Citrus thrips *Scirtothrips citri* (Moulton) (Thys., Thripidae) scarring and navel orange fruit quality in California. applied entomology Journal of U.S.A, 1991, v.111. , n°. 5, p. 28–32
- Benmessaoud-Boukhalfa H, Mouhouche F ET Belmazouzi Z., 2010 - Inventorandidentification of some Thrips species in coastal and subcoastal regions of Algeria. Agriculture and Biology Journal of North America, , v. 1, n°. 5, p.775-761
- Bournier A., 1983- Thrips: Biology, Agronomic Importance.. Ed., INRA, Paris, 128p.
- DUVAL J., 1993- Thrips from greenhouse crops. Ecological agriculture Projects agro-bio360 (0 3): 1-6.
- Hannafi A. et Lacham A., 1999 -ntegrated control of California thrips (*Frankliniella occidentalis*) in greenhouse peppers in the Souss region. Cahiers Options Méditerranéennesvol 31. Ed., CIHEAM. 5p.
- Houamel S., 2013-Biological study of thrips under greenhouse conditions in the region of El GHROUS (BISKRA). Diploma of magister in agronomic science: University MOHAMED KHIDAR BISKRA 82p
- Hore T., 2004-Thrips (*Frankliniellatritici*; and possiblyotherspecies), Manitoba Agriculture, Food and Rural Initiatives.<http://www.gov.mb.ca/agriculture/crops/insects/fad90s00.html>
- Lambert L., 1999- S.O.S Thrips, Crops in greenhouses. Bull. information : 1-5
- Moreau B., Thicoïpe J. P., Paitier G., 1997 - Phytosanitary protection of vegetables and berries. Ed., professional Fruit and Vegetable Technicalprofessional Centertechnique inter professionnel des fruits et légumes, Paris, 157 p.
- Mound L. A., 2009 a- Sternal pore plantes (glandular areas) of male Thripidae (*Thysanoptera*). Zootaxa 2129: 29-46.
- Mound L. A., 2004- Fighting, flight and fecundity: behaviouraladeterminantsof Thysanoptera structural diversity.InInsects and PhenotypicPlasticity. Ed. T. N. Ananthakrishnan, D. Whitman, Science Publishers Inc. Enfield, NH, USA, 105 p.
- EPPO (European and Mediterranean Plant Protection Organization), 2000 - Diagnostic protocols for regulated organisms, Thrips palmi. Bull. 32: 281-292
- Steiner, M. Y., and A. Medhurst. 2003- Western bower thripsmanagement strategies for strawberries. Report BS00002.Horticulture Australia Limited, Sydney, NSW, Australia.

## CURRENT STATUS OF CITRUS TRISTEZA VIRUS (CTV) AND ITS POTENTIAL APHID'S VECTORS IN CHLEF VALLEY (ALGERIA)

Samir ALI AROUS<sup>1\*</sup>, Yamina GUENAOUT<sup>1</sup>, Khaled DJELOUAH<sup>2</sup>

<sup>1</sup>University Abdelhamid Benbadis of Mostaganem, Algeria

<sup>2</sup>International Centre for Advanced Mediterranean Agronomic Studies (CIHEAM), Mediterranean Agronomic Institute of Bari, Valenzano (Bari), Italy

\*Corresponding author: samirtaifour@yahoo.fr

### Abstract

Field observation in citrus orchards in Chlef valley showed many cases of decline and other typical symptoms of tristeza disease mostly in plants grafted on sour orange which is the dominant rootstock in the valley. A survey of *citrus tristeza virus* (CTV) was carried out during the spring of 2016 to evaluate its current situation and to identify the potential aphid's vectors. Total of 1680 samples collected from 93 orchards located in 21 communes were tested by DTBIA/DAS-ELISA. The analyses have confirmed the presence of CTV in 54 samples through the study area on citrus trees of different species, varieties, ages and origins, whereas the inventory of citrus aphids species carried out during the same period highlighted the presence of two important CTV vectors which are *Aphis gossypii* (Glover) and *A spiraecola* (Patch). However, there was no evidence of the presence of the major vector *Toxoptera citricidus* (Kirkaldy).

**Keywords:** *Citrus*, *CTV*, *Aphids*, *vector*, *Chlef valley*.

### Introduction

For several decades, citriculture has been considered as the most important fruit crop sector in Algeria and part of its traditional agriculture. Before the French colonization (1830), more than 22 000 citrus trees, mainly orange trees, were already grown in the Mitidja area (near Algiers). Currently, citrus orchards cover an area of 45,040 ha, or 0.6% of the agricultural land, and 11% of lands reserved to fruit trees crops, 90% of this crop is located along the coastal zones in 13 different regions, four of them represent 55% of the total area (Bilda, Chlef, Mascara and Relizane). Chlef valley is the second most important in Algeria, and citriculture is covering about 6000 hectares, however the crop is facing to serious issues, among them salinity and drought. To face these two obstacles, growers use the sour orange rootstock (*Citrus aurantium*), which is very adequate for such soil (salty and alkaline) and dry weather, furthermore the sour orange is tolerant to gummosis which was the major disease of citrus in the past, whereas the emergence of new diseases as Tristeza in the valley since 2010 (Ali Arous *et al*, 2016), which induced several cases of decline on sweet orange grafted on sour orange, had obliged the citrus industry in the valley to start thinking to an alternative rootstock which is adequate both to the new biotic and abiotic conditions. The current study contribute to understand better the current status of this epidemic disease and its epidemiology by monitoring CTV and its vectors in the main citrus growing areas of the valley. The work may help authorities to set up strategy to protect citrus industry from the serious threat of Tristeza citrus disease.



## Material and methods

### II.1. Citrus aphids monitoring

Thirteen (13) citrus orchards situated in eight different locations in Chlef valley were chosen to carry out the sampling from March to May 2016. On each of the ten trees per orchard ten shoots were weekly observed (100 shoot per orchard) choosing them randomly at different height and orientation and collecting ten young shoots per tree. Collected shoots have been put in polyethylene bags and examined in the laboratory where infestation rate and aphid's identification were performed by using the universal dichotomy identification key Blackman R.L. and Eastop V.F. (2000).

Since valuable documents for studying ecological characteristics of the aphids can be obtained by taking photographs from aphid colonies and their closest environment, a lot of photos were made in the studied citrus orchards.

### II.2. CTV survey

In order to investigate the presence and the incidence of CTV in the Chlef valley citrus groves a second survey was carried out during the blossom period in March and April 2016.

A total of 93 groves, representative of the main citrus growing areas in Chlef valley were chosen for monitoring. About 25% of the trees were sampled from each selected grove according to the hierarchic method of Gottwald and Hughes (2000) or randomly on the diagonals of the fields. Most of the visited groves were homogenous in terms of age, rootstocks, density and variety. Age of surveyed trees ranged between 1 to over 40 years. Each sample was made by 10-15 closed flowers, leaves and petioles taken from each site of the canopy of the selected trees. Samples were put in plastic bags, labeled and stored in a refrigerator box containing ice pads. Fresh flowers were printed on the CTV membranes in the laboratory. A total of 1680 samples were collected.

All collected samples were analyzed by DTBIA for the detection of CTV using stems and leaf petioles (Bar Joseph *et al.*, 1979; Cambra *et al.*, 2000). Positive samples have been confirmed by DAS-ELISA tests.

## Results and discussion

### III.1. Results of Citrus Tristeza Virus (CTV) survey

As shown in table 1, a total of 54 infected trees of different categories were detected by DTBIA test, which represent around 3.21% as infection rate, in term of citrus surface, 8.07% of the total area prospected were contaminated, whereas the survey has revealed that 16% of citrus groves are infected by CTV (Tab 1).

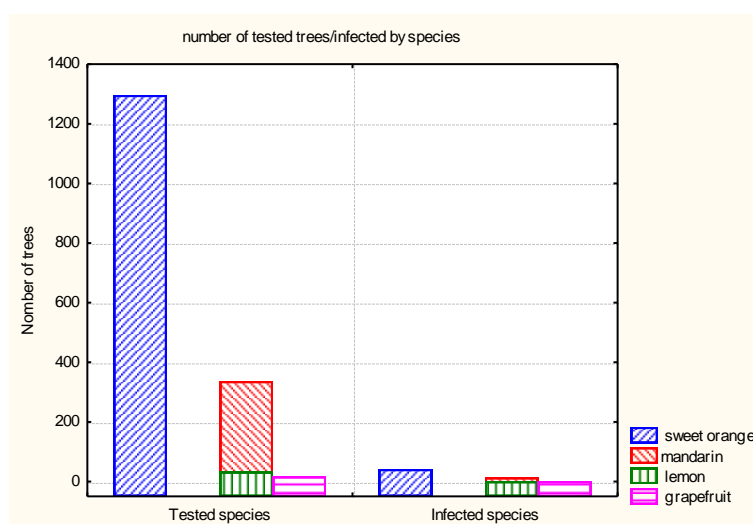
**Table 1.** Results of the CTV survey in the study area

	Total (N)	infected	% of infection
Orchard	93	15	16 %
Surface (ha)	660	53.3	8.07 %
Trees	1680	54	3.21 %

### III.2. Study of some epidemiological parameters of Tristeza disease.

#### III.2.1. Citrus species

Majority of CTV infected trees were sweet oranges (41trees) out of 1296 trees tested; sweet orange was the widest group on this study, because it is the most important cultivated group in Chlef valley (DSA, 2016). The second important group is mandarin with 13 infected trees out of 336 tested trees, whereas no grapefruit or lemon positive cases have been recorded. According to the survey, most positive cases were detected on sweet orange species.



**Figure. 1.** Infected trees by species

Even though 13 only mandarin were contaminated by Tristeza virus, the infection rate (3.86%) was higher than in sweet oranges (3.16%); the survey highlighted that the occurrence of citrus tristeza virus was significant, with about 24% of mandarin orchards and 14.5% of sweet orange groves CTV infected (Fig 1). According to Kitajima *et al* (1974) et Muller *et al* (1974), *Citrus sinensis* (L), *Citrus reticulata* (Blanco) et *Citrus paradisi* (Macf) are the principal host of CTV.

#### III.2.2. Age of orchards

The survey shown that CTV were present in all categories of citrus orchards regardless their age, unless the youngest plantations of less than 7 years. Prospection allowed the assessment of CTV status in function of age of trees, the lowest infection rate (1.7%) was recorded in the oldest trees (more than 40 years old), which were planted during the French colonial period, followed by the groves aged between 18 and 39 years old (3.7%). However, the highest infection rate was found in the tree of 8 to 17 years old, whereas no positive case was recorded in trees aged less than 7 years. In 2011 the first CTV infection case in Chlef valley

was detected, the tree was 6 years old, another case has been detected a year after, the tree was 62 years old ( Ali arous *et al*, 2016)

According to Rebourts (1950), till the second world war, Algerian citrus industry was one of the most important in the Mediterranean basin, at that time bud-woods groves already exist, they were under rigorous varietal assessment and pests investigation. Thus it is difficult to know the origin of CTV infection found in old orchards, we think that natural dissemination by aphids and illegal grafting were probably associated to this situation, the first quick decline were detected since 1948, CTV has been mentioned associated to these cases. Infected vegetal material imported from overseas into Mediterranean countries including Algeria is the cause if these first contaminations (Bové, 1966).

### III.2.3. Origin of plant materials

The study has focused on the origin of plantation, Analysis shown that the incidence rate of the disease in orchard planted with plant material brought from Mitidja region were the highest, we recorded 11 contaminated orchard out of 48 tested; whereas , from two orchard created with plant material imported from Spain, one was infected (Tab 2)

**Table 2.** Situation of CTV/origin of plants

Origin/Plants	orchard (N)	Infected orchard	%
Mitidja	48	11	22.9
Unkown	39	03	7.6
Spain	02	01	50
Ain Defla	01	00	00
Bir safsaf(Chlef)	02	00	00

In old groves with unknown origin, the survey came out 3 contaminated orchards out of 39 analyzed. We stressed that trees produced locally were completely free of CTV.

Result of investigation highlights that 36 plants came from different nurseries of Mitidja have been diseased plus 7 imported plant from Spain, all plants were 8 to 17years old. This report excludes thus the role of aphid vectors; more likely, contamination took place in nurseries, since natural dissemination take long time to become significant (Gambra *et al*, 1988).

### III.2.4. Rootstocks

The survey has supported that sour orange rootstock *Citrus aurantium* (L) is dominant in Chlef valley: 85.7% of tested tree were grafted on it, only 12.3% were grafted on citrange *Poncirus trifoliata* (L), furthermore 14.2% of infected groves had trees with combination *C. sinensis* or *C. reticulata/C. aurantium* (Tab 3). Sour orange is well adapted to calcareous soils, which are widely present in the valley; it is also tolerant to gummosis and drought. but very sensible to Tristeza, the most destructive disease of citrus (Lacirignola and D'onghia, 2009; D'onghia *et al*, 2009; Roistacher, 1991).

**Table 3.** Situation of CTV/ rootstocks

rootstocks	orchards (N)	Infected orchards	Tested trees	Infected trees	% infection (trees)
sourorange	84	12	1440	44	3

citrange	07	03	208	10	4.8
volkameriana	02	00	32	00	00

Even though the resistance of citrange and volkameriana *Citrus volkamerana* (Ten and Pasq) rootstocks to decline due to CTV, their use must consider other crucial biotic and abiotic parameters like (salinity, freeze, gummosis...), to ensure the future of citrus industry in any region (Yokomi, 2009).

#### IV. CTV Aphid vectors monitoring in the study area

A survey of frequency, abundance and infestation rate of aphid vectors population was done from March to May 2016 in 13 orchards located in 8 different areas.

Dichotomy identification of aphid populations encountered during the monitoring has revealed only two species among about fourteen related to citrus (Blackman et Eastop, 2000; Remaudière, 1996). Both species belong to the genus of *Aphis*, *Aphis gossypii* (Glover 1877), *Aphis spiraecola* (Patch 1934) (Homoptera: Aphidoidea) (Remaudière, 1996).

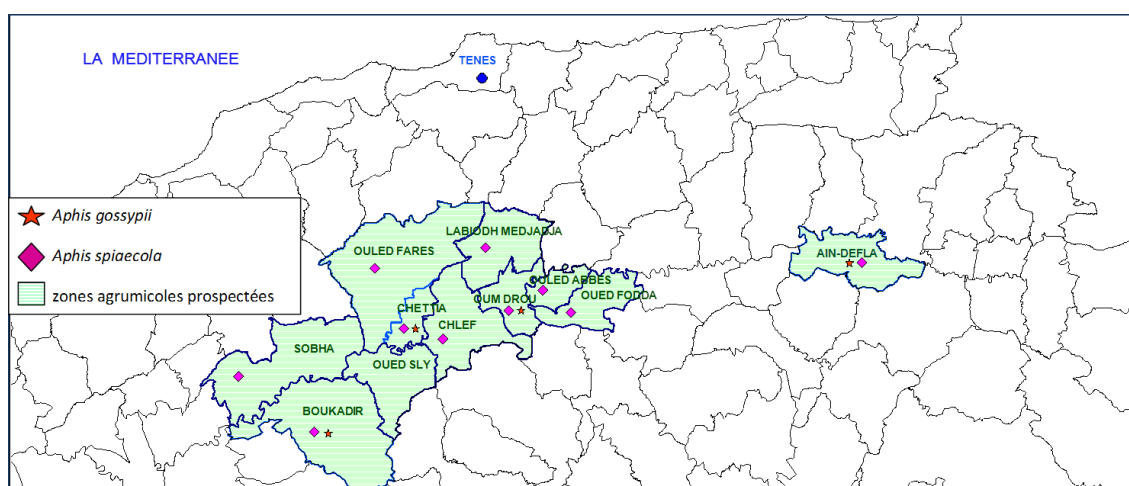


Figure 2. Repartition of *A. gossypii* and *A. spiraecola* in the study area.

*A. spiraecola* was the dominant species during the survey, the green citrus aphid is strongly related to rutaceae family (Blackman and Eastop, 2000) it is the dominant species in many Mediterranean countries (Abou Kubaa *et al*, 2009; Baloglu and Birisik, 2009 and Delkhosh and Tousi, 2009), whereas *Aphis gossypii* (Glover) was less frequent than *A. spiraecola* (Fig 2), the average of infestation rate was 2.8%, its occurrence frequency was around (23.8%), the infestation rate of the melon aphid during a survey carried out in 2010 in the valley recorded around 43% (Ali Arous *et al*, 2016). However, there was no evidence of the presence of the major vector *Toxoptera citricidus* (Kirkaldy).

#### Conclusion

The survey has shown the rapid dissemination of tristeza virus through citrus groves of Chlef valley, its status is changing constantly. Investigation has revealed very important technical information and confirmed the role of nurseries and informal propagation materiel movement in the high incidence of the virus. Natural dissemination by aphids in the spread of the disease is not clearly established for which more studies are required. Management policy and strategies for disease control and quarantine should be taken in order to limit the spread of the disease through citrus orchards of the region.

## References

- Abou Kubaa R., Addante R., Jamal M. et D'onghia A.M. (2009). Occurrence and distribution of Citrus tristeza virus (CTV) and its vectors in Syria In: Citrus Tristeza Virus and Toxoptera citricidus: A serious threat to the Mediterranean citrus industry Options Méditerranéennes, Série B: Studies and Research, N° B 65, - IAM-Bari "Centre International de Hautes Etudes Agronomiques Méditerranéennes".
- Ali Arous S., Houari A., Meziane M., Djelloul Berkane B., Madani B.K., Boudjeltia F. and Radjah F. (2016). Contribution à l'étude de la maladie de la Tristeza et ses pucerons vecteurs potentiels au niveau de la wilaya de Chlef: Séminaire international "Santé des plantes au service du développement": 12-14 Avril 2016. Chlef, Algérie.
- Baloglu S., Birisik N. (2009). Historical review of Citrus tristeza virus (CTV) and its vectors in turkey, In: Citrus Tristeza Virus and Toxoptera citricidus: A serious threat to the Mediterranean citrus industry Options Méditerranéennes, Série B: Studies and Research, N° B 65, - IAM-Bari "Centre International de Hautes Etudes Agronomiques Méditerranéennes".
- Bar-Joseph, M., Garnsey, S.M., Gonsalves, D., Moskovitz, M., Pursifull, D.E., Clark, M.F. and Loebenstein, G. (1979). The use of enzyme-linked immunosorbent assay for detection of citrus tristeza virus. *Phytopathology*, 69: 190-194.
- Blackman R.L and Eastop V.F. (2000). Aphids on the world's crops. An identification and information guide. 2nd Ed. John Wiley and Sons, Chichester. 466p.
- Bové J.M. (1966). Citrus virus diseases in the Mediterranean area. Proceedings of meeting on phytiatric and phytopharmacy. Marseille (France).
- Cambra M., Gorris M.T., Roman M.P., Terrada E., Garnsey S.M., Camarasa E., Olmos A and Colomer M. (2000). Routine detection of Citrus tristeza virus by direct immunoprinting-ELISA method using specific monoclonal and recombinant antibodies, pp 34-41.
- Cambra M., Serra J., Villalba D. and Moreno P. (1988). Present situation of the citrus tristeza virus in the Valencian Community, p.1-7. In: Timmer L.W. et Garnsey S.M (eds). Proc. 10th Conf. IOCV.
- D'Onghia AM. (2009). Citrus certification in the Mediterranean region. In: Citrus Tristeza Virus and Toxoptera citricidus: A serious threat to the Mediterranean citrus industry Option Méditerranéennes, Série B: Studies and Research, N° B 65, - IAM-Bari "Centre International de Hautes Etudes Agronomiques Méditerranéennes".
- Delkhosh H.R. and Tousi N. (2009). Historical review of Citrus tristeza virus and its vectors in Iran, In: Citrus Tristeza Virus and Toxoptera citricidus: A serious threat to the Mediterranean citrus industry. Option Méditerranéennes, Série B: Studies and Research, N° B 65, -IAM-Bari "Centre International de Hautes Etudes Agronomiques Méditerranéennes"
- DSA. Chlef (2016). Direction des services agricoles. Service statistiques. Bilan agricole 2015-2016.
- Gottwald T.R. and Hughes G. (2000). A new survey method for Citrus tristeza virus disease assessment. In Proc. 14th Conf. Of IOCV,(Brazil, 1998),IOCV Riverside: 77-78.
- Gottwald T.R., Garnsey S.M. and Yokomi R.K. (1993). Potential for spread of citrus tristeza virus and its vector, the brown citrus aphid. *Proc. Fla. State Hort. Soc.* 106: 85-94.
- Kitadajima E.W., Muller G.W. et Costa A.S. (1974). Electron microscopy of tristeza-infected *Passiflora gracilis* Jacq. In: LG Wethers M Cohen (eds). Proc. 6th Conf. Int. Org. Citrus Virol. Univ. Calif. Div Agric. Sci. Richmond, California, pp 79-82.
- Lacirignola C. and D'Onghia A.M. (2009). The Mediterranean citriculture: production and perspectives. CIHEAM- Mediterranean Agronomic Institute, Valenzano (Ba) Italy, pp 13-17.

- Muller G.W., Costa A.S., Kitadjima E.W. and Camargo L.J.B. (1974). Additional evidence that tristeza virus multiplies in *Passiflora* spp. In: LG Weathers, M Cohen (eds.). Proc. 6th Conf. Int. Citrus Virol., Univ. Calif. Div. Agric. Sci. Richmond. California, pp 75-78.
- Rebours H. (1950). Les agrumes. Rapport de l'union des syndicats des producteurs d'agrumes en Algérie. 3e édit., 502p.
- Remaudière G. and Remaudière M. (1997). Catalogue of the world's Aphididae, INRA, Paris, 473p.
- Roistacher C.N. (1991). Graft-transmissible diseases of citrus. Handbook for detection and diagnosis. FAO, Rome (Eds.) 286p.
- Yokomi R.K. (2009). Natural spread of severe citrus tristeza virus isolates in citrus preinfected with mild CTV isolates. Proc. 11th Conf. Int. Org. Citrus Virol. IOCV, Riverside, pp 86-92.

## HOW CAN THE STAFF HYGIENE PRACTICES INFLUENCE THE MILK HEALTHY QUALITY? CASE OF STUDY FROM M'ZAB DAIRY IN ALGERIA

Hocine BENSAHA<sup>1\*</sup>, Lahcen BENSAHA<sup>2</sup>

<sup>1</sup>Applied Research Unit in Renewable Energies (ARURE) Center for the Development of Renewable Energies, CDRE, 47133 Ghardaïa, Algeria

<sup>2</sup>SH DP SONATRACH Oued Noumer, Zelfana- Ghardaia , Algeria

\*Corresponding author: hocinemail@yahoo.fr

### Abstract

The consumption of low-quality dairy products can endanger consumers' health and even cause serious food poisoning. The implementation of the quality policy in dairy units is therefore a priority in terms of consumer protection. To assess the implementation of hygiene in dairies in the Ghardaia region in Algeria, a field survey of 7 dairies and a literature research were conducted across the province. Members of staff play a vital role in determining food quality; being trained in hygiene practices remains a quality determinant. Conversely, if poorly trained or careless, staff can be a major source of contamination with their own health, their clothing or their work practices. Also, at the farm level, the incorrect maintenance of the milking equipment and the insufficient level of hygiene in the building proved to be a source of bacterial contamination. In this context, our work has focused on the evaluation of hygiene practices applied by dairies staff.

**Keywords:** *Aerobic plate count, Dairy, Hygienic Practice, Personal, Saharan Region, Safety.*

### Introduction

Micro-environments that promote the growth and proliferation of different microbial strains are created in different stages of milk processing lines. That affects the quality of milk; in other word affects the customer's health. This encourages the dairies managers to take all the necessary preventions for protect their products, such as the hygiene practices. The food safety should be compulsory in every phase of the production chain, and the primary level of production is the first step which means that the dairy quality is closely connected to the activities that take part in the production process that happens on the farm itself (Vilar *et al.*, 2012).

The purpose of our study is to investigate the effect of hygiene practices, especially the staff practices on the milk microbiological quality. By the use of a field survey of seven dairies in the province of Ghardaïa, which recently knows a revolution in milk and its derivatives industry and also by a literature research were conducted across the province.

We have focused on staff in this work; because we thought that they are in directly contact with the product from the first step of preparation until the last stage of storage. We also believe that their conscience with their professionalism play a very important role in their hygiene practices as the respect of security rules, wearing the correct uniform (blouse, cap, boots and gloves) and their own personal hygiene. We found when these practices are not respected the dairy products are poor in the microbiological content. The implementation of hygiene practices by staff gave significant effect to milk quality.

The population growth and the evolution of their standard of living assert the use of modern technology to need of the high level of consumption of food products. This can clearly be seen when we know “UHT milk is consumed extensively throughout the world” (Pujol *et al.*,

2013). That's why many governments devoted their interest in food industry, which have one of the most important challenges which is the microbial quality and the upkeep of sanitary conditions as the high availability of nutrients and oxygen favor microbial growth (Cleto *et al.*, 2012). UHT processing is responsible for 95% of total fluid milk consumed in Algeria (MADR, 2012). The dairy industry depends on proper disinfection by regular sanitization procedures because the milking procedure, shipping and storage of milk load faces risks of further contamination from man, the environment, or from growth of inherent pathogens (Pandey *et al.*, 2011). One of the most important precautions is taking hygiene practices in consideration, specially the staff practices.

Algeria, like other countries seeking self-sufficiency in milk production and its derivatives has created many dairies, and is the case in the Ghardaia region. The enthusiasm for milk production in the M'zab valley led to the creation of many cattle farms (Bensaha *et al.*, 2014a). And because the number never substitute for quality, therefore, the implementation of monitoring the correct hygiene of milk and dairy products throughout the supply chain is essential to ensure the safety and suitability of these products for their intended use (Pandey *et al.*, 2011). Sporulated bacteria pertaining to the genera *Bacillus* and *Paenibacillus* are the main micro-organisms identified as being limiting factors for fluid milk quality, due to inadequate hygienic condition (Huck *et al.*, 2007; Ivy *et al.*, 2012). It's the responsibility of the food producer (Dairy) to identify these points and implement control measures to protect the milk from contamination (Vignola, 2002).

The objective of this study is to investigate the effects of staff hygiene practices on the quality of milk produced by the dairies in M'zab valley. To appreciate the implementation of hygiene in dairies in the Ghardaia region, a field survey on 07 dairies, based on the findings and bibliographical research was conducted across the province, followed by microbiological analyzes of the final product for each dairy concerning the total aerobic mesophilic flora. The notion of good hygiene practices in Algeria remains to be introduced (Plan national de salubrité des aliments, 2006).

## Material and methods

### Survey of dairies studied

This study is based on a detailed survey of 7 dairies in region of M'zab in the province of Ghardaia (located 600 Km south of Algiers) (**Figure.1**), The survey was conducted during three month, from September to November 2016.

The approach of the study was focused on surveys and interviews with the processing units in order to characterize the daily staff hygiene practices of milk processing and dairy products. This survey was performed to determine within each dairy, the worker's instruction level, the clothes worn (blouse, cap, boots and gloves), the medical periodical survey and safe and hygienic measures (Table 1).



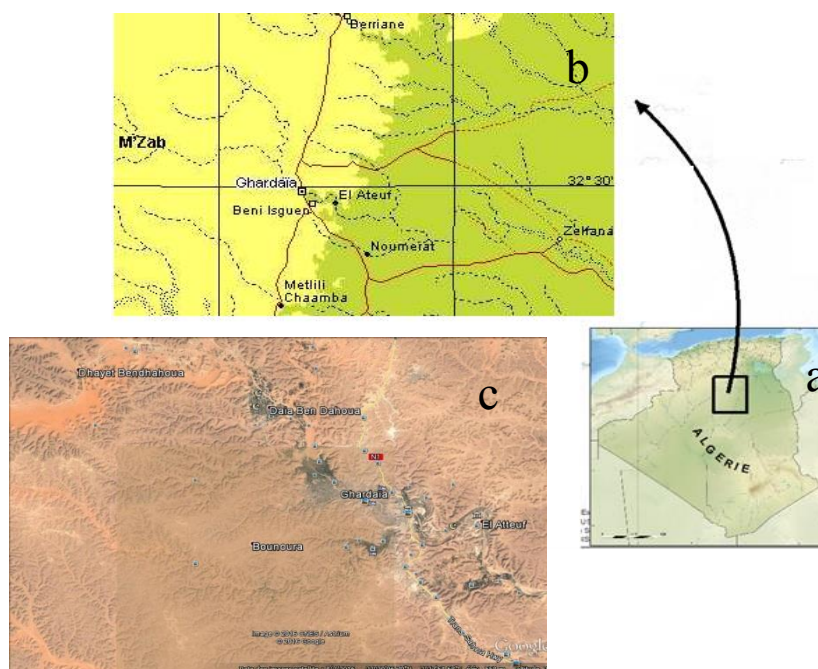


Figure 1: The geographical location of the study area.

A set of maps showing the study area location, map of Algeria, which shows the location of the province of Ghardaïa (a), the geographical location of the areas concerned (b), the geographical location of the areas concerned taken by Google Earth site at an altitude of 30.64 km on 08/02/2016 (c).

Table 1: The data of staff hygiene practices collected.

Dairies	Instruction level	Gloves	Blouse	Blouse color	Boots	Cap	Safe & hygienic rules board	Frequency of medical visits
LA Ghardaia	Secondary	No	Rare	Blue	No	No	No	06 months
LC Gerrara	Medium	No	Yes	White	No	No	No	Every year
LkGerrara	Ts+ Secondary	Yes	Yes	Brown	Yes	No	No	Every year
LM Gerrara	Ts+ Secondary	No	Yes	White	No	No	No	Every year
LW Berrieane	Secondary	No	Yes	White	No	No	No	Every year
LA Metlili	Ts+ Medium	No	Rare	White	No	No	No	Every year
LS Daya ben daho	Medium	No	Rare	White	No	No	No	Every year

### Sampling procedure and laboratory analysis

Milk samples were collected immediately after the packaging (the final step of production), which were transported directly to the laboratory of Algerian central of quality control and packaging in Ghardaia for microbiological analyzes.

Total aerobic mesophilic flora: dilutions ( $10^{-1}$  to  $10^{-5}$ ) of each sample are made. The Petri dish is inoculated with one ml of each dilution which is added to the PCA agar (Table 2). After 72 hours of incubation, all the colonies are counted and the results expressed in units CFU per ml of milk (CFU / ml). (**Federation Internationale de Laiterie, 1991**)

**Table 2: Microbiological analyzes of aerobic mesophilic total flora analysis of each dairy.**

Dairies	TPC
LA Ghardaia	$5 \times 10^5$
LC Gerrara	$7 \times 10^2$
LkGerrara	$8 \times 10^3$
LM Gerrara	$7 \times 10^3$
LW Berrieane	$6 \times 10^3$
LA Metlili	$4 \times 10^2$
LS Daya ben dahoa	$7 \times 10^3$

### Data Analysis and Statistics

We have two types of studied parameters, qualitative parameters (parameters are studying by surveys) and quantitative parameters (microbiological analysis) and to analyze these parameters, we choose to go through two methods.

The first method is to quantify and standardize the values of these parameters in binary system, which represents the parameters values using two different symbols: typically 0 (zero) and 1 (one).

The second method is based on statistical multivariate tools such as Multiple Factorial Analyses (Factor analysis of mixed data), which were used to determine the main factors which describe the variability of milk hygienic quality

The results of the study (Table 03) show that the level of education of the personnel of these processing units is medium or even modest.

Table 3: Standardized parameter values in binary system.

Dairies	Instruction level	Gloves	Blouse	Blouse color	Boots	Cap	Safe & hygienic rules board	Frequency of medical visits	TPC
LA Ghardaia	0	0	0	0	0	0	0	0	0
LC Gerrara	0	0	1	1	0	0	0	1	1
LkGerrara	1	1	1	1	0	0	0	1	1
LM Gerrara	1	0	1	0	0	0	0	1	1
LW Berrieane	0	0	1	1	0	0	0	1	1
LA Metlili	0	0	0	1	0	0	0	1	1
LS Daya ben dahoa	0	0	0	1	0	0	0	1	0

Their low level of education is a handicap for the adoption of newly introduced practices in dairy processing and requiring technical mastery. According to (Bensaha, 2009) the level of training of this staff, their skills in animation and their good knowledge of the specificities of their areas of intervention constitute a non-negligible capital in the development of the production unit. Indeed, we have recorded that these people are poorly recruited, poorly adapted to their jobs and, even worse they received little training on the tools, methods and practices that fall under their responsibility. The training and development of the dairy staff contributes significantly to improving the quality of intervention of these people (Bensaha *et al.*, 2013). Nevertheless, with regard to the availability of labor power, we find that more than half of the dairies face difficulties for its availability in due time, because it is made up of a young workforce, without any experience and with a low professional qualification. This experience remains based on empirical knowledge with very little scientific knowledge. This situation is incompatible with good hygiene practice because the low-tech worker is often incapable of rapidly preventing situations that may affect the milk processing chain.

The initiative should also encourage processors to play their full role and assume their responsibilities in the search for efficient recruitment systems.

The uniform must conform to good hygiene practices, namely: a clean, short-sleeved blouse, clean rubber boots and short nails, no jewelry (wristwatches, gourmet, rings ...), a bucco-nasal mask for Sensitive workstations, gloves, shoes and work boots (Vignola, 2002). The study shows that 80% of milk handlers do not wear headgear, gloves, or bucco-nasal mask and rarely blouses and boots.

Therefore, the cleanliness of body and clothing is not satisfactory. The agents assigned to the various work stations all have a single work wear and boots. According to Bensaha *et al* (2012), cleanliness of staff is essential in the food industries especially for perishable foodstuffs such as milk (Bensaha *et al.*, 2012). Nevertheless, 20% of the manipulators are dressed in a clean white coat and take care of their body and clothing cleanliness (Burbuddhe *et al.*, 2008). Generally, staff must ensure a high degree of body cleanliness, a hair must be well maintained, nail cleanliness and it must have two to several work clothes, preferably light colored. All staff must have clean hands, wear clean clothes and perform clean practices (Pandey *et al.*, 2011). A manipulator must be designated for each task, this reduces the risk of contamination of people coming from contaminated areas (Bensaha *et al.*, 2014b). According to Olechnowics *et al.*, (2012), at the farm level, microbial contamination of milk occurs via the surface of the milking equipment.

The study shows that in 90% of dairies, toilets are far from all other premises. In 20%, the soap is absent at the entrance to the sanitary facilities, which favors poorly washed hands. Cleanliness in the bathroom is not satisfactory (Bensaha *et al.*, 2014a). Noted that bad design of buildings can generate health concerns with significant negative economic repercussions as well as the work of the manipulators. At 90% of the times, dairy equipment and rooms are manually cleaned at regular frequencies. Thus, adequate hand washing facilities and a hygienic hand drying method should be available in the vicinity of the handling area (DSP, 2012). A routine program to check the effectiveness of cleaning should be put in place (Varnam *et al.*, 2001).

Human diseases can be transmitted via milk. The Staff engaged in the handling of foodstuffs and milk in particular must undergo a health examination (Varnam *et al.*, 2001). All dairies (100%) report receiving, once or twice a year, a visit from the working doctor and having their workers vaccinated. It is worth highlighting the positive character of the periodic (bi-annual) health action associated with epidemiological surveys initiated locally to maintain all the epidemiological indices at a satisfactory threshold. This is reflected in visits to the processing units carried out periodically to sensitize the dairy managers to the many aspects of their activity: hygiene, good practice (Bensaha *et al.*, 2014b). It is recommended that people involved in the handling of food should be subjected to health regular checks (Burbuddhe *et al.*, 2008). Only 03 of the dairies surveyed possess plates of safe and hygienic rules. Thus, it is understandable that it is almost impossible for these people to hold a reading of these distinctive emblems. Indeed, it is possible to operate the transformation units according to modern organizational methods. But there must be an agreement to start with on diagnoses and make proper investments as the economic profitability is already enormous (Plan national de salubrité des aliments, 2006).

## **Conclusion**

Through the presentation of theoretical notions of good practice, the success of the dairy industry depends on the promotion of knowledge, examination, continuous study of the performances acquired and practices that have affected positively the safety of food hygiene. This confirms the importance of hygiene training for food handlers.

The adoption of good hygienic practices is an operational approach to tackle the many challenges in food safety and safe and healthy agri-food products. This finding can have important economic consequences; as such contamination can increase the probability of consumers purchasing a product that may have problems related to appearance and flavor. In the end, the debate remains open and the concept of good hygienic practices deserves careful reflection and popularization, both in terms of management and the agricultural profession.

## **Acknowledgement**

On the light of this study, I am grateful to: Dr Doubangolo coulibaly from Institute of Rural Economy (IRE), Mali.

## **References**

- Barbuddhe, SB, and Swain BK, (2008). Hygienic Production of Milk. Technical Bulletin No. 11, ICAR Research Complex for Goa, Ela, Old Goa, 17 pp.
- Bensaha H, (2009). Management of agricultural development perimeters, case of Chebka du M'zab, Thesis Magister, ITAS, UKM, Ouargla (Algérie), 125p.
- Bensaha H, Arbouche F, (2013). Characterization of dairy cattle breeding in a saharan region (ghardaïa, algeria): socio-professional profile of producing breeders *Lucrări Științifice-Seria Zootehnie*, vol. 59.183-189
- Bensaha H, Arbouche F, (2014a). The structures of breeding dairy cattle in the sahara: the status in the m'zab valley (southern algerian shara) *Online J. Anim. Feed Res.*, 4(3): 46-50, 2014.
- Bensaha H, Arbouche F, (2014b). Factors influencing the milk sector in a saharan zone: the case of marketing in the valley of m'zab (algeria) *Lucrări Științifice-Seria Zootehnie*, vol.61.11-19.
- Bensaha H, Mayouf R, Bensaha L, (2012). Inventory and development perspective of milk production in Saharan area: the case of the Ghardaïa region (Algeria). *Online J. Anim. Feed Res.*, 2(3): 264-269.
- Cleto S, Matos S, Kluskens L, and Vieira MJ, (2012). Characterization of contaminants from a sanitized milk processing plant. *PLOS one* 7(6): <http://doi.org/10.1371/journal.pone.0040189>.
- DSP, (2012). Directorate of Health and Population. Evaluation of occupational health activities *Revue et perspectives*. Imprimerie officielle. Mai 2012 : Pages 44 et Annexes.
- International Dairy Federation (IDF), (1991). Milk, somatic cell count of milk. 1991. Standard No. 148, 1-8.
- Huck J R, Hammond B H, Murphy S C, Woodcock N H and Boor K J (2007) Tracking spore-forming bacterial contaminants in fluid milk processing systems. *Journal of Dairy Science* 90 4872–4883.
- Ivy R A, Ranieri M L, Martin N H, den Bakker H C, Xavier B M, Wiedmann M and Boor K J (2012) Identification and characterization of psychrotolerant sporeformers associated with fluid milk production and processing. *Applied Environmental Microbiology* 78 1853–1864

- MADR, (2012). Ministry of Agriculture and Rural Development-MADR. Agricultural and rural renewal on the move - Review and perspectives. Official printing. May 2012: Pages 44 and Appendices.
- Olechnowicz J, and Jaskowski MJ, (2012). Somatic Cells Count in Cow's Bulk Tank Milk. *Journal of Veterinary Medicine Science*. 74, (6), pp. 681-686.
- Pandey GS, and Voskuil GCJ, (2011). Manual on milk safety, quality and hygiene. Golden valley agricultural research trust, Lusaka Zambia. Pp 7-13.
- National Food Safety Plan, (2006). Preliminary draft, FAO / WHO, Algiers, September, 111 pages.
- Pujol L, Albert I, Johnson N B and Membré J M (2013) Potential application of quantitative microbiological risk assessment techniques to an aseptic-UHT process in the food industry. *International Journal of Food Microbiology* 162 283–296.
- Varnam AH, et Sutherland P, (2001). Milk and Milk Products: Technology, Chemistry, and Microbiology. Volume 1 Food products series. An Aspen Publication. New York. pp: 35-37.
- Vignola C, (2002). Science and Technology of Milk Processing of Milk. Edition Presses Internationales Polytechnique, Canada. pp. 3-75.

## BIOCONTROL OF ACTINOBACTERIA AGAINST *STREPTOMYCES SCABIES*

Lamia AOUAR<sup>1,2\*</sup>, Abderrahmane BOULAHROUF<sup>2</sup>

<sup>1</sup> SESNV Faculty. Larbi ben M'hidi University. BP 358, Oum El Bouaghi 04000, Algeria.

<sup>2</sup> University Mentouri 1 Constantine. Faculty of Biology. Road Ain El bey BP 233, Constantine 25017, Algeria.

\*Corresponding author: aouarlamia@yahoo.fr

### Abstract

The phytopathogenic bacteria affect several vegetable crops. *Streptomyces scabies* is the causal agent of common scab, the toxin involved in this pathology is the thaxtomin A. Among genes encoding this toxin, there is the *nos* gene. The objective of this work was focused on the screening of potential biocontrol agents against *S. scabies*. Thus, six strains of Actinobacteria (*S. griseus* Lac1, *S. rochei* Lac3, *S. anulatus* Pru14, *S. champavatii* Pru16, *Nocardiopsis dassonvillei* Vic8 and *N. alba* Pin10) were isolated from Algerian rhizospheric soil. The evaluation of the antagonist capacity of these strains was tested. The *in planta* antagonism test was conducted on radish seedlings in growth pouches. Root growth was estimated by analysis of data with the Winrhizo software. The promising Lac1 antagonist strain was selected to study its effect on *nos* gene expression (qRT-PCR) and thaxtomin A production (HPLC). The Results of antagonism test against *S. scabies* indicated that Pru16, Vic8 and Lac3 strains showed no inhibitor activity *in vitro*. However, *in planta*, these same stains could reduce the pathogenic effect on radish seedlings, which resulted in the disappearance of necrosis. These strains appear to be PGPR. The Lac1 proved active both *in vitro* and *in planta*. Compared to all isolates, the Lac1 isolate acting by antibiosis showed the most significant antagonism. Also, this isolate had effect on *nos* gene expression and production of thaxtomin A. In addition to the widely studied *Streptomyces* sp., this study showed promising new candidate for biological control belonging to the genus *Nocardiopsis*.

**Keywords:** Common scab, biological control, *Streptomyces*, *Nocardiopsis*.

### Introduction

Common scab of potato is a disease that causes economic losses. The disease can also affect other types of vegetables such as radish. Common scab is associated with four main species of Streptomycetes: *Streptomyces scabies*, *S. acidiscabies*, *S. caviscabies* and *S. turgidiscabies*. Common scab is mainly caused by species *S. scabies*. This organism inhibits the growth of young seedlings. The taxonomic studies on plant pathogenic *Streptomyces* showed a high genetic diversity within this group. A common characteristic of these organisms is their ability to synthesize phytotoxins, called the thaxtomins (King *et al.*, 1991).

The thaxtomins are nitrated peptides which inhibit the synthesis of the cellulose during the development of plant tissue. Thaxtomin A is the major toxin produced by *S. scabies*. Its biosynthesis involved a conserved non-ribosomal peptide synthetase (NRPS), P450 monooxygenases and a nitric oxide synthase, encoded by the *nos* gene, which is required for the nitration of the toxin (Loria *et al.*, 2008). The nitric oxide synthase is also responsible for the release of nitric oxide causing scab in host-pathogen interface. This suggests that nitric oxide may play an additional role during the infection process (Healy *et al.*, 2002). Thaxtomin A plays a central role in the induction of lesions formation on the tubers. Studies have shown

that all pathogenic strains of *S. scabies* tested produce thaxtomin A (King *et al.*, 1991). They have demonstrated a correlation between the production of thaxtomin A and pathogenicity. The investigation focused on the *in vitro* and *in planta* antagonism of six actinomycetes strains against *S. scabies*. Also, the study of the culture supernatant effect of the representative strain *S. griseus* Lac1 (active against *S. scabies* *in vitro* and *in planta*) on *nos* gene expression, involved in thaxtomin A biosynthesis by *S. scabies*.

## Material and methods

### Microorganisms

*S. scabies* was isolated from the potato affected by common scab, cultivated in Quebec. The antagonists actinomycetes strains (*S. griseus* Lac1, *S. rochei* Lac3, *S. annulatus* Pru14, *S. champavatii* Pru16, *N. dassonvillei* subsp. *dassonvillei* Vic8 and *N. alba* Pin10) were isolated and identified in Laboratory of Applied Biochemistry and Microbiology University of Constantine (Aouar *et al.*, 2012). The strains were designated: Lac1, Lac3, Pru16, Pru14, Vic8 and Pin10.

### *In vitro* Antagonism against *S. scabies*

Determination of antagonism activity of stains against *S. scabies* was carried out by four different techniques: the vertical stripe (Selvin *et al.*, 2009), agar cylinders (Bauer *et al.*, 1966), the wells technique (Kutzner, 1981) and diffusion disk technique (Wu *et al.*, 2007).

### *In planta* antagonism of actinomycetes against *S. scabies*

#### Radish germination

Radish seeds (*Raphanus sativus* 'Cherrybelle') were sterilized, and then washed with sterile water. They were distributed on Petri dishes containing agar-water medium, and incubated in darkness for germination at 30 °C for 48 h.

#### Subcultures of antagonistic actinomycetes and *S. scabies*

For all strains, tryptic soy broth (TSB) medium was inoculated with 10 µl of a spore suspension ( $10^8$  UFC/ml). The medium was incubated at 30 °C in a rotary shaker (190 rpm) for 48 hours. The culture was then centrifuged at 4000 g for 10 minutes; each pellet was re suspended in five volumes of fresh TSB (Legault *et al.*, 2011).

#### Growth pouches

Six radish seeds were placed in each growth pouch previously sterilized (125 X 75 mm, Mega International) and filled with 18 ml of sterile distilled water. Radish seeds were grown in the presence of 1 ml of antagonist actinomycete suspension and 1 ml of physiological saline, in order to test their eventual effect on radish growth (Legault *et al.*, 2011). To evaluate the antagonistic effect, the radish seeds were inoculated with 1 ml of *S. scabies* suspension and 1 ml of antagonistic strain suspension. The positive control was inoculated with 1 ml of saline and 1 ml of *S. scabies* suspension. Four repetitions were performed for each treatment. Growth pouches packed in aluminum foil and incubated for 6 days at 21°C and 68% humidity, in the plantarium.

### Effect of Lac1 supernatant on *nos* gene expression

#### Culture of *S. scabies* strain

Subcultures of 48 hours were used to inoculate the minimum starch medium (MSM). This medium was amended with (0.1% W/ V) suberin and (0.5% W/V) cellobiose as inducers of thaxtomin A production. The incubation period was 5 days at 30 ° C under agitation (180 rpm). The cultures were supplemented with the methanolic extract of the Lac1 strain at concentration 4 µg/ml (Wu *et al.*, 2007). A randomization of three repetitions was performed for each treatment.

#### Total RNA extraction

Cultures were stopped and the mixture was centrifuged. The pellets containing the total RNA were harvested and supplemented with 1 ml of lysozyme prepared in buffer Tris / EDTA and β-mercaptoethanol (β-ME). After sonication, phenol-chloroform was added, followed by centrifugation. The supernatant was recovered; this step was repeated three times. Finally, a volume of 600 µl of ethanol was added to supernatant containing the RNA. The remaining steps are those of a commercial preparation of RNA "kit" extraction 'Rneasy MiniKit Protocol' (Qiagen, Mississauga, ON, Canada) (Legault *et al.*, 2011)

#### Synthesis and amplification of cDNA

An amount of RNA (20 µl) was dissolved in DEPC water, denatured by heating at 65° C for 7 min. The first strand synthesis is carried out with a commercial preparation 'kit' (GE Healthcare, Baie d'Urfé, QC, Canada). Two target genes were amplified *nos* and *gyr A*. The pair of primers was obtained from Integrated DNA Technologies (IDT, USA). The reference *gyr A* gene 2457 bp (forward primer ggacatccagacgcagtaga; reverse primer ctcggtgttgagcttctct). The *nos* gene 1173 bp (forward primer gagctggcttggaggtcctatc; reverse primer cgcattgttgagatgacgggtacg). Amplification is performed in a thermocycler type Biometra. The amplification cycles are the following: pre-denaturation 95° C (5 min); denaturation 95° C (1 min); association 60° C (1 min); elongation 72° C (2 min); end amplification 72° C (2 min).

#### Genomic DNA extraction from *S. scabies*

*S. scabies* strain was cultured in TSB medium for 5 days. After centrifugation, the DNA contained in pellet was extracted (Pospiech and Neuman, 1995) . This genomic DNA will be amplified together with the cDNA, it will serve as a control for both *nos* and *gyr* genes.

#### Gene expression (qRT-PCR)

The q RT-PCR analysis of transcripts gene was conducted on the Stratagene Mx3000P with SYBRGreen. Thresholds amplification (Ct) for both *nos* and *gyr* genes were translated into relative expression (Legault *et al.*, 2011).

### Effect of Lac1 supernatant on thaxtomin A production

#### Thaxtomin A production and extraction

The MSM amended with suberin and cellobiose was inoculated with *S. scabies*. A Lac1 methanol extract was prepared and added to the culture medium at a concentration of 4µg/ ml. The cultures were incubated at 30° C for one week on a rotary shaker (200 rpm). Four repetitions were performed for both assays and controls (Lauzier *et al.*, 2002).

After centrifugation, the supernatant was harvested. The pellet was used to determine dry weight biomass. Thaxtomin A contained in the supernatant was extracted with ethyl acetate.



Once concentrated, it was separated by preparative thin layer chromatography. The mobile phase was chloroform: methanol (9:1). After migration the yellow spot with Rf equal to 0.27 corresponding to thaxtomin A, was scraped and eluted with methanol: chloroform (Beauséjour *et al.*, 1999).

#### Quantification of thaxtomin A by HPLC

Purified thaxtomin A was dissolved in acetonitrile then quantified by reverse phase HPLC using an Agilent 1260 Series (Agilent Technologies, Santa Clara, CA, USA) with the column: Zorbax SB-C18 (Agilent Technologies). Elution was carried out with a 25-75% acetonitrile linear gradient and detected at 249 nm with a diode array detector (DAD) (160-620 nm).

#### Statistical study

The SAS 9.1 (Statistical Analysis System) program with the GLM (General Linear Model) was used to increase the precision of ANOVA procedures.

### Results and discussion

#### Results

##### *In vitro* antagonism against *S. scabies*

Results of the vertical stripe technique showed that among the six strains only Lac1 and Pru14 inhibited *S. scabies* growth. The inhibition zones recorded were 20 mm for the both strains. The same strains were positive with the agar cylinders technique, where Lac1 and Pru14 exhibited inhibitions of 38 and 16 mm, respectively. However, disk diffusion and wells technique showed that only Lac1 was active, and the inhibition zone was 30 mm. With all the techniques employed, the strains Lac3, Vic8 and Pin10 showed no activities. *In vitro*, the Lac1 strain presented the best inhibition against *S. scabies*.

##### Antagonistic actinomycetes effect on radish growth

After the incubation period, the pouches were scanned. The antagonistic actinomycetes strains showed no pathogenic effect on growth seedling, where the plant showed a good rhizogenesis and the absence of necrosis (Figure 1).

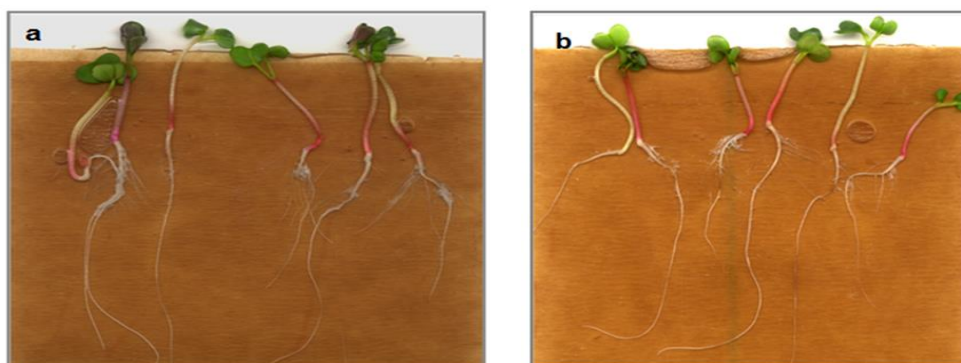


Figure 1: antagonism on radish growth: (a) negative control, (b) Lac1 strain effect.

##### *In planta* antagonism against *S. scabies*

Results analysis by the software WinRhizo followed by ANOVA statistical analysis consolidated with LSD test ( $P < 0.05$ ), indicated that radish seedlings inoculated only with *S. scabies* were affected by common scab, the root surface was  $3.44 \text{ cm}^2$ . The surfaces of root seedlings inoculated with *S. scabies* and antagonists strains varied between  $5.66$  and  $8.06 \text{ cm}^2$  (Table 1).

Table 1: Effect of antagonistic strains on the growth of roots radish inoculated with *S. scabies*.

Roots Surface (cm <sup>2</sup> )	Negative control	6.36 ± 0.99 <b>ab</b>
	Positive control	3.44 ± 0.33 <b>c</b>
Roots Surface of inoculated seeds with <i>S. scabies</i> and antagonists (cm <sup>2</sup> )	Lac1	8.06 ± 1.64 <b>a</b>
	Lac3	6.80 ± 1.81 <b>ab</b>
	Vic8	5.96 ± 0.99 <b>b</b>
	Pin10	5.76 ± 1.28 <b>b</b>
	Pru14	5.66 ± 1.76 <b>b</b>
	Pru16	5.57 ± 1.16 <b>b</b>

Statistical analysis revealed no significant differences between root surfaces of the negative control and those of seedlings inoculated simultaneously with the antagonist strains (Figure 2). Compared to the other strains Lac1 presented the most significant antagonistic activity (Table 1).

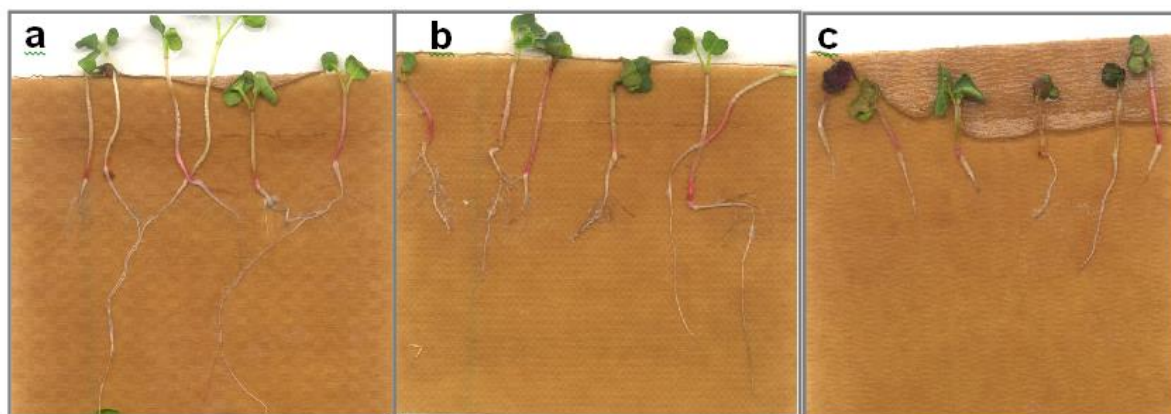


Figure 2: Effect of the antagonists on the roots growth of radish inoculated with *S. scabies* (a): Lac1; (b): Pru14; (c) positive control.

#### Gene expression

The dissociation curve showed two peaks corresponding to two amplicons formed *nos* and *gyr*. This result showed the absence of dimers primers. The dissociation temperature (T<sub>m</sub>) was equal to 89.9° C for *gyr* gene and at 92° C for *nos* gene. Ct values obtained were significant and varied between 23.2 and 31. The highest value (23.2) corresponding to the genomic DNA. The Ct of the reference gene *gyr* was 27 for both controls and assays. This is the reason why the *gyr* gene was chosen as reference gene. The Ct for the target *nos* gene varied from 28 to 31. Analysis of results achieved by the RESET program (Table 2) showed that at 24, 48 and 72 hours significant differences were recorded between controls and the assays. This means the presence of supernatant effect of Lac1 on *nos* gene expression. The expression of the *nos* gene coding for the production of thaxtomine A decreases in the presence of the extract of the Lac1 strain after 48 h of incubation (Figure 3).

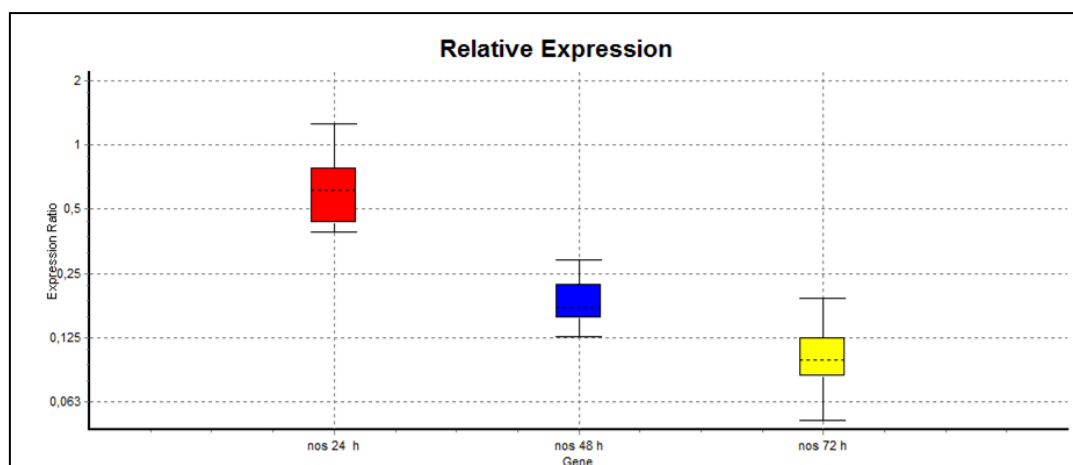


Figure 3: Relative expression of *nos* gene in the presence of Lac1 extract

#### Extraction and quantification of thaxtomin A

The minimum starch medium supplemented with suberine and cellobiose, amended or not with the Lac1 methanolic extract, induced thaxtomin A production by *S. scabies*. The HPLC analysis was carried out with commercial thaxtomin A as standard, which was eluted at 4.90 minutes. Its peak presented a typical absorption spectrum from 150 to 500 nm with a maximum at 249 nm. The chromatogram of the organic extract obtained from *S. scabies*, revealed a peak at 4.91 minutes which has the same absorption spectrum as commercial thaxtomin A.

Quantification of dry weight of the purified thaxtomin A by HPLC in the absence of Lac1 extract was  $2543.39 \pm 248.47$   $\mu\text{g}/\text{mg}/\text{DW}$  and  $1752.87 \pm 152.59$   $\mu\text{g}/\text{mg}/\text{DW}$  in the presence of Lac1 extract. Statistical analysis by the Student test ( $\alpha = 0.05$ ) showed a significant difference ( $P = 0.0014$ ) between the amounts of thaxtomin A produced in the absence and in the presence of the Lac1 extract. There is a significant decrease in the production of thaxtomin which confirmed the gene expression results.

#### Discussion

The strain Pru14 showed inhibitory activity with the agar cylinders technique. However, its activity with disks technique diffusion was only partial. This could be explained by the fact that the bioactive molecule was not produced in a liquid medium or it was produced but was not extracted with ethyl acetate. In the case of actinomycetes, the solid medium is the suitable medium for bioactive molecules production (Anibou *et al.*, 2008). Some metabolites are produced during maturation because aerial mycelium of actinomycetes have morphogenesis program colony coordinated with bioactive molecules excretion (Thompson *et al.*, 2002). In addition, the Pru14 aqueous solution deposited in the wells showed no inhibitory activity in contrast to the agar cylinders technique. It is possible that the molecule diffused poorly in agar medium or is not soluble in water. Common scab caused by *S. scabies*, affect not only potatoes, but also other vegetables like radish. In this study, the radish seedlings were chosen to perform this test *in planta* for two reasons: their susceptibility to *S. scabies* and their rapid growth in the planetarium. The rhizospheric Lac3, Pru16, Pin10 and Vic8 strains showed no *in vitro* activity against *S. scabies*. However, *in planta* these same isolates have minimized the pathogenic effects on radishes; which were translated by the appearance of secondary roots. It is possible that the antibiotic molecule does not diffuse into the agar, or the inadequacy of the fermentation medium and/or extraction solvent. This is in agreement with the results obtained by Selvin *et al.* (2009), who found that the bioactive molecules of the strain *N. dassonvillei* MAD08 extracted by organic solvents inhibited *in vitro* the growth of Gram positive and

Gram negative bacteria, whereas the soluble phase in the water, inhibited *Candida albicans*. According to the literature, about 5% rhizobacteria promote growth and protect plant against pathogens, including bacteria and fungi (Beauchamp *et al.*, 1993). Thus, antibiosis is not the only mechanism used by rhizobacteria to antagonize pathogenic microorganisms. Rhizospheric actinomycetes can also compete with *S. scabies* and thereby reduce its pathogenic effect on seedlings, or produce plant hormones. It appears that Lac3, Pru16, Pin10 and Vic8 strains act either by competition and/or siderophore production. Biological control or biocontrol against *S. scabies* has already been the subject of several studies. A strain of *Streptomyces albidoflavus* CH33 was used as biofertilizers for the control against *S. scabies* (Hayashida *et al.*, 1988). This biological control agent acts by antibiosis, it has been reported that strains belonging to the *S. diastatochromogenes* and *S. albogriseolus* species inhibited the growth of *S. scabies* (Liu *et al.*, 1995). Thaxtomin A synthesis requires the presence of two genes encoding two key enzymes, *txtA* encodes a peptide synthetase involved in cyclization, while *nos* encodes a nitric oxide synthase involved in the nitration of tryptophanyl (Legault *et al.*, 2011). The isolate Lac1, was the most antagonist of *S. scabies* on radishes, was selected to test the effect of its methanolic extract on *nos* gene expression. To extract the total RNA used for the quantification of *nos* gene expression, the culture medium employed was a minimal starch medium amended with suberin and cellobiose. This medium was recommended by Lerat *et al.* (2010) who demonstrated that suberin and cellobiose are inducers of thaxtomin A production in *S. scabies*. Our results confirm those of Lerat *et al.* (2010). In fact, the combination of minimal starch medium with suberin and cellobiose has activated the production of a significant amount of thaxtomin A. The amount of RNA was maximal at 24 hours; this can be explained by the intensity of protein synthesis during the exponential phase of bacterial growth. Our study indicated that thaxtomin A production was not inhibited with 4 mg/ml of methanolic extract of Lac1 strain. Quantification of expression level of *nos* gene by q RT-PCR showed a lower expression level in the presence of the methanolic extract of Lac1. Also, Legault *et al.* (2011) founded that in a culture of *S. scabies* tryptophan addition led to a significant decrease in *nos* gene expression. The proteomic result concurred with that of genomic, because the quantification of thaxtomin, A produced in liquid media by HPLC confirmed the results obtained by the q RT-PCR. Also, studies conducted by Legault *et al.* (2011) on the regulation of thaxtomin A production were confirmed by HPLC and by q RT-PCR. Thaxtomin A biosynthesis is modulated by several factors such as development stage of bacteria, plant compounds, glucose and other aromatic amino acids (Beauséjour *et al.*, 1999).

### Conclusion

The Lac1 strain was active against *S. scabies* with all the antagonism methods used. However, the antagonism of strain Pru14 was found positive only with the agar cylinders technique. This results show their antibiosis action. However, the *in planta* experiments on radish seedlings showed that all strains reduced disease symptoms (root necrosis, etc.). The best results were obtained with the Lac1 strain both *in vitro* and *in planta*. Although the strains Pru16, Lac3, Vic8 and Pin10 showed no activity *in vitro*, but *in planta* they were active because they have reduced the effects of the pathogen. The six strains tested antagonists appear to stimulate the growth of radish seedlings. This stimulation action is certainly involved in the biocontrol process (Kleopfer *et al.*, 1980). These strains may be affiliated to PGPR (Plant Growth Promoting Rhizobacteria). It has been reported that some of these rhizobacteria (PGPR) may also protect plants against phytopathogenic infections by inducing their defense system (Gamalero *et al.*, 2005). These isolates are interesting for biological control because they produced antifungal molecules, and showed chitinolytic activities (Aouar *et al.*, 2012). It is confirmed that the Lac1 strain acted by antibiosis, also it has an effect on the

*nos* gene expression. Among the six strains, two of them belong to the genus *Nocardopsis*. According to El-Tarabily and Sivasithamparam (2006), *Streptomyces* sp. have been widely studied because of their abundance in the soil and their antibiotics production, which have commercial importance. Commercial biocontrol products containing *Streptomyces* living cells as active ingredients are available for farmers (Mycostop, Actinovate and Actino-Iron) (Tahvonen and Avikainen, 1987; Cross and Polonenko, 1996; Crawford *et al.*, 2005). However, the biological control of plant pathogens by non-*Streptomyces* actinomycetes is rarely reported in the literature (El-Tarabily and Sivasithamparam, 2006). Members of the genus *Nocardopsis*, obtained in this study, could be good candidates.

### References

- Anibou M., Chait A., Ziyad A., Taourirt M., Ouhdouh Y. (2008). Actinomycetes from Moroccan habitats: isolation and screening for cytotoxic activities, *World Journal of Microbiology and Biotechnology*, 24, 2019-2025.
- Aouar L., Lerat S., Ouffroukh A., Boulahrouf A., Beaulieu C. (2012). Taxonomic identification of rhizospheric actinobacteria isolated from Algerian semi-arid soil exhibiting antagonistic activities against plant fungal pathogens, *Canadian Journal of Plant Pathology*, 34(2), 165-176.
- Bauer A.W., Kirby W.M. Sherric J.C., Turck M. (1966). Antibiotic susceptibility testing by a standardized single disk method, *American Journal Clinical Pathology*, 45(4), 493-496.
- Beauchamp C. J. (1993). Mode of action of plant growth-promoting rhizobacteria and their potential use as biological control agent., *Phytoprotection*, 74(1), 19-27.
- Beauséjour J., Goyer C., Vachon J., Beaulieu C. 1999. Production of thaxtomin A by *Streptomyces scabies* strains in plant extract containing media, *Canadian Journal of Microbiology*, 45, 764-768.
- Crawford D.L., Kowalski M., Roberts M.A., Merrell G., Deobald L.A. (2005). Discovery, development, and commercialization of a microbial antifungal biocontrol agent, *Streptomyces lydicus* WYEC108: history of a decade long endeavor, *Soc. Industrial Microbiology News*, 55, 88-95.
- Cross J.V., Polonenko D.R. (1996). An industry perspective on registration and commercialization of biocontrol agents in Canada. *Canadian Journal of Plant Pathology*, 18, 446-454.
- El-Tarabily K.A., Sivasithamparam K. (2006). Non-*Streptomyces* actinomycetes as biocontrol agents of soil-borne fungal plant pathogens and as plant growth promoters, *Soil Biology and Biochemistry*, 38, 1505-1520.
- Gamalero E., Lingua G., Tombolini R., Avidano L., Pivato B., Berta G. (2005). Colonization of tomato root seedling by *Pseudomonas fluorescens* 92rkG5: spatio-temporal dynamics, localization, organization, viability, and culturability, *Microbial Ecology*, 50, 289-297.
- Hayashida S., Choi M.Y., Nanri N., Miyaguchi M. 1988. Production of potato common scab-antagonistic biofertilizer from swine feces with *Streptomyces albidoflavus*, *Agricultural and Biological Chemistry*, 53, 349-354.
- Healy F.G., Krasnoff S.B., Wach M., Gibson D.M., Loria R. (2002). Involvement of a cytochrome P450 monooxygenase in thaxtomin A biosynthesis by *Streptomyces acidiscabies*, *Journal of Bacteriology*, 184, 2019-2029.
- King R.R., Lawrence C.H., Clark M.C. (1991). Correlation of phytotoxin production with pathogenicity of *Streptomyces scabies* isolates from scab infected potato tubers, *American Potato Journal*, 68 (10), 675-680.

- Kleopfer J.L., Leong J., Teintze M., Schroth M.N. (1980). Enhanced plant growth by siderophores produced by plant growth-promoting rhizobacteria, *Nature*, 286, 885-886.
- Kutzner H.J. (1981). The family Streptomycetaceae. In: *The Prokaryotes*. Starr M. P., Stolp H., Trüper H. G., Balows A. and Schlegel H. G. (Eds). A Handbook on Habitats, Isolation, and Identification of Bacteria. Vol. 2. Springer Verlag, Berlin. 2028- 2090.
- Lauzier A., Goyer C., Ruest L., Brzezinski R., Crawford D.L., Beaulieu C. (2002). Effect of amino acids on thaxtomin A biosynthesis by *Streptomyces scabies*, *Canadian Journal of Microbiology*, 48, 359-364.
- Legault S.G., Lerat S., Nicolas P., Beaulieu C. (2011). Tryptophan regulates thaxtomin A and indole-3-acetic acid production in *Streptomyces scabiei* and modifies its interactions with radish seedlings, *Phytopathology*, 101(9), 1045-1051.
- Lerat S., Simao-Beauvoir A.-M., Wu R., Beaudoin N., Beaulieu C. (2010). Involvement of the plant polymer suberin and the disaccharide cellobiose in triggering thaxtomin A biosynthesis, a phytotoxin produced by the pathogenic agent *Streptomyces scabies*. *Phytopathology*. 100, 91-96.
- Liu D., Anderson N.A., Kinkel L. 1995. Biological control of potato scab in the Field with antagonistic *Streptomyces scabies*, *Phytopathology*, 85, 827-831.
- Loria R., Bignell D.R.D., Moll S., Huguet-Tapia J.C., Joshi M.V., Johnson E.G., Seipke R.F., Gibson D.M. (2008). Thaxtomin biosynthesis: the path to plant pathogenicity in the genus *Streptomyces*, *Antonie van Leeuwenhoek*, 94, 3-10.
- Pospiech A., Neuman B. 1995. A versatile quick-prep of genomic DNA from gram-positive bacteria, *Trends in Genetics*, 11, 217-218.
- Selvin J., Shanmughapriya S., Gandhimathi R., Seghal-Kiran G., Rajeetha Ravji T., Natarajaseenivasan K., Hema T.A. (2009). Optimization and production of novel antimicrobial agents from sponge associated marine actinomycetes *Nocardioopsis dassonvillei* MAD08, *Applied Microbiology and Biotechnology*, 83, 435-445.
- Tahvonen R.T., Avikainen H. (1987). The biological control of seedborne *Alternaria brassicicola* of cruciferous plants with a powdery preparation of *Streptomyces* sp, *Journal of Agricultural Science in Finland*, 59, 199-208.
- Thompson C.J., Fink D., Nguyen L.D. (2002). Principles of microbial alchemy: insights from the *Streptomyces coelicolor* genome sequence, *Genome Biology*, 3(7), 10201-10204.
- Wu X.C., Chen W.F., Qian C.D., Li P. O., Wen Y.P. (2007). Isolation and Identification of newly isolated antagonistic *Streptomyces* sp. strain AP19-2 producing Chromomycins, *Journal of microbiology-Seoul*, 45(6), 499-504.

## IMPACT OF THREE DIET REGIMES ON BIOLOGICAL PARAMETERS OF *Ectomyelois ceratoniae*

Mohamed Seghir MEHAOUA<sup>1\*</sup>, Ayoub HADJEB<sup>1</sup>, Hanane BEDJAOU<sup>1</sup>, Mohamed Laïd OUAkid<sup>2</sup>

<sup>1</sup>Department of Agronomy, University Mohamed Khider, Biskra, 07000, Algeria

<sup>2</sup>Department of Biology, University Badji Mokhtar, Annaba, 23000, Algeria

\*Corresponding author: linaseghir@yahoo.fr

### Abstract

Carob moth *Ectomyelois ceratoniae* Zeller control requires knowledge of biological parameters in relation with different diets; these data will represent a fundamental tool allowing mechanisms interpretation of variation in abundance of this pest. The biological parameters of *E. ceratoniae* were studied in a controlled breeding chamber within a temperature of  $27 \pm 2$  ° C, relative humidity of  $65 \pm 10\%$  and a photoperiod of 16 hours light and 8 hours of darkness on the dates of Deglet Noor, Mech Degla and Ghars varieties. The results showed that the net reproductive rate ( $R_0$ ), intrinsic rate of increase ( $r_m$ ) and the finite rate of increase ( $\lambda$ ) of the carob moth on the three considered varieties dates are significantly different. These latest parameters were lower on the dates of Mech Degla and Ghars and higher on Deglet Noor (respectively  $29.05 \pm 6.84$ ,  $0.162 \pm 0.05$  and  $1.18 \pm 0.05$ ). The mean generation time (T) and the doubling time (DT) were significantly longer on the dates of Mech Degla with respectively,  $32.66 \pm 7.74$  and  $8.37 \pm 1.35$  days. On the contrary of fecundity rate and fertility, the development duration of various stages of *E. ceratoniae* showed highly significant differences where, the longest time was recorded in individuals fed by Ghars dates. Our results showed that the fruit nutritional quality of the three varieties influence greatly on the development and the growth of *Ectomyelois ceratoniae*.

**Keywords:** *Ectomyelois ceratoniae*, date, development, growth, reproduction

### Introduction

The *Ectomyelois ceratoniae* Zeller is a well-known pest of date in Algeria (Lepigre, 1963 and Wertheimer, 1958), it remains among the most dreaded pest of the Algerian palm groves. The carob moth poses a serious economic threat to the date Industry (Norouzi and *al.*, 2008).

The study of the mechanisms responsible of the organism populations' regulation is essential for a better understanding of the structure of biological communities and their evolution forces in nature (Alyokhin and *al.*, 2011). The quality and quantity of food offered by the host plant are major factors controlling the population dynamics of phytophagous insects (Klingauf, 1987). Thus, nutrition provides for the insect the necessary chemical compounds for its growth, development, reproduction, defense, displacement and survival (Slansky and Rodriguez 1987). The host plant as a food source plays a key role in population dynamics with its nutritional and allelochemicals components (Ohgushi 1992).

Insect nutritional needs changes in function of time, depending on the destination of growth, reproduction, diapauses and migration. In general, the nutrients needs of young larvae are higher than the older ones (Kumbasli, 2005). In order to control this polyphagous pest, it is important to clearly define its feeding behavior with a variety of food sources. What makes the study of various biological parameters under the effect of different diets, a fundamental

information allowing the comprehension and the interpretation of variation mechanisms in abundance of this pest.

For that, our work aim is to study the impact of the nutritional quality of three diets dates of Deglet Noor (semi-soft), Mech Degla (dry) and Ghars (soft) on parameters development, reproduction and growth of *E. ceratoniae*.

## Material and Methods

To determine the life table parameters of *E. ceratoniae* it needs rearing of carob moth on dates of Deglet Noor, Mech Degla and Ghars varieties. This experiment was conducted in the laboratory in rearing chamber at a temperature of  $27 \pm 2$  ° C, relative humidity  $65 \pm 10\%$  and a photoperiod of 16: 8 (L: D) hours.

To facilitate the observation and monitoring of each larval stage, we introduced freshly laid eggs (same age) into dates, an egg for each date, after being cut in two parts by using secateurs and eliminating the core. Dates are then sealed and placed separately in small plastic boxes on which establishment date, the individual's number and the name of the variety were indicated. After removal of no fertile eggs, measurements were performed on only 25 individuals of each development stage, from egg incubation until adult emergence.

The development stages were verified each day with a binocular microscope and periods of development, mortality of eggs, larvae, pupae and adults, and sex ratio were recorded. This experiment was continued until the death of all individuals in the cohort.

To calculate the demographics parameters of carob moth, the same number of males and females was selected at random from the newly emerged adults respectively Deglet Noor, Degla and Mech Ghars variety for the separated couple placed in Petri dishes in the rearing room. The number of eggs laid by each female and the number of fertile eggs were recorded daily until the death of the last female. The essential factors allowing population parameters calculation were female age in days ( $x$ ), number of live females at age  $x$  ( $l_x$ ) and mean number of female eggs laid per female per day ( $m_x$ ).

Demographic parameters were calculated from daily records of mortality, females' fecundity and fertility of *E. ceratoniae* cohorts. Reproductive (gross rates of fecundity and fertility, net fecundity and fertility, the mean number of eggs and the mean number of fertile eggs per female per day) and growth parameters [Intrinsic rate of increase ( $r_m$ ), net reproductive rate ( $R_0$ ), mean time of a generation ( $T$ ), finished rate of increase ( $\lambda$ ) and doubling time ( $D_T$ )] were calculated using the formulas proposed by Carey (1993) et Maia and *al.*, (2000). The various calculated parameters were subjected to an analysis of variance (ANOVA) and the mean comparison is made by the Fisher's multiple comparison tests at 5% level using XLSTAT software 2013.

## Results and Discussion

### *Developmental time and life table*

Monitoring development cycle of *E. ceratoniae* spawning until adult emergence in dates varieties Ghars, Deglet Noor and Mech Degla (Table 1) showed that the duration of larval period development (1<sup>st</sup> instar larvae from to 5<sup>th</sup> instar larvae) of *Ectomyelois ceratoniae* was significantly different (Table 1). The duration of the various instars longest was recorded on variety Ghars compared to Deglet Noor dates and Mech Degla. Our results showed that the duration of carob moth larval development obtained in our study on three varieties of dates was shorter than that recorded by Norouzi and *al.* (2008) on Zahedi date. Conversely, no significant difference ( $P = 0.5322$ ) was observed between the eggs incubation period (from



3.76 to 3.88 days) between the three varieties. These results were partly in agreement with Norouzi and *al.* (2008); Al Rubeai (1987).

**Table 1.** mean developmental time (day) of *E. ceratoniae* on dates of three varieties

Stages of development	Mean duration ± standard deviation (days)			P
	Deglet Noor	Mech Degla	Ghars	
Eggs incubation period	3.88 ± 0.33 a	3.76 ± 0.44 a	3.84 ± 0.37 a	0.5322
1 <sup>st</sup> instar larvae	6.28 ± 0.46 a	4.32 ± 1.15 b	6.12 ± 0.73 a	< 0.0001
2 <sup>nd</sup> instar larvae	6.04 ± 0.68 b	4.88 ± 0.53 c	7.52 ± 1.01 a	< 0.0001
3 <sup>rd</sup> instar larvae	5.04 ± 0.74 b	5.44 ± 1.29 b	6.04 ± 0.68 a	0.0015
4 <sup>th</sup> instar larvae	4.08 ± 1.04 b	5.84 ± 1.60 a	5.92 ± 1.00 a	< 0.0001
5 <sup>th</sup> instar larvae	6.40 ± 2.42 b	6.80 ± 1.63 b	8.96 ± 3.60 a	0.0023
Larval development time	31.72 ± 3.12b	31.04 ± 3.01b	38.40 ± 4.13 a	< 0.0001
Pupal period	6.28 ± 1.95 b	7.16 ± 1.63ab	7.96 ± 2.87 a	0.0318
Adult longevity	4.30 ± 1.13 a	3.40 ± 0.69 b	4.65 ± 1.23 a	0.0192
Life cycle	42.60 ± 4.06b	42.20 ± 3.65b	51.40 ± 5.73 a	< 0.0001

Different letters in the rows indicate significant ( $P < 0.05$ ) differences within various dates.

However, significant differences were recorded between development time chrysalis stage ( $P = 0.0318$ ), and adults ( $P = 0.0192$ ) on the three varieties of fruit, with a longer duration for pupae Ghars dates (7.96 days) and a shorter one for Deglet Noor dates (6.28 days). Emerged adults of Ghars and Deglet Noor dates had a longer life marked with 4.65 and 4.30 days respectively compared to adults emerged of the Mech Degla dates with 3.40 days (Table 1). The duration of the pupal stage of *E. ceratoniae* on different dates was similar to that found by Norouzi and *al.* (2008); Zare and *al.* (2013). Also, emerged adults on Deglet Noor and Ghars had scored a close longevity that observed by Norouzi and *al.* (2008) on the Zahedi. A highly significant difference was also observed between the life cycle duration of carob moth made on the dates of the three varieties ( $P < 0.0001$ ), it ended in a long period of 50.50 days in the variety Ghars compared to the other two varieties. The life cycle of *Ectomyelois ceratoniae* on different varieties was comparable to that recorded by Zare and *al.*, (2013) on three pomegranate varieties. However, it was shorter than that obtained by Norouzi and *al.*, (2008). It appears that the duration of the different development stages of *E. ceratoniae* is affected by the food quality. The work of Nay (2006) showed that the mortality rate and development time carob moth may be affected by dates humidity.

### **Reproductive parameters**

The gross rate of females fecundity and fertility of carob moth was higher among females emerged from Deglet Noor dates (respectively 129.70 and 111.90 eggs) followed by the females of dates Mech Degla (respectively 128.80 eggs and 101.00 eggs), whereas it was low in emerged females of Ghars variety with 112.80 and 91.70 eggs respectively (Table 2). For net fecundity and fertility, they were lower on the Mech Degla dates (respectively 41.22 and 32.32 eggs) compared to other varieties. However, analysis of the variance in gross and net rates of fecundity and fertility of *Ectomyelois ceratoniae* on the three varieties of dates, showed no significant difference (Table 2).

**Table 2.** Population reproductive parameters of *E. ceratoniae* on dates of three varieties of dates.

Parameter	Dates Varieties			P
	Deglet Noor	Mech Degla	Ghars	
Gross fecundity rate	129.70 ± 9.66 a	128.80 ± 12.65 a	112.80 ± 14.75 a	0.5658
Gross fertility rate	111.90 ± 10.13 a	101.00 ± 7.35 a	91.70 ± 14.39 a	0.4726
Net fecundity rate	51.88 ± 3.86 a	41.22 ± 4.05 a	45.12 ± 5.90 a	0.3807
Net fertility rate	44.76 ± 4.05 a	32.32 ± 2.35 a	36.68 ± 5.76 a	0.2530
Mean Daily eggs per female	27.76 ± 2.09 ab	36.41 ± 6.82 a	21.99 ± 2.95 b	0.0432
Mean Daily fertile eggs per female	23.83 ± 2.15 a	28.04 ± 4.19 a	17.91 ± 2.77 a	0.0777

Different letters in the rows indicate significant ( $P < 0.05$ ) differences within various dates.

The Mean number of eggs per female per day for females emerged from different dates was significantly different ( $P = 0.0432$ ). This parameter was higher on Mech Degla with 36.41 eggs and lowers on Ghars with 21.99 eggs (Table 2). In addition, the fertile eggs number per female per day was not significantly influenced by the difference in dates varieties consistence ( $P < 0.0777$ ). This variation in reproductive parameters of carob moth on different varieties could be the result of differences in host plant quality, translating a difference of nutrients required by the pest or differences in the levels of secondary compounds (Naseri et al., 2011).

### Growth parameters

In this study, we noted that the net reproductive rate ( $R_0$ ), intrinsic rate of increase ( $r_m$ ) and the finite rate of increase ( $\lambda$ ) were significantly higher on Deglet Noor dates in comparison to the two other varieties, respectively 29,05 females per female per generation, 0,162 females per female per day and 1.18 (Table 3).

According to Dajoz, (1974) the intrinsic rate of natural increase ( $r_m$ ) is a parameter that can predict the population growth rate because it includes values such as development time, fecundity and mortality which condition the reproductive capacity of the species.

The parameters of life table, especially the intrinsic rate of natural increase ( $r_m$ ), are the most important parameters that can be used to evaluate the level of plant resistance to insects (Razmjou and al., 2006; Goodarzi and al., 2015; Mahmoudi and al., 2015). The host plants with lower values of  $r_m$  are relatively stronger than plants with higher values of  $r_m$  (Zare and al., 2013). Indicating that the variety Deglet Noor is a suitable food source for the growth of carob moth population in comparison with other varieties of dates.

**Table 3.** The population Growth parameters of *E. ceratoniae* on fruit of three varieties of dates.

Parameter	Varieties of dates			P
	DegletNoor	MechDegla	Ghars	
Net reproductive rate ( $R_0$ )	29.05 ± 6.84 a	14.84 ± 3.26 b	21.66 ± 8.95 b	0.0055
Intrinsic rate of increase ( $rm$ )	0.162 ± 0.05 a	0.085 ± 0.01 b	0.125 ± 0.03 b	0.0027
Finite rate of increase ( $\lambda$ )	1.18 ± 0.05 a	1.09 ± 0.02 b	1.13 ± 0.04 b	0.0029
Doubling time ( $D_T$ )	4.68 ± 1.60 b	8.37 ± 1.35 a	5.92 ± 1.53 b	0.0010
Mean generation time ( $T$ )	22.20 ± 6.45 b	32.66 ± 7.74 a	24.45 ± 5.00 b	0.0174

Different letters in the rows indicate significant ( $P < 0.05$ ) differences within various dates.

The doubling time ( $D_T$ ) of the population of *E. ceratoniae* is longer on the Mech Degla (8.37 ± 1.35 days) and very short on Deglet Noor (4.68 ± 1.60), the doubling time of the dates of the three varieties are significantly different ( $P = 0.0010$ ). Doubling time ( $D_T$ ) calculated on Deglet Noor and Mech Degla is partly consistent with Nay (2006) on artificial diet, dates Kimri, dates Khalal, and dates Ripe. The same author has also determined that the doubling time of carob moth is strongly influenced by the dates' humidity.

The mean generation time ( $T$ ) of the *E. ceratoniae* showed a significant difference in the three cultivars ( $P = 0.0174$ ) (Table 3). The maximum and minimum of the mean generation time was calculated on the Mech Degla and Deglet Noor respectively 32.66 ± 7.74 and 22.20 ± 6.45 days (Table 3).

Vegetal species differ greatly in their pertinence as hosts for specific insects when measured in terms of survival, development and reproduction rates (Naseri and *al.*, 2009 and 2011). A shorter time of development and greater insect reproduction on a host plant indicates greater relevance of this plant (Van Lenteren and Noldus, 1990). The quality and quantity of food ingested by an insect can directly affect the survival and reproduction (Van Steenis and El - Khawass, 1995; Du and *al.*, 2004). So the fitness of phytophagous insects depends on the nutrients in their host plant (Naseri and *al.*, 2009). In fact, the date Deglet Noor seems response to the nutritional requirements of larvae's better than other varieties.

### Conclusions

The independent nutrition parameters, which are the mean incubation period of eggs and fecundity and fertility rates and the number of fertile eggs laid per female per day that does not seem to be affected by the nutritional quality of three varieties of dates. For dependent parameters of nutrition, we identified the growth parameters and development parameters.

This work demonstrated that the heterogeneity in the nutrient quality of food influences on the biological performance and feeding behavior of the carob moth. This showed that the dates of the variety Deglet Noor provided the best conditions for the development and growth of the population of the carob moth in comparison with Mech Degla and Ghars dates. It appeared that Deglet Noor is more sensible to attack by this pest compared to other cultivars.

### References

- AL-Rubeai H. F., 1987. Growth and development of *Ectomyelois ceratoniae* (Lepidoptera: Pyralidae) under laboratory mass-rearing conditions.-*Journal of Stored Products Research*, 23: 133-135.
- Alyokhin A., Drummond F. A., Sewell G. and Richard Storch R. H., 2011. Differential Effects of Weather and Natural Enemies on Coexisting Aphid Populations. *Environmental Entomology*. 40(3):570-580.

- Carey, J. R., 1993. Applied Demography for Biologists, with Special Emphasis on Insects. Oxford University Press, U. K. 211p.
- Dajoz R., 1974. Dynamique des Populations. Ed Masson et Cie, Paris, 301 pp.
- Du, L., Ge, F., Zhu, S. and Parajulee, M. N., 2004. Effect of Cotton Cultivar on Development and Reproduction of *Aphis gossypii* (Homoptera: Aphididae) and Its Predator *Propylaea japonica* (Coleoptera: Coccinellidae). *J. Econ. Entomol.* 97:1278- 1283.
- Goodarzi, M., Fathipour, Y. and Talebi A. A., 2015. Antibiotic Resistance of Canola Cultivars Affecting Demography of *Spodoptera exigua* (Lepidoptera: Noctuidae). *J. Agric. Sci. Technol.*, 17: 23-33.
- Klingauf F.A., 1987. Feeding, adaptation and excretion. In *Aphids: Their Biology, Natural Enemies and Control*, Ed. A. K. Minks and P. Harrewijn, Elsevier, Amsterdam, The Netherlands .Vol.A: 225–253.
- Kumbasli M., 2005. Etudes sur les composés polyphénoliques en relation avec l'alimentation de la tordeuse des bourgeons de l'épinette (*Choristoneura fumiferana* Clem.) Thèse doctorat des Sciences Forestières. Faculté de foresterie et de géomatique, (Studies on polyphenolic compounds in relation to spruce budworm feeding (*Choristoneura fumiferana* Clem.) Thesis doctorate in Forest Science. Faculty of Forestry and Geomatics). , university of Laval. Québec 176p.
- Lepigre A., 1963. Essais de lutte sur l'arbre contre la pyrale des dattes (*Myelois ceratoniae* Zeller (Control trials on the tree against date borer (*Myelois ceratoniae* Zeller)– (*Pyralidae*) *Annal. Epiphyties.* 14(2): 85-105.
- Mahmoudi M., Sahragard A., Pezhman H., and Ghadamyari M., 2015. Demographic Analyses of Resistance of Five Varieties of Date Palm, *Phoenix dactylifera* L. to *Ommatissus lybicus* De Bergevin (Hemiptera: Tropiduchidae). *J. Agric. Sci. Technol.*, 17.
- Maia A. H. N., Luiz A. J. B., Campanhola C., 2000. Statistical influence on associated fertility life table parameters using jackknife technique, computational aspects. -*Journal of Economic Entomology.* 93: 511-518.
- Naseri B., Fathipour Y., Moharrampour S. and Hosseinaveh V., 2009. Comparative Life History and Fecundity of *Helicoverpa armigera* (Lepidoptera: Noctuidae) on Different Soybean Varieties. *Entomol. Sci.* 12: 147-154.
- Naseri B., Fathipour Y., Moharrampour S., and Hosseinaveh V., 2011. Comparative Reproductive Performance of *Helicoverpa armigera* (Hübner) (Lepidoptera: Noctuidae) Reared on Thirteen Soybean Varieties. *J. Agr. Sci. Tech.* 13: 17-26.
- Nay J. E., 2006. Biology, Ecology and Management of the carob moth, *Ectomyelois ceratoniae* (Zeller) (Lepidoptera: Pyralidae), a pest of dates, *Phoenix dactylifera* L., in southern California. Thesis doctorate, university of California Riverside, USA, 296 p.
- Norouzi A, Talebi A, Fathipour AY., 2008. Development and demographic parameters of the Carob moth *Apomyelois ceratoniae* on four diet regimes. *Bulletin of Insectology.* 61:291-297.
- Ohgushi T., 1992. Resource limitation on insect herbivore populations. In: *Effects of resource distribution on animal- plant interactions.* Edited by Hunter M. D., Ohgushi & P.W. Price. Academic Press Inc: 199-24.
- Razmjou J., Moharrampour S., Fathipour Y. and Mirhoseini S. Z., 2006. Effect of Cotton Cultivar on Performance of *Aphis gossypii* (Homoptera: Aphididae) in Iran. *J. Econ. Entomol.* 99:1820-1825.
- Slansky F. Jr., and Rodriguez J.G., 1987. Nutritional ecology of insects, mites, spiders, and related invertebrates: an overview: 1-69.

- Van Lenteren, J. C. and Noldus, L. P. J. J., 1990. Whitefly-plant Relationship: Behavioral and Biological Aspects. In: "Whitefly: Their Bionomics, Pest Status and Management", Gerling, D. (Ed). Intercept, Andover, U. K: 47-89.
- Van Steenis, M. J. and El-khawass, K. A. M. H., 1995. Life History of *Aphis gossypii* on Cucumber: Influence of Temperature, Host Plant and Parasitism. *Entomol. Exp. Appl.* 76: 121-131.
- Wertheimer M., 1958. Un des principaux parasites du palmier dattier algérien: le Myelois décoloré (One of the main parasites of the Algerian date palm : The Mylois discolored) . *Fruits*. 13(8):109-123.
- Zare D., Sendia J.J., Nodoushanb A.J. and Khosravia R., 2013. Life table parameters and biological characteristics of *Apomyelois ceratoniae* Zeller (Lepidoptera: Pyralidae) on three cultivars of pomegranate. *Archives of Phytopathology and Plant Protection*, 8 p

**EFFECTIVENESS OF WATER EXTRACTS OF *PEGANUM HARMALA*  
ANDESSENTIAL OILS OF *MENTHA PULEGIUM* ON *CALLIPTAMUS BARBARUS*  
(ORTHOPTERA: ACRIDIDAE)**

Moad ROUIBAH<sup>\*</sup>, Rabah BOUREDJOUL, Salaheddine KOUAHI

Department of Environment science, Universty of Jijel, Algeria

\*Corresponding author: rouibahm@yahoo.com

**Abstract**

This work is a study on the insecticidal effect of aqueous extracts of seeds and leaves of Harmal *Peganumharmala* and essential oils of mint *Menthapulegium* on both of two larvae L2 and L3 of barbarian locust *Calliptamusbarbarus* (Orthoptera: Acrididae). Treatments on *C. barbarus* have been performed by two ways: contact and ingestion. Contact allowed us to obtain a cumulative mortality rate (after 3 days of treatments) which was 90% for a highest dose (2.4 g/l) with an LD 50 of 0.67 g /l for *P. harmala*EAq seeds and 50% of mortality with 3.01g / l for leaves of the same plant. For the HEs of *M. pulegium*, with the highest dose (48 µl/ml) we recorded a cumulative mortality of 100%. The LD50 is 12.58 µl/ ml. By ingestion and after 6 days of treatments, the cumulative mortality rate for the dose of 2.4 g/l and the LD 50 of EAq seeds were respectively 90% and 0.45 g /l. For leaves of the same plant, these were 70% and 0.85 g /l. For the HEs of *M. pulegium*, the yield of mortality was 80% with a dose of 48µl/ml for an LD50 of 23.98 µl/ ml. Finally authors concluded that the results were very satisfactory.

**Keywords:** *Calliptamus barbarus*; *Menta pulegium*, *Peganum harmala*, Essential oil, Aqueous extracts, Mortality.

**Introduction**

Food safety is mainly based on the protection of crops against bio-aggressors, including Orthoptera. Among the Calliptaminae, *C. barbarus* is the most polymorphous species. It has a chromatic and geographical polymorphism (Clement et al.,1987; Benzara, 2004; Larrosa et al., 2004; Rouibah et al, 2016). In addition, it is a dangerous species causing a lot of damage in Algeria. In agriculture, the protection of crops against pests, weeds and diseases is generally achieved through chemical control. This is based on the application of various phytosanitary products of synthesis (Regnault-Roger et al., 2002). Unfortunately, these chemicals cause health and environmental problems. The cause is the contamination of natural environments by non-degradable polluting molecules. For these reasons, it is therefore urgent to propose alternative solutions such as the use of natural pesticides. These pesticides are based on the extraction of bioactive substances from plants. Currently, this use is very widespread in the world hence the interest of this study. In order to control the larvae of *C. barbarus*, the choice was made on two plant species known for their therapeutic virtues. It is the Harmal: *Peganum harmala* (Zygophyllaceae) and the mint pouliot: *Mentha pulegium* (Labiace). Some works has already been successfully carried out on the harmal but against the larvae of the Desert Locust: *Schistocerca gregaria* (Idrissi Hasani et al, 1998; Benzara et al, 2010). Concerning mint, the works are rare, but this plant is known for these therapeutic virtues (Karousou et al., 2007). The aim of this study is to test the effect of the aqueous

extracts and essential oils of the grains and leaves of these two plants on the larva of *C. barbarus* the locust by two methods: the direct contact and their effect by ingestion.

### **Material and methods**

For Harmal, the bioactive substances tested are the aqueous extracts (EAq) of grains and leaves. For the Mint, the bioactive substances tested are the essential oils (HEs) of the leaves. Two processes were required for the extraction of the active ingredients. For Harmal, the method of maceration was chosen with a view to obtaining the extracts (mainly the alkaloids). For mint, the method of hydro distillation has been adopted for the extraction of these essential oils. Once the substances are obtained, their yield is calculated and their chemical composition analyzed before testing their acridicidal effect.

#### **Preparation of extracts based on grains and leaves of *Peganum harmala*:**

##### **Maceration protocol**

The grains of *P. harmala* were cleaned of impurities, washed with tap water and dried in the dark for a few days. They are then ground (using an electric mixer) into a moderately fine powder, from which the various extracts have been prepared. The aqueous extract (EAq) is obtained according to the method described by Mbiantcha et al. (2011), with some modifications. Maceration is done with 100g of the grain powder in 1000 ml of warm distilled water for 3 days. Filtration on hydrophilic cotton and then on Wattman paper was carried out. For the evaporation of distilled water, the filtrate is placed in an oven at 45 ° C. until an extract is obtained which is subsequently stored at -4 ° C. in a freezer until it reaches its use. The brute extraction (EBr) was carried out with 80% methanol (10 g of grain powder / 100 ml) for 24 hours at ambient temperature and protected from light. A second maceration is carried out after filtration on hydrophilic cotton and then through Wattman paper. The filtrates are recombined and then evaporated (by a rotary evaporator) almost dry. The final residues are dried in an oven as described previously (Mbiantcha et al., 2011).

##### **Extraction of essential oils from Mint: hydrodistillation protocol**

Once collected, the leaves were first rinsed with distilled water and then dried in the shade for 8 days. The essential oils of Mint are obtained by hydro distillation. It is a method based on the use of a Clevenger, using dried leaves with distilled water. The experimental hydro-distillation protocol employed here is that proposed by Pavida et al. (1976), with some modifications: 50 g instead of 100 and 700 ml of distilled water instead of 1400. According to El Haib (2011) the duration of a hydro-distillation can vary considerably. It can reach several hours depending on the material used and the plant material to be treated. It can influence not only the yield but also the composition of the extract. This operation was carried out for 3 hours by boiling a mixture of 100 g of plant material and 1400 ml of distilled water. The separation of essential oils is made in the Florentine vase by means of the difference in density with distilled water. The oils thus obtained are stored at 4 ° C in hermetically sealed tubes covered with aluminum foil. The yield of essential oil is expressed as a percentage relative to the dry matter (Pavida et al., 1976).

## Efficacy tests

Prior to testing the effectiveness of bioactive substances, *C. barbarus* larvae were placed in rearing cages. They should be fed with wheat seedlings supplemented with bran (Benzara et al., 2010). To perform the tests, the larvae were isolated in batches of 10 individuals in insect boxes. The experimental conditions in the laboratory are almost the same as those in the field (temperature, photoperiod and relative humidity). The treatments were carried out by direct spraying on insects in captivity or mixed with food. In the case of Harmal, four doses of active ingredient were used per liter of distilled water: 0.3, 0.6, 1.2 and 2.4 g / l. Two methods of treatment are used: contact and ingestion. Contact treatment involves spraying the product directly onto the larvae. The second method is based on the treatment of insect foods. Note to confirm the biological tests, two controls are used. One negative (distilled water) and the other positive, an insecticide (ACEPLAN 20). To do this, 16 boxes of insects in total are used, one box per dose. For the essential oil of mint, the following doses were prepared: 6, 12, 24 and 48 µl of active substance per ml of diluent (distilled water and acetone). The experimental device of this test is the same as that described above. For contact treatment, the results (counts of dead individuals) were read 1, 2 and 3 days after spraying the product. For treatment by ingestion, and in order to allow the product to act against insects, the reading was done 2, 4 and 6 days after the application of the product.

## Results and discussion

### Effect by contact of the EAq of grains of *P. harmala* and essential oils of *M. pulegium*

Figure 1 shows that the population treated with the EAq recorded progressive mortality according to dose and duration of treatment. The highest mortality rate (90%) was recorded on the 3rd day, with the highest dose (2.4 g / l). This is the same result obtained with the positive control (Aceplan). On the other hand, the lowest dose (0.3 g / l) had no effect on the larvae during the first day and caused only 30% mortality on the 3rd day of treatment. The other doses (0.6 and 1.2 g / l) had an average effect on the larvae of *C. barbarus* (between 40% and 60%). It should be noted that all these results are compared with the negative control (distilled water).

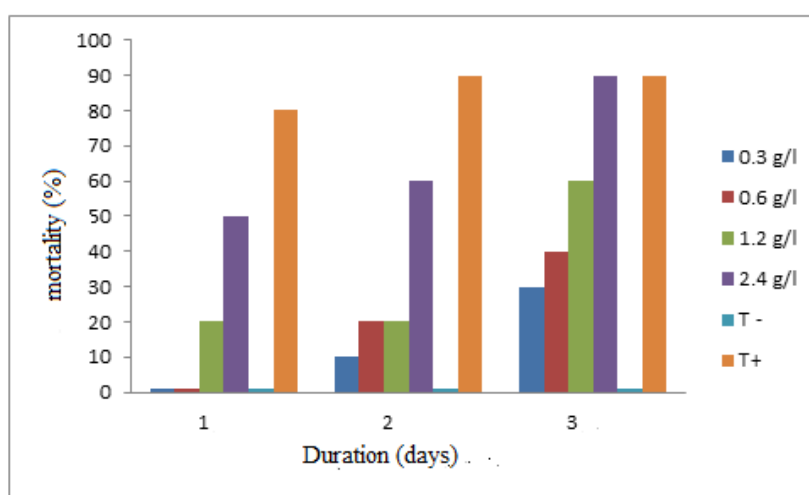


Figure1. Effect by contact of the EAq of the grains of *P. harmala* (T: negative control, T+: positive control)

The following regression equation can be obtained by adjusting the cumulative mortality percentages (mortality after three days of treatment) as a function of the doses:  $y = 28.406x +$



23.043 ( $r = 0.9942 = 99.42\%$ ). The correlation coefficient ( $r$ ) is equal to 99.42% (very strong correlation between dose and mortality). Thus, 99.42% of the mortality variation in the *C. barbarus* population is due to the EAq treatment effect of *P. harmala* grains by contact. Similarly, analysis of variance (ANOVA) revealed a significant difference between doses ( $P$  equal to 0.024, therefore less than 0.05). In consequence, the higher the dose and the higher the mortality. To calculate LD 50 (lethal dose to kill 50% of the population), doses are converted to log doses and cumulative mortality in Probit. The calculation of the LD 50 from the equation of the regression line  $y = 1.97x + 5.33$  shows that the dose of 0.67 g / l caused a mortality of 50%.

Compared to EAq, *M. pulegium* HEs resulted in a total mortality of 100% (more than the chemical insecticide), (Fig.2). This mortality is obtained from the first day of treatment but with a very high dose (48  $\mu\text{l/ml}$ ). The linear equation of dose-specific mortality rates is:  $y = 1.9275x + 9.1304$ . The correlation coefficient is 99.24 ( $r = 0.9924$ ). There is therefore a strong correlation between the different doses on one side and the mortality rates on the other side. For its part, the ANOVA test showed that there was a significant difference between the two ( $P = 0.041 < 0.05$ ). A dose of 12.58  $\mu\text{l/ml}$  is obtained with a mortality rate of 50%.

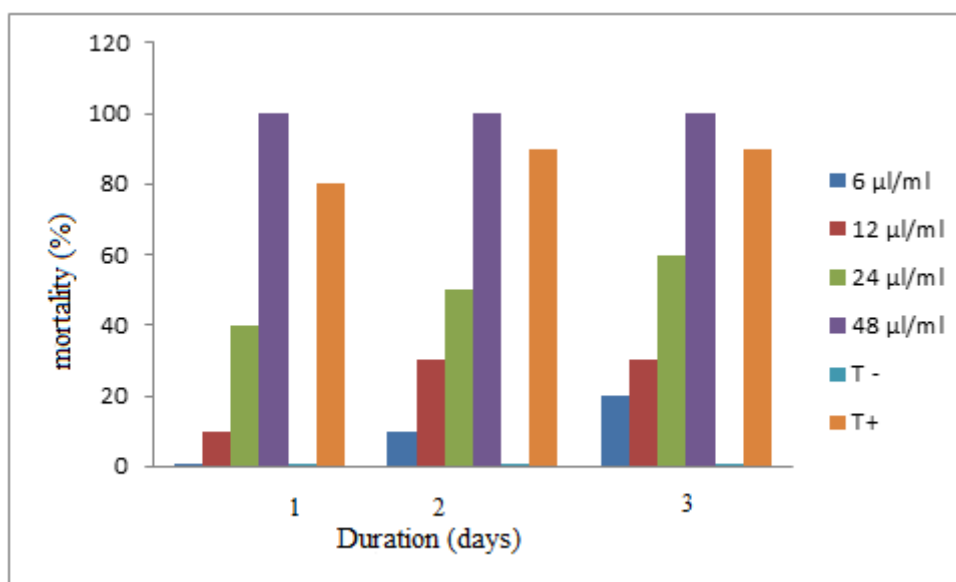


Figure2. Contact effect of *M. pulegium* essential oil

By studying the toxic effect of the EAq of the grains of *P. harmala* by contact on the L5 of the Locust locust: *Schistocerca gregaria*, Benzara et al. (2010) first obtained a low mortality rate, less than 26% at doses of 0.3 and 0.6 g / l. Then this rate increased to 50% with the doses 1,2 and 2,4 g / l. These extracts are therefore more effective on the L2 and L3 of *C. barbarus* than on the L5 of *S. gregaria*. This may be due to the difference in developmental stages, with L2 and L3 having a higher sensitivity than L5 which are more resistant. Idrissi Hassani et al. (2002) recorded a mortality rate of 55% in Desert Locust L4 for a dose of 3 ml / l. Against *S. gregaria*, the action of these extracts led to a decrease in food intake, a reduction in motility and perturbations in the reproductive function (Abbassi et al., 2005). This action also caused blockage of ovarian development in females (Idrissi Hassani et al., 1998). Furthermore, Benzara et al. (2013) by contacting the effect of the Harmal grains on the L5 of *Locusta migratoria*, obtained a low mortality rate estimated at 30% for doses 0.3 and 0.6 g / l. On the other hand, this mortality increased markedly with doses 1,2 and 2,4 g / l, for which this rate reached 60% and 80% respectively. These results are quite close to a few 10%. In the case of

Mint, according to Benayad (2008), essential oils of *M. pulegium* proved very effective against two Coleoptera species: *Sitophilus oryzae* and *Rhizopertha dominica*. Insect mortality was total, as early as 24 h after treatment, but at low doses (3 and 12 µl / ml). The two experiments seem to be similar, except that to reach this 100%, the concentration used for the present work is higher (48 µl / ml). In all cases, these studies show that the HEs of this plant have an excellent insecticidal power both on the Coleoptera and on the Orthoptera.

### Effect by ingestion of the EAQ of grains of *P. harmala* and HEs of *M. pulegium*

The results obtained for the ingestion efficacy tests are summarized in Figures 3. The EAQ of the grains of *P. harmala* did not start to act until the 4th day. The mortality rate then evolved according to the concentration gradient (from the lowest to the highest concentration). On day 6, the mortality rate reached the peak of 90% obtained with the dose of 2.4 g / l, as the positive control (Fig.3).

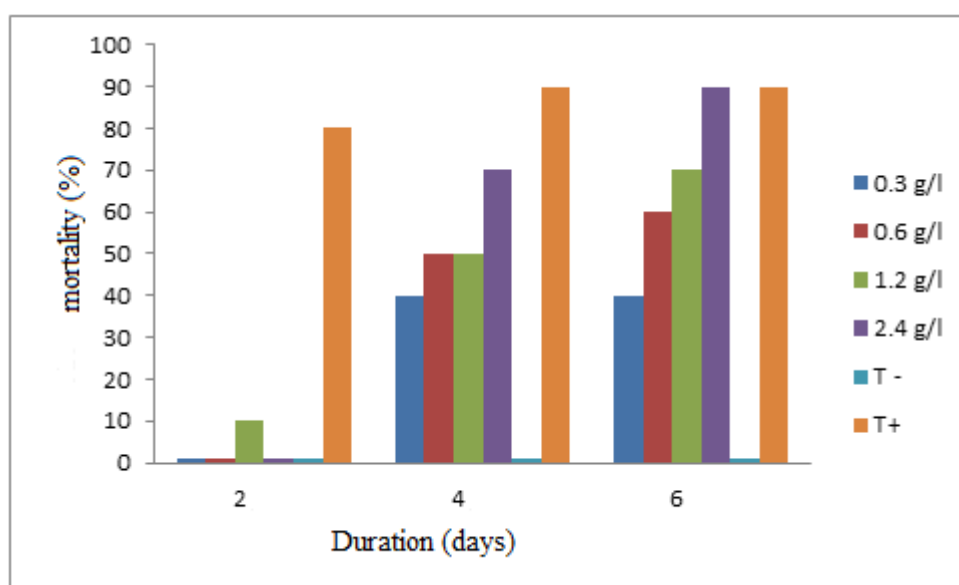


Figure3. Effect by ingestion of EAQ of grains of *P. harmala*

For statistical analyzes, the correlation coefficient is calculated from the linear regression line of mortality rates as a function of doses:  $y = 21.449x + 40.87$  with a correlation coefficient of 91.57% ( $r = 0.9157$ ). The latter shows that 91.54% of the variation in the effect of the extracts of the grains of *P. harmala* is due to the variation of the doses. In addition, the ANOVA test indicated that there is a very significant difference between doses and mortality rates ( $P = 0.007$ , therefore less than 0.01). Thus, the higher the dose, the greater the mortality. The linear regression line is calculated:  $y = 1.6169x + 5.5648$ . This yielded a LD 50 of 0.45 g / l.

Regarding the HEs, and whatever the doses used, the mode of action by ingestion of the latter gave no results on the 2nd day. It produced a rate between 10 and 20% on the 4th day of treatment. Then, mortality changed significantly on day 6, from 10% for the lowest dose to 80% for the highest dose (Fig. 4). For the *M. pulegium* HEs test, the equation of the linear regression line is:  $y = 1.4928x + 13.913$  with a correlation coefficient  $r = 0.8622$ . The latter showed a mean correlation between mortality and doses. Note that the ANOVA test revealed a probability  $P = 0.04 < 0.05$ . There is therefore a significant difference between the two (the higher the dose, the greater the mortality rate). In addition, the LD 50 is 24µl/ml.

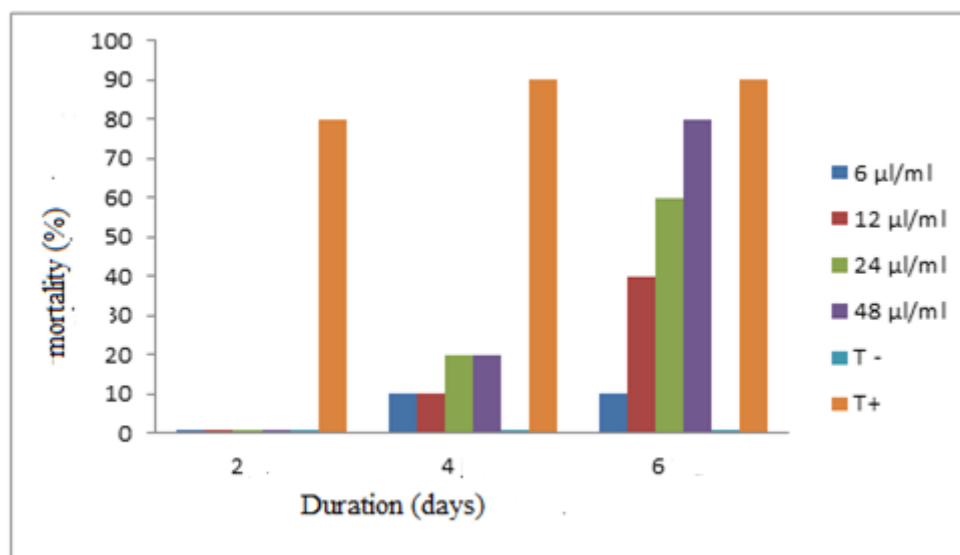


Figure 4. Ingestion Effect of HEs of *M. pulegium*

For the treatment of *P. harmala* by ingestion, Benzara et al. (2013) reported mortality rates of 30 and 40%. The latter are obtained by doses of 0.03 and 0.06 mg / ml. By increasing these concentrations to 0.12 and 0.24 mg / ml, the mortalities reached 70 and 90% respectively. For the present work, approximately similar results are obtained, but with doses 10 times greater (1.2 and 2.4 g / l). By testing the ingestion activity of EAq *P. harmala* during the flowering period on the L4 of the Desert Locust (*S. gregaria*), Abbassi et al. (2005) recorded a mortality rate of 75%. It should be noted from this information that the EAq of the "harmal" have proved, to varying proportions, their effectiveness against locusts. This efficacy is justified by a histological study in the middle intestine of *S. gregaria* (Idrissi Hassani and Hermas, 2008). In this study, it is shown that the Desert Locust has a reduction in external circular musculature. The latter led to a relaxation of the intestine and atrophy of the intestinal mucosa with reduced striated epithelium. The mesenteric epithelium in turn exhibits a granular appearance, an altered brush border, and typical signs of cellular necrosis (Idrissi Hassani and Hermas, 2008). These results may be explained in the work on extracts of *P. harmala*, which showed that alkaloids (alkane for the present case) are responsible for toxicity in insects. These alkaloids act through harmalol and harmol (Idrissi Hassani and El Hadek, 1999). But, they act mostly through harmine and harmaline. These are two substances present at all the phenological stages of the plant and more particularly at the maturation stage of the grains and roots. During this last stage, the rate varies from 2 to 7% compared to the foliage where only 0.5% is recorded (Tahri et al., 2004, Benzara et al., 2010).

#### Comparison between the two modes of action (by contact and ingestion)

After 3 days of contact treatment, a result (90%) similar to that recorded 6 days after ingestion treatment is obtained for the Harmal grains. This difference in mortality time is interpreted by the difference between the modes of penetration faster by contact than by ingestion. Concerning the HE of *M. pulegium*, the action by contact is also greater than that by ingestion.

Idrissi Hassani and Hermas (2008) believe that in *S. gregaria*, fed by ingestion through *P. harmala*, there was a direct effect on epithelial cells and thus an inhibition of absorption and assimilation. In addition, there was an indirect effect with absorption of the metabolites but without assimilation. On the other hand, for Benzara et al. (2013), the bio-pesticide effect

induced by the *P. harmala* grains is lesser compared to the ingestion treatment, despite the fragility of the cuticle of the larvae. Finally, it should be noted that the effectiveness effect by contact is stronger than by ingestion. This can be explained by the direct action of these oils on the cuticle of insects and other soft-body Arthropods (Chiasson and Beloin, 2007). It remains, however, to determine the mechanism by which these HEs degrade the external cuticle of certain insects and mites. The lipophilic nature of the essential oil can degrade the waxy layer and cause water losses (Chiasson and Beloin, 2007). As regards ingestion, most of the time, the action of bioactive substances in HEs is generally due to inhibition of growth regulators in the treated insect (Ketoh et al., 1998).

### Conclusion

In order to combat this potential pest of crops, bioactive substances have been extracted from different parts of the two well-known medicinal plants. These are the grains of *P. harmala* and the leaves of *M. pulegium*. These substances have been applied as bioacridicides by contact and by ingestion with juveniles of *C. barbarus*. The results recorded after the biological tests were carried out were very satisfactory. After treatment of the larvae, the best efficacy was obtained using *M. pulegium* HEs used by contact at the dose of 48 µl / ml (total mortality after 3 days of treatment). This has even exceeded that of the chemical insecticide (Aceplan), with which the mortality rate is 90%. It should be noted that for all bioactive substances, the highest mortality rates are recorded with the highest doses either by ingestion (6 days) or by contact (3 days). For example, the grain EAq caused 90% mortality with the dose 2.4 g / l, whereas with the dose 0.3 g / l, this rate is only 30 to 40%. The insecticidal effect by contact of the Harmal EAq grains is evaluated by a DL 50 of 0.67 g / l. Regarding the effect by ingestion, the LD50 recorded is 0.45. Whereas for the HEs of *M. pulegium*, it is to register a LD 50 of 12.58 µl / ml by contact and 23.98 µl / ml by ingestion. It should also be noted that these results are obtained with only the active ingredients without any adjuvant. It will be interesting to know what their effect will be by adding substances such as stabilizers, surfactants or other antioxidants and synergists.

### References

- Abbassi K., Mergaoui L., Atay-Kadiri Z., Gaout S. et Stambouli A., 2005. Activités biologiques des feuilles de *Peganum harmala* (Zygophyllacea) en floraison sur la mortalité et l'activité génésique chez le Criquet pèlerin. Faculté des Sciences, Université de Rabat, 16: 31-46.
- Benayad N., 2008. Les huiles essentielles extraites des plantes médicinales marocaines: moyen efficace de lutte contre les ravageurs des denrées alimentaires stockées. Rapport d'étude. Université Mohammed V-Agdal, 61p.
- Benzara A. 2004. Polymorphisme géographique de l'espèce *Calliptamus barbarus* (Costa, 1836) (Orthoptera: Acrididae) en Algérie. Thèse Doctorat. Ins Nat. Agro., El Harrach, Alger, 154p.
- Benzara A., Khalfi-Habes O. et Lazib Z., 2010. Efficacité des extraits aqueux de *Peganum harmala* (Zygophyllacée) sur les larves L5 du Criquet pèlerin, *Schistocerca gregaria* (Forsskål, 1775) (Orthoptera, Acrididae). Proceedings du 7ème Congrès de l'Association Marocaine de Protection des Plantes, Rabat. Pp: 469 -474.
- Benzara A., Ben Abdelkrim A. and Khalfi-Habes O., 2013. Effect of extracts of seeds of aqueous *Peganum harmala* L. (zygophyllaceae) on 5th stage larvae *Locusta migratoria cinerascens*(Fabricius, 1781) (Orthoptera: Oedipodinae), Journal of life science, 7(2):154-163.

- Chiasson H. et Beloin N., 2007. Les huiles essentielles, des biopesticides « nouveau genre ». Bulletin de la Société d'entomologie du Québec. Vol. 14, no 1:3-6.
- Clemente M.E., Garcia M.D and Presa J.J. , 1987. Morphometric and pigmentary variation in *Calliptamus barbarus* (Costa, 1836) in relationship with environment, and its taxonomic value, in *Evolutionary Biology of Orthoptera* insects. Ed. Boccetti, Ellis Horwood Ltd, Chichester, 184-189.
- El Haib A., 2011. Valorisation de terpenes naturels issus de plantes marocaines par transformations atalytiques. Thèse Doct. Université de Toulouse, 181 p.
- Idrissi Hassani L.M. et El Hadek M. 1999. Analyse de la composition de l'huile de *Peganum harmala* L. (Zygophyllacées). *Acta botanica Gallica: bulletin de la Société botanique de France* 146(4): 353-359 .
- Idrissi Hassani L.M. et Herms J., 2008. Effets de l'alimentation en *Peganum harmala* L. (Zygophyllaceae) sur le tube digestif du Criquet pèlerin *Schistocerca gregaria* Forsk. (Orthoptera, Acrididae). Université Ibn Zohr, Agadir, 19: 71-84.
- Idrissi Hassani L.M., Ould Ahmedou M.A., Chihrane J., et Bouaichi A., 1998. Effets d'une alimentation en *Peganum harmala* (Zygophyllaceae) sur la survie et le développement ovarien du criquet pèlerin *Schistocerca gregaria* Forskål (Orthoptera, Acrididae), *Ethnopharmacologia*, 23: 26-41.
- Idrissi Hassani L.M., Ould Ahmedou M.L., Mayad E.H. et Bouaichi A., 2002. Pouvoir insecticide de *Peganum harmala* sur *Schistocerca gregaria*: effets de l'huile et des extraits de feuilles. *Biologie & santé*, 2(2): 122-133.
- Karousou R., Balta M., Hanlidou E. and Kokkini S. 2007. "Mints", smells and traditional uses in Thessaloniki (Greece) and other Mediterranean countries. *J Ethnopharmacol*, 109 (2):248–57. doi:10.1016/j.jep.2006.07.022 PMID:16962274
- Ketoh K., Glitho A., Nuto Y. et Koumaglo K., 1998. Effets de six huiles essentielles sur les œufs et les larves de *Callosobruchus maculatus* F. (Coleoptera : Bruchidae). *Revue cames*. Volume n° 00 : 16-20.
- Larrosa E., Ggarcia M.D., Clemente M.E. y Presa J.J., 2004. El comportamiento en cautividad de *Calliptamus barbarus* (Orthoptera:Acrididae). *Memorie della Societa entomologica italiana*, 82 (2): 615-630.
- Maruthu-Pandian A. and Mohan V.R., 2011. GC-MS Analysis of some bioactive constituents of *Pterocarpus marsupium* Roxb. *International journal of ChemTech research*, 35(3): 1652-1657.
- Mbiantcha M., Kamanyi A., Teponno R.B., Tapondjou A.L., Watcho P. and Nguenefack T.B., 2011. Analgesic and Anti-Inflammatory Properties of Extracts from the Bulbils of *Dioscorea bulbifera* L. var *sativa* (Dioscoreaceae) in Mice and Rats. *Evidence-Based Complementary and Alternative Medicine*. Vol. 2011, Article ID 912935, 9 pages. Available on <http://dx.doi.org/10.1155/2011/912935>.
- Pavida D.L., Lampman G.M. and Kriz G.S, 1976. Introduction to organic laboratory techniques. Ed. W.B. Saunders Co. Philadelphia, 567 p.
- Regnault-Roger C., Vincent C. et Philogene B J. R., 2002. Produits phytosanitaires, insecticides d'origine végétale : promesses d'hier et d'aujourd'hui. In: *Biopesticides d'origine végétale*. TEC et DOC. Ed. Lavoisier, Paris. 1013 p.
- Rouibah M., López-López A., Presa J. and Doumandji S., 2016. A molecular phylogenetic and phylogeographic study of two forms of *Calliptamus barbarus*. (Costa 1836) (Orthoptera: Acrididae, Calliptaminae) from two regions of Algeria *Annales de la Société entomologique de France*: 52(2)77-87.
- Tahri N., Rhalem N. et Soulaymani R., 2004 ; L'intoxication au Harmal, *Peganum harmala*. *Esperance Med*, 10: 5.

## POPULATIONS OF APHIDS ON TWO MANDARIN VARIETIES AND THEIR CORRELATION WITH SOME LEAF CHARACTERISTICS

Salim LEBBAL<sup>1,2\*</sup>

<sup>1</sup>Department of Agronomy, Faculty of Natural and Life Sciences, University Abbas Laghrour, Khenchela, Algeria

<sup>2</sup>Department of Agronomy, University Batna 1, Algeria

\*Corresponding author: salim-leb@hotmail.com

### Abstract

Mandarin is an important fruit crop in the world. It confronts many diseases and pests such as aphids. The use of resistant cultivars is an alternative control method that may limit the negative impact of pesticides. In the present study, the level of aphid populations on two mandarin varieties (Carvalhal and Ortanique) were investigated in an orchard situated in the region of Skikda (northeast Algeria), from January to June 2014, by sampling 16 leaves/variety monthly. Furthermore, the relation between the infestation degree and some leaf morphological and chemical characteristics are evaluated. We identified one aphid species on Carvalhal (*Aphis spiraecola*) and two species on Ortanique (*A. spiraecola* and *A. gossypii*). Concerning the fluctuations of aphid populations, ANOVA did not show a significant difference of infestation levels between the two varieties although we noticed that Ortanique was the most infested reaching its peak in April. In addition, during this month, Ortanique presented higher amount of total flavonoids and lower quantity of total phenols than Carvalhal. On the other hand, the comparison between the two examined cultivars revealed some differences in the leaf morphological characteristics such as its width and the intensity of its green color. These differences in leaf chemical and morphological traits of mandarin varieties might explain the variations in the infestation degree between them.

**Keywords:** *Aphids, Citrus, Ortanique, Carvalhal, phenols, flavonoids*

### Introduction

Citrus is the most economically important fruit crop in the world (Tadeo *et al.*, 2008). They contain vitamin C and numerous other vitamins and minerals. Because of their nutritional and organoleptic qualities, citrus fruits contribute to nutritional balance for both Northern and Southern populations (Lacirignola and D'Onghia, 2009). Mandarins are among the species belonging to this group. They are soft-skinned and easy to peel varieties compared to other citrus types (Skaria, 2004). The production of mandarins, tangerines, clementines and satsumas in the world was more than 30 million tonnes in 2014 (FAOstat, 2017).

Numerous biotic and abiotic factors limit mandarin production, of which the aphids constitute real dangerous pests to this culture. There are more than 4000 species of aphids in the world. They are important pest insects in the agriculture of temperate regions (Hong and Boo, 1998). They affect plant growth and crop production either directly, such as leaf and/or fruit deformation, or indirectly through the development of sooty moulds on honeydew excretion and phytovirus transmission (Bonnemain, 2010).

The main method used to control these pests was chemical pesticides that are effective, but some of them showed negative effects. Sullivan (2008) mentioned that evidence from field studies demonstrated that pesticide residues persisted in the ecosystem, and accumulated in the food chain causing unexpected dangers to non-target organisms. To confront these

undesirable effects, the selection of resistant cultivars represents one of the most interesting alternative methods to control plant enemies. Adoption of insect-resistant cultivars has been considered as the most economic and eco-friendly strategy for pest management (Bhatia *et al.*, 2011). Knowledge about the population of a pest on different host plants gives us an idea about the resistance or susceptibility of hosts (Özgökçe and Atlihan, 2005). In the present research, we studied the level of aphid populations on two mandarin varieties in the field, as well as their relation with some leaf morphological and chemical characteristics.

## Materials and Methods

### Aphid infestation on Ortanique and Carvalhal mandarin varieties

The study was conducted in the Skikda citrus region located 500 km east of the capital Algiers. The studied orchard (36° 42' N, 6° 47' E, 200 m altitude) is situated at the level of the Technical Institute of Fruit Arboriculture of Emjez Edchich extends over 10 ha of area. Two mandarin varieties were considered in this paper, Ortanique and Carvalhal. From January to June 2014, sampling was conducted at approximately monthly intervals. Four leaves were collected from different orientations of the tree canopy at each of the four randomly selected trees per variety, for a total of 16 leaves per variety per sampling date. All aphids installed on each sampled leaf are counted. Afterwards, these pests were conserved in ethanol and then identified in the laboratory basing on two identification keys (Stoetzel, 1994; Blackman and Eastop, 2000).

### Total phenols and total flavonoids

Leaf analysis for phenols and flavonoids was carried out using leaves collected in April 2014, that correspond to the highest level of infestation by aphids on the two varieties. Total phenols are measured spectrophotometrically by the Folin-Ciocalteu method (Makkar *et al.*, 2007), while total flavonoids were quantified using aluminum chloride method (Zhishen *et al.*, 1999).

### Leaf morphological characteristics

Several authors have reported that some leaf characters have a role in plant resistance to aphids (Stipanovic, 1983; Gregory *et al.*, 1986). In our case, on each variety of mandarin, 5 morphological characters relative to the leaves were studied. The green color, the emargination, the length of the petiole, the length and width the leaves were measured. The young leaves used for this assessment were collected from 4 trees representing each variety. They were located at man's height and at the outer surface of the canopy.

### Statistical analysis

Means of infestation degrees, quantity of phenols and flavonoids is compared by ANOVA followed by Student-Newman-Keuls test. These statistical procedures were carried out using the software SPSS (10<sup>th</sup> version), while the graphs were created using MS Excel 2007.

## Results and Discussion

### Aphid infestation on Ortanique and Carvalhal mandarin varieties

On Carvalhal variety only one species (*Aphis spiraecola* Patch) was identified, whereas this species and *A. gossypii*(Glover) are identified on Ortanique variety. In other regions, different aphid species are identified. For instance in Turkey, Yoldaş *et al.* (2011) found five species of aphids in satsuma mandarin orchards and the most common species observed were *A. gossypii*

and *A. spiraecola*. While, *Toxoptera aurantii*, *A. craccivora* and *A. gossypii* found infesting mandarin in Greece (Kavallieratos *et al.*, 2007).

Concerning the fluctuations of aphid populations, ANOVA did not show a significant difference of infestation levels between the two varieties although we remarked that Ortanique variety was the most infested reaching its peak in April (Figure 1). Smith (2005) mentioned that individuals surviving the direct effects of antibiosis may suffer the debilitating effects of reduced fecundity.

It is noticed also that the level of infestation was higher in the spring than those in winter for the examined varieties (Figure 1). The peak of infestation in April was followed by a decrease in the number of aphids. The spring season is characterized generally by the production of new shoots and a pertinent temperature to the development of aphids. Kindlmann and Dixon (2010) indicated that an initial dramatic increase in population size in spring is typically followed by a steep decline in abundance during summer. Furthermore, Wang and Tsai (2000) highlighted the influence of temperature on biological parameters of *A. spiraecola*.

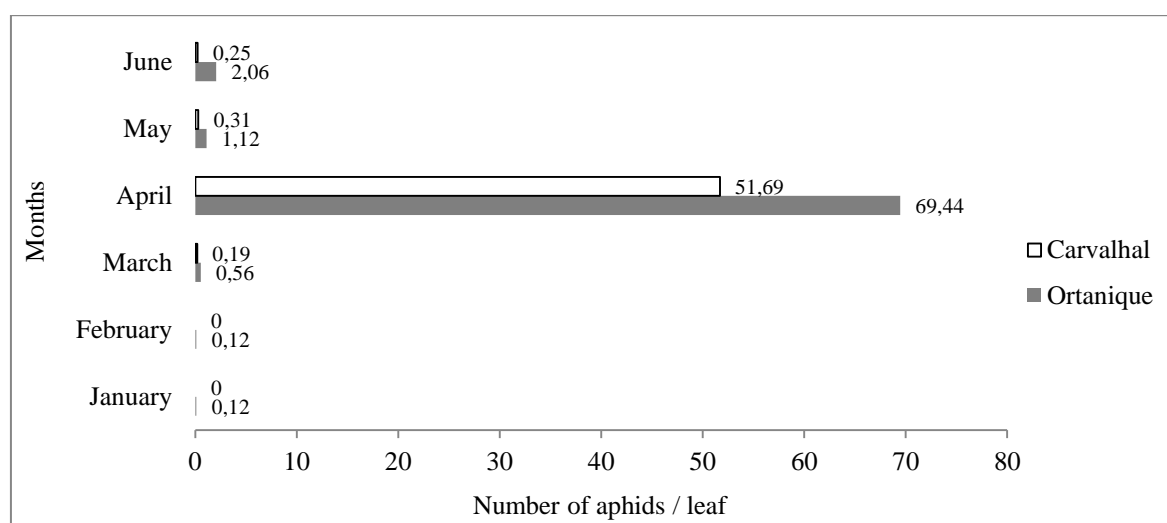


Figure 1. Mean number of aphids/leaf on two mandarin varieties.

#### Total phenols and total flavonoids

ANOVA showed significant difference of total phenols ( $P < 0.05$ ), and no significant difference of total flavonoids between Ortanique and Carvalhal varieties.

Ortanique variety presented higher infestation level and lower quantity of total phenols, than Carvalhal variety (Table 1). Plant phenolics are involved in the defense mechanisms of plants against insect herbivores (Lattanzio *et al.*, 2006). Polyphenols produced in relatively large quantities are among the most effective repellents against herbivores (Mooney *et al.*, 1983). Several studies found that plants containing higher phenolic levels had some resistance against different aphid species (Eleftherianos *et al.*, 2006; Kamel and El-Gengaihi, 2009; Wójcicka, 2010). Moreover, Chrzanowski *et al.* (2009) demonstrated that plant phenolic compounds act by reducing the enzymatic activity of aphids. In addition, tannins, which are a group of polyphenols, have the ability to precipitate proteins (Peng, 1991). Nevertheless, Bastide *et al.* (1988) mentioned that some phenolic compounds or their derivatives in the peach resistant hybrid to *Myzus persicae*, seem to be more important than the higher overall level of phenolics in the susceptible hybrid.



Table 1. Infestation level and total phenols and flavonoids of leaves collected in April 2014.

Mandarin variety	Number of aphids/leaf	Phenols (Mg/g)	Flavonoids (µg/g)
Ortanique	69,44 a	4,60 a	65,53 a
Carvalhal	51,69 a	5,95 b	63,63 a

\* Values indicated with different letters are significantly different at  $P < 0,05$

On the other side, we found that Carvalhal variety presented lower infestation level and lower quantity of total flavonoids, than Ortanique variety (Table 1). Similarly, the results of Goławska *et al.* (2008 and 2012) suggested that lower level of flavonoids of an alfalfa (*Medicago sativa*) cultivar was less attacked by the pea aphid (*Acyrtosiphon pisum*). Furthermore, Kamel and El-Gengaihi (2009) reported a positive correlation between the population density of *A. gossypii* and the content of the cucumber in flavonoids. The role of flavonoids in plant resistance may be the result of some of its types and not by the total amount. Flavonoids are known to have important physiological functions in plants by protecting them from biotic stresses (Goławska *et al.*, 2010). Lattanzio *et al.* (2000) demonstrated a direct involvement of quercetin or isorhamnetin in the resistance mechanism of *Vigna* species to aphids.

#### Leaf morphological characteristics

The results of the morphological characters of the leaves revealed differences in the intensity of the green color, emargination, leaf and petiole dimensions (Table 2). The leaves of the Ortanique variety, which seems to be the most susceptible to attacks by aphids, have been distinguished by long petioles and broad leaves, compared to the Carvalhal. Apparently, the large area of the leaves of the Ortanique allowed the aphids to develop denser colonies. Similarly, Whitham (1978) observed in his study a positive correlation between leaf size of *Populus angustifolia* and the biotic potential of the aphid *Pemphigus betae*.

Table 2. Description of the mandarin leaves.

Morphological characters / Variety	Carvalhal	Ortanique
Length of leaves(cm)	6	5,76
Width of leaves (cm)	2,87	3,04
Length of petioles(cm)	0,7	1,2
Green color	dark	light
Emargination	present	absent

In addition, the variety Ortanique, presented leaves of light green color. It seems that this color is the most attractive to citrus aphids compared to the dark color that characterized Carvalhal. According to Sadasivam and Thayumanavan (2003), most aphids express a particular preference for leaves that reflect colors in the range of 500 to 600 nm (yellow-green).

#### Conclusion

Our study showed that Carvalhal variety was slightly more resistant than Ortanique. This may contribute in reducing pesticide sprayings and thus producing healthy mandarins with low cost. On the other hand, although it is remarked that the increased number of aphids was associated with high amount of flavonoids and low amount of phenols, further studies should be conducted to better understanding the relation between mandarin varieties composition in primary and secondary metabolites, and their susceptibility to aphids.

## Acknowledgments

I would like to thank Aicha HALIS, Adel LEKBIR and the workers of the Technical Institute of Fruit Arboriculture of Emjez Edchich (Skikda) for their help.

## References

- Bastide P., Massonie G., Macheix J.-J. (1988). Influence in vitro des composés phénoliques des jeunes feuilles du pêcher, *Prunus persica* (L.) Batsch, sur le puceron vert du pêcher, *Myzus persicae* Sulzer (Influence in vitro of phenolic compounds in young peach leaf, *Prunus persica* (L.) Batsch, on green peach aphid, *Myzus persicae* Sulzer), *Agronomie*, 8 (9), pp. 787-792.
- Bhatia V., Uniyal P.L., Bhattacharya R. (2011). Aphid resistance in Brassica crops: Challenges, biotechnological progress and emerging possibilities, *Biotechnology Advances*, vol. 29, pp. 879-888.
- Blackman R.L., Eastop V.F. (2000). *Aphids on the world's crops: An identification and information guide*, John Wiley and Sons, UK.
- Bonnemain J.-L. (2010). Aphids as biological models and agricultural pests, *Comptes Rendus Biologies*, vol. 333, pp. 461-463.
- Chrzanowski G., Leszczyński B., Sempruch C., Sytykiewicz H., Sprawka I. (2009). Effect of phenolics from woody plants on activity of grain aphid oxidases, *Pestycydy/Pesticides*, vol. 20, pp. 63-70.
- Eleftherianos I., Vamvatsikos P., Ward D., Gravanis F. (2006). Changes in the levels of plant total phenols and free amino acids induced by two cereal aphids and effects on aphid fecundity, *Journal of Applied Entomology*, 130 (1), pp. 15-19.
- FAOstat(2017). <http://www.fao.org/faostat/en/#data/QC>. Accessed on 30/06/2017.
- Gregory P., Tingey W.M., Ave D.A., Bouthyette P.Y. (1986). Potato glandular trichomes: A physicochemical defense mechanism against insects. In: Green M.B., Hedin P.A. (eds.), *Natural Resistance of Plants to Pests: Roles of Allelochemicals*, American Chemical Society, USA, pp. 160-167.
- Goławska S., Łukasik I., Goławski A., Kapusta I., Janda B. (2010). Alfalfa (*Medicago sativa* L.) apigenin glycosides and their effect on the pea aphid (*Acyrtosiphon pisum*), *Polish Journal of Environmental Studies*, vol. 19, pp. 913-919.
- Goławska S., Łukasik I., Kapusta I., Janda B. (2012). Do the contents of luteolin, tricetin, and chrysoeriol glycosides in alfalfa (*Medicago sativa* L.) affect the behavior of pea aphid (*Acyrtosiphon pisum*)? *Polish Journal of Environmental Studies*, vol.21, pp. 1613-1619.
- Goławska S., Łukasik I., Leszczyński B. (2008). Effect of alfalfa saponins and flavonoids on pea aphid, *Entomologia Experimentalis et Applicata*, vol.128, pp. 147-153.
- Hong J., Boo K.S. (1998). Artificial production of sexual morphs in *Aphis spiraeicola*, *Journal of Asia-Pacific Entomology*, 1 (2), pp. 171-176.
- Kamel A.M., El-Gengaihi S.E. (2009). Is there a relationship between the level of plant metabolites in cucumber and globe cucumber and the degree of insect infestation? *Notulae Botanicae Horti Agrobotanici Cluj*, 37(1), pp. 144-156.
- Kavallieratos N.G., Tomanović Ž., Sarlis G.P., Vayias B.J., Žikić V., Emmanouel N.E. (2007). Aphids (Hemiptera: Aphidoidea) on cultivated and self-sown plants in Greece, *Biologia Bratislava*, 62 (3), pp. 335-344.
- Kindlmann P., Dixon A.F.G. (2010). Modelling population dynamics of aphids and their natural enemies. In: Kindlmann P., Dixon A.F.G., Michaud J.P., (eds.), *Aphid Biodiversity under Environmental Change*, Springer, Dordrecht, pp. 1-20.

- Lacirignola C., D'Onghia A.M. (2009). The Mediterranean citriculture: Productions and perspectives, *Options Méditerranéennes*, vol. B 65, pp. 13-17.
- Lattanzio V., Lattanzio V. M. T., Cardinali A. (2006). Role of phenolics in the resistance mechanisms of plants against fungal pathogens and insects, *Phytochemistry: Advances in Research*, pp. 23-67.
- Lattanzio V., Arpaia S., Cardinali A., Di Venere D., Linsalata V. (2000). Role of endogenous flavonoids in resistance mechanism of Vigna to aphids, *Journal of Agriculture and Food Chemistry*, 48 (11), pp. 5316-5320.
- Makkar H.P.S., Siddhuraju P., Becker K. (2007). *Plant secondary metabolites*, Humana Press, New Jersey.
- Mooney H.A., Gulmon S.L., Johnson N.D. (1983). Physiological constraints on plantchemical defenses. In: Hedin P.A. (ed.), *Plant Resistance to Insects*, American Chemical Society, USA, pp. 21-36.
- Özgökçe M.S., Atlihan R. (2005). Biological features and life table parameters of the mealy plum aphid *Hyalopterus pruni* on different apricot cultivars, *Phytoparasitica*, 33 (1), pp. 7-14.
- Peng Z. (1991). Feeding determinant in aphids with special reference to the rose aphid *Macrosiphum rosae* (L.), PhD thesis, University of Adelaide.
- Sadasivam S., Thayumanavan B.(2003). *Molecular host plant resistance to pests*, Marcel Dekker, USA.
- Skaria M. (2004). People, arthropods, weather and citrus diseases. In: Naqvi S.A.M.H. (ed.), *Diseases of Fruits and Vegetables, Volume I*, Kluwer Academic Publishers, the Netherlands.
- Smith C.M. (2005). *Plant resistance to arthropods*, Springer.
- Stipanovic R.D. (1983). Function and chemistry of plant trichomes and glands in insect resistance: Protective chemicals in plant epidermal glands and appendages. In: Hedin P.A. (ed.), *Plant Resistance to Insects*, American Chemical Society, USA, pp. 69-100.
- Stoetzel M.B. (1994). Aphids (Homoptera: Aphididae) of potential importance on Citrus in the United States with illustrated keys to species, *Proceedings of the Entomological Society of Washington*, 96 (1), pp. 74-90.
- Sullivan D.J. (2008). Aphids (Hemiptera: Aphididae). In: Capinera J.L. (ed.), *Encyclopedia of Entomology*, Springer, Dordrecht, pp. 191-215.
- Tadeo F.R., Cercós M., Colmenero-Flores J.M., Iglesias D.J., Naranjo M.A., Ríos G., Carrera E., Ruiz-Rivero O., Lliso I., Morillon R., Ollitrault P., Talon M. (2008). Molecular physiology of development and quality of citrus, *Advances in Botanical Research*, vol. 47, pp. 147-223.
- Wang J.-J., Tsai J.H. (2000). Effect of temperature on the biology of *Aphis spiraeicola* (Homoptera: Aphididae). *Annals of Entomological Society of America*, 93 (4), pp. 874-883.
- Whitham T.G. (1978). Habitat selection by Pemphigus aphids in response to response limitation and competition, *Ecology*, 59 (6), pp. 1164-1176.
- Wójcicka A. (2010). Cereal phenolic compounds as biopesticides of cereal aphids, *Polish Journal of Environmental Studies*, 19 (6), pp. 1337-1343.
- Yoldaş Z., Güncan A., Koçlut T. (2011). Seasonal occurrence of aphids and their natural enemies in Satsuma mandarin orchards in Izmir, Turkey, *Türkiye Entomoloji Dergisi*, 35 (1), pp. 59-74.
- Zhishen J., Mengcheng T., Jianming W. (1999). The determination of flavonoid contents in mulberry and their scavenging effects on superoxide radicals, *Food chemistry*, 64 (4), pp. 555-559.

## FAUNAL BIODIVERSITY ASSOCIATED TO THE TOMATO CULTURE (*LYCOPERSICON ESCULENTUM* MILL, TAVERA VARIETY) IN METIJDA

Nadia YAHIA<sup>1\*</sup>, Faiza MARNICHE<sup>2</sup>, Manel BELLACHE<sup>1</sup>, Wassila BENSLIMANE<sup>3</sup>,  
Samia MOUHEB<sup>4</sup>

<sup>1</sup> Biothecnology department, Faculty of Nature and Life Sciences, Saad Dahleb Blida1 University, Blida, Algeria

<sup>2</sup> National Veterinary High School, EL-Harnach, Algiers, Algeria

<sup>1,3</sup> Department of population, Faculty of Nature and Life Sciences, Saad Dahleb Blida 1 University, Blida, Algeria

<sup>4</sup> Research Laboratory of Biotechnology, Environnement and Health, Faculty of Nature and Life Sciences, Saad Dahleb Blida1 University, Blida, Algeria

\* Corresponding author: ydida21@yahoo.fr

### Abstract

Tomato occupies a strategic place in the national and global economy. The objective of this study was to find out the entomofauneqtique procession associated to the culture of Tavera variety of tomato (*Lycopersicon esculentum* Mill). This study was conducted in a multispan greenhouse using the colorful pots traps sampling technique. A total of 45 colored pots are placed alternately: 9 traps at the ends of the culture and 5 between rows of tomatoes.

The total number of species recorded shows the presence of 1736 individuals belonging to 146 insect species, distributed in 12 orders. The most abundant order was the Diptera with 44 species (34%) and with a predominance in red traps. In addition to Insects, 8% of the total number of individuals captured belongs to the Aranea, Acari and Collembola orders. Depending on the color of the traps, the overall rate of captured species was highest in yellow pots (41%), followed by reds (32%) and lastly the green pots (27%). The distribution of the different trophic categories revealed the existence of 5 large groups with the predominance of phytophagous species (34%).

The values of (S) are between 48 species and 97 ( $48 \leq S \leq 97$ ). The lowest total wealth was recorded in April with only 48 species, although the number of individuals captured was higher than in March (N = 537). The values of the Shannon-Weaver diversity index of species counted in colored traps, were from 4.20 to 4.89 bits. For the values of fairness, they varied according to the month from 0.47 to 0.81. The graph of factorial correspondence analysis highlights the presence of each season in a separate quadrant.

**Keywords:** *Lycopersicon esculentum* Mill., *Tavira*, colorful pots traps, Diptera, parasites

### Introduction

The tomato (*Lycopersicum esclentum* Mill., *Solanaceae*) is one of the 40 most important vegetable species in the world, and ranks second after potatoes, as well as in production and consumption (Trichpoulou and Lagio, 1997). Despite an extension of the vegetable areas, the yields remain moderate. However, greenhouse cultivation offers great possibilities for improving vegetable yields. In Algeria, work on the entomofauna of the tomato under greenhouse is rare. Among them, at most, it is possible to cite those of Chennouf (2011), who studied the faunal diversity associated with tomatoes in the Ouargla region, and it is to try to complete this work that we decided to study the faunistic diversity of the tomato in a multispan greenhouse using the technique of colored traps. In fact, the study of the entomofauna

of the tomato in greenhouse offers a great ecological importance. The aim of this work is to make a contribution on the knowledge of the faunistic species associated with the cultivation of the tomato under multispan greenhouse.

### **Material and Methods**

The faunistic inventory is carried out in the National Specialized Institute for Professional Training in Bougara (L'I.N.S.F.P), located at 25 km from the capital of the Blida district (La wilaya de Blida), at an altitude of 114 m and coordinates 36 ° 32 'N, 3 ° 05' E in a hemicylindrical multispan, with a north-facing. The choice of this site is motivated by the appropriate experimental conditions (controlled temperature, aeration, irrigation). The climate of this region is typically Mediterranean, characterized by a mild, rainy winter, and a warm, dry summer.

The preparation of the soil and the cultivation of the tomato (Tavira variety) involve several operations: plowing, disking, sowing, planting, pitching, pruning, leaf removing and weeding. In order to control the temperature, considered as an important factor for the growth and development of the culture, the greenhouse is equipped with a digital thermometer, as well as two large ventilation systems.

The daily temperature of the greenhouse is measured 3 times per day (9 am, 1 pm, 4 pm). The sampling method used is the technique of colored traps; 45 colored plastic containers of which 15 yellows, 15 greens and 16 reds were placed alternately early in the morning. 09 traps placed at the ends of the culture, and 5 traps in the middle of the rows. The traps were filled two-thirds of their height with soapy water and a few drops of white vinegar (Fig1). Collection is carried out every 48 hours, the contents of the traps were poured into a filter and the insects were collected with a fine brush and stored in 70% alcohol, into marked test-tubes (date and color of trap) until their identification. The sampling is carried out once every 15 days during the period of our study.

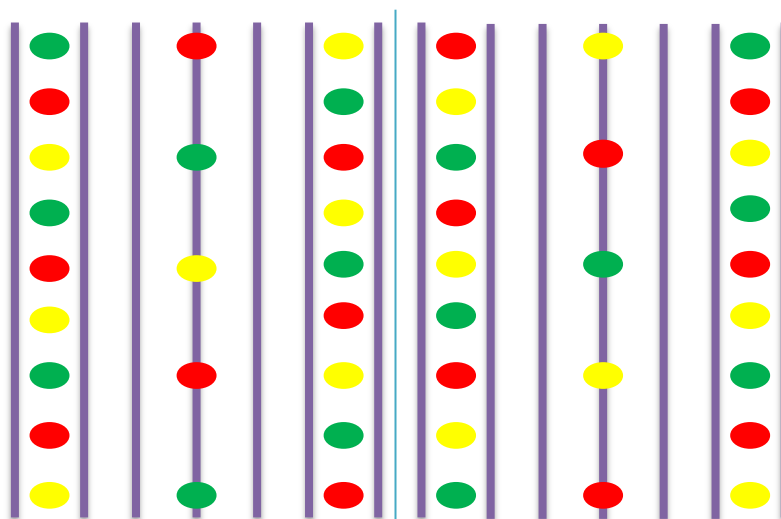


Figure.1. Trapping device

### **Results and Discussion**

The study of the entomofauna using colored traps allowed to inventory 1.736 invertebrates distributed among 3 classes, those of Arachnida, Collembola and Insecta. Our results corroborate those of Belatra (2010) which in a potato field in Maalba and Moudjbra stations,

captured in yellow traps 140 invertebrate species distributed among 71 families, 13 order and 3 classes. Within these classes, the Insecta dominates both in number of individuals and in number of species. Indeed, in term of richness, Insecta are rated with 128 species (92%) and it is the same in term of numbers with  $N=1.598$  (97.1%). The month of May contributes with a total of 97 species, and a greater number of individuals, or 891 individuals. In March the total richness ( $S$ ) is 67 species represented by 307 individuals. The lowest total richness is recorded in April with only 48 species, but with a higher number of individuals than in March ( $N = 537$ ). The average richness ( $S_m$ ) varies between 24 and 49 species.

The present results confirm those of several authors who used the same sampling technique Belatra (2010) in a potato field using the same sampling technique reported 121 species in Maalba, and 91 species in Moudjbara. Like Remini (2007), in a wasteland of the Zoological Park in Ben Aknoun, reported 117 species. Moreover, in other types of environment, from an author to another the number of species is variable, in fact N'doye (1975) in Bondy in France, mentioned in its study on the altitudinal distribution of an entomological fauna above a meadow, 35 species divided between two classes. Whereas, Moussa (2005) in the plots of greenhouse culture in Staoueli records 87 species. Among the class of Insecta, the Diptera are best represented with 44 species with a rate of 34%. For relative abundances (RA %) of invertebrate species trapped in colored traps, the highest frequency was 39.80% recorded for *Myzus sp.* (Homoptera, Aphididae). Apart from Insects, the invertebrates sampled belong to the Arachnida and Collembola classes and together account for 8% of all the caught species (Fig2).

The present results confirm those of several authors who used the same sampling technique. In fact, in the highlands southwest of Madagascar, Hautier et al., (2003) noted the abundance of the Diptera with 24.80%, followed by Hymenoptera. And even Boussad and Doumandji (2004) at Oued Smar have noted the predominance of the Diptera order with 33 species, followed by Hymenoptera with 23 species. Hamiche (2005) reports that Diptera are dominant with a rate of 27.4%, followed by Coleoptera with 25 species (23.6%) and lastly Hymenoptera with a rate of 20.8%. But Belatra (2010) in a field of potato mentioned the presence of Diptera with a rate of 15.5% lower than what found in the present study. Similarly Berchiche (2004) reported the presence of Diptera with a percentage of 24.80% followed, Homoptera and Orthoptera with dominance of the order Hymenoptera (33.33%).

The diversity values of Shannon-Weaver applied to the species captured using the color traps technique, range from 4.20 to 4.89 bits indicating that diversity was important in the months of May and March. The calculated value of  $H'$  exceeds that mentioned by Moussa (2005), in Staoueli which records a value of 3.48 bits. In a bean culture, Boussad (2003), noted a value ranging from 3.43 to 4.77 bits depending on the stations considered, while in the farm of Alia, Boussad (2006) noted a higher value of 6.22 bits on the same cultures. For Belatra (2010) the value found was 5 bits in the station of Maalba and of 5.07 bits in Moudjbara in different pear orchards. In the wasteland of the Zoological Park in Ben Aknoun, Remini (2007), reports a value of 5.33 bits. Similarly, Alili (2008) reports values of 5.09 bits in Birtouta station, 5.34 bits in Eucalyptus, and 4.89 bits in Réghaia.

In the present work, the fairness values found are 0.81 for the month of March; 0.63 for the month of May; and 0.47 for the month of April, which indicates an imbalance between species numbers characterized by the presence of a dominant species such as *Myzus sp.* Value of the same order of magnitude as that of Berchiche (2004) noted at Oued Smar (0.60). However, several authors report higher values. Indeed, Remini (2007), in studies carried out in the wasteland, maquis, and in the forest of the Zoological Park in Ben Aknoun, reported equitability values respectively equal to 0.78, 0.71, and 0.82. Similarly, Hamiche (2005), in the olive groves of Boudjima, mentioned a fairness equal to 0.75 and 0.84 in the Maatkas station.

The distribution of the different trophic categories revealed the existence of 05 large groups among the 292 species of insects inventoried with the dominance of phytophagous species (34%), followed by a massive presence of auxiliaries (33%) represented by the predators (16%), parasites and parasitoids (17%) (Fig3). The presence of these two categories of species is more often reported in yellow traps. Polyphagous species represented by fungivores, necrophages, omnivores, and acrophages are present with a percentage of 29%, most of which are trapped in red pots. Lastly, the saprophagous or coprophagous species are poorly rated with a rate of 04% (Fig4). However, the comparison with the authors mentioned above is not possible because they did not study the distribution according to the categories.

The factorial analysis of the correspondences highlights a resemblance between 4 groups for each month; each group is placed in a separate quadrant. For the trophic distribution of the species we note the presence of 5 groups. This analysis revealed the presence of one ubiquitous species (*Scatopse sp.*) during the three months of the study, with a frequency occurrence of 100% and an abundance of 0.35%.

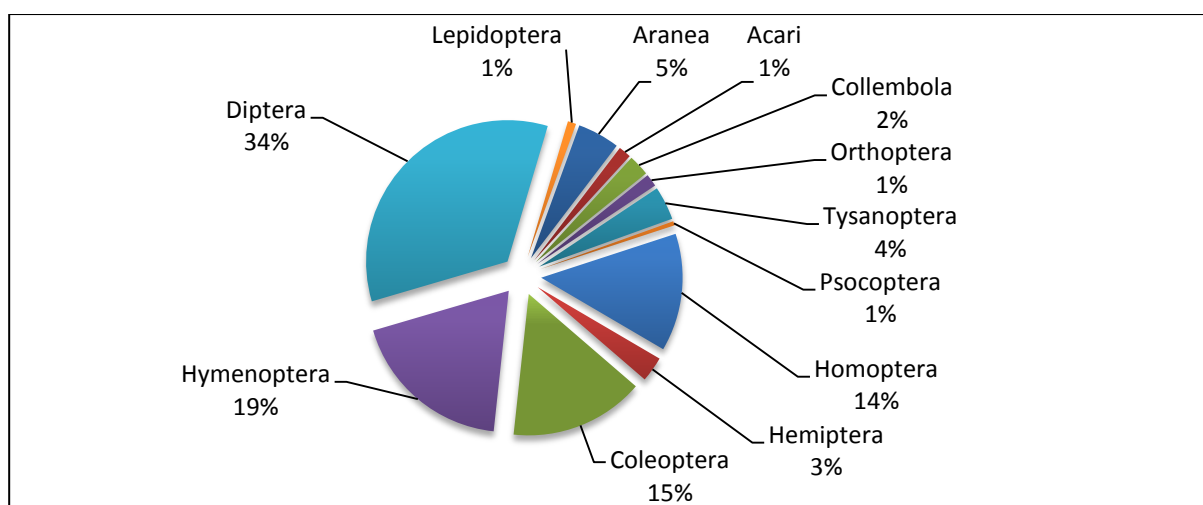


Figure.2. Total number of species trapped according to orders

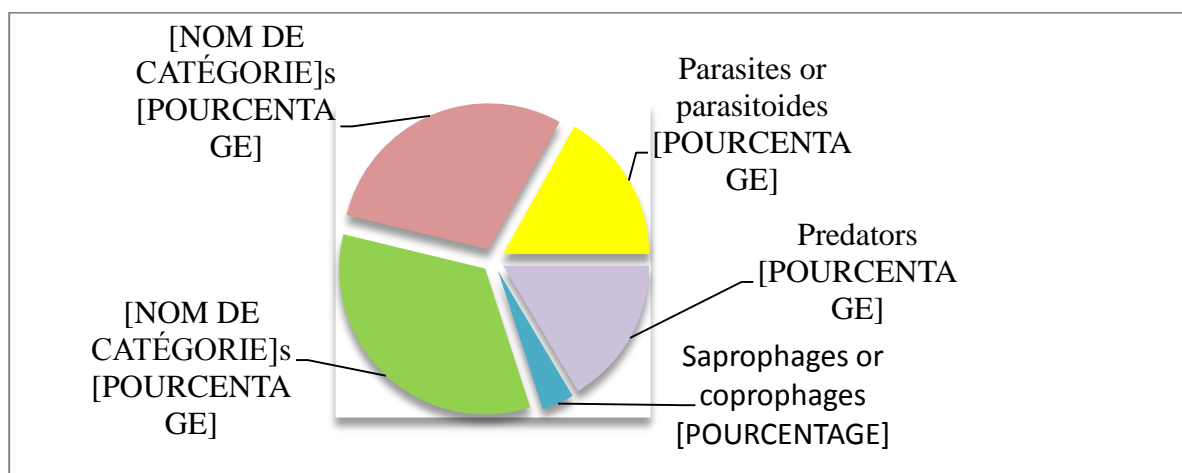


Fig3. Trophic distribution of entomofauna recorded on greenhouse tomato

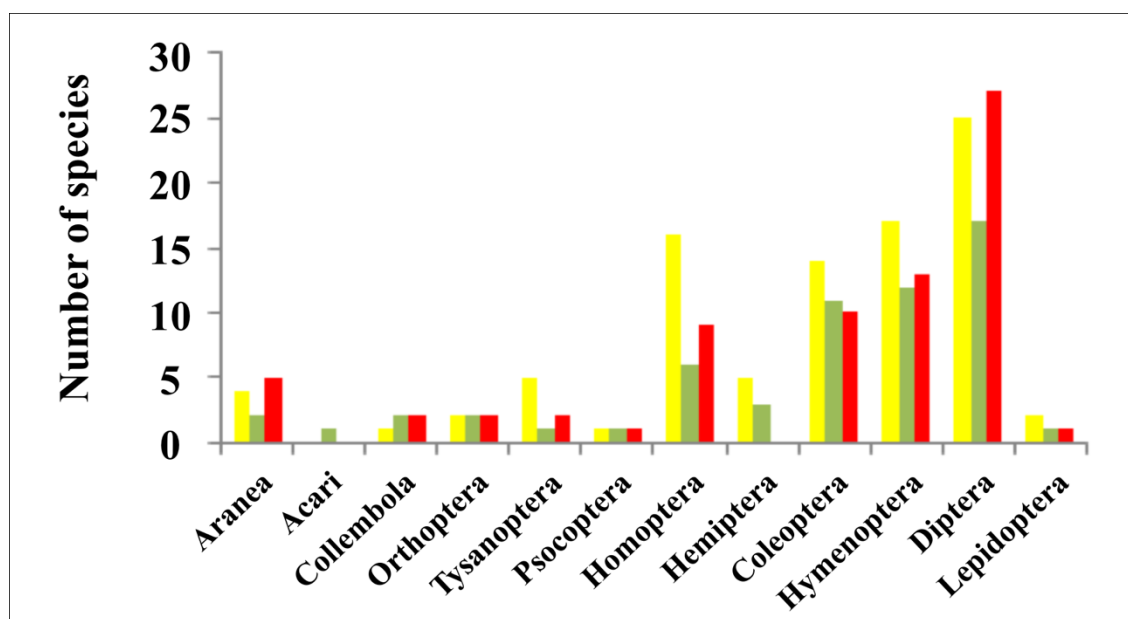


Figure.4. Total number of trapped species according to the color of the trap

### Conclusion

To further this study, it would be desirable to consider other sampling techniques by increasing the frequency of sampling. Consideration could be given to extending the scope to other regions belonging to other geographical entities, phytocenotic or simply bioclimatic such as the humid, subhumid, semi-arid, arid and Saharan levels. It would be interesting to follow several cultures of the same family of Solanaceae in different biotopes. Similarly, it would be instructive to examine the biological cycles of species and their phenological stages.

### References

- Alili F. (2008). Psylle du poirier *cacopsylla pyri* L(Homptera, Psyllidae) a Birtouta aux Eucalyptus et a Réghaia : dynamique de populations, ennemis naturels et entomofaune associée . Thèse Magister Inst. nati. agro. El Harrach. 211 p.
- Belatra O. (2010) Diversité de l'arthropodofaune de la pomme de terre (*Solanum tuberosum*) dans la région de Djelfa. Thèse Magister. Inst. nati. agro. El Harrach. 125 p.
- Berchiche S. (2004) Entomofaune du triticum aestivum et de vicia fabae, étude des fluctuations d'*Aphis fabae* Scopoli (1763) dans la station expérimentale de Oued – Smar. Thèse Magister . Inst. nati. agro. El Harrach. 218 p.
- Boussad F. (2003) Essai faunistique dans trois stations de légumineuses à Oued –Smar (Mitidja), Taribant et Timizart (Tizi-Ouzou) dégâts dus aux insectes de la fève à l'institut technique des grandes cultures (Oued–Smar) .Mémoire ing Inst. nati. agro. El Harrach. 184 p.
- Boussad F. (2006). Relations invertébrés -fève (*Vicia faba* Linné) comportement d'*Aphis fabae* Scopoli sur quatre variétés de fève dans la banlieue d'El-Harrach. Thèse ing , Inst. nati. agro. El Harrach. 179 p.
- Boussad F., Doumandji S. (2004). La diversité faunistique dans une parcelle de *Vicia faba* (Fabaceae) à l'institut technique des grandes cultures d'Oued – Smar. 2ème Journée protection végétaux, 15 mars 2004. Dép. Zool. agri., Inst. nati. agro. El Harrach. p.19.



- Chennouf R. (2011). Diversité entomofaunistique associée à la tomate et étude de dans la région de Ouargla (Hassi Abdallah). Mémoire de Magister. Inst. nati. agro. El Harrach. 95p.
- Hamiche A. (2005). Entomofaunr dans deux oliveries de Boudjima et de Maatkas (Tizi-ouzou): bioecologie de la mouche de l'olivier *Bactrocera oleae* Gmelin et Rossi 1788 (Diptera-Tephritidae). These Magister.INA. El Harrach. 199p
- Hautier L., Patiny S., Thomas-Odjo A., Gaspard C. (2003) – Evaluation de la biodiversité de l'entomofaune circulante au sein d'associations culturales au Nord Bénin. Notes faunistiques de Gembloux, (52) : 39-51.
- Moussa S. (2005). Inventaire de l'entomofaune sur cultures maraichères sous serre à l'institut technique des cultures maraichères et industrielles de Staouali. Mémoire ing Inst. nati. agro. El Harrach. 114 p.
- Ndoye M. (1975). Repartition altitudinale d'une faune entomologiqueau dessus d'une prairie . Cahier de L'ORSTOM. Serie Biologie x; 35-39;
- Remini L. (2007). Etude faunistique en particulier du Parc Zoologique de Ben Aknoun. Thèse Magister. Inst. nati. agro. El Harrach. 220 p.
- Trichpoulou A., Lagiou P. (1997). Healthy traditional Mediterranean diet : an expression of culture, history and lifestyle. *Nutrition Reviews*, 55(11) : 383-389

## THE MAIN CITRUS APHID SPECIES AND THEIR PARASITOIDS IN NORTHWESTERN ALGERIA. WHY IS APHID CONTROL NOT ALWAYS SUCCESSFUL?

Zine Eddine LABDAOUI\*, Yamina GUENAOUI

Department of Agronomy, University Ibn Badis of Mostaganem, Algeria

\*Corresponding author: zineddine.labdaoui@univ-mosta.dz

### Abstract

Aphids are an important problem in the Algerian citrus groves with very high densities during spring seasons. During the last years, the aphid *Aphis spiraecola* Patch has displaced *Aphis gossypii* Glover and *Toxoptera aurantii* Boyer de Fonscolombe (Hemiptera: Aphididae) in most citrus groves located in the region of Mostaganem (northwestern Algeria). This research was conducted in order to develop the control of the main Citrus aphid species. We have to record parasitoid populations able to destroy the aphid populations in 2 localities in order to determine the main parasitoids associated with the dominant aphid species and to evaluate the impact of pesticides on the parasitism rate. Samples of infested young leaves were recorded weekly from the beginning of the flush period until the end of spring. Aphid densities reached 153 aphids/leaf equivalents to 10 aphids.cm<sup>-2</sup>. The parasitoid species *Lysiphlebus testaceipes* Cresson and *Binodoxys angelicae* Haliday (Hymenoptera: Braconidae: Aphinae) were associated with both *A. spiraecola*, *A. gossypii* and *T. aurantii*, but the parasitism rate remains very low in both situations varying between 0.76 and 2.66. We tried to give some factors to explain why parasitoids were unsuitable for use in biological control of *A. spiraecola*.

**Keywords:** *Citrus*, aphids, natural enemies, integrated control, Northwestern Algeria.

### Introduction

Among several pests attacking *Citrus* trees, aphids are considered as the most damaging insects causing economic losses both in nurseries and Citrus groves. Feeding on young foliage, they produce leaf curling and are also able to transmit the most damaging disease due to *Citrus Tristeza Virus* (CTV) (Hermoso de Mendoza, 2001; Addante and *al.*, 2009). The damage is more important in spring (Hermoso de Mendoza *et al.*, 2001, 2006). In Algeria, the first work on aphid on *Citrus* spp. was started in 1985 (Aroun, 1985). Some works on aphids and their natural enemies, especially parasitoids were done in most growing *Citrus* spp. regions located in the north; in the centre (Benoufella-kitous and *al.*, 2014), in the northeast (Lebbal and Laamari, 2015) and in the northwest (Labdaoui and Guenaoui, 2015) but these studies were not deepened. Only 6 aphid species were found in the northwest of Algeria: *Aphis spiraecola* (Patch.), *Aphis gossypii* (Glover), *Aphis craccivora* (Koch), *Aphis fabae* (Scopoli), *Toxoptera aurantii* (Boyer de Fonscolombe) and *Myzus persicae* (Sulzer), with always a predominance of *A. spiraecola* (Labdaoui and Guenaoui, 2015). The European producing countries of *Citrus* spp. fruit usually try to control aphids by natural enemies associated to *Citrus* spp. (Stary *et al.*, 1988a; Jacas and Urbaneja, 2010; Gómez-Marco *et al.*, 2016). Indeed, in Algeria, chemical control is the only issue for the farmers, and it is very hard to guide the farms towards sustainability, promoting ecological principles with the conservation of resources. The objective of this study was to evaluate the importance of parasitoids attacking aphids in 2 situations: in a Citrus orchard, free of pesticides and in a

plantation currently sprayed with insecticides against aphids, and the leaf miner *Phyllocnistis citrella* (Lepidoptera: Gracillaridae).

## Material and methods

### Sites of study:

This study was conducted in the spring of 2016 on two *Citrus* orchards named site “A” at Mazaghran (35°53' 30.49"N - 0° 5'7.94"E, 1.12 ha) and site “B” at Sirat (35°43' 34.8"N 0°12' 25.5"E, 2.10 ha) in the Mostaganem region. “A” is a mixed orchard with a dominant variety (*Citrus clementina*) which is 30 years old. The orchard “B” (15 years old) is only constituted of *Citrus sinensis* var. Thomson; both were flood irrigated. The orchard “A” was free of pesticides and B was treated with Acetamiprid at the dose of 12 gr/ hl. The sampling dates started on 14<sup>th</sup> April and stopped on 23<sup>rd</sup> May in orchard “A” and from on 29<sup>th</sup> March to 14<sup>th</sup> May in orchard “B”.

### Field sampling

Colonies of aphids were marked at the beginning of spring leaf-flushing period and tracked weekly over the flush duration. One hundred young leaves from ten trees (10 leaves/ tree) were randomly collected on each sampling date. Samples placed separately in a labelled plastic bag were taken to the laboratory for the monitoring of aphids and their enemies.

### Aphid complex:

Samples were observed under a stereo-microscope. Healthy aphids were counted and parasitized aphids were left until mummification. New mummies were added to the total number.

### Parasitoid complex:

Mummies were separately placed in a gelatin capsule until the emergence of parasitoids. Emerged adults were immediately placed in 95% ethanol and stored at 4°C. The percentage of parasitization was estimated by calculating the number of mummified aphids to the total number of aphids. Parasitoids were observed and morphologically identified using different identification keys (Kavallieratos *et al.*, 2005; Rakhshani *et al.* , 2012, 2015; Tomanović *et al.* , 2012; Stary *et al.* , 2014; Petrović *et al.* , 2015).When needed European specialists were asked for confirmation.

### Statistical analysis

We used the software IBM SPSS Statistics v.23.

## Results and discussion

### Aphid complex:

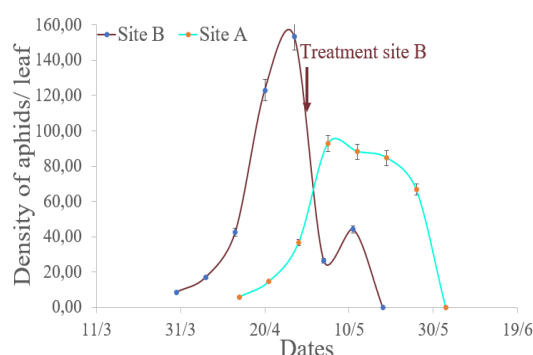


Figure 1: Total density of aphids/ leaf in site A and B

Density of aphids reached a peak of  $92.75 \pm 22.44$  aphids/leaf which represent  $6.90 \pm 1.06$  aphids.  $\text{cm}^{-2}$  on 19<sup>th</sup> May in site “A” and  $153.24 \pm 35.88$  which represent  $10.46 \pm 4.66$  aphids.  $\text{cm}^{-2}$  on 27<sup>th</sup> April in site “B” (Figure 1).

Three aphid species were identified: *A. spiraecola*, *A. gossypii* and *T. aurantii*. The latter was found only in “A” with the dominance of *A. spiraecola* in all cases (Figure 2 and 3) with a presence in 90% of infested leaves. In Spain, it is also the most prevalent, especially on *C. clementina* (Hermoso de Mendoza *et al.*, 2006; Gomez Marco, 2015).

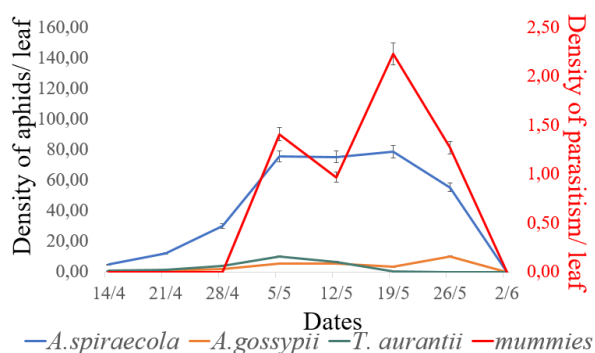


Figure.2: Density of aphids/ leaf in site “A” “B”

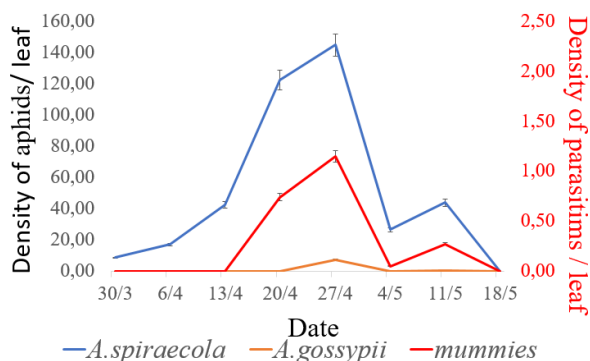


Figure.3: Density of aphids/ leaf in site

To control the infestation in site B, the *Citrus* spp. plantation was sprayed with a systemic insecticide (Acetamiprid) on 29<sup>th</sup> April (Figure 1). After treatment, aphid population decreased to  $26.49 \pm 10.90$  individuals/ leaf which represent  $1.81 \pm 1.80$  individuals.cm<sup>-2</sup> on 04<sup>th</sup> May with 64% of leaves infested. Of course, the aphid infestation decreased but its density was still remained high, exceeding 25% of shoots infested by *A.spiraecola* and as a threshold used the same number of aphids in Spain for chemical control (Hermoso de Mendoza *et al.*, 2001 and 2006).

#### Parasitoid complex:

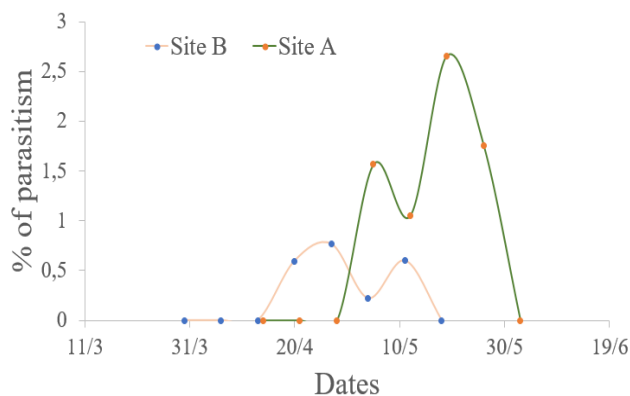


Figure 4: Rate of parasitism in site A and B

The first mummies were recorded on 04<sup>th</sup> May in “A” and on 20<sup>th</sup> April in “B”. The parasitism rate had been very low in both sites not exceeding 0.76% in the sprayed orchard and 2.66% in “A” without chemicals (Figure 4). In site “A” (Figure 5), between 05<sup>th</sup> May and 26<sup>th</sup> May, the rate of *A.spiraecola* mummies ranged from 60% to 86% with 13.51% of mummies on *A. gossypii*. On 12<sup>th</sup> May, we also noted that 28.57% of mummies on *T. aurantii*. On the last week of sampling (19<sup>th</sup> -26<sup>th</sup> May) the number of *A. spiraecola* mummies was always high (82 and 86%).

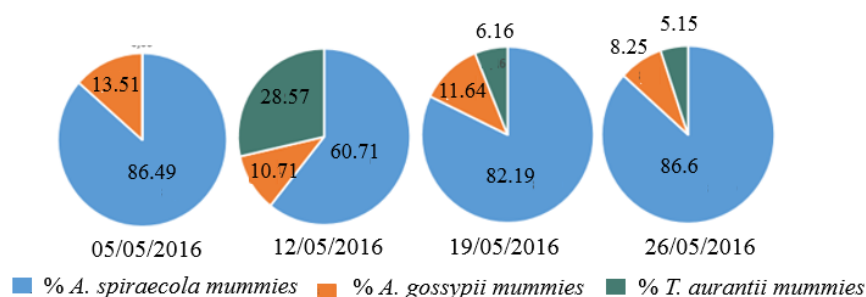


Fig.5: Rate of parasitism in site "A"

In site "B", we found only *A. spiraecola* mummies because of the predominance of this species (95 and 100% of total aphids during all sampling).

Emergence of adults from *A. spiraecola* mummies had been limited with 26.57 % in A (Figure 6) and 10% in B (Figure 7) and statistically insignificant ( $P=0.442$ ) in "A" and ( $P=0.118$ ) in "B". We recorded only 2 primary parasitoids species: *Lysiphlebus testaceipes* Cresson and *Binodoxys angelicae* Haliday (Hymenoptera: Braconidae: Aphiinae) and 4 hyperparasitoids species (secondary parasitoids) with a new species recorded on *A. spiraecola* (Ferrer-Suay *et al.*, 2017). In Spain, only *B. angelicae* was found parasitizing *A. spiraecola* (Gomez Marco, 2016). In Tunisia 4 parasitoids were inventoried on *A. spiraecola* (Sellami *et al.*, 2013). Until now, the causes of the low efficacy of parasitoids on *A. spiraecola* have not been well understood (Costa and Sary, 1988; Sary *et al.*, 1988; Gomez-Marco, 2016). According to Sary *et al.* (1988), *L. testaceipes* is not able to have a complete development on *A. spiraecola*. Malausa *et al.*, 2008 noted that mummies have emerged rarely. In our study, *L. testaceipes* represent until 31.58% (Site A) of the total emerged mummies on 05<sup>th</sup> April.

We found 4 Hyperparasitoids species: *Asaphes vulgaris* Walker, *Pachyneuron aphidis* Bouché, *Phaenoglyphis villosa* Hartig, *Phaenoglyphis heterocera* Hartig. The latter was recorded for the first time in Algeria in site "A" (Ferrer-Suay *et al.*, 2017).

Hyperparasitism can also contribute to the mortality and low abundance of primary parasitoids (Sullivan et Völkl, 1999; Rosenheim, 1998). In our case, the rate of parasitism has reached 17% in site "A" (Figure 6) and 30% in site "B" (Figure7). In Spain, the diversity and the abundance of hyperparasitoids from the beginning of spring were the cause of the low rate of parasitism (Gomez-Marco *et al.*, 2015).

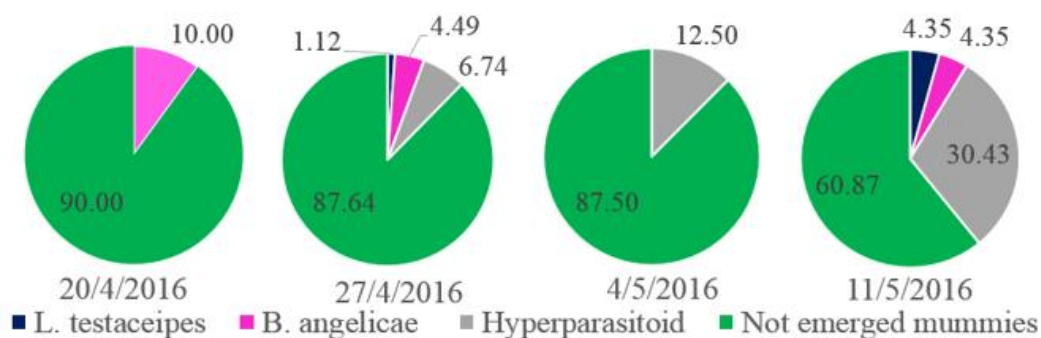


Fig.6: Rate of parasitism on *A. spiraecola* in site "A"

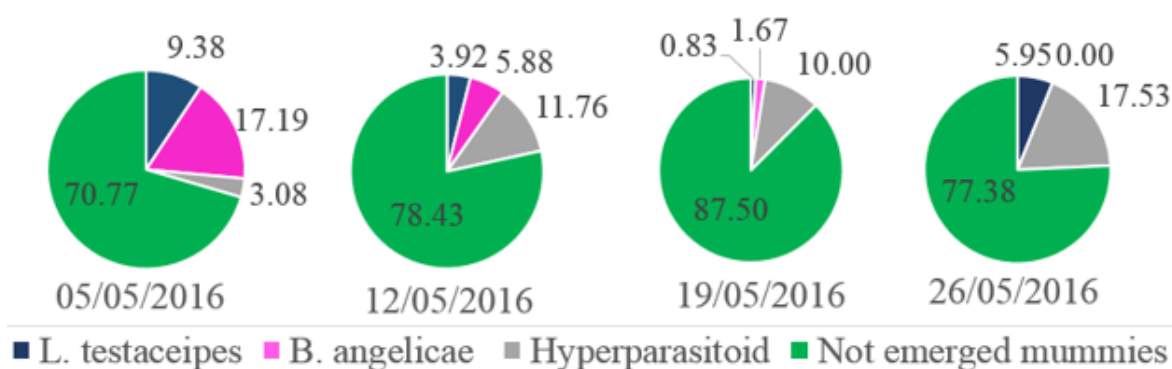


Fig.7: Rate of parasitism on *A. spiraecola* in site “B”

### Conclusion

In this study, only 3 aphids were recorded: *A. spiraecola*, *A. gossypii* and *T. aurantii*. The most dangerous one, *Toxoptera citricidus* have not been found until now. *A. spiraecola* was the dominant species during the sampling period. Despite chemical control, the aphid density was still important. Only 2 parasitoids were found: *L. testaceipes* and *B. angelica* with a limited rate even in free pesticides plantation (under 3 %). The presence of the 4 hyperparasitoids recorded could have disturbed the efficacy of these primary parasitoids. Within the framework of integrated protection management, other measures can underpromote the development of specific weeds to attract more natural enemies. This research could help *Citrus* spp. growers in the adoption of sustainable practices and could provide answers to some questions related to frequent high aphid infestations even in free pesticide orchards.

### References

- Addante, R., Djelouah, K., D’Onghia, A. M. (2009). Citrus aphids in Italy: historical review. Options Méditerranéennes–Citrus Tristeza Virus and Toxoptera citricidus: a serious threat to the Mediterranean Citrus industry, 65, 63-68.
- Aroun M.E.F, (1985). Les aphides et leurs ennemis naturels en vergers d’agrumes de la Mitidja (Algérie). Aphids and their natural enemies in citrus crops in Mitidja (Algeria). (Magister). National agronomic institute El Harach. Algiers
- Costa, A., Starý, P. (1988). Lysiphlebus testaceipes, an introduced aphid parasitoid in Portugal [Hym.: Aphidiidae]. BioControl, 33(4), 403-412.
- Benoufella-Kitous K., Doumandji S. Hance T., 2014. Inventaire des aphides et de leurs ennemis naturels dans un verger d'agrumes. Inventory of aphids and their natural enemies in a citrus orchard. AFPP- Tenth International Conference on Pest in Agriculture Montpellier (France)- 22 and 23 October 2014. 10p.
- Ferrer-Suay M., Selfa J., Labdaoui M.Z., Guenaoui Y. Pujade-Villar. (2017). First record of Phaenoglyphis heterocera (Hartig, 1841) (Hymenoptera: Cynipoidea: Figitidae: Charipinae) from Algeria. Butlletí de la Institució Catalana d'Història Natural. 81:17-18
- Gomez Marco F. (2015). Integrated Pest Management of Aphis spiraecola (Hemiptera: Aphididae) in clementines: enhancing its biological control. PhD thesis. Universitat Politècnica de València (Spain). 202p
- Gómez-Marco, F., Urbaneja, A., Jaques, J. A., Rugman-Jones, P. F., Stouthamer, R., Tena, A. (2015). Untangling the aphid-parasitoid food web in Citrus: Can hyperparasitoids disrupt biological control?. Biological Control, 81, 111-121.
- Gómez-Marco F., Urbaneja A. Tena A. (2016). A sown grass cover enriched with wild forb plants improves the biological control of aphids in citrus. Basic and Applied Ecology, 17(3), 210-219.

- Hermoso De Mendoza A., Belliure B., Carbonell E. A., Real V. (2001). Economic thresholds for *Aphis gossypii* (Hemiptera: Aphididae) on *Citrus clementina*. *Journal of economic entomology*, 94(2), 439-444.
- Hermoso De Mendoza A., Arouni R., Belliure B., Carbonell E. A. Pérez-Panadés J. (2006). Intervention thresholds for *Aphis spiraeicola* (Hemiptera: Aphididae) on *Citrus clementina*. *Journal of economic entomology*, 99(4), 1273-1279.
- Jacas J. A., Urbaneja A. (2010). Biological control in Citrus in Spain: from classical to conservation biological control. In *Integrated management of arthropod pests and insect borne diseases*. Springer Netherlands, pp. 61-72.
- Kavallieratos, N. G., Tomanović, Ž., Athanassiou, C. G., Starý, P., Žikić, V., Sarlis, G. P., Fasseas, C. (2005). Aphid parasitoids infesting cotton, citrus, tobacco, and cereal crops in southeastern Europe: aphid-plant associations and keys. *The Canadian Entomologist*, 137(05), 516-531.
- Labdaoui M.Z, Guenaoui Y., (2015). The aphids infesting Citrus orchards and their natural enemies in the Northwestern Algéria. *Sixth International Scientific Agricultural Symposium Agrosym 2015“*. 787-792
- Lebbal S, Laamari (2016). Population dynamics of aphids (Aphididae) on orange (*Citrus sinensis* ‘Thomson Navel’) and mandarin (*Citrus reticulata* ‘Blanco’). *Acta agriculturae Slovenica*. 137-147.
- Petrović, A., Mitrović, M., Ivanović, A., Žikić, V., Kavallieratos, N. G., Starý, P., Bogdanović A.M., Tomanović Ž., Vorburger, C. (2015). Genetic and morphological variation in sexual and asexual parasitoids of the genus *Lysiphlebus*—an apparent link between wing shape and reproductive mode. *BMC evolutionary biology*, 15(1), 5.
- Rakhshani E., Kazemzadeh S., Starý P., Barahoei H., Kavallieratos N. G., Četković A., Popović A., Bodlah I, Tomanović, Ž. (2012). Parasitoids (Hymenoptera: Braconidae: Aphidiinae) of northeastern Iran: Aphidiine-aphid-plant associations, key and description of a new species. *Journal of Insect Science*, 12(143), 1-26.
- Rakhshani, E., STARÝ, P., TOMANOVIĆ, Ž., Mifsud, D. (2015). Aphidiinae (Hymenoptera, Braconidae) aphid parasitoids of Malta: review and key to species. *Bulletin of the entomological Society of Malta*, 7, 121-137
- Rosenheim, J.A., 1998. Higher-order predators and the regulation of insect herbivore populations. *Annu. Rev. Entomol.* 43, 421–447.
- Sellami, E. L., Delvare, G., Chermiti, B. (2013). Parasitoids and hyperparasites of citrus aphids in northern east of Tunisia (Cap Bon). *IOBC-WPRS Bulletin*, 95, 131-139.
- Starý, P., Lyon, J. P., Leclant, F. (1988). Biocontrol of aphids by the introduced *Lysiphlebus testaceipes* (Cress.)(Hym., Aphidiidae) in Mediterranean France. *Journal of Applied Entomology*, 105(1-5), 74-87.
- Starý, P., Kavallieratos, N. G., Petrović, A., Žikić, V., Rakhshani, E., Tomanović, S., Tomanović Ž., Havelka, J. (2014). Interference of field evidence, morphology, and DNA analyses of three related *Lysiphlebus* aphid parasitoids (Hymenoptera: Braconidae: Aphidiinae). *Journal of Insect Science*, 14(171), 1-6.
- Sullivan, D.J., Völkl, W., 1999. Hyperparasitism: multitrophic ecology and behavior. *Annu. Rev. Entomol.* 44, 27.
- Tomanović Ž., Starý P., Kavallieratos N. G., Gagić V., Plečas M., Janković M., Rakhshani E., Četković A., Petrović, A. (2012). Aphid parasitoids (Hymenoptera: Braconidae: Aphidiinae) in wetland habitats in western Palaearctic: key and associated aphid parasitoid guilds. In *Annales de la Société Entomologique de France* Taylor & Francis Group. 189-198

## THE EFFECT OF VEGETABLE FATS ON THE QUALITY AND SENSORY PROPERTIES OF TEA COOKIES

Amela SEMIC<sup>1\*</sup>, Selma CORBO<sup>1</sup>, Seval MUMINOVIC<sup>2</sup>

<sup>1</sup>Faculty of Health Studies, University "Vitez" Vitez, Bosnia and Herzegovina

<sup>2</sup>Faculty of Agriculture and Food Sciences, University of Sarajevo, Bosnia and Herzegovina

\*Corresponding author: amela.semic@asholding.ba

### Abstract

One of the basic raw materials in the production of vanilla crescents is vegetable fats, which affect the product taste, consistency, texture and other properties. Greater content of vegetable fat gives the product a lighter structure, increased volume, better solubility and softness during consumption; however, at the same time, it may have a negative effect on the product taste and smell. The purpose of this paper is to examine the effect of application of the different types and quantities of vegetable fats on the quality of vanilla crescents produced at the *Klas Sarajevo* Company plant. The vegetable fats used in this paper were products of companies *Zvijezda* and *Dijamant*. Directly after the production and two months after the preservation, all the samples of vanilla crescents were subjected to sensory evaluation in order to examine the extent to which the change in the type and quantity of vegetable fats affected the quality parameters of the basic product, specifically, the product shape, upper and lower surface, breakage, structure and crispiness, solubility, and smell and taste of vanilla crescents. Sensory evaluation was done by a ten member evaluation team, who applied a unified evaluation form. The evaluated, quality parameters were rated from 1 to 5, multiplied by a corresponding significance coefficient (SC), specifically 0.3 for shape, 0.5 for upper surface, 0.4 for lower surface and breakage, 0.6 for structure, and 1 point for taste and smell. The values, thus obtained were then added up, the maximum sum of points being 20. The tea cookie samples where *Zvijezda* fats were used on average scored higher compared to the samples with *Dijamant* fats and it is recommended in further production.

**Key words:** *vegetable fats, vanilla crescents, melting point, fat, water, sensory evaluation*

### Introduction

In confectionery industry, natural vegetable fats are used (cocoa butter), as well as hydrogenated vegetable fats, individually or in combination with animal fats (Corbo, 2008; Stanimirovic, 1987). In the technology of confectionery products specific purpose fats are used, namely vegetable butters, special and bakeable fats. Vegetable butters consist of simple mixture of triglycerides, which melt within a narrow temperature interval, are crispy and display the property of polymorphism. They regulate the behavior of dough through their qualities of plasticity and the ability to absorb air bubbles. Special fats have functional properties adapted to achieving appropriate physical qualities of a confectionery product. Preference is given to special fats which do not contain lauric acid, sensitive to hydrolytic and enzyme spoilage. Depending on the composition of a confectionery product, changes in the product smell and taste may occur as a result of chemical changes in fats, leading to shorter product durability. Bakeable fats need to be resistant to the effect of the dough pH value and baking temperature (Gavrilovic, 2011). Being one of the basic ingredients of confectionery products, fats affect their taste, consistency, texture and physical properties. Vegetable fat



(cocoa butter) contains 60 % of saturated fat acids, stearic and palmitic acid. Additionally, it contains non-saturated fatty acids. When consumed, it melts softly within a narrow temperature range between 29 and 33°C and significantly determines the product sensory properties. Other vegetable fats have a lower portion of saturated fatty acids but melt within a broader temperature range between 35 and 40°C and still contain a high proportion of unmelted fraction (Schunemann and Treu, 2012.). Depending on the product type, 30 to 40% is added, which significantly affects the physical and sensory properties of the product (Gavrilovic, 2000). Higher proportion of fat gives the product a lighter structure, more volume, better solubility and softness when consumed (Kramar, 2004; Corbo *et al.*, 2006). Tea cookies take up a significant place in the overall confectionary production and consumption (Pajin *et al.*, 2005; Oluwamukomi *et al.*, 2011; Galla *et al.*, 2017). There are four groups of tea cookies: pressed, formed, cut and dressed. They differ in their shape, upper surface, size, aromatic properties and decoration. Their common characteristic is that their top is smooth to rather rough, shiny or without shine, with clear mold prints, more or less damaged bottom, weary looking cross-section, crunchy and crispy breakage. Fats give these products plastic-elastic and grainy structure, their middle is softer, dry, with round, unevenly placed holes. When broken and chewed, they are extremely crunchy and gently sandy due to large granules of pastry flour. Depending on their type, these products are decorated and coated with chocolate or sugar coating (Beslagic, 1999; Beslagic, 2005).

### **Material and methods**

Physical and chemical analyses were performed on different fats (margarine, vegetable butter and vegetable ghee) used in the production of vanilla crescents. In the production process, fats were added in accordance with the original recipes,  $\pm 5\%$  in respect to the original recipe (Table 1). In addition to the fats, in the preparation of raw materials, all-purpose wheat flour Type 500 was used, along with powdered sugar, fresh eggs, confectioners sugar, salt, water and flavors. After the production, the packed products were kept in storage at 15°C and air humidity of 60%.

After the preparation, scaling was done, which was followed by the mixing in two phases. In phase one, fast mixing was applied for 8 minutes, while in phase two the mixing lasted for 2 minutes. The raw materials were mixed in a mixer with an installed spiral hook (Universal Mixer V 250-V1600 Diosna). The dough was formed by pressing it through molds and cutting by wire to a specified height. The cutting device (Hecrona-Hass type) consists of a dough bowl, underneath which are two ribbed rolls spinning one against the other. This way they accept the dough and push it through the mold openings arranged in two rows and located below the rolls. The shaped dough falls down to a conveyor belt, where the shaped pieces are cut. After the shaping, the dough goes to the industrial tunnel baking chamber. In zone one, the initial baking temperature was 150 to 200°C, which was then gradually increased to 220 and up to 240°C. The baking time was 7 to 15 minutes. When the product left the oven, it was cooled naturally on open conveyer belts at air temperature between 3 and 10°C. After cooling, the final products were packed in PS polystyrene pads and PP polypropylene and PS polystyrene printed foil. Before packing, the top of the tea cookies was sprinkled with hazelnuts. The cookies were then packed in cellophane and the packaging for transportation. The raw materials were prepared and vanilla crescents were produced at the confectionery factory *Klas Ltd Sarajevo*.

Table 1. Names and markings of the samples examined

Tea cookies/sample marking	Fats/sample marking	Quantity of fats added and with a lower portion during the production (fats produced according to the manufacturer's recipe)
Vanilla crescents (DVZ)	<i>Zvijezda</i> vegetable fat (BMZ)	- 5% vegetable fat
Standard sample – vanilla crescents (DVS)	<i>Zvijezda</i> vegetable fat (BMZ)	Recipe known to the manufacturer
Vanilla crescents with hazelnut (DVLJ)	<i>Zvijezda</i> vegetable fat (BMZ <sup>+</sup> )	+ 5% vegetable fat
Standard sample – (DVLJS)	<i>Zvijezda</i> vegetable fat (BMZ)	Recipe known to the manufacturer
Vanilla crescents (DVD1)	<i>Dijamant</i> vegetable fat (BMD <sup>+</sup> )	-5% vegetable fat
Standard sample – (DVSD)	<i>Dijamant</i> vegetable fat (BMD)	Recipe known to the manufacturer
Vanilla crescents with hazelnut (DLJD)	<i>Dijamant</i> vegetable fat (BMD <sup>+</sup> )	+5% vegetable fat
Standard sample – (DLJS)	<i>Dijamant</i> vegetable fat (BMD)	Recipe known to the manufacturer

Fat analyses were done prior to their adding into the products, that is, prior to the production. In terms of the physical analyses, the fat melting point was determined by open capillary method (HRN EN ISO 6321:2004). In terms of the chemical analyses, the fat content was determined by the Soxhlet extraction method (HRN EN ISO 659:2004), while the water content was determined by drying method at 105°C (HRN EN ISO 662:2004).

The sensory analysis was done for two samples of vanilla crescents (with and without the addition of hazelnuts), produced with the same dough composition, to which different fats had been added. Sensory evaluation was done by 10 professional evaluators according to standard and common practice in factory. After the production and two months of storage, the final product was subjected to sensory evaluation. The following quality factors were evaluated: shape, upper surface, lower surface, breakage, structure and crispiness, solubility, smell and taste. The descriptive quality indicators were rated on a scale from 1 to 5, multiplied by the corresponding coefficient (CC). All products evaluated as *excellent* and *very well* may be placed on the market (Kaludjerski and Filipovic, 1998).

The standard mathematical-statistical method was applied, which implied the variance analysis and evaluation of the significance of the differences obtained by applying the appropriate Tukey's test ( $W_{0,05}$  test) and using Microsoft Excel 2003.

## Results and discussion

Individual values of the melting point, fat and water content for all the samples of vegetable fats, vegetable ghee and margarine are shown in Table 2.

Table 2. Melting point, fat and water content of the examined fat samples

Samples	Melting point (°C)	Fat (%)	Water (%)
BMRZ	34.00 ± 1.63	97.32 ± 1.30	0.23 ± 0.02
BMZ	32.00 ± 1.63	95.17 ± 11.19	0.18 ± 0.08
MGZ	39.33 ± 2.49	77.67 ± 0.46	8.17 ± 0.37
BMRD	34.00 ± 2.00	97.75 ± 1.19	0.79 ± 0.02
BMD	29.33 ± 1.15	97.71 ± 2.68	0.20 ± 0.01
MGD	40.00 ± 2.00	77.68 ± 3.63	15.11 ± 1.15

Vegetable fats have different melting points. This is the temperature at which a matter, fat included, melts and is transformed from solid to liquid state (Rade *et al.*, 2009). In the winter period it is 30 to 32°C and in the summer it is between 34 and 36°C (Official Gazette of RB&H 2/92). The fat containing 15-30% of solid phase at the temperature interval between 10-30°C possesses the properties of plasticity (Beslagic, 2005). The melting point in fat samples was in range from 29.33 (BMD) to 40 °C (MGD). There are no statistically significant differences in the melting point between the examined fat samples produced by two different manufacturers. The results obtained are in accordance with the Rulebook values (Official Gazette of RB&H 2/92).

The content of fat ranged from the lowest value in the case of margarine sample (MGD) and was 77.68 % to the maximum value in the case of the vegetable ghee (BMRD) and was 97.75 %. The results were in accordance with the results of authors Lambasa-Belak *et al.* (2005) and Kramar (2004), who indicate the fat content in the vegetable ghee of up to 95 %. The values of the results for water content did not deviate from the values prescribed by the Rulebook (Official Gazette of RB&H 2/92) of up to 1.5% for vegetable ghee, where in the case of the vegetable ghee sample (BMRZ) it was 0.23 %. There are no differences in the fat and water content among the examined fat samples produced by different manufacturers.

Table 3 presents the results of the examination of the vanilla crescents quality parameters depending on the type and quantity of added vegetable fats directly after the production.

Table 3. Average sensory values of the examined vanilla crescent quality parameters depending on the type and quantity of added vegetable fats observed directly after the production\*

Type and quantity of added vegetable fat	shape	upper surface	lower surface	breakage	structure	solubility	smell and taste	score sum
Variation 1. (BMZ)	1.5a	2.5a	2a	2a	3a	4a	5a	20a
Variation 2. (BMZ <sup>+</sup> )	1.44b	2.35a	2a	1.92b	3a	4a	5a	19.71b
Variation 3. (BMZ)	1.5a	2.30b	1.84b	1.88b	2.76c	3.92b	5a	19.2c
Variation 4. (BMD)	1.5a	2.50a	2a	1.92b	3a	4a	5a	19.92a
Variation 5. (BMD <sup>+</sup> )	1.47a	2.25b	2a	1.92b	2.82b	3.84c	4.80b	19.1 c
Variation 6. (BMD <sup>-</sup> )	1.44b	2.35a	1.88b	1.92b	2.70d	3.76d	5a	19.05c

\* Different letters in columns from a to d for each parameter indicate significantly different values among variations at  $P < 0.05$

The results presented in Table 3 indicate that the overall quality of vanilla crescents, at the time directly after the production, significantly depended on the type and quantity of added vegetable fat. The highest sum of scores for the overall product quality was observed in the variation 1, where *Zvijezda* vegetable fat was added in the production in accordance with the recipe, and in the variation 4, where *Dijamant* vegetable fat was used also in accordance with the recipe.

Observed within the same quantities of added vegetable fats, almost all examined vanilla crescent quality parameters had significantly higher values in the varieties where *Zvijezda*

vegetable fat was used to compare to the varieties where *Dijamant* vegetable fat was used. This leads to a conclusion that certain chemical properties of vegetable fat also have a significant effect on the quality of vanilla crescents.

Table 4 presents the results of examination of vanilla crescent quality parameters depending on the type and quantity of added vegetable fats, however, observed two months after the production.

Table 4. Average sensory values of the examined vanilla crescent quality parameters depending on the type and quantity of added vegetable fats, observed two months after the production\*

Type and quantity of added vegetable fat	shape	upper surface	lower surface	breakage	structure	solubility	smell and taste	score sum
Variation 1. (BMZ)	1.47b	2.35bc	1.88c	1.84c	2.70c	3.76c	4.9a	18.9c
Variation 2. (BMZ <sup>+</sup> )	1.50a	2.40b	1.88c	1.92b	2.76b	3.84b	5a	19.3b
Variation 3. (BMZ)	1.47b	2.35bc	1.92b	1.84c	2.70c	3.76c	4.9a	18.94c
Variation 4. (BMD)	1.50a	2.50a	2a	2a	3a	4a	5a	20a
Variation 5. (BMD <sup>+</sup> )	1.50a	2.30c	1.88c	1.88bc	2.64d	3.76c	5a	18.96c
Variation 6. (BMD)	1.47b	2.35bc	2a	1.92b	2.58e	3.52d	4.7b	18.54d

\* Different letters in columns from a to e for each parameter indicate significantly different values among variations at  $P < 0.05$

Two months after product storage, all samples were evaluated as *excellent*. The presented results also suggest that within each examined type of vegetable fat, the overall quality of vanilla crescents statistically significantly drops if the vegetable fat content in them is lower. If one compares the results presented in tables 3 and 4, one can see that the overall quality of vanilla rolls was significantly lower two months after the production, particularly in the case of the product structure and solubility as the quality parameters. The results obtained could be realistically expected if one takes into account the fact that with time vegetable fats degrade.

### Conclusions

During sensory evaluation, all of the tea cookie samples were descriptively evaluated as *excellent*, and as such they can be placed on the market. It is important to mention that the samples where *Zvijezda* fats were used on average scored higher compared to the samples with *Dijamant* fats. It is therefore recommended that *Zvijezda* fats be used in further production and that *Dijamant* fats be placed on the list of raw materials as an alternative. This research has given a contribution and a recommendation for maintenance and possibly improvement of quality of tea cookies produced by *Klas Sarajevo*.

### References

- Beslagic S. (1999). Tehnologija žita, skroba i šećera (Technology of cereals, starch and sugar). Zavod za udžbenike i nastavna sredstva IP Sarajevo. pp. 91-115.
- Beslagic S. (2005). Tehnologija konditorskih proizvoda (Technology of confectionery products). Univerzitetski udžbenik Sarajevo. pp. 19, 20-30, 114-122.
- Corbo S.(2008). Tehnologija ulja i masti (Technology of oil and fat). Univerzitetski udžbenik, Sarajevo, pp. 215-217.
- Corbo S., Smajic A., Tahmaz J., Ganic A., Sinanovic N., Basic M. (2006). Application of margarine and vegetable fats as a functional food in the modern diet. Works of Faculty of Agriculture and Food Sciences, University of Sarajevo, Vol. LI. No. 57. pp. 187-192.

- Galla N.R., Pamidighantam P.R., Karakala B., Gurusiddaiah M.R., Akula S. (2017). Nutritional, textural and sensory quality of biscuits supplemented with spinach (*Spinacia oleracea* L.), *International Journal of Gastronomy and Food Science*, Vol.7, pp.20-26.
- Gavrilovic M. (2000). *Tehnologija konditorskih proizvoda (Technology of confectionery products)*, Novi Sad.
- Gavrilovic M. (2011). *Tehnologija konditorskih proizvoda (Technology of confectionery products)*, Novi Sad.
- HRN EN ISO 6321:2004- Determination of melting point by oven capillary method (ISO 6321:2002; EN ISO 6321:2002).
- HRN EN ISO 659:2004 –Determination of fat content (ISO 658:1998; EN ISO 659:1998).
- HRN EN ISO 662:2004- Determination of water content and volatile substances (ISO 662:1998; EN ISO 662:2000).
- Kaludjerski G., Filipovic N. (1998). *Metode ispitivanja kvaliteta žita, brašna i gotovih proizvoda (Methods of testing the quality of grain, flour and final products)*, Tehnološki fakultet. Zavod za tehnologiju žita i brašna, Novi Sad.
- Kramar I. (2004). *Upotreba biljnih masnoća u proizvodnji čajnih peciva (The use of vegetable fats in the production of tea biscuits)*. Magistarski rad, Poljoprivredno-prehrambeni fakultet Sarajevo.
- Lambasa-Belak Z., Gacina N., Radic T. (2005). *Tehnologija hrane (Food technology)*, Interna skripta. Viša škola za menadžment u Šibeniku. pp. 55-58.
- Landa-Habana L., Pina-Hernandez A., Agama-Acevedo E., Tovar J., Bello-Perez L.A. (2003). *Effect of cooking procedures and storage on starch bioavailability in common beans- Plants Food for Human Nutrition*. pp. 133-136.
- Oluwamukomi M.O., Oluwalana I.B., Akinbowale O.F. (2011). *Physicochemical and sensory properties of wheatcassava composite biscuit enriched with soy flour*. *African Journal of Food Science* Vol. 5 (2) pp.50 – 56.
- Pajin B., Jovanovic O., Torbica A., Saric M. (2005). *Tehnološki kvalitet brašna domaćih sorti pšenice za proizvodnju brašneno-konditorskih proizvoda (Technological quality of flour domestic wheat varieties for the production of farinaceous-confectionery products)*. *Žito-hleb* 32.
- Pravilnik o uvjetima u pogledu mikrobiološke ispravnosti kojima moraju udovoljavati živežne namirnice u prometu (Official Gazette of RB&H 2/92).
- Rade D., Mokrovicak Z., Strucelj D. (2009). *Pripručnik za vježbe iz kemije i tehnologije lipida (Handbooks for the practical work of chemistry and technology of lipids)*, Zagreb. pp. 57.
- Schunemann C.,Treu G. (2012). *Tehnologije proizvodnje pekarskih i slastičarskih proizvoda (The technology of production of bakery and confectionery products)*, Zagreb.pp. 413.
- Stanimirovic D. (1987). *Bromatologija (Food Science)*, Beograd. pp. 19-20, 38-52.

## TECHNOLOGICAL PROPERTIES OF POMEGRANATE JUICE FROM MOSTAR CITY AREA (BOSNIA AND HERZEGOVINA)

Amna BIJEDIĆ<sup>1\*</sup>, Hanadija OMANOVIĆ<sup>2</sup>, Asima AKAGIĆ<sup>1</sup>

<sup>1</sup>Faculty of Agriculture and Food Science, University Of Sarajevo

<sup>2</sup>Agromediterranean faculty, University „Džemal Bijedić“ in Mostar

\*Corresponding author: \*hanadija.omanovic@unmo.ba

### Abstract

The aim of this work is a comparative analysis, microbiological and chemical characteristics of the pomegranate juice from area Mostar city, Bosnia and Herzegovina. Sampling of juice was randomly selected, selecting from area Mostar city: Podgorani, Vrapčići i Bijelo Polje. Microbiological analysis were: *Salmonella types* in 25 g (ml), *Coagul.pos.staphilococae* in 0.1 (ml), *Sulph.red. clostridiae* u 0.1 g (ml), *Proteus species* in 0.1 g (ml), *Escherichia coli* in 0.1 g (ml) and total number of bacteria in 1 g (ml). Chemical analyses were: determination of soluble dry matter (manual refractometer), determination of the total dry matter (gravimetric), determination of total sugars (method by Luff-Schorl), determination of Vitamin C, the presence of artificial paints by the chromatographic method of color induration. The samples tested according to the provisions of the Ordinance on conditions in terms of chemical, microbiological correctness, which must comply with foodstuffs in the market, Official Gazette R BiH 2/92, rulebook on refreshing non-alcoholic beverages and similar products (Official Gazette of BiH No. 85/08, 54/11), as well as the Ordinance on microbiological criteria for food (Official Gazette of BiH No. 11/13). The results obtained indicate that all three analyzed juice samples deviate from the prescribed values, the microbiological correctness in terms of the total number of bacterial g (ml), as well as the dry matter content, while the high values of vitamin "C" in each of the tested samples determined, indicates a significant nutritive value of pomegranate juice and its significance in our diet, especially from the aspect of human health.

**Keywords:** *juice, pomegranate, microbiological and chemical analysis, quality.*

### Introduction

Fruit juice is a non-alcoholic drink usually made from fruit, but also some types of vegetables, and is obtained by squeezing of their liquid. Juices, together with their related products, represent the most important group of fruit products from the food and economic point of view. They differ in physical and chemical characteristics, as well as the technological process of production itself. Sugar content can be corrected by adding it in the production process. Pomegranate juice (especially from wild pomegranate) is distinguished by its potability and beneficial effect. Juice from the pomegranate fruit of Herzegovina and Montenegrin varieties mainly contains water (62.8-73.6%) which is sterile and healthy. For the production of juice wild pomegranate that grows freely in spontaneous vegetation without the influence of man is used. Also, for the production of pomegranate juice, the most important is the harmonious relationship between sugar and acids. Domestic pomegranate juice due to chemical composition, primarily because of dry matter content and method of production (cooking process), belongs to fruit syrups. Fruit syrup is a product with a high percentage of dry matter, syrup consistency, obtained from freshly squeezed or semi-processed clear or blurry juice with the addition of sugar. Dry matter is from 65 to 67%

(Niketić, Aleksić, 1982). Syrup is produced primarily from aromatic fruits. For the quality syrup, in addition to aromaticity, very important is intense color, in order for the diluted product to have a certain intensity of the characteristic color of the fruit from which the syrup was obtained. Because of that, the syrup is produced by mixing fruits, wherein aromatic and intensively colored types - i.e. varieties are combined. Adding artificial colors is not allowed according to the valid Rule book. Natural colors can be added in the form of concentrated fruit juices up to 5% of the amount of juice. Technological process of syrup production consists of two phases (Omanovic, 2008): The first phase is to obtain a clear or blurry juice, i.e. semi-processed, chemically preserved juice, and the second phase is cooking the juice with the addition of sweetening agents. It can rightly be said that the pomegranate juice belongs to functional food. Pomegranate juice not only provides enough nutrients for the body, but it has been proven that its consumption has a good impact on health, positively influences some body functions and affects the prevention of disease. Pomegranate juice (especially from wild pomegranate) is distinguished by its potability and beneficial effect, especially in cases of mild stomach problems and urinary tract inflammation. Properties of juice have been known since the early centuries where it was used to treat diabetes, asthma, heart disease and arteriosclerosis. Pomegranate juice is used in many ways in nutrition and drinks. The aim of this work was to examine the microbiological and chemical characteristics of three pomegranate juices from three different independent producers from the area of Mostar, compare the results with the parameters of the current Rule book, and give an assessment of the acceptability of the products for future potential consumers in the free market with the presentation of the results of chemical analyzes.

### **Material and Methods**

Sampling was carried out in 2015 in the Mostar area by random selection of three different independent producers of pomegranate juice: sample number 1, Independent manufacturer: Tipura Elvina, Podgorani-Mostar, sample number 2, Independent producer: Kubić Alija, Vrapčići-Mostar and sample number 3, Independent manufacturer: Zaklan Emina, Bijelo Polje. Samples were submitted to analyzes made at the Federal Institute for Agriculture in Sarajevo and the Agromediterranean Faculty in Mostar.

The aim of the chemical analysis is based on the determination of the nutritive values: % of dry matter (gravimetric technique), % of total sugar (titrimetric determination technique), total acid content (titrimetric technique), pH value (electrochemical determination technique), presence of artificial colors (chromatography methods) and content of vitamin C (oxidation-reduction method).

The microbiological analysis of all three samples included the analysis on *Salmonella* and *Escherichia coli*, *Coagul.pos.Staphilococae*, *Sulph.red. Clostridiae*, Proteus species and total number of bacteria, which was made in accordance with food safety criteria for cut fruits and vegetables.

### **Results and Discussion**

The obtained results of the microbiological analysis for all three samples are shown in Table 1 and compared with the parameters of the rule book Official Gazette of BIH 2/92, thus obtaining the overall picture of the quality of the product in terms of health and hygiene correctness of the product.

Table 1. Microbiological analysis of samples

Parameter	Sample 1	Sample 2	Sample 3
Salmonella types in 25 g (ml)	negative	negative	negative
Coagul.pos.Staphilococae in 0,1 (ml)	negative	negative	negative
Sulph.red. Clostridia in 0,1 g (ml)	negative	negative	negative
Proteus species in 0,1 g (ml)	negative	negative	negative
Escherichia Coli in 0,1 g (ml)	negative	negative	negative
Total number of bacteria in 1 g (ml)	$1,0 \times 10^3$	$5,0 \times 10^2$	$4 \times 10^2$

OPINION: Tested samples do not meet the requirements of the Rulebook on conditions in terms of microbiological correctness which must comply sustaining food (rations) in traffic, due to an increase in the total number of bacteria in 1 g (ml), Official Gazette of BIH 2/92.

The results of the chemical analysis are shown in Table 2:

Table 2. Results of chemical analysis:

Parameter	sample 1	sample 2	sample 3
Dry matter content %	59,10	64,33	63,76
Total sugar content %	57,10	62,05	60,40
Total acidity content %	1,764	1,652	1,652
pH value	3,16	3,06	3,09
Presence of artificial colors	Not present	Not present	Not present
Vitamin „C“ content %	935,66	1046,46	1056,73
Degree of sweetness mg/100g	32,36	37,56	36,56

The dry matter content of all three of these samples was carried out with a drying technique (gravimetric). This method is based on the drying of samples in various types of dryers, under ordinary or reduced pressure to constant mass. In order to ensure proper drying, care must be taken of the preparation of the samples, the temperature and the drying time, the quantity of samples, and so on. The highest dry matter content has a sample number 2. (64.33), while the smallest content has a sample number 1. (59.10). According to the literature (Niketić, Aleksić, 1982) the dry matter content in fruit syrups should be from 65 to 67%, and one can conclude that all three samples are slightly below these values. From the tabular display the content of total sugar in the samples it can be concluded that the sample no. 2 (62.05) has the highest value of sugar content. The smallest sugar content has sample no. 1 (8.5). The highest content of total acidity has sample no. 1 (1,764), while samples no. 2 and no. 3 have the same acidity content (1.652). The obtained pH values are also the highest in sample 1 (3.16), while the other two analyzed samples have approximate values and these are 3.06 and 3.09. From the tabular display it can be concluded that none of analyzed sample contains any artificial colors which is in accordance with the applicable Rule book. Data obtained in terms of vitamin C content are very important, given that its positive effect on human health is known, some literature quotes mention the fact that content vitamin "C" in pomegranate is immediately behind the lemon (Džubur, 1999). The degree of sweetness is the



relationship between sugar and acid and which participates in the final formation of the taste of the juice that should be acceptable for targeted consumers. The value of the degree of sweetness should not be less than 30, otherwise correction should be made in that direction (Niketić, Aleksić, 1982). Based on the above, all three analyzed samples are acceptable for consumption.

Statistical analysis

We used a one-way analysis of variance (ANOVA) and Tukey test to determine the statistical significance, which was not significant in terms of chemical composition

### **Conclusion**

The analysis of the product resulted in the complete picture of the composition and quality of the product, pomegranate juice, domestic product from household cottage industry, in terms of microbiological correctness and chemical composition. Based on the obtained results of the analyzed individual parameters, it is concluded that each of the three analyzed samples has different values. Regarding the microbiological analysis, none of the three tested samples produced in the household cottage industry meets the prescribed values of the Rule book on the conditions in terms of microbiological correctness, which must comply sustaining food in traffic, due to the increased total number of bacteria in 1 gr (ml) – (Official Gazette of BiH 2/92). Increasing the total number of bacteria in the tested samples implies that within the technological line, none of these manufacturers paid attention to the sanitary and hygienic conditions during production, dishes and rooms in which the juice itself is produced. By chemical analysis, we obtained a picture of dry matter, total sugar and total acidity content, pH values, the presence of artificial colors and vitamin C content in the tested samples. Dry matter content was recorded in quite high values, but still slightly lower in all three examined samples compared to the recommended values by literature. In samples of domestic pomegranate juice, high values of total sugars were obtained which, in relation to the obtained content of total acidity, give a satisfactory degree of sweetness over 30, what is acceptable from the aspect of eligibility of the product for consumption. Obtained values of vitamin "C" in each of the tested juice samples, once again gave the seal of approval of functional food in pomegranate in the form of a finished product, i.e. pomegranate juice and confirmed its importance in daily nutrition in terms of positive effect on human health.

### **References**

- Džubur A. (1999), Pomegranate, Agromediterranean faculty, Mostar  
Niketić, Aleksić (1982), Technology of fruit and vegetables , Beograd  
Omanović H., (2008), Technology of fruit processing, Agromediterranean faculty , Mostar  
Trajković J. (1983). Analysis of foodstuffs, Faculty of food technology, Belgrade  
Rulebook on conditions in terms of microbiological safety required for foodstuff on market (Official Gazette of BiH 2/92).  
Rulebook on conditions of usage foodstuff additives in food for human consumption (Official Gazette of BiH 83/08).

## EFFICACY OF NEW HERBICIDES AND HERBICIDE COMBINATIONS ON CORIANDER (*CORIANDRUM SATIVUM* L.)

Grozi DELCHEV<sup>1\*</sup>, Teodora BARAKOVA<sup>2</sup>

<sup>1</sup>\*Trakia University, Faculty of Agriculture, 6000, Stara Zagora, Bulgaria

<sup>2</sup>Field Crops Institute, 6200, Chirpan, Bulgaria

\*Corresponding author: delchevgd@dir.bg

### Abstract

The research was conducted during 2013 - 2015 on pellic vertisol soil type. The subject-matter of this research was Bulgarian coriander cultivar Lozen 1 (*Coriandrum sativum* L.). Factor A included no treated check, 6 soil-applied herbicides – Tender EC (S-metolachlor), Silba SC (metolachlor + terbuthylazine), Sharpen 33 EC (pendimethalin), Merlin flex 480 SC (isoxaflutole), Smerch 24 EC (oxyfluorfen), Raft 400 SC (oxidiargil) and 5 foliarly-applied herbicides – Kalin flo (linuron), Eclipse 70 DWG (metribuzine), Sultan 500 SC (metazachlor), Corrida 75 DWG (tribenuron-methyl), Lontrel 300 EC (clopyralid). Factor B included no treated check and 1 antigraminaceous herbicide – Tiger platinum 5 EC (quizalofop-P-ethyl). Combinations of antigraminaceous herbicide Tiger platinum with soil-applied herbicides Tender, Silba Sharpen, Merlin flex, Smerch and Raft and foliarly-applied herbicides Kalin flo, Eclipse, Sultan, Corrida and Lontrel do not reduce herbicide efficacy. Volunteer durum wheat crops in coriander crops are successfully controlled with the foliarly-applied herbicide Tiger platinum. High yields of coriander seeds are obtained with the foliar treatment with the antigraminaceous herbicide Tiger platinum after soil-applied herbicides Raft, Smerch, Sharpen, Silba and Tender. The tank mixtures of Tiger platinum with foliar herbicides Kalin flo, Eclipse, Sultan, Corrida and Lontrel also lead to high seed yields. The use of the soil-applied herbicide Merlin flex does not increase the seed yield, due to its higher phytotoxicity against coriander. Sole use of soil-applied or foliarly-applied herbicides leads to lower yields due to the fact they must be combined for full control of weeds in coriander crops.

**Key words:** *Coriander, Herbicides, Efficacy, Selectivity, Seed yield*

### Introduction

During the last years coriander significantly increased its area and became the sixth culture in Bulgaria, after only of wheat, sunflower, maize, canola and barley. In our country the best predecessors for coriander are winter cereals. Cereal volunteers along with graminaceous weeds are a serious problem in coriander fields (Delchev and Georgiev, 2015a,b).

The weeds occurring in coriander crops of are mainly from the group of the winter-spring species and from the group of early spring species (Delchev, 2015). The most frequent winter-spring weeds are: *Alopecurus myosuroides* L., *Apera spica-venti* P.B., *Bromus arvensis* L., *Avena ludoviciana* Durien., *Lolium multiflorum* L., *Anthemis arvensis* L., *Chamomilla recutita* Rauchert, *Consolida regalis* Gray, *Viola tricolor* L., *Lithospermum arvense* L., *Centaurea cyanus* L., *Papaver rhoes* L., *Agrostemma githago* L. The most frequent early spring weeds are: *Avena fatua* L., *Galium aparine* L., *Sinapis arvensis* L., *Falopia convolvulus* Leve, *Myagrurn perfoliatum* L. et al. (Atanasova and Gospodinov, 2005; Atanasova et al., 2012).

Biological peculiarity of coriander is its slow growth rates in the first stages and therefore it is highly vulnerable to the competitive impact of weeds at the beginning of its vegetation and weed infestation significantly (Vaculik, 2007). Effective weed control is one the important conditions for full realization of the biological potential of culture (Mathukia et al., 2014). The purpose of this investigation was to establish the efficacy and selectivity of some herbicides, herbicide combinations and herbicide tank mixtures on the coriander by influence of different meteorological conditions.

### Materials and methods

The research was conducted during 2013 - 2015 on pellic vertisol soil type. Under investigation was Bulgarian coriander cultivar Lozen 1 (*Coriandrum sativum* L.). Two factors experiment was conducted under the block method, in 4 repetitions; the size of the crop plot was 15 m<sup>2</sup>. Factor A included no treated check, 6 soil-applied herbicides – Tendar EC, Silba SC, Sharpen 33 EC, Merlin flex 480 SC, Smerch 24 EC, Raft 400 SC and 5 foliar-applied herbicides – Kalin flo, Eclipse 70 DWG, Sultan 500 SC, Corrida 75 DWG, Lontrel 300 EC. Factor B included no treated check and 1 antigraminaceous herbicide – Tiger platinum 5 EC. Active substances of herbicides and their doses are shown in Table 1.

Table 1. Investigated variants.

№	Variants	Active substance	Doses	Treatment period
Antibroadleaved herbicides				
1	Check	-	-	-
2	Tendar EC	S-metolachlor	1.5 l/ha	ASBE
3	Silba SC	metolachlor + terbuthylazine	3.5 l/ha	ASBE
4	Sharpen 33 EC	pendimethalin	5 l/ha	ASBE
5	Merlin flex 480 SC	isoxaflutole	420 g/ha	ASBE
6	Smerch 24 EC	oxyfluorfen	1 l/ha	ASBE
7	Raft 400 SC	oxidiargil	1 l/ha	ASBE
8	Kalin flo	linuron	2 l/ha	rosette
9	Eclipse 70 DWG	metribuzine	500 g/ha	rosette
10	Sultan 500 SC	metazachlor	2 l/ha	rosette
11	Corrida 75 DWG	tribenuron-methyl	20 g/ha	rosette
12	Lontrel 300 EC	clopyralid	500 ml/ha	rosette
Antigraminaceous herbicides				
1	Check	-	-	-
2	Tiger platinum 5 EC	quizalofop-P-ethyl	2.5 l/ha	rosette
ASBE – after sowing, before emergence				

The soil-applied herbicides were used in the period between sowing and emergence. The foliar-applied herbicides used at the rosette stage of the coriander. Introduction of herbicide combinations during rosette stage is done as herbicide tank mixtures – the mixing is done in the spray tank. All of the herbicides, herbicide combinations and herbicide tank-mixtures were applied in a working solution of 200 l/ha. Mixing of the foliar-applied herbicides was done in the tank on the sprayer. It was investigated efficacy and selectivity of herbicides and their tank mixtures. It was established their influence on seed yield. Efficacy of herbicides against weeds was appointed according to 100 % scale of EWRS (European Weed Research Society). Selectivity of herbicides to coriander plants was followed according to the 9-rate scale of EWRS (rating 1 - without damages, rating 9 - crop is completely destroyed). The mathematical processing is done with analysis of variance method.

## Results and discussion

Annual broadleaved weeds in the experiment are represented by *Anthemis arvensis* L., *Chamomilla recutita* Rauchert, *Galium aparine* L., *Sinapis arvensis* L., *Raphanus raphanistrum* L., *Capsella bursa-pastoris* L., *Falopia convolvulus* Leve, *Lithospermum arvense* L., *Papaver rhoes* L., *Consolida regalis* Gray, *Viola tricolor* L., *Myagrurn perfoliatum* L., *Lamium purpureum* L., *Veronica hederifolia* L., *Stellaria media* Cyr. Annual graminaceous weeds are *Avena fatua* L., *Avena ludoviciana* Durien., *Alopecurus myosuroides* L., *Apera spica-venti* P.B., *Lolium temulentum* L., *Lolium multiflorum* L., *Bromus arvensis* L. Perennial broadleaved weeds are *Cirsium arvense* Scop., *Convolvulus arvensis* L., also single plants of *Cardaria draba* L. and *Sonchus arvensis* L. Perennial graminaceous weeds are represented by *Sorghum helepense* Pers., *Cynodon dactylon* Pers. and more rarely *Agropyrum repens* L. Volunteers are represented by durum wheat (*Triticum durum* Desf.), was grown as predecessor. Soil-applied herbicides Tendar, Silba, Sharpen, Merlin flex, Smerch and Raft applied in autumn, during the period after sowing before germination of coriander, are inefficacy against *Cirsium arvense* Scop., *Convolvulus arvensis* L., *Cardaria draba* L. and *Sonchus arvensis* L., because these perennial broadleaved weeds germinate in spring (Table 2). Foliar-applied herbicides Kalin flo, Eclipse and Sultan applied in spring, during the rosette stage of coriander, are also inefficacy against perennial broadleaved weeds *Cirsium arvense* Scop., *Convolvulus arvensis* L. and *Sonchus arvensis* L. Foliar-applied herbicides Corrida and Lontrel are inefficacy only against *Convolvulus arvensis* L., because this perennial broadleaved weed germinate later, after treatment with the herbicides.

Table 2. Efficacy of some herbicides against broadleaved weeds at coriander according to the 100 % visual scale of EWRS (mean 2013 - 2015).

Herbicides		Weeds	<i>Galium aparine</i>	<i>Chamomilla recutita</i>	<i>Papaver rhoes</i>	<i>Sinapis arvensis</i>	<i>Raphanus raphanistrum</i>	<i>Anthemis arvensis</i>	<i>Capsella bursa-pastoris</i>	<i>Cirsium arvense</i>	<i>Convolvulus arvensis</i>
Antibroadleaved	Antigraminaceous										
-	-	0	0	0	0	0	0	0	0	0	0
	Tiger platinum – 2.5 l/ha	0	0	0	0	0	0	0	0	0	0
Tendar – 1.5 l/ha	-	85	100	90	90	90	95	100	0	0	0
	Tiger platinum – 2.5 l/ha	85	100	90	90	90	95	100	0	0	0
Silba – 3.5 l/ha	-	85	100	100	100	100	100	100	0	0	0
	Tiger platinum – 2.5 l/ha	100	100	100	100	100	100	100	0	0	0
Sharpen – 5 l/ha	-	100	100	100	100	100	100	100	0	0	0
	Tiger platinum – 2.5 l/ha	100	100	100	100	100	100	100	0	0	0
Merlin flex – 420 g/ha	-	100	100	100	100	100	100	100	0	0	0
	Tiger platinum – 2.5 l/ha	100	100	100	100	100	100	100	0	0	0
Smerch – 1 l/ha	-	100	100	100	100	100	100	100	0	0	0
	Tiger platinum – 2.5 l/ha	100	100	100	100	100	100	100	0	0	0
Raft – 1 l/ha	-	100	100	100	100	100	100	100	0	0	0
	Tiger platinum – 2.5 l/ha	100	100	100	100	100	100	100	0	0	0
Kalin flo – 2 l/ha	-	40	100	100	100	100	100	100	0	0	0
	Tiger platinum – 2.5 l/ha	40	100	100	100	100	100	100	0	0	0
Eclipse – 500 g/ha	-	15	100	100	100	100	100	100	0	0	0
	Tiger platinum – 2.5 l/ha	15	100	100	100	100	100	100	0	0	0
Sultan – 2 l/ha	-	85	100	100	0	0	100	100	0	0	0
	Tiger platinum – 2.5 l/ha	85	100	100	0	0	100	100	0	0	0
Corrida – 20 g/ha	-	45	100	100	100	100	100	100	100	0	0
	Tiger platinum – 2.5 l/ha	45	100	100	100	100	100	100	100	0	0
Lontrel – 500 ml/ha	-	100	100	100	0	0	100	100	100	0	0
	Tiger platinum – 2.5 l/ha	100	100	100	0	0	100	100	100	0	0

Herbicide Tendar has the weakest efficacy against annual broadleaved weeds. It controls of 100 % only *Chamomilla recutita* Rauchert, and *Capsella bursa-pastoris* L. Tendar controls of 85 – 95 % weeds as *Galium aparine* L., *Papaver rhoes* L., *Sinapis arvensis* L., *Raphanus raphanistrum* L., *Anthemis arvensis* L. Herbicide Silba has weaker efficacy of 85 % only against *Galium aparine* L. Other four soil-applied herbicides - Sharpen, Merlin flex, Smerch and Raft have 100 % efficacy against all annual broadleaved weeds, which are represented in the experiment. Foliar-applied herbicides Kalin flo, Eclipse and Corrida are weaker efficacy against *Galium aparine* L. They control this weed from 15 % at Eclipse to 45 % at Corrida. Herbicide Sultan is inefficacy against *Sinapis arvensis* L. and *Raphanus raphanistrum* L. and has weaker efficacy against *Galium aparine* L. and *Anthemis arvensis* L. Herbicide Lontrel is inefficacy only against *Sinapis arvensis* L. and *Raphanus raphanistrum* L.

Soil-applied herbicides Tendar and Silba are inefficacy against annual graminaceous weeds *Bromus arvensis* L., *Avena fatua* L., *Avena ludoviciana* Durien. and against perennial graminaceous weeds *Sorghum helepense* Pers. and *Cynodon dactylon* Pers. (Table 3). They have weak efficacy of 40 % against volunteers of durum wheat (*Triticum durum* Desf.). Herbicides Merlin flex and Raft are efficacy against all annual graminaceous weeds except *Bromus arvensis* L. Herbicides Sarpen are efficacy against all annual graminaceous weeds except *Bromus arvensis* L. and volunteers of *Triticum durum* Desf. Herbicides Smerch, Kalin flo, Corrida and Lontrel are inefficacy against all annual and perennial graminaceous weeds and volunteers of durum wheat. Herbicides Tendar, Silba, Sharpen, Merlin flex and Raft are efficacy against *Sorghum helepense* Pers. by seeds, but are inefficacy against *Sorghum helepense* Pers. by rhizomes. Herbicide Sultan has sufficient efficacy against annual graminaceous weeds and volunteers of durum wheat but it is not efficacy against perennial graminaceous weeds. Herbicide Eclipse has antigraminaceous effect only against *Alopecurus myosuroides* L.

Table 3. Efficacy of some herbicides against graminaceous weeds and volunteers at coriander according to the 100 % visual scale of EWRS and selectivity according to the 9-rate scale of EWRS (mean 2013 - 2015).

Herbicides		Weeds	<i>Avena fatua</i>	<i>Avena ludoviciana</i>	<i>Alopecurus myosuroides</i>	<i>Apera spica-venti</i>	<i>Bromus arvensis</i>	<i>Triticum durum</i> *	<i>Sorghum helepense</i>	<i>Cynodon dactylon</i>	Selectivity
Antibroadleaved	Antigraminaceous										
-	-	0	0	0	0	0	0	0	0	0	1
	Tiger platinum – 2.5 l/ha	100	100	100	100	100	100	100	100	100	1
Tendar – 1.5 l/ha	-	0	0	100	100	100	0	40	(50)	0	1
	Tiger platinum – 2.5 l/ha	100	100	100	100	100	100	100	100	100	1
Silba – 3.5 l/ha	-	0	0	100	100	100	0	40	(50)	0	1
	Tiger platinum – 2.5 l/ha	100	100	100	100	100	100	100	100	100	1
Sharpen – 5 l/ha	-	100	100	100	100	100	0	0	(50)	0	1
	Tiger platinum – 2.5 l/ha	100	100	100	100	100	100	100	100	100	1
Merlin flex – 420 g/ha	-	100	100	100	100	100	0	100	(50)	0	2
	Tiger platinum – 2.5 l/ha	100	100	100	100	100	100	100	100	100	2
Smerch – 1 l/ha	-	0	0	0	0	0	0	0	0	0	1
	Tiger platinum – 2.5 l/ha	100	100	100	100	100	100	100	100	100	1
Raft – 1 l/ha	-	100	100	100	100	100	0	100	(50)	0	1
	Tiger platinum – 2.5 l/ha	100	100	100	100	100	100	100	100	100	1
Kalin flo – 2 l/ha	-	0	0	0	0	0	0	0	0	0	1
	Tiger platinum – 2.5 l/ha	100	100	100	100	100	100	100	100	100	1
Eclipse – 500 g/ha	-	0	0	100	0	0	0	0	0	0	1
	Tiger platinum – 2.5 l/ha	100	100	100	100	100	100	100	100	100	1
Sultan – 2 l/ha	-	100	100	100	100	100	100	100	0	0	1
	Tiger platinum – 2.5 l/ha	100	100	100	100	100	100	100	100	100	1
Corrida –	-	0	0	0	0	0	0	0	0	0	1

20 g/ha	Tiger platinum – 2.5 l/ha	100	100	100	100	100	100	100	100	1
Lontrel – 500 ml/ha	-	0	0	0	0	0	0	0	0	1
	Tiger platinum – 2.5 l/ha	100	100	100	100	100	100	100	100	1
*- volunteers of durum wheat ( <i>Triticum durum</i> Desf.)										
(50) – against <i>Sorghum helepense</i> Pers. from seeds only, without <i>Sorghum helepense</i> Pers. from rhizomes										

Annual graminaceous weeds are *Avena fatua* L., *Avena ludoviciana* Durien., *Alopecurus myosuroides* L., *Apera spica-venti* P.B., *Lolium temulentum* L., *Lolium multiflorum* L., *Bromus arvensis* L., Perennial graminaceous weeds *Sorghum helepense* Pers., *Cynodon dactylon* Pers. and *Agropyrum repens* L., as well as volunteers of *Triticum durum* Desf. are controlled successfully by foliar-applied antigraminaceous herbicide Tiger platinum.

Combinations of Tiger platinum with soil-applied herbicides Tendar, Silba, Sharpen, Merlin flex, Smerch and Raft and with foliar-applied herbicides Kalin flo, Eclipse, Sultan, Corrida and Lontrel do not reduce herbicide efficacy. From those herbicides included in the experiment only the use of soil-applied herbicide Merlin flex and herbicide combination Merlin flex + Tiger platinum leads to phytotoxicity on coriander - rating 2 by scale of EWRS (Table 3). Signs of phytotoxicity overcome difficult from coriander plants and lead to decrease of seed yield. Soil-applied herbicides Tendar, Silba, Sharpen, Smerch and Raft and foliar-applied herbicides Kalin flo, Eclipse, Sultan, Corrida, Lontrel and Tiger platinum have high selectivity - rating 1 by scale of EWRS. It was found that the lowest seed yields are obtained by alone application of herbicide Merlin flex, followed by the untreated control (Table 4). The use of soil-applied herbicide Merlin flex do not increases seed yield despite its very good herbicidal effect against both graminaceous and broadleaved weeds. The reason for this is its higher phytotoxicity against coriander.

Table 4. Influence of some herbicide combinations on seed yield of coriander (2013 - 2015).

Herbicides		2013		2014		2015		Mean	
Antibroadleaved	Antigraminaceous	kg/ha	%	kg/ha	%	kg/ha	%	kg/ha	%
-	-	2150	100	2333	100	2060	100	2181	100
	Tiger platinum	2227	103.6	2433	104.3	2142	104.0	2267	103.9
Tendar	-	2288	106.4	2492	106.8	2182	105.9	2321	106.4
	Tiger platinum	2417	112.4	2678	114.8	2348	114.0	2481	113.8
Silba	-	2288	106.4	2499	107.1	2188	106.2	2325	106.6
	Tiger platinum	2423	112.7	2685	115.1	2348	114.0	2485	113.9
Sharpen	-	2333	108.5	2550	109.3	2245	109.0	2376	108.9
	Tiger platinum	2526	117.5	2753	118.0	2408	116.9	2562	117.5
Merlin flex	-	2008	93.4	2240	96.0	1840	89.3	2029	93.0
	Tiger platinum	2176	101.2	2384	102.2	2017	97.9	2192	100.5
Smerch	-	2311	107.5	2522	108.1	2227	108.1	2353	107.9
	Tiger platinum	2498	116.2	2734	117.2	2396	116.3	2543	116.6
Raft	-	2356	109.6	2563	110.7	2250	109.2	2390	109.6
	Tiger platinum	2537	118.0	2767	118.6	2433	118.1	2579	118.2
Kalin flo	-	2376	110.5	2592	111.1	2268	110.1	2412	110.6
	Tiger platinum	2537	118.0	2755	118.1	2414	117.2	2569	117.8
Eclipse	-	2301	107.0	2522	108.1	2217	107.6	2347	107.6
	Tiger platinum	2481	115.4	2702	115.8	2385	115.8	2523	115.7
Sultan	-	2301	106.0	2508	107.5	2200	106.8	2336	107.1
	Tiger platinum	2473	115.0	2690	115.3	2377	115.4	2513	115.2
Corrida	-	2270	105.6	2492	106.8	2184	106.0	2315	106.1
	Tiger platinum	2457	114.3	2685	115.1	2369	115.0	2504	114.8
Lontrel	-	2258	105.0	2473	106.0	2167	105.2	2299	105.4
	Tiger platinum	2451	114.0	2676	114.7	2365	114.8	2497	114.5
LSD 5 %		80	3.7	85	3.6	79	3.8		
LSD 1 %		104	4.8	110	4.7	100	4.7		
LSD 0.1 %		133	6.2	147	6.3	128	6.2		

Foliar-applied herbicides Kalin flo, Eclipse, Sultan, Corrida and Lontrel and alone application of soil-applied herbicides Tendar, Silba, Sharpen, Smerch and Raft increases seed yields because the big numbers of weeds are destroyed by these herbicides. The increases of the yield by alone application of antigraminaceous herbicide Tiger platinum is less than the increase by other herbicides, because prevailing weeds in the trail are broadleaved. Foliar treatment with Tiger platinum after soil-applied herbicides Tendar, Silba, Sharpen, Smerch and Raft increases the seed yields during the three years of the investigation. Tank mixtures of Tiger platinum with herbicides Kalin flo, Eclipse, Sultan, Corrida and Lontrel also lead to bigger increase in seed yields compared to yield at alone application of respective herbicides. Herbicide combination Merlin flex + Tiger platinum increases seed yield compared to alone application of Merlin flex, but not proven increase yield compared to no treated control.

### **Conclusions**

Combinations of antigraminaceous herbicide Tiger platinum with soil-applied herbicides Tender, Silba Sharpen, Merlin flex, Smerch and Raft and foliarly-applied herbicides Kalin flo, Eclipse, Sultan, Corrida and Lontrel do not reduce herbicide efficacy. Volunteer durum wheat crops in coriander crops are successfully controlled with the foliar-applied herbicide Tiger platinum. High yields of coriander seeds are obtained with the foliar treatment with the antigraminaceous herbicide Tiger platinum after soil-applied herbicides Raft, Smerch, Sharpen, Silba and Tender. The tank mixtures of Tiger platinum with foliar herbicides Kalin flo, Eclipse, Sultan, Corrida and Lontrel also lead to high seed yields. The use of the soil-applied herbicide Merlin flex does not increase the seed yield, due to its higher phytotoxicity against coriander. Sole use of soil-applied or foliar-applied herbicides leads to lower yields due to the fact they must be combined for full control of weeds in coriander crops.

### **References**

- Atanasova, D., Gospodinov, G. (2005). Studies on herbicides for weed control in coriander (*Coriandrum sativum* L.). Balkan Conference. Breeding and farming practices on field crops, Karnobat, Part II, 540-542.
- Atanasova, D., Maneva, V., Dacheva, S. (2012). Phytosanitary Monitoring of Coriander Crops in South-East Bulgaria. *Plant Science*, 49 (2) 36-40.
- Delchev, Gr. (2015). Studies on the chemical control of weeds and volunteers at five field crops - durum wheat (*Triticum durum* Desf.), winter oilseed canola (*Brassica napus* L.), oil-bearing sunflower (*Helianthus annuus* L.), grain maize (*Zea mays* L.) and grain sorghum (*Sorghum bicolor* Moench.), Habilitation monograph, Stara Zagora, Bulgaria.
- Delchev, Gr., Georgiev, M. (2015). Achievements and problems in the weed control in oilseed canola (*Brassica napus* L.). *Scientific Papers. Series A. Agronomy*, Vol. LVIII, 174-180.
- Delchev, Gr., Georgiev, M. (2015). Achievements and problems in the weed control in common wheat (*Triticum aestivum* L.) and durum wheat (*Triticum durum* Desf.). *Agricultural Science and Technology*, 7 (3) 281-286.
- Mathukia, R., Sagarka, B. Panara, D. (2014). Efficient and Economical Weed Management in coriander (*Coriandrum sativum* L.). *Journal of Crop Science and Technology*, 3 (3) 30-33.
- Vaculík, A. (2007). The influence of the herbicides treatment on the yield and essential oil content of spice plants growth in the Czech Republic. Dissertation thesis. Brno, Czech Republic.

## INSECTICIDES FOR THE CONTROL TOBACCO THRIPS (*THRIPS TABACI* LIND.) OF THE COTTON

Stefan RASHEV<sup>1\*</sup>, Yanko DIMITROV<sup>2</sup>, Nedyalka PALAGACHEVA<sup>2</sup>

<sup>1</sup>Field Crops Institute, 6200 Chirpan, Bulgaria

<sup>2</sup>Agrarian University, 4000 Plovdiv, Bulgaria

\*Corresponding author: rashev1963@abv. bg

### Abstract

During 2014-2015, a field experiment has been carried out in the Field crops institute - Chirpan (Bulgaria) in conditions of naturally infected cotton with tobacco thrips (*Thrips tabaci* Lind.) including 4 replications of 10 m<sup>2</sup> for each variant. We investigated insecticides Danadim progress 400 EC (Dimethoate), Sumi alfa 5 EC (Esfenvalerat), Pirinecs 48 EC (Chlorpirifosetil), Deccis 2.5 EC (Deltamethrin), Mospilan 20 SP (Acetamiprid), Lannat 25 WG (Methomyl) and Cohinor 200 SL (Imidacloprid). For successful leading the fight against tobacco thrips, the insecticides that can be used are: Mospilan 20 SP at a dose of 15 g/da, Cohinor 200 SL at a dose of 60 ml/da, Danadim progress 400 EC at a dose of 200 ml/da, Sumi alfa 5 EC at a dose of 50 ml/da, Pirinecs 48 EC at a dose of 100 ml/da, Deccis 2.5 EC at a dose of 50 ml/da and Lannat 25 VG at a dose of 100 g/da. The best duration was observed (within the fourteenth day after the treatment) in the neonicotinoid insecticides Mospilan 20 SP and Cohinor 200 SL. The insecticides Danadim progress 400 EC, Sumi alfa 5 EC, Pirinecs 48 EC, Deccis 2.5 EC and Lannat 25 VG retain their efficacy until the 7<sup>th</sup> day after the treatment.

**Key words:** Cotton, insecticides, Tobacco thrips, efficacy.

### Introduction

Tobacco thrips (*Thrips tabaci* Lind.) are polyphagous and attacks over 300 plant species (Straub *et al.*, 1992).

In many countries such as Spain, India, Turkey, Israel and Pakistan, tobacco thrips are also reported to be an important pest in cotton (Aston and Winfeld, 1972; Klein *et al.*, 1986; Williams, 2006; Khan, 2011; Anonymous, 2013; Din *et al.*, 2015). It feeds on the various weeds (*Sinapis arvensis* L., *Capsella bursa-pastoris* Medic, *Cirsium arvense* Scop, *Chenopodium album* L.) and cultured plants (tobacco - *Nicotiana tabacum* L., sunflower - *Heliantus annuus* L., onion - *Allium cepa* L., *Cucurbita* spp.). Tobacco thrips occurs on cotton plants throughout the growing season, but a critical period in the development of cotton is from emergence to buttoning (Radev, 1967; Radev, Stefanov, 1976; Rashev, 2012), causing the juveniles and the larvae to suck juice from the leaves and the vegetation peak, very often causing deformation of the young leaves and appearance of silver stains. Damaged leaves are curled or deformed, become stiffer and tear apart as if they were beaten by hail (Radev, Stefanov, 1976; Atakan *et al.*, 1996). As an enemy whose numbers are difficult to control by useful species, it is necessary to carry out 2-3 chemical treatments every year (Stefanov, Dimitrov, 1986). For control, insecticides of various chemical groups are approved: phosphorus compounds (dimethoate and chlorpyrifosetil) which inhibit the activity of cholinesterase that degrades the acetylcholine of choline and acetic acid; synthetic pyrethroids (esfenvalerate and deltamethrin) that disrupt sodium-potassium conduction in axon membranes and gamma-aminobutyric acid suppression; carbamate insecticides (methomyl)



that block the ester and anionic sites of the enzyme acetylcholinesterase and neonicotinoids (acetamiprid and imidacloprid) that bind to the postsynaptic nicotinic acetylcholine receptors of the central nervous system and attack the  $Cl^+$  channels. The long-term use of these compounds for the control of tobacco thrips not only in cotton, but also in other crop plants, has resulted in its mass multiplication and spread in the country due to the low efficacy of chemical control. Many authors Zielbermintz *et al.* (1979), Zilbermintz and Zhuravleva (1990), Grafton-Cardwell (1991), Grossman (1994), Hollingsworth *et al.* (1997), Kerns *et al.* (1998), Denholm *et al.* (1999), Godfrey and Fuson (2001), Shelton *et al.* (2006) on the basis of efficacy and their change in the fight against tobacco thrips establish resistance and the possibility of overcoming it by using chemical compounds with different mechanisms of action. In regard to this, the aim of this study is to review the use of chemical preparations for the control of tobacco thrips in order to establish the emergence of resistance and the possibility of overcoming.

### **Material and Methods**

During 2014-2015 in the Field crops institute - Chirpan (Bulgaria), a polish experiment was conducted in conditions of naturally infected cotton areas with tobacco thrips in 4 repetitions of 10 m<sup>2</sup> for each variant. In the experiment, the following insecticides were included: Danadim progress 400 EC (dimethoate 400 g/l), Sumi alpha 5 EC (esfenvalerate 50 g/l), Pirinex 48 EC (chlorpyrifosetil 480 g/l), Mospilan 20 SP (acetamiprid 200 g/kg), Lannat 25 WG (methomyl 250 g/kg) and Cohinor 200 SL (imidacloprid 200 g/l). The control was treatment with water. The initial density of the tobacco thrips is determined before treatments. The efficacy of the formulations for each variant was calculated using the Henderson-Tilton formula. After the 1st, 3rd, 7th and 14th day, the remaining living individuals in the variants and control are also counted. From each variant, 100 plants are taken and by the strapping method the available insect's adults and larvae are counted.

### **Results and Discussion**

All tested insecticides on the first day after treatment showed a high efficacy against tobacco thrips reaching 99-100%, which dramatically reduced its population (Table 1). In the preparations with a clear contact action: Danadim progress 400 EC (Dimethoate), Pirinex 48 EC (Chlorpyrifosetil), Sumi alpha 5 EC (Esfenvalerate), Decis 2.5 EC (Deltamethrin) and Lannat 25 WG (methomyl), efficacy decreases after the seventh day, ranges from 65-79%. While the systemic action of insecticides Mospilan 20 SP (acetamiprid) and Cohinor 200 SL (imidacloprid) remains high (90%) until the fourteenth day after treatment, which provides protection for cotton for a period of time which in contact insecticides to be achieved through two treatments.

Table 1. Efficacy of insecticides against tobacco thrips (*T. tabaci*) in 2014

Variants/ Dose	Number of the live thrips	Days after spraying, efficacy							
		1 <sup>st</sup> day		3 <sup>rd</sup> day		7 <sup>th</sup> day		14 <sup>th</sup> day	
		Number of live	E %	Number of live	E %	Number of live	E %	Number of live	E %
Dimethoate Danadim progress 400 EC - 200 ml/da	165	2	99	17	90	26	84	72	60
Esfenvalerat Sumi alfa 5 EC - 50 ml/da	136	0	100	5	96	15	89	65	56
Chlorpirifosetil Pirinecs 48 EC - 100 ml/da	135	0	100	4	97	11	92	42	71
Deltamethrin Deccis 2.5 EC - 50 ml/da	160	0	100	6	96	17	89	73	58
Acetamiprid Mospilan 20 SP – 15 g/da	158	0	100	2	99	3	98	17	90
Methomyl Lannat 25 WG - 100 g/da	172	2	99	4	98	16	91	44	74
Imidacloprid Cohinor 200 SL - 60 ml/da	185	0	100	2	99	4	98	19	90
Control	195	234		201		193		211	

Similar results are available in 2015, confirming the possibility of maintaining a low population of tobacco thrips by contacting insecticides at a range of 7 days and 14 days in systemic insecticides.

The obtained results show high efficacy of all applied insecticides. The lack of resistance and their limited use during vegetation has led to the maintenance of registered efficacy.

Table 2. Efficacy of insecticides against tobacco thrips (*T. tabaci*) in 2015

Variants/ Dose	Number of the live thrips	Days after spraying, efficacy							
		1 <sup>st</sup> day		3 <sup>rd</sup> day		7 <sup>th</sup> day		14 <sup>th</sup> day	
		Number of live	E %	Number of live	E %	Number of live	E %	Number of live	E %
Dimethoate Danadim progress 400 EC - 200 ml/da	204	2	99	10	96	38	89	95	74
Esfenvalerat Sumi alfa 5 EC - 50 ml/da	221	3	99	12	96	35	90	135	65
Chlorpirifosetil Pirinecs 48 EC - 100 ml/da	235	5	98	11	97	28	93	86	79
Deltamethrin Deccis 2.5 EC - 50 ml/da	191	5	99	7	97	26	92	118	65

Acetamiprid Mospilan 20 SP – 15 g/da	254	0	100	4	99	8	98	18	96
Methomyl Lannat 25 WG - 100 g/da	232	3	99	6	98	31	92	98	76
Imidacloprid Cohinor 200 SL - 60 ml/da	231	0	100	3	99	10	97	19	95
Control	233	253		328		385		412	

### Conclusions

As a result of the studies conducted, the following conclusions can be drawn:

As a result of the treatments carried out with the approved insecticide control tobacco thrips (*T. tabaci*), the occurrence of resistance to the different chemical groups has not been established.

The duration of the contact insecticides is 7-8 days, and the system provides efficacy for 14 days.

### References

- Anonymous (2013). Economic survey of Pakistan. Ministry of food, agriculture and livestock. Islamabad, pp. 17-18.
- Aston J.L., Winfield B.. (1972). Insect section introduction, in Ciba-Geigy, Cotton. Technical Monograph, No. 3, pp. 44-45.
- Atakan E., Coll M., Rosen D. (1996). Within-plant distribution of thrips and their predators: effects of cotton variety and developmental stage. Bulletin of Entomological Research (1996) 86, pp. 641-646.
- Denholm, I., Pickett J.A., Devonshire A.L. (1999). Insecticide resistance: from mechanisms to management. Aspects of Applied Biology, № 52, pp. 407-414.
- Din ud, M., Nadeem M.K., Ali M., Waqar M.Q. Ali M.A., Masood N. (2015). Efficacy of some insecticides against cotton thrips (*Thrips tabaci* Lind.) under natural field conditions. Journal of Environmental and Agricultural Sciences, 5, pp. 1-3.
- Grossman J. (1994): Onion thrips. IPM Practitioner 1, pp. 12-13.
- Godfrey L.D., Fuson K.J. (2001). Environmental and host plant effects on insecticide susceptibility of the cotton aphid (Homoptera: Aphididae). Journal of Cotton Science, vol. 5, № 1, pp. 22-29.
- Grafton-Cardwell E.E. (1991). Geographical and temporal variation in response to insecticides in various life stages of *Aphis gossypii* (Homoptera: Aphididae) infesting cotton in California. Journal of Economic Entomology, № 84, pp. 741-749.
- Hollingsworth R.G., Tabashnik B.E., Johnson M.W., Messing R.H., Ullman D.E. (1997). Relationship between susceptibility to insecticides and fecundity cross populations of cotton aphid (Homoptera: Aphididae). Journal of Economic Entomology, vol. 90, № 1, pp. 55-58.
- Kerns D.L., Palumbo J.C., Byrne D.N. (1998). Relative susceptibility of red and green color forms of green peach aphid to insecticides, Southwest. Entomology, vol. 23, № 1, pp. 17-24.
- Khan A.S., A. Suhail, Z.A. Zaffar, 1987. Comparative efficacy of some pyrethroids and organophosphate insecticides for the control of insect pests of cotton, Pak. Entomol., 9(1-2), pp. 57-60.
- Khan S.M. (2011). Arietal performance and chemical control used as tactics against sucking insect pests of cotton. Sarhad J. Agric. Vol.27, No.2, pp. 2011.

- Klein M.A., Franck A., Rimon D. (1986). Proliferation and branching of cotton seedlings, the suspected cause Thrips tabaci, the influence on yield and tests to reduce damage. *Phytoparasitica* 14, pp. 25-31.
- Radev R. (1967). Cotton leaf aphid ( *Aphis gossypii* Glov., Homoptera; Aphididae ) in Bulgaria and the fight against it. Abstract, Plovdiv.
- Radev R., Stefanov St. (1976). In: Breeding and agrotechnics of cotton and durum wheat.
- Rashev St. (2012). *Aphis gossypii* Glover (Hemiptera; Aphididae) – pest of the cotton. Abstract of a thesis for the award of educational and scientific degree "Doctor". Chirpan.
- Shelton A.M., Zhao J.Z., Nault B.A., Plate J., Musser F.R., Larentzaki E. (2006). Patterns of insecticide resistance in onion thrips (Thysanoptera: Thripidae) in onion fields in New York. *J. Econ. Entomol.* 99, pp. 1798–1804.
- Stefanov St., Dimitrov, Y. (1986). *Plant science*, № 5, pp. 72-75.
- Straub R.W., Emmett B. Pests of Monocotyledon Crops. In: Mc Kinlay R.G. (Editor). (1992). *Vegetable Crop Pests*. Macmillan Press. U. K., pp. 213-262.
- Zilbermints I.V., Smirnovoi A.A., Matova G.N. (1979). Resistance to pests of crop protection chemicals. *Proceedings of Agricultural Sciences*. Publishing House "Kolos". Moscow, pp. 136.
- Zilbermints I.V., Zhuravleva, L.M. (1990). Prevention of the development of resistance. *Zashchita Rastanii Moskva*, № 1, pp. 26-27.
- Williams M.R. (2006). Cotton loss estimates-2005. San Antonio, TX. January 3-6, 2006. In *Proc. Beltwide Cotton Conf., National Cotton Council, Memphis, TN*. pp. 1135-1150.

## THE EFFECT OF ORGANIC AMENDMENTS ON UPTAKE OF HEAVY METALS IN MAIZE (*ZEA MAYS L.*)

Violina ANGELOVA\*, Krasimir IVANOV

Department of Chemistry, Agricultural University-Plovdiv, Bulgaria

\*Corresponding author: vileriz@abv.bg

### Abstract

The experiment was performed on an agricultural field contaminated by the Non-Ferrous-Metal Works near Plovdiv, Bulgaria. The field experimental was a randomized complete block design containing five treatments and four replications (20 plots). The treatments consisted of a control (no organic amendments), compost amendments (added at 2 t/ha and 4 t/ha), and vermicompost amendments (added at 2 t/ha and 4 t/ha). Upon reaching commercial ripeness, the maize plants were gathered. Heavy metal contents in roots, stems, leaves and grains of maize were analyzed by the method of the microwave mineralization. To determine the heavy metals in the samples, inductively coupled emission spectrometry (Jobin Yvon Emission - JY 38 S, France) was used. Tested organic amendments significantly influenced the uptake of Pb, Zn and Cd by the roots, stems, leaves and grains of maize. The compost and vermicompost treatments significantly reduced heavy metals concentration in grains but the effect differed among them. The 2 t/ha compost treatment led to decreased heavy metal contents in grains below the regulated limits.

**Keywords:** *Accumulation, Organic amendments, Heavy metals, Maize*

### Introduction

Phytoremediation can be defined as the combined use of plants, soil amendments and agronomic practices to remove pollutants from the environment or to decrease their toxicity (Salt et al., 1998). This technique has many advantages compared with other remediation procedures – low economic costs and the possibility of being applied to soils, causing a minimum environmental impact. As a technology based on the use of plants, the success of phytoremediation will mainly depend on the proper selection of plants. Many researchers examine the rapidly growing, high biomass plants, including agronomic crops for their ability to tolerate and accumulate metals in their shoots. Many metal tolerant plant species, especially wheat plants of the family Gramineae, avoid toxicity through the mechanisms of exclusion and therefore are more suitable for phytostabilization than phytoextraction (Baker et al., (1994). Ebbs and Kochian (1998) established that barley (*Hordeum vulgare L.*) and oats (*Avena sativa L.*) were tolerant to metals such as Cu, Cd, and Zn and accumulated medium to high quantities of them in their tissues. According to Wierzbiska (1999), barley and maize were species with high constitutional tolerance towards Pb, whereas wheat and oats belonged to the group of cultures capable of weak heavy metals accumulation. Opposite results, however, were obtained by Vincenc et al. (1996), which indicated that heavy metals accumulation was most apparent in cereals (maize, oats, rye, wheat, and barley). The addition of organic matter amendments, such as compost, fertilizers, and wastes, is a common practice for immobilization of heavy metals and soil amelioration of contaminated soils (Clemente et al., 2005). The effect of organic matter amendments on heavy metal bioavailability depends on the nature of the organic matter, their microbial degradability, salt content and effects on

soil pH and redox potential, as well as on the particular soil type and metals concerned (Walker et al., 2003). The main objective of this paper is to conduct a systematic study, which will help to determine the impact of organic soil amendments on the uptake of the heavy metals by maize (*Zea mays L.*), as well as the possibilities to use the plant for phytoremediation of heavy metal contaminated soils.

### Material and Methods

The experiment was performed on an agricultural field contaminated by the Non-Ferrous-Metal Works near Plovdiv, Bulgaria. The field experimental was a randomised complete block design containing five treatments and four replications (20 plots): 1 – addition of 2 t/ha of vermicompost to the soil, 2 - addition of 4 t/ha of vermicompost to the soil, 3 - addition of 2 t/ha of compost to the soil, 4 - addition of 4 t/ha of compost to the soil, 5 - control variant. Characteristics of soils and organic amendments are shown in Table 1. The soils used in this experiment were slightly acidic, with moderate content of organic matter and essential nutrients (N, P, and K) (Table 1). The total content of Zn, Pb and Cd is high (1430.7 mg kg<sup>-1</sup> Zn, 876.5 mg kg<sup>-1</sup> Pb and 31.4 mg kg<sup>-1</sup> Cd, respectively) and exceeds the maximum permissible concentrations (320 mg kg<sup>-1</sup> Zn, 100 mg kg<sup>-1</sup> Pb, 2.0 mg kg<sup>-1</sup> Cd).

Table 1. Characterisation of the soil and the organic amendments used in the experiment

Parameter	Soil	Compost	Vermicompost
pH	6.5	6.9	7.5
Organic matter (%)	3.99	72.10	38.58
N Kjeldal (%)	0.24	2.22	1.57
Total P (mg kg <sup>-1</sup> )	642	12654	10211
Total K (mg kg <sup>-1</sup> )	5518	6082	10495
Total Pb (mg kg <sup>-1</sup> )	876.5	12.0	32.3
Total Zn (mg kg <sup>-1</sup> )	1430.7	170.8	270.3
Total Cd (mg kg <sup>-1</sup> )	31.4	0.19	0.69

The test plant was maize (*Zea mays L.*). The maize seeds were sown in each plot at a spacing of 70 cm and a seed density of 4 plants per m<sup>2</sup> and were grown according to conventional technology. Upon reaching commercial ripeness, the maize plants were gathered and the content of heavy metals in their different parts (roots, stems, leaves, and grains) was quantitatively determined. The concentrations of Pb, Zn, and Cd in their different parts of the maize were determined by the method of microwave mineralization. To determine the heavy metal content in the samples, inductively coupled emission spectrometer (Jobin Yvon Emission - JY 38 S, Paris, France) was used.

### Results and Discussion

Accumulation of heavy metals in vegetative and reproductive organs of maize without amendment (control)

Table 2 presents the results obtained for the content of heavy metals in the vegetative and reproductive organs of the study cereal crop. In all three elements, the main part was accumulated in the roots, and which was in conformity with the results of other authors (Fassler et al., 2010). The content of Pb in the roots of maize without amendments reached to 248.4 mg kg<sup>-1</sup>, Zn - 599.2 mg kg<sup>-1</sup> and Cd -18.3 mg kg<sup>-1</sup>. The greater part of the heavy metals, that had entered the soil, are fixed and accumulated in the roots of maize, as maize formed a powerful root system with a strong ability to uptake the nutrients. In penetration in the plazma

inactivation and precipitation of considerable quantities of heavy metals takes place, probably as a result of the formation of little mobile compounds with the organic substance.

Table 2. Content of Pb, Zn and Cd (mg/kg) in maize plants (without amendments)

Element	Roots x±sd	Stems x±sd	Leaves x±sd	Grains x±sd
Pb	248.4±1.5	54.2±0.3	116.9±0.7	0.87±0.05
Zn	599.2±6.5	539.9±6.5	363.5±5.3	41.9±0.1
Cd	18.3±0.5	10.2±0.4	12.7±0.5	0.33±0.05

x- average value(mg kg<sup>-1</sup>) from 5 repetitions; sd - mean standard deviation

The Pb contents in the aboveground parts of the maize were considerably lower compared to those in the root system, which showed that their movement through the conductive system was strongly restricted. However, the Zn and Cd contents in the aboveground parts are higher compared to those in the root system. Our results do not confirm finding the results of Perriguet et al. (2008) and Puertas-Mejía et al. (2010) who found that after absorption by the root, Cd is mainly retained in the roots and a small quantity is translocate to shoot. The content of Pb in the stems of maize without amendments reached to 54.2 mg kg<sup>-1</sup>, Zn – 539.9 mg kg<sup>-1</sup> and Cd – 10.2 mg kg<sup>-1</sup>. The results obtained showed that the heavy metal concentrations in the stems of the maize were within the normal range (below the maximum permissible concentrations) for fodder. Heavy metal content in the leaves was lower compared to that in the root system. The content of Pb in the leaves of maize without amendments reached to 116.9 mg kg<sup>-1</sup>, Zn – 363.5 mg kg<sup>-1</sup>, and Cd – 12.7 mg kg<sup>-1</sup>. Cd and Pb content in the leaves of the maize were below the phytotoxic levels for dry foliage but were at a higher level than the maximum permissible concentrations for fodder (30 mg kg<sup>-1</sup> for Pb and 1 mg kg<sup>-1</sup> for Cd). Zn content in the leaves of the crops was within the range of normal plant foliage (15 - 150 mg kg<sup>-1</sup> Zn) (Hapke, 1991).

The heavy metal content in the grains of the maize was lower in comparison to that in the roots and leaves, which confirmed the results obtained by Fassler et al. (2010). The heavy metal accumulation in maize grains was likely caused by the conductive system. The content of Pb in the grains of maize without amendments reached to 0.87 mg kg<sup>-1</sup>, Zn – 41.9 mg kg<sup>-1</sup>, and Cd – 0.33 mg kg<sup>-1</sup>. The Zn content in the grains of maize was slightly higher than the maximum permissible concentrations (40 mg kg<sup>-1</sup> Zn), whereas the Pb and Cd accumulated in quantities considerably above the proposed guideline value for grains (0.2 mg kg<sup>-1</sup> Pb and 0.2 mg kg<sup>-1</sup> Cd). These results confirm those obtained by Madejon et al. (2002), according to whom cadmium, lead, arsenic, and copper content in grains may reach levels considered toxic for the food-web. Our results do not confirm the results of Wenger et al. (2002) who found that maize seed produced on contaminated land may be suitable for animal feed.

The distribution of the heavy metals in the organs of the studied crops has a selective character that in maize decreases in the following order: roots > leaves > stems > > grains (Fig.1).

#### Organic additives impact

According to the literature, the content of the organic substance in soil has a significant impact on uptake and translocation of heavy metals in soil and their uptake by plants. Zn, Pb, and Cd are adsorbed on organic matter, which generates stable forms and leads to their accumulation in organic horizons of soil and peat (Kabata Pendias, 2001).



Fig.1. Distribution of heavy metals in vegetative and reproductive organs of maize plants

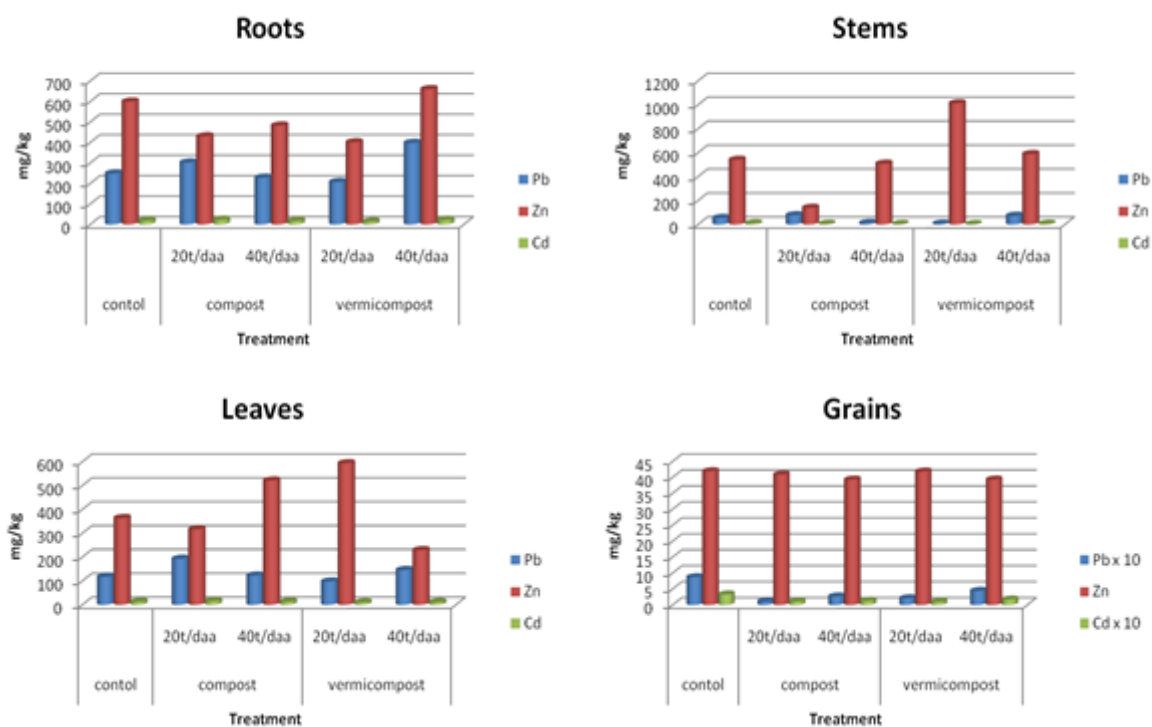


Fig. 2. Effect of the compost and vermicompost treatments on the quantity of Pb, Zn and Cd ( $\text{mg kg}^{-1}$ ) in maize plants

The results for the influence of the organic additives on the accumulation and distribution of Pb, Zn, and Cd in the maize plants are presented in Figure 2. The results obtained by us showed that Pb, Zn, and Cd uptake by maize plants depended on the soil amendments and treatment (type and rate). The application of organic amendments significantly influenced the uptake of Pb, Zn, and Cd by the tested plant. Changes in heavy metals content in maize organs were rather complex. The impact of organic amendments on heavy metals accumulation in organs of maize depended significantly on their quantity. The application of 2 t/ha compost and 4 t/ha vermicompost led to increased Pb content in the roots, stems, and leaves of maize. When the soil was treated with 4 t/ha compost and 2 t/ha vermicompost Pb contents in the roots, stems and leaves of maize decreased (Fig.2). The application of 2 t/ha compost led to increased Cd content in the roots and leaves of maize. When the soil was treated with 4 t/ha compost and 2 t/ha vermicompost Cd contents in the leaves of maize decreased (Fig.2). The addition of 2 t/ha compost and 4 t/ha vermicompost leads to increase of the content of Cd in the roots. The content of Zn in the roots decreases after the addition of compost, as this decrease is more pronounced after the addition of 2 t/ha of compost. The addition of 2 t/ha vermicompost leads to increase of the content of Zn in the stems and leaves. Similar results were obtained by Putwattana et al. (2015) who found that application of cow



manure and rice straw in Cd/Zn-contaminated soil increased maize growth and grain yield, and decreased Cd and Zn uptake by maize. However, heavy metal contents in grains of maize decreased in the plants treated with all amendments used in the experiments. The impact of organic amendments on Pb accumulation in grains of maize depended significantly on their quantity. The application of 2 t/ha compost led to a decrease of the Pb content in grains to 0.11 mg kg<sup>-1</sup> and these concentrations were below the maximum permissible concentrations. When the soil was treated with 4 t/ha compost and 2 t/ha vermicompost Pb content remained practically unchanged (0.21-0.29 mg kg<sup>-1</sup>). When the soil was treated with 4 t/ha vermicompost, Pb concentration slightly increased to 0.44 mg kg<sup>-1</sup>. Cd showed a similar tendency. When the soil was treated with compost Cd content remained practically unchanged (0.11 -0.13 mg kg<sup>-1</sup>). The application of 2 t/ha vermicompost led to a decrease of the Cd content in grains to 0.10 mg/kg. When the soil was treated with 4 t/ha vermicompost, Pb concentration slightly increased to 0.17 mg kg<sup>-1</sup>. Organic amendment addition was especially effective for the reduction of Cd content in grains below maximum permissible concentrations (0.2 mg kg<sup>-1</sup>). When the soil was treated with 2 t/ha compost and 2 t/ha vermicompost, Zn content remained practically unchanged (40.8-41.8 mg kg<sup>-1</sup>). The increase in the quantity of compost and vermicompost (4 t/ha) led to a decrease of Zn content in maize grains to 39.3 mg kg<sup>-1</sup> and these concentrations were slightly lower than maximum permissible concentrations (40 mg kg<sup>-1</sup> Zn). Organic amendments significantly reduced heavy metals concentration in maize grains, but the effect differed among them. Also, there was a dose effect for amendments. 2 t/ha compost addition was especially effective for the reduction of Pb and Cd content in maize grains, (87% and 66%, respectively), the Pb and Cd content were bellowed regulated limits and grains can be used as livestock feed. The possibility to use maize grains for animal feed as well as the stems and leaves for nonfood purposes such as bioenergy production will make maize economically interesting crops for farms, through use of phytoremediation technology.

### **Conclusions**

Based on the results obtained regarding the impact of organic soil amendments on the uptake of the heavy metals by maize, as well as the possibilities to use the plant for phytoremediation, the following conclusions can be made:

The compost and vermicompost treatments significantly reduced heavy metals concentration in maize grains, but the effect differed among them. Also, there was a dose effect for amendments. 2 t/ha compost treatment led to decreased heavy metal content in maize grains bellow the regulated limits and grains can be used as livestock feed. The possible use of grains for animal food will make maize economically interesting crops for farms, through use of phytoremediation technology.

The maize is a crop tolerant to heavy metals and can be grown on the heavy metal polluted soils. Maize plants are characterized by a low capacity to absorb and accumulate Pb, Cd, and Zn, and show no signs of toxicity (chlorosis and necrosis) in the content of 31.4 mg kg<sup>-1</sup> Cd, 876.5 mg kg<sup>-1</sup> Pb and 1430.7 mg kg<sup>-1</sup> Zn in the soil. It can be referred to the group of low accumulators of Pb, Zn, and Cd and can be successfully used for phytoremediation of heavy metal polluted soils.

### **Acknowledgement**

This work is supported by the Bulgarian Ministry of Education, Project DFNI 04/9.

## References

- Baker A.J.M, McGrath S.M., Sidoli C.M.D. (1994). The possibility of in situ heavy metal decontamination of polluted soils using crops of metal-accumulating plants. *Resour Conserv Recycl.*, vol.11, pp. 41–49.
- Clemente R., Walker D.J., Bernal M.P. (2005). Uptake of heavy metals and As by Brassica Juncea grown in a contamination soil in Arnalcollar (Spain): The effect of soil amendments. *Environmental Pollution*, vol.136, pp.46 - 58.
- Ebbs S. D., Kochian V. (1998). Phytoextraction of zinc by oat (*Avena sativa*), barley (*Hordeum vulgare*), and Indian mustard (*Brassica juncea*). *Environmental Science and Technology*, vol.32, pp. 802-806.
- Fassler E, Robinson BH, Gupta SK, Schulin R. (2010). Uptake and allocation of plant nutrients and Cd in maize, sunflower and tobacco growing on contaminated soil and the effect of soil conditioners under field conditions. *Nutrient Cycling in Agroecosystems*, vol.87(3), pp. 339–352.
- Hapke H. J. (1991). Metal accumulation in the food chain and load of feed and food. In Merian, E. (ed.), “Metals and their Compounds in the Environment. Occurrence, Analysis, and Biological Relevance”, Weinheim, New York, NY, USA; pp.469–479.
- Kabata-Pendias A., (2001). Trace Elements in Soils and Plants, Third Edition. CRC Press LLC, Boca Raton.
- Madejon P., Murillo J. M., Marañón T., Cabrera F., López R. (2002). Bioaccumulation of As, Cd, Cu, Fe and Pb in wild grasses affected by the Aznalcóllar mine spill (SW Spain). *Sci. Total Environment*, vol. 290, pp.105–120.
- Perriguet J., Sterckeman T., Morel J. L. (2008). Effect of rhizosphere and plant-related factors on the cadmium uptake by maize (*Zea mays* L.). *Environmental and Experimental Botany*, vol.63, pp. 333–341.
- Puertas-Mejía M. A., Ruiz-Díez B., Fernández-Pascual M. (2010). Effect of cadmium ion excess over cell structure and functioning of *Zea mays* and *Hordeum vulgare*. *Biochemical Systematics and Ecology*, vol.38, pp.285–291
- Putwattana N., Kruatrachue M., Kumsopa A., Pokethitiyook P. (2015). Evaluation of organic and inorganic amendments on maize growth and uptake of Cd and Zn from contaminated paddy soils. *International Journal of Phytoremediation*, vol.17, pp.165–174
- Salt D. E, Smith R.D., Raskin I. (1998). Phytoremediation. *Annual Rev. Plant Physiol. Plant Mol. Biol.*, vol.49, pp.643 –668.
- Vincenc J., Belan F., Adamec V. (1996). Contamination of field crops in the region of Svetle and Sazavou, *Acta Universitatis Agriculturae et Silviculturae Mendelinae Brunensis*, vol. 44, pp.65-71.
- Walker D. J., Clemente R., Roig A., Bernal V. (2003). The effect of soil amendments on heavy metal bioavailability in two contaminated Mediterranean soils. *Environ Pollution*, vol.22, pp. 303 – 312.
- Wenger K., Gupta S.K., Furrer G., Schulin R. (2002). Zinc extraction potential of two common crop plants, *Nicotiana tabacum* and *Zea mays*. *Plant and Soil*, vol. 242 (2), pp. 217–225.
- Wierzbiska M. (1999). Comparison of lead tolerance in *Allium cepa* with other plants, *Environmental pollution*, vol. 104, pp. 41-52.

## KEEPING THE QUALITY AND EXTENDING SHELF-LIFE OF STRAWBERRY FRUITS BY USING ARBIC GUM AS EDIBLE COATING

Mohamad ABD ELHAMED GOMMAA\*, Elsayed AWAD ABDELRASOUL, Maha MAHFOZ GOMMAA

Food Technology Research Institute, Agriculture Center, Kafr Elsheikh, Egypt

\*Corresponding author: abdelrasoul63@yahoo.com

### Abstract

The aim of this study is keeping the quality and expanding shelf-life of strawberries fruits by using Arabic gum as edible coating. We used Arabic gum in aqueous solutions of 5, 10, 15 and 20% was applied as a novel edible coating to gardener-mature strawberries which were stored at 20°C and 80–90% relative humidity (RH) for 10 days. Fruits coatings significantly reduced decay compared to control fruits. A significantly higher weight loss in 5 and 20% Arabic gum coatings was observed compared to 10 and 15% Arabic gum coatings. The maximum firmness was maintained by the 20% Arabic gum treated strawberry fruits until 6 day. The highest decrease in lightness (L\*) was observed in uncoated strawberries followed by 5% coated fruits. The lowest soluble solids (SS) at the end of the storage period was recorded in fruit coated with 20% Arabic gum. The titratable acidity (TA) values of uncoated and coated fruits during storage decreased with storage time. The highest levels of ascorbic acid were observed in control fruits, closely followed by fruits coated with 5% Arabic gum.

**Keywords:** *Strawberries, Shelf-life, Arabic gum, Edible coating.*

### Introduction

According to Food and Agriculture Organization (FAO) of the United Nations, world production of strawberries has exceeded 4 million tons since 2007. In 2010, approximately 28 percent of the total production came from the United States, the largest producer among countries where statistical data are available. Other major strawberry producing countries are Turkey, Spain, Egypt, Korea, Mexico, and Poland. Although Spain, Korea, and Poland still have a high production, the growth has been slow or even negative. For example, Spain's production in 2010 was 275,000 tons, down 12 percent from ten years ago. Korea showed an upward trend, but only grew 14 percent during the same period. In contrast, Turkey, Egypt, and Mexico experienced a high growth in the same period. Production in Egypt increased more than 3 times from 70,000 tons to 240,000 tons, and Turkey's production rose from 130,000 tons to 300,000, becoming the second largest strawberry producer in the world (Bouffard, 2012).

Strawberries are one of the most popular summer fruits worldwide that are characterized with unique and highly desirable taste and flavor. They are rich in polyphenols and anthocyanins, vitamins and amino acids. The main characteristics related to the quality of the ripe strawberries are their texture, flavor (organic acids and soluble sugars content) and color (Campaniello *et al.*, 2008; Koyuncu and Dilmaçunal, 2010). Due to their very active metabolism strawberries are highly perishable and have high physiological postharvest activities which lead to short ripening and senescence periods that make their marketing a challenge (Garcia *et al.*, 1998). Loss of quality in this fruit is connected with its sensitivity to

fungal infection and susceptibility to water loss, bruising, mechanical injuries and texture softening due to the lack of protective rind (Atress *et al.*, 2010).

Several techniques such as modified atmosphere, controlled atmosphere, edible coatings, low temperature, ionizing radiation, plant growth regulators and chemicals have been used to reduce deterioration, extend the shelf-life and maintain quality of strawberries fruits (Singh and Singh, 2012). Modified or controlled atmosphere are common techniques for retaining quality and extending fruit shelf-life (Pesis *et al.*, 2000). However, in modified or controlled atmosphere CO<sub>2</sub> accumulation can cause off flavor and anaerobic respiration (Bender *et al.*, 1994). Fungicides have been used to reduce postharvest decay and extend the storage life of fruit, although fungicide resistance by pathogens, along with consumer concerns about possible risks associated with the residue of fungicides on the fruit surface (Charles *et al.*, 1994).

Gum Arabic is a polysaccharide natural secretion from Acacia species and used in industries for film forming, emulsification and encapsulation purposes (Motlagh *et al.*, 2006). Gum Arabic coatings effectively maintained total antioxidant and phenolic contents in tomato fruit (Ali *et al.*, 2013) and in papaya (Addai *et al.*, 2013). Gum Arabic treatment reduced browning, loss of ascorbic acid and total phenolic contents of tomato slices (Eltoum and Babiker, 2014). Calcium chloride has been extensively used in the fruits and vegetables sector for whole and fresh-cut commodities as preservative and firming agent. It has been observed that calcium is associated with fruit firmness, stress tolerance, ripening and senescence (Martin-Diana *et al.*, 2007). Low temperature caused physiological disorders that are related to calcium content. Calcium chloride dip treatment reduced flesh browning of peach fruit (Manganaris *et al.*, 2007). Calcium chloride combined with chitosan maintained a high level of vitamin C and reduced sensitivity to chilling injury of peach fruit during refrigerated storage (Ruoyi *et al.*, 2005).

Although, to the best of our knowledge, there is no report about the combined effect of gum Arabic coating on post-harvest qualities of strawberries fruits.

Therefore, the objective of this study was to elucidate the effect of gum Arabic pretreatments on physiological, biochemical and quality aspects of strawberries fruits stored at 80-90% RH for 20°C for 10 days.

### **Materials and methods:**

#### **Materials:**

Strawberry (*Fragaria ananassa* Duch.) was chosen for this study. Strawberries were purchased from a local market at Kafr El-Sheikh Governorate, Egypt during the 2016 winter and selected for uniformity of size and ripeness, and fruit with apparent injuries were removed. Fruit were stored at 4±1 °C prior to processing. All materials used for the coating in this study were of food grade, including Arabic gum powder (KB-120, Food Grade) was supplied by Elattar Trading Co., Kafr El-Sheikh, Egypt. The chemicals were obtained from El-Gomhoria Co., Tanta, Egypt, are of analytical grade. All of these experiments were conducted in the laboratory of Food Technology Research Institute at Sakha, ARC.

#### **Methods:**

##### **Preparation of edible film:**

Arabic gum coating solutions at 5, 10, 15, 20% (w/v) from 5, 10, 15 and 20 g of powder was dissolved in 100 mL purified water. The solutions were stirred with low heat (40 °C) for 60 min on a magnetic stirrer/hot plate (Model: HTS-1003), then filtered to remove any undissolved impurities using a vacuum flask. After cooling to 20°C, glycerol monostearate (1.0%) was added as a plasticiser to improve the strength and flexibility of the coating solutions. The pH of the solutions was maintained at 5.6 using 1N NaOH. Arabic gum films were prepared according to the method described by (Ghulam *et al.*, 2015). The coating treatments were selected according to preliminary experiments in strawberry to assure

adherence and steadiness of the coatings. Fruits were washed with 0.01% sodium hypochlorite water solutions for 2 min and then air dried at ambient temperature for one hour. The strawberries were randomly divided into five lots each one containing kilogram of fruits. The strawberry fruits were immersed in each concentration of Arabic gum coating solution (5, 10, 15 and 20%) for 2–3 min and the coating solution was applied uniformly on the whole surface, while control fruit were dipped in purified water. After treatment, fruit were air-dried for 1 h. All fruits were packed in plastic boxes (40 × 30 × 12 cm) covered with polyethylene film (0.02 mm thickness) to maintain relative humidity (RH) were stored at 20±1 °C and 80–90% RH for 10 days. The samples were taken at zero time and after every two days from storage intervals for 10 days of shelf-life.

**Decay percentage:**

The decay percentage of uncoated and coated fruits were calculated as the number of decayed fruit divided by initial number of all fruit multiplied by 100 (El-Anany *et al.*, 2009).

**Weight loss percentage:**

Strawberry samples (10 fruit per replication) were weighed at initial and at the end of each storage interval. The difference between initial and final fruit weight was considered as total weight loss during that storage interval and calculated as percentages on a fresh weight basis by the standard (AOAC, 2005) method.

**Fruit firmness:**

Fruit firmness were assessed by using an Instron Universal Testing Machine (Model 5543 P5995 USA) connected with a computer. The force required to penetrate 10 mm inside the fruit using a probe diameter of 6 mm was measured. The machine was set with compression mode and speed of 20 mm min<sup>-1</sup>. Readings were recorded on 3 points in the equatorial region of the whole fruit with skin removed and the results were expressed in terms of force recorded in Newtons (N). (Zapata *et al.*, 2008).

**Color:**

Color was determined according to McGuire, (1992) using the Hunter Lab System, Miniscan XE Plus colorimeter model (Model: 45/0-5, Reston Virginia, USA). Values were recorded as L\* [white (100) to black (0)] and hue angle (h°) [h° represents red-purple at an angle of 0°, yellow at 90°, bluish green at 180°, and blue at 270°]. The mean values of L\* and h° were obtained from two different points along the strawberry circumference. Before readings were taken during each sampling day, the Miniscan XE Plus colorimeter was calibrated using calibration black and white tiles with values of X = 79.0, Y = 83.9 and Z = 87.9.

**Soluble solids, titratable acidity and ascorbic acid:**

The strawberries from each treatment were ground in a blender and juice from the fruits were used to determine the soluble solids concentration (SSC) using a Palettle Digital Refractometer (Model: PR-32\_, Atago Co., Ltd. Japan). The machine was standardised using purified water before readings were taken. Titratable acidity (TA) was determined using the method of (Ranggana, 1977) by measuring the amount of 0.1N NaOH. Ascorbic acid contents were estimated using the dye 2,6-dichlorophenol–indophenol titration (DCPIP) method after (Ranggana, 1977).

**Sensory evaluation:**

Sensory evaluation of the fruits for pulp color, texture, flavor and overall acceptability for all the samples were done at the end of the storage period using the method of Bai *et al.* (2003) with some modifications. Based on their consistency and reliability of judgment, a panel of seven judges with age ranging from 25 to 40 years was set up. Panelists were asked to score the difference between samples where 0–2 represented extreme dislike; 3–5 fair; 6–8 good; and 9 excellent for pulp color, texture, flavour and overall acceptability.

**Statistical analysis:**

The experiment was conducted using a completely randomized design (CRD) with four replications. The data were subjected to analysis of variance (ANOVA) using the computer software MSTAT-C (Freed and Scott, 1986), while least significant difference (LSD) tests were used to compare differences between treatments at the 95% confidence level of each variable (Chase and Brown, 1997).

## Results and discussion

### Decay incidence (DI):

There was no visible sign of decay in coated or control fruit until two day of the storage period (Table 1). Thereafter, the coatings significantly ( $P \leq 0.05$ ) reduced decay compared to control fruit and fruit treated with 10% Arabic gum coating remained disease free even after 8 days of storage. Many of the control fruit (68.37%) were spoiled after 6 days of storage.

Table 1: Effect of different concentrations of gum Arabic coatings on strawberry fruit decay (%) during storage.

Treatments (%)	Storage time (day)					
	0	2	4	6	8	10
Control	00.00 <sup>m</sup>	00.00 <sup>m</sup>	36.45 <sup>e</sup>	68.37 <sup>c</sup>	92.89 <sup>b</sup>	100.00 <sup>a</sup>
5	00.00 <sup>m</sup>	00.00 <sup>m</sup>	00.00 <sup>m</sup>	27.34 <sup>t</sup>	38.23 <sup>e</sup>	46.86 <sup>d</sup>
10	00.00 <sup>m</sup>	00.00 <sup>m</sup>	00.00 <sup>m</sup>	00.00 <sup>m</sup>	00.00 <sup>m</sup>	09.24 <sup>k</sup>
15	00.00 <sup>m</sup>	00.00 <sup>m</sup>	00.00 <sup>m</sup>	04.06 <sup>l</sup>	09.23 <sup>k</sup>	12.23 <sup>k</sup>
20	00.00 <sup>m</sup>	00.00 <sup>m</sup>	03.00 <sup>m</sup>	10.56 <sup>k</sup>	17.10 <sup>j</sup>	22.67 <sup>t</sup>

Treatments are deferment concentrates of Arabic gum .

Values in table not followed by the same letter are significantly different ( $P \leq 0.05$ ).

The decrease in decay percentage was probably due to the effect of the coating on delaying senescence, which makes the commodity more vulnerable to pathogenic infection as a result of loss of cellular or tissue integrity (Tanada-Palmu and Grosso, 2005). Bai *et al.* (2003) found that ‘Gala’ apples coated with 10% zein maintained their quality, similar to that achieved with the use of commercial shellac formulation, and extended apple shelf-life compared with non-coated controls. Also, Tanada-Palmu and Grosso (2005) noted that wheat gluten coatings and films extended the shelf-life of strawberries and delayed senescence for up to 16 d when stored at 7–10 °C.

### Weight loss percentage:

Fruit coated with 10 and 15% Arabic gum had less weight loss during storage than the control (Table 2;  $P \leq 0.05$ ) and weight loss increased gradually during the storage period. A significantly higher weight loss in 5 and 20% Arabic gum coatings was observed compared to 10 and 15% Arabic gum coatings, which could be explained by the thickness of coatings. The 5% Arabic gum coating was not so thick that it provided a sufficient barrier against moisture loss while the 20% Arabic gum coating was so thick that it completely covered the surface of the fruit. Similar results were reported by Asgar *et al.* (2010) who found that tomato fruit coated too thickly with a corn-zein film resulted in O<sub>2</sub> concentrations which were too low and excessive CO<sub>2</sub> concentrations, resulting in ethanol production. The primary reason for increased weight loss of thickly coated tomatoes might be the generation of heat and production of end-products from anaerobic fermentation (Weichmann, 1987). The basic mechanism of weight loss from fresh fruit and vegetables is by vapor pressure at different locations (Yaman and Bayoindirli, 2002), although respiration also causes a weight reduction (Pan and Bhowmilk, 1992). This reduction in weight loss was probably due to the effects of the coating as a semi-permeable barrier against O<sub>2</sub>, CO<sub>2</sub>, moisture and solute movement, thereby reducing respiration, water loss and oxidation reaction rates (Baldwin *et al.*, 1999; Park, 1999). The results are in agreement with the findings of Ben-Yehoshua (1969) for oranges coated with wax and those of Banks (1984), who reported that sucrose ester-based

coatings on banana fruit extended their storage life through reduction in water loss and a modification of the internal atmosphere.

Table 2: Effect of Arabic gum coatings on weight loss (%) of strawberry fruit during storage

Treatments (%)	Storage time (day)					
	0	2	4	6	8	10
Control	00.00	05.78 <sup>gh</sup>	07.64 <sup>e</sup>	09.56 <sup>b</sup>	10.55 <sup>a</sup>	11.42 <sup>a</sup>
5	00.00	04.54 <sup>hi</sup>	06.84 <sup>efg</sup>	08.09 <sup>bc</sup>	09.26 <sup>bc</sup>	10.62 <sup>ab</sup>
10	00.00	04.02 <sup>hi</sup>	05.43 <sup>g</sup>	06.98 <sup>ef</sup>	07.67 <sup>d</sup>	09.03 <sup>bc</sup>
15	00.00	03.07 <sup>i</sup>	05.06 <sup>gh</sup>	06.04 <sup>fg</sup>	07.12 <sup>de</sup>	08.53 <sup>bc</sup>
20	00.00	03.04 <sup>i</sup>	04.66 <sup>h</sup>	06.00 <sup>fg</sup>	06.94 <sup>ef</sup>	08.12 <sup>cd</sup>

Treatments are a deferment concentrates of the Arabic gum.

Values in table not followed by the same letter are significantly different ( $P \leq 0.05$ ).

### Fruit firmness:

Firmness of fruit significantly ( $P \leq 0.05$ ) decreased with storage period for both treated and control fruit (Table 3). At the end of storage, control fruit clearly showed the lowest firmness. The maximum firmness was maintained by the 20% Arabic gum treated strawberry fruits until 6 day and after that time no significant differences were found among coated strawberries. Softening of fruits is due to deterioration in the cell structure, cell wall composition and intracellular materials (Seymour *et al.*, 1993) and is a biochemical process involving the hydrolysis of pectin and starch by enzymes e.g. wall hydrolases. As the process of fruit ripening progresses, depolymerisation or shortening of chain length of pectin substances occurs with an increase in pectinesterase and polygalacturonase activities (Yaman and Bayoindirli, 2002). Low levels of O<sub>2</sub> and high levels of CO<sub>2</sub> limit the activities of these enzymes and allow retention of the firmness during storage (Salunkhe *et al.*, 1991). In agreement with these findings, Park *et al.*, (1994) reported that respiration and O<sub>2</sub> consumption of corn-zein coated tomatoes were lower than for non-coated tomatoes. Reduction in respiration rates of coated tomatoes could be responsible for delaying ripening which resulted in retention of firmness during storage. Similarly, Tanada-Palmu and Grosso (2005) reported that refrigerated strawberries coated with wheat gluten-based films retained their firmness better than control fruit.

Table 3: Effect of Arabic gum coatings on strawberry fruits firmness (N) during storage

Treatments (%)	Storage time (day)					
	0	2	4	6	8	10
Control	33 <sup>a</sup>	21 <sup>d</sup>	10 <sup>f</sup>	06 <sup>g</sup>	03 <sup>h</sup>	02 <sup>h</sup>
5	33 <sup>a</sup>	30 <sup>b</sup>	24 <sup>c</sup>	22 <sup>d</sup>	18 <sup>e</sup>	16 <sup>e</sup>
10	33 <sup>a</sup>	28 <sup>b</sup>	24 <sup>c</sup>	21 <sup>d</sup>	17 <sup>e</sup>	17 <sup>e</sup>
15	33 <sup>a</sup>	29 <sup>b</sup>	25 <sup>c</sup>	20 <sup>d</sup>	16 <sup>e</sup>	15 <sup>e</sup>
20	33 <sup>a</sup>	30 <sup>b</sup>	26 <sup>c</sup>	20 <sup>d</sup>	15 <sup>e</sup>	14 <sup>e</sup>

Treatments are a deferment concentrates of the Arabic gum.

N = Expressed in terms of force recorded in Newtons.

Values in table not followed by the same letter are significantly different ( $P \leq 0.05$ ).

**Color:**

The lightness ( $L^*$ ) gradually decreased during storage in both uncoated and coated fruits (data not shown). The highest decrease in lightness was observed in uncoated strawberries followed by 5% coated fruits, while the fruits coated with 10, 15 and 20% Arabic gum retained their lightness values at the end of the experiment. There was a significant ( $P \leq 0.05$ ) decrease in lightness during the storage period. As the concentrations of Arabic gum increased the lightness value also increased. Significant ( $P \leq 0.05$ ) changes were found in hue angle and the value of ( $h^\circ$ ) decreased sharply in control as well as 5% Arabic gum coated strawberry until day 4 of storage, thereafter the reduction was slower (Table 4).

Table 4: Effect of Arabic gum coatings on color [hue angle ( $h^\circ$ )] of strawberries fruit during storage.

Treatments (%)	Storage time (day)					
	0	2	4	6	8	10
Control	118 <sup>a</sup>	082 <sup>e</sup>	061 <sup>f</sup>	050 <sup>g</sup>	041 <sup>h</sup>	035 <sup>i</sup>
5	118 <sup>a</sup>	093 <sup>d</sup>	078 <sup>c</sup>	062 <sup>f</sup>	051 <sup>g</sup>	043 <sup>h</sup>
10	118 <sup>a</sup>	117 <sup>a</sup>	117 <sup>a</sup>	110 <sup>ab</sup>	104 <sup>bc</sup>	096 <sup>cd</sup>
15	118 <sup>a</sup>	117 <sup>a</sup>	116 <sup>a</sup>	115 <sup>a</sup>	113 <sup>a</sup>	111 <sup>ab</sup>
20	118 <sup>a</sup>	117 <sup>a</sup>	116 <sup>a</sup>	116 <sup>a</sup>	115 <sup>a</sup>	113 <sup>a</sup>

Treatments are a deferment concentrates of the Arabic gum.

$h$  = hue angle ( $h^\circ$ ) [ $h^\circ$  represents red-purple at an angle of  $0^\circ$ , yellow at  $90^\circ$ , bluish green at  $180^\circ$ , and blue at  $270^\circ$ ].

Values in table not followed by the same letter are significantly different ( $P \leq 0.05$ ).

The hue angle was maintained in fruit coated with 10, 15 and 20% Arabic gum until day 8 of storage, with a subsequent slight decrease, however no significant differences were found between 15 and 20% Arabic gum treated strawberries. The color change in uncoated strawberries were enhanced and they attained pink to red color within 2–4 days of storage compared to the fruit coated with 5 and 10% Arabic gum (6–8 days) while the fruit coated with 15 and 20% remained green even after 10 days of storage. The mechanism behind this is not fully understood and needs further investigation. It is possible that Arabic gum provided a thick barrier against ethylene production and gas exchange between inner and outer environments, and therefore delayed the ripening of the fruit during storage. Similar results were observed by Park *et al.* (1994) when they stored tomatoes coated with a corn-zein film at  $21^\circ\text{C}$ . Color is an important criterion of quality and consumer acceptability, especially with respect to tomatoes (Aked, 2000). During ripening, the green chlorophyll pigment is degraded and there is accumulation of carotenoids, particularly lycopene giving the red color to the ripe tomato (Khudairi, 1972). During ripening of tomatoes, high  $\text{CO}_2$  levels decrease ethylene synthesis, which can delay color changes (Buescher, 1979). In this study, coating of tomatoes with Arabic gum delayed color change, which was probably due to an increase in  $\text{CO}_2$  and decrease in  $\text{O}_2$  levels.

**Soluble solids:**

In general, there was a gradual increase in soluble solids (SSC) during the complete storage period (Table 5). The SSC was significantly higher ( $P \leq 0.05$ ) in control compared to coated fruits and the reduction in SSC in coated fruit was directly proportional to the concentration of the coating. The lowest SSC at the end of the storage period was recorded in fruit coated with 20% Arabic gum, and showed that the coatings provided an excellent semi-permeable film around the fruit, modifying the internal atmosphere by reducing  $\text{O}_2$  and/or elevating  $\text{CO}_2$  and suppressing ethylene production. Decreased respiration rates also slow down the synthesis and use of metabolites resulting in lower SSC (Yaman and Bayoindirli, 2002).



Table 5: Effect of Arabic gum coatings on soluble solids (%) of strawberries fruits during storage

Treatments (%)	Storage time (day)					
	0	2	4	6	8	10
Control	04.4 <sup>t</sup>	05.7 <sup>def</sup>	07.0 <sup>cd</sup>	08.2 <sup>bc</sup>	09.4 <sup>ab</sup>	10.8 <sup>a</sup>
5	04.4 <sup>t</sup>	05.1 <sup>def</sup>	05.9 <sup>de</sup>	07.0 <sup>cd</sup>	08.3 <sup>b</sup>	10.0 <sup>a</sup>
10	04.4 <sup>f</sup>	04.7 <sup>t</sup>	05.3 <sup>ef</sup>	05.9 <sup>de</sup>	07.1 <sup>cd</sup>	07.7 <sup>cd</sup>
15	04.4 <sup>t</sup>	04.8 <sup>t</sup>	05.0 <sup>ef</sup>	05.4 <sup>ef</sup>	05.9 <sup>de</sup>	07.2 <sup>cd</sup>
20	04.4 <sup>t</sup>	04.6 <sup>t</sup>	04.9 <sup>ef</sup>	05.4 <sup>ef</sup>	05.2 <sup>ef</sup>	06.4 <sup>de</sup>

Treatments are a deferment concentrates of the Arabic gum. Values in table not followed by the same letter are significantly different ( $P \leq 0.05$ ).

#### Titratable acidity:

The titratable acidity (TA) values of uncoated and coated fruits during storage decreased with storage time (Table 6) and the value was significantly higher ( $P \leq 0.05$ ) in 20% Arabic gum treated fruit compared to the control. The increase in TA was directly proportional to the Arabic gum concentration. The low level of (TA) in control fruit compared to coated fruit suggests that the Arabic gum coating delayed ripening by providing a semi-permeable film around the fruit. Since organic acids, such as malic or citric acid, are primary substrates for respiration, a reduction in acidity is expected in highly respiring fruit (El-Anany *et al.*, 2009). It is also considered that coatings reduce the rate of respiration and may therefore delay the utilization of organic acids (Yaman and Bayoindirli, 2002). Retention of titratable acidity has been reported previously for various fruit treated with edible coatings and films (Yaman and Bayoindirli, 2002; Tanada-Palmu and Grosso, 2005).

Table 6: Effect of Arabic gum coatings on titratable acidity (%) of strawberries fruits during storage

Treatments (%)	Storage time (day)					
	0	2	4	6	8	10
Control	0.36 <sup>a</sup>	0.35 <sup>ab</sup>	0.30 <sup>de</sup>	0.26 <sup>fg</sup>	0.23 <sup>hi</sup>	0.21 <sup>ij</sup>
5	0.36 <sup>a</sup>	0.33 <sup>bc</sup>	0.28 <sup>ef</sup>	0.24 <sup>gh</sup>	0.21 <sup>i</sup>	0.19 <sup>j</sup>
10	0.36 <sup>a</sup>	0.31 <sup>cd</sup>	0.29 <sup>de</sup>	0.25 <sup>fg</sup>	0.19 <sup>j</sup>	0.20 <sup>ij</sup>
15	0.36 <sup>a</sup>	0.34 <sup>ab</sup>	0.30 <sup>de</sup>	0.26 <sup>fg</sup>	0.21 <sup>ij</sup>	0.20 <sup>ij</sup>
20	0.36 <sup>a</sup>	0.36 <sup>a</sup>	0.31 <sup>cd</sup>	0.26 <sup>fg</sup>	0.22 <sup>hij</sup>	0.22 <sup>hij</sup>

Treatments are a deferment concentrates of the Arabic gum. Values in table not followed by the same letter are significantly different ( $P \leq 0.05$ ).

#### Ascorbic acid:

The ascorbic acid (vitamin C) content of coated and uncoated strawberry fruit increased to maximum after 8 days of storage and subsequently declined after 10 days (Table 7). The highest levels of ascorbic acid were observed in control fruits, closely followed by fruits coated with 5% Arabic gum. This increase in ascorbic acid content was in parallel with the increase in other parameters associated with ripening. In strawberries fruits, ascorbic acid content increases with maturity and stage of ripening (Mathooko, 2003), however once fruits reach the full ripe stage, ascorbic acid content starts to decline (AOAC, 1984). The slower increase in ascorbic acid in coated fruits suggests that the coating slowed down but did not prevent the synthesis of ascorbic acid during ripening. Similar slowing down of the increase in ascorbic acid during ripening has been reported with high CO<sub>2</sub> storage atmospheres for tomatoes (Mathooko, 2003).

Table 7: Effect of Arabic gum coatings on ascorbic acid (mg/100g) of strawberries fruits during storage

Treatments (%)	Storage time (day)					
	0	2	4	6	8	10
Control	09.3 <sup>k</sup>	15.3 <sup>ef</sup>	18.2 <sup>c</sup>	20.4 <sup>ab</sup>	21.1 <sup>a</sup>	20.5 <sup>ab</sup>
5	09.3 <sup>k</sup>	14.2 <sup>fg</sup>	16.4 <sup>de</sup>	18.7 <sup>c</sup>	20.2 <sup>ab</sup>	19.7 <sup>bc</sup>
10	09.3 <sup>k</sup>	10.9 <sup>jk</sup>	12.3 <sup>hi</sup>	13.0 <sup>gh</sup>	13.9 <sup>fgh</sup>	12.8 <sup>h</sup>
15	09.3 <sup>k</sup>	09.8 <sup>k</sup>	10.8 <sup>jk</sup>	11.7 <sup>ij</sup>	12.5 <sup>hi</sup>	11.7 <sup>ij</sup>
20	09.3 <sup>k</sup>	09.9 <sup>k</sup>	10.7 <sup>jk</sup>	11.8 <sup>ij</sup>	12.6 <sup>hi</sup>	11.9 <sup>hij</sup>

Treatments are a deferment concentrates of the Arabic gum.

Values in table not followed by the same letter are significantly different ( $P \leq 0.05$ ).

### Sensory evaluation:

Sensory evaluation of uncoated and coated fruits at the end of the storage period revealed significant ( $P \leq 0.05$ ) differences in pulp color, texture, flavor and overall acceptability (Table 8). The 10% Arabic gum coated fruit had the highest scores in all parameters after 10 days of storage, while those coated with 15 and 20% Arabic gum developed poor pulp color and inferior texture and had flavors. The latter fruit were not acceptable to the panel of experts. Compared with 10% Arabic gum, control fruit and fruit treated with 5% Arabic gum had lower scores for flavor and overall acceptability. These results suggest that Arabic gum upto 10% can be used successfully as an edible coating for prolonging the shelf-life and improving strawberry fruit quality during storage at 10 °C. Similar results were observed by El-Anany *et al.* (2009) when they treated ‘Anna’ apples with Arabic gum coating.

Table 8: Sensory evaluation of strawberry fruit after treatment with different concentrations of Arabic gum and 20 day of storage.

Treatments (%)	Pulp color	Flavor	Texture	Overall acceptability
Control	2.3 <sup>d</sup>	1.6 <sup>e</sup>	1.2 <sup>e</sup>	1.5 <sup>e</sup>
5	4.3 <sup>bc</sup>	4.2 <sup>bc</sup>	3.6 <sup>c</sup>	3.5 <sup>c</sup>
10	8.2 <sup>a</sup>	8.0 <sup>a</sup>	8.5 <sup>a</sup>	8.3 <sup>a</sup>
15	4.4 <sup>b</sup>	4.3 <sup>b</sup>	4.2 <sup>b</sup>	4.3 <sup>b</sup>
20	3.9 <sup>c</sup>	4.1 <sup>bc</sup>	3.6 <sup>c</sup>	3.8 <sup>c</sup>

Treatments are a deferment concentrates of the Arabic gum.

Values in table not followed by the same letter are significantly different ( $P \leq 0.05$ ).

### Conclusion

The results of this study indicate that strawberry fruit coated with 10% Arabic gum showed a significant delay in the change of weight, firmness, titratable acidity, soluble solids concentration and color during storage at 20 °C as compared to uncoated control fruit. In addition, sensory evaluation showed that 10% Arabic gum coating maintained the overall quality of the strawberry fruit during storage. Further studies should be conducted on the gaseous exchange of Arabic gum coatings in relation to the development of new formulations and their application to different climacteric fruit and vegetables.

## References

- Addai, Z.; Abdullah, A.; Mutalib, S. and Musa, K., (2013). Effect of gum Arabic on quality and antioxidant properties of papaya fruit during cold storage. *Int. J. Chem. Tech. Res.* 5, 2854–2862.
- Aked, J., (2000). Fruits and vegetables. In: Kilcast, D., Subramanian, P. (Eds.), *The Stability and Shelf-life of Food*. Woodhead Publish. Ltd., pp. 249–278.
- Ali, A.; Maqbool, M.; Alderson, P. and Zahid, N., (2013). Effect of gum Arabic as an edible coating on antioxidant capacity of tomato (*Solanum lycopersicum* L.) fruit during storage. *Postharvest Biol. Technol.* 76, 119–124.
- AOAC, (2005). *Official Methods of Analysis*, 14th ed. Association of Official Analytical Chemists, Washington, DC, USA.
- Asgar, A.; Mehdi M.; Senthil R. and Peter G., (2010). Arabic gum as a novel edible coating for enhancing shelf-life and improving postharvest quality of tomato (*Solanum lycopersicum* L.) fruit. *Postharvest Biology and Technology* 58, 42–47.
- Atress, A.; El-Mogy M.; Aboul-Anean H. and Alsanian, B (2010). Improving strawberry fruit storability by edible coating as a carrier of thymol or calcium chloride. *Journal of Horticultural Science and Ornamental Plants*, 2, 88e97.
- Bai, J.; Alleyne, Hagenmaier, R.; Mattheis, J. and Baldwin, E., (2003). Formulation of zein coatings for apple (*Malus domestica* Borkh). *Postharvest Biol. Technol.* 28, 259–268.
- Baldwin, E.; Burns, J.; Kazokas, W.; Brecht, J.; Hagenmaier, R.; Bender, R. and Pesis, E., (1999). Effect of two edible coatings with different permeability characteristics on mango (*Mangifera indica* L.) ripening during storage. *Postharvest Biol. Technol.* 17, 215–226.
- Banks, N., (1984). Some effects of TAL-Prolong coating on ripening bananas. *J. Exp. Bot.* 35, 127.
- Bender, R.; Brecht, J. and Campbell, C. (1994). Response of Kent and Tommy Atkins mangoes to reduced O<sub>2</sub> and elevated CO<sub>2</sub>. *Proceed. Florida State Hortic. Soc.* 107, 274–277.
- Ben-Yehoshua, S., (1969). Gas exchange, transportation and the commercial deterioration in storage of orange fruit. *J. Am. Soc. Hortic. Sci.* 94, 524.
- Bouffard, K., (2012). “Florida Strawberry Farmers Face Increasing Competition from Mexico”. *The Ledger*, Aug 25, 2012.
- Buescher, R., (1979). Influence of carbon dioxide on postharvest ripening and deterioration of tomatoes. *J. Am. Soc. Hortic. Sci.* 104, 545.
- Campaniello, D.; Bevilacqua, A.; Sinigaglia, M., and Corbo, M. (2008). Chitosan: antimicrobial activity and potential applications for preserving minimally processed strawberries. *Food Microbiology*, 25, 992e1000.
- Charles, L.; Wilson, A.; Ghaouth, E.; Chalutz, E.; Droby, S.; Stevens, C.; John, Y.; Khan, V. and Joseph, A., (1994). Potential of induced resistance to control postharvest dis-eases of fruits and vegetables. *Plant Dis.* 78, 837–842.
- Chase, W. and Brown, F., (1997). *General Statistics*, 3rd ed. John Wiley and Sons, Inc., NY, pp. 491–523.
- El-Anany, A.; Hassan, G. and Rehab Ali, F., (2009). Effects of edible coatings on the shelf-life and quality of Anna apple (*Malus domestica* Borkh) during cold storage. *J. Food Technol.* 7, 5–11.
- Eltoum, Y. and Babiker, E., (2014). Changes in antioxidant content, rehydration ratio and browning index during storage of edible surface coated and dehydrated tomato slices. *J. Food Process Preserv.* 38, 1135–1144.

- Freed, R. and Scott, D., (1986). MSTAT-C. Crop and Soil Sci. Dept. Michigan State University, Michigan, USA.
- Garcia, M.; Martino, M. and Zaritzky, N. (1998). Plasticized starch-based coatings to improve strawberry (*Fragaria ananassa*) quality and stability. *Journal of Agricultural and Food Chemistry*, 46, 3758e3767.
- Ghulam, K.; Mahmud T.; Asgar, A.; Phebe, D. and Hasanah, M. (2015). Effect of gum Arabic coating combined with calcium chloride on physico-chemical and qualitative properties of mango (*Mangifera indica* L.) fruit during low temperature storage. *Scientia Horticulturae* 190, 187–194.
- Khudairi, A., (1972). The ripening of tomatoes. *Am. Sci.* 60, 696.
- Koyuncu, M. and Dilmaçunal, T. (2010). Determination of vitamin C and organic acid changes in strawberry by HPLC during cold storage. *Notulae Botanica Horti Agrobotanici*, 38, 95e98.
- Manganaris, G.; Vasilakakis, M.; Diamantidis, G. and Mignani, I., (2007). The effect of postharvest calcium application on tissue calcium concentration, quality attributes incidence of flesh browning and cell wall physicochemical aspects of peach fruits. *Food Chem.* 100, 1385–1392.
- Martin-Diana, A.; Rico, D.; Frias, J.; Barat, J.; Henehan, G. and Barry-Ryan, C., (2007). Calcium for extending the shelf life of fresh whole and minimally processed fruits and vegetables: a review. *Trends Food Sci. Technol.* 18, 210–218.
- Mathooko, F., (2003). A comparative study of the response of tomato fruit to low temperature storage and modified atmosphere packaging. *Afr. J. Food, Agric. Nutr. Dev.* 2, 34–41.
- McGuire, R., (1992). Reporting of objective color measurements. *Hort. Science* 27, 1254–1260.
- Motlagh, S.; Ravines, P.; Karamallah, K. and Ma, Q., (2006). The analysis of Acacia gums using electrophoresis. *Food Hydrocolloids* 20, 848–854.
- Pan, J. and Bhowmilk, S., (1992). Shelf-life of mature green tomatoes stored in controlled atmosphere and high humidity. *J. Food Sci.* 57, 948–953.
- Park, H., (1999). Development of advanced edible coatings for fruits. *Trends Food Sci. Technol.* 10, 254–260.
- Park, H.; Chinnan, M. and Shewfelt, R., (1994). Edible coating effects on storage life and quality of tomatoes. *J. Food Sci.* 59, 568–570.
- Pesis, E.; Aharoni, D.; Aharon, Z.; Ben-Arie, R.; Aharoni, N. and Fuchs, Y., (2000). Modified atmosphere and modified humidity packaging alleviates chilling injury symptoms in mango fruit. *Postharvest Biol. Technol.* 19, 93–101.
- Rangana, S., (1977). *Manual analysis of fruit and vegetable products*. Tata McGraw- Hill Publish. Comp. Ltd., New Delhi, pp. 77–78.
- Ruoyi, K.; Zhifang, Y. and Zhaoxin, L., (2005). Effect of coating and intermittent warming on enzymes, soluble pectin substances and ascorbic acid of (*Prunus persica* cv. zhonghuashoutao) during refrigerated storage. *Food Res. Int.* 38, 331–336.
- Salunkhe, D.; Boun, H. and Reddy, N., (1991). *Storage processing and nutritional quality of fruits and vegetables*. CRC Press Inc., Boston, USA, pp. 156–161.
- Seymour, G.; Taylor, J. and Tucker, G., (1993). *Biochemistry of Fruit Ripening*. Chapman and Hall, London, New York.
- Singh, Z. and Singh, S., (2012). Mango. In: Rees, D., Orchard, J. (Eds.), *Crop Post-harvest: Science and Technology*. Volume 3: Perishables. Blackwell Pub, UK, pp. 108–142.
- Tanada-Palmu, P. and Grosso, C., (2005). Effect of edible wheat gluten-based films and coatings on refrigerated strawberry (*Fragaria ananassa*) quality. *Postharvest Biol. Technol.* 36, 199–208.

- Tanada-Palmu, P. and Grosso, C., (2005). Effect of edible wheat gluten-based films and coatings on refrigerated strawberry (*Fragaria ananassa*) quality. *Postharvest Biol. Technol.* 36, 199–208.
- Weichmann, J., (1987). In: Weichmann, J. (Ed.), *Low Oxygen Effects. Postharvest Physiology of Vegetables*. Marcel Dekker, Inc., New York, pp. 231– 237.
- Yaman, O. and Bayoindirli, L., (2002). Effects of an edible coating and cold storage on shelf-life and quality of cherries. *Lebnsn. -Wiss. Und. Technol.* 35, 146–150.
- Zapata, P.; Guillén, F.; Martínez-Romero, D.; Castillo, S.; Valero, D. and Serrano, M., (2008). Use of alginate or zein as edible coatings to delay postharvest ripening process and to maintain tomato (*Solanum lycopersicon* Mill) quality. *J. Sci. Food Agric.* 88, 1287–1293.

## EXPERIMENTAL CONTROL TRIALS ON THE PREVALENCE OF ESCHERICHIA COLI IN RETAIL RAW BEEF

Mohamed HAMADA<sup>1\*</sup>, Abo-Bakr EDRIS<sup>2</sup>, Abdel-Rahman EL-BAGORY<sup>3</sup>, Mahmoud NADA<sup>1</sup>

<sup>1</sup> Department of Food Hygiene & Control, Faculty of Veterinary Medicine, Sadat City University, Egypt

<sup>2</sup> Department of Food Hygiene & Control, Faculty of Veterinary Medicine, Benha University, Egypt

<sup>3</sup> Department of Food Hygiene & Control, Faculty of Veterinary Medicine, Menoufia University, Egypt

\*Corresponding author: gado722006@gmail.com

### Abstract

The present study aimed to evaluate the prevalence and contamination level of *E. coli* in retail beef available on the Egyptian market, to investigate the antimicrobial activity of thyme essential oil (EO) against *E. coli* in minced beef, and to detect its effect on sensory quality attributes of minced beef. A total of 120 fresh beef samples from Egyptian butcher's shops were microbiologically screened for *E. coli* screening. The results show that 27 samples (22.5%) were found to be contaminated with *E. coli* strains, represented as follows: *O*<sub>26</sub>:*H*<sub>11</sub> (3.33%), *O*<sub>111</sub>:*H*<sub>2</sub> (5.83%), *O*<sub>44</sub>:*H*<sub>18</sub> (0.83%), *O*<sub>55</sub>:*H*<sub>7</sub> (1.67%), *O*<sub>86</sub> (0.83%), *O*<sub>114</sub>:*H*<sub>21</sub> (0.83%), *O*<sub>124</sub> (1.67%), *O*<sub>125</sub>:*H*<sub>21</sub> (3.33%), *O*<sub>127</sub>:*H*<sub>6</sub> (2.5%) and *O*<sub>128</sub>:*H*<sub>2</sub> (0.83%). The antimicrobial activity of thyme (*thymus vulgaris*) EO against *E. coli* count (cfu/g) in the fresh minced beef were detected by using different concentrations of thyme EO. In our study, non-O157 *E. coli* serogroups may be also a cause of shiga-toxin producing *E. coli* (STEC) illness. Thyme EO has antibacterial activity against *E. coli* at 0.5% concentration. The thyme EO slightly positively affects the sensory quality attributes, such as color, odor, texture and overall acceptability of minced beef. So, thyme EO may help in improving the safety and sensory quality of minced beef. Advanced research may be needed to allow its practical application, and to determine the optimal concentration to overcome its intense aroma.

**Keywords:** *E. coli*, thyme essential oils, beef, minced beef, prevalence.

### Introduction

Beef is the most common source for pathogenic *E. coli* (Andrews, 2014), which can be classified into enterotoxigenic (ETEC), enteropathogenic (EPEC), shiga-toxin producing *E. coli* (STEC) and entero-invasive (EIEC) pathotypes. ETEC causes gastroenteritis and diarrhea in humans specially infants in developed countries. EPEC specially in poor sanitation causes mild to severe diarrheal symptoms. STEC specially enterohemorrhagic *E. coli* (EHEC) can cause bloody diarrhea, blood-clotting problems, kidney failure, and death. EHEC strains have been traced also to ground meats, which usually begins as watery diarrhea, then progresses to mild dysentery -diarrhea that often contains blood and mucus (FDA, 2012).

Plant essential oils are gaining a wide interest in food industry, as their active components have a wide spectrum of antimicrobial activity, against food-borne pathogens and spoilage bacteria (Gutierrez et al., 2008, 2009). The antimicrobial activity of these oils is due to their chemical structure, as they contain hydrophilic functional groups, such as hydroxyl groups of phenolic components and/or lipophilicity of some essential oil components (Dorman and Deans, 2000). On the other hand, their use in food preservation remains limited mainly due to their intense aroma and toxicity problems. Several authors have reported changes in the organoleptic properties of the food when these oils are used. The use of combinations of

different food preservation methods could solve this problem. The ingestion of high doses of essential oils can induce serious toxicity problems. Thus, the balance between the effective compound dose and the risk of toxicity is necessary. Moreover, the use of essential oils remains expensive, so their use as preservatives needs further studies (Lucera et al., 2012). Thyme EO has high inhibitory activity, particularly against Gram-positive bacteria, rather than Gram-negative bacteria (Marino et al., 2001 and Skandamis et al., 2002). Thyme EO obtained by steam distillation of the fresh flowering aerial parts of *Thymus vulgaris* L., *T. zygis* Loeffl. ex L. or a mixture of both species (Baser and Buchbauer, 2010). Thyme EO is stated to possess bactericidal properties. It is active against *E. coli* and spoilage flora in meat products. The antibacterial activities of thyme EO are mostly attributable to the phenolic compounds and to the hydrocarbons which can be bactericidal or bacteriostatic depending on their effective concentration (Rassooli et al., 2006; Kotan et al., 2010; Helmy, 2012 and Küçükbay et al., 2014). Therefore, the objectives of this study were to investigate prevalence of *E. coli* in raw retail beef, and to evaluate the efficiency of thyme EO as antimicrobial agent against *E. coli* in raw minced beef. Also, enhancement of sensory characteristics of raw minced beef using thyme as essential oil.

### Materials and Methods

*Isolation and identification of E. coli:* A total of 120 fresh blade steak samples of beef (250 gm of each) were collected, in the winter of 2015, from different butcher's shops in Cairo and Menoufia of Egypt. The samples were transferred quickly to the animal health research institute lab (Shebin El-Kom, Egypt) in an ice box under complete aseptic conditions without undue delay. Ten grams of the examined sample were homogenized in a Stomacher-Blender (Seward Medical, London, England) with 90 ml of sterile buffered peptone water (0.1%) for 2.5 minutes to provide a homogenate of 1/10 dilution, decimal serial dilutions were prepared. One ml of each previously prepared serial dilutions was inoculated into 3 sterile tubes of MacConkey broth with inverted Durham's tubes then incubated at 37°C for 48 hours (ICMSF, 1982). A loopful of each positive tube (color changes and gas production) was streaked onto plates of EMB agar (Oxoid CM 69) and incubated at 37° C for 24 hours. Typical colonies (Greenish metallic with dark purple center) were picked up and transferred into nutrient agar slants and incubated at 37 °C for 24 hours, for further identification (FAO, 1992). Biochemical identification tests were performed as described by Koneman et al. (1994). Serological identification of *E. coli* isolates was carried out according to Varnam and Evans (1991).

*Detection of antimicrobial activity of thyme essential oil against E. coli:* The ready-made thyme oil (*Thymus vulgaris*) used in this study were purchased from El Captain company for extracting natural oils, plants and cosmetics, El Obour city - Cairo - Egypt. This oil was analytical reagent grade and stored in amber-colored bottles at 4°C until use. A total of 2.5 kg of the fresh minced beef meat were irradiated to eliminate natural microbial populations in Gamma irradiation unit, Egyptian atomic energy authority, Cairo, Egypt by Gamma irradiation using Indian Gamma Cell (Ge 4000 A, dose 5 kgy and dose rate 1.915 kgy/hr) (Huq et al., 2015).

*E. coli* reference strains were obtained from media unit, food hygiene department, animal health research institute, Dokki, Giza, Egypt. EMB Agar was supplied by Merck, Darmstadt, Germany for enumeration and identification of *E. coli*. Four to five isolated colonies of the tested strains were picked by sterile inoculating loop and inoculated in tubes of sterile peptone water 0.1% (5 ml in each) and were then incubated at 37°C/24 hrs. From this culture, dilutions up to 10<sup>-10</sup> were plated on EMB agar to determine the cell concentration. *E. coli* cell

count was adjusted to  $10^4$  cfu/ml with tube dilution methods. The number of cfu/ml was considered as initial inoculum load to inoculate into fresh minced meat (Barbosa et al., 2009). The irradiated minced beef was immediately prepared and was inoculated with *E. coli* ( $10^4$  cfu/g), then mixed thoroughly by gently squeezing the bags by hand. It was subdivided into equal subgroups (100 g each). Essential oil of thyme (% v/g) was homogenized with the minced beef subgroups to achieve final concentrations of 0.5, 1 and 1.5% for oil. Phosphate buffer saline (PBS) was used for treatment of control (untreated) samples. The essential oil is mixed with the minced beef samples for a further 30 seconds to ensure even mixing. Each sample was packed in polyethylene bag, labeled and stored at 4°C (Jay, 1992 and Kantachote and Charernjiratrakul, 2008). Samples prepared according to ISO (1999). Sensory evaluation (color, odor and texture) according to Pearson and Tauber (1984) and *E. coli* were counted after 3 hours and 24 hrs intervals during storage at 4°C, using the serial dilutions and spread plate technique for each sample in a triplicate manner (ICMSF, 1996). The results were analyzed Statistically according to the guidelines of Feldman et al. (2003).

### Results and Discussion

Contaminated raw meat specially at the retail level is one of the main sources of food-borne illness (Bhandare et al., 2007). The presence of *E. coli* isolates on the meat surface will render the meat spoiled and unsafe to the consumer as they are encountered in causing food poisoning and they reflect the hygienic standard of the butchers' shops. Also *E. coli* serotypes isolated from meat constitute public hazard specially in cases of gastroenteritis, cystitis, pyelonephritis, peritonitis (Nossair et al, 2015). Our results show that 27 samples (22.5%) were found to be contaminated with *E. coli* strains, which classified into four serogroups as follows; EHEC as *O*<sub>26</sub>:*H*<sub>11</sub>(3.33%) and *O*<sub>111</sub>:*H*<sub>2</sub> (5.83%), EPEC as *O*<sub>44</sub>:*H*<sub>18</sub> (0.83%), *O*<sub>55</sub>:*H*<sub>7</sub> (1.67%), *O*<sub>86</sub> (0.83%) and *O*<sub>114</sub>:*H*<sub>21</sub> (0.83%), EIEC as *O*<sub>124</sub> (1.67%) and ETEC as *O*<sub>125</sub>:*H*<sub>21</sub> (3.33%), *O*<sub>127</sub>:*H*<sub>6</sub> (2.5%) and *O*<sub>128</sub>:*H*<sub>2</sub> (0.83%). *E. coli* contamination may be attributed to bad eating habits, long food supply chain with increased movement and poor hygiene practices, poor hygiene and improper preparation practices in consumer homes as kitchen utensils (Erickson et al., 2015). The results differ from a study to a study based on the exposure of each study to sources of bacterial contamination. Moustafa (1993) isolated nearly the same isolates of *E. coli* but in a high ratio (34 %) of meat samples; the serotypes were *O*<sub>26</sub> (4%), *O*<sub>55</sub> (8%), *O*<sub>111</sub> (6%), *O*<sub>119</sub> (4%), *O*<sub>124</sub> (2%) and untyped strains (10 %). Also, a higher percentage of *E. coli* were serologically identified from the examined beef samples by Edris et al. (2013) from Menoufia abattoirs, the serotypes were *O*<sub>26</sub>: *K*<sub>60</sub> (15%), *O*<sub>86</sub>: *K*<sub>61</sub> (15%), *O*<sub>111</sub>: *K*<sub>58</sub> (25 %). Also, Iyer et al. (2013) stated higher incidence rates 65 % of *E. coli* in the small butcher shops in Jeddah market where serotypes were *O*<sub>124</sub>: *K*<sub>72</sub> (5%), *O*<sub>128</sub>: *K*<sub>67</sub> (10%), *O*<sub>119</sub>: *K*<sub>96</sub> (5%), *O*<sub>124</sub>: *K*<sub>72</sub> (5%) and untypable (5%). While lower results were obtained by Chapman et al. (2001) as 1.4% of beef samples were *E. coli* contaminated from butcher shops. Also *E. coli* was isolated in a lower ratio by Philips et al. (2001) who recovered 10.3% *E. coli* strains of 1275 examined beef carcasses and Iroha et al. (2010) who isolated 8% *E. coli* from raw beef samples collected from Abakaliki abattoir, Ebonyi state, Nigeria. All *E. coli* serotypes obtained in our study were non-*O*<sub>157</sub> *E. coli* serotypes; Which in turn can be transferred to human and constituting a public health problem, as urinary tract infection, colicystitis or septicemia (Rahman and Kang, 2009). Recent studies indicate that non-*O*<sub>157</sub> *E. coli* serogroups may be also a cause of STEC illness. Reports from countries that export beef to USA, indicated that non-*O*<sub>157</sub> STEC are of primary importance elsewhere. Consequently, USA authorities are taking an increasing interest in non-*O*<sub>157</sub> STEC, to begin testing foods for the presence of 5 serogroups (*O*<sub>26</sub>, *O*<sub>45</sub>, *O*<sub>103</sub>, *O*<sub>111</sub>, and *O*<sub>145</sub>) (Alexander and Colin, 2010). Non-*O*<sub>157</sub> STEC serotypes including *O*<sub>26</sub>, *O*<sub>103</sub>, *O*<sub>111</sub>, *O*<sub>113</sub> and *O*<sub>121</sub> were also, commonly



associated pathogenic (Acheson, 2000). *E. coli* O<sub>26</sub> was the most frequent *non-O*<sub>157</sub> STEC infections in USA between 1983 and 2002 (Brooks et al, 2005). *E. coli* O<sub>26</sub> and O<sub>111</sub> were an important cause of human infections in Europe and Korea (Su and Brandt, 1995). *E. coli* O<sub>111</sub> serotypes were considered as STEC and EHEC types. *E. coli* O<sub>127</sub> caused attachment and destruction lesions in the intestine without toxin production (Mossel et al, 1995). Regarding the sensory analysis, the thyme essential oil slightly positive affect the color, odor, texture and overall acceptability than control one. The general organoleptic characteristics (color, odor and texture) and overall acceptability of the meat in untreated minced beef samples(control) and thyme oil treated samples at 0.5%, 1% and 1.5% were good, very good, very good and very very good, respectively, after 3 hours; after 1day the results were fair, medium, good and very good, respectively; after 2days the results were poor, fair, medium and good, respectively; after 3days the results were very poor, poor, fair and medium, respectively; after 4 days, the results were very poor, very poor, poor and fair, respectively. The use of natural antibacterial compounds, such as extracts of plant essential oils is reported in the literature to improve the shelf life of meat (Jamilah et al., 2008; Jałosnska and Wilczak, 2009). Thyme EO has high inhibitory activity, particularly against gram-positive bacteria, rather than gram-negative bacteria (Marino et al., 2001). In respect of our current study, different concentrations of thyme EO on *E. coli* counts (CFU/g) artificially inoculated in minced beef samples (initial *E. coli* load at zero hr. =  $7.9 \times 10^7 \pm 5.1 \times 10^5$  CFU/g) was reported as following: the control samples counts were  $1.6 \times 10^7 \pm 1.1 \times 10^6$  after 3 hrs,  $3.1 \times 10^7 \pm 2.6 \times 10^5$  at 1<sup>st</sup> day,  $3.4 \times 10^7 \pm 1.7 \times 10^7$  at 2<sup>nd</sup> day,  $1 \times 10^8 \pm 7.2 \times 10^5$  at 3<sup>rd</sup> day,  $1.3 \times 10^9 \pm 9.5 \times 10^6$  at 4<sup>th</sup> day, while the thyme oil treated 0.5% samples counts were  $1.1 \times 10^4 \pm 8.5 \times 10^2$  after 3 hrs,  $1.4 \times 10^3 \pm 8.7 \times 10^2$  at 1<sup>st</sup> day,  $6.7 \times 10^2 \pm 1.2 \times 10^2$  at 2<sup>nd</sup> day,  $5.1 \times 10^2 \pm 9.5 \times 10$  at 3<sup>rd</sup> day,  $3.2 \times 10^2 \pm 1.9 \times 10$  at 4<sup>th</sup> day, the thyme oil treated 1% samples counts were  $1 \times 10^5 \pm 1.3 \times 10^4$  after 3 hrs,  $3.4 \times 10^4 \pm 2.6 \times 10^2$  at 1<sup>st</sup> day,  $1.5 \times 10^4 \pm 7.9 \times 10^2$  at 2<sup>nd</sup> day,  $1.7 \times 10^3 \pm 1.8 \times 10^3$  at 3<sup>rd</sup> day,  $1.2 \times 10^3 \pm 8.9 \times 10^2$  at 4<sup>th</sup> day, finally the thyme oil treated 1.5% samples counts were  $1.2 \times 10^5 \pm 1.1 \times 10^5$  after 3 hrs,  $3.1 \times 10^5 \pm 1 \times 10^4$  at first day,  $1.3 \times 10^5 \pm 4.5 \times 10^3$  at 2<sup>nd</sup> day,  $3.3 \times 10^4 \pm 2.6 \times 10^3$  at 3<sup>rd</sup> day and not detected at 4<sup>th</sup> day. In conclusion, we found thyme EO had significantly inhibitory effect on *E. coli* growth of at 0.5% concentration. Thyme oil was from the most active essential oils against *E. coli* (with bacterial activity 50 values ranging from 0.057 to 0.28) (Friedman et al. 2002). Thyme is one of the most active essential oils against bacteria. Furthermore, addition of thyme oil at concentrations of 0.5 and 1% caused a significant reduction in microbial growth (Lucera et al. 2012).

### Conclusion

In conclusion, our study showed that serogroups other than O157:H7 may be a significant source of human illnesses in Egypt. Certain serogroups have a higher association than others with illness in humans as O<sub>26</sub>, O<sub>111</sub>, O<sub>44</sub>, O<sub>55</sub>, O<sub>86</sub>, O<sub>114</sub>, O<sub>124</sub>, O<sub>125</sub>, O<sub>127</sub>, and O<sub>128</sub>. But food contamination may be better controlled using natural preservatives. This study showed that thyme EO possess an antibacterial activity against *E. coli* at 0.5% concentration. It can be concluded that the thyme EO slightly positive affect the sensory acceptability of minced beef. Accordingly, thyme EO may be added to meat to prevent food borne pathogens and to extend shelf-life.

## References

- Alexander G and Colin O G. (2010). Non-O157 verotoxigenic *Escherichia coli* and beef: A Canadian perspective. *The Canadian Journal of Veterinary Research*. 74: 161-169.
- Andrews J. (2014). CDC Shares Data on E. Coli and Salmonella in Beef. <http://www.foodsafetynews.com>.
- Barbosa, L.N.; Rall, V.L.; Fernades, A.; Ushimaru, P.; Da Silva, I. and Fernandes, A. (2009): Essential oils against foodborne pathogens and spoilage bacteria in minced meat. *Foodborne Pathogens and Disease*, 6:725-728.
- Baser, K. H. C. and Buchbauer, G. (2010). *Handbook of essential oils: science, technology, and applications*. ICRC Press, Taylor & Francis Group, USA. SBN 978-1-4200-6315-8.
- Bhandare SG, Sherikarv AT, Paturkar AM, Waskar VS, Zende RJ (2007). A comparison of microbial contamination of sheep/goat carcasses in a modern Indian abattoir and traditional meat shops. *Food. Contr.*, 18: 854-868.
- Brooks, J.T.; Sowers, E.G. and Wells, J.G.L.(2005): Non-O157 shiga toxin-producing *Escherichia coli* infections in the United States, 1983-2002. *J. Infect. Dis.*, 192/8: 1422-1429.
- Chapman, P.A.; Cerdàn Malo, A.T.; Ellin, M.; Ashton, R. and Harkin. (2001). *Escherichia coli* O157 in cattle and sheep at slaughter, on beef and lamb carcasses and in raw beef and lamb products in South Yorkshire, UK. *Int. J. Food microbial.*, 64/1-2:139-50.
- Dorman, H.J.D., and Deans, S.G. (2000). Antimicrobial agents from plants: antibacterial activity of plant volatile oils. *J. Appl. Microbiol.* 88, 308-316.
- Edris, A.; Hassan, M.; Shaltout, F. and El -Hosseney, S. (2013). Detection of *E. coli* and *Salmonella* organisms in cattle and camel meat. *BVMJ*, 25/2: 198-204.
- Erickson, M. C.; Liao, J.; Cannon, J. L. and Ortega, Y. R. (2015). Contamination of knives and grates by bacterial foodborne pathogens during slicing and grating of produce. *Food Microbiol.*, 52: 138-45.
- Feldman, D.; Ganon, J.; Haffman, R. and Simpson, J. (2003). *The solution for data analysis and presentation graphics*. 2nd Ed., Abacus Lancripts, Inc., Berkeley, USA.
- Food and Agriculture Organization of the United Nations (1992): *Food and Nutrition paper. Manual of food quality control. Part 14. Food analysis*. Rome 186.
- Food and Drug Administration (2012). *Bad Bug Book, Foodborne Pathogenic Microorganisms and Natural Toxins*. Second Edition.
- Friedman M, Henika PR, Mandrell RE. (2002). Bactericidal activities of plant essential oils and some of their isolated constituents against *Campylobacter jejuni*, *Escherichia coli*, *Listeria monocytogenes*, and *Salmonella enterica*. *J Food Prot.* 65/10:1545-60.
- Gutierrez, J., Barry-Ryan, C. and Bourke, P. (2008). The antimicrobial efficacy of plant essential oil combinations and interactions with food ingredients. *Int. J. Food Microbiol.* 24: 91-97.
- Gutierrez, J., Barry-Ryan, C., and Bourke, P. (2009). Antimicrobial activity of plant essential oils using food model media: efficacy, synergistic potential and interaction with food components. *Food Microbiol.* 26:142-150.
- Helmy, Shahinaze, A. (2012). Extending the shelf life of minced meat by some essential oils under refrigeration and freezing storage. *International Journal of Academic Research*, 4/6:14-21.
- Huq, T., Vu, K., Ried, B., Bouchard, J., Lacroix, M. (2015). Synergistic effect of gamma ( $\gamma$ )-irradiation and microencapsulated antimicrobials against *Listeria monocytogenes* on ready-to-eat (RTE) meat. *Food Microbiology Volume 46*: 507-514.
- ICMSF (1996). *International Commission on Microbiological Specifications for Foods: Microorganisms in foods*. Black Academic and Professional, London.

- ICMSF. (1982). International Commission on Microbiological Specification for Foods. Micro-organisms in Foods., Vol. I their significance and methods of enumeration 2nd Ed., Univ., Tronto Press, Toronto, 188-192.
- Iroha, I. R.; Ugbo, E. C.; Iiang, D. C.; Oji, A. E. and Ayogu, T. E. (2010): Bacteria contamination of raw meat sold in Abakaliki, Ebonyi State, Nigeria. Department of applied microbiology, Faculty of Biological Science, Ebonyi State University, P.M.B, O 53, Abakaliki, Ebonyi State, Nigeria.
- ISO "International Specification organization" (1999): Microbiology of food and animal feeding stuffs. Preparation of test samples, initial suspension and decimal dilutions for microbiological examination. Part 1: General rules for the preparation of the initial suspension and decimal dilutions. Reference number ISO 6887-1. 1st edition.
- Iyer A., et al. (2013). Bacteriophages in *Escherischia coli* antimicrobial resistance. *Advances in Bioscience and Biotechnology* 4: 469-476.
- Jałosnska, M., and Wilczak, J. (2009). Influence of plant extracts on the microbiological shelf life of meat products. *Pol. J. Food Nutr. Sci.* 59, 303–308.
- Jamilah, M.B., Abbas, K.A. and Rahman, R. A. (2008). A review on some organic acids additives as shelf life extenders of fresh beef cuts. *Am.J. Agric. Biol. Sci.* 3: 566-574.
- Jay, J.M. (1992): *Modern Food Microbiology*, 4th Ed. New York: Chapman and Hall.
- Kantachote, D. and Charernjiratrakul, W. (2008). Selection of lactic acid bacteria from fermented plant beverages to use as inoculants for improving the quality of the finished product. *Pakistan J. Biol. Sci.*, 1-8.
- Koneman, W.E., Allen S.D., Janda W.M., Schreckenberger P.C. and Winn W. (1994). *Introduction to Diagnostic Microbiology*. Lippincott Publishers, Philadelphia, USA.
- Kotan, R., Çakır, A., Dadasoglu, A., Aydin, T., Cakmakci, R., Özer, H., Kordali, S., Mete E., Dikbas, N. (2010). Antibacterial activities of essential oils and extracts of Turkish *Achillea*, *Satureja* and *Thymus* species against plant pathogenic bacteria, *J. Sci. Food. Agr.* 90: 145-160.
- Küçükbay, F., Kuyumcu, S., Çelen, S., Azaz, A., Arabac, T. (2014). Chemical Composition of the Essential Oils of Three *Thymus* Taxa from Turkey with Antimicrobial and Antioxidant Activities. *Rec. Nat. Prod.* 8/2: 110-120.
- Lucera A., Costa C., Conte A., Nobile M. (2012). Food applications of natural antimicrobial compounds. *Front. Microbiol.* 3: 287.
- Marino, M., Bersani, C., and Comi, G. (2001). Impedance measurement to study antimicrobial activity of essential oils from Lamiaceae and Compositae. *Int. J. Food Microbiol.* 67: 187-195.
- Mossel, D.A.; Corry, J.; Struijk, C.B. and Baird, R.M. (1995). *Essentials of the microbiology of foods: a text book for advanced studies*. Chichester (England): John Wiley and Sons.
- Moustafa, M. M. M. (1993): Bacteriological studies on certain Gram-negative food borne pathogens. Ph.D., Thesis, Military Institute of Health and Epidemiology. Military Medical Academy.
- Nossair, M.A.; Khaled, K.; El Shabasy, N. A. and Samaha, I. A. (2015). Detection of some enteric pathogens in retailed meat. *Alex. J. Vet. Sci.*, 44/1: 67-73.
- Pearson, M. A. and Tauber, W. F. (1984): *Processed meat*. 2nd Ed., pp: 93. AVI Pub. Com., Inc. West port, Connection.
- Rahman, A. and Kang, S. (2009): In vitro control of food-borne and food spoilage bacteria by essential oil and ethanol extracts of *Lonicera japonica* Thunb. *Food Chemistry*, 116: 670-675.
- Rassooli, I., Rezaei, M. B., Allameh, A. 2006. Ultrastructural studies on antimicrobial efficacy of thyme essential oils *Listeria monocytogenes*, *Int. J. Infect. Dis.* 10: 236 -241.

- Skandamis, P., Tsigarida, E., and Nychas, G.-J. E. (2002). The effect of oregano essential oil on survival/death of *Salmonella typhimurium* in meat stored at 5C under aerobic, VP/MAP conditions. *Food Microbiol.* 19: 97-103.
- Su, C. and Brandt, L.J. (1995): *E. coli* O157:H7 infection in humans. *Ann. Intern. Med.*, 123: 698-714.
- Varnam, A.H. and Evans, M. G. (1991). *Salmonella*. In: *Foodborne pathogens. An illustrated text*. Eds: Varnam A.H. and Evans M.G. Wolfe publishing Ltd, Aylesbury, England.

## A DATE PALM DISEASE CAUSED BY *ACREMONIUM STRICTUM* (*CEPHALOSPORIUM*) IN SAUDI ARABIA

Mohammad Fawzy RASHED

Agric. Res. Cen. Plant pathology research institute- Fruits and Woody Trees Dept. Giza Egypt

\*Corresponding author: dmfawzy@windowslive.com

### Abstract

*Acremonium strictum* is reported as a new causal agent of a disease in date palm (*Phoenix dactylefera*) in Saudi Arabia. A study was carried out in Awqaf Al Rajhi Date Palm Research Center- Plant Disease Department – Al Kharj- Al Riyadh Saudi Arabia to assess the pathogenicity caused by *A. strictum* in our date palm. Symptoms and necrosis caused by *A. strictum* in susceptible cultivars showed small brown necrosis streak at midrib of fruit stalk in an early stage. There was increase in number and size as the disease progresses; then extended to the bases of fruit strands due to death of bases and strands wilt, the infection of fruit strand caused drying the fruits and their fall. *A. strictum* attacks the bunches and move quickly inside and out the tissues causing brown necrosis and death of the tissues. The isolation and pathogenicity tests were made two times between 2015 - 2016 in both and identification of the pathogen was done by classic method in Plant pathology research institute, Fungi department. The confirmation of results by Biolog technique and DNA sequence were done. Proper temperature for infection was between 20 -30 ° C and the optimum 25° C. When testing the susceptibility of varieties of infection, more varieties like Medjool, Saqae and Kholas were susceptible to infection and the most resistant to infection were Barhy and Khidri. The best results in the control of the fungus *in vitro* were due to use of Karpendazem followed Topsen M<sub>70</sub>, at the same time, the worst results were seen with the use of Abredion followed Karant (Copper hydroxide).

**Keywords:** *Acremonium*, date palm, Fruit stalk, Fruit strand, Bunch, Biolog, DNA

### Introduction

Date palm (*Phoenix Dactylefera* L.) is a very important tree in the Arab world and Saudi Arabia is not an exception but it is more important with the great variation of varieties . It is known that the recorded diseases of date palms such as Bayoud caused by *Fusarium oxysporum f.sp. albedinis* , black scorch caused by *Thielaviopsis paradoxa* , diplodia disease caused by *deplodia phoenicum* and *Botryodiplodia theopromae* (Barakat, F.M. et al1992). Inflorescence decay caused by *Mauginiella scaettae* , *Thielaviopsis paradoxa* and *Fusarium moniliforme* then *Graphiola* leaf spot caused by *Graphiola phoenicis* (Djerby M 1981 , Alzyat 2002.) Date palm is affected by all diseases that affect the growth and the productivity. A new disease ( bunch blight ) which affect the crop directly because it causes the wilt of the fruit strands. The symptoms scored for the first time by Al Meleigi 2004 in Saudi Arabia, but the record that causes *Fusarium moniliforme* , reported Rashid and Abdul Hafeez 2001 infection of bunches, fruit stalks and fruit strands with *Fusarium moniliforme*. Yuvol Cohen 2010 recorded that the cause of fall of fruits and bunch blight with *Fusarium Proliferatum*. Benkee Thiyam and Sharma (2013) reported that *Fusarium moniliforme* causes falling of fruit in the date palm. *Acremonium strictum* is pathogenic to many monocotyledonous and dicotyledonous crops, causing leaf desiccation on one side of the midrib of these plants, plant

wilt and abnormal, discoloured vasculature of the stalk near the soil line. Vasculature of the plant forms orange, red and brown bundles, usually resulting in death. Infection of *A. strictum* is systemic, and the fungus can be isolated from all tissues of the plant. Isolates have been found in plant seeds, which is probably the route of dissemination of the fungus and the crops affected by *A. strictum* include *Acacia*, *Ficus*, *Glycine Gossypium*, *Triticum* and *Zea*. Because of its ubiquitous presence in soils, *A. strictum* negatively impacts many agricultural plants.

## Materials and Methods

**Area of study:** This study was conducted during the period from February 2015 to June 2016 in Al Kharj province. It consisted of 20 date palm field in Al Kharj and Al Qaseem. The total number of date palm trees was estimated to be around 230000 trees with the total area about 1500 ha and production of about 5000 tons.

**Isolation and identification:** Samples of affected tissues of symptomatic trees represents fruit stalks and strands of infected trees collected from Al Kharj and Al Qaseem province and kept in plastic bags and transferred to laboratory( in Al Kharj ) for investigation. Individually samples were cut into small pieces 0.5 cm, surface sterilized for 2 min in a Sodium Hypochlorite solution (1.5%), washed twice with sterile distilled water and placed on Potato Dextrose Agar (PDA) and incubated for 3-7 days at 26°C. Emerged colonies from the tissue pieces were transferred to PDA and incubated at 26°C for 7 days. The single spore was transferred to a PDA slants and stored at 4°C for further studies. Colonies were described according to morphological characteristics. Specific keys and references are used to identify the fungi to the genus level (according to the taxonomic systems of Ellis (1971), Barnett and Hunter (1972), Nelson *et al.* (1983) and Paulin-Mahady *et al.* (2002). Isolates well be deposited in the ARC PPRI Fungi Lab. 25/8/2015 and GSFMO, KSA for further identification using Biolog technique (Singh, 2009) and DNA sequence (Pryce *et al.*, 2003).

**Biolog and Molecular Identification:** Filamentous fungi are known to have unique biochemical pathways. The Biolog FF Microplate was recently introduced for rapid identification of common filamentous fungi based on their abilities to utilize 95 discrete substrates. The substrate utilization fingerprints were useful in selecting media components for media optimization of secondary metabolite production for the various cultures. In general, a strong correlation was found among substrate utilization, growth, antimicrobial activity and presence of the responsible secondary metabolites. The method was used for replication of isolated fungi and in the differentiation of closely related variants within one species. The isolates were grown on 2% malt agar for 5 days and then processed according to Singh (2009).The identification was confirmed by molecular tool. DNA sequence-based approach for the accurate and timely identification of fungi by sequencing polymerase chain reaction (PCR) products with a rapid automated capillary electrophoresis system. A simple DNA extraction method and PCR amplification using universal fungal primers was used to amplify ribosome DNA from a range of isolates and reference strains. The internal transcribed spacer (ITS) DNA region was sequenced using automated dye termination sequencing. This identification was conducted according to Pryce *et al.*, 2003.

**Evaluate the pathogenic capability:** Pathogenicity tests were conducted in vitro on healthy detached samples representing different parts of date palm (fruit stalks). Healthy cuttings 25 cm long of the middle part of fruit stalks of Kholas cultivar were surface sterilized with 70% ethyl alcohol. The desired fungus well grows on PDA medium in Petri dishes for seven days at 28°C. For inoculation, pieces of the desired fungal growth were inserted into artificially made wounds (5 mm long x 3 mm deep) made at the center of fruit stalks cuttings. Proper controls were also prepared using PDA agar plug without pathogen. Three replicate were used

for each treatment. All inoculated cutting of fruit stalks were kept in plastic boxes supplemented with wet cotton at room temperature according to the methods described by Molan *et al.*, (2004) and Barakat *et al.* ,(1992). The size of damaged affected tissues around the point of inoculation was measured (mm) 10 days after inoculations as follow: width \*long= area of lesion mm.( means of three replicates for each treatment)

**Effect of temperature:** The pathogenicity tests were done in the effect of temperature, but the inoculated parts were incubated at different temperatures such as 17, 20, 25, 30 and 35 C°, ( 3 replicates for each temperature degree), the results were obtained after 15 days of incubation.

**Varieties susceptibility:** Pathogenicity tests were carried out on several cultivars such as Barhi, Kholas, Saqaey, Medjool and Khadri. They were incubated at 25C°. The results were taken after 15 days of incubation. The results were calculated by measuring the area of the spot caused by the fungus. .( means of three replicates for each treatment)

**In-vitro evaluation of different fungicides against *Acremonium Strictum***

The efficacy of non-systemic fungicides and systemic fungicides against *Acrimonium strictum* were assessed by poisoned food technique (Sharvelle, 1961). Required quantities of individual fungicides based on active ingredients (a.i.) were added separately into potato dextrose agar (PDA) to get the desired concentration of the fungicides. Later 25 mL of the poisoned medium was poured into sterile Petri plates. Mycelial discs of five mm size from actively growing culture of the fungus were cut out by a sterile cork borer and one such disc was placed at the center of each PDA plate. Control was maintained without adding any fungicides to the medium. Each treatment was replicated thrice. Then plates were incubated at 26±1C° for nine days and radial colony growth was measured. The efficacy of a fungicide was expressed as percent inhibition of mycelia growth over control that was calculated by using the formula given by Vincent (1947). The percent values were converted to arc sin transformations, the data were analyzed statistically.

$$I = \frac{(C-T)}{C} \times 100 \quad I = \text{Percent inhibition}$$

C= Radial growth in control (mm)

T= Radial growth in treatment

**Four fungicides used in this trial as follow:**

Trade name of fungicides	Commen name of fungicides
Topsin M70	Thiophanatmethyl 70%
Carbandazim	Carbandazim 50%
Corval	Abredion 50%
Carant	Cupper hydroxide77%

**Concentrations/ppm (10,30,50,100) for each fungicide.**

**Results and Discussion**

**Orchard Symptoms**

As shown in Figure 1- 1, 2 and 5 the parasite attacks fruit stalks causing elongated brown color and then extends longitudinally and internally causing necrosis of tissues and the parasite attacks the bases of fruit strands (Figure 1- 3 and 6) causing brown necrosis then deterioration leads to the death of the tissues and drying of fruit strands and fruits (Figs.1- 4 and 6)





Figure 1. The pathogen (*Acremonium Strictum*)

*Acremonium* is a genus of fungi in the family Hypocreaceae. It used to be known as "Cephalosporium".

Culture Plate (Fig.2-7) and microscopic picture of the *A strictum*. Fig.2-8 and 9.



Figure 2

**Pathogenicity test:**

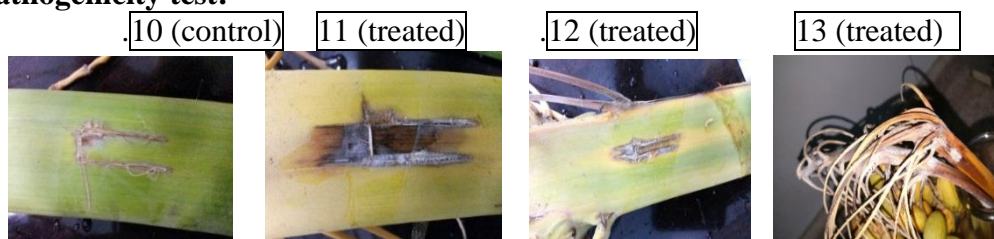


Figure 3.

Fig.3-10 non inoculated ,there is no symptoms, while in Fig.3-11, 12 inoculated with fungus, the symptoms were clear after 15 days of inoculum. In the same time in Fig.3-13 The result obtained after 25 days, there was a development of infection and the symptoms included fruit stalk and fruit strand completely. Re-isolated from a distance of 25 centimeters from the place of the first inoculum was conducted

**Effect of temperature:**

Table (1) area of lesion after 15 days of inoculated of fungus and incubated under different temperatures

Temperatures	17C°	20 C°	25C°	30 C°	35 C°
Area of lesion mm.	50	90	140	130	60

From Table 1 it is clear that the infection spread in a wide moderate temperature range, which is the time of the differentiation of fruit stalk and the emergence of flowers and the holding of fruits of date palm during February, March and April in Saudi Arabia, which means that the activity of the pathogen coincides with the activity of flowering, pollination and fruit.

**Varietal susceptibility:**

Table (2) area of lesion after 15 days of inoculated of pathogen in different of date palm cultivars and incubated under 26 C°.

Cultivars	Barhi	Kholas	Saqae	Medjool	Khidry
Area of lesion mm.	25	125	150	180	25





Figure 4.

It is clear from the results that the most sensitive cultivars of infection was Medjool Fig.4-17 and followed by Saqaey Fig.16 and Kholas Fig.4-15 while the least sensitive was Barhi Fig.4-14 and Khidry Fig.4-18 cultivars. *A. strictum* has been shown to be involved in some myoparasitic relationships, as well as a wide range of plant endophytic and parasitic relationships (Rivera-Varas, *et al.*, 2007) and further studies are required to determine *A. strictum*'s use as a biological control agent and role as a parasite that reduces crop yields. *A. strictum* exhibits metabolism of many products that imply future agricultural and pharmaceutical significance (Chen, *et al.*, 2008 and Chang, Jianing *et al.*, 2013)

### Disease Control ( *In vitro* studies)

Table (3) Evaluation of different fungicides against *Acremonium Strictum*:

Concentrates(B)	Means of linear growth of <i>A. strictum</i> (mm.)			
	Fungicides(A)			
	Carbendazim	TopsinM <sub>70</sub>	Corval	Carant
10ppm	7.0	12.0	29.5	80.0
30 ppm	7.0	10.5	35.3	80.0
50 ppm	7.0	7.7	32.3	80.0
100 ppm	7.0	7.0	31.8	75.0

LCD 5% (A) = 1.120 (B) = 1.120 (A) × (B) = 2.240

It is clear from Table 3 that the highest inhibitory of fungus was with Karpendzim followed by Tobsen( thiphanatmethyl) and that the least inhibitory was with the Carant (copper hydroxide) pesticide and this is consistent with Rashid *et al.*, (2007) and Rashed (2014) in the treatment of palm diseases systemic pesticides, especially Tobsen and Carbendezim.

### Conclusion

The purpose of this research is to identify the new causative agent (( *Acremonium strictum* (is recorded for the first time on date palms). Experiments on the conditions of the infection and their economic effects on the date palm crop have been defined and tested. The susceptibility of the infected varieties was studied. Medjool variety was the most susceptibility to the infection, while the Khidry variety was the least susceptible to infection. The recommended of the control of this disease are doing with the control of the inflorescence decay with the same pesticides( Carbendazim good affective ) and the same time because it is associated with the appearance of spathes of inflorescence date.

### References

Alzyat M. M. (2002). Pests and diseases of date palm in Saudi Arabia and its control ,F.A.O.and Ministry of agriculture Saudi arabia Al Riyadh ,King Fahd library: pp.369.

- Benkee T. and G.D. Sharma (2013). Isolation and Identification of Fungi Associated with local Fruits of Barak Valley , Assam , Current World Environment Vol.8(2) 319-322 (2013)
- Barakat, F.M.; K. K. Sabet.; S. A.Hussien and M. F. Rashed (1992). Pathological studies on the deterioration of date palm off-shoots caused by *Botryodiplodea theobrome*. Bulletin of Fac. Agric., Cairo Univ., vol. 43 No. 1 supplement January.
- Chen, G.T.; Yang, M; Song, Y; Zhang, J.Q.; Huang, H.L.; Wu, L.J.; Guo, D.A. (2008). "Microbial transformation of ginsenoside Rb1 by *Acremonium strictum*". Applied Microbiology and Biotechnology. 77 (6): 1345–1350
- Chang, Jianing; Tani, Yukinori; Naitou, Hirotaka; Seyama, Haruhiko (2013). "Fungal Mn oxides supporting Mn(II) oxidase activity as effective Mn(II) sequestering materials". Environmental Technology. 34 (19): 2781–2787
- Das S, Saha R, Dar SA and Ramachandran VG.(2010) *Acremonium* species: a review of the etiological agents of emerging hyalohyphomycosis. Mycopathologia. 2010 Dec; 170(6):361-75
- Djerbi M. (1981): Diseases of date palm, F.A.O. Regional Project for palm and dates Research Center in the Near East and North Africa , Baghdad, Iraq:pp56.
- Al-Meleigi, M. A.( 2004). First report on two new diseases of date palm (*Phoenix dactylifera*), rachis blight caused by *Seranomyces californica* and wilt of fruit bunch caused by *Fusarium moniliforme* in Saudi Arabia. Proc. International Conf. on Date Palm, King Saud University, Qassim Branch, College of Agric. And Vet. Med., Burydah, Saudi Arabia, p 49- 61..
- Rashed, M. F. and N. A. Abd El-Hafize (2001). Decline of the date palm tree in Egypt. The Second International Conference on Date Palms. United Arab Emirates Univ., Fac. Agric. Sciences, Plant Production Dept., Agric & Livestock. Al-Ain, 25-27 March.
- Rashed, M. F.; F.M. Barakat ; K.K. Sabet (2007) Evaluation of some fungicides and biocontrol agent to control black scorch disease of date palm caused by *Thielaviopsis paradoxa*. Proceeding 4th Symposium on Date Palm in Saudi Arabia, May 5-8, 2007.315p.
- Rashed, M. F. (2014) Tip Die – Back Disease of Date Palm Leaves in Egypt. J Biol. Chem. Environ. Sci., 9(1), March (2014)
- Racedo, J; Salazar, SM; Castagnaro, P; Diaz Ricci, JC (2013). "A strawberry disease caused by *Acremonium strictum*". European Journal of Plant Pathology. 137 (4)
- Rivera-Varas, VV; Freeman, TA; Gudmestad, NC; Secor, GA (2007). "Mycoparasitism of *Helminthosporium solani* by *Acremonium strictum*". Phytopathology. 97 (10): 1331–1337.
- Sabet, K.K., S.A. Hussien F. M. Barakat and M. F. Rashed (1995) Factors affecting severity of *Botryodiplodea theobrome* on date palm off-shoot and its control. Egypt. J. Agric. Res., 73(4).
- Sharville, E.G. (1961). The nature and use of modern fungicides. Burgess Publishing Co., Minnesota,USA. pp. 308
- Skrobot, F; Aglan, HA; Kitchens, S; Ludwick, A; Amburgey, T; Hamid, B; Diel, SV (2014). "Fungal populations in air and materials in a flood simulation study". Wood and Fiber Science. 46 (3).
- Specht,L.P., and Murray, T. D. (1989). Sporulation and survival of conidia of *Cephalosporium gramineum* as influenced by soil pH, soil matric potential, and soil fumigation. Phytopathology. 79:787-793.
- Stiles, C. M., and Murray, T.D. (1996).Infection of field-grown winter wheat by *Cephalosporium gramineum* and the effect of soil pH. Phytopathology. (86):177

- Yuvol Cohen, Rachel ben Zvi , Yaakov Nache, Shinom Biton, Victoria Soroker (2010) Hortscience Ashspubications.org/Contant45/6/887 June 2010 Vol 45 No.(6) 687-893
- Zida, P.E.; Sereme, P; Leth, V; Sankara, P; Somda, I; Neva, A (2008). "Importance of seed-borne fungi of sorghum and pearl millet in Burkina Faso and their control using plant extracts". Pakistan Journal of Biological Sciences. 11 (3)
- Zhou, Sheng-Liang; Yan, Shu-Zhen; Liu, Qi-Sha; Chen, Shuang-Lin (2014). "Diversity of endophytic fungi associated with the foliar tissue of a hemi-parasitic plant *Macrosolen cochinchinensis*". Current Microbiology. 70: 58–66.

## MASS PRODUCTION OF THE FACULTATIVE PARASITIC MITE, *AEGYPTUS RHYNCHOPHORUS*, AS A NATURAL ENEMY AGAINST THE RED PALM WEEVIL IN EGYPT

Sally Farouk ALLAM<sup>1</sup>, Ahmed Rabie EL-BADAWY<sup>2</sup>

<sup>1</sup>Department of Zoology and Agricultural Nematology, Faculty of Agriculture, Cairo University, Egypt

<sup>2</sup>Plant Protection program, Faculty of Agriculture, Cairo University, Egypt

\*Corresponding author: sallyfmallam@gmail.com

### Abstract

The present investigation studies mass production of the facultative parasitic mite, *Aegyptus rynchophorus*, on sugar cane inoculated with fungi *Memnoniella* spp. And artificie culture from *Memnoniella* spp. Only as bio control agents against the red palm weevil in Egypt. *Aegyptus rynchophorus* ectoparasite on pupae results in deformed adults of the red palm weevil, thus reducing damage to palms caused by the red palm weevil .A new method of mass production of facultative parasitic mites is easy for Egyptian farmers to apply. *Aegyptus rynchophorus* (Family: Trachyuropodidae) was propagated on sugar cane inoculated with fungi and with cultures from fungi only. The aim was to determine the level of success of mass production of *Aegyptus rynchophorus*. The duration of tray was 30 days, and the unit was one tray. Every unit has five pieces from sugar cane and unit from fungi was one petri-dish from PDA. The number of parasites increased two fold with sugar cane inoculated with fungi and the culture from fungi only. The researchers determined biological aspects such as life cycle, type of progeny, number of deposited eggs, oviposition period, pre-oviposition period, fecundity, incubation period and behavior. The results was promise in propagative of mite .the life cycle ranged from 13-15days in female, 9-16 in male, type of progeny five females per one male in one fold on culture of fungi and number of deposited eggs ranged from 30 to64 in one fold on sugar cane and culture of fungi only respectively.

**Key words:** *Red palm weevil (R.P.W)*, *Aegyptus rynchophorus*, *Rhynchophorus ferrugineus*, *mass production*, *biological aspects*.

### Introduction

The red palm weevil (RPW), *Rhynchophorus ferrugineus* Olivier (Coleoptera: Curculionidae) is an economically importance invasive tissue borer that has host range restricted to palm trees, mostly young trees less than 20 years old, where the stem of the young palm is soft and juicy and easily penetrated (Eppo, 2008; Salama *et al.*, 2009; El-Mergawy and Al-Ajlan,(2011).There are varying degree of bio relationships between mites and other invertebrates. The most interesting and best known being the association of mites with insects, these relationships could be either predacious, parasitism or phoresy .The relationships of predacious and parasitism play an important role in the biological control of insect pests by suppressing their population where certain predatory and parasitic mites are well known to be capable of regulation. Members of several mite families attack Coleoptera insects. Biodiversity of mites associated with the red palm weevil *R. ferrugineus* varying degrees of bio-relationship between each of the associated, ecto, endoparasitic, predaceous, phoretic and fungivorus mites.Studies on some mites associated with the red palm weevil have been reported by Gomaa, 2006 who isolated three mites pecies associated with (RPW). El-Bishlawy and Allam(2007) recorded new genus and new species, *A. rynchophorus*

(Trachyuropodidae) associated with pupae and adults of RPW. Abde-El-Hamed (2009) recorded another species *Aegyptus zaheri* with differ stages of RPW in Egypt. Al-Dhafar and Al-Qahtani (2012) recorded three mite species associated with RPW, one of these *Aegyptus alhessa* n. sp. (Gamasida, Trachyuropodidae) as a parasite on eggs, pupae, cocoons and adults of RPW. Mazza. *et al.* (2014) reviewed the natural enemies of *Rhynchophorus* species in both their native and introduced regions of the world, to assess the possibility of biological control of this taxon. Its natural enemies in the Mediterranean region, because the impact of this pest in this recently colonized area is particularly remarkable and also the recent trend in species management is looking for indigenous natural enemies. The present study aims to mass production of *Aegyptus rhynchophorus* on sugar cane pieces inoculated with *Memnoniella* spp. And culture from *Memnoniella* spp. on PDA media for utilization of the facultative mite as bio control agent against red palm weevil. Biological aspects were studied under temperature at 25°C ±2 and 70% RH and dark light.

## Materials and Methods

### Collect red palm weevil

Last instar larvae, pupae adults and materials from their habitats of *Rhynchophorus ferrugineus* were collected, using a hatchet, from the trunk of the infested palm trees in Ismailia governorate, Egypt during spring, summer and fall through the years of 2016 and 2017. Adults and immature stages of *R. ferruginus*, in addition to materials from their habitats, were transferred to the laboratory of Acarology of the Faculty of Agriculture, Cairo University.

### Extraction of mite

**From red palm weevil:** insects were carefully examined individually by using the dissecting microscope, then the detected mites were removed gently with a fine brush or needle from different parts of the insect cadavers via spiracular plates, under elytra, wing axillaries, antennal bases, coxal cavity, the thorax region, abdomen and inner elytra. The pupae cocoons were ruptured searching for the mites on the pupae surface.

**From insect habitat:** Each sample was mixed carefully and put in petri-dishes were examined by using the dissecting microscope.

### Identification and Description.

Identification and description of mites were based mainly on those given by El-Bishlawi and Allam (2007-2010).

### Source of food

The types of food used in the present study. A piece of sugar cane inoculated with *Memnoniella* spp. cultures from fungi only (petri dish with media PDA for growth fungi).

**Mass production unit:** mass production culture pieces of sugarcane inoculated with fungi were put in plastic unit (43 cm in length, 25 cm in width and 9 cm height); fungi were cultured in a petri dish (9 cm diameter and 1.5 cm height), each unit was put in incubator at 25 °C ±2.

**Experimental procedure:** After preliminary tests we noticed that mites can live for 30 days on a piece of sugarcane, after cutting of a linear break, maintained in incubator at 25°C and 70% humidity. Therefore, we put five pieces of sugarcane, on every piece put five male and five female from one species of mite and recorded the data every day. Typically it will take place in a closed environment such as incubator in laboratory and growth room when mass production by farmers *A. rhynchophorus* must be situated to a warm, dark and humid climate. Each piece of sugarcane examined and determined the stage of mites, behaviour, and numbers of mites in fold on one cm in all units. Biological phenomena were observed on one female and male such as Incubation period - Larval stage - protonymphal stage - Dutonymphal stage - Total immature stage - Life cycle - preoviposition - Oviposition - Fecundity – sex ration.

These phenomena were very important to know how try the mass rearing to mass production in these mites that can be used by Egyptian farmers.

**Procedure of SEM study:** the live specimens from mite and fungi were cleaned in several baths of distilled water to remove the debris from observation under the scanning electron microscope. They were then briefly submerged in distilled water near boiling point in order to force extension of appendages. Specimens were then fixed in 3.5% concentration of glutaraldehyde for 6 hours, dehydrated in ethyl alcohol, dried using the critical point procedure, individually affixed to stubs using double-sided sticky tape, and sputter coated with gold-palladium. Microscopy was performed with a JEOL GM 4200) microscope. Scanning electron micrographs of the mites and fungi are presented. Shams El-Dean *et al.* (1989).

**Statistical analysis:** T-test was applied in all data at possibility (0.05 and 0.01) SD was obtained for all data.

### Results and Discussion

Large number of *A. rhynchophorus* from female and male produce from one fold in (1 cm<sup>2</sup>) was mean 3.60 (female or male with sex ration) on sugar cane (Table 2) on the other hand was mean 4.2 on culture fungi only. The daily rate number of eggs was 2.375–2.86 on sugar cane inoculated with fungi and fungi only respectively (Table 1). Life cycle in one fold was respectively 14.87–13.72 days on sugar cane inoculated with fungi and fungi only. Sex ratio was respectively 4:3–15:4 female to male on sugarcane inoculated with fungi and fungi only. Our life cycle in one fold was shorter than results by Allam *et al.* (2014) they found that the duration of life cycle of *A. rhynchophorus* were 22 and 21.1 days for female and 21.7 and 19.8 days for male when reared on pupae and sugar cane respectively

They also reported that the duration of life cycle in affected by type of applied diet our results agree with their opinion also Allam *et al.* (2014) determined daily rate was 0.9 eggs when the female was fed on pupae of R.P.W and also on sugar cane at 25 °C and 70% R.H

#### Some biological studies

When the mite propagated on sugarcane inoculated with fungi and culture of fungi only respectively at 25°C (Table 1), the incubation period recorded was 4 and 2 days, the larval stage 3.8 and 3.5 days, the protonymphal stage 3.5 and 3.75 days, the deutonymphal stage average 4 and 6 days. The total immature stages were long 11.33 and 12.55 days, the preoviposition period lasted for 4.5 and 2 days), the oviposition periods were (18 and 16 days). The shorter periods in comparison to sugar cane inoculated with fungi may be due to carbohydrates in sugar cane more than in (PDA) media.

#### Behaviour

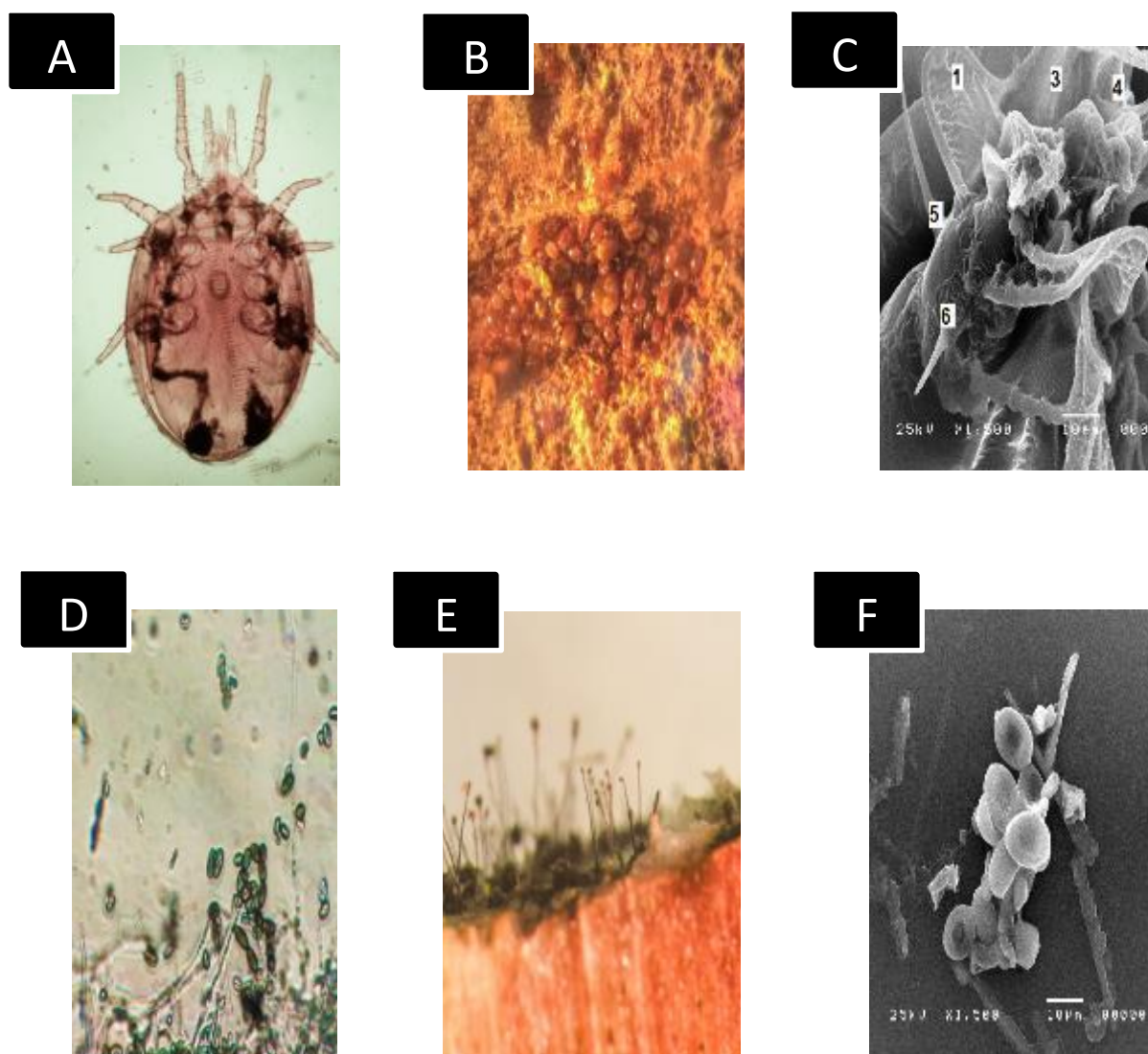
Mites aggression beside and inside colonies of fungi (Fig. 1B). Sugar cane pieces must be always humid for long period to growth inoculated fungi. Drying in sugar cane pieces effect on growth fungi and mite. When we started folds in trays by young female the production of mites were better than started by mother female. Although number of eggs in sugar cane were larger than on culture of fungi only but the number of progeny that complete life cycle on culture of fungi only were (95%) larger than on sugar cane. These results supported the finding of Sobhi (2006) and Abdelhamed (2009), who found that uropodid mites *Agyptus* spp. affected significantly on some biological activities of red palm weevil .when the uropodid (parasitoid) mite released on the pupae stage of the red palm weevil induced malformation in the pupae as well as increasing adults malformation up to 50% compared to 3.3% in control. Also El-Beshlawi and Allam (2007) found that when *A. rhynchophorus* was put with red palm weevil pupae it caused deformation in wings, and death when found in great numbers (500-1000 mite per insect stage).

**Table ( 1 ): Duration of development stage (in days ) and fecundity of *Aegyptus rynchophorus* (Trachyuropodidae) propagated on sugarcane inoculated with *memnoniella* spp. and culture from fungi only *memnoniella* spp. At 25°C ±2**

Mite stages	<i>A. rynchophorus</i> propagated on sugarcane				<i>A. rynchophorus</i> propagated on culture from fungi only			
	T. test				T. test			
	period	T(0.05)	T(0.01)	S.D	period	T(0.05)	T(0.01)	S.D
<b>Incubation period</b>	4	2.06	2.79	1.70	2	1.99	2.65	0.00
<b>Larvae</b>	3.83	2.11	2.89	0.38	3.5	1.96	2.57	0.00
<b>Protonymph</b>	3.5	2.01	2.69	0.00	3.75	2.00	2.67	0.52
<b>Dutonymph</b>	4	2.01	2.69	0.00	5	1.96	2.58	0.00
<b>Total immature</b>	11.33	----	----	0.00	12.25	----	----	0.00
<b>Life cycle</b>	14.87	2.04	2.76	1.39	13.727	1.96	2.57	0.00
<b>Preoviposition period</b>	4.5	2.04	2.74	0.00	2	1.99	2.64	0.00
<b>Oviposition period</b>	18	2.04	2.76	0.00	16	1.99	2.64	0.00
<b>No. of eggs/female</b>	57	4.30	9.92	16.70	51.66	4.30	9.92	14.04
<b>Daily rate</b>	2.37	4.30	9.92	.318	2.86	4.30	9.92	1.50
<b>Sex ration</b>	f4-3m	2.77	4.60	2.12	f4-1m	2.22	3.16	4.725

**Table (2):Relation of Length, width and height with number of mites and determination of the average numerical density**

N	Length	width	height	No .of mites
1	14	2	0.5	168
2	16	2	1	52
3	13	2	1	99
4	15	2	1	95
5	14	2.5	1	105
6	7	2	1.5	50
7	11	2	1	90
X̄	13	2	1	94



**Fig (1):** A) male of *Aegyptus rhynchophorus* feeded on fungi *Memnoniella* spp B) Cluster from *Aegyptus rhynchophorus* immature stage, male and female in groove from sugar cane. C) SEM for mouth parts of *Aegyptus rhynchophorus* feed on spores from fungi(1-epistome1,2-epistome2,3-labrum,4-muscle,5-hyposeta3,6-hyposeta1).D) Brown spores and Aerial hyphae from fungi *Memnoniella* spp growth on PDA media. E) Brown Spores and Aerial hyphae from fungi *Memnoniella* spp growth on sugar cane F) SEM from cluster of spores for fungi *Memnoniella* spp

### Conclusion

Very large quantities of parasitic mites can be produced with a relatively low laboratory investment. Open rearing systems production was continuous, low stress levels during collection, better environmental control. *A. rhynchophorus* is a facultative parasite that may be propagated on other media except pupae of R.P.W. This feeding behavior lead to easy mass production and application on date palm. The feeding behavior, biotic and abiotic factors on the mass production of *A. rhynchophorus* leads to promising bio control agent



against R.P.W on date palm especially in Arab countries. On the other hand mass production mostly needs practical persons-and pure cultures from mites and fungi, the contamination with other fungi and other mite especially Acarid mites may happen. Mass production lead to existing closed developed methods that can be scaled up for quantities from parasitic mites. We confirmed the successes of mass production of facultative parasite mite with 25 °C, 70% relative humidity and dark light to provide biological control of Red Palm Weevil stages. These data support promising alternative in integrated pest management programs. Previous results lead to this facultative parasite can survive and produce other parasites that can be used in controlling pupae of R.P.W. Density on sugar cane pieces it is important if we apply by using sugar cane pieces as carrier with mites

#### **Future studies**

Comparison between two or three ways of application with *A. rhynchophorus*. This facultative parasite would be needed in Bio control programs

#### **Acknowledgement**

Deep thanks to Prof. Dr. Shams El-Dean (Applied Centre of Entomonematodes, Faculty of Agriculture, Cairo University, Giza, Egypt) and its staff members for providing samples and SEM photos; also deep thanks to Prof. Dr. Khairy Abada and Prof. D. Farouk Attia (Plant Pathology Dept., Faculty of Agriculture, Cairo University, Giza, Egypt) for their efforts for identifying fungi.

#### **References**

- Abdelhamed, D.M (2009). Taxonomical and biological studies on mites associated with some insects of agricultural economic importance. M.Sc. Thesis, Fac. Agric. Ain Shams Univ.,147 pp.
- Al-Dhafar, Z.M. and Al-Qahtani, A. M. (2012). Mites associated with the red palm weevil, *Rhynchophorus ferrugineus* Oliver in Saudi Arabia with a description of new species. *Acarines*, 6: 7-13
- Allam, sally. F.; M.F. Hassan; H.A. taha and Mahmoud, reham. A.( 2014)Mass rearing of *Aegyptus rynchophorus* (trachyuropodidae) and *Cosmolealaps keni*(laelapidae) to control the Red palm weevil in Egypt. Proceeding of 3rd Arab Conference of Arab scintests Sharm El Sheikh, Egypt from 5-8 April 2014.
- ELBishlawi,Shahira.M.O.andAllam,Sally.F.M.(2007).Aegyptushynchophorus,N.GEN.,N.SP.(Acari:Uropodina:Trachyuropodidae) from the red palm weevil ,*Rhynchophorus ferrugineus* (Olivier), (Coleoptera, Curculionidae) In Egypt. Proc. 2nd nter.Conf.Ent.Soc.Egypt,Vol.I,2007: 421-433.
- El-Mergawy RAAM, Al-Ajlan AM (2011) Red Palm Weevil, *Rhynchophorus ferrugineus* (Olivier): Economic Importance, Biology, Biogeography and Integrated Pest Management. *J Agric Sci Technol A* 1: 1-23.
- Eppo (European and Mediterran plant protection organization)(2008). Data sheets on quarantine pests. *Rhynchophorus ferruginus* Eppo Bull., 38,55-59.
- Gommaa, W. O. (2006).Three mite species associated with the red palm weevil, *Rhynchophorus ferrugineus*(Oliv.) in Egypt.*Bull. Fac.Agri.,Cairo Univ.,57:543-548.*
- Salama , H.S,Zaki ,F.N. and Abdel-Razek,A.S.(2009).Ecological And biological syudies on the red palm weevil,*Rhynchophorus Ferrugineus* Oliver,Archives of phytopathology and plant protection 42(4):392-399.
- Sobhi, A. I. (2006). Utilization of animal parasites and predators against some insect pests. M.sc. thesis, Fac. Agric, Al-Azhar Univ., Cairo, Egypt, 122 pp.

## CORRELATION BETWEEN STORAGE PERIOD AND SOME BIOLOGICAL AND CHEMICAL PROPERTIES IN THREE QUINOA LINES SEED

Tawfik H. ABD EL-MOITY<sup>1\*</sup>, Sahar T. IBRAHIM<sup>2</sup>, Ayat M. ALI<sup>1</sup>

<sup>1</sup>Central Lab of Organic Agriculture, Agriculture Research Center (ARC), Egypt

<sup>2</sup>Crop Intensification Research Section, Field Crops Research Institute, ARC, Egypt

\*Corresponding author: tawfikabdelmoity@yahoo.com

### Abstract

Quinoa is a very promising crop in Egypt, especially in new reclaimed or poor salty soil areas where many other crops cannot be cultivated. The present work was designed to illustrate different biological and chemical changes may be occurred during storage periods in quinoa seeds. Three different quinoa lines seed were stored for zero, 1, 2, 3 and 4 years. Stored seeds, for different periods, were used to determine viability, water content and fungal population on seeds. Chemical analysis for nutrient components i.e. carbohydrates, fats and proteins were determined. Special attention was paid to aflatoxin content in stored quinoa seeds. Aflatoxin was determined in stored seeds under low and high relative humidity (RH) conditions. Aflatoxin was also determined in whole seeds, peeled seeds (without saponin) and in bran obtained after peeling seeds (with high content of saponin) to illustrate different factors lead to aflatoxin accumulation in stored seeds. Obtained data showed that percentage of water in seeds and germination were reduced by increasing storage period. Fats and proteins were also reduced by increasing storage period whereas slight increase was noticed in carbohydrates. Saponin was drastically reduced by increasing storage period. Fungal population was increased by increasing storage period. No or very low traces of aflatoxin B1 were detected in whole quinoa seeds, peeled seeds or bran of quinoa seeds, when these materials were stored at low RH (30- 37%). When whole quinoa seeds were stored at high RH (65 – 72%) all aflatoxin types were detected in considerable high values.

**Keywords:** *Quinoa, Storage, Saponin, Aflatoxin, Chemical changes.*

### Introduction

In country like Egypt where the population is very high and the cultivated area is very limited, crop like quinoa (*Chenopodium quinoa* Willd.) can play an important role in food supply. This because quinoa can be cultivated, and give considerable yield, in new reclaimed poor sandy soil with saline water (Rasmussen *et al.* 2003, El-Assiuty *et al.*, 2014, Abd El-Moity *et al.*, 2015 and Yazar *et al.*, 2015). Quinoa is considered as a good source for essential amino acids especially lysin (Bhargava *et al.* 2006 and Stikic *et al.*, 2012). Storage of quinoa seeds (pseudo cereal) for different period may affect seed quality.

Many investigators studied effect of storage, for relatively short period, on seed viability (Parsons, 2012 and Souza *et al.* 2016). Investigators also studied the changes occurred in protein and fats contents (Castellion *et al.*, 2010 and Shaban, 2013). According to available literature, no studies were done on relation between storage period, percentage of RH, fungal population and aflatoxin content.

The present work studied changes may be occurred in quinoa seeds, during storage periods up to four years. Viability of seeds expressed as percentage of germination, was assessed. Changes in nutrient components i.e. carbohydrates, fats, and proteins were also studied. Special attention was paid to aflatoxin content in quinoa seeds either as whole seed, seeds

without saponin (peeled seeds) or bran resulted after mechanical remove of outer layer. Quinoa seed also tested for aflatoxin under low RH or high RH conditions. Aflatoxin content also correlated with changes in saponin content in seeds and fungal population on seeds. The aim of this work is to figure out proper storage period of quinoa seeds (propagation material) also to study changes occurred in seeds regarding nutrition value. Aflatoxin contents and factors lead to increase or inhibit toxin production were also considered.

### Material and Methods

Three quinoa lines (Code: Q19, Q26 and Q31) were kindly obtained from FAO in 2013 among many other lines. During 2013, lines were propagated and selected according to suitability to Egyptian conditions. Samples of the selected three lines, 10 kg of each, were packed in paper bags and stored under room conditions (25- 30°C and 30- 37 RH) for 0, 1, 2, 3 and 4 years. At the end of storage periods samples of each batch were taken and used to determine the following parameters.

#### 1 - Viability of seeds (percentage of germination)

Twenty quinoa seeds were placed in clean Petri dish, each contain 2 filter papers supplemented with 25 ml of water. Five plates (100 seeds) were used for each treatment. All plates were kept under room temperature (25- 30°C). Percentage of germinated seeds was recorded after 24, 48 and 72 hours. The final percentage of germination was calculated using the following formula:

$$\% \text{ of seed germination} = \frac{\text{No. of germinated seeds} \times 100}{100}$$

#### 2 - Water content of seed

Samples of different quinoa seeds (100 gm), stored for different periods, were placed in aluminum foil. Aluminum foil with seeds were kept in oven at 70 °C for 24 hour and then transferred to oven 105°C till complete dryness and then percentage of water content was calculated.

#### 3 - Nutrient content, carbohydrate, fats and protein

Samples of different quinoa lines, stored for different periods, were used to determine percentages of fats, using methods developed by AOCS Official Procedure (2005).

Protein was determined as described by AOAC International (1980) whereas carbohydrates were calculated according to Mayer *et al.*, (2007).

#### 4 - Fungal population

One gram of different quinoa varieties seeds, stored for different periods, were added to a flask contained 9 ml or 99ml sterilized distilled water to prepare 1:10 and 1:100 dilutions, respectively. Flasks with water and quinoa seeds were shaken on electric shaker for 1 hour. One ml of each dilution was poured in sterilized Petri plate; contain 10ml of milted warm (45°C) Rose Bengal medium (Johnson *et al.*, 1960) to isolate fungi. Three plates were used for each treatment. All plates were incubated at 25°C. After 5 days plates contain Rose Bengal were examined. Developed fungal colonies were purified and examined according to colony characteristics and morphology of the mycelia and spores using light microscope, to identify types of developed fungi. *Aspergillus* spp. were identified using key developed by Raper and Fennell (1965). Whereas *Penicillium* spp. were identified according to Raper and Thom (1949). *Alternaria solani* was identified as described by Krishnappa and Shetty (1990).

#### 5 - Aflatoxins studies:

5- a-Effect of storage period, saponin layer, fungal population under low RH on aflatoxin content in stored quinoa seeds

Samples of quinoa seeds stored for different periods; *i.e* zero, 1, 2, 3, and 4 years under room conditions (25 - 30°C) and (30- 37% RH); were used to determine aflatoxin B1, B2, G1 and

G2 content in different samples using HPLC (High pressure liquid chromatography), AOAC official methods, (2000) ch., 49 (Modified). Saponin, in different quinoa lines, stored for different periods was also determined to correlate storage period with saponin content and aflatoxin production under low RH conditions. Saponin was determined using method mentioned by Obdoni and Ochuko (2001). To illustrate role of saponin in aflatoxin production whole seed, peeled seeds (without saponin) quinoa bran (contain high amount of saponin) were stored at room conditions (25 - 30°C and 30- 37% RH) for 3 months. Stored ingredients (whole seeds, peeled seeds and quinoa bran) were used to determine aflatoxin contents using the previously mentioned method.

**5-b-Role of high RH on aflatoxin production on quinoa seed in relation to fungal population and saponin content.**

Samples of all quinoa lines, stored for different storage period, were taken and kept under (25 - 30 °C and 65- 72% RH) for one month. Aflatoxin in ppb was determined, to illustrate role of RH in toxin production. Percentages of saponin and fungal population were also determined to correlate production of different types of aflatoxins (B1, B2, G1 and G2) with these two factors under high RH condition.

**Results and Discussion**

Length of storage period in addition to storage conditions play important role in viability and chemical content of storage quinoa seeds. Data in Table (1) indicate that when pseudo cereal of quinoa were stored under low RH and 25-30°C for one year all tested quinoa lines showed high germination percentage ranged from 99% in case of line Q31 to 92% in case of Q26. After two years storage, different quinoa lines seed varied in percentage of germination. Percentage of germination was drastically reduced in line Q19 and only 35% was recorded whereas the other two lines showed 83% for line Q31 and 90% for line Q19. When quinoa seeds were stored for three or four years absolutely no germination was noticed in all tested quinoa lines. When percentage of water content in seeds reached 9.7% or less no germination was noticed in any of tested quinoa seeds, these results support finding of Gurses *et al.*, (2001). The cause of seed deterioration and loss of viability is a complex process (Begum *et al.* 2014). Water content, catalase, peroxidase and lipase were recorded as active factors in seed ageing. In present work water content was significantly reduced also percentage of fates was drastically reduced in non-viable seeds which means increase lipase. These results confirm work of Begum *et al.* (2014) who correlate ageing of seeds by increasing lipase percent.

Table (1): Correlation between water content in quinoa seeds, storage period and percentage of germination

Quinoa lines	Storage period in years	% Water content	Percentage of germination
Q31	0	11.2	99.0
	1	10.3	99.0
	2	9.7	83.0
	3	9.3	00.0
	4	9.2	00.0
Q26	0	11.0	99.0
	1	10.9	92.0
	2	9.9	90.0
	3	9.3	00.0
	4	9.1	00.0
Q19	0	11.1	99.0
	1	10.3	93.0

	2	9.8	35.0
	3	9.2	00.0
	4	9.0	00.0

Effects of storage period on nutrient contents in quinoa seeds were also studied. Data in Table (2) clearly indicate that positive correlations between length of storage period and percentage of losses in protein and fats, in all tested quinoa seeds, were detected. This is in harmony with work of Cakmak *et al.* (2009) who confirm this information. Reduction in protein and fats also can be due to respiration activities which consume some of these stored materials as source of energy. Different quinoa lines varied in percentage of losses in protein. Line Q26 and Q19 were the most stable ones and only 1.8 and 1.2 % reduction in protein content were noticed after one year storage compare with 9.2 reduction in Q31. After 4 years storage, slight differences in protein losses were detected among the three quinoa lines under test. Fats show very slight reduction during the first storage year whereas great significant reduction in percentage of fats were detected after 4 years storage and percentage of reduction reached 43.6% in quinoa Q31 compare with 35.5 and 35.7% in Q26 and Q19, respectively. This may be due to that fats are used as a main source for energy Stefanello *et al.*, (2015). On the contrary, percentage of carbohydrates was increased in all quinoa lines. Percentage of increase was positively correlated with length of storage period. This confirms work of Olayinka *et al.* (2016).

Table (2): Effect of storage period on nutrient content in quinoa seeds

Quinoa lines	Storage period in years	Carbohydrate		Fats		Protein	
		%	% increase	%	% reduction	%	% reduction
Q31	0	57.3	0.0	9.4	0.0	17.4	0.0
	1	59.6	4.0	9.2	2.1	15.8	9.2
	2	61.5	7.3	8.8	6.4	14.8	15.0
	3	64.1	11.7	6.7	28.7	14.7	15.5
	4	66.5	16.0	5.3	43.6	14.0	19.5
Q26	0	58.0	0.0	9.0	0.0	16.7	0.0
	1	58.5	0.9	8.9	1.1	16.4	1.8
	2	61.7	6.4	7.4	17.8	15.1	9.6
	3	65.7	13.3	6.3	30.0	13.1	21.5
	4	66.4	14.5	5.8	35.5	13.1	21.5
Q19	0	57.6	0.0	8.4	0.0	16.6	0.0
	1	59.3	3.0	8.2	2.4	16.4	1.2
	2	62.3	8.2	6.7	20.4	15.7	5.4
	3	64.2	11.5	6.3	25.0	14.8	10.8
	4	68.5	19.5	5.4	35.7	13.1	21.1

To figure out role of saponin, fungal population and RH on aflatoxin production this experiment was carried out. Data in Table (3) show that absolutely no aflatoxin was detected when whole quinoa seeds (surrounded with layer of saponin) were stored for zero to 4 years at low RH (30- 37%) in presence of *Aspergillus* spp. and *Penicillium* spp. When saponin was removed and peeled seeds were stored at low RH (30- 37%) for 3 months a few traces of aflatoxin B1 were detected on peeled seeds and also on the quinoa bran (Mixture of saponin, proteins and carbohydrates). This means that RH and presence of saponin as a solid barrier layer surrounding quinoa seeds play the most important factors in aflatoxin production. At removal of this solid saponin few traces (0.8 ppb on peeled seeds and 0.7ppb on quinoa bran) were detected even in presence of low RH. These results are in harmony with work of Soetan *et al.* (2006), who state that saponin acts as antimicrobial factor.

Table (3): Relation between saponin cover, fungal population and aflatoxin content

Treatment	% Protein	Aflatoxin (ppb)				fungi* (c.f.u./gm)
		B1	B2	G1	G2	
Quinoa seeds (all lines) stored for 0-4 years	15.9-13.1	0.0	0.0	0.0	0.0	100-1400
Peeled seeds	4.5	0.8	0.0	0.0	0.0	100
Quinoa bran	5.1	0.7	0.0	0.0	0.0	1800

\* *Aspergillus* spp., *Penicillium* spp. and *Alternaria solani*

To determine role of high RH on aflatoxin production, samples of different quinoa seeds, stored for different periods up to 4 years were stored under RH (65- 72) for one month. Different types of aflatoxins, percentage of saponin, in addition to fungal population (c.f.u./ gm) were determined to figure out responsible factors lead to aflatoxin production. Data in Fig. (1) and Table (4) show that clear positive correlations were detected between length of storage period of all quinoa line seeds, and amounts of all aflatoxin types, when these seeds were stored at high RH (65-72). The highest amount of aflatoxins was detected when line Q26 was stored for four years and 2112.6 ppb /kg of seeds was calculated compare with the other two lines Q31 and Q19 where only 1986.4 and 1608.7 ppb /kg were detected respectively. The lowest aflatoxin content was appeared when Q26 was stored for one year and only 732 ppb / kg of seed was calculated, compare with 1428 and 887.2 ppb / kg of quinoa seed when lines Q31 and Q19 seed were stored for the same period. These results can be explain in the light of the fact that, production of aflatoxin by microorganisms is controlled by many factors, e.g. high humidity (Pratiwi *et al.*, 2015), protein contents (Liu *et al.*, 2016), presence of responsible microorganisms and also presence of some inhibitors such as saponin (Soetan *et al.*, 2006 and Ahmed *et al.*, 2012). The presented data show clearly, that the highest value of aflatoxin 2112.6 ppb was noticed at presence of the low percent of saponin 0.29% compare with 0.75% saponin when the lowest aflatoxin value (732) was detected. These data confirm work of Jun *et al.* (2004) who mentioned that saponin act as inhibitor for fungal growth. Fungal population also plays important role, obtained data show that lowest fungal population was correlated with high percentage of saponin and with lowest percentage of aflatoxin and vise verse. Data also show that clear variation in hosting fungi and consequently amount of aflatoxin. Quinoa Q26 was the most hospitable quinoa line and 1400 c.f.u/g were counted in seeds stored for 4 years. This because saponin inhibit growth of *Aspergillus* spp. consequently reduce amount of aflatoxin (Ezeabara *et al.*, 2014). Data in Table (4) indicate that different types of aflatoxin varied in quantities according to length of storage period and quinoa line. All aflatoxin types were positively increased by increase storage period in all quinoa lines, stored for any storage period. Aflatoxin G1 showed the highest concentration compare with the other three types B1, B2 and G2. Whereas B2 showed the lowest content in all materials under test. G2 occupied the third rank after aflatoxin G1 and B1.

Table (4): Types of aflatoxin in relation to storage period and quinoa seed lines

Quinoa lines	Storage period in years	Aflatoxin(ppb)				Total aflatoxin (ppb)	% Saponin
		B1	B2	G1	G2		
Q31	1	389	27.9	974	37.1	1428.0	0.78
	2	469	32.9	1094	44.2	1640.1	0.48
	3	539	36.9	1254	53.2	1883.1	0.26

	4	568	38.2	1315	65.2	1986.4	0.19
Q26	1	163	14.2	517	37.8	732.0	0.75
	2	296	24.2	817	44.6	1181.8	0.40
	3	450	31.2	1267	77.6	1825.8	0.34
	4	547	41	1432	92.6	2112.6	0.29
Q19	1	230	17	602	38.2	887.2	0.78
	2	305	21.9	768	41.8	1136.7	0.53
	3	355	27.4	1045	54.1	1481.5	0.40
	4	400	30.6	1105	73.1	1608.7	0.23

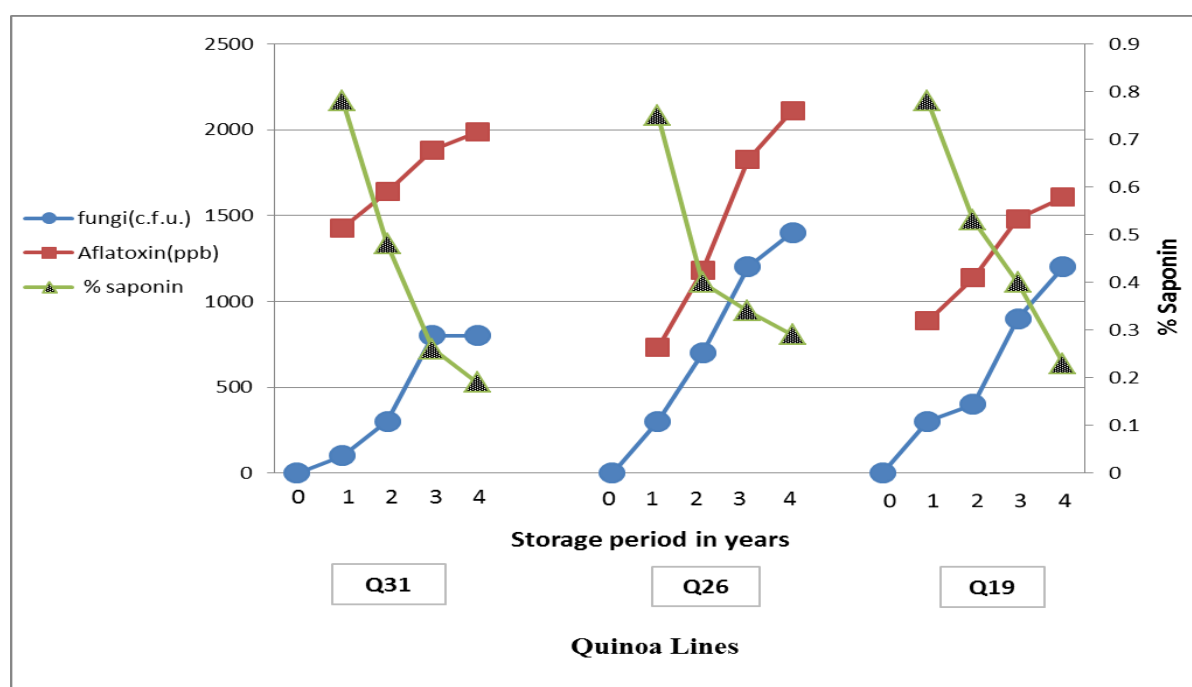


Fig. (1): Correlation between, storage period, under high RH, fungal population and aflatoxin content in three different quinoa lines.

### Conclusion

Quinoa seeds, as propagation material, can be stored at room conditions (25- 30°C and 30- 37 RH) for one to two years without significant reduction in viability of seeds. Relative humidity is the most important factor in aflatoxin production in quinoa pseudo grain so, quinoa seeds stored for human consumption should be stored under low humidity condition (30- 37%)RH to avoid aflatoxin accumulation. Remove saponin layer from quinoa seeds lead to stimulation of aflatoxin production. Protein content was reduced by 20% whereas fats were drastically reduced (more than 40%) after 4 years. To keep high nutrient quality of quinoa grains, storage period can be 1- 2 years only.

### References

Abd El-Moity, T. H.; Bdraway, H. B. and Ali, Ayat M. (2015). Survey on diseases and pests attack quinoa in Egypt. Sixth International Scientific Agricultural symposium, Agrosym. Sarajevo, Bosnia. 868-876.

- Ahmed, D. B.; Chaieb, I.; Salah, K. B.; Boukamcha, H.; Jannet, H. B.; Mighri, Z. and Remadi, M. D. (2012). Antibacterial and antifungal activities of *Cestrum parqui* saponins: possible interaction with membrane sterols. *Intern. Res. J. of Plant Sci.*, vol. 3(1): 001-007.
- AOAC International (1980). Official methods of analysis: Method 16193, Semimicro-Kjeldahl. Association of Official Analytical Chemists, Washington, DC, USA.
- AOAC Official Method 980.21 (2000). Aflatoxin M1 in milk and cheese, thin-layer chromatographic method. *Natural Toxins-chapter 49* (pp. 37-38). Official Methods of Analysis of AOAC International, 17th edition, vol. II, AOAC International. Gaithersburg, Maryland 20877-2417, USA.
- AOCS Official Procedure (2005). Approved Procedure Am 5-04, Rapid determination of oil/fat utilizing high temperature solvent extraction. American Oil Chemists Society, Urbana, IL.
- Begum, S.; Abd El slam, N. M.; Adnan, M.; Tariq, A.; Yasmin, A. and Hameed, R. (2014). Ethnomedicines of highly utilized plants in the temperate Himalayan region. *Afr. J. Tradit Complement Altern Med.*, 11(3): 132-142.
- Bhargava, A.; Shukla, S. and Ohri, D. (2006). *Chenopodium quinoa*: an Indian perspective. *Industrial Crops and Products*, 23: 73- 87.
- Cakmak, T.; Atici, O. and Agar, G. (2009). The natural aging-related biochemical changes in the seeds of two legume varieties stored for 40 years. *Acta Agriculturae Scandinavica, Section B-Soil& Plant Science*, 60(4): 353-360.
- Castellion, M.; Matiacevich, S.; Buera, P. and Maldonado Sara. (2010). Protein deterioration and longevity of quinoa seeds during long-term storage. *Food Chemistry*, vol. 121(4): 952-958.
- El-Assiuty, E. M.; Hassan, F. M. and Fahmy, Z. M. (2014). First record of downy mildew of quinoa in Egypt. *Egypt J. Agric. Res.*, 92 (3).
- Ezeabara, C. A.; Okeke, C. U.; Aziagba, B. O.; Ilodibia, C. V. and Emeka, A. N. (2014). determination of saponin content of various parts of six Citrus species. *Intern. Res. J. of Pure & Applied Chemistry*, 4(1): 137-143.
- Gurses, M.; Erdogan, A.; Turkoglu, H. and Sert, S. (2001). The effects of storage period and relative humidity on Tombul type Hazelnut produced in Turkey. *Pakistan J. of Biological Sci.*, 4(7): 858-860.
- Johnson, L. F.; curl, R. A.; Bon, J. H. and Fribourg, H. A. (1960). Method for studding soil microfora plant disease relationship. Second printing, Burgess publishing Company, 1-17.
- Jun, H. S.; Kim, S. E. and Sung, M. K. (2004). Protective effect of soybean saponins and major antioxidants against Aflatoxin B1-induced mutagenicity and DNA- adduct formation. *J. of Medicinal Food*, 5(4): 235-240.
- Krishnapa, M. and Shetty, H. S. (1990). Location of *Alternaria* species in sunflower seeds. *Plant Disease Res.*, 5: 203-204.
- Liu, J.; Sun, L.; Zhang, N.; Guo, J.; Rajput, S. A. and Qi, D. (2016). Effects of nutrients in substrates of different grains on aflatoxin B1 production by *Aspergillus flavus*. *BioMed Res. Intern.*, 1-10.
- Mayer, E. T.; Fuke, G.; Nornberg, J. L. and Minella, E. (2007). Caracterizacao nutricional de graos integrais descascados de cultivares de cevada. *Pesquisa Agropecuaria Brasileira*, 42(11): 1635- 1640. (English abstract).
- Obdoni, B. O. and Ochuko, P. O. (2001). Phytochemical studies and comparative efficacy of the crude extracts of some Homostatic plants in Edo and Delta States of Nigeria. *Global J. Appl. Sci.*, 8:203-208.



- Olayinka, B.; Olahan, G.; Obadire, T.; Raiyemo, D.; Mohammed, R. (2016). Effect of storage materials on viability and proximate composition of garcinia kola heckel. *J. Appl. Sci. Environ. Manage.*, vol. 20 (3) 897-900.
- Parsons, R. F. (2012). Incidence and ecology of very fast germination. *Seed Science Res.*, 22: 161-167.
- Pratiwi, C.; Rahayu, W. P.; Lioe, H. N.; Herawati, D.; Broto, W. and Ambarwati, S. (2015). The effect of temperature and relative humidity for *Aspergillus flavus* BIO 2237 growth and aflatoxin production on soybeans. *Intern. Food Res. J.*, 22(1): 82-87.
- Raper, K.B. and Thom, C. (1949). *A manual of the Penicillia*. Williams & Wilkins Co., Baltimore. U.S.A. 875 pp.
- Raper, K. B. and Fennell, D. I. (1965). *The Genus Aspergillus*. Williams and Wilkins Co., Baltimore, Maryland. 686.
- Rasmussen, C.; Lagnaoui, A. and Esbjerg, P. (2003). Advances in the knowledge of quinoa pests. *Food reviews intern.*, vol. (19). pp. 61-75.
- Shaban, M. (2013). Review on physiological aspects of seed deterioration. *Intern. J. of Agr. and Crop Sci.*, vol. 6(11): 627-631.
- Soetan, K. O.; Oyekunle, M. A.; Aiyelaagbe, O. O. and Fafunso, M. A. (2006). Evaluation of the antimicrobial activity of saponin extract of *Sorghum Bicolor* L. Moench. *African J. of Biotechnology*, vol. 5(23): 2405-2407.
- Souza, F. F.; Devilla, I. A.; Souza, R. T. and Spehar, C. R. (2016). Physiological quality of quinoa seeds submitted to different storage conditions. *African J. of Agric. Res.*, vol. 11(15): 1299-1308.
- Stefanello, R.; Londero, P.M.; Muniz, M.F.; Alves, J.S. and Fischer, L. (2015). Chemical composition of landrace maize seeds stored under different conditions. *Intern. Food Res. J.*, 22 (3): 918- 922.
- Stikic, R.; Glamoclija, D. j.; Demin, M.; Vucelic-Radovic, B.; Jovanovic, Z.; Milojkovic-Jacobsen, S. E.; and Milovanovic, M. (2012). Agronomical and nutritional evaluation of quinoa seeds (*Chenopodium quinoa* Willd.) as an ingredient in bread formulations. *J. Cereal Sci.*, 55: 132-138.
- Yazar, A.; ÇigdemIncekaya, S.; MetinSezen, S. and Jacobsen, S. (2015). Saline water irrigation of quinoa (*Chenopodium quinoa*) under Mediterranean conditions. *Crop and Pasture Sci.*, 66(10): 993-1002. <http://dx.doi.org/10.1071/CP14243>

## VIRULENCE OF THE WHEAT LEAF RUST POPULATION IN GEORGIA

Zoia SIKHARULIDZE\*, Ketino SIKHARULIDZE, Ketino NATSARISHVILII, Tsisana TSETSKHLADZE, Lali MGELADZE

Department of Genetics of Resistance, Institute of Phytopathology and Biodiversity,  
Batumi Shota Rustaveli State University, Georgia

\*Corresponding author: zsikharulidze@ymail.com

### Abstract

In Georgia, one of the centers of origin of wheat, rust pathogens are common. Rust surveys throughout different geographical zones of Georgia indicated that wheat leaf rust caused by *Puccinia triticina* f. sp. *tritici* occurred with low incidence (1-20%) in 2014-2015 wheat growing seasons. Disease severity varied from 5% to 100% depending on the environment and varieties. Wheat leaf rust was first observed in the fall-planted wheat plots in Colchis Lowland around mid-May. In June-July, it spread across the other zones characterized by more temperate dry climate. The virulence of 114 single isolates was characterized on the set of 20 North American leaf rust differential near-isogenic lines. In addition, eight supplemental tester lines carrying Lr19, Lr20, Lr23, Lr25, Lr27+31, Lr29, Lr36 and Lr37 were included to confirm virulence. According to seedling virulence surveys the majority of isolates were virulent on lines with the resistance genes: Lr1, Lr2a, Lr3ka Lr2c, Lr3, Lr11, Lr14a, Lr26, Lr 23, Lr30 and LrB. Virulence in genes, Lr16, Lr17, Lr18, Lr20 and Lr24 was high in both years. No virulence was found in Lr28, Lr29, Lr27+31, Lr41 and Lr42. Low virulence (1.8-13.2%) was recorded in genes Lr9, Lr19, Lr10 and Lr21. Sixteen pathotypes were described in *Puccinia triticina* population. The most common pathotype PKTTL, PTKNL and PFTPL were occurred in 14.0-12.3% of the isolates. Dominant pathotypes consist of 13-15 virulence genes. The existence and severity of leaf rust natural infection were assessed in two growing seasons on the 85 entries of Trap Nurseries (5<sup>th</sup> ILRTN-14 and 6<sup>th</sup> ILRTN-15). Resistance of 60 % of entries was indicated. Among them 34.1% showed R type. Moderate resistance to leaf rust have been expressed on lines with genes Lr17, Lr18, Lr19, Lr21, Lr28, Lr29, Lr37, Lr 10+ 27+31.

**Keywords:** *wheat rust, virulence, resistance genes, pathotypes*

### Introduction

Wheat in general is the major stable crop in Georgia, which is one of the centers of origin of wheat (Zhykovsky, 1973). Wheat rusts are common in Georgia. Leaf rust of wheat, caused by *Puccinia triticina* Eriks, is a potentially dangerous disease. It occurred annually throughout most of the wheat growing areas of Georgia in 30 years ago (Naskidashvili and Sikharulidze, 1998). However, incidence and severity of leaf rust have decreased in the recent years. Breeding of resistant cultivars is the most economically profitable and effective way to control of disease. Difficulty of breeding for leaf rust durable resistance is due to highly variability of pathogen. Virulence surveys aim to monitor shifts of pathotype frequencies, to know the virulence variation in the natural pathogen population and to help breeders in developing resistant varieties. Virulence surveys of the wheat rusts conducted in Georgia during 2009-2015 were financially supported by ICARDA. The present paper reports on the determination of virulence frequencies in Georgia by means of seedling tests and field evaluations.

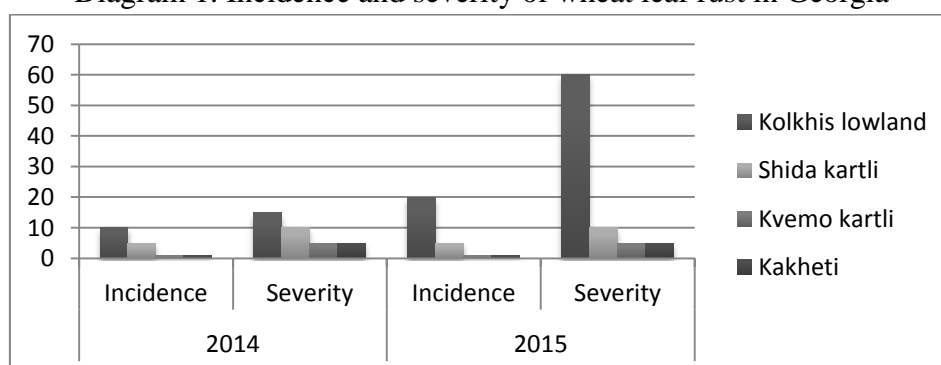
## Materials and Methods

During 2014-2015 growing seasons leaf rust collections were taken from wheat commercial fields, small private plots and breeding stations through major wheat producing areas of Georgia. Observation of wheat fields and sampling were conducted using standard methodology (Yahyaoui *et al.*, 2003). The main area of commercial sowings was occupied by varieties Bezostaya 1, Lomtagora 123, Tanya and Jagger. Each collection was used to inoculate 7 day-old wheat seedlings of universally susceptible cultivar Thatcher. After 6-10 days, the leaves were trimmed so that only one uredinium remained on each plant. Spores from single uredinia were collected separately and were used to inoculate 1-week old seedlings differential set consisting of near-isogenic lines of Thatcher, each with a different resistance genes: *Lr1*, *Lr2a*, *Lr2c*, *Lr3a*, *Lr9*, *Lr16*, *Lr24*, *Lr26*, *Lr3ka*, *Lr11*, *Lr17*, *Lr30*, *LrB*, *Lr10*, *Lr14a*, *Lr18*, *Lr21*, *Lr28*, *Lr41*, *Lr42* (Table 1). The differential set was provided by CIMMYT. In addition, tester lines carrying *Lr19*, *Lr20*, *Lr23*, *Lr25*, *Lr27+31*, *Lr29*, *Lr36* and *Lr37* were included to confirm virulence. Plants were inoculated with water-spore suspensions of each single pustule isolate and placed in a dew chamber overnight. The next morning, seedlings were maintained in a greenhouse from 20°C to 28°C. Twelve to fourteen days after inoculation, plant reaction was scored using the 0-4 scale described by Johnston and Browder (1966). Seedlings with the infection types 0, 1 and 2 were considered resistant response (R), while infection types 3, 4 and X were considered susceptible ones (S) (Roelfs *et al.*, 1992). The races (pathotypes) were recorded according to North American *Prt* Nomenclature (Long and Kolmer, 1989). Factor of virulence, value of polymorphism and coefficient of diversity of pathogen population were accounted (Ayala, 1989; Groth and Roelfs, 1987). We also obtained the valuable information on virulence genes by observation of Trap Nurseries: 5<sup>th</sup> ILRTN-14 and 6<sup>th</sup> ILRTN-15 planted in two geographic zones. For disease severity evaluation the modified Cobb's scale (Peterson *et al.*, 1948) was used.

## Results and Discussion

Thirty five locations were surveyed covering the main wheat growing areas of five agro-ecological zones. Rust surveys throughout different geographical zones of Georgia indicated that wheat leaf rust caused by *Puccinia triticina f. sp. tritici* was occurred with low incidence (1-20%) in 2014-2015 wheat growing seasons. As diagram 1 shows the disease severity varied from 5% to 100% depending on the environment conditions and wheat varieties. Wheat leaf rust was first observed in the fall-planted wheat plots in Kolchis lowland around mid-May, in June-July, it spread across the other zones, which are characterized by more temperate dry climate (Diagram 1).

Diagram 1. Incidence and severity of wheat leaf rust in Georgia



During 2014-2015 twenty nine samples were collected from commercial wheat fields and nurseries across four agroecological zones of Georgia. Three to five single-pustule isolates were derived from each samples. In total one hundred fourteen isolates of *Puccinia triticina* were evaluated using isogenic lines to identify pathogen virulence. In all, sixteen pathotypes were described based on infection types to the twenty near-isogenic lines (Table 1). A total of twelve pathotypes were found in collection from Kolkheti zone, thirteen - from Shida kartli and ten - from Kakheti and Kvemo kartli zones. Frequency of pathotypes was varied between 0.9-14.9%. Pathotypes PKTTL(virulence to genes *Lr1, Lr 2c, Lr3a, Lr 16, Lr 24, Lr 26, Lr3ka, Lr11, Lr17, Lr30, LrB, Lr10, Lr14a, Lr18, Lr21*) and PTKNL (virulence to genes *Lr1, Lr 2c, Lr3a, Lr9, Lr16, Lr24, Lr26, Lr11, Lr17, Lr30, LrB, Lr14a, Lr 21*) were the most prevalent in *Puccinia triticina* population. They constituted 14.9% and 12.3% of all isolates, respectively. Races PFTPL, TRPPF, THRPL, TPTPF, TTTTP, TKTNP and THTPP were distributed with frequency ranged between 11.4-5.3%. The frequency of races PMTTP, PTTTP, PMTTPF, PRTPB, PHTPF, FHTPP and PHTNP was low 4.4-0.9%. Races FHTPP and PHTPF were found only in Kvemo Kartli zone and race PHTNP was found only in Kakheti zone. Dominant races consisted of 13-15 virulence genes. The diversity of *P. triticina* was slightly higher in 2015 than in 2014. According to Gleason index ( $H_G=0.14$ ) the level of genetic diversity of *P.triticina* population was low. However, the factor of virulence ( $F_v=18.9$ ) and polymorphism ( $p=0.8$ ) were high. Jaccard similarity index (SI) comparisons showed that LR collections from different zones were similar, SI varied between 50-75%. Only both Kakheti and Kvemo kartli zones had less common races ( $SI=31.1\%$ ). Low diversity of leaf rust population can be explained by small commercial fields and similar genotypes of producing wheat cultivars.

Table 1. Frequency of races of *Puccinia triticina* identified on 20 differential lines in Georgia in 2014-2015

Race	Virulence	Isolates, %									
		Kolkheti		ShidaKartli		Kvemo kartli		Kakheti		Total	
		2014	2015	2014	2015	2014	2015	2014	2015	no	%
PKTTL	<i>1,2c,3a,16,24,26, 3ka, 11,17, 30, B,10, 14a, 18, 21</i>	25.0	5.0	30	10.0	28.5	0	28.5	0	17	14.9
PTKNL	<i>1,2c, 3a, 9, 16,24, 26, 11, 17, 30, B, 14a,21</i>	12.5	0	20.0	15.0	28.5	8.3	28.5	0	14	12.3
PFTPL	<i>1,2c,3a,24, 26, 3ka,11, 17, 30, B, 14a,18, 21</i>	12.5	35.0	0	5.0	0	0	0	25.0	13	11.4
TRPPF	<i>1,2c,3a,16, 26, 3ka, 17, 30, B, 14a,18, 41,42</i>	12.5	20.0	5.0	15.0	0	8.3	0	0	11	9.6
THRPL	<i>1, 2a,2c,3a, 16, 26,3ka, 11, 30, B, 14a,18, 21</i>	0	5.0	10.0	10.0	0	0	42.8	16.6	10	8.8
TPTPF	<i>1, 2a,2c,3a, 9, 16,24, 26, 3ka, 11, 17, 30, B, 14a,18, 41, 42</i>	0	5.0	0	5.0	28.5	33.3	0	16.6	10	8.8
TTTTP	<i>1, 2a,2c,3a, 9, 16,24, 26, 3ka, 11,</i>	6.3	10.0	10.0	10.0	0	8.3	0	8.3	9	7.8

	17, 30, B, 14a, 18, 21, 41,42										
TKTNP	1, 2a,2c,3a,16,24, 26, 3ka, 11, 17, 30, B, 14a,21, 41,42	6.3	10.0		10.0	14.2	0	0	8.3	7	6.1
THTPP	1, 2a,2c,3a,16, 26,3ka, 11, 17, 30, B, 14a,18, 21,41,42	6.3	5.0	5.0	5.0	0	16.6	0	0	6	5.3
PMTTP	1,2c,3a, 9, 26, 3ka, 11, 17, 30, B, 10, 14a,18, 21, 41,42	6.3	5.0	5.0	5.0	0	0	0	8.3	5	4.4
PTTPL	1,2c,3a, 9, 16,24,26,3ka,11, 17, 30,B, 14a,18, 21	6.3	5.0	5.0	5.0	0	0	0	0	4	3.5
PMTPB	1,2c,3a, 9, 26, 3ka, 11, 17, 30, B, 14a, 18	6.3	0	5.0	5.0	0	0	0	0	3	2.6
P RTPB	1,2c,3a, 9, 16, 26,3ka, 11, 17, 30, B, 14a,18,	0	0	5.0	0	0	8.3	0	8.3	3	2.6
PHTPL	1,2c,3a,16, 26, 3ka, 11, 17, 30, B, 14a,18,21	0	0	0	0	0	8.3	0	0	1	0.9
FHTPB	2c,3a,16, 26, 3ka, 11, 17, 30, B, 14a,18	0	0	0	0	0	8.3	0	0	1	0.9
PHTNB	1,2c,3a, 16, 26, 3ka, 11, 17, 30, 21,B, 14a	0	0	0	0	0	0	0	8.3	1	0.9

All analyzed isolates were virulent to genes *Lr2c*, *Lr3a*, *Lr14a*, *Lr23*, *Lr25*, *Lr26*, *Lr30* and *LrB*. Virulence frequencies to lines with genes *Lr1*, *Lr3ka*, *Lr11*, *Lr16*, *Lr17*, *Lr18*, *Lr20* and *Lr21* were 64.9-99.1% of isolates across the country. Low virulence (18.4%) was recorded to lines with gene *Lr10*. Virulence to lines with genes *Lr9*, *Lr19* and *Lr24* occurred in 50.8, 55.2 and 65.8% of the isolates, respectively. These genes were very effective against to wheat leaf rust during many years (Sikharulidze *et al.*, 1993; Sikharulidze and Bedoshvili, 2005). Virulence frequencies (41.2%) to genes *Lr41* and *Lr42* were identical. Frequency of virulent isolates to gene *Lr10* was low (23.7%). Virulence to genes *Lr28*, *Lr29* and *Lr27+31* was not found in any of the tested isolates (Table 2).

Table 2. Frequency of isolates of *Puccinia triticina* virulent to near-isogenic lines with resistance genes in Georgia in 2014-2015

N	Source	Resistance Genes	Isolates of <i>Puccinia triticina</i>					
			2014		2015		Total	
			No.	%	No.	%	No.	%
1	Tc* 6 / Centenario (RL6003)	<i>Lr 1</i>	49	98.0	64	100.0	113	99.1
2	Tc* 6 / Webster (RL6016)	<i>Lr 2a</i>	16	32.0	37	57.8	53	46.5
3	Tc* 6 / Loros (RL6047)	<i>Lr 2c</i>	50	100.0	64	100.0	114	100
4	Tc* 6 / Democrat (RL6002)	<i>Lr 3</i>	50	100.0	64	100.0	114	100
5	Tc* 6 / Antiversario (RL6007)	<i>Lr 3ka</i>	50	100.0	50	78.1	100	87.7

6	Transfer / 6* TC (RL6010)	<i>Lr 9</i>	25	50.0	33	51.5	58	50.8
7	Tc* 6 / Exchange (RL6004)	<i>Lr 10</i>	16	32.0	5	7.8	21	18.4
8	Hussar (W 976)	<i>Lr 11</i>	46	92.0	57	89.1	103	90.4
9	Selkirk / 6*TC (RL6013)	<i>Lr 14a</i>	50	100.0	64	100	114	100
10	Tc* 6 / Exchange RL6005)	<i>Lr 16</i>	44	88.0	41	64.0	85	74.6
11	Klein Lucero / 6* TC (RL6008)	<i>Lr 17</i>	45	90.0	59	92.2	104	91.2
12	Tc* 7 / Africa 43(RL6009)	<i>Lr 18</i>	31	62.0	55	85.9	86	75.4
13	Tc* / TR (RL6040)	<i>Lr 19</i>	28	56.0	35	46.8	63	55.2
14	Thew (W203)	<i>Lr 20</i>	42	84.0	56	87.5	98	85.9
15	Tc* 6 / RL5406 (RL6043)	<i>Lr 21</i>	42	84.0	43	67.2	85	74.6
16	Lee 310 / 6* TC (RL6012)	<i>Lr 23</i>	50	100.0	64	100.0	114	100.0
17	Tc* 6 / Agent (RL6064)	<i>Lr 24</i>	35	70.0	39	60.9	74	64.9
18	Tc* ? / Transec	<i>Lr 25</i>	50	100.0	64	100.0	114	100.0
19	Tc* 6 / St-1-25 (RL6078)	<i>Lr 26</i>	50	100.0	64	100.0	114	100.0
20	Gatcher (W3201)	<i>Lr27+31</i>	0	0	0	0	0	0
21	CS2D -2M	<i>Lr 28</i>	0		0	0	0	0
22	Tc* 6 / CS / AG#11 (RL6080)	<i>Lr 29</i>	0	0	0	0	0	0
23	Tc* 6 / Terenzio (RL6049)	<i>Lr 30</i>	50	100.0	64	100.0	114	100.0
24	Tc* 6 / Carina (RL6051)	<i>LrB</i>	50	100.0	64	100.0	114	100.0
25	NEPT / 3 / 3* MITU	<i>Lr36</i>	-	-	40	62.5	40	62.5
26	Tc* 6 / VPM (RL6081)	<i>Lr37</i>	-	-	64	100	114	100
27	WGRC10	<i>Lr 41</i>	14	28.0	33	51.5	47	41.2
28	WGRC11	<i>Lr 42</i>	14	28.0	33	51.5	47	41.2

According to results of observation of Trap Nurseries 5<sup>th</sup> ILRTN-14 and 6<sup>th</sup> ILRTN-15 the resistance of 60 % of entries was indicated. Among them 34.1% showed R type. Resistance and moderate resistance to leaf rust have been expressed on lines with genes *Lr17*, *Lr18*, *Lr19*, *Lr20*, *Lr21*, *Lr28*, *Lr29*, *Lr37*, *Lr10+ 27+31*.

Population of *P. tritricina* distributed in Georgia is much differed with populations from other countries by virulence structure (Kolmer *et.al.* 2013; Kolmer and Hughes, 2013; Babayants *et. al.*, 2015).

### Conclusions

Thus, population of leaf rust occurred in Georgia in 2014-2015 was highly virulent. Considerable changes in the populations from year to year have been connected with virulence to genes *Lr9*, *Lr19* and *Lr24*. There was no significant difference in virulence genes and races between populations occurred in the different geographic areas. The level of population diversity was low ( $H_G= 0.14$ ). The results of research are very useful for future breeding programs.

### References

- Ayala F. (1984). Introduction in population genetic//Moscow, "Mir", p.40-51.
- Groth, J.V. & Roelfs, A.P. (1987). The concept of measurement of phenotypic diversity in *Puccinia graminis* on wheat. *Phytopathology*, 77:1394-1399
- Babayants O. Babayants L. Gorash A, Vasilev A, TraskovetskayaV. Galaev A. (2015). Physiologic
- Specialization of *Puccinia tritricina* Erikss and effectiveness of Lr-genes in the South of Ukraine during 2013-2014. *Chilean J. Agric. Res.* vol.75 no.4
- Johnston C.O. and Browder L.F. (1966). Seventh revision of the international register of physiologic races of *Puccinia recondite* f.sp.*tritici* . *Plant Disease Rep.* 50:756-760

- Kolmer J.A, Mert Z., Akan K., Demir R., Keser M., Akin B., Morgounov A. (2013). Virulence of *Puccinia triticina* in Turkey and leaf rust resistance in Turkish wheat cultivars. *European Journal of Plant Pathology*, vol.135, issue 4, pp.703-716.
- Kolmer J. A. & Hughes M. E. (2015). Physiologic specialization of *Puccinia triticina* on wheat in the United States in 2013. *Plant Disease*, 99(9), 1261-1267. DOI: 10.1094/PDIS-12-14-1277-SR
- Long D.L., Kolmer J.A. (1989). A North American System of Nomenclature for *Puccinia recondita* f.sp.*tritici*//*Phytopathology*, 79, 25-529.
- Naskidashvili G., Sikharulidze Z. (1998). Sources of wheat resistance to the leaf rust population in Georgia//*Bull.Georg. Acad. Sxi.* vol.175, 1:129-131.
- Peterson R.F. Campbell A.B., Hannah A.E., (1948). A Diagrammatic Scale for Estimating Rust Intensity on Leaves and Stems of Cereals. *Can. J. Bes.*, 26:496-500.
- Roelfs A.P., Sigh R.P., Saari E.E., (1992). Rust Diseases of Wheat. Concepts and Methods of Disease Management– Mexico, P.F. CIMMYT. 81p.
- Sikharulidze Z., Naskidashvili G, Smirnova L.A. (1993). Virulence Structure of the Wheat Leaf Rust Population in Georgia during 1987-1991. *Cereal Rusts and Powdery Mildews Bulletin*, vol.21, p.182: 35-40.
- Sikharulidze Z., Bedoshvili D. (2005). Virulence of *Puccinia triticina* in Georgia in 2003-2004// *Agromeridian*, 1:88-91
- Yahyaoui A., Ezzrahiri B., Hovmoller M., Jachoor A. (2003). A field guide for cereal diseases management. p.83.
- Zhykovsky P.M. (1973). Coevolution of host-plant and pathogen// *Proceeding of genetic basis of plant breeding for resistance*// "Nauka", p.120-134.

## ALLELOPATHIC EFFECTS OF THREE IMPORTANT WEEDS ON GERMINATION AND EARLY GROWTH OF WINTER WHEAT

Erzsébet NÁDASY\*, György PÁSZTOR, Astrit MUCOLLI

Institute of Plant protection, Georgikon Faculty, University of Pannonia, Hungary

\*Corresponding author: nadasyne@georgikon.hu

### Abstract

The aim of this study was to examine the allelopathic potential of three important weed species in cereals: *Papaver rhoeas*, *Cirsium arvense* and *Convolvulus arvensis* on germination and early growth of winter wheat. Bioassay experiments were made in the laboratory in 2016. The water extracts from air dried and grinded shoots and roots were made in different concentrations (2.5%, 5.0% and 7.5%). Winter wheat seeds were taken into Petri-dishes, treated with 15 ml solutions, and put into thermostat at 20 °C in the dark. The germination percentage was evaluated and the whole length of primary roots and shoots was measured on the 8<sup>th</sup> day of the assay. The statistical analysis has been done by using two-factorial analysis of variance (ANOVA). The strongest inhibitory effect of shoot extracts on root length of winter wheat was detected with *Convolvulus arvensis* followed by *Papaver rhoeas*, inversely root extract of these weeds caused stimulatory effect. It was determined that root extracts of examined weeds stimulated the shoot length of wheat. Stimulation increased with concentrations. On the basis of the results, we established that shoot and root extracts of *Papaver rhoeas*, *Cirsium arvense* and *Convolvulus arvensis* had allelopathic effect on germination and growth of winter wheat seedlings. The allelopathic effect of shoot and root extracts of examined weeds were different. In the experiments we observed both, inhibiting and stimulating effects. The effects were changed by concentrations, and usually the higher concentrations caused the strongest effect.

**Keywords:** *allelopathy, Papaver rhoeas, Cirsium arvense, Convolvulus arvensis, winter wheat.*

### Introduction

Allelopathy is defined as the direct influence of a chemical released from one plant on the development and growth of another, or can be defined like this: it is a form of interference; plants influence each other in chemical way by releasing secondary metabolites. It is known that allelopathic substances are induced by environmental stresses. Allelopathic compounds may be released into the environment from plants by: root exudation, leaching, evaporation and decomposition of plant residues in the soil. Allelochemicals may reduce the needs for herbicide use in weed management. Using allelochemicals alone may not be a perfect weed management technology but it may be a supplementary tool for weed control in the field. It is extremely difficult to demonstrate allelopathy in nature because of the complexity of plant interference which includes positive, negative and neutral effects on each other (Christensen, 1993).

Weeds cause annual losses of about 10% in agricultural production (Anderson, 1987). A lot of weeds are now reaching importance as a factor of weed control for having special types of allelochemicals. These allelochemicals are able to suppress germination and growth of several other weeds, some of which are herbicide resistant.



According to Torra et al. (2008) field poppy (*Papaver rhoeas* L.) is one of the most important broadleaf weed in winter cereals, it is a strong competitor, which can decrease the wheat yield up to 32% (Kazinczi et al. 1997).

Creeping thistle (*Cirsium arvense* L.) is an insufferable, very competitive perennial weed which reduces productivity of crops, pasturelands and fruit trees, so can causes large economic losses (Kazinczi et al., 2001). Allelopathic effects of *Cirsium arvense* plant extracts and residues on agronomic crops and weeds have been reported in many studies (Helgeson-Konzak 1950; Bendal, 1975; Stachon-Zimdahl, 1980).

According to Kazinczi et al., (2004) which reported inhibitory effect of watery extracts from fresh roots, stems and leaves of *Cirsium arvense* on germination and growth of wheat and other crops. Allelochemicals of creeping thistle are vanillic acid, caffeic acid, ferulic acid, p-coumaric acid, chlorogenic acid, p-hydroxybenzoic acid (Hussain et al., 1987)

Field bindweed (*Convolvulus arvensis* L.) is a twining, perennial weed that reproduces by both, seeds and adventitious shoots turn up from a spreading root system. It becomes a problem when competes strongly with many crops such as wheat, corn and causes their yield decrease (Holm et al., 1977; Weaver-Rilly (1982)). Field bindweed has several allelochemicals, as p-Hydroxybenzoic acid, p- coumaric acid, pyrogalllic acid, protocatechuic acid, resorcinol, chlorogenic acid, caffeic acid, syringic acid, ferulic acid, salicylic acid, cinnamic acid (Hegab- Ghareib, 2010)

### Materials and Methods

The study was intended to evaluate the allelopathic effect of three important weed species on germination of winter wheat (*Triticum aestivum* L.). Common poppy (*Papaver rhoeas*) from *Papaveraceae* family, creeping thistle (*Cirsium arvense*) from *Asteraceae* family, and field bindweed (*Convolvulus arvensis*) from *Convolvulaceae* family were collected from different cultivated fields belonging to Georgikon Faculty on May 2016. Roots from stem and leaves were separated in laboratory and after were cut into small pieces and were dried in exsiccator for 24h in 50 °C. The dried roots and shoots were stocked in paper bags in dark condition at room temperature until use. Experiment was conducted in Laboratory in Georgikon Faculty. Allelopathic effects of these three weed species on winter wheat (*Triticum aestivum* L.) were studied in 2016 in two parts, first part for extract of the shoots and second part for the extract of the roots. Watery extracts have been made from *Papaver rhoeas*, *Cirsium arvense* and *Convolvulus arvensis* shoots and roots separately in three concentrations: 2.5%, 5.0% and 7.5%. Solutions were created with tap water and let 24h to soaking. The extracts were filtered after 24 hours, and were used immediately. Fifty pieces of winter wheat seeds were placed into Petri-dishes and treated with 15 ml solutions. In control Petri-dishes 15 ml tap water was used. Petri dishes were put into thermostat and held at 20 °C in dark. All treatments were made in four replications. The germination percentage was studied and the whole length of primary roots and shoots was measured on the 8<sup>th</sup> day of the bioassay. The statistical analysis has been done by using the SPSS computer program, two-factorial analysis of variance (ANOVA). Mean differences was computed using Duncan Multiple Range Test (DMRT). Correlation analysis for the root length and shoot length was done by using Excel program.

## Results and Discussion

The length of the wheat's primary roots are significantly different between plant parts on 1% ( $p < 0.01$ ) significant level (table 1). PAPRH with concentration 7.5% have made significant difference between length of the wheat primary root treated with root extract (144.99 mm) which was 20.28% longer than length of the root treated with shoot extract (120.54 mm). Common poppy 2.5% and 5.0 % can be seen that there is no significant difference between root and shoot extract.

In treatments with CIRAR solutions weren't significant differences between root and shoot extract even that are used three different concentrations. CONAR caused significant differences in all three concentrations in both root and shoot extract. Extracts decreased the growth of wheat's primary root, beside the 2.5% root extract which increased it.

Table 1. The length (mm) of wheat's primary root treated with weeds solutions

Weed concentration %	Root length treated with weed extracts		
	Shoot extract	Root extract	Mean B (Plant part)
Control	127.28	127.28	127.28 <sup>abc</sup>
PAPRH 2.5	114.77	123.55	119.16 <sup>cde</sup>
PAPRH 5.0	127.12	131.38	129.25 <sup>ab</sup>
PAPRH 7.5	120.54 <sup>b</sup>	144.99 <sup>a</sup>	132.77 <sup>a</sup>
CIRAR 2.5	124.27	131.95	128.11 <sup>abc</sup>
CIRAR 5.0	131.57	134.24	132.91 <sup>a</sup>
CIRAR 7.5	129.26	127.79	128.52 <sup>abc</sup>
CONAR 2.5	103.54 <sup>b</sup>	139.16 <sup>a</sup>	121.35 <sup>bcd</sup>
CONAR 5.0	104.54 <sup>b</sup>	117.44 <sup>a</sup>	110.99 <sup>e</sup>
CONAR 7.5	104.81 <sup>b</sup>	126.16 <sup>a</sup>	115.49 <sup>de</sup>
<b>Mean A (Weed concentration)</b>	118.77 <sup>b</sup>	130.39 <sup>a</sup>	
Sig (Plant part)	**		
Sig (Weed concentration)	**		
Sig a x b	**		
CV (%)	10.6		

Values with the same letters are not significant.

\*\* - significant at 0.01 level

Extract from the roots resulted 74.60 mm length of the wheat's shoot in average, 13.47% longer than wheat's shoot from extract of the shoot, where the average length of wheat's shoot were 65.74 mm (table 2). The all root extracts stimulated the growth of wheat's shoot. Shoot extracts from PAPRH 2.5 and 5% decreased the growth of wheat, but contrary all root extracts stimulated it. According to [Ravlic et al. \(2012\)](#) similarly our measuring PAPRH caused significant reduction in shoot length in all treatments compared to the control. Shoot extract of PAPRH inhibited length of shoots while root extract stimulate it. CIRAR solutions increased the shoot length of wheat, but CONAR shoot extracts hindered the shoot development of wheat. Similarly, [Pilipavicius and Romaneckas \(2014\)](#) established that winter wheat shoot length growth was stimulated by all over-ground part water extract of *Cirsium arvense*.

Table 2. The length of wheat seedling's shoot (mm) in different treatments

Weed concentration %	Shoot length treated with weed extracts		
	Shoot extract	Root extract	Mean B (Plant part)
Control	68.57	68.57	68.57 <sup>cd</sup>
PAPRH 2.5	64.12	69.27	66.69 <sup>cd</sup>
PAPRH 5.0	60.91 <sup>b</sup>	70.56 <sup>a</sup>	65.75 <sup>cd</sup>
PAPRH 7.5	68.41 <sup>b</sup>	83.44 <sup>a</sup>	75.92 <sup>ab</sup>
CIRAR 2.5	70.83	72.32	71.58 <sup>bc</sup>
CIRAR 5.0	77.36	76.72	77.04 <sup>ab</sup>
CIRAR 7.5	81.53	78.44	79.99 <sup>a</sup>
CONAR 2.5	51.43 <sup>b</sup>	74.33 <sup>a</sup>	62.88 <sup>d</sup>
CONAR 5.0	55.61 <sup>b</sup>	76.91 <sup>a</sup>	66.26 <sup>cd</sup>
CONAR 7.5	58.65 <sup>b</sup>	75.39 <sup>a</sup>	67.02 <sup>cd</sup>
<b>Mean A (Weed concentration)</b>	65.74 <sup>b</sup>	74.60 <sup>a</sup>	
Sig (Plant part)	**		
Sig (Weed concentration)	**		
Sig A x B	**		
CV (%)	13.7		

Values with the same letters are not significant.

\*\* - significant at 0.01 level

Table 3. is showing the percentage (%) of wheat germination which are not significantly different between plant part. According to [Ravlic et al. \(2012\)](#) watery extract from fresh part of PAPRH significantly reduced germination of wheat. In our experiment root extracts not significantly influenced the germination. Application of shoot extract of PAPRH resulted in higher germination percentage of wheat except for 2.5% treatment.

Table 3. The percentage (%) of wheat germination by different weed solutions

Weed concentration %	Percentage (%) of wheat germination		
	Shoot extract	Root extract	Mean B (Plant part)
Control	93.5	93.5	93.50
PAPRH 2.5	91	93.5	92.25
PAPRH 5.0	96	89.5	92.75
PAPRH 7.5	95.5	91.5	93.50
CIRAR 2.5	98	88.5	93.25
CIRAR 5.0	95	95.5	95.25
CIRAR 7.5	89	95	92.00
CONAR 2.5	95	95.5	95.25
CONAR 5.0	96.5	95	95.75
CONAR 7.5	96.5	93.5	95.00
<b>Mean A (Weed concentration)</b>	94.6	93.1	
Sig (Plant part)	Ns		
Sig (Weed concentration)	Ns		
Sig A x B	Ns		
CV (%)	5.0		

ns – not significant

Pilipavicius and Romaneckas (2014) established that over ground part of creeping thistle water extracts at low concentrations have tendency to stimulate winter wheat germination which is similar to our experimental results. Watery extracts prepared from *C. arvense* rootstock showed similar regularity showing stimulation and suppression effects on winter wheat grain germination as in its over-ground part. In this experiment root extract in low concentration inhibited, and in high concentration stimulated the germination.

According to Yarnia et al. (2008) all weed extracts of CONAR (leaf, shoot, root, flower extracts) with 4 different concentration (1:5, 1:10, 1:15, and 1:20) decreased germination but root extract showed highest prohibition, extracts of root and other parts of weed at 1:5 concentration totally inhibited germination. In our experiment we did not experienced germination hindering effect of field bindweed extracts, however these results are not significant.

### Conclusion

On the basis of our results we established, that shoot and root extracts of *Papaver rhoeas*, *Cirsium arvense* and *Convolvulus arvensis* had allelopathic effect on germination and early growth of winter wheat. *Convolvulus arvensis* considerably influenced the development of wheat, followed by *Cirsium arvense*. The root extracts stimulated the growth of winter wheat, while shoot extracts inhibited it. Stimulating effect depended on concentrations of extracts.

### References

- Anderson, W.P. (1987): Weed science as it relates to crop production. In: CRC Handbook of plant science in Agriculture. Vol. II. (Ed. B. R. Christie). CRC. Press Inc. Boca Raton. Florida: 100-113.
- Bendall, G.M. (1975): The allelopathic activity of Californian thistle (*Cirsium arvense* (L.) Scop.) in Tasmania. Weed Research 15: 77-81.
- Christensen, S. (1993): Weed suppression in cereal varieties. Min. Agric. Statens Planeavlsforsog. Denmark. Ph.D. thesis, 1. 104.
- Hegab, M.M., Ghareib, H.R. (2010): Methanol extracts potential of field bindweed (*Convolvulus arvensis* L.) for wheat growth enhancement. International Journal of Botany 6 (3): 334-342.
- Helgeson, E.A., Konzak, R. (1950): Phytotoxic effects of aqueous extracts of field bindweed and Canada thistle. A preliminary report, N. Dak., Agr. Expt. Sta. Bimo. Bul. 12:71-76.
- Holm, L.G., Plucknett, D.L., Pancho J.V., Herbenger, J.P. (1997): The world's worst weeds. University Press of Hawaii, Hawaii, USA., 609.
- Hussain, F., Khan, T.W., Hussain, A. (1987): Allelopathic effects of *Cirsium arvense* (L.) Scop. in modern trends of plant science research in Pakistan. Proceedings of the Third National Conference of Plant Scientists, Department of Botany. Peshawar University of Peshawar: 24-28.
- Kazinczi, G., Béres, I., Mikulás J., Nádasy, E. (2004): Allelopathic effect of *Cirsium arvense* and *Asclepias syriaca*. Journal of Plant Diseases and Protection, 19: 301-308.
- Kazinczi, G., Béres, I., Narwal, S.S. (2001): Allelopathic plants. 1. Canada thistle [*Cirsium arvense* (L.) Scop.]. Allelopathy Journal 8: 29-40.
- Kazinczi, G., Mikulás, J., Hunyadi, K., Horváth, J. (1997): Allelopathic effects of weeds on growth of wheat, sugarbeet and *Brassica naous*. Allelopathy J. 4: 335-340.

- Pilipavicius, V., Romaneckas, K. (2014): Allelopathic activity of creeping thistle water extracts on germination and early growth of winter wheat. *Bulgarian Journal of Agricultural Science*, 3: 607-612.
- Ravlic, M., Balicevic, R., Knezevic, M., Ravlic, I. (2012): Allelopathic effect of scentless mayweed and field poppy on seed germination and initial growth of winter wheat and winter barley. *Herbologia an International Journal on Weed Research and Control*, 13: 1-7.
- Stachon, W.J., Zimdahl, R.L. (1980): Allelopathic activity of Canada Thistle (*Cirsium arvense*) in Colorado. *Weed Science*, 28: 83-86.
- Torra, J., Gonzalez J.L., Andujar, J. Recasens. (2008): Modelling the population dynamics of *Papaver rhoeas* under various weed management systems in Mediterranean climate. *Weed Research*, 48: 136-146.
- Yarnia, M., farajzadeh, E., Ahmadzadeh, V., Noubari, N. (2008): Allelopathic effects of *convolvulus arvensis* on wheat (*triticum aestivum* L.) germination and growth. *Agroecology journal (journal of new agricultural science)*, 4: 83-99.
- Weaver, S.E., Rilly, W.R. (1982): The biology of Canadian weeds. 53-*Convolvulus arvensis* L. *Can. Plant Sci.*, 62: 461-472.

## MODEL STUDY TO INVESTIGATE THE TOXIC INTERACTION BETWEEN TEBUCONAZOLE FUNGICIDE AND LEAD ACETATE ON CHICKEN EMBRYOS

Géza SZEMERÉDY<sup>1</sup>, Rita SZABÓ<sup>1</sup>, Éva KORMOS<sup>1</sup>, Csenge SZALAI<sup>1</sup>, József LEHEL<sup>2</sup>,  
Péter BUDAI<sup>1</sup>

<sup>1</sup>University of Pannonia, Georgikon Faculty, Institute of Plant Protection, H-8360 Keszthely Deák F. u. 16.

<sup>2</sup>University of Veterinary Medicine, Department of Food Hygiene, H-1078 Budapest, István u. 2.

Corresponding author: [tjjsvanvervest@gmail.com](mailto:tjjsvanvervest@gmail.com) or [lehel.jozsef@univet.hu](mailto:lehel.jozsef@univet.hu)

### Abstract

The aim of this study was to determine the individual and combined toxic effects of MYSTIC 250 EC fungicide (tebuconazole 250 g/l) and lead acetate on the development of chicken embryos. The chicken eggs were dipped in the solution or emulsion of the test materials for 30 minutes on the first day of incubation (day 0). The applied concentration of lead acetate was 0.01% and of fungicide MYSTIC 250 EC was 0.1%. The chicken embryos were examined on day 19 of incubation by the followings: rate of embryo mortality, body mass, type of developmental anomalies by macroscopic examination. The body mass was evaluated statistically by the one-way ANOVA, the embryo mortality and the developmental anomalies was analysed by Fisher test. The body weight of the embryos in all treated groups applied the test items individually or simultaneously was significantly decreased compared to the control group. The embryo mortality was increased statistically in the embryos treated with lead acetate alone or in combination with MYSTIC 250 EC fungicide. The frequency of developmental abnormalities was sporadic in all treated groups. Our teratogenicity study revealed that, the individual toxic effect of lead acetate and tebuconazole containing fungicide formulation (MYSTIC 250 EC) was embryotoxic but not teratogenic in chicken. Based on the results, there is an addition type toxic interaction between tebuconazole containing MYSTIC 250 EC and lead acetate resulted in increased embryotoxicity due to the concomitant exposure.

**Keywords:** Ecotoxicology, Tebuconazole, Toxic interaction, Lead acetate, Chicken embryo

### Introduction

The chemical plant protecting process is one of the most important polluting activities in the agricultural production. The ecosystem of a given habitat can be contaminated simultaneously by sprayed pesticides and other xenobiotics, e.g. heavy metals due to the agricultural activities during the plant protecting processes. Therefore, the chemical load can be occurred as a complex problem, so the combined toxic effect, i.e. toxic interaction of at least two substances can be expected and the components can modify the effect of each other. Recently, the examination of the combination of heavy metals and other chemicals gained significant ground in both avian (Fejes *et al.*, 2001; Kertész, 2001) and mammalian (Institóris *et al.*, 2001; Pecze *et al.*, 2001) toxicology research studies. Furthermore, the interaction effects are examined not only in the field of ecotoxicology, but also in all other areas that deal with health care and chemical safety issues (Oskarsson, 1983; Danielsson *et al.*, 1984; Speijers and Speijers, 2004).

The different agricultural areas offer sources of food, shelter and breeding places to wild birds, therefore the sprayed pesticide and other chemical substances can contaminate not only the adults, but the embryos developing in egg, as well. The eggs of the wild birds may be

exposed to different chemicals on the cultivated lands at the same time and their toxic effects may appear in embryo mortality and developmental anomalies. Teratological tests carried out on avian embryos provide useful data for environmental protection and facilitate the development of environmental-friendly chemical plant protection techniques (Várnagy *et al.*, 1996). The aim of our study was to examine the toxic effect and interaction of lead acetate and a tebuconazole containing fungicide (Mystic 250 EC) on chicken embryos after administration of single compounds and simultaneously by immersion technique.

### Materials and Methods

Farm chicken eggs with good fertile potential (Goldavis Ltd., Hungary) were used in the experiment. The eggs based on their size and weight were divided into four homogenous groups (40 eggs in each), and were incubated in Ragus type table incubator (Vienna, Austria) ensuring the required temperature (37–38°C), the relative humidity (65–70%) and the daily rotation. The chicken eggs were dipped into the solution or emulsion of the test materials for 30 minutes on day 0 of incubation. During the single and simultaneous administration lead acetate (Reanal-Ker Ltd., Budapest) with a concentration of 0.01% and 0.1% of Mystic 250 EC tebuconazole containing fungicide (Nufarm Hungary Ltd., 360 g/l) corresponding to that used in plant protection practice were applied. The control group was treated with tap water. The details of the experimental design are presented in *Table 1*. All eggs and embryos were examined and processed on day 19 of incubation. During the processing rate of embryo mortality, body mass of embryos and type of developmental anomalies were registered. The distribution of body weight of the live embryos was controlled by Comparison-Quantile Plot and was analysed statistically by One-Way ANOVA. Data of groups were compared by Tukey and Dunnett tests. The statistical analysis of the results of embryo mortality and developmental abnormalities were performed by Fisher's exact test (Baráth *et al.*, 1996).

Table 1. Experimental design

Group	No of egg	Treatment (concentration)	
		Lead acetate	Mystic 250 EC
I (control)	40	-	-
II	40	0.01%	-
III	40	-	0.1%
IV	40	0.01%	0.1%

### Results and Discussion

The average body weight of the embryos was 19.51±1.11 g in Group II that was significantly lower as compared to the control (20.34±1.28 g, p=0.05). Due to tebuconazole (0.1%) treatment the body weight was 19.32±1.4 g that was significantly lower than the control. The simultaneous administration of lead acetate (0.01%) and tebuconazole resulted significant decrease (p=0.001) of average body weight (Group IV: 18.48±1.22 g) as compared to the control

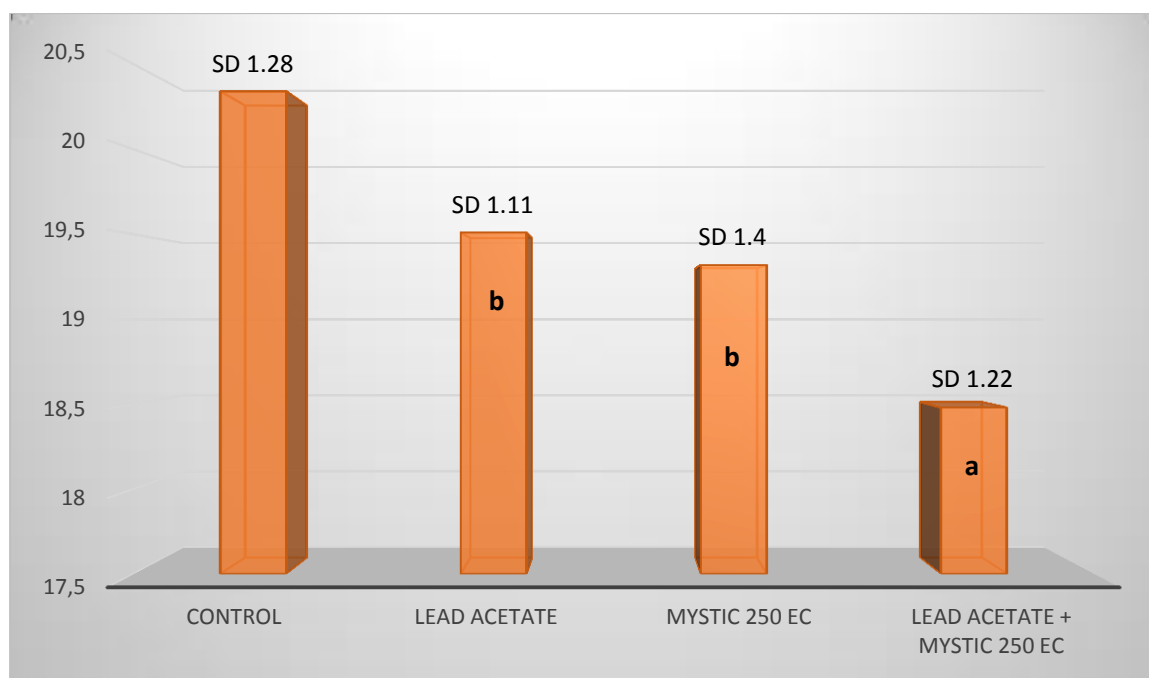


Figure 1. Body weight (g) of the chicken embryos on day 19 of incubation from teratogenicity test on Mystic 250 EC and lead acetate after single and simultaneous administration

a: Significance decrease as compared to the control( $p=0.001$ )

b: Significance decrease as compared to the control( $p=0.05$ )

The results of the embryo mortality is presented in *Table 2*.

There was one died embryo in the control group (2.7 %). The single administration of lead acetate increased the mortality up to 26.6%. The changes were statistically significant as compared Group I (control). The application of 0.1% Mystic 250 EC caused 2.6% of mortality in the treated embryos in Group III.

Table 2. Embryonic death and developmental anomalies from teratogenicity test of lead acetate and Mystic 250 EC in chicken embryos after single and combined administration

Group	Treatment	No of embryos showing abnormality/No of live embryos	Death No/ No of live embryos	Rate of developmental anomalies (%)	Mortality (%)
I	Control	0/37	1/37	0	2.6
II	Lead acetate	3/30	8/30 <sup>a</sup>	10	26.6
III	Mystic 250 EC	1/37	1/37	2.7	2.6
IV	Lead acetate + Mystic 250 EC	3/31	7/31 <sup>a</sup>	9.6	22.5

a: Significant difference as compared to the control ( $p=0.05$ )

Due to the simultaneous administration of 0.01% lead acetate and 0.1% tebuconazole induced significant increase of embryomortality 22.5%. Developmental abnormalities were not recorded in the control group (*Table 2*). The 0.01% lead acetate induced leg deformation and open abdomen (Group II: 3 embryos) without statistical difference as compared to Group I. One embryo shows teratogenic malformation after a single administration of Mystic 250 EC (leg deformation, Group III). The simultaneous administration of the fungicide (0.1%) and lead acetate induced leg deformation, growth retardation and beak malformation in the survivor embryos (Group IV). The results of the individual teratogenicity studies on lead



acetate in chicken are in accordance with results of toxicity studies in other species. Depending on the dose, lead has embryotoxic potential and may cause developmental anomalies (Ferm and Carpenter, 1967; Várnagy and Budai, 1995). Similar results were found in chicken embryos treated with 0.01% lead acetate (lower body weight, higher rate of embryo mortality) but the developmental anomalies were not significant versus the control group (Juhász, 2009). Tebuconazole is a common triazole fungicide that has been extensively used for fungi control. Jinghua *et. al.*(2016) showed that tebuconazole could reduce cell viability, disturb normal cell cycle distribution and induce apoptosis of human placental trophoblast cell line HTR-8/SVneo (HTR-8). Bcl-2 protein expression decreased and the level of Bax protein increased after tebuconazole treatment in HTR-8 cells. The results demonstrated that this fungicide induced apoptosis of trophoblast cells via mitochondrial pathway. Tebuconazole suppressed human trophoblast invasion and migration through affecting the expression of protease, hormones, angiogenic factors, growth factors and cytokines. As the invasive and migratory abilities of trophoblast are essential for successful placentation and fetus development, their findings suggest a potential risk of triazole fungicides to human pregnancy. According to the published literature the toxicity of many pesticide combinations is at least additive. In some cases pesticide mixtures, if they particularly contain insecticide component, have been shown to be synergistic effects, with reported increase in toxicity up to 100-fold. However, these effects are species, time and dose dependent, therefore difficult to predict it routinely (Thompson, 1996).

### Conclusions

The single treatment of lead acetate with 0.1% concentration induced embryotoxic effect in chicken embryo which manifested in significant decrease of body weight and elevated rate of embryo mortality. The tebuconazole containing MYSTIC 250 EC plant protection product with fungicidal action was also embryotoxic on chicken embryos and resulted statistically significant reduce of body weight. Due to the simultaneous application of lead acetate and Mystic 250 EC the embryo mortality was statistically higher than the individual effect. Developmental abnormalities were sporadically observed due to the single and concomitant administration (leg and beak deformation, growth retardation, open abdomen). Based on the results, there are presumably addition-type toxic interaction between lead acetate and Mystic 250 EC that highly reduce the viability of the embryos.

### Acknowledgement

The publication is supported by the EFOP-3.6.3-VEKOP-16-2017-00008 project. The project is co-financed by the European Union and the European Social Fund.

### References

- Baráth, Cs., Itzés, A., Ugrósdý, Gy. (1996). Biometrics. Mezőgazda Publishing, Budapest. 37-217.
- Danielsson, B.R.G., Oskarsson, A., Dencker, L. (1984). Placental transfer and fetal distribution of lead in mice after treatment with dithiocarbamates. Arch. Toxicol. 55: 27-33.
- Fejes, S., Várnagy, L., Budai, P., Takács, I. (2001). A réz-szulfát és a BI 58 EC interakciós vizsgálata házityúk embrión. TOX'2001 Konferencia. Eger. Absztraktok C2-4.
- Ferm, V.H., Carpenter, S.J. (1967). Teratogenic effect of cadmium and its inhibition by zinc. Nature. 216: 1123.

- Institóris, L., Siroki, O., Dési, I. (2001). Kombinált cipermetrin Hg<sup>2+</sup> és As<sup>3+</sup> expozíció immuntoxikológiai vizsgálata patkányon. TOX'2001 Konferencia. Eger. Absztraktok C1–2.
- Jinghua Z., Jianyun Z., Feixue L., Jing L. (2016). Triazole fungicide tebuconazole disrupts human placental trophoblast cell functions. *Journal of Hazardous Materials*. Volume 308, 5 May 2016, Pages 294–302.
- Juhász, É. (2009). Herbicidek (Stomp 330 EC, Dikamin D) és nehézfémek (réz, kadmium, ólom) egyedi és együttes méreghatása madárembriókon. Doktori (PhD) értekezés. PE GK. Keszthely.
- Kertész, V. (2001). Nehézfémek és PAH-vegyületek embrionális fejlődésre gyakorolt hatása madarakon. Doktori (PhD) értekezés. SZIE MKK. Gödöllő.
- Oskarsson, A. (1983). Redistribution and increased brain uptake of lead in rats after treatment with dethyldithiobarbamate. *Arch. Toxicol.* 6: 279-284.
- Pecze, L., Papp, A., Nagymajtényi, L. (2001). Kombinált toxikus expozíció hatása az in vivo regisztrált hippokampális populációs spike-ra patkányban. TOX'2001 Konferencia. Eger. Absztraktok C1–4.
- Speijers, G.J.A., Speijers, M.H.M. (2004). Combined toxic effects of mycotoxins. *Toxicology Letters*. 153: 91-98.
- Thompson, H.M. (1996). Interaction between pesticides; A review of reported effects and their implications for wildlife risk assessment. *Ecotoxicology*. 5: 59-81.
- Várnagy, L., Budai, P. (1995). Agrochemical hygiene. *Mezőgazda Publishing*, Budapest. 45., 50-52., 64-65., 70-83.
- Várnagy, L., Varga, T., Hlubik I., Budai P., Molnár, E. (1996). Toxicity of the herbicides Flubalex, Fusilade S and Maloran 50 WP to chicken administration as single compounds or in combination. *Acta Vet. Hung.* 44: 3. 363-376.

## VIROLOGICAL EXAMINATION OF PUBLIC ORNAMENTAL PLANTS

György PÁSZTOR\*, Erzsébet NÁDASY IHÁROSI, András TAKÁCS

Plant Protection Institute, University of Pannonia, Georgikon Faculty, Hungary

\*Corresponding author: pasztor018@gmail.com

### Abstract

Ornamental plants are gaining an increasing role because of the increasing urbanization. In Hungary, about 30-32 million annuals are cultivated annually. The annual ornamental plants dominate in the public spaces of Hungary, where 30 - 40 of the species are generally cultivated. The widespread species of the annuals are the Cockscomb species (*Celosia spp.*), Petunia species (*Petunia spp.*), Begonia (*Begonia spp.*), Sweet potato (*Ipomoea batata*) and Impatiens (*Impatiens spp.*). The purpose of our research was to determine the natural viral infection of planted plant material and the epidemiological significance of these viruses. Our study was carried out from samples collected from the flower beds in the spring, summer and autumn (depending on the time of planting) of 2016, from Keszthely, Zalaegerszeg, Óhid, Túrje, Tekenye, Sümeg and Zalaszentgrót settlements in Zala county. One of the most common methods for diagnosing plant viruses was used - the double antibody sandwich (DAS ELISA). In case of 56 samples, viral infections were detected from ten samples. Tomato spotted wilt virus (TSWV) was present in five samples (two *Celosia*, one *Impatiens*, one *Begonia*, one *Tagetes*) after serological testing. In five-five cases, Tomato mosaic virus (ToMV) was diagnosed in one *Tagetes*, two *Callistephus*, two *Dianthus*, as well potato virus A (PVA) in two *Begonia*, two *Celosia* and one *Impatiens*. Potato Y virus (PVY) was found in three cases (one *Celosia*, one *Begonia*, one *Tagetes*) and in one case Cucumber mosaic virus (CMV)(one *Impatiens*). The registered viruses from these species have never been detected before not just in Hungary, but worldwide, according to the „Viruses on Plant Virus Descriptors and Lists” from the VIDE Database web site.

**Keywords:** *annual, ornamental plants, virus infection, serological methods*

### Introduction

Thanks to the ever-increasing urbanization, ornamental plants have an increasing role in our public spaces. Annual or perennial ornamental plants become the most decisive elements of our gardens, parks and public spaces. Worldwide, the goal is to crop plants whose decorative value does not decrease as a result of stress. But the examination of virus resistance from the producer side is not essential. The aim of the breeding is to emphasize the decorative value of ornamental plants. Because of that, it does not know exactly which viruses can infect those plants, and how the potential of infection affects the spread of viruses. Not to mention, as a result of viral infection, the lifespan and decorative value of these plants are significantly reduced. In Hungary, about 30-32 million annuals, 10-12 million bishops are cultivated annually (Boróczy, 2002), out of which 25% is in public space and 75% in private gardens. Cultivation of plants is essentially under greenhouse conditions, and after spring, they are planted in flower beds and in various flower pots. Apart from their decorative value, they have an impact on our mood and have a big role to play in creating a good city scene. In the public areas of Hungary, the annual ornamental plants dominate mostly, which was confirmed during the survey and collection of the samples. Nearly 100 species are used in flower beds,

30 - 40 of which are commonly cultivated. The number of perennials in areas of the survey are considerably lower. From the annuals, the widespread species are the cormorant species (*Celosia spp.*), petunia species (*Petunia spp.*), begonia (*Begonia spp.*). The new entrants are the sweet potato (*Ipomoea batata*) and the impatiens species (*Impatiens spp.*). With the breeder's work this list is constantly expanding, the number of ornamental plants we have today is over 100 species. In Hungary, ornamental plants are grown in fragmented areas and in outdated facilities, so it cannot keep up with the continued expansion of demand in any product group. Accordingly, 95% of propagating material comes from imports. The largest importers in Europe are the Netherlands, Italy and Hungary (Jankuné, 2010). As a result of global warming and climate changes in future, in Hungary, more ornamental plants - which can easily adapt to drier climatic conditions - should be planted in public space, and provide people with the appearance of nature between concrete walls. Virology of plant material from abroad is, in many cases, either inadequate or completely absent, hence increasing the risk of supply infected propagating material, and even new viruses may enter the domestic flora. In order to avoid it, the examination of the Hungarian plant stock requires continuous attention so that the potential host plants are continuously examined and filtered. The aim of the experiment was the virological examination of the annual ornamental plants of public spaces, and the determination of the epidemiological significance of detected viruses.

### Materials and methods

Our study was carried out from samples collected from the flower beds of the spring, summer and autumn (depending on the planting of the ornamentals) 2016, from Keszthely, Zalaegerszeg, Óhid, Túrje, Tekenye, Sümeg, Zalaszentgrót settlements, in Zala county, near Keszthely, Hungary. In total 56 leaf samples from the annuals were tested: *Impatiens walleriana* (14), *Ipomoea batata* (7), *Celosia argentea* (7), *Begonia* species (5), *Tagetes* species (5), *Callistephus chinensis* (7), *Zinnia elegans* (4), *Dianthus barbatus* (5), *Petunia* species (3). Our aim was to collect samples that showed symptoms of viral infection, but there were also samples from asymptomatic individuals, as well. The collected samples was stored frozen until the serological test was done. In order to detect viral infection, DAS ELISA serological method was used. In the this survey Cucumber mosaic virus (CMV), Tobacco mosaic virus (TMV), tomato spotted wilt virus (TSWV), potato Y virus (PVY), Potato X virus (PVX), potato virus A (PVA) and tomato mosaic virus (ToMV) reagents were used. To identify the new viral host plant relationships, „Viruses on Plant Virus Descriptors and Lists” from the VIDE Database web site was used.

### Results and discussion

The samples were grouped according to the collected plant species, so that the evaluation could encompass a particular region. Of the fifty-six samples, ten were infected with viruses (Table 1.). There were no viral infections detected in three species (*Ipomoea batata*, *Zinnia Elegans* and *Petunia x hybrida*). The tomato spotted wilt virus (TSWV) was present in five samples (*Impatiens*, *Begonia*, *Celosia*, *Tagetes* and *Dianthus* species) In five-five cases, Tomato mosaic virus (ToMV) (*Celosia*, *Tagetes*, *Impatiens*, *Dianthus* and *Callistephus* species) and Potato virus A (PVA) (*Impatiens*, *Begonia*, *Celosia*, *Tagetes* and *Dianthus* species) were also diagnosed. Potato Y virus (PVY) was found in three cases (*Begonia*, *Celosia* and *Tagetes* species) and in one case Cucumber mosaic virus (CMV) were found in an *Impatiens walleriana* sample (Table 2.) Tobacco mosaic virus (TMV) and potato X virus (PVX) could not be found in any of the samples. In four cases, virus complex was present. In the case of one *Begonia* sample and a *Celosia argentea*, complex virus infection was detected,

the sample showed TSWV, PVY, PVA infection complex. In one *Tagetes* sample presence of TSWV, ToMV, PVY complex was diagnosed, and in one *Impatiens walleriana* the TSWV, CMV, PVA complex. Five of the seven tested viruses were identified during the test.

Table 1: The viral infection of the species according to the DAS ELISA serological test (Source: Author's elaboration based on the obtained results)

Plant species	Amount of collected samples	Amount of infected samples
<i>Impatiens walleriana</i>	14	1
<i>Ipomoea batata</i>	7	0
<i>Celosia argentea</i>	7	2
<i>Begonia species</i>	5	2
<i>Dianthus barbatus</i>	7	2
<i>Callistephus chinensis</i>	4	1
<i>Tagetes species.</i>	5	1
<i>Zinnia elegans</i>	4	0
<i>Petunia x hibryda</i>	3	0
All samples:	56	10

Table 2: The viruses found in the investigated samples (highlighting new host-virus relationships in red) (Source: Author's elaboration based on the obtained results)

	<i>Impatiens walleriana</i>	<i>Begonia spp.</i>	<i>Celosia argentea</i>	<i>Tagetes spp.</i>	<i>Dianthus spp.</i>	<i>Callistephus spp</i>
TSWV	1	1	1	1	1	0
CMV	1	0	0	0	0	0
PVY	0	1	1	1	0	0
PVA	1	1	1	1	1	0
ToMV	0	0	1	1	2	1

More than 18% of the examined plants has been found infected by polyphagous viruses. In four cases, complex infection has been founded. Although the extent of the infection is not significant, its presence or the complexity of the viruses is, as much of the viral infections in these ornamental plants are not included in the international database. The test highlights how unproven propagation is a growing problem. Several viruses have been detected earlier amongst the examined species (Table 3.), but infections discovered during the research have revealed new host-parasitic relationships. These relationships were characterized from a symptomatic point of view. PVA virus infection has not been described yet for any ornamental plant either of the following: *Impatiens Walleriana*, *Begonia species*, *Celosia argentea*, *Tagetes species*, *Dianthus species* and *Callistephus species*. Similarly, it has not been described that the TSWV, ToMV and PVY can infect the *Celosia argentea*, PVY the *Begonia* and *Tagetes species* and the ToMV the *Tagetes*, *Dianthus species* and *Callistephus chinensis* too.

Table 3.: Previously identified viruses in the examined plant species

<i>Impatiens walleriana</i>	<i>Begonia species</i>	<i>Celosia argentea</i>	<i>Tagetes species</i>	<i>Dianthus species</i>	<i>Callistephus species</i>
-----------------------------	------------------------	-------------------------	------------------------	-------------------------	-----------------------------

<b>TSWV</b>	Klinkowsky(1968)	Klinkowsky(1968)	Not identified	Klinkowsky(1968)	Albouy(1998)	Klinkowsky(1968)
<b>CMV</b>	Flasinski(1995)	Klinkowsky(1968)	Not identified	Klinkowsky(1968)	Aminuddin(1993)	Klinkowsky(1968)
<b>PVY</b>	Not identified	Not identified	Not identified	Not identified	Not identified	Not identified
<b>PVA</b>	Not identified	Albouy(1998)	Not identified	Not identified	Not identified	Not identified
<b>ToMV</b>	Not identified	Not identified	Not identified	Not identified	Not identified	Not identified

## Conclusions

The viral infection of ornamental plants is a less-researched topic in Hungary. The importance of the research is underpinned by the current uncontrolled propagating material flow into domestic markets, with new diseases, including viruses that can enter the ecosystem of the Carpathian Basin. In order to prevent this, research has been set up to identify new host plants. Increasing emphasis should be placed on the destruction of infected plants, but the more constant monitoring of the propagation material. This will reduce the risk of viruses became epidemic, which in many cases leads to economic damage. Results of this survey carrying important economic and viral epidemiological informations, as these ornamental plants can spread easily and can also cause damage to other important horticultural and arable crops. The results of the current research also show the spread of TSWV, which is a dangerous polyphagous virus, infecting crops and ornamental plants too (Parella, 2003). The spread of the virus is particularly important because the infection is carried by viral vectors like thrips which, due to the warming, can spread not only in the greenhouses but also on the field crops. By continuous monitoring of propagation material and the destruction of contaminated crops, economic damage can be reduced or prevented (Horváth, 1999/a). The choice of appropriate cultivation technology plays an important role in ornamental crop production as well. In many cases, providing adequate protection against pests and pathogenic microorganisms is difficult. The biggest problem is the plant pathogenic viruses, since chemical plant protection is not solved (Horváth, 1999/b). One option is prevention against viral diseases. As with other plants, with herbaceous ornamental plants, because of the unlimited quantities of propagating material and goods, the viruses that have not yet been counted in our country have significantly increased. It is a concern as the economic significance of these plants is less so that their susceptibility to viruses is less explored. Based on previous research results, it can be concluded that the ornamental plant growing industry has no production group that does not affected infected by the viral infections.

## References

- Albouy, J., Devergne, J. C. (1998): Maladies à virus des plantes ornementales (Diseases with viruses of ornamental plants). Institut National de la Recherche Agronomique, Paris, pp: 96, 458-471.
- Aminuddin S. K., Srivastava, K. M. - Singh B. P. (1993): Natural infection of cucumber mosaic virus on *Dianthus barbatus* in India. *Plant. Pat.* p: 811-813.
- Boróczky M., Gerzson L., Hámori Z., Honfi P., Imre Cs., Jámborné B. E., Komiszár L., Turiné N. T., Neményi A., Schmith G., Szafián Zs., Szántó M., Szóriné Zs. A., Tillyné M. A., Tóth I., Farkas Zs. (2002): *Növényházi dísznövények termesztése (Cultivation of herbaceous ornamental plants)*. Mezőgazda Kiadó, Budapest.
- Flasinski, S. W., Scott, O. W., Barnett, S., Sun, C. (1995): "Diseases of *Peperomia*, *Impatiens*, and *Hibbertia* Caused by Cucumber mosaic virus," *Plant. Dis.*, Clemson University, Clemson, p. 843.
- Horváth. J. (1999/a): *A vírusok osztályozása (Classification of viruses)*. Földművelésügyi és Vidékfejlesztési Minisztérium, Budapest pp: 69-76.

- Horváth J., Gáborjányi R. (1999/b): Növényvírusok és virológiai vizsgálati módszerek (Plant viruses and virological test methods). Mezőgazda Lap- és Könyvkiadó Kft, Budapest. p. 415-425.
- Jankuné K. Gy., Kozak A., Radócné K. T. (2010): A hazai dísznövényágazat helyzete és kilátásai (The position and prospects of the domestic ornamental plant sector). Agrárgazdasági Kutató Intézet, Budapest, p. 61-65.
- Klinkowski, M., Uschdraweit, H. A. (1968): Die Freilandprimer virose (Staudenvirose) in „Pflanzlichevirologie”(Viral diseases of annuals in the plant virology) Volume II. Akademie-Verlag, Berlin, p. 169.
- Parrella, G. - Gognalons, P. - Gebre, K. - Selassié, G.- Vovlas, C. - Marchoux, G. (2003): An Update of the host range of tomato spotted wilt virus. Journ. Plant Path, p. 227-260.

## ISOLATION OF INSECTICIDAL MOLECULES FROM CASSAVA AND FORMULATION OF BIO-PESTICIDES AGAINST SOME IMPORTANT PESTS OF HORTICULTURAL CROPS

Unni Krishnan JITHU<sup>1\*</sup>, Cheruvandasseri Arumughan JAYAPRAKAS<sup>1</sup>, George AJESH<sup>1</sup>, Narendranath Rajambika LEKSHMI<sup>1</sup>, Lekshmikutty Shivashankaran RAJESWARI<sup>1</sup>, Srinivas LEENA<sup>2</sup>, Jayakumar Rajeswari JITHINE<sup>1</sup>

<sup>1</sup>Biopesticide Laboratory, Division of Crop Protection, ICAR-Central Tuber Crop Research Institute, Thiruvananthapuram- 695017, Kerala, India

<sup>2</sup>Krishi Vinjyan Kendra, ICAR-Central Plantation Crop Research Institute, Thiruvananthapuram-671124, Kerala, India

\*Corresponding author: jithuukrishnan@gmail.com

### Abstract

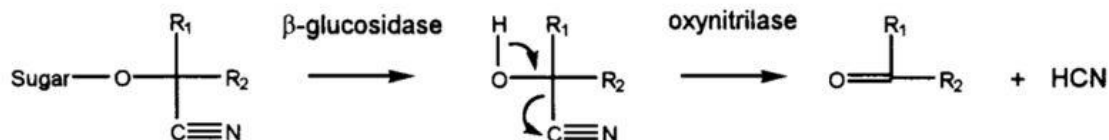
Injudicious use of chemical inputs in agriculture poses challenge to sustainable agriculture. Cassava (*Manihot esculenta* Crantz) is a climate resilient crop cultivated in tropical and subtropical countries for its tuber as food, feed, and industrial products. Nevertheless, owing to the presence of Cyano-glucosides, leaves and tuber rinds are often thrown as waste or rather underutilized. The insecticidal principles from such bio-waste have been isolated and made formulations to manage certain important pests of horticultural crops. Current management strategy relies upon application of very toxic synthetic insecticides, although complete control of the pests could not be achieved. An extensive laboratory and field study was conducted on insects of contact applications were possible. Excellent package of control was developed both by prophylactic and curative means against the banana weevil (*Odoiporous longicollis* Oliver and *Cosmopolitus sordidus* Germer) management and over many of the noxious pests of vegetable and fruit crops. Lethality studies suggest the scope of cassava bio-pesticides as an alternative over synthetic pesticides specifically to the borer and sucking pests. The thick waxy coating of mealy bug and white fly were a major hurdle to the synthetics to act while cassava bio-pesticide formulation removes it by a spray to expose it and kill. Dose, concentration and application strategies of the bio-formulation have been standardised individually for some of the major pests, and large scale validation was done at the farmers' fields in three geographically and agro-climatically distinct zones of Kerala state, India and established its potency to manage the dreaded pests.

**Keywords:** *Cassava bio-pesticide, Odoiporous longicollis, Cosmopolitus sordidus, Pest management.*

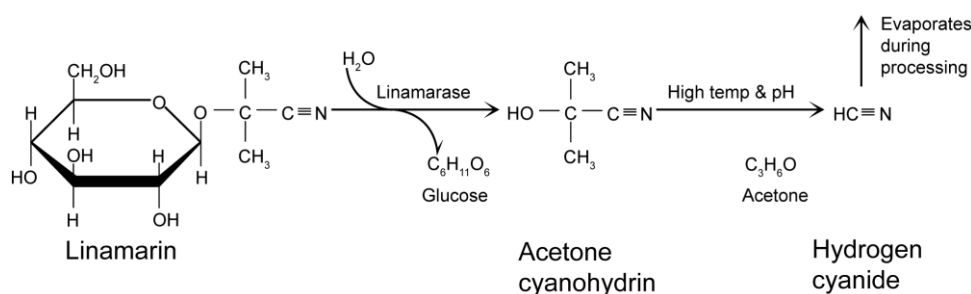
### Introduction

Cassava (*Manihot esculenta* Crantz) is the most important calorie-producing crops grown as a staple or subsidiary food for 450-500 million people in 26 tropical and subtropical countries. After harvest large portion of the biomass such as cassava leaf (2 t<sup>-ha</sup>) fruits (3t<sup>-ha</sup>) and tuber rinds (15-23% of the tuber) are generally discarded as waste. Cassava leaf is a storehouse of protein and minerals, despite the anti-nutritional factors like Cyano-glycosides present in the plant is a challenge in its diversified use. Most of the Cyano-glycosides in nature are Cyanogenic and since they have a nitrile group  $\alpha$  to the glycosidic linkage, hydrolysis of this by specific enzymes will lead to the formation of Hydrogen Cyanide (Yang and Tanaka, 1999).





Linamarin is a potential cyanogenic glycoside present in cassava and it generates HCN when cell-lysis happen usually during herbivore consumption.



However, some growers use the leaves as cattle feed after removing the toxic principle by sun drying. Literature shows that cyanogen has been used as a potential biopesticide (Price, 1985; Yong-lin Ren and Desmarchelier, 1998; Yong-lin Ren and Allen, 2001; Cortes *et al.*, 2003; Lisbeth *et al.*, 2003).

Current study deals with the effectiveness of cassava biopesticide over various pests of horticultural crops. Effectiveness conferring lethality was the general scale of measurement throughout the study. Lethality measurement of Hydrogen cyanide present and isolated in the extract of Cassava namely ‘*Menma*’ on BPW was worked out. Since the bio-efficacy of Hydrogen cyanide in *Menma* against the BPW was done in every lethality perspectives such as Lethal Concentration (LC)<sub>50</sub>, Lethal Doss (LD)<sub>50</sub> and Knock Down Time (KDT)<sub>50</sub>, the study promises the minimum respective amount of application for the management. Synthetic insecticides cannot be ‘replaced’ in a point of time but it should be judiciously reduced through other means of pest management measures that is effective and organic, which includes botanical preparation. *Menma* promises a quality as equal to synthetics while being completely organic. Pests such as aphid, mealy bug, thrips and weevil were generally scrutinised in a management perspective throughout the study and promising results were observed.

## Materials and methods

### Maintenance of test insects

**Aphid:** The common pea aphid (*Acyrtosiphon pisum*) were reared in green house garden and adult female aphids were transferred into long-pea cut-parts of 3 cm length using a brush and were kept in 100 ml bottles with amber coloured glass plates as lid. **Mealy bug:** *Paracoccus marginatus* were reared in potted chilly plants in cages that restrict parasitoid entry and climatic hazards. Insects were collected as per requirement from the inoculum in 100 ml containers with air-permitting cloth as lid.

**Thrips:** *Gynaikothrips uzeli* were reared in garden weeping fig *Ficus benjamina* and samples required were collected by opening the curled infected leaves and transferring it into 100 ml containers with fresh uninfected leaves. **Weevil:** Samples of adult *Odoiporus longicollis* collected from the banana fields of Thiruvananthapuram district were maintained in the laboratory at 26±3° C, RH 60 ± 10% and L:D 12:12 in an incubator. The pupae collected

were maintained separately in 100 ml plastic container and its mouth was covered by muslin cloth. On emergence, the adults were transferred into one litre plastic container and they were provided pseudostem (50gm) for feeding. Adults with approximately two weeks old, irrespective of sex, were selected for the study.

### **Production of biopesticide**

The insecticidal principle (Hydrogen Cyanide) was isolated from cassava leaves (variety H-97), those were collected from the farm of ICAR-Central Tuber Crops Research Institute, Thiruvananthapuram, by using the cassava biopesticide extraction unit commissioned at the biopesticide laboratory. The active principles isolated from the leaf were named as “*Menma*” and its cyanogen content was estimated using spectrophotometer and gas chromatography. *Menma* was used for trial within 30 after production.

### **Estimation of cyanogen in the extract**

Cyanogen in the biopesticide *Menma* was estimated with a modified method of Breuer and Rumball, (2007). *Menma*- 20 ml, was taken in a 100 ml conical flask and into which one drop of 0.5 M NaOH was added (Breuer and Rumball, 2007). By adding 0.1 ml of the newly prepared Rhodanine indicator (Breuer and Rumball, 2007), it was titrated against 0.0103 M AgNO<sub>3</sub> solution until reaching the endpoint reached (colour change), and the cyanogen in the sample was estimated.

### **Toxicity Study**

Common pea aphid (*Acyrtosiphon pisum*): Cyanogen present in the biopesticide *Menma* was diluted to 0 to 20 ppm (1, 2, 4, 8, 10, 20 ppm), and was stored in an airtight container. The test solution was poured into a plastic container of 100 ml capacity, and the test insects, >500 nos x 3 long-pea cut-parts. each were transferred in to the container.

Papaya mealy bug (*Paracoccus marginatus*): Cyanogen present in the biopesticide *Menma* was diluted to 0 to 40 ppm (1, 2, 4, 8, 10, 20, 30, 40 ppm), and was stored in an airtight container. The test solution was poured into a plastic container of 100 ml capacity, and the test insects, >50 nos x 3 leaves. each were transferred in to the container.

Weeping fig thrips (*Gynaikothrips uzeli*): Cyanogen present in the biopesticide *Menma* was diluted to 0 to 80 ppm (1, 2, 4, 8, 10, 20, 40, 80 ppm), and was stored in an airtight container. The test solution was poured into a plastic container of 100 ml capacity, and the test insects, >20 nos x 3 leaves, each were transferred in to the container.

Banana Pseudostem Weevil (*Odoiporus longicollis*): Cyanogen present in the biopesticide *Menma* was diluted to 0 to 100 ppm (1, 2, 4, 8, 10, 20, 40, 80 and 100 ppm), and was stored in an airtight containers. The test solution was poured into a plastic container of 100 ml capacity, and the test insects, 5 nos. each were transferred in to the container.

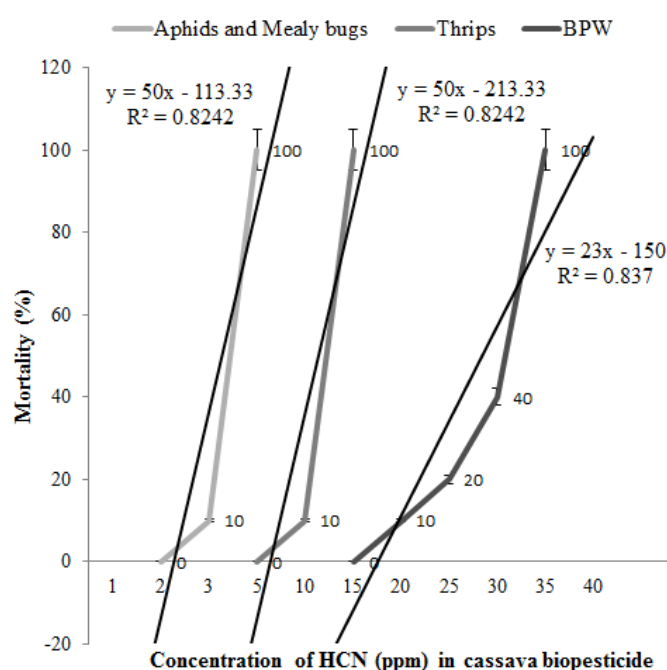
To avoid direct contact between the test solution and insects, an aluminium mesh (160 mesh/square inch) was fixed in the container just above this solution, and onto it the infected samples/ insects were placed. LC<sub>50</sub> and LD<sub>50</sub> studies were worked out.

### **Data analysis**

The LD<sub>50</sub> was calculated along with their respective intercepts and slopes using SAS 9.3 statistical software. All the data pertained to mortality were corrected using Abbott's formula (Abbott, 1925). ANOVA was used for comparison of treatments and time of exposure.

## Results and discussion

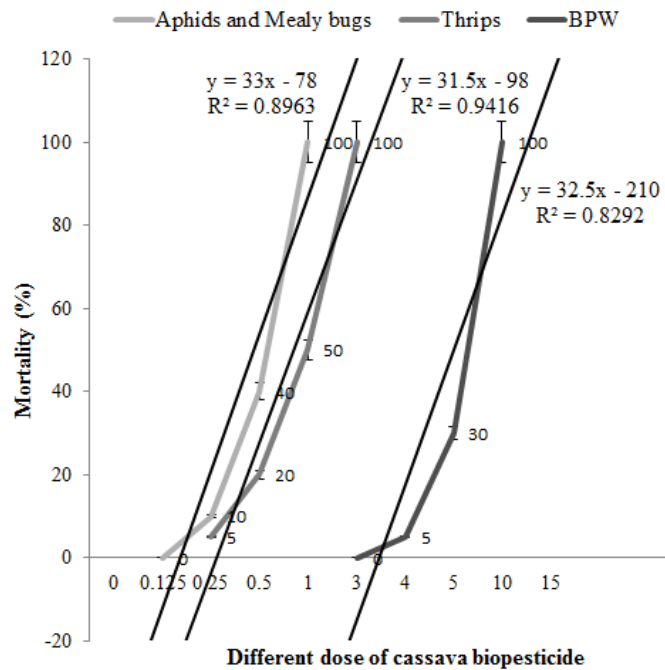
A positive correlation between the concentration of cyanogen in the biopesticide *Menma* and mortality of aphids, mealy bugs, thrips and weevils were observed ( $P < 0.001$ ) (Fig. 1a, 1b). In all the treatments, the treated aphids and mealy bugs were alive at one minute after treatment, except with 3 ppm and concentration above; however with 5 ppm, mortality was significantly higher than with all other treatments ( $P < 0.001$ ). Mortality of the treated insects was also noticed due to the treatment with *Menma* at low concentration of cyanogen, but it was delayed. This result is in corroboration with Hensen *et al.* (1991) who reported that mortality of thrips in cut flower due to the treatment of cyanogen was less in batches treated with lower concentration than the treatment with higher concentrations. Thrips show only 10% mortality in 10ppm at 1 minute after treatment while exhibit a cent percentage mortality at 15ppm. Weevils are the most resistant and they demand a minimum concentration of 20 ppm for a minute to exhibit 10% mortality and it demand 35ppm to assure 100% mortality (Fig. 1).



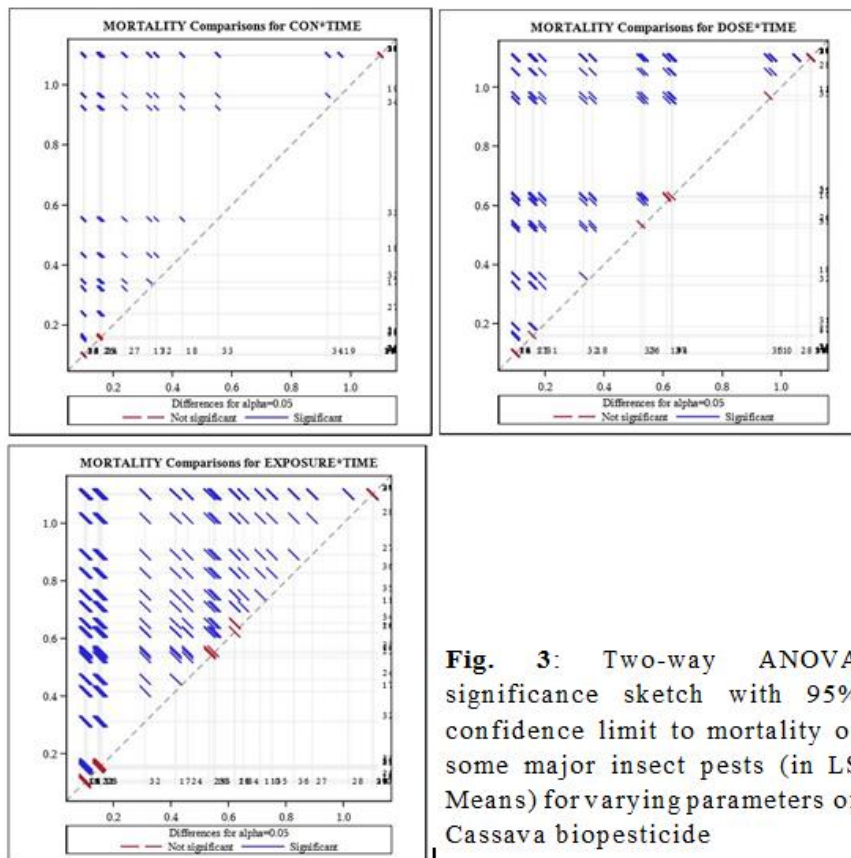
**Fig. 1:** Effect of concentration of HCN on the cassava biopesticide on different pests of horticultural crops.

The formulation with 300 ppm of cyanogen when exposed at different doses *viz.* 0.25, 0.5, 1, 3, 4 and 5 ml, a positive correlation was noticed between the dose and mortality of the test insects (Table 2). Mortality of aphids and mealy bugs were even observed in 1ml dose. Thrips demand 3 ml dose to achieve significant mortality. BPW delayed at lower dose (2 to 3 ml), but at higher dose (over 4 ml) its death started as early as 10 minutes after treatment (MAT) and reached complete mortality at 4 HAT. However, no death was observed in the untreated as well as in 0.25 and 0.5ml batches for all the insects even for long hours of exposure. Cent per cent mortality was achieved at 10 ml dose within 1 HAT (Fig. 2). Hansen *et al.* (1991) observed a variation in the mortality of certain quarantine pest of Hawaii at different concentration of hydrogen cyanide fumigation.

Two-way ANOVA significance sketch showcase the studies conducted were significant to above 95% limit to all the variable parameters such as, concentration, dose and exposure over time (Fig. 3).



**Fig. 2:** Effect of different dose of cassava biopesticide over various pests of horticultural significance.



**Fig. 3:** Two-way ANOVA significance sketch with 95% confidence limit to mortality of some major insect pests (in LS Means) for varying parameters of Cassava biopesticide

Cassava biopesticide is thus a promising alternative to synthetic pesticides since it exhibits a very significant pesticidal property and is organic. Aphids, mealy bugs, thrips and weevils are major villains to horticultural crops and confer a cumulative pre-harvest damage of more than 80-90%. Since agriculture confers the most significant footprint in the biosphere than any other human activity this promising bio-utility can definitely assure sustainability and will also make cassava farmers to earn from a general bio-waste.

### **Conclusion**

Use of plant products to protect pests associated with horticultural crops is an age-old practice. The present study focuses on the use of an underutilised plant parts such as leaf and tuber rind of cassava for the production of biopesticides against borer pests of fruits and tree crops; the efficacy of the biopesticide, Menma against many of the pests in horticultural crops has been established. The study also details the lethality status of cyano-glycosides present in the extract Menma over such pests. Mortality of the treated insects such as aphids and mealy bugs were noticed in 1HAT due to the treatment with Menma at concentration of Hydrogen cyanide at 5ppm or 1ml doss of 300ppm. In thrips the minimum required concentration for cent per cent mortality in 1HAT is 15ppm or 3ml doss of 300ppm of HCN. 35ppm or 10ml doss of the same is demanded by weevil to exhibit 100% mortality for the same foresaid duration. Though Hydrogen Cyanide is a publicised toxin its potential as an organic, degradable, volatile, accessible, cheap and effectiveness marks this as a perfect solution addressing many issues in pest management. As per WHO, Carbon monoxide is more toxic than HCN to humans but both will be lethal only in confined conditions of fumigation.

### **Acknowledgement**

The authors acknowledge *Rashtriya Krishi Vikas Yojana* for providing financial support for the study, to the Director, ICAR- Central Tuber Crop Research Institute (CTCRI) for the encouragement and providing laboratory facilities, E. R. Harish, for his constant support in article formatting and to Dr. J. Sreekumar, Senior Scientist (Agricultural Statistics) ICAR-CTCRI for rendering statistical assistance.

### **Disclosure statement**

The authors are not aware of any biases that might be perceived as affecting the objectivity of this research article.

### **Competing interest**

I declare that the authors have no competing interests as defined by this publishing group, or other interests that might be perceived to influence the results and/or discussion reported in this article.

### **References**

- Abbott, W.W., 1925. A method of computing the effectiveness of an insecticide. *Journal of economic entomology*, 18, 265-267.
- Anitha Nair, 2004. Clonal susceptibility and age preference of banana pseudostem weevil, *Odoiporus longicollis* Oliv. *Insect Environment*, 10 (3): 132-134.
- Bhagawati Bhabesh, M.K. Deka and P. Patgiri, 2009. Bio-efficacy of botanicals against Banana pseudostem borer, *Odoiporus longicollis*, *Annals of plant protection Science* 17 (2): 366-369.
- Cortes M.L., T. Sanchez, L. Riis, A.C. Bellotti and P.A. Calatayud, 2003. A bioassay to test HCN toxicity to the burrowing bug, *Cyrtomenus bergi*. A short communication to Netherlands Entomological Society, *Entomological experimentaliset. Applicata*, 109: 235-239.

- Food and Agricultural Organization Statistical Yearbook. UN, 2013.
- Gailce Leo Justin C., M. Leelamathi and S.B. Nirmaljohnson, 2008. Bionomics and management of the pseudostem weevil *Odoiporus longicollis* Oliver (Coleoptera: Curculionidae) in banana- a review. *Agriculture Review*. 29 (3): 185-192.
- Gold C., Bagamba F., I. W. Ssenyonga, E. Katungi, P. Ragama, A. Katwijukye and W. K. Tushemereirwe, 2001. Current banana production and productivity in Bamunanika sub-country, Central Vganda, Base line study. ICIPE, Nairobi, Kenya.
- Hansen James D., Harvey T. Chan, Jr.1, Arnold H. Hara, and Victoria L. Tenbrink, 1991. Phytotoxic Reaction of Flowers and Foliage to Hawaiian Cut Hydrogen Cyanide Fumigation, *Horticulture science*. 26(1):53-56.
- Lisbeth RHS., Antony Charles Bellotti, Meredith Bonierbale and Gerard Michael Obrine, 2003. Cyanogenic potential in Cassava and its influence on a generalist insect herbivore *Cyrtomenusbergi* (Hemiptera: Cydnidae). *Journal of Economic Entomology*, 96 (6): 1905-1914.
- Padmanaban B., P. Sundararaju, K. C. Velayudhan and S. Sathiamoorthy, 1999. Evaluation of Musa germplasm against banana weevil borers; *INFOMUSA*, 10 (1) 26-28.
- Padmanaban,B and Sathiamoorthy S, 2001. Incidence of banana pseudostem borer, *Odoiporus longicollis* (Oliver) (Curculionidae: Coleoptera) in banana peduncle. *Indian journal of entomology* 63:204-205.
- Prasuna A. L., K. N. Jyothi, A. R. Prasad, J. S. Yadav and B. Padmanaban, 2008. Olfactory responses of banana pseudostem weevil, *Odoiporus longicollis* Oliver (Coleoptera: Curculionidae) to semiochemicals from conspecifics and host plant, *Current science*. 94 (7): 896-900.
- Price N.R., 1985. Review-The mode of action of fumigants, *Journal of stored products*. 21 (4): pp 157-164.
- Ravi, G. and M. S. Palaniswami, 2002. Evidence for a female-produced sex pheromone in the banana pseudostem weevil, *Odoiporus longicollis* Olivier. *Current Science*, 83 (7): 893-898.
- Reghunath P., Visalakshi A., Mathew T.B., Mohandas N., Beevi S.N. and Remamoni K.S. 1992. Insecticidal management of the pseudostem borer *Odoiporus longicollis*. Oliv. (Coleoptera: Curculionidae) *Entomon* 17 (1-2): 113-115.
- Thippaiah M., C. T. Ashok Kumar, C. Shivaraju and A.K. Chakravarthy, 2010. Incidence of banana pseudostem weevil, *Odoiporus longicollis* (Oliver) in south Karnataka. *Pest Management in Horticultural Ecosystems*. 16 (1): 50-53.
- Visalakshi, A. G. Nair, M. Beevi S. N. and Amma, A. M. K., 1989. Occurance of *Odoiporus longicollis* Olivier (Coleoptera: Curculionidae) as a pest of banana in Kerala. *Entomon*, 14 (4): 367-368.
- Yang Chong-Ren, Osamu Tanaka, 1999. *Advances in Plant Glycosides, Chemistry and Biology*, Elsevier, Science publication – pp. 335
- Yong-lin Ren and James M. Desmarchelier, 1998. Release of fumigant residues from grain by microwave irradiation. *Journal of AOAC International* 81 (3): 673-677.
- Yong-lin Ren and Sylvia E. Allen, 2001. Ultrasound treatment acceleration of solvent extraction for fumigant residue from wheat. *Journal of AOAC International* 84 (5): 1551-1554.

## WHITE CHEESE MICROBIAL PROPERTIES MADE OF INFRA RED PASTEURIZED MILK RIPENED IN POTASSIUM CHLORIDE (KCl) SOLUTION

Simin HAGH NAZARI\*<sup>1</sup>, Mohammad Reza AZIMI<sup>2</sup>, Sajjad VALINEZHAD<sup>3</sup>

<sup>1</sup>Department of Food Science and Technology, Agriculture Faculty, University of Zanjan, Zanjan, IRAN.

<sup>2</sup>Cultivation Department, Agriculture Faculty, University of Zanjan, Zanjan, IRAN.

<sup>3</sup>Department of Food Science and Technology, Agriculture Faculty, University of Zanjan, Zanjan, IRAN.

\*Corresponding author:haghnazari.simin@znu.ac.ir

### Abstract

Nowadays some of the traditional food technologies and formulations are being replaced with new ones. In addition to providing healthy and nutritious food, the new methods have potential to reduce risk factors. Using infrared irradiation heat for milk pasteurization as a technology with the high thermal efficiency can be a good alternative to traditional methods of milk processing.

Also by replacing potassium chloride instead of sodium chloride in the formula of the salt water of white cheese, the adverse health effects resulting from the consumption of sodium chloride can be prevented. In this study, by using the infrared radiation heat, raw cow milk prepared of Zanjan University animal husbandry was pasteurized and then white cheese produced from it in 2016. The white cheese was placed in four different formulations of brine containing 1) NaCl: KCl, 10:0 percent 2) NaCl: KCl, 7.5: 2.5 percent, 3) NaCl: KCl, 5:5 percent and 4) NaCl: KCl, 0:10 percent for 21 days at a temperature of 8° C. Then the microbial and characteristics of the cheeses were evaluated. Cheeses produced using two pasteurization methods of classical and infrared irradiation had no significant differences in the coliform, yeast and mold counts. Also a comparison of data means resulting from the analysis of the cheese characteristics show that the changing the formula of the brine had no significant effect on the microbial load.

**Key Words:** *NaCl, KCl, White Cheese, Brine, Infrared pasteurizing, microbial*

### Introduction

Cheese is the ripened or unripened soft, semi-hard, hard, or extra-hard product, which may be coated, and in which the whey protein/casein ratio does not exceed that of milk (CODEX GENERAL STANDARD FOR CHEESE. 283-1978)<sup>6</sup>. Cheese contains less water than milk, and so has different organoleptic properties and shelf life than milk (Walstra et al., 2006). Cheese can be more useful than milk in high protein diets, also its proteins are highly digestible (Renner, 1993). Traditional production of white cheese in brine has been popular for centuries in small-scale cow keeping farms and that way it was difficult to set the standard for the properties and composition of the cheese. Along with the recent developments in dairy product processing industry and with the integration of mechanization and automation, large-scale production of cheese became possible (Ozer, 2014).

Salting is an important stage in the process of cheese. Salt is considered as an additive commonly used in the food industry and plays a vital role in the food processing, including food protection, helping to improve the flavor, the impact on proteolysis, water activity and

---

<sup>6</sup> . [www.fao.org/input/download/standards/175/CXS\\_283e.pdf](http://www.fao.org/input/download/standards/175/CXS_283e.pdf)

strength in the tissue (Reddy and Marth, 1991; Guinee, 2004a; Guinee and Fox, 2004). Salt provides about 90 percent of the sodium in the human diet (He et al., 2012). In the structure of the salt, the sodium intake is very important to control the membrane potential of the cell and absorption of nutrients in the small intestine. In order to maintain the blood volume, osmotic pressure on the cell and also transportation of nervous signals, sodium is essential (Strazzullo et al., 2009; He and MacGregor, 2010). Although salt plays an important role during food processing, but has been known to be a major risk for diseases such as osteoporosis due to urinary excretion of calcium chloride, kidney stones and high blood pressure (Beumi et al., 2002; Kotchen, 2005; Massey, 2005; Heaney, 2006). The World Health Organization has recommended food manufacturers to reduce the use of salt (WHO, 2007). Meat, dairy, bakery and other food products, each include a different percentage of sodium uptake by the body in different classes in the world for example, the daily intake of sodium through cheese in England, France, America and Australia, have been reported 7.8, 9.2, 8.2 and 5% namely (Meneton et al., 2009; Anderson et al., 2010). So many efforts have been made for producing low-salt cheese using different techniques such as reducing the amount of salt or partial replacement of salt in cheese with other materials (Guinee and O'Kennedy, 2007). Reducing the salt content of the Cheddar cheese and the effects of these changes on the microbial growth were done by Schroeder and colleagues (1988b). Replacing salt with other materials such as potassium chloride, calcium chloride and magnesium chloride may be considered as a successful strategy to reduce the amount of salt (Kilcast and den Ridder, 2007). Also partial replacement of sodium chloride with potassium chloride revealed that the quality of the cheese has not significantly changed (Guinee, 2004b). Potassium chloride salt is acknowledged as a potential alternative to sodium chloride in cheese making. Increasing potassium intake has been reported as a protective factor for people with hypertension (Fregly, 1981; Reddy and Marth, 1991). A mixture of potassium chloride and sodium chloride has been successfully used in cheese production and no adverse effects have been reported on the quality of the cheese (Fitzgerald and Buckley, 1985). Several studies have also been made on the effect of replacing sodium chloride with potassium chloride on the properties of Cheddar (Reddy and Marth, 1993a), feta cheese (Katsiari, et al., 1997; 2000a), Kefalograviera cheese (Katsiari et al., 2001a), and Fynbo cheese (Zorrilla and Rubiolo, 1994; Zorrilla et al., 1996), but there is not any investigation on white cheese made of IR pasteurized milk and aged in KCl substituted brine. Infrared heating is an alternative preservation method with a higher thermal efficiency, which transfers thermal energy in the form of electromagnetic waves. Recent applications of infrared heating indicate this technology is a viable alternate for the pasteurization of liquid foods, in addition it can decontaminate foodstuffs in both liquid and solid foods with retaining higher levels of health promoting compounds (Hagh Nazari, 2014). The aim of this research is to study the effects of replacement of NaCl with KCl salt on the microbial properties of ripened white brined cheese made from pasteurized milk using infrared irradiation.

### **Materials and Methods**

Cheese making method: for the preparation of cheese, raw milk from the dairy farm of Zanjan University was prepared. Raw milk was pasteurized using flavor wave Turbo device that emits infrared waves at 72 °C for 15 seconds has shown in figure 1. The temperature of the process was checked by a digital thermometer model TES made in China. For comparing and evaluating the effects of the pasteurization methods, the milk was also pasteurized using classic (conventional) methods. After pasteurization of milk, 200 ml of milk was poured in lidded plastic containers of the same shapes in 3 replicates equaled 24 samples.





Figure 1: flavor wave Turbo device

After the milk temperature reached to 35 °C; the kefir starter solution to the volume of 2 ml along with calcium chloride to the amount of 0.02 % of the milk were added to the pasteurized milk. The samples were transferred to an incubator made by Memmert Company in Germany at 35 °C. And 20 minutes after adding the starter, the fungal rennet Valiren made in America was added to the amount of 0.0025 g to each container at 35 °C. After clot formation, clots were left without cutting for 12 hours in 18 °C to continue fermentation, coagulating and dewatering. The resulting clots were transferred to salt solutions containing: 1) NaCl: KCl, 10:0 percent 2) NaCl: KCl, 7.5: 2.5 percent, 3) NaCl: KCl, 5:5 percent and 4) NaCl: KCl, 0:10 percent for 21 days at a temperature of 8° C. After ripening, microbiological tests were conducted on the cheese. Microbiological tests: to evaluate the effect of potassium chloride on the microbial load of the produced cheeses, after the period of ripening, the cheeses were sampled and the total microbial load (ISIRI 2406, 2008), Coliform count (ISIRI 5486-1.2, 2002), fungi count (ISIRI 10154, 2007), coagulase positive *Staphylococcus aureus* count (ISIRI 6086-3, 2006), detection of the presence of *Salmonella* (ISIRI 4413, 2010) and detect the presence of *E. coli* (ISIRI 5234, 2000) was measured.

**Statistical analysis:** The data obtained via examination of cheeses prepared of two types of pasteurized milk with two methods of infrared and classical irradiation and four types of salt formulas were analyzed by means of factorial method using Mstatc statistical software. The obtained meanings were compared with Duncan's method.

## Results and discussion

Microbiological analyses:

The results of the pasteurization of milk are shown in table 1. The total microbial count by the infrared radiation method has declined more than the classic method (Table 1).

Table 1: The total microbial count of milk processed by the infrared radiation method and the classic method

CFU	Raw Milk	Classic Pasteurized Milk	IR Pasteurized Milk
Total Microbial Count	3244000 ± 24000	68880 ± 2200	48110 ± 2600

The comparison of the Coliform count of cheese prepared with pasteurized milk using infrared radiation and Classic method at 72° C for 15 seconds is shown in Figure 2.

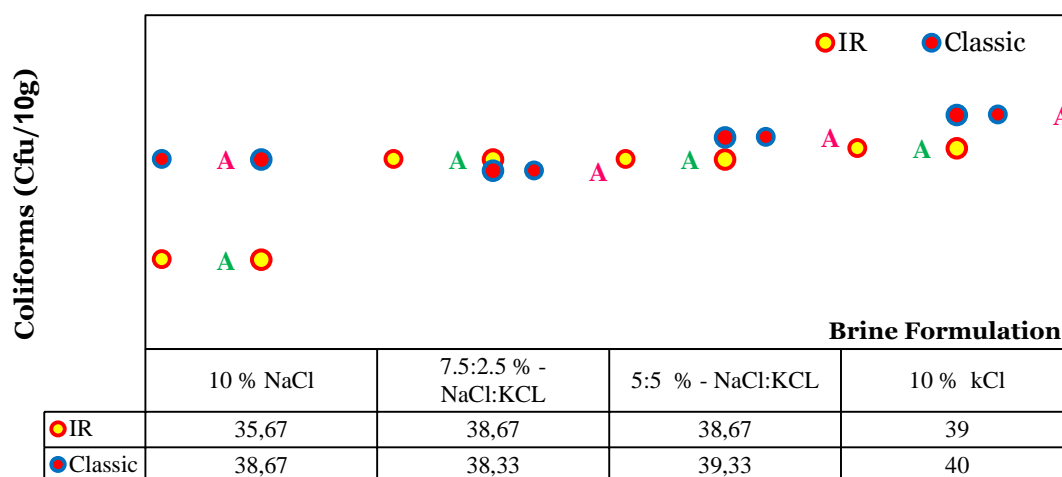


Figure 2: The comparison of the Coliform count of cheese prepared with pasteurized milk using Infrared radiation and Classic method at 72° C for 15 seconds.

The above results show that the changes in the brine formulation also had no significant effect on the coliform count of the cheese. The mold and yeast count data by comparing the four formulations of aging cheeses in brine are shown in figure 3.

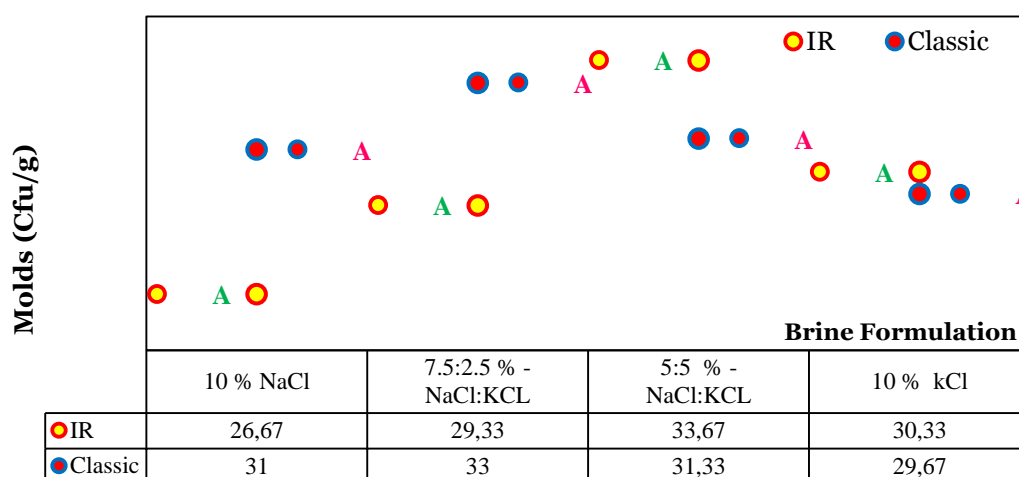


Figure 3: Comparing the four formulations of aged cheeses in brine respected to their yeast and molds.

The results primarily in high common salt ripened cheese show that the yeast and mold count in IR processed cheese is lower than classic method ones and by decreasing the amount of common salt in samples, the 2 manners of the production don't show any significant difference in yeast and mold count in ripened cheese especially in 10% KCl brine formulation.

Other microbiological results on related culture media and following tests of ripened cheese samples show that there is no *Staphylococcus aureus* coagulase-positive, no *E. coli* per gram of cheese, but containing an average 38 and 35 colonies of coliforms, 31 and 26 colonies of mold and yeast per gram in classic and IR method of pasteurization respectively, and salmonella is negative at 25 per gram of two types of cheeses. Overall, a comparison of data

means resulting from the analysis of the cheese characteristics show that the changing the formula of the brine had no significant effect on the microbial load.

#### **The use of potassium chloride in the formula of the cheese brine:**

The reason for the replacement of sodium chloride with potassium chloride, is achieving a product that reduces harmful effects to health caused by the consumption of sodium chloride. In addition to the fact that the product is supposed to be acceptable in terms of evaluated properties. Reduced sodium salt, cheese is very soft, bitter, less salty, and has a strong off-flavor and shorter shelf life (Ying Lu, 2012). Potassium chloride (KCl) has a similar structure and salty flavor as sodium chloride (salt) and partial replacement of salt with potassium chloride can be used to lower salt content in foods. Moreover, potassium can lower the blood pressure and the risk of heart disease or stroke. Thus, potassium chloride is a potential substitute for salt in the cheese.

#### **Effects of brine formula on microbial properties of cheese**

The researchers also reported that the initial pH of the cheese is specified according to the pasteurization method, the type of milk used to make cheese, the microbial load of the raw milk and the starter culture type. While the pH of the ripened cheese is specified according to the ripening temperature, period length and the type of rennet used (Lindsay, 1982; Aly, 1985; Katsiari et al., 1998, 2000, 2001). Partial replacement of sodium chloride with potassium chloride with different levels of substitution (10:00 percent sodium chloride - potassium chloride, 7.5:2.5% sodium chloride - potassium chloride, 5:5 % sodium chloride - potassium chloride and 10:00 percent potassium chloride - NaCl) had no significant effect on pH values. These results are similar to findings of Katsiari in 1998, 2000 and 2001. This researcher replaced (3% sodium chloride, 1.5:1.5 percent sodium chloride - potassium chloride and 3% potassium chloride) on Kefalograviera cheese and observed no significant change in the pH of the cheese. (Katsiari et al., 1998, 2000, 2001).

The microbiological properties of the produced cheeses in different brine formulations showed no significant difference between the cheeses produced from various ratios of NaCl and KCl. These findings can be confirmed by Kamleh et al investigations (2014). They investigated on the effect of partial replacement of NaCl with KCl on the microbiological characteristics of fresh and mature Akkawi cheese and they recorded that all tested microorganisms increased with storage but in general did not differ between salt treatments, specifically between control (100% NaCl) and (70% NaCl, 30% KCl) samples which this article's results also suggest similar collected data as the studies made.

#### **The effect of infrared radiation in cheese production**

Examining the microbiological properties of the produced cheeses showed no significant difference between the cheeses produced from pasteurized milk using the infrared and classic methods, but due to the high heat performance in the infrared radiation, the pasteurization process of milk is approximately 75% faster than the classic method. It is considered a more suitable method for pasteurization of milk compared to the classic method, especially due to the heat shock effect on microbial cellular structure. For confirmation of this subject, yeast cells (*Candida albicans* NBRC 1950, *Saccharomyces cerevisiae* NBRC 1067) and fungal spores (*Aspergillus niger* NBRC 4781) were subjected to IR heating as a pasteurization method by Nakata et al in 2015. The obtained results showed that IR heating was fairly effective than thermal conductive heating for killing microorganisms. Also the activation energy for the death of fungi by IR irradiation was slightly less than thermal conductive heating (Nakata et al 2015). The efficacy of infrared (IR) heating for inactivation of *Staphylococcus aureus* in milk was studied to investigate the potential of IR irradiating technology in milk processing by Krishnamurthy (2008). The results demonstrated that IR

heating has a potential for effective inactivation of *S. aureus* in milk (Krishnamurthy, 2008). The reason of microbial death is recorded due to the cell wall damage, cytoplasmic membrane shrinkage, cellular content leakage and mesosome disintegration of IR-treated microorganisms (Krishnamurthy, 2008). The efficacy of near-infrared (NIR) heating to reduce *Salmonella enterica* serovar *typhimurium*, *Escherichia coli* O157:H7, and *Listeria monocytogenes* in ready-to-eat (RTE) sliced ham compared to conventional convective heating by Won Ha (2012). Also they determined the effect of NIR heating on hams' quality by measuring their microbial count. NIR heating for 50 s achieved 4.1-, 4.19-, and 3.38-log reductions in surface-inoculated *S. Typhimurium*, *E. coli* O157:H7, and *L. monocytogenes* respectively, whereas convective heating needed 180 s to attain comparable reductions for each pathogen. All above studies confirms this project's results due to the higher efficiency and saving energy consumption via IR assisted systems in comparison of classic method of pasteurization.

### Conclusion

In general, from this study it can be concluded that changing the formulation of the used brine has no effects on microbial properties.

The microbiological properties of the produced cheeses in different brine formulations showed no significant difference between the cheeses produced from various ratios of NaCl and KCl.

The effect of infrared radiation in cheese production showed no significant difference between the cheeses produced from pasteurized milk using the infrared and classical methods, but the pasteurization process of milk is approximately 75% faster than the classic method due to the high heat performance in the infrared radiation.

### References

- Aly M. E. (1995). An attempt for producing low-sodium Feta type cheese. *Food Chem.* 52: 295-299.
- Anderson, C. A., Appel, L. J., Okuda, N., Brown, I. J., Chan, Q., Zhao, L., Ueshima, H., Kesteloot, H., Miura, K., Curb, J. D., Yoshita, K., Elliott, P., Yamamoto, M. E., Stamler, J. (2010). Dietary sources of sodium in China, Japan, the United Kingdom, and the United States, women and men aged 40 to 59 years: the INTERMAP study, *J. Am. Diet. Assoc.* 110: 736–745.
- AOAC. (1995). Official Methods of Analysis. AOAC International, Arlington, VA.
- Buemi, M., Senatore, M., Corica, F., Aloisi, C., Romeo, A., Tramontana, D., et al. (2002). Diet and arterial hypertension: Is the sodium ion alone important. *Medicinal Research Reviews*, 22(4): 419–428.
- Binkerd, E. F., and Kolari, O. E. (1975). The history and use of nitrate and nitrite in the curing of the meat. *Food Cosmet. Toxicol*, 13: 655-661.
- Durack, E., Alonso-Gomez, M., and Wilkinson, M. G. (2008). Salt: A review of its role in food science and public health. *Current Nutrition and Food Science*, 4: 290 - 297.
- Fitzgerald, E. and Buckley, J. (1985). Effect of total and partial substitution of sodium chloride on the quality of Cheddar cheese. *Journal of Dairy Science*, 68:3127-3134.
- Fregly, M. J. (1981). Sodium and potassium. *Annual Review Nutrition*, 1: 69-93.
- Fucà N, McMahon DJ, Caccamo M, Tuminello L, La Terra S, Manenti M, Licitra G. *J Dairy Sci.* 2012 Jan;95(1):460-70. doi: 10.3168/jds.2011-4438. PMID: 22192226.

- Guinee, T. P., & O’Kennedy, B. T. (2007). Mechanisms of taste perception and physiological controls. In: T. P. Guinee, & B. T. O’Kennedy (Eds.), Reducing salt in foods: Practical strategies (pp. 246-287). Boca Raton LA, USA: CRC Press.
- Guinee, T. P. (2004a). Salting and the role of salt in cheese. *International Journal of Dairy Technology*, 57: 99-109.
- Guinee, T. P. (2004b). Scrap the salt: as concern about the high salt content of cheese rises. *Dairy Industries International*, 69: 36 - 38.
- Guinee, T. P., and Fox, P. F. (2004). Salt in cheese: Physical, chemical and biological aspects. Pages 207-259 In Cheese: Chemistry, physics and microbiology General aspects. Vol. 1. 3 ed. P. F. Fox, P. McSweeney, L. H., Cogan, T. M., and Guinee, T. P., edr. Elsevier Academic Press, London, UK.
- Hagh Nazari, S. (2014). Impact of using infrared irradiation energy in food processing. *Energy Education Science and Technology Part A: Energy Science and Research*. Volume (issues) 32(2): 1387-1396.
- Heaney, R. P. (2006). Role of dietary sodium in osteoporosis. *J. Am. Coll. Nutr.* 25: 271–276.
- He, F. J., MacGregor, G. A. (2010). Reducing population salt intake worldwide: from evidence to implementation, *Prog. Cardiovasc. Dis.*, 52: 363 – 382.
- Institute of Standards and Industrial Research of Iran N° 4413: 2010, Milk and milk products- Detection of Salmonella, 1<sup>st</sup> – Revision.
- Institute of Standards and Industrial Research of Iran N° 2406: 2008, Microbiology of milk and milk products-Specifications. 2nd revision, Karaj. 2008.
- Institute of Standards and Industrial Research of Iran N° 10154: 2007, Milk and milk products – Enumeration of colony-forming units of yeasts and/or molds-colony - Count Technique at 25°C. 1<sup>st</sup> – Edition.
- Institute of Standards and Industrial Research of Iran N° 6083-3: 2006, Microbiology of food and animal feeding stuffs- Horizontal method for the enumeration of positive Staphylococci –coagulase (Staphylococcus aureus and other species)-Part 3: Detection and MPN technique for low numbers. 1<sup>st</sup> – Edition.
- Institute of Standards and Industrial Research of Iran N° 5486-1, 2: 2002, Milk and milk product, Enumeration of coliforms part 2: Most probable number technique at 30°C. 1<sup>st</sup> – Edition.
- Institute of Standards and Industrial Research of Iran 5234: 2000, Milk and milk products – enumeration of presumptive Escherichia coli - MPN technique.
- ISO 6611:2004 (IDF 94: 2004). Milk and milk products -- Enumeration of colony-forming units of yeasts and/or moulds -- Colony-count technique at 25 degrees C.
- ISO 6785:2001 (IDF 93: 2001). Milk and milk products -- Detection of Salmonella spp.
- ISO 11866-1:2005 (IDF 170-1: 2005). Milk and milk products -- Enumeration of presumptive Escherichia coli -- Part 1: Most probable number technique using 4-methylumbelliferyl-beta-D-glucuronide (MUG).
- ISO 11866-2:2005 (IDF 170-2: 2005). Milk and milk products -- Enumeration of presumptive Escherichia coli -- Part 2: Colony-count technique at 44 degrees C using membrane.
- Jae-Won Ha, Sang-Ryeol Ryu and Dong-Hyun Kang. (2012). Evaluation of Near-Infrared Pasteurization in Controlling Escherichia coli O157:H7, Salmonella enterica Serovar Typhimurium, and Listeria monocytogenes in Ready-To-Eat Sliced Ham. *Appl. Environ. Microbiol.* 78:18 6458-6465.
- Kamleh, R., Olabi, A., Toufeili, I., Daroub, H., Younis, T. and Ajib, R. (2015), The effect of partial substitution of NaCl with KCl on the physicochemical, microbiological and sensory properties of Akkawi cheese. *J. Sci. Food Agric.*, 95: 1940–1948. doi:10.1002/jsfa.6906.

- Katsiari, M. C., Voutsinas, L. P., Alichanidis, E., & Roussis, I. G. (1997). Reduction of sodium content in Feta cheese by partial substitution of NaCl by KCl. *International Dairy Journal*, 7(6-7): 465-472.
- Katsiari, M. C., Voutsinas L. P., Alichanidis E., Roussis G. (1998). Manufacture of Kefalograviera cheese with less sodium by replacement of NaCl with KCl. *Food Chem.*, 61: 63-70.
- Katsiari, M. C., Voutsinas, L. P., Alichanidis, E. and Roussis, I. G. (2000). Proteolysis in reduced sodium Feta cheese made by partial substitution of NaCl by KCl. *International Dairy Journal*, 10: 635-646.
- Katsiari, M. C., Voutsinas, L. P., Alichanidis, E. and Roussis, I. G. (2001). Lipolysis in reduced sodium Kefalograviera cheese made by partial substitution of NaCl with KCl. *Journal of Food Chemistry*, 72: 193-197.
- Kilcast, D. and den Ridder, C. (2007). Sensory issues in reducing salt in food products Pages 201-220 In *Reducing Salt in Foods: Practical Strategies*. Kilcast, D. and Angus, F., edr. CRC Press LLC, Washington DC, USA.
- Kotchen, T. A. (2005). Contributions of sodium and chloride to NaCl-induced hypertension. *Hypertension* 45: 849–850.
- Krishnamurthy, K., Khurana, H.K., Soojin, J., Irudayaraj, J. and Demirci, A. (2008). Infrared Heating in Food Processing: An Overview. *Comprehensive Reviews in Food Science and Food Safety*, 7, 2-13. <http://dx.doi.org/10.1111/j.1541-4337.2007.00024.x>.
- Manolopoulou, E., Sarantinopoulos, P., Zoidou, E., Aktypis, A., Moschopoulou, E., Kandarakis, I. G., Anifantakis, E. M. (2003). Evaluation of microbial population during traditional Feta cheese manufacture and ripening. *Int. J. Food Microbiol.* 82: 153-161.
- Massey, L. K. (2005). Effect of dietary salt intake on circadian calcium metabolism, bone turnover, and calcium oxalate kidney stone risk in postmenopausal women. *Nutr. Res.* 25: 891–903.
- Meneton, P., Lafay, L., Tard, A., Dufour, A., Ireland, J., Menard, J., Volatier, J. L. (2009). Dietary sources and correlates of sodium and potassium intakes in the French general population, *Eur. J. Clin. Nutr.*, 63: 1169–1175.
- Mojsova, S., Jankuloski, D., Sekulovski, P., Angelovski, L., Ratkova, M., Prodanov, M. (2013). Microbiological properties and chemical composition of Macedonian traditional white brined cheese, *Mac Vet Rev.*, 36(1): 13-18.
- Nakata, Tubasa. Okamoto, Arisa. Sawai, Jun, Kikuchi, Mikio (2015). Effects of Far-Infrared Irradiative Heating Pasteurization on Fungi T. *Journal of Biosciences and Medicines*, 2015, 3, 60-65.
- Ozer, B. (2014). Microflora of White-Brined Cheeses. In C. Batt, & M. Tortorello, *Encyclopedia of Food Microbiology* (p. 402). Academic Press is an imprint of Elsevier.
- Reddy, K. A., and Marth, E. H. (1993). Lipolysis in Cheddar cheese made with sodium chloride, potassium chloride or mixtures of sodium and potassium chloride. *Milkchwissenschaft.* 48: 488-493.
- Reddy, K. A., and Marth, E. H. (1991). Reducing the sodium content of foods: A review. *Journal of Food Protection.* 54: 138-150.
- Renner, E. (1993). Nutritional aspects of cheese. In: P. F. Fox (Ed), *cheese: chemistry, physics and microbiology Vol 1*(pp, 557-559). London: Elsevier applied science.
- Schroeder, C. L., Bodyfelt, F. W., Wyatt, C. J., & McDaniel, M. R. (1988). Reduction of sodium chloride in cheddar cheese: effect on sensory, microbiological, and chemical properties. *Journal of Dairy Science*, 71(8): 988-993.
- Strazzullo, P., D'Elia, L., Kandala, N. B., Cappuccio, F. P. (2009). Salt intake, stroke, and cardiovascular disease: meta-analysis of prospective studies. *BMJ*, 339: 1 – 9.

- Taormina, P. J. (2010). Implications of salt and sodium reduction on microbial food safety. *Critical Reviews in Food Science and Nutrition*, 50: 209 - 227.
- Walstra, P., Wouters, J., & Geurts, T. (2006). Principles of Cheese Making. In P. Walstra, J. Wouters, & T. Geurts, *Dairy Science and Technology* (pp. 577-582). NW: Taylor & Francis Group, LLC.
- World Health Organization. 2007. Reducing salt intake in populations: Report of a WHO forum and technical meeting. Accessed August 7, 2008. [http://www.who.int/dietphysicalactivity/reducingsaltintake\\_EN.pdf](http://www.who.int/dietphysicalactivity/reducingsaltintake_EN.pdf).
- Ying, Lu. Effects of Sodium Chloride Salting and Substitution with Potassium Chloride on Whey Expulsion of Cheese. Thesis for Master of Science. 2012. Utah State University.
- Zorrilla, S. E., Castelao, E. L., De Piante, D., & Rubiolo, A. C. (1996). Proteolysis during ripening of low-fat Fynbo cheese salted with a mixture of NaCl and KCl. *The Australian Journal of Dairy Technology*, 51: 6-7.
- Zorrilla, S. E., and Rubiolo, A. C. (1994). Modeling NaCl and KCl movement in Fynbo cheese during salting. *J. Food Sci.* 59:976–980.

## ACCUMULATION OF HEAVY METALS IN THE WILD FOREST MOUNTAINS OF EASTERN KAZAKHSTAN

Gulnar S. AIDARKHANOVA<sup>1</sup>, Andrey A. KALACHEV<sup>2</sup>, Ayaulym N. TILEUBERDI<sup>1\*</sup>

<sup>1</sup>Department of Management and Engineering in the Field of Environmental Protection, Faculty of Natural Sciences, Eurasian National University named after L.N.Gumilyov, Astana, Kazakhstan

<sup>2</sup>Kazakh Scientific Research Institute of Forestry and Agroforestry, Ridder, Kazakhstan

\*Corresponding author: 17tile@gmail.com

### Abstract

Forest berries are an essential biological resource that provides the population with a complex of mineral, organic substances, and medicinal properties. Wild berries are widely distributed in the mountain forests of Eastern Kazakhstan. Research requires the ecological safety of these resources in the system "plants-food products", since there are significant industrial enterprises in the region that determine the biogenic migration of toxic elements. The aim of the research was to study the gross concentrations of heavy metals in the berries of the mountain forests of Eastern Kazakhstan, harvested for use as food. The research subjects were *Ribes rubrum L.*, *Rosa acicularis Lindl.*, *Vaccinium myrtillus L.*, selected during the expeditions in 2016 on the territories of the forest ecosystems of Rudniy Altai. Heavy metals were determined by the method of atomic absorption spectrometry. The results of the studies showed that the chemical elements studied were installed in all samples. The range of heavy metals in Cu content was within the range of 3.44-4.84 mg/kg, for Zn – 8.02-9.3 mg/kg, for Mn – 32.7-37.3 mg/kg, for Pb – 0.25-0.31 mg/kg, for Co– 0.4-0.43 mg/kg, for Cd–0.02-0.026 mg/kg. Analysis of the concentration of heavy metals in the selected samples showed no excess of the maximum permissible levels. However, in some samples, the concentrations of detected heavy metals reached the boundary of the permissible limits. The obtained results of research characterize the wild berries of the forest areas of Eastern Kazakhstan as safe for use in food and medicinal purposes.

**Keywords:** *environmental monitoring, heavy metals, plant resources, Kazakhstan.*

### Introduction

Currently, the study of plant resources for the purpose of their rational use, restoration and protection is becoming increasingly important. A careful study of the plant resources of forest ecosystems is a part of a broader area that relates to their use in various branches of the economy, medicine and food. The using of wild species for maximum satisfaction of needs is possible only with a thorough study of plant resources, which are an integral part of natural resources (Petrik et al., 2003; Chistilin, 2008; Hisamov and Kulagin, 2003).

Complex usage of forest resources provides for harvesting not only wood products, but also non-timber resources, with which forests are rich. This group includes mushrooms, berries, food, medicinal, technical, honey and fodder plants, bark, and forage, etc. The collection and harvesting of non-timber forest by-products, their use, represents a certain source of income in industrial, technological and entrepreneurial activities. Non-timber forest resources have a considerable price, often significantly higher than the cost of timber. The annual income from cranberries from 1 hectare of a bog is 5-7 times higher than the income from wood, which grows over 80 to 100 years. According to expert estimates, the market value of the commercial wild-berry stock in the country's forests is more than \$ 10 billion, and the value



of the commercial mushroom stock is \$ 5 billion. in year. The revenues of the forestry of Belarus from the harvesting of products of spurious forest use and secondary forest resources in 2013 amounted to about 5 billion Belarusian rubles. Only 40% of non-timber resources are used, and the remaining 60% remain untouched throughout the world (Griboedova and Mashkanova, 2011; Tipcina, 2013). FAO research found that by-products are the main source of food in most developing countries, animal feed, additional food components, medicinal herbs and other food products that provide seasonal income in many regions of the world (FAO, 2001; FAO, 2013). Such studies are pioneering in Kazakhstan. It is required to determine the species diversity, the ecological quality of raw materials, the biological productivity of objects suitable for harvesting and processing in food technologies for forest areas in the long term. The abundance of wild berries in the mountain forests of Eastern Kazakhstan, growing near industrial plants, makes them a priority for biocomplex research in modern conditions. The purpose of the study was to study the gross concentrations of heavy metals in the berries of the mountain forests of Eastern Kazakhstan, polluted as a result of wind-dust transfer and harvested for food purposes.

### Material and Methods

The research subjects were forest berries of mountain forests of Eastern Kazakhstan, harvested by the local population for use as food. Samples of red currant berries (*Ribes rubrum L.*), rose hips (*Rósa aciculáris Lindl.*), blueberry (*Vaccínium myrtillus L.*) were selected during the expeditions of 2016 on the territories of forest ecosystems of Rudnyi Altai (50°45'N 86°36 'E). All samples were collected on the floodplains of the river Lugovatka, in the vicinity of Ridder. The figure 1 shows the scheme of the territory of the Kazakhstan part of the Altai with an indication of the location of the industrial center Ridder. The area has a temperate climate conditions. The average annual rainfall is around 600 mm. August is the driest month. Fully matured berries are harvested in green appearance period in July. The berries were stored at normal atmosphere and modified atmosphere packaging conditions.

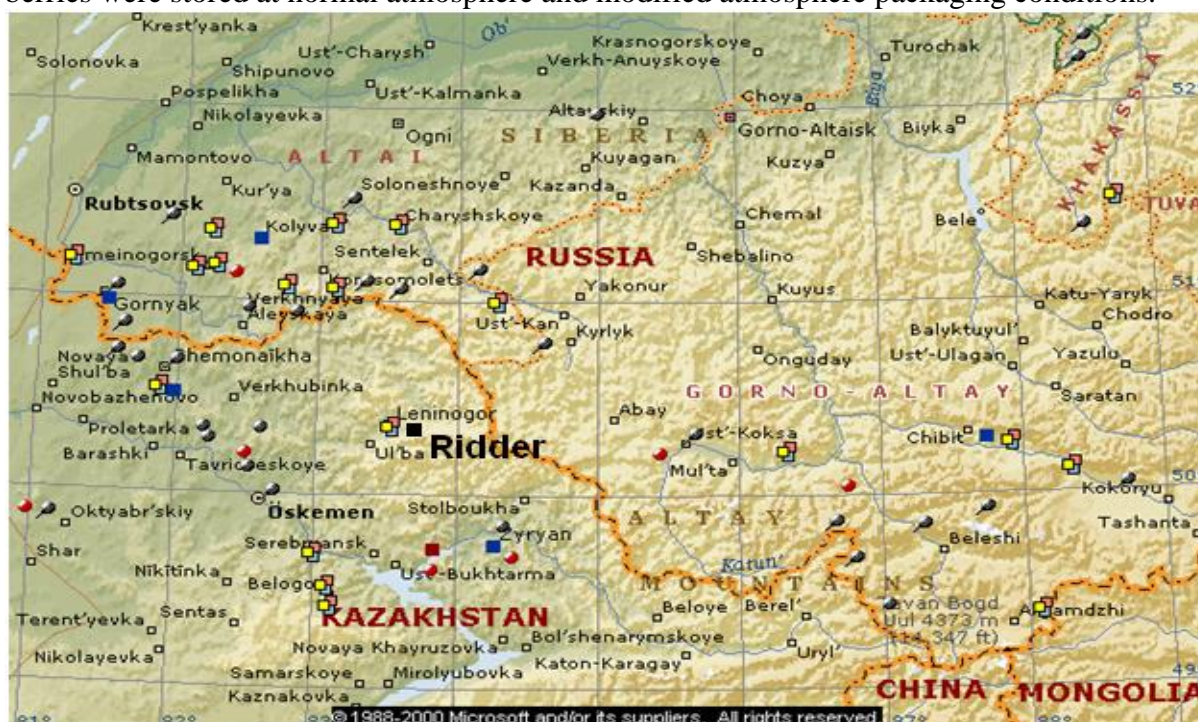


Figure 1. Scheme of the territory of Ore Altai (Evseev, 2004)

Determination of species of berry crops was carried out in accordance with the "Determinant of vascular plants of the Republic of Kazakhstan" (Abdullina, 1998). Preparation of samples and determination of heavy metals were performed in accordance with GOST 26929-94 «Raw material and food-stuffs. Preparation of samples. Decomposition of organic matters for analysis of toxic elements» (GOST 26929-94), GOST 30178-96 «Raw material and food-stuffs. Atomic absorption method for determination of toxic elements» (GOST 30178-96) and also by methodical instructions on atomic absorption methods for the determination of toxic elements in food products and food raw materials (Methodical instructions, 1992). Statistical processing of data, the level of error determined by the method contained in the above-mentioned GOSTs.

### Results and Discussion

The territory of the Republic of Kazakhstan is covered by forests for 4-4.5%, the majority of forest ecosystems are located in the regions of Eastern Kazakhstan. The main types of forests are mountainous areas of the Kazakhstan part of Altai, which is called Rudnyi Altai. Due to its unique landscape and biological diversity, fir, cedar, pine, deciduous (birch-aspen) and mixed forests are widespread in this region. Rational use of the forest lands of the Rudnyi Altai provides for increasing the productivity of forests, which is one of the main tasks facing the forestry in the region at the present stage. The potential of plant forest resources, as shown in separate works (Kalachev, 2014, Sorajic and Zerdelic, 2015, Filipovic *et al.*, 2015, Erturk *et al.*, 2015), makes it possible to use them in various aspects. The study of biological indicators of plant resources of individual regions in order to search for new plant species containing biologically active substances is extremely important in the food industry, pharmacology. One of the important directions is the definition of ecological safety of raw materials of wild species used in food technologies. The study of the features of the accumulation of heavy metals in plant resources, including forest berries, is of current interest to many scientists (Angelova *et al.*, 1999; Rademacher, 2003; Moilanen *et al.*, 2006; Golami *et al.*, 2012; Johnny, 2014). at present 4 elements (cadmium, lead, zinc, cobalt) are subject to compulsory rationing in plant resources and derived vegetable oils in Kazakhstan according to regulatory documents,. Manganese and copper are determined in vegetable oils according to various technical requirements, (GOST 26929-94, GOST 30178-96).

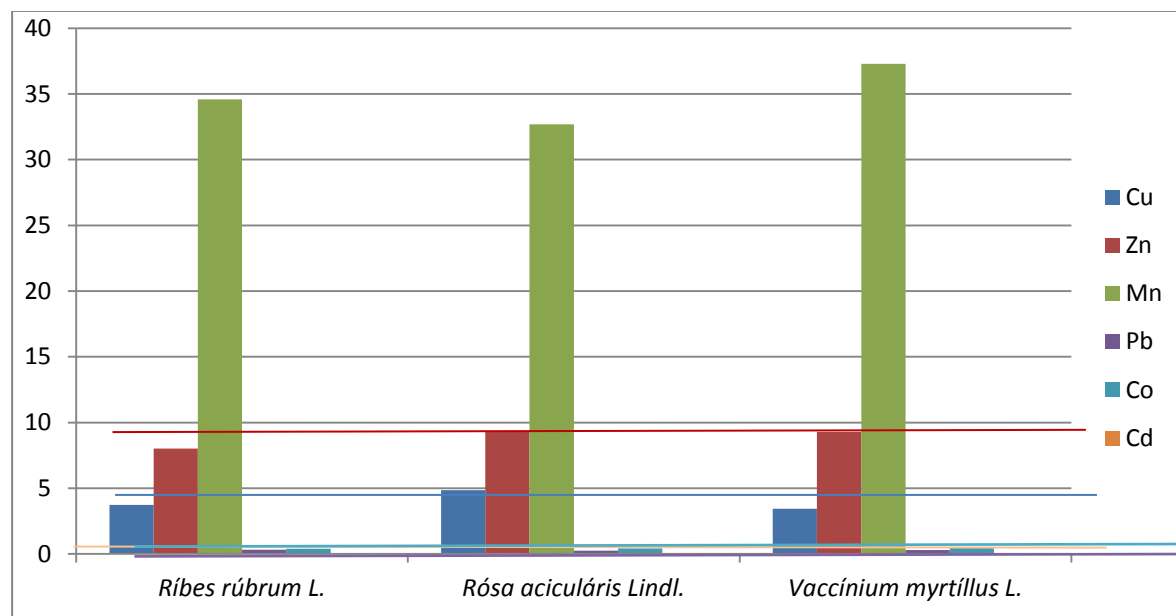
The results of the studies showed that the chemical elements studied were installed in all samples. The range of heavy metals in Cu content was within the range of 3.44-4.84 mg/kg, for Zn – 8.02-9.3 mg/kg, for Mn – 32.7-37.3 mg/kg, for Pb – 0.25-0.31 mg/kg, for Co– 0.4-0.43 mg/kg, for Cd–0.02-0.026 mg/kg. The results of determining the content of heavy metals in the investigated berry crops are shown in Table 1.

Table 1. Concentrations of heavy metals in samples of forest berries, mg/kg (x : average value from 5 repetitions ; sd : mean standard deviation)

№	Objects	Cu (x ± sd)	Zn (x ± sd)	Mn (x ± sd)	Pb (x ± sd)	Co (x ± sd)	Cd (x ± sd)
	Extremely permissible concentrations	5.0	10.0	-	0.4	0.5	0.03
1	<i>Ribes rubrum L.</i>	3.72±0.14	8.02±0.13	34.6±0.6	0.31±0.02	0.4±0.1	0.02±0.01
2	<i>Rósa aciculáris Lindl.</i>	4.84±0.26	9.3±0.42	32.7±0.4	0.25±0.11	0.41±0.1	0.02±0.01
3	<i>Vaccínium myrtillus L.</i>	3.44±0.41	9.28±0.47	37.30±0.7	0.3±0.6	0.43±0.2	0.026±0.02

\*Source: Author's elaboration based on the laboratory research.

To determine the conformity of forest berries in terms of levels of heavy metals, the norms "Sanitary Rules and Norms 2.3.2.1078-01" (SanRules, 2009) for a biological active additive on a plant basis were used. Analysis of the data in Table 1 shows that all selected samples of forest berries meet regulatory requirements. Figure 2 shows a comparative-comparative picture of the accumulation of various heavy metals in the types of berries studied.



Graph 1. Accumulation of various heavy metals in the studied berries

Experimental studies of the contamination of forest berries were below the Extremely permissible concentrations (EPC). Presumably, the sources of pollution of forest berries are the industrial enterprises of the region, providing wind-dust-transfer of elements in the air stream. On the Rudnyi Altai are various mining enterprises, which have a significant technogenic impact on natural ecosystems: in the Rudnyi Altai - Zolotushinskoye, Zmeingorskoye, Korbalkhinsky and other gold-pyrite barite-polymetallic; In the Gornyi Altai - Sinyukhinskoye gold-copper-skarn, Kalgutin molybdenum-tungsten quartz-greisen, Aktash, Chagan-Uzun mercury ore and others (Gusev, 2010). Ridder is on the 9th place out of the list of 10 contaminated cities in Kazakhstan according to KazGidroMet specialists (Smailov, 2014). Table 2 lists the index of atmospheric pollution (IAP) for large cities of the republic.

Table 2. Quality of atmospheric air in urban areas

Urban area	The index of atmospheric pollution (IAP)
Almaty	11.5
Kyzylorda	11.4
Shymkent	8.6
Ust-Kamenogorsk	7.6
Taraz	7.4
Karaganda	7.0
Temirtau	6.9
Zhezkazgan	6.5
Ridder	5.2
Atyrau	4.8

\* Data on RSE "Kazhydromet"

It is shown that the city of Ridder is included in the first ten cities of Kazakhstan with increased IAP.

### Conclusions

It has been established that all samples of contaminated forest berries are contaminated with all certain elements. *Vaccinium myrtillus L.* is contaminated with the greatest number of heavy metals (Mn, Co, Cd) to the greatest extent. *Rósa aciculáris Lindl.* occupies an intermediate position and accumulates two elements - Cu, Zn. *Ribes rúbrum L.* is the least polluted, since the highest concentration of Pb is determined in it. The level of contamination of berries Cd objects are arranged in the order *Vaccinium myrtillus L.*, *Ribes rúbrum L.* and *Rósa aciculáris Lindl.*; Pb - *Ribes rúbrum L.*, *Vaccinium myrtillus L.* and *Rósa aciculáris Lindl.* The contamination of forest berries Co and Zn shows the same picture and determined the following order: *Vaccinium myrtillus L.*, *Rósa aciculáris Lindl.* and *Ribes rúbrum L.* Experimental studies of the contamination of forest berries were below the EPC. Perhaps the transfer of dust particles in the dynamics is reduced during the ripening period of berries. Also, important is the atmospheric precipitation, which can wash away pollution from vegetative parts of plants. Thus, research on the territory of forest ecosystems of mountain forests in Eastern Kazakhstan showed a satisfactory state of contamination of forest berries with heavy metals. In this paper, the determination of heavy metals in forest berries (only on the example of *Ribes rúbrum L.*, *Rósa aciculáris Lindl.*, *Vaccinium myrtillus L.*). Species diversity of forest berries in the region is much broader, which requires continuing research to ensure food security of the population. The most important conclusion established in the course of the studies is that all samples selected meet the requirements of regulatory documents on the criterion of environmental safety.

### References

- Abdulina S.A. (1998). List of vascular plants of Kazakhstan. Almaty, pp. 156-157.
- Angelova V., Ivanov A., Braikov D., Ivanov K.(1999). Heavy metal (Pb, Cu, Zn and Cd) content in wine produced from grape cultivar mavrud, grown in an industrially polluted region. Journal International Science Vigne Vin. Vol 3, pp. 119-131.
- Chistilin, V. G. (2003). Non-timber forest products. Bryansk, pp. 270-271.
- Erturk Y.E., Gecer M.K., Yalcin S. (2015) Sixth International Scientific Agricultural Symposium „Agrosym 2015“. October 5-8, 2015, Jahorina, Bosnia and Herzegovina, pp. 2008-2018
- Evseev A.A. (2004). Atlas of the world for mineralogists. Moscow, pp. 284-285.
- FAO (2001). Global Forest Resources Assessment, Rome.
- FAO (2013). The States Of Forest Genetic Resources In The Sec Region, The Republic Of Kazakhstan Country Report, Turkey.
- Filipovic J., Stankovic S., Coloc S., Rahovic., Tomic., Ljiljanic N., Radisic R., (2015) Sixth International Scientific Agricultural Symposium „Agrosym 2015“, pp. 1961-1965.
- Golami A., Amini H., Kar S. (2012). Appraisal of berry tree (*Morus alba*) as a biomonitor of heavy metal contamination in Esfahan, Iran, International journal of Agriculture and Crop Sciences, Vol 4-9, pp. 578-581.
- GOST 26929-94 «Raw material and food-stuffs. Preparation of samples. Decomposition of organic matters for analysis of toxic elements».
- GOST 30178-96 «Raw material and food-stuffs. Atomic absorption method for determination of toxic elements» .

- Griboedova I.A., Mashkanova A.A. (2012). Economic characteristics of the use of non-timber forest resources, *Economics and Management*, № 2, pp. 95-98.
- Gusev A.I. (2010). Minerageny and minerals of the Altai Republic. -Бийск: Изд-во АГАО, p. 385..
- Hisamov R.R., Kulagin A.A. (2008). Efficiency of non-timber forest resources use in Bashkortostan // *Agrarian Russia*, № 4., pp. 45-50.
- Johnny C. (2014) Heavy metal in dried vegetables. *Journal Food Safety Focus*, vol 95, pp. 1-4.
- Kalachev A.A. (2016). Reserves for increasing the productivity of dark coniferous forests of Rudnyi Altai. *Agrarian herald of the Urals*, Vol. №04(146), pp. 66-70.
- Methodical instructions on atomic absorption methods for the determination of toxic elements in food products and food raw materials (1992). Moscow, p.26.
- Moilanen M., Fritze H., Nieminen M., Piirainen S., Issakainen J., Piispanen J. (2006), Does wood ash application increase heavy metal accumulation in forest berries and mushrooms? *Journal Forest Ecology and Management*, Vol 226, pp. 153-160.
- Petrik V.V., Tutygin G.S., Gayevsky N.P. (2003). Non-timber forest products. Arkhangelsk: ASTU, p. 260.
- Rademacher P. (2003). Atmospheric heavy metals and forest ecosystems. Vol 12. Work report of the Insitute for World Forestry.
- Sanitary rules (2010) "Sanitary-epidemiological requirements for food products". Minister of Health of the Republic of Kazakhstan, Astana.
- Smailov A.A. (2014). Environmental Protection and Sustainable Development of Kazakhstan (Statistical Digest 2009-2013). Committee on Statistics of the Ministry of National Economy of the Republic of Kazakhstan, Astana.
- Sorajic B., Zerdelic T. (2015) The effect of global G.A.P. on the financial results of agricultural holdings in Bosnia Herzegovina, Sixth International Scientific Agricultural Symposium „Agrosym 2015“. Pp 1841-1847
- Tipcina N.N. (2013). Blueberry Research. Newsletter of KrasnSAU, №11, pp 283-285.

## EVALUATION OF DOSES OF RADIATION DUE TO NATURAL RADIOACTIVITY IN CORN AS ANIMAL FEED IN THE VICINITY OF THE CITY OF SKOPJE (MACEDONIA)

Aleksandra ANGELESKA\*, Elizabeta DIMITRIESKA STOJKOVIK, Zehra HAJRULAI-MUSLIU, Radmila CRCEVA NIKOLOVSKA, Biljana DIMZOVSKA, Riste UZUNOV,  
Dean JANKULOSKI

Food Institute, Faculty of Veterinary Medicine Skopje, Macedonia

\*Corresponding author: mizasandra@fvm.ukim.edu.mk

### Abstract

Soil is the first link of the ecological chain soil-food-animals-human, and for this reason it has an important role in the distribution and transfer of radionuclides in fodder. The natural radionuclides come from the soil to the crops by means of migration and contribute for the total radiation burden in the population. The goal of this study was focused on investigation of the radioactivity in corn, and presence of natural radionuclides, and on the basis of the specific activity of the crops, we will calculate the dose which the human receives if the person consumes the examined crops. The corn samples were collected in 2016 from different locations in the surrounding of the city of Skopje. The sampling was performed so that 3 samples were taken from every location, which is in accordance with the recommendations from IAEA. The samples are measured on an instrument – gamma spectrometer (Canberra Packard) by using the program GENIE 2000. The values of specific activity and the calculated doses obtained in this study, regardless of the location, did not exceed the safety limits, pointing out the insignificant danger for radiation which arises from soil radionuclides which are naturally present. From the indicated above it follows that at a current level of radioactive contamination of corn, it would not be necessary to take measures in regard to reduction of the radioactive contamination, considering that the values of the radioactive contamination, compared to the level of radiological contamination of natural origin, are lower.

**Key words:** *radioactivity in corn; radionuclides; gamma spectrometry.*

### Introduction

The radioactive contamination of animal feed, which is the most important factor for the radiation safety of people through the food chain, imposes the need of continuous radiation control of various types of crops for animal use. Usually radionuclides penetrate in crops from the soil through the root system. The very radioactive contamination of soil can be caused by radioactive substances of natural origin, however also radioactive isotopes that are a result of the experimental nuclear explosions, nuclear reactors, as well as a many other atomic techniques and plants. The behavior of radionuclides in soil, their retaining and transfer to plants, are very complex processes that depend on many factors (Jasinka, 1980). In the soil are present about 40 different radionuclides whose contribution is different (Bockok, 1981; Tzortzis et al., 2004).

The entry of radionuclides from the soil to plant crops depends on certain factors such as: the soil type, physical and chemical properties of the soil, the fertility of the soil, its texture, pH, conductivity, carbonate and sulfate content, etc. (Clarck and Smith, 1988). In addition, the use

of phosphate fertilizers in agricultural land, such as phosphorus fertilizers, which are extremely rich in radioactive substances and belong to products of uranium decomposition, increases the contamination of plants (Abdel-Rassoul, 2007). The level of radioactive contamination of soil will mainly determine the extent to which the radioactive substance will reach the organs of the corn, and further into the other links of the trophic chain. It is necessary to pay attention to the contamination of radioactivity in soil and its absorption in corn. Thus, keeping in mind that the main purpose of the radioactive contamination investigation is its impact on people, there are numerous undertaken studies for the crops radioactivity (Vasconcellos, 1987; Arogunjo et al, 2005; Tahir, 2005; Al-Kharouf et al, 2008; Changizi et al, 2013). The purpose of this study was to examine the level and redistribution of certain radionuclides in maize production, as well as to provide preliminary (preparatory) assessment of the doses of earth exposure of the population in the surrounding of the city of Skopje, and to assess the potential danger for radiation of the population that lives in the areas under research.

### **Materials and methods**

**Sampling.** The corn samples were collected during the summer of 2016 from different locations in the surrounding of the city of Skopje. The corn samples with the root are collected so that three samples with a quantity of 1 kg are taken from each location. During the sampling, it was ensured that the micro-location is a flat terrain, which excludes the consequences of a possible horizontal translocation of radionuclides. The collected samples were carefully cleaned and root, stem, leaf, and fruit were separated.

Afterwards, the samples were air-dried at room temperature for a period of approximately three weeks in order to remove the moisture. After the drying, the samples were crushed, placed on a stand and grinded to a predetermined particle size according to the analytical requirements, and in the end the samples were passed through a sieve. The homogenized samples were packed in plastic containers that had the same geometry as the one for the reference materials wherewith the measurement equipment was calibrated.

**Instrument.** Gamma ray spectrometry technique was used for determination of radioactivity of the tested samples. The spectrometer consisted of an HPGe detector, model 3020 (Canberra Packard, Meriden, CT, USA), with an active volume of 180 cm<sup>2</sup>, relative efficiency of 30 %, an operating voltage of 3000 V, and a resolution of 2 keV at 1332.5 keV. The detector was enclosed in massive 12 cm thick lead shielding and internal lining of 2 mm high purity cooper. Data acquisition and analysis were performed with 8192 channel digital analyzer; the duration of the acquisition interval for each sample was 65 ks. The activity of <sup>226</sup>Ra was determined from the gamma lines associated with low half-live time daughters of <sup>214</sup>Bi (609.31, 1120.29, and 1794.49 keV) and <sup>214</sup>Pb (351.93 keV). The <sup>232</sup>Th activity was determined by 338.4, 911.2 and 969.1 keV gamma lines form <sup>228</sup>Ac and its decay products. The gamma line at 1460.8 keV was used to determine the activity of <sup>40</sup>K.

Efficiency calibration was performed with mixed calibration standard sources MBSS2, supplied from the Czech Metrological Institute, Inspectorate for Ionizing Radiation. In order to determine the background distribution in the detector environment, empty sealed Marinelli beaker with the same geometry was measured at equal counts as the soil samples. The analysis procedure included the subtraction of the background spectrum.

**Absorbed dose rate in air (D).**The natural decay of radionuclides in the soil is one of the main sources of the human exposure to radiation. This level of radiation is different depending on the content of minerals and radioactive elements of each region. The dose of gamma radiation which is due to natural radioactive contents of the soil is important for the population in the area where they live. The rate of absorbed does in the air for the

radionuclides with a height of 1 meter above the ground surface was calculated on the basis of the instructions provided below (UNSCEAR 2000).

$$D(\text{nGy/h})=0.462A_{\text{Ra}}+ 0.604 A_{\text{Th}}+0.042 A_{\text{K}} \quad (1)$$

where  $A_{\text{Ra}}$ ,  $A_{\text{K}}$  and  $A_{\text{Th}}$  accordingly are the average activity concentrations of  $^{226}\text{Ra}$ ,  $^{40}\text{K}$  and  $^{232}\text{Th}$ , expressed in Bq/kg.

**Calculation of the external hazard index ( $H_{\text{ex}}$ ).** The external hazard index is calculated with an equation proposed by Beretka and Mathew (1985).

$$H_{\text{ex}} = C_{\text{Ra}}/370+ C_{\text{Th}}/259+ C_{\text{K}}/4810 \quad (2)$$

where  $H_{\text{ex}}$  is the external hazard value,  $C_{\text{Ra}}$ ,  $C_{\text{Th}}$  and  $C_{\text{K}}$  are the mean activity concentrations (Bq kg<sup>-1</sup>) of  $^{226}\text{Ra}$ ,  $^{232}\text{Th}$  and  $^{40}\text{K}$ , respectively. The value of this index must be less than unity, thus keeping the radiation hazard insignificant. The maximum value of  $H_{\text{ex}} = 1$ , corresponds to the upper limit of  $\text{Ra}_{\text{eq}}$  (370 Bq kg<sup>-1</sup>).

**Calculation of radium equivalent activity.** As the distribution for  $^{226}\text{Ra}$ ,  $^{232}\text{Th}$  and  $^{40}\text{K}$  in soil samples is not uniform, exposure to radiation can be defined in terms of radium equivalent ( $\text{Ra}_{\text{eq}}$ ), to compare the specific activity of the radionuclides of (Beretka and Mathew, 1985). The radium equivalent activity could be defined as:

$$\text{Ra}_{\text{eq}} = A_{\text{Ra}} + 1.43A_{\text{Th}} + 0.077A_{\text{K}} \quad (3)$$

where  $A_{\text{Ra}}$ ,  $A_{\text{Th}}$  and  $A_{\text{K}}$  are the specific activities (Bq kg<sup>-1</sup>) of  $^{226}\text{Ra}$ ,  $^{232}\text{Th}$  and  $^{40}\text{K}$ , respectively. By defining the  $\text{Ra}_{\text{eq}}$  according to previous equation, it is assumed that 370 Bq kg<sup>-1</sup>  $^{226}\text{Ra}$  or 259 Bq kg<sup>-1</sup>  $^{232}\text{Th}$  or 4810 Bq kg<sup>-1</sup>  $^{40}\text{K}$  produce equal gamma dose rate (Singh et al, 2005).

## Results and discussion

**Determination of a specific activity.** In Table 1 the average radionuclide concentrations for  $^{226}\text{Ra}$ ,  $^{232}\text{Th}$  and  $^{40}\text{K}$  obtained from three measurements of individual corn samples are presented, associated with the respective standard deviations (SD).

Table 1. Mean values of specific activities of values of  $^{226}\text{Ra}$ ,  $^{232}\text{Th}$  and  $^{40}\text{K}$  in corn samples

	Specific activity*±SD		
	<sup>26</sup> Ra	<sup>232</sup> Th	<sup>40</sup> K
C1	0.40±0.1.0	0.06±0.02	108.15±2.00
C2	1.30±0.40	<MDA	99.00±2.00
C3	0.16±0.04	0.02±0.12	69.70±1.00
C4	0.73±0.42	0.08±0.03	85.35±1.50
C5	0.17±0.11	<MDA	99.86±1.54
C6	0.40±0.05	0.17±0.20	115.54±2.40
C7	0.08±0.33	<MDA	115.26±2.00
C8	0.29±0.20	0.15±0.03	92.00±1.70
C9	0.38±0.20	0.10±0.40	89.57±1.50
C10	0.61±0.21	1.02 ±0.45	117.21±2.50
C11	0.48±0.20	0.30±0.25	78.02±2.00
C12	0.61±0.25	0.11±0.20	195.97±2.00
C13	0.33±0.15	0.17±0.05	107.50±2.35
C14	0.62±0.08	0.94±0.04	112.48±2.50



The presented results in the table are mean values from measurements performed on corn samples taken from 14 different locations, 3 samples from each location. It can be concluded that corn absorbs  $^{232}\text{Th}$  significantly less than  $^{226}\text{Ra}$ , which is in accordance with the physical-chemical properties of this radionuclide. By analyzing potassium which is necessary for the normal course of the life functions of crops, another behavior can be observed i.e. the transport from the soil to the corn is more intensive.

The concentration of activity of  $^{40}\text{K}$  in corn is greater than the one of  $^{232}\text{Th}$  and  $^{226}\text{Ra}$ , which is consistent with the literature data (Saracević, 1990). The average activity concentrations for  $^{226}\text{Ra}$ ,  $^{232}\text{Th}$  and  $^{40}\text{K}$  and their ranges were  $0.44 \text{ Bq kg}^{-1}$  ( $0.08\text{-}1.30 \text{ Bq kg}^{-1}$ ),  $0.22 \text{ Bq kg}^{-1}$  ( $0.08\text{-}1.02 \text{ Bq kg}^{-1}$ ) and  $105.68 \text{ Bq kg}^{-1}$  ( $69.70\text{-}195.97 \text{ Bq kg}^{-1}$ ), respectively. The global average concentrations of the respective radionuclides are  $40 \text{ Bq kg}^{-1}$  ( $^{226}\text{Ra}$ ),  $40 \text{ Bq kg}^{-1}$  ( $^{232}\text{Th}$ ) and  $580 \text{ Bq kg}^{-1}$  ( $^{40}\text{K}$ ) (UNSCEAR, 2008). According to the results presented (Table 1) the levels of  $^{226}\text{Ra}$ ,  $^{232}\text{Th}$  and  $^{40}\text{K}$  for the corn samples cultivated in the Skopje city surrounding are lower than the levels determined for USA and Brasil (in Akhtar, 2005; in Changizi et al, 2013).

**Absorbed dose rates.** On basis of the data for activity concentrations applying the equations 1-3, absorbed dose rate in air (D), radiation risk index ( $H_{\text{eks}}$ ) and radium equivalent ( $Ra_{\text{eq}}$ ) were calculated, and the respective results are presented in Table 2.

Table 2. Obtained results for absorbed dose rate in air (D), radiation risk index ( $H_{\text{eks}}$ ), radium equivalent ( $Ra_{\text{eq}}$ )

	Specific activity*		
	D(nGy/h)	$H_{\text{eks}}$	$Ra_{\text{eq}}$
C1	4.76	0.023	8.81
C2	4.87	0.024	8.92
C3	4.24	0.014	5.55
C4	3.95	0.019	6.20
C5	4.27	0.021	7.85
C6	5.13	0.025	9.30
C7	4.87	0.024	8.97
C8	4.08	0.020	7.29
C9	3.74	0.020	7.04
C10	5.81	0.029	11.09
C11	3.67	0.018	6.91
C12	8.57	0.042	15.85
C13	4.76	0.023	8.85
C14	5.31	0.027	9.52

The mean value of the absorbed dose for corn samples is  $4.85 \text{ nGy/h}$  and it is lower than the global average value of  $55 \text{ nGy/h}$  (Al-Hamarneh and Awadallah, 2009). The average value of the  $H_{\text{eks}}$  radiation risk index is 0.02, which shows that there is no significant radiation risk for the population in the surrounding of Skopje. From the table itself, it may be seen that the specific average for the radium equivalent  $Ra_{\text{eq}}$  for corn samples is within the range from 5.55 to  $15.85 \text{ Bq/kg}$  and it is below the maximum recommended limit, i.e.  $370 \text{ Bq kg}^{-1}$  (El-Aydarous, 2007).

### Conclusions

The results of this study are completely compared to the international values and the results of other studies in other countries in the world. It was found that the natural levels of radioactivity in the vicinity of Skopje are not with the range of high risk and they are in

accordance with the international standards. The amount of radioactive elements in corn was so low that the health of consumers was not threatened. From the indicated above it arises that at the current level of radioactive contamination of corn, it would not be necessary to undertake measures related to reduction of radioactive contamination, considering that the values of radioactive contamination, compared to the level of radiological contamination of natural origin, are lower. These results can be used as reference values for current assessment of doses due to natural radioactivity in the surrounding of the city of Skopje.

### References

- Al-Hamarneh and M. Awadallah, (2009). Soil radioactivity levels and radiation hazard assessment in the highlands of northern Jordan, *Radiat. Meas.*, 44, 102.
- Arogunjo A.M., Ofuga, E.E., Afolabi, M.A. (2005). Levels of natural radionuclides in some Nigerian cereals and tubers, *J. Environ. Radioactivity*, 82: 1-6.
- Abdel-Rassoul A.A., Lasheen Yasser F, Seliman Ayman F. (2007). Simultaneous measurement of <sup>226</sup>Ra and <sup>228</sup>Ra in natural water by liquid scintillation counting. *Journal of Environmental Radioactivity*, 95: 86–97.
- Akhtar N, Tufail M, Ashraf M, Mohsin Iqbal M. (2005). Measurement of environmental radioactivity for estimation of radiation exposure from saline soil of Lahore, Pakistan. *Radiation Measurements*, 39(1): 11–14.
- Al-Kharouf S. A, Al-Hamarneh, I. F., Dababneh, M. (2008). Natural radioactivity, dose assessment and uranium uptake by agricultural crops at Khan Al-Zabeeb, Jordan, *J. Environ. Radioactivity*, 99, 1192-1199.
- Bocock K.L. (1981). Radionuclides in terrestrial ecosystems. Institute of terrestrial ecology Merlwood Research Station Grange-Over-Sands, Gumbria.
- El-Aydarous A., (2007). “Gamma Radioactivity Levels and Their Corresponding External Exposure of Some Soil Samples from Taif Governorate, Saudi Arabia”, *Global Journal of Environmental Research (GJER)* Vol.1, No. 2, P: 49-53.
- Berehta J. and Mathew, P.J., 1985. Natural radioactivity of Australian building materials waste and by-products. *Health Physics*, 48(8).
- L.Saracević. Research on the Effects of Acute Radioactive Contamination of Soils on the Effective Equivalent Dose and Radiation Risk of the Population of the Region of Sarajevo, Doctoral Dissertation, Sarajevo 1990.
- Clark, M.J. and Smith, F.B., 1988. Wet and dry deposition of Chernobyl releases. *Nature*, 332(6161), pp.245-249.
- Jasinska M., Niewiadomski, T. and Schwabenthan, J., (1980). On a new possibility of estimating population exposure to terrestrial sources. *Health physics*, 38(3), pp.416-419.
- Singh S., Rani, A., Mahajan R.K. <sup>226</sup>Ra, <sup>232</sup>Th and <sup>40</sup>K in soil samples from some areas of Punjab and Himachal Pradesh, India using gamma ray spectrometry. *Radiat. Meas.*, 39, 431-439 (2005).
- Tahir SN, Jamil K, Zaidi JH. (2005). Measurements of activity concentrations of naturally occurring radionuclides in soil samples from Punjab province of Pakistan and assessment of radiological hazards. *Radiat Prot Dosimetry*, 113( 4): 427–470.
- Tzortzis M., Svoukis, E. and Tsetos, H. 2004 A Comprehensive Study of Natural Gamma Radioactivity Levels and Associated Dose Rates from Surface Soils in Cyprus. *Radiation Protection Dosimetry*, 109(3), 217–22
- UNSCEAR (2000) Report to the General Assembly, with scientific annexes, Sources and effects of ionizing radiation, United Nations Scientific Committee on the Effects of Atomic Radiation, United Nations, New York.

- Vahid CHANGIZI, Elham SHAFIEI, and Mohammad Reza ZAREH Measurement of  $^{226}\text{Ra}$ ,  $^{232}\text{Th}$ ,  $^{137}\text{Cs}$  and  $^{40}\text{K}$  activities of Wheat and Corn Products in Ilam Province – Iran and Resultant Annual Ingestion Radiation Dose, Iran J Public Health. 2013 Aug; 42(8): 903–914.
- Vasconcellos LMH, Amaral ECS, vianna ME. (1987). Uptake of  $^{226}\text{Ra}$  and  $^{210}\text{Pb}$  by food crops cultivated in a region of high natural radioactivity in Brazil. J Environ Radioact, 5 : 287–302.

## THE INFLUENCE OF THE DRYING TECHNOLOGY ON THE CHEMICAL COMPOSITION OF *STENLEJ* AND *CACANSKA RODNA* PLUM CULTIVARS

Monika STOJANOVA<sup>1\*</sup>, Olga NAJDENOVSKA<sup>1</sup>, Igor IVANOVSKI<sup>1</sup>, Jovana NAJDENOVSKA<sup>2</sup>

<sup>1</sup>University of Ss. Cyril and Methodius, Faculty of Agricultural Sciences and Food, Skopje, Republic of Macedonia

<sup>2</sup>University of Ss. Cyril and Methodius, Medicine Faculty, Skopje, Republic of Macedonia

\*Corresponding author: stojanova.monika@yahoo.com

### Abstract

In fruit growing production in the Republic of Macedonia, plum growing is of great importance. Knowledge of the chemical composition of plums has significant importance for human nutrition as well as for technological processing. The aim of this research was to determine the difference in the chemical composition of fresh and dried plum fruits from the cultivars *stenlej* and *cacanska rodna*. The examinations were done in 2014. The chemical properties of fresh and dried plum fruits were determined. Drying of plums was done in a ventricular dryer with heated air. All of the tested parameters had higher values in the dried plums of both cultivars than in the fresh ones. The content of the total dry matter was higher in the dried plums of the *stenlej* cultivar (79.90%) and the *cacanska rodna* cultivar (84.00%) than in the fresh plums of the *stenlej* cultivar (17.10%) and *cacanska rodna* (19.80%). Total acid content was higher in the dried plums of the *stenlej* cultivar (0.40%) and *cacanska rodna* (0.30%). In the fresh plums this value was 0.85% for the *stenlej* cultivar and 0.97% for the *cacanska rodna* cultivar. The content of vitamin C in the dried plum fruits of the *stenlej* cultivar was 7.00 mg% and 6.80 mg% in the *cacanska rodna* cultivar. In the fresh plums this value was 5.60 mg% for *stenlej* and 4.80 mg% for *cacanska rodna*. The content of mineral matter in the dried plums of the *stenlej* cultivar was 2.50% and the dried plums of the *cacanska rodna* cultivar was 30.30%. In the fresh fruits, the content of mineral matter is 0.52% for the *stenlej* cultivar and 0.40% for *cacanska rodna*.

**Key words:** *Plums, Ventricular drying, Chemical composition.*

### Introduction

Plum (*Prunus domestica* L.), genus *Prunus* is cultivated on all continents and it is ranked fourth in fruit growing. The first written documents for the plum are from Greece, 6th century BC. It is thought that the plum is native to Western Asia and that it was made with spontaneous hybridization between *Prunus spinosa* and *Prunus cerasifera*. It grows like a medium-high tree. Different cultivars vary considerably according to color, size and characteristic of growth (Bulatović, 1989; Pantelić M. 1993). Usually every plum yields many fruits, almost equal in size. It has a round or oval fruit. It has a blue, red, creamy yellow or light green color depending on the variety (Robertson et al., 1996). The flesh of the fruit is tasty and juicy with a yellowish color with a smooth seed in the middle (Cvejanov et al., 2004).

In the fruit production in the Republic of Macedonia, the cultivation of plums is of great importance. According to the number of stems and production, it occupies the second place immediately after the apple. The large production of plums in our country is due to the fact that it has a multipurpose usable value. On the other hand, there are modest requirements for

climatic and soil conditions. It operates in hilly mountainous areas where other fruiting species are less represented.

The plum fruits contain 75-87% water and 13-25% dry matter. The taste of the fruit depends on the ratio of sugars and organic acids. In the fruit of the plum, glucose prevails in relation to fructose. The flesh part of the fruit contains up to 0.69% pectic substances that have a significance in the technology of production of marmalades, jellies and similar products. Of the minerals most contains potassium and phosphorus, and in a smaller amount of calcium, magnesium and iron. Pro vitamin A, vitamin B and C, folic acid, niacin and vitamin B6 are the most commonly present vitamins (Santos and Silva, 2008). It contains chlorophyll, carotenoids and anthocyanins, which are the most important dyes in the fruit plum. A good source is of flavonoids and polyphenolic antioxidants (Hui, 2010; Ertekin et al., 2006). The plum is low calorie fruit. It has a high energy value that is twice as big as apple fruits. It can be consumed in fresh condition, it can be dried and processed (Vereš, 2004).

Knowing the chemical composition of fruit plums is important for human nutrition, but also for the technological processing (Marković, 1986; Paliyath, 2008). The chemical composition of fresh fruit is of great importance for the choice of technological processes and quality properties of end products (Niketić-Aleksić, 1988).

Fruit plums contain a large amount of water, which reduces their durability in fresh condition (Barbosa-Canovas et al., 2007). The presence of water in the plums in large quantities allows for the development of various biochemical processes as well as the development of microorganisms (Jašić, 2007; Taiz and Zeiger, 2006). With their drying, i.e. dehydration, the water from fresh fruits is removed, causing unfavorable conditions for the development of microorganisms as causes for the internal decay (Barrett, 2004; Welti-Chanes et al., 2005).

The aim of drying is to remove a part of the water from the fruit plums, while retaining all other properties and nutrients in a same shape.

Dried fruits of plums should have all the qualitative characteristic: adequate size, meatiness, healthy fruit with sweet taste and good appearance that has the natural taste and smell (Chen, 2008). In addition, it should have a certain amount of humidity as well as an appropriate chemical composition in terms of the dry matter content, sugar content, total acids.

The aim of this research was to determine the difference in the chemical composition of fresh and dried fruit plums from the cultivars of *stenlei* and the *cacanska rodna*.

## Materials and Methods

In this research, as a material for work, fresh and commercially dried plums from the cultivar *stenlej* and *cacanska rodna* were used. The cultivar *stenlej* mature in the second half of August and it is medium lush. The fruit is medium-sized, oval-shaped, dark blue. The meat is green yellow, firm, juicy, easily separated from the bone. The cultivar *cacanska rodna* is maturing in late August and it also is medium lush. The fruit is medium large, egg-shaped and dark blue. The meat is yellow, firm, juicy, sweet and quality.

After harvesting, a visual assessment of the examined cultivars of plums has been performed. The qualitative properties of the examined cultivars of plums has been determined by determining the mechanical and chemical properties. The examination was conducted in 2014 in Valandovo region.

From mechanical properties were determined: height, width and thickness of the fruit, weight of the fruit and participation of the bone in the mass of the meat.

The chemical properties of fresh and dried fruit plums has been determined. The drying of the plums was performed in a ventricular drier with heated air. The principle of drying is precisely made to produce a distinctive odor and appearance of the plum.

From the chemical properties of fresh and dried plums from the cultivars *stenlej* and *cacanska rodna*, the following parameters were determined:

Content of total water was determined by drying the material in dryer on temperature of 105°C (Sarić et al., 1989);

Content of total dry matter was determined by calculation when from 100%, the percentage of hygroscopic water (Sarić et al., 1989);

Content of vitamin C - determined by the Thilmans method based on the redox reaction between L-ascorbic acid and organic color 2.6 dichlorophenolindophenol;

Total acid content - determined by the method of neutralization with 0.1 M NaOH solution in the presence of the indicator 1 % solution of phenolphthalein indicator;

Content of total carbohydrates - determined by HPLC method;

Content of mineral matter (ash) - determined with material burning at a temperature of 500 °C;

Content of nitrogen (N) - determined using Kjeldahl method (Sarić et al., 1989);

Content of phosphorus (P<sub>2</sub>O<sub>5</sub>) - determined by using atomic emission spectrometry with inductively coupled plasma (ICP - AEC) (Sarić et al., 1989);

Content of potassium (K<sub>2</sub>O) - determined by incineration of the material with concentrated H<sub>2</sub>SO<sub>4</sub> and plamenfotometar (Sarić et al., 1989);

Content of calcium (SAT) - determined by using atomic emission spectrometry with inductively coupled plasma (ICP - AEC) (Sarić et al., 1989);

Content of magnesium (Mg) - determined by applying atomic; emission spectrometry with inductively coupled plasma (ICP - AEC) (Sarić et al., 1989);

Proteins – determined with calculation when the % N is multiplying with coefficient 6.25

In dried plums, two pretreatments were made, and three variants were getting: variant M1 - control variant; Variant M2 - where the pretreatment was performed with a 2% solution of ascorbic acid for 5 minutes; Variant M3 - where the pretreatment was carried out with 3% potassium metabisulphite for a period of 5 minutes. The content of the mineral matters nitrogen, phosphorus, potassium, calcium and magnesium, as well as the protein content, was analyzed only in the three cultivars of dried plums.

## Results and Discussion

The mechanical and the chemical content are specific for each kind of plums. The mechanical properties are basic requirement for cost-effective production of plums. Size is an important characteristic for each plum kind. By analyzing the mechanical properties, is determined the weight ratio of separate parts of the plums in percentage. Chemical composition of the plums means the content of all ingredients in the plums including the water. The mechanical properties were determined by measuring 50 fruit plums separately for each cultivar. From the performed measurements (Table 1), it was determined that the plums from the cultivar *stenlej* have higher average height (48.4 mm), larger width (35.2 mm), greater thickness (33.8 mm), larger mass of the fruit (33.4 g) and greater participation of the bone in the mass of meat (5.46 g) compared to the fruit plums from the cultivar *cacanska rodna*.

Table 1. Mechanical properties of fresh *stenlej* and *cacanska rodna* plum cultivar

Cultivar	Average high (mm)	Average width (mm)	Average thickness (mm)	Average fruit mass (g)	Bone part in the plum mass (g)
<i>Stenlej</i>	48.40	35.20	33.80	33.40	5.46
<i>Cacanska rodna</i>	41.0	31.80	28.40	26.40	4.50

Table 2. Chemical composition of fresh plums from *stenlej* and *cacanska rodna* cultivar

Components	<i>Stenlej</i> fresh plum	<i>Cacanska rodna</i> fresh plum
Total water (%)	82.90	80.20
Total dry matters (%)	17.10	19.80
Total acids (%)	0.85	0.97
Vitamin C mg/100g	5.60	4.80
Mineral matters (ash) (%)	0.52	0.40
Total carbohydrates (%)	8.10	8.90

From the data presented in Tables 2, 3 and 4, can be concluded that the total water content is higher in the fresh plums of both cultivars, where it is 82.90%, in *stenlej* cultivar and 80.20% in *cacanska rodna* cultivar, and in dried fruits, the highest content of total water is in the variant M3 (21.20%) in *stenlej* cultivar and 18.00% in the cultivar *cacanska rodna*.

The content of total dry matters is in correlation with the content of total water and its value is 19.80% in the fresh plums from *cacanska rodna* cultivar, i.e. 84.00% in the variant M2 from dried plums from *cacanska rodna* cultivar.

The fresh plums from *cacanska rodna* cultivar have higher content of total acids (0.97%). The highest content of total acids in the dried plums have the variant M1 in *stenlej* cultivar (0.40%), i.e. in *cacanska rodna* cultivar (0.30%).

Table 3. Chemical composition of dried plums from *stenlej* cultivar per variants

Components	M1	M2	M3
Total water (%)	20.30	20.10	21.20
Total dry matters (%)	79.70	79.90	78.80
Total acids (%)	0.40	0.35	0.20
Vitamin C mg/100g	6.50	7.00	6.80
Mineral matters (ash) (%)	2.50	2.20	2.00
Total carbohydrates (%)	10.40	9.90	10.30
N (%)	0.80	0.73	0.65
P (%)	1.25	1.10	0.95
K (%)	1.23	1.17	1.25
Ca (%)	1.90	1.20	1.60
Mg (%)	0.95	0.60	0.80
Proteins (%)	5.00	4.56	4.06

Table 4. Chemical composition of dried plums from *cacanska rodna* cultivar per variants

Components	M1	M2	M3
Total water (%)	16.50	16.00	18.00
Total dry matters (%)	83.50	84.00	82.00
Total acids (%)	0.30	0.22	0.20
Vitamin C mg/100g	6.30	6.80	5.40
Mineral matters (ash) (%)	3.10	3.30	2.90
Total carbohydrates (%)	12.70	11.90	11.80
N (%)	0.50	0.47	0.35
P (%)	1.10	0.80	0.82
K (%)	1.05	1.25	1.30
Ca (%)	1.40	1.10	1.30
Mg (%)	1.20	1.10	1.15
Proteins (%)	3.12	2.93	2.19

In the fresh plums from *stenlej* cultivar is getting higher content of vitamin C (5.60%) as well as higher content of mineral matters (0.52%). The highest content of vitamin C in both dried plum cultivars was determined in variant M2 (7.00% in *stenlej* cultivar and 6.80% in *cacanska rodna* cultivar), where the pretreatment was made with 2% solution of ascorbic acid. The highest content of mineral matters in dried plums, was determined in the variant M1 in *stenlej* cultivar (2.50%) and in variant M2 in *cacanska rodna* cultivar (3.30%). In the fresh plums, the content of carbohydrates is lower than in the dried plums. The highest content of carbohydrates in dried plums was determined in variant M1 (10.40%) for *stenlej* cultivar and 12.70% for *cacanska rodna* cultivar. The content of mineral matters: nitrogen (0.80% in *stenlej* cultivar and 0.50% in *cacanska rodna* cultivar), phosphorus (1.25% in *stenlej* cultivar and 1.10% in *cacanska rodna* cultivar), calcium (1.90% in *stenlej* cultivar and 1.40% in *cacanska rodna* cultivar), magnesium (0.95% in *stenlej* cultivar and 1.20% in *cacanska rodna* cultivar) and proteins (5.00% in *stenlej* cultivar and 3.12% in *cacanska rodna* cultivar) is the highest in dried plums from the variant M1.

The content of potassium has the highest value in both cultivars of dried plums in variant M3, where the pretreatment was made with 3% solution of potassium etabisulphite. From the presented data can be concluded that the two cultivars of plums are suitable for ventricular drying because their chemical composition after drying does not change in negative direction. From the three cultivars of dried plums, the variant M1 which has no pre-treatment, is characterized with the best chemical composition. Therefore, this variant is recommended for consumption, as a food with a rich chemical composition and excellent nutritional properties.

### Conclusion

Based on the analyses and the obtained results for determining the influence of drying technology on the chemical composition of the plum fruits from the cultivars *stenlej* and *cacanska rodna*, the following conclusions can be made:

The chemical composition of the plums is of special importance for human nutrition, but also for the choice of the technological processing;

In the three cultivars of ventricular dried plums, higher content of all tested parameters in both cultivars has been determined, compared with fresh plums;

The two cultivars of dried plums from the control variant, M1, have the highest content of nitrogen, phosphorus, calcium, magnesium and proteins;



Dried plums from variant M1, which had no pre-treatment, are characterized with the best chemical properties;

The potassium content in the two cultivars of dried plums is the highest in M3 variant, where the pretreatment was made with 3% solution of potassiummetabisulphite;

Ventricular drying is in the initial stage in our country. With the introduction of ventricular in general practice, will increase the income of farmers, production, employment and foreign exchange inflows into the country.

### References

- Barbosa-Cánovas, V. G., Fontana, Jr. J. A., Schmidt, J. S., Labuza, P. T. (2007). *Water Activity in Foods - Fundamentals and Applications*, John Wiley & Sons, Iowa.
- Barrett, D. M., Somogyi, L., Ramaswamy, H. (2004). *Processing fruits*, Science and Technology, CRC Press, London.
- Bulatović, S. (1989). *Modern fruit growing*, Nolit, Belgrade.
- Cvejanov S., Tošić B., Gavrilović M., Pejin D., Grujić O., Ružić N. (2004). *Food technology*, Center for books, Belgrade.
- Chen, X.D. (2008). *Food drying fundamentals. Drying technologies in food processing*. Wiley-Blackwell Publishing, West Sussex, UK.
- Ertekin, C., Gozlekci, S., Kabas, O., Sonmez, S., Akinci, I., (2006) Some physical, pomological and nutritional properties of two plum (*Prunus domestica* L.) cultivars. *J. Food Eng.* 75: 4, (508-514).
- Hui Y.H. (2010): *Handbook of fruit and vegetable flavors*, John Wiley & Sons Inc., New Jersey 3
- Jašić, M. (2007). *Fruit and vegetable technology - I part*. Faculty of technology, Tuzla.
- Marković, V. (1986). *Dry plum: drying, keeping, processing, and packing*, Phipo, Šabac.
- Niketić-Aleksić G. (1988). *Fruit and vegetable technology*. Faculty of Agriculture, Belgrade.
- Pantelić M. (1993). *Plum growing and processing*. Fruit and vegetable company, Belgrade.
- Paliyath, G., Murr, D.P., Handa, A.K., Lurie, S. (2008). *Postharvest Biology and Technology of Fruits, Vegetables, and Flowers*. Wiley-Blackwell Publishing: Iowa, USA.
- Robertson J.A., Meredith F.I., Senter S.S., Okie W.R., Norton J.D. (1992): Physical, chemical and sensory characteristics of Japanese-type plums growing in Georgia and Alabama. *Journal of the Science of Food and Agriculture*, 60: (339–347).
- Santos, P. H. S., Silva, M. A. (2008). Retention of vitamin C in drying processes of fruits and vegetables - A review. *Drying Technology*, 26, (1421-1437).
- Sarić, M., Stanković, Z., Krstić, B. (1989). *Plant physiology*, Science book, Novi Sad, Serbia.
- Taiz, L., Zeiger, E. (2006). *Plant Physiology*, Fourth Ed. Sinauer Associates, Inc.: Massachusetts, USA.
- Vereš, M. (2004). *Principle for food conserving*, Faculty of Agriculture, Beograd.
- Welti-Chanes, J., Bermúdez, D., Valdez-Fragoso, A., Mújica-Paz, H., Alzamora, S.M., (2005). *Dehydrated Vegetables: Principles and Applications in Hui, Y. H., Sherkat, F. (ed.): Handbook of Food Science, Technology, and Engineering - 4 Volume*. CRC Press. pp. (1-61).

## INFLUENCE OF BIOFERTILIZERS ON SOIL MICROFLORA IN PRODUCTION OF SAFETY FOOD

Olga NAJDENOVSKA<sup>1\*</sup>, Monika STOJANOVA<sup>1</sup>, Jovana NAJDENOVSKA<sup>2</sup>, Dejan TANESKI<sup>2</sup>, Marina STOJANOVA<sup>1</sup>

<sup>1</sup>Faculty of Agricultural Sciences and Food, Ss. Cyril and Methodius University, Skopje, Macedonia

<sup>2</sup>Medical faculty, Ss. Cyril and Methodius University, Skopje, Macedonia

\*Corresponding author: olganajdenovska@gmail.com

### Abstract

The impact of biofertilizers on the dynamics of the total number of bacteria, fungi, actinomycetes and nitrobacteria and aerobic cellulitic microorganisms in the soil has been examined. Tests were performed on different types of soils under crop of strawberry, Swiss chard and lettuce. The experiment was placed in random block system in two variants and three repetitions. Variants in the experiment were: Variant 1 - Control and Variant 2 - using microbiofertilizers. The biofertilizers were foliarly applied, with dorsal nozzle every fifteen days during the crop vegetation. The application of microbiofertilizers with strawberry started from the time of flowering of the culture, until the completion of harvesting the strawberry every seven days, and the chard and lettuce from planting the crop by the end of vegetation also every fifteen days. Microbiofertilizer has been used, the Microbiological fertilizer Slavon. Before the application the fertilizer gets dissolved in water 1:100 (100ml/10l). Before the application the microbiofertilizer agrochemical analysis of the soil was carried out. We found that the application of microbiofertilizers affects the dynamics of microorganisms in the soil and increases their number during the vegetation in three cultures. The highest numbers of examined groups of microorganisms in the soil is found at the end of the vegetation in all three cultures, and the lowest number at the beginning of the vegetation. The use of microbiofertilizers affects the improvement of biogenesis and biological activity of the test soil, in order to produce environmentally safe and healthy product.

**Keywords:** *Soil, Microorganisms, Swiss chard, Strawberry.*

### Introduction

Biofertilizers have an organic origin and promote the primary agricultural production. They are used to improve the physico-chemical properties of the soil, increasing the fertility of the soil and productivity of the observed crops by increasing the microbial activity. (Malik et al., 2005; Galloway et al, 1995). The use of biofertilizers reduces the use of agrochemicals by making them exceptionally favorable in the production of health-safe food. (Červenski et al., 2013; Vasić, 2014). Biofertilizers are used as fertilizers in which bacterial and fungal cultures produce phosphatases and supply plants with wood-affordable phosphorus or they are used in combination with nitrogen-fixing bacteria that supply plants with nitrogen. (Najdenovska et al., 2012; Govedarica, 2000). The most active relationships between plants and microorganisms are established in the rhizosphere of soil (Kennedy, 2005). Microorganisms participate in the exchange of materials and energy in nature. They play a major role in one of the most important processes in the ground. Microorganisms are carriers of the process of biological nitrogen fixation (Govedarica et al., 1996, 1997). With the use of microbiological fertilizers, through foliar application on the agricultural crops, the use of skimmers of nitrogen fertilizers is reduced, the adoption of plant phosphorus is facilitated by the plants, they affect

the dynamics of microorganisms and the microbiological processes that indirectly influence the maintenance and increase of fertility At the beginning (Najdenovska et al., 2013; Djordjević et al., 2004). According to Miskoska-Milevska et al., (2012), the effect of microbial fertilizers depends on the strain of bacteria, the concentration of the bacterial cells in the inoculant, the type of plants, the application of agromeliorative measures and the physico-chemical properties of the soil. Through the application of microbial fertilizers, ie the introduction of living microorganisms in the soil, the plants are provided with nutrients and a healthy environment is maintained and production of environmentally sound products is allowed (Najdenovska and Djordjevic, 2009).

The purpose of the research in this effort is to examine the influence of the application of microbial fertilizers on the dynamics of different groups of microorganisms in the soil, in conditions of organic farming and production of health-safe strawberry, marl and shrimp.

### Material and Methods

The examination of the dynamics of microorganisms in the soil with the application of biofertilizers was carried out on alluvial soil type under sowing of strawberry (*Fragaria spp.*), Swiss chard (*Beta vulgaris, var.vulgaris, L.*) and lettuce (*Lactuca sativa, L.*). The experience with strawberry from the homogeneous variety Alba is set on the experimental area of 200 m<sup>2</sup>, in the village of Stracinci, Skopje. The strawberry is grown on black foil. The taste with swiss chard and lettuce was placed in greenhouses in the village of Piperevo, Strumica. The lettuce was grown on a total area of 67.5 m<sup>2</sup>, with the basic size of the experimental plot of 7.5 m<sup>2</sup> or (3 x 7.5 m<sup>2</sup> = 22.5 m<sup>2</sup> x 3 = 67.5 m<sup>2</sup>). The swiss chard is cultivated on a total area of 70.2 m<sup>2</sup>, with the basic size of an experimental plot of 7.8 m<sup>2</sup> or (3 x 7.8 m<sup>2</sup> = 23.4 m<sup>2</sup> x 3 = 70.2 m<sup>2</sup>), in the period from March to Month of May. The trial with the three examined cultures was set in two variants in three repetitions per random block system. The variants of the experiment were: Variant 1 - without the use of microbiophyllators and Variant 2 - by application of microbiophyllizers. Biofilterers are applied folially, with a dorsal spray every seven days during the vegetation of the crops. The application of microbiophalizers on strawberries began at the period of flowering of the crop to the end of the harvesting of strawberry, and in the shrubs and lettuce from the planting of the crops until the end of the vegetation. During the test, the microbiophalizer Slavol was used. Prior to application, the microbiological fertilizer was dissolved in water at a ratio of 1: 100 (100 ml / 10 l). During the cultivation of the culture, appropriate agrotechnology (irrigation and spraying of crops) was applied. Agrochemical analysis of the soil was performed prior to the application of microbiophalizers. The following parameters were determined: pH value; Content of available nitrogen, phosphorus and potassium; Content of carbonates; Content of humus. All parameters were determined according to standard methods by Bogdanović et al., 1966. The soil samples were taken at depths from 0 to 30 cm. The strawberries were taken three times during the vegetation: the first trial at the very beginning of strawberry flourish (first decade of April), the second rehearsal before the start of the first harvest (first decade of May) and the third rehearsal after the last (fourth) strawberry harvest (End of May). In the experiment with swiss chard and lettuce, three soil samples were also taken: First test at the stage of 4 petals (April); Second trial in the growth phase (May) and the third trial in the phase of technological maturity.

Trough microbiological analysis of the soil, the dynamics of: azotobacteria, ammonifiers, aerobic cellulolitic microorganisms, fungi and total number of bacteria were determined.

The number of microorganisms is determined by an indirect method of seeding the appropriate dilution of the soil suspension of selective nutrient substrates (Govedarica and Jarak, 1997).

## Results and discussion

Soil is an open, biological system in which there is a constant exchange of energy and circulation of the materia under the influence of several factors, among which the most important are the biological. The biological factors include all living organisms, and from all living organisms, carriers of the circular motion of the material in the soil are microorganisms (Kennedy, 2005). Although they represent less than 1% of the basic starting component with their role in the transformation and circulation of the material, microorganisms represent a basic chain in the formation of quality and fertile soil. The soils in a region with a climate such as ours are rich in microorganisms. Their number and variety is conditioned by several factors, including: the physico-chemical characteristics of the soil, the pH value and the water-air regime at the ground (Kiss et al., 1978); Biological factors such as the appearance of the plant and the influence of man through his activity; And applications of agro-technical measures (Jarak et al., 1990; Jarak et al., 1999).

Table 1. Agrochemical analysis of soil

Crop	Soil properties (0-30 cm of depth)						
	pH		Available nutrients (mg 100 g <sup>-1</sup> )			Percent	
	H <sub>2</sub> O	KCl	N	P <sub>2</sub> O <sub>5</sub>	K <sub>2</sub> O	Humus	CaCO <sub>3</sub>
Strawberry	7.60	7.00	5.50	18.20	28.30	2.70	0.20
Lettuce	7.35	6.73	6.50	14.10	31.10	1.20	/
Swiss chard	8.02	7.43	6.50	23.90	20.00	3.60	2.30

According to pH the value is based on strawberry and marl, which is neutral, but poorly ground under the shade. What all three layers do is medium-low, nitrogen is available. According to pH the value is based on strawberry and marl, which is neutral, but poorly ground under the shade. What all three layers do is medium-low, nitrogen is available. Lower-order nitrogen is available under strawberry and lettuce, and it is well-fertilized under the sowing of swiss chard. Good fertility is available to all three. Highly fruitful according to the content of the humus under the strawberry and lettuce sowing, and well-fertilized under the sowing of swiss chard. The soil is poorly carbonated under strawberry and swiss chard, and there is no presence of carbonates under the seeds of lettuce. Table 2 shows the dynamics of the microorganisms in the root of the strawberry. The number of nitrogen bacteria in the course of strawberry vegetation has been steadily rising. The vegetation period is an important factor that influences the microbiological activity in the soil (Jarak et al., 1990). The highest number of azotobacter (904) was recorded in the last vintage phase. The number of ammonifiers is increasing during the growth of strawberries. Most ammonifiers (74534) are determined by variant V2 at the last vintage. Most of the cellulite microorganisms were recorded in the soil (12307) in the period of strawberry cutting prior to the application of microbiological fertilizers. The following two phases have a decrease in the number of cellulite microorganisms. The content is higher in the control variant in comparison to the treated variant.

The highest number of fungi was recorded in the soil (596), during the period of cutting before the use of microbiological fertilizers. Microbiological fertilization decreases the number of gaps in the soil, which is positively because it improves the pH of the soil.

Microbiological fertilizer has a positive effect on the total number of microorganisms. The lowest content of the total number of microorganisms (133974) is determined during the cutting period, and the highest in the third phase (683167) in the control variant.

The lowest content of total number of microorganisms (133974) was determined in the blooming period, and the highest in the third phase (683167) in the control variant.

Table 2. Dynamics of microorganisms in soil under sowing of strawberry

Type of microorganism	1. Start of flowering		2. First harvest		3. Last harvest	
			B1	B2	B1	B2
Azotobacter	596		751	683	782	904
Ammonifier	22435		42176	34210	47904	74534
Cellulite microorganisms	12307		9487	4868	10680	4730
Fungi	596		95	78	186	161
Total number of bacteria	133974		306122	171052	683167	649101

Table 3. Dynamics of microorganisms in soil under sowing of swiss chard

Type of microorganism	1. 4 leaves phase		2. growth phase		3. technological maturity phase	
	B1	B2	B1	B2	B1	B2
Azotobacter	5	20	12	24	25	40
Ammonifier	434000	13642000	527000	719000	472000	1236000
Cellulite microorganisms	66000	13100	69200	34000	68100	54900
Fungi	31530	40880	2690	2300	9670	7030
Total number of bacteria	55000	120000	357000	428000	687000	12593000

Table 4. Dynamics of microorganisms in soil under sowing of lettuce

Type of microorganism	1. 4 leaves phase		2. growth phase		3. technological maturity phase	
	B1	B2	B1	B2	B1	B2
Azotobacter	33	36	47	34	28	12
Ammonifier	1743000	16000	273000	1295000	470000	694000
Cellulite microorganisms	8200	45900	23500	40400	57300	72100
Fungi	27540	6990	4260	2350	6830	6720
Total number of bacteria	3200	3800	224000	1235000	1388000	1437000

Table 3 shows the dynamics of microorganisms in swiss chard soil. The largest number of azotobacter (47) is determined in the control variant in the second phase. The number of azotobacters in the third phase is the lowest compared to the other phases. The number of ammonifiers has increased in the second (1295000) and in the third phase (694,000) in variant 2. The number of cellulite microorganisms has a tendency to rise in the three stages of the test. The highest number is determined in variant 2 (40400) in the second and 72100 in the third stage. The total number of fungi tends to decline in the second and third stages of the test. The largest number of fungi (27540) are in the control variant of the first phase of the trial, and the smallest number (2350) in the second phase of the trial in variant 2. The lowest total number of bacteria in the first phase of the test, and the largest in the third phase of the trial. In all three phases of the trial, the highest content of total bacteria is determined in variant 2 where the microbiological fertilizer is used. The number of azotobacter increases from the first to the third stage of the test. In variant 2, in all three phases, a higher number of azotobacter was determined in relation to the control variant. The smallest number of azotobacter (5) was determined in the control variant of the first phase, and the largest number of azotobacter (40) was determined in variant 2 of the third stage of the test. In all

three phases of the trial, most of the ammonifiers were achieved in variant 2 compared to the control variant. Most of the ammonifiers (13642000) are determined in variant 2 of the first phase of the test, while in the second and third phases there is a decrease in the number of ammonifiers. The number of cellulite microorganisms in the three stages of the trial is greatest in the control variant. The highest number of cellulite microorganisms (69200) was obtained in the control variant of the second phase. The number of fungi in both variants is greatest in the first phase, and in the second and third phases their number is declining. The total number of bacteria increases from the first to the second and third stages. A higher number of total microorganisms in the three stages of the trial was determined in variant 2 with respect to the control variant. The total number of bacteria is the largest (12593000) in variant 2 in the third stage.

### **Conclusion**

Based on the results obtained from the study of this paper, it can be concluded that the application of microbiophalizers affects the increase in the number of all investigated groups of microorganisms in the soil under sowing of strawberry, swiss chard and lettuce during vegetation, with the exception of fungi whose number is reduced during vegetation. The highest prevalence of azotobacter, ammonifiers and cellulite microorganisms was observed in the third phase of the soil test in the three crops. The number of fungi is the highest in the first phase of the soil test in all three cultures. The use of microbiophyllators has an impact on the improvement of the biogenicity and biological activity of the investigated soil, without the use of mineral fertilizers, and in order to produce an environmentally safe and healthy product. All this suggests that the application of biofertilizers should take their place in modern agricultural production.

### **References**

- Bogdanović M., Velkonija N., Rasz Z. (1966): Chemical methods of soil analysis. Book I, sine loco, (44, 162, 184, 189).
- Červenski, J., Adamović, A., Sikora, V., Vasić, M., Gvozdanović-Varga, J., Berenji, J., Maksimović, L., Djalović, I., Terzić, S., Popović, V., Vasić, R., Petrović, A., Savić, A. (2013): Seeds and organic products. Published in journal 47. Counseling agronomists Serbia, Zlatibor, Serbia: Scientific Institute of Field and Vegetable Crops, (93- 103).
- Djordjević, S., Jakovljević, M., Santric, Lj., (2004): Effects of the bacterization of the paprika with fertilizer "SLAVOL" in the production of seedling. Book of science papers, Vol. 10 br. 1. (115-120).
- Galloway, J.N., Schlesinger, W.H., Levy, H., Michaels, A., and Schnoor, J.L. (1995): Nitrogen fixation. *Global Biogeochemical Cycles*, 9 (2), (235-252).
- Govedarica M., Milošević N., Jarak M., Djurić S., Milošev D., Jeličić Z., Krunic V., Petrović N. (1996): Importance of biological nitrogen in agricultural production. Fifth congress of ecologists of Yugoslavia: Collection of summaries, Belgrade, pp. (99-108).
- Govedarica M., Jarak M. (1997): Practical book of microbiology, University in Novi Sad, (45, 122, 125, 129, 135, 142).
- Govedarica, M., (2000): The influence of diazotroph on the yield of corn, sunflower and sugar swiss chard.. *Yearbook of Scientific papers*, number 1-2, (31-38).
- Jarak, M., Redžepović, S., Milošević, N., Govedarica, M., (1990): Activity on the urease in some soil types. 2 Yugoslav symposium of the microbiological ecology. Book of the papers, 16-19.10, Zagreb, pp. (155-161).

- Jarak, M., Govedarica, M., Milošević, N., (1999): Microorganisms and fertility. Chapter in the monograph "Fertility in farming". Ed. I. Molnar. Scientific Institute of Field and Vegetable Crops, Novi Sad, (277-289)
- Kiss, S., Bularda, D., Radulesku, D., (1978): Soil polysaccharides: activity and agricultural importance of the soil enzymes, editor B.R.G. Burns, (117-140).
- Kennedy, A.C., (2005): Rhizosphere and Principles of use of Soil Microbiology, D.M., Sylvia, J.J., Fuhrmann, P.G., Hartel, and D.A., Zuberer, eds., 2<sup>nd</sup> ed. Pearson, Prentice Hall, New Jersey, pp. (242-262).
- Miskoska-Milevska E., Najdenovska O., Selamovska A., Popovski Z., Djordjević S. (2012): The effect of microbiological fertilizer- slavol on strawberry leaf area and stomatal number, *Zemljiste i Biljka*, Belgrade Vol. 61, No. 3, pp. (147-158).
- Malik, B.S., Paul, S., Sharma, R.K., Sethi, A.P. and Verma, O.P. (2005) : Effect of *Azotobacter chroococcum* on wheat (*Triticum aestivum*). *Indian Journal of Agriculture Sciences* 75: (600-610).
- Najdenovska O., Jarak M., Colo J., (2013): Microbiology. University „St Cyril and Methodius“ Skopje.
- Najdenovska, O., Jarak, M., Djordjević, S., (2002): The influence of azotobacter on chemical characteristics of potato bulbs. *Mikrobiology*, Belgrade, Vol 39, No 1-2, (27-34).
- Najdenovska O., (2012): The effect of the application of microorganisms in the production of quality potatoe. *Zemljište I biljka*, Belgrade, Vol. 61, No. 1, (15-21).
- Vasić, M., (2014): Preservation and increase of agrobiodiversity in organic production. Published in the *Wonderful World of Organic Agriculture*, "Green network of the Vojvodina", Novi Sad, Serbia, Lazić B. (ed.), (81-92.).

## GENETICALLY-MODIFIED FOOD AND ITS IMPACT ON OVERCOMING MALNUTRITION

Muhammad suhail IBRAHIM<sup>1\*</sup>, Asif AHMAD<sup>2</sup>, Maria KHAN<sup>3</sup>, Zaheer AHMAD<sup>4</sup>, Asma SOHAIL<sup>5</sup>

<sup>1</sup>Institute of Food and Nutritional Sciences PMAS, Arid Agriculture University, Rawalpindi, Pakistan

<sup>2</sup>Institute of Food and Nutritional Sciences PMAS, Arid Agriculture University, Rawalpindi.

<sup>3</sup>University College of Agriculture, University of Sargodha

<sup>4</sup>Department of Home and Health Sciences Allama Iqbal Open University, Islamabad

<sup>5</sup>Institute of Food and Nutritional Sciences PMAS, Arid Agriculture University, Rawalpindi

\*Corresponding Author: choudhary.mohammad@hotmail.com

### Abstract

GM foods or GMOs (genetically-modified organisms) is most commonly used to refer to crop plants created for human or animal consumption using the latest molecular biology techniques. These plants have been modified in the laboratory to enhance desired traits such as increased resistance to herbicides or improved nutritional content. Malnutrition is the most threatening aspect in present scenario. We have not quantity and quality of food for alarmingly increasing population. GM crops can play vital role in malnutrition especially overcoming the nutritional deficiencies disorders. Only six Asian countries involve in adoption having very low proportion. The GM crops adoption by the Asian countries is question mark. The enhancement of desired traits had traditionally been undertaken through breeding, but conventional plant breeding methods were very time consuming and were often not very accurate. GM crops are now also being developed for the production of recombinant medicines and industrial products, such as monoclonal antibodies, vaccines, plastics and biofuels. Genetic engineering, on the other hand, can create plants with the exact desired trait very rapidly and with great accuracy. In 1990 china was the first who commercialize the first transgenic plant. Food and Drug Administration Authority approved commercially the flavor Savor Tomato in 1994. This genetic manipulation delayed ripening after harvesting. GM products which are currently in the pipeline include medicines and vaccines, foods and food ingredients, feeds and fibers. Locating genes for important traits, such as those conferring insect resistance or desired nutrients-is one of the most limiting steps in the process.

**Keywords:** *Food safety, genetically modified food. Environment, Biodiversity, Toxicity.*

### Introduction

Genetically modified organisms are produced by the use of novel molecular techniques to transfer the gene of interest from distinct specie to another. Organism having a foreign gene inserted in its genome is called as transgenic. According to Schneider and Schneider (2002) modification in the genetic constitution through DNA recombinant technology results in the development of genetically-modified foods (GM foods). Use of genetic engineering made it possible to transfer gene of interest from wild relatives and distinct species that is impracticable through conventional breeding. Genes could not only be transferred from the plant species but from non-plant species (Whiteman, 2000). About 90 million hac area was grown by GM crops in 2005 out of which 33.9 million hec area is under developing countries (Kimenju and Groote, 2007; James, 2006). Technology is rapidly adopted in some parts of Asia, north and South America (Kimenju and Groote, 2007). Malnutrition is a global issue but



developing countries are at a greater risk to it. Malnutrition in its both aspects as protein deficit food intake or intake of food deficit in iodine, iron, zinc and vitamin A has negative impact on health and mental growth of human (Muller and Krawinkle. 2005). Insufficient food intake, insufficient energy intake and mineral deficiency are major causes of malnutrition. Kramer and Allen (2015) reported 26% stunted growth, 3 % mortality in children worldwide while 45 % of children were found underweight during year 2012. World population is increasing day by day and is predicted to rise by 30 % up to 2050. According to Whitman (2000) world population is 6 billion currently which is expected to double in next 50 years. To ensure the food demand for rising population masses sustainable economic yield must be ensured. Thus food security issues are putting a lot of pressure to increase agricultural productivity and biotechnology can be used as efficient tool to achieve the goal. Biotechnological tools are highly adopted by developing countries to increase crop productivity because they are at a greater risk of food insecurity. Improved health and nutrition of the consumer by the use of genetically modified food has been reported (Bouis, 2007). Introgression of dwarfing gene through conventional breeding overcome the lodging and also increases the economic produce of wheat and rice crop. Sudden boost in the yield resulted in Green revolution in 1960's. Use of genetic engineering is making a pace in the current research world as "Gene Revolution" is the revolution predicted in 21st century. Bouis (2007) has postulated 3 possible ways GM crops could benefit the human nutrition i.e. through increased yield by the transfer of novel gene, through reduced chemical contamination in B.t crops and through transfer of genes for improved micro nutrition. Genetically modified crops are not only grown as crops but can also be used for other purposes. Research on genetic modification for the incorporation of edible vaccines in tomatoes and potatoes is in progress while GM poplar tree have been found effective in remediation of metal toxic soils (Whitman 2000). Genetic Engineering is a novel technique which is used to enhance quantity and quality of agricultural production. Several important crops have been modified for increased yield and quality attributes. However use of technology is controversial and further research is also required for a better understanding of the technology and its role in food security. A lot of expertise and high cost input is also required for growing GM crops which lacks in the developing countries.

#### **Extent of food security and malnutrition:**

Food unavailability is concomitant to human malnutrition. Food security does not always meant for the availability of sufficient food but a complete diet comprising of all essential nutrients (minerals & vitamins). Diet plan is a major cause of malnutrition. Unavailability of food, poor asses to food and improper utilization of food were reported as determinant of hunger in the world (Stein, 2007). More as one billion people from 6 billion people were found undernourished (FAO, 2009). Schmidhuber and Tubiello (2007) predicted 5-170 million more people at the risk of hunger up to 2080. Booth and smith (2001) discussed food insecurity, its causes and its negative impact on health of Australian nation. Developing nations has greater intake of staple food and whole grains but low intake of fruits and vegetables that are enriched source of minerals. People consuming rice as staple food experience color blindness because rice lack carotene in it. Wheat is staple food in Pakistan and wheat flour is consumed after milling. Wheat embryo contains sulphur and selenium while bran contains iron, zinc and copper (Gregori et al., 2000; Lyons et al., 2005). Protein energy malnutrition is major problem in developing countries (Waterlow, 1997). More than one in seven people suffer with malnutrition due to unavailability of sufficient and quality food (FAO, 2009). Currently more than 3 billion people suffered with micronutrient deficiency (Mason and Garcia, 1993; Welch et al., 1997; Welch and graham, 2004; WHO, 1999; World Bank, 1994). Lack of sufficient mineral and vitamin in the food termed as

hidden hunger because its consequences are not visible (Stein, 2010). There are 49 essential nutrients required by human for metabolic pathway and deficiency of a single nutrient can lead to stunted growth and development (Welch and Graham, 2004). Some minerals are required in greater quantity while some are required in trace amount. Nutrients exist in soluble or non-soluble form but their availability depends upon the presence of promoter or anti-nutrients (White and Broadly, 2005). A major part of population is deficient in micro nutrients. 60-80 % of people were found to be deficient in iron, more than 30 % deficient in zinc, 30 % deficient in iodine and 15 % deficient in selenium (Kennedy et al., 2003; Combs, 2001). Iodine deficiency disorders were reported highest in Mediterranean region (32%) while 20 % in Africa, 15 % in Europe, and 12 % in Asia (Ramakrishnan, 2002). Bouis (2007) reported deficiency of vitamin A, iron and iodine as major contributors towards human malnutrition. More than 60 countries and large proportion of children in Asia, Africa and America suffered with vitamin A deficiency (Ramakrishnan, 2002). Iodine deficiency leading to endemic goiter is a common disease with high prevalence in developing countries. Iron deficiency leads to reduced hemoglobin and anemia due to depletion of iron stores. Losses vary with the age and food intake however children and pregnant women are at greater risk (Ramakrishnan, 2002). Iron deficiency may not lead to anemia all the time but 50-60 % of anemia is due to iron deficiency (Stein, 2005; Stein 2010). Several health hazards are associated with human malnutrition ranging from diarrhea to mental retardation and even death can occur. Mental retardation, abnormal physical activities and fetus mortality are consequences of iron deficiency anemia. Zinc deficiency has a mild impact on the health of infants and children (Stein, 2005; Stein 2010). Iron deficiency leads to mental retardation and goiter in women (De Benoist et al., 2004). Calcium deficiency causes rickets, arthritis and other bone diseases (Thacher et al, 2006; DeLucia et al, 2003). Mineral deficiency leads to several diseases and has a significant negative impact on social and economic growth (Stein, 2007). 0.2- 4.7 % decrease in annual economic growth due to malnutrition was reported by Acraud (2001). 50 % of world population suffered with vitamin deficiency (Naqvi et al, 2009). Vitamin deficiency includes the deficiency of B6, B12, folate and riboflavin. Serious health hazards were reported due to vitamin deficiency. B12 deficiency was also reported in developed countries like the United States (Allen et al, 2001). Folate and riboflavin deficiencies are common in developing countries like Asia and Africa (Ramakrishnan, 2002).

### **Genetically modified crops to overcome malnutrition:**

First genetic modification was practiced by Calgene in tomato to induce vine ripened taste. It was named as Flavr-Savr tomato and approved in 1993 (Schneider and Schneider, 2002). In later 1980's genetic modification in plants was initiated for medicinal purposes but use of technology was controversial in debates (Azadi and Ho, 2010). Genetic modification in maize was done to induce pest resistance and improved grain quality. Bt-corn was engineered to enhance resistance against corn borer, armyworm and earworm. Bt gene was transferred from *Bacillus thuringiensis* which produces a toxin to kill insects. Bt-corn was approved for general cultivation by USDA in 1995 (Schneider and Schneider, 2002). Maize crop is deficient in lysine and tryptophan. Two mutant genes *opaque2* and *floury2* were used to increase lysine content in maize but high lysine genes made the endosperm soft. High lysine kernels were prone to breakage and rot. Thus a modifier gene was transferred to elucidate the negative attributes (Poehlman, 2013). Elite transgenic corn was created in South Africa by the modification in 3 different pathways for the enhancement of B-carotene, ascorbate level and folate level (3 different vitamins) (Naqvi et al, 2009). Phytic acid reduced the bioavailability of several essential micronutrients. High content of phytic acid was reported in cereals and oilseed crops which is harmful for human and animal consumption (Shi et al 2007). *Lpa1* mutant gene engineered in corn reduced phytic acid content improving its nutritional value.

(Shi et al 2007). Rice has marginal quantity of folate, iron, provitamin A and vitamin E while significant quantity is present in leaves (Beyer, 2010). Provitamin A is precursor of vitamin A which is good for vision, eye sight, immunity and bone growth. Deficiency of vitamin A can cause night blindness. In making of golden rice, first time a complete metabolic pathway was engineered. Phytoene synthase was limiting factor in production of carotenoids (Paine et al, 2005) exchanged with lycopene to increase vitamin A production (Poehlman, 2013). 23 folds increase in total carotenoids was observed when psy1 gene was used in combination with crt1 obtained from *Erwinia uredovora* (Paine et al, 2005) this led to the development of Golden rice2. Improvement in provitamin A through conventional breeding is difficult because there is low genetic variability for the trait. Folate deficiency in rice endosperm was treated with the transfer of two pathway genes from model plant *Arabidopsis thaliana* (Beyer, 2010). Iron deficiency in rice endosperm is also a major problem as rice is a staple food for more than 3 billion people in the world. Varietal variation for iron content in rice endosperm varies from 1 to 8 ppm while high variability was reported for zinc content (Beyer, 2010). There is a great potential to increase micro nutrient content (Fe and Zn) in wheat because high genetic variability in mineral content prevails in the seed and other plant parts (White and Broadley, 2005). Banana is highly deficit in minerals and vitamins. Enhancement through conventional breeding is difficult because commercial banana is triploid thus genetic transformation can improve the micronutrient content.

BT banana and BT cassava were produced to lower the cost of insecticide control chemicals. Minipathway” was transformed in potato successfully for the enhancement of vitamin A precursor (Diretto et al, 2007). Bt cotton reduced the input expenses and fewer health issues were observed due to less use of pesticides (Huang et al, 2002). Qaim and Zilberman (2003) reported higher yield gains in Bt cotton due to increased yield, less chemical usage and low labor input charges. GM corn has increased yield while genetically modified soybean required low input and chemicals (Azadi and Ho, 2010). Viswanathan and Lalitha (2010) reported a significant role of B.t cotton in combating food security issues, malnutrition and to overcome poverty in cotton growing states. B-carotene level was improved in carrot and potato, corn with high lysine content, lettuce with enhanced Iron and tomato with improved lycopene have been developed through genetic engineering (Naqvi et al, 2009). Bio fortification of the crops can help to overcome issue of malnutrition. Plant with slower growth has more accumulation of minerals in edible parts but they have reduced yield and small seed size (Whitman and Broadly, 2005).

### **Conclusion**

Food security has become a major issue globally due to increasing population. High and substantial grain yield can overcome the issue. Use of novel molecular technique in agricultural crops can ensure better quantity and quality of food produced. GM crops are widely adopted across the world. GM crops are framed as technological solution to ensure high food productivity under adverse natural condition while on other hand genetically modified crops are thought to have some ethical issues. A comparative study for GM acceptance in UK and Australia reveals that former has some resistance in acceptance by government and consumers while later has accepted it open heartedly (Dibden et al, 2013). There is greater concern about whether use of genetically modified crops has more benefits or risks. Possible risks include poor digestibility, presence of toxins and Allergenicity if GM crops could pass the test for these attributes they can be allowed for general cultivation (Paarlberg, 2010). Keeping in view the risks of using G.M crops scientists suggested the farmer community to adopt organic farming which is not feasible for the farmer community of developing countries due to less output (Azadi and Ho, 2010). Replacement of

conventional breeding with genetically modified technology will lead to unavailability of non GM seed in coming years (Dibden et al, 2013). Modification in genetic makeup of organisms and their use in the food chain may have some risks. GM food should be environment friendly and safe for intake and should allow for cultivation after proper risk assessment (Godfray et al, 2010). In developing countries, national agriculture program, food safety regulation policy and intellectual property rights help in the adoption of GM crops (Raney, 2006). Genetic transformation is way more efficient and less time consuming than conventional breeding.

### References

- Arcand, J. L. (2001). Undernourishment and economic growth: the efficiency cost of hunger (No. 147). Food & Agriculture Org.
- Allen L, Casterline-Sabel J. Prevalence and causes of nutritional anemia. In: Ramakrishnan U, ed. Nutritional anemias. Boca Raton, FL: CRC Press, 2001: 7–21
- Azadi, H., & Ho, P. (2010). Genetically modified and organic crops in developing countries: A review of options for food security. *Biotechnology advances*, 28(1), 160-168.
- Beyer, P. (2010). Golden Rice and ‘Golden’ crops for human nutrition. *New biotechnology*, 27(5), 478-481.
- Booth, S., & Smith, A. (2001). Food security and poverty in Australia-challenges for dietitians. *Australian journal of nutrition and dietetics*, 58(3), 150-156.
- Bouis, H. E. (2007). The potential of genetically modified food crops to improve human nutrition in developing countries. *The Journal of Development Studies*, 43(1), 79-96.
- Combs, G.F. (2001) Selenium in global food systems. *Br. J. Nutr.* 85, 517–547.
- De Benoist B, Andersson M, Egli I, Takkouche B, Allen H (eds) (2004) Iodine status worldwide: WHO global database on iodine deficiency. World Health Organization Geneva.
- DeLucia MC, Mitnick ME, Carpenter TO (2003) Nutritional rickets with normal circulating 25-hydroxyvitamin D: a call for reexamining the role of dietary calcium intake in North American infants. *J Clin Endocrinol Metab* 88:3539-354.
- Dibden, J., Gibbs, D., & Cocklin, C. (2013). Framing GM crops as a food security solution. *Journal of Rural Studies*, 29, 59-70.
- Diretto, G. et al. (2007) metabolic engineering of potato carotenoid content through Tuber-specific overexpression of a bacterial mini-pathway. Food and Agriculture Organization of the United Nations (FAO), State of Food Insecurity in the World 2009 (FAO, Rome, 2009).
- Godfray, H. C. J., Beddington, J. R., Crute, I. R., Haddad, L., Lawrence, D., Muir, J. F., ... & Toulmin, C. (2010). Food security: the challenge of feeding 9 billion people. *Science*, 327(5967), 812-818.
- Gregorio, G.B. et al. (2000) Breeding for trace mineral density in rice. *Food Nutr. Bull.* 21, 382–386.
- Huang, J., Hu, R., Fan, C., Pray, C. E., & Rozelle, S. (2002). Bt cotton benefits, costs, and impacts in China.
- James, C., 2006. Global Status of Commercialized Biotech/GM Crops: 2005. ISAAA Briefs No. 34–2005. ISAAA, New York.
- Kennedy, G. et al. (2003), The scourge of “hidden hunger”: global dimensions of micronutrient deficiencies. *Food Nutr. Agric.* 32, 8–16.
- Kimenju, S. C., & De Groote, H. (2008). Consumer willingness to pay for genetically modified food in Kenya. *Agricultural economics*, 38(1), 35-46.
- Kramer, C. V., & Allen, S. (2015). Malnutrition in developing countries. *Paediatrics and child health*, 25(9), 422-427.

- Lyons, G.H. et al. (2005) Selenium distribution in wheat grain, and the effect of postharvest processing on wheat selenium content. *Biol. Trace Elem. Res.* 103, 155–168.
- Mason JB and Garcia M. (1993), Micronutrient deficiency—the global situation. *SCN News* 9,11–16.
- Müller, O., & Krawinkel, M. (2005). Malnutrition and health in developing countries. *Canadian Medical Association Journal*, 173(3), 279-286.
- Naqvi, S., Zhu, C., Farre, G., Ramessar, K., Bassie, L., Breitenbach, J & Christou, P. (2009). Transgenic multivitamin corn through biofortification of endosperm with three vitamins representing three distinct metabolic pathways. *Proceedings of the National Academy of Sciences*, 106(19), 7762-7767.
- Paarlberg, R. (2010). GMO foods and crops: Africa's choice. *New biotechnology*, 27(5), 609-613.
- Paine, J.A. et al. (2005) Improving the nutritional value of Golden Rice through increased pro-vitamin A content. *Nat. Biotechnol.* 23, 482–487
- Poehlman, J. M. (2013). *Breeding field crops*. Springer Science & Business Media.
- Qaim, M., & Zilberman, D. (2003). Yield effects of genetically modified crops in developing countries. *Science*, 299(5608), 900-902.
- Ramakrishnan, U. (2002). Prevalence of micronutrient malnutrition worldwide. *Nutrition reviews*, 60(suppl\_5), S46-S52.
- Raney, T. (2006). Economic impact of transgenic crops in developing countries. *Current Opinion in Biotechnology*, 17(2), 174-178.
- Schmidhuber, J., & Tubiello, F. N. (2007). Global food security under climate change. *Proceedings of the National Academy of Sciences*, 104(50), 19703-19708.
- Schneider, K. R., & Schneider, R. G. (2009). Genetically modified food. Retrieved September, 26, 2010
- Shi, J., Wang, H., Schellin, K., Li, B., Faller, M., Stoop, J. M & Glassman, K. (2007). Embryo-specific silencing of a transporter reduces phytic acid content of maize and soybean seeds. *Nature biotechnology*, 25(8), 930.
- Stein AJ, Meenakshi JV, Qaim M, Nestel P, Sachdev HPS, Bhutta ZA (2005) Analyzing the health benefits of bio fortified staple crops by means of the disability adjusted life years approach: A handbook focusing on iron, zinc and vitamin A. Harvest Plus Technical Monograph 4, International Food Policy Research Institute, Washington DC.
- Stein AJ, Nestel P, Meenakshi JV, Qaim M, Sachdev HPS, Bhutta ZA (2007) Plant breeding to control zinc deficiency in India: how cost-effective is biofortification? *Public Health Nutr* 10:492-501
- Stein, A. J. (2010). Global impacts of human mineral malnutrition. *Plant and soil*, 335(1-2), 133-154.
- Thacher TD, Fischer PR, Strand MA, Pettifor JM (2006) Nutritional rickets around the world: causes and future directions. *Ann Trop Paediatr Int Child Health* 26:1-16.
- Viswanathan, P. K., & Lalitha, N. (2010). GM technology and sustainable agriculture future: Empirical evidences from Bt cotton farmers in Maharashtra and Gujarat in India. *Journal of Development and Agricultural Economics*, 2(1), 007-017.
- Waterlow, J. C. (1997). Protein-energy malnutrition: the nature and extent of the problem. *Clinical Nutrition*, 16, 3-9.
- Welch RM, Combs Jr GF, Duxbury JM. 1997. Toward a ‘Greener’ revolution. *Issues in Science and Technology* 14, 50–58.
- Welch, R. M., & Graham, R. D. (2004). Breeding for micronutrients in staple food crops from a human nutrition perspective. *Journal of experimental botany*, 55(396), 353-364.
- Welch, R. M. (2001). Impact of mineral nutrients in plants on human nutrition on a worldwide scale. In *Plant Nutrition* (pp. 284-285). Springer Netherlands.

- White, P. J., & Broadley, M. R. (2005). Bio fortifying crops with essential mineral elements. *Trends in plant science*, 10(12), 586-593.
- Whitman, D. B. (2000). Genetically modified foods: harmful or helpful. *CSA Discovery guides* 1-13.
- WHO. 1999. *Malnutrition worldwide*. Geneva, Switzerland: World Health Organization. [http://www.who.int/nut/malnutrition\\_worldwide.htm](http://www.who.int/nut/malnutrition_worldwide.htm).1–13.

## **REDUCTION IN ENERGY DEMAND FOR GRAIN DRYING THROUGH HEAT RECOVERY FROM HUMID AIR EXTRACTED FROM CROSSFLOW DRYERS**

Edward PRZYDRÓŻNY<sup>1</sup>, Aleksandra PRZYDRÓŻNA<sup>2\*</sup>

<sup>1</sup>Wrocław University of Science and Technology, Department of Air Conditioning, Heating, Gas Engineering and Air Protection, 4/6 Norwida st., Building C-6, 50-373 Wrocław, Poland

<sup>2</sup>Max Fordham, St Andrew's House, 59 St Andrew's St, CB2 3BZ, Cambridge, United Kingdom (UK)

\*Corresponding author: aleksandrprzydrozna@gmail.com

### **Abstract**

This paper outlines the method of reducing energy demand for drying grain through the use of heat recovery from humid air extracted from a crossflow dryer. The use of heat exchanger to recover heat from the extract air and to transfer the recovered heat to the cold, dry, external air results in a significant reduction of the primary energy demand for heating of the cold external air. At low external air temperatures, it is possible to recover, from the extract air, both the sensible heat and the latent heat from condensation of water vapour. The design solution with direct heat recovery from the extract air to the supply air has been presented. For selected design setpoints of a drying room and design solutions with heat recovery in summer and autumn, both the achievable reduction of the primary energy demand for thermal air treatment and the resultant increase in the energy demand for air transport, due to the use of heat recovery exchanger, have been estimated. The energy balance of a crossflow dryer has indicated that the use of systems with heat recovery results in the significant reduction of the energy demand for drying grain in range 25-35%.

**Keywords:** *Drying grain, Heat recovery, Energy demand.*

### **Introduction**

Grains, collected during harvest season, are stored in silos when their moisture content is at a required level that ensures safe storage. Also, in the silos, the air temperature is maintained to ensure proper storage conditions. Moisture content of cereal crops, especially maize, when harvested, is rarely adequate for storage and has to be decreased to the optimum level through drying processes (Bakker-Arkema et al. 1996). A standard approach involves drying cereal grains by heated airflow passing through and assimilating the moisture. For decades high-capacity continuous-flow crossflow dryers (see Ferrum 2017 for examples of cross-flow dryers used currently) have been most widely used in industrial-scale applications worldwide (Bakker-Arkema 1984, Kreyger 1972). A substantial body of research has been conducted since to improve the end quality of grain (Gustafson et al. 1981), to understand thermodynamic processes within the dryer (Brooker et al. 1992), to develop models enabling simulation of processes within the dryer (Khatchatourian et al. 2013) and, finally, to reduce primary energy consumption through air recirculation or basic heat recovery (Bakker-Arkema et al. 1996, Pierce et al. 1981, Lai et al. 1977). Treatment of the drying air has been identified as a particularly energy-intensive operation. Different technologies to prepare the drying air have been thus investigated with particular emphasis on the method of heating. For instance, energy efficient options include heating the drying air by using natural energy resources, i.e. solar energy (Johansson et al. 2012) or systems with a closed circulation of the drying air and heat pumps, used for energy flow and preparation of the drying air, gain popularity (Chua et al. 2002). During harvesting the open-cycle dryers, that use external air heated before passing

through cereal grains, are most commonly used. In these dryers, the humid airflow, after assimilating the moisture from cereal grains, is removed to the outside. The external airflow for drying may be heated either externally (central system used by different end-users) or individually (heat supply dedicated to the dryer). Depending on the technology and availability, solid, liquid and gaseous fuels may be used (Acasio et al., 1992). Currently, heating the air supplied to the drying room usually involves the gas burning directly within the drying air (Maier & Bakker-Arkema, 2002). This technology ensures high efficiency of heat recovery from the combustion gas, due to negligible energy losses for heat transfer from the flared gas to the heated air. The temperature of the heated drying air directly affects the drying efficiency. The maximum temperature allowed depends on the type of cereal grain and its end-use. The drying air temperature in crossflow dryers typically range from 80 - 110°C (Maier & Bakker-Arkema, 2002). The drying airflow passes through the cereal grain, the air temperature decreases to 45 - 60°C and the air humidity increases to 30 - 35 g/kg<sub>ps</sub>, to be subsequently removed and all the energy once used for treatment wasted. In Poland, a harvest season for basic grains is in July and August, whereas for maize in the second half of October, November and often even in the first half of December. Corn grains harvested in the autumn usually have the highest moisture content. Simultaneously, the external air temperatures are the lowest. Drying corn grains under these conditions requires the largest energy demand to dry the unit weight of grain. In addition, drying corn grains under such conditions, with a moisture content exceeding 40%, often requires two-stage treatment. The humid air removed from the dryer has a high thermal potential, a high specific enthalpy, relative to the external air parameters. As a result, an attempt to recover energy from the extracted air and using the recovered heat to reduce energy demand for heating the drying airflow seems to be rational and economically justified. The above applies especially to the autumn period when the external air temperature is the lowest and the moisture content of grain is the highest. Under these conditions, the energy of moisture condensation of the extract air may be used to heat the external air. This is particularly energy effective because the heat of condensation is several times higher than the specific heat capacity of air. In other words, the decrease in the extract air temperature, from which moisture is released, is minimal compared to the increase in the heated external air temperature. There are two reasonable technical solutions for the heat recovery from the extract air and its subsequent use for heating the drying air. Two main distinctions between the solutions correspond to the method of heat transfer from the extract airflow to the external airflow and the relative distribution of both airflows. The first solution is based on the use of plate heat exchanger, in which the extract air while flowing on one side of the heat exchanger transfers heat through the baffles to the external air flowing on the other side. The extract airflow and the external airflow pass through the same heat exchanger, thus these are required to be distributed into the same area. The second solution is based on the use of two air-liquid heat exchangers connected by pipework with circulating water (aqueous glycol). In the heat exchanger installed in the extract air, the heat is accumulated and transferred to the circulating water from which heat is subsequently released to the external air through the heat exchanger installed therein. In this way, the external and extract airflows may be separated. In both solutions the heat exchanger surfaces on the extract air side are exposed to the deposition of impurities. In order to reduce the negative effects of pollutants sedimentation on the efficiency of the drying processes, including reducing the flow of drying air and reducing the efficiency of heat recovery from the extract air, the extract air should be cleaned before passing through the heat exchanger or alternatively the heat exchanger surfaces need to be periodically cleaned. Treating the extract air can be cumbersome in operation especially in the case of airflow polluted with moist corn residue. Removing impurities from the surface of heat exchangers is relatively easy for plate exchangers, but particularly challenging for air-liquid exchangers with a developed heat exchange surface on



the air side. This paper focuses on the design solution with the plate heat exchanger and demonstrates the possibilities of reducing the energy demand for grain drying by recovering heat from the extract air.

### Material and Methods

Fig. 2.1 a) shows a schematic of a proposed heat recovery system utilising waste heat from the humid air, extracted from a crossflow dryer, to preheat the drying air (external airflow) in the diaphragm plate exchanger. In order to ensure a rational efficiency of heat recovery, heat exchanger consisting of two sections is used, through which the counter-flow cross airflows exchanging heat are designed to pass. Under the assumption that mass flows of the extract air and the external air are equivalent, the efficiency of heat recovery can be estimated from the expression:

$$\eta_t = \frac{t_{z'} - t_z}{t_u - t_z} \quad (2.1)$$

where  $t_z$  denotes the external air temperature at the inlet of the exchanger, °C;  $t_z'$  is the external air temperature after passing through the heat exchanger, °C;  $t_u$  denotes the extract air temperature from the dryer at the inlet of the exchanger, °C.

Fig. 2.1. b) shows Mollier i-x chart with exemplary simulations of air treatment processes during the cereal grain drying with heat recovery from the extract air in summer (oc) and autumn (oj), respectively. This chart shows, for the assumed efficiency of heat recovery  $\eta_t = 0.6$ , average parameters of: external air in summer and autumn ( $Z_{oc}$ ,  $Z_{oj}$ ), external air preheated in heat recovery exchanger ( $Z'_{oc}$ ,  $Z'_{oj}$ ), drying air supplied to the dryer ( $Z''_{oc}$ ,  $Z''_{oj}$ ), extract air from the dryer at the inlet of heat recovery exchanger ( $W_{oc}$ ,  $W_{oj}$ ) and the exhaust air ( $W_{oc}'$ ,  $W_{oj}'$ ).

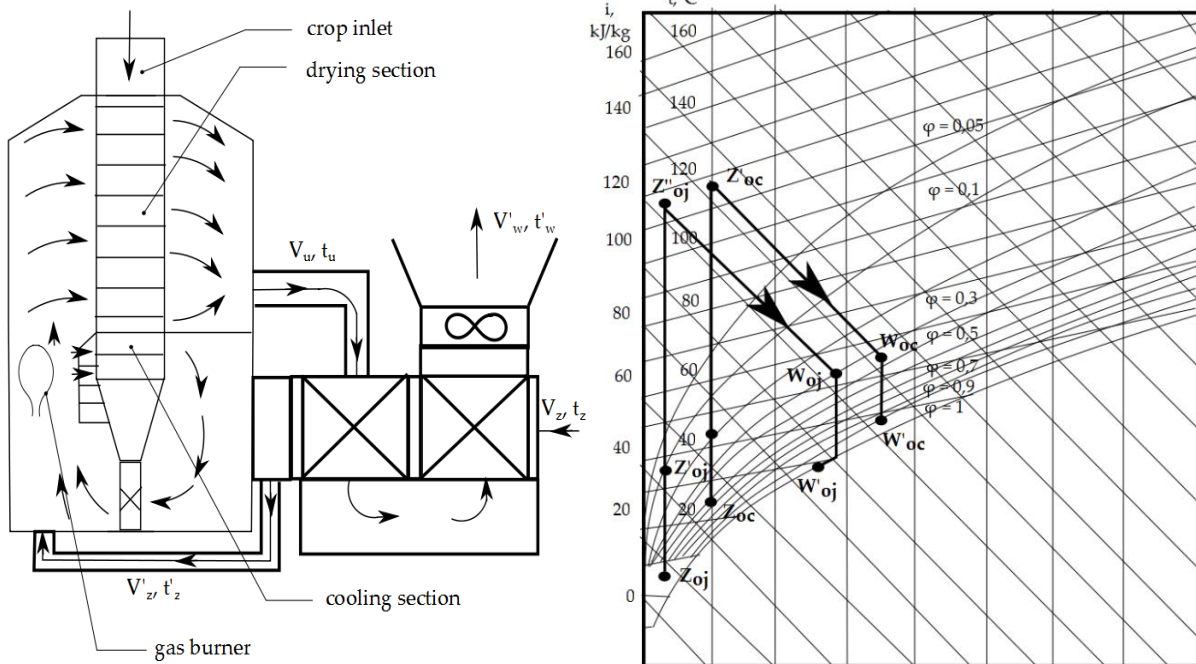


Fig. 2.1. a) Schematic of crop dryer with heat recovery; b) i-x chart with air treatment processes during the grain drying in system with heat recovery ( $\eta_t = 0.6$ ) (preheating, heating, assimilation of moisture during drying and extract air cooling).

The energy effects of including preheat of the drying air have to be considered in the context of air treatment and transport. The ratio of renewable energy (recovered in the heat exchanger) and the total energy demand for heating the drying airflow can be determined from the expression:

$$U_o^c = \frac{(t'_z - t_z)}{(t''_z - t_z)} \cdot 100\%, \quad (2.2)$$

where  $U_o^c$  denotes the portion of renewable energy recovered in the plate heat exchanger in the total energy supplied to heat the drying air, %;  $t_z$ ,  $t'_z$ ,  $t''_z$  denote air temperatures in points Z, Z' and Z'' in i-x chart, °C.

The use of heat recovery exchanger, however, increases the energy demand for transport of drying air. The increase in the fan power, associated with additional airflow resistances through the heat exchanger, can be calculated from:

$$\Delta N = \frac{10^{-3} V \Delta P_w}{\eta_w \eta_s \eta_p} \quad (2.3)$$

where  $\Delta N$  denotes the increment of fan power, kW;  $V$  is the external and extract airflow, m<sup>3</sup>/s;  $\Delta P_w$  denotes the sum of the airflow resistance of the external and extract air passing through the heat recovery exchange, Pa;  $\eta_w$ ,  $\eta_s$ ,  $\eta_p$  are performance of fans, motors and gears, respectively.

## Results and discussion

Preheating the drying air in the heat recovery exchanger results in the significant reduction in the primary energy demand supplied externally. The data extracted from air treatment simulations in Fig. 2.1. b) indicate that in the summer, the use of system with heat recovery reduces the primary energy consumption for heating the drying air by approx. 21% while in the autumn by approx. 28.5%. Discrepancies in the efficiency of heat recovery between the two seasons are caused by differences in the external air temperatures. The efficiency of heat recovery increases with decreasing external air temperatures. At lower temperatures (autumn design conditions in the figure) the surface temperature of heat recovery exchanger is lower than the dew point temperature of extract air. As a result, heat for condensation of water vapour from the extract air is utilised, thus improving the energy effects of heat recovery. In general, increasing thermal efficiency of heat recovery reduces the primary energy demand for heating the drying air as shown for summer (dashed line) and autumn (continuous line) periods in Fig. 2.2 a). The curves have been developed based on the airflow parameters used to prepare simulations in i-x chart in Fig. 2.1. b). Depending on the efficiency of heat recovery  $\eta_h$ , the use of recovered heat to preheat the drying air reduces the primary energy demand for heating the drying air by 15%-25% in summer and 25%-35% in autumn, respectively. However, adding the heat recovery exchanger to the system leads to the increase in the airflow resistance of the dryer, thus also the increase in the fan power requirement. The increase in the efficiency of heat recovery, which grants better energy effects, simultaneously triggers the increase in the energy demand for air transport. Fig. 2.2 b) shows the approximate relationship (increasing trend) between the airflow resistance and the thermal efficiency of heat recovery. In order for the new design solution to work and to guarantee energy savings, the reduction in primary energy demand for air treatment, induced by heat recovery, has to outweigh the energy gains due to higher energy costs of air transport. Fig. 2.3 presents comparisons of the energy balance in the dryer as a function of thermal efficiency of heat recovery. Bar charts in Fig. 2.3. show: the total energy demand ( $E$ , kW) for heating 1m<sup>3</sup>/s (1.2 kg/s) of drying air, and the corresponding breakdown into the primary energy demand, supplied by gas burner, heat recovered in heat exchanger and additional fan power, for summer and autumn conditions. The breakdown of total energy demand for air treatment and transport reveals that under actual design conditions it is always energy-beneficial to recover heat from the extract air expelled from the dryer. The use of recovered heat increases (up to 35%) with the increase in the thermal efficiency of heat recovery. The additional energy demand due to the increase in the fan power requirement for air transport is significantly lower (up to 20 times lower) than the recovered heat output. For example, for a crossflow

dryer with a drying capacity of 10 Mg/h, it is possible to reduce the energy demand supplied to the dryer by 600-900 kW with corresponding increase in the fan power by 26-66 kW, respectively. As an aside, note that, the increase in the efficiency of heat recovery  $\eta_t$  ought not to impede exploitation and everyday use of the dryer. To ensure longevity of the system and the delivery of anticipated energy effects, a proper maintenance of the heat recovery exchanger is required, by either purifying the extract air prior to passing through or cleaning the exchanger surface on the extract side regularly.

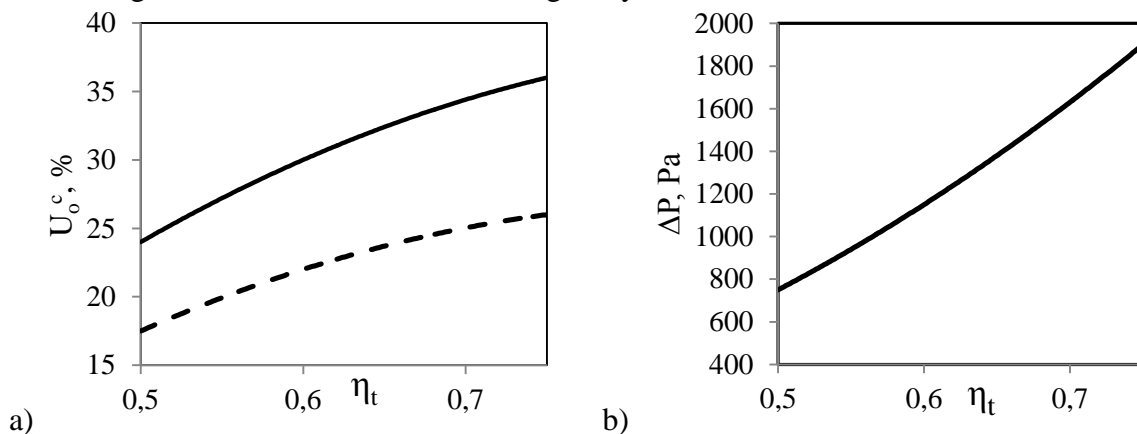


Fig. 2.2. a) Energy savings  $U_o^c$ , in %, caused by heat recovery in the plate exchanger as a function of thermal efficiency of heat exchanger for summer (dashed line) and autumn (continuous line); b) Airflow resistance as a function of thermal efficiency of heat exchanger.

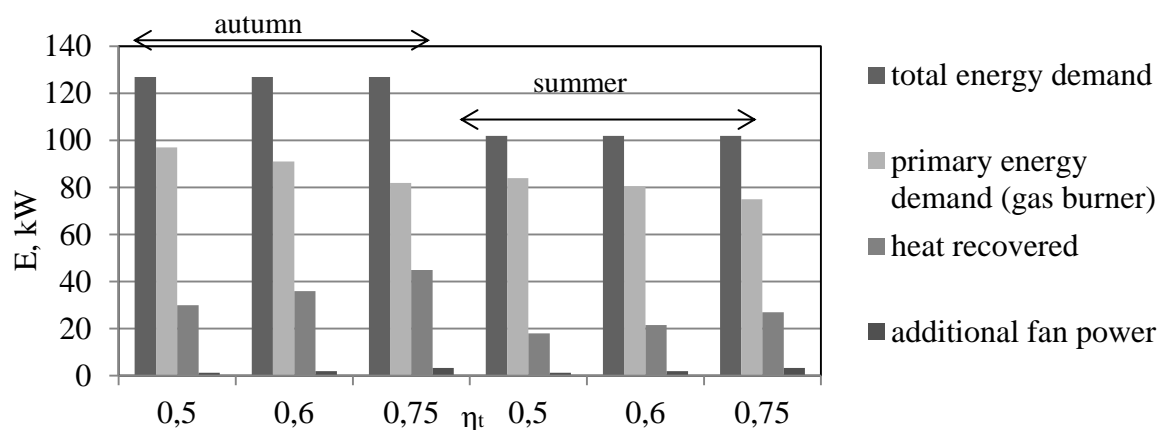


Fig. 2.3. Energy demand for air treatment and transport of  $1\text{m}^3/\text{s}$  of drying air in a crossflow dryer using a plate heat exchanger to recover heat from the extract air.

### Conclusions

Nowadays there is a worldwide trend towards reducing primary energy consumption. Somewhat surprisingly technologies used in agriculture still remain one step behind and modernisation of design solutions is required to ensure sustainable agriculture. This paper is aimed at revising grain drying in crossflow dryers and proposing a new energy-efficient design solution. Our new design solution involves using heat recovered from the air extracted from the crossflow dryer to preheat the drying air. By adding a heat recovery exchanger to the system, the primary energy consumption is reduced through the utilisation of energy recovered. The use of heat recovery to preheat the drying air leads to:

The decrease in the size of heating devices by 15 to 35%, corresponding to the limitation of the energy demand supplied to the dryer.

The increase in the resistance of the drying airflow through the dryer, thus also the increase in the fan power.

The need to either purify (filter) the extract air before passing through the heat recovery exchanger or alternatively clean the exchanger surface on the extract air side regularly.

The analysis of system performance revealed that:

Under actual conditions of operation, heat recovery from the air expelled from the dryer is always energetically beneficial.

The increase in efficiency of heat recovery leads to a greater use of recovered heat to preheat the drying air.

The increase in electrical power demand of fan drives, as a response to the increase in the efficiency of heat recovery exchanger, is significantly lower than the heat output.

The effect of contributions of this conceptual research into reducing energy demand for crop drying begins to flourish in Poland, where first systems with heat recovery from the extract air from the dryers have been created as a result of cooperation between Feerum and Wrocław University of Science and Technology.

### **References**

- Acasio, U. A., Maxon, R. C. & Khan, S. H. (1992) Handling, Management and Marketing of Cereal Grains. Food and Feed Grains Institute Manhattan, Kansas 66506-2202, USA.
- Bakker-Arkema, F. W. (1984) Selected Aspects of Crop Processing and Storage: A Review. *J. agric. Engng Res.*, 30, 1- 22.
- Bakker-Arkema, F. W., Montross, M. D., Liu, Q. & Maier, D. E. (1996) Analysis of continuous-flow grain dryers. In *ACIAR Proceedings*, 123-131.
- Brooker, D. B. & Bakker-Arkema, F. W. (1974) *Drying Cereal Grains*. Westport: AVI Publishing Co.
- Chua, K. J., Chou, J. C. Ho & Hawlader, M. N. A. (2002) Heat Pump Drying: Recent Developments and Future Trends, *Drying Technology*, 20(8), 1579-1610
- Feerum (2017) Cross-flow Dryer, In *Catalogue of Continuous-flow Grain Dryers* Website: <http://www.feerum.pl/katalogi/suszarnia-o-pracy-ciaglej.pdf>.
- Gustafson, R. J. & Morey, R. V. (1981) Moisture and quality variations across the column of a crossflow grain dryer, *Transactions of the ASAE*, 24 (6), 1621-1625.
- Johansson, T. B., Patwardhan, A. P., Nakićenović, N., & Gomez-Echeverri, L. (Eds.). (2012). *Global energy assessment: toward a sustainable future*. Cambridge University Press.
- Khatchatourian, O. A., Vielmo, H. A., & Bortolaia, L. A. (2013). Modelling and simulation of cross flow grain dryers. *Biosystems engineering*, 116(4), 335-345.
- Kreyger, J. (1972). *Drying and Storing Grains, Seeds and Pulses in Temperate Climates*. Wageningen, The Netherlands: Institute for Storage and Processing of Agricultural Produce.
- Lai, F. S. & Foster, G. H. (1977) Improvement in Grain-Dryer Fuel Efficiency through Heat Recovery, *Transactions of the ASAE*, 20(3),0579-0584.
- Maier, D. E., & Bakker-Arkema, F. W. (2002). Grain drying systems. In *Proceedings of the 2002 Facility Design Conference of the Grain Elevator & Processing Society*, St. Charles, Illinois, USA.
- Pierce, R. O. & Thompson, T. L. (1981) Energy Use and Performance Related to Crossflow Dryer Design, *Transactions of the ASAE*, 24(1),0216-0220.

## PRESENCE OF THE GRAPEVINE LEAFHOPPER *SCAPHOIDEUS TITANUS* IN VINEYARDS IN NORTH-EASTERN ROMANIA

Constantina CHIRECEANU<sup>1\*</sup>, Andrei TEODORU<sup>1</sup>, Ghica MIHU<sup>2</sup>, Marioara BOSOI<sup>2</sup>, Ileana STOIAN<sup>2</sup>

<sup>1</sup>Research - Development Plant Protection Institute Bucharest, Romania

<sup>2</sup>Research - Development Station for Viticulture and Winemaking Odobești, Vrancea, Romania

\*Corresponding author: cchireceanu@yahoo.com

### Abstract

The North American grapevine leafhopper *Scaphoideus titanus* Ball 1932 (Hemiptera: Cicadellidae) is a major pest of grapevine in Europe, being the main vector of the phytoplasma pathogens associated with the *Flavescence dorée* disease. In 2016, a field survey was conducted to evaluate the presence of *S. titanus* in vineyards in the viticulture region Dealurile Moldovei (North-Eastern Romania). The research comprised sixteen vineyard plantations, newly created within the national program of reconversion and restructuring of vineyards developed in the country since 2011. All plantations were subjected to pesticide treatments. No insecticide treatment was applied against *S. titanus*. Yellow sticky traps were used for sampling of leafhoppers. The captures on the yellow sticky traps indicated that *S. titanus* was present in all investigated vineyard plantations. Its population was different in size from one plantation to another. On average, 8 to 88 specimens of *S. titanus* (mixed population of adults and larvae) per trap were collected over the period from June to October.

**Key words:** *vector control, population dynamic.*

### Introduction

The North American grapevine leafhopper, *Scaphoideus titanus* Ball 1932 (Hemiptera: Cicadellidae) is a major pest of grapevine in Europe, because it produces damages directly by sucking for feeding and indirectly by transmitting the phytoplasmas associated with *Flavescence dorée* (FD) disease (Mori *et al.*, 2002; Galetto *et al.*, 2016). FD disease is the most dangerous among the yellowing diseases of European grapevines (Bertaccini and Duduk, 2009). The insect is a monophagous species on plants of *Vitis* genus and develops one generation per year from May to September (Chuche and Thiéry, 2014). Phytoplasmas are bacteria-like organisms that infect the phloem tissues of plants and are transmitted from one plant to another by sap-sucking insect vectors such as leafhoppers and planthoppers (Ploaie, 1981; Weintraub and Beanland, 2006). The distribution of *S. titanus* in Europe, presented in the EPPO Global Database in 2017, showed that this insect is present in Austria, Bosnia-Herzegovina, Bulgaria, Croatia, Czech Republic, France, Hungary, Italy, Moldova, Montenegro, Portugal, Romania, Serbia, Slovakia, Slovenia, Spain and Switzerland. The presence of *S. titanus* in Romania was first recorded in the south part of the country in 2009 (Chireceanu *et al.*, 2011). Spreading of *S. titanus* from one area to another can be done through multiple ways, either by its movement or by various transport vectors. The human activities are considered one of the main long-distance dispersal way of the insect (Bertin *et al.*, 2007; Chuche and Thiéry, 2014; Riolo *et al.*, 2014). Commercial activity with grapevine planting material which contains overwintering eggs of the pest plays a significant role in its spreading between distant geographical zones (Boudon-Padeau *et al.*, 2005; Maixner, 2005). The aim of the paper was to evaluate the presence of the grapevine leafhopper *Scaphoideus*

*titanus* in young vineyard plantations from the viticulture region Dealurile Moldovei (North-Eastern Romania), recently created within the framework of the program of reconversion and restructuring in Romanian viticulture.

### Materials and methods

In 2016, the presence of *S. titanus* was evaluated in sixteen vineyard plantations, set up within the national program of reconversion and restructuring of vineyards, distributed in five vineyards in the viticulture region Dealurile Moldovei, situated in the North-Eastern part of Romania. The plantations were of 2-8 years old and belonged to some owners in the region. The surveyed plantations included national and international grape cultivars. The planting material was from local sources (Tămâioasa românească cl 36 Pt. variety) and EU (the other varieties). All plantations were subjected to different chemical sprays: fungicides to prevent or reduce the infections by specific pathogens, and acaricides against mites (*Tetranychus sp.*) and insecticides against grape moth (*Lobesia botrana* Den et Schiff). No control measures were applied against *S. titanus*. Yellow sticky traps, produced in Romania, were used for sampling of leafhoppers and also for monitoring of *S. titanus* population (adults and larvae). For each vineyard plantation, five traps were set up and replaced every two weeks from June to October. The information for vineyard plantation is given in table 1.

Table 1. Information on vineyard plantations surveyed in 2016 for presence of *S. titanus*

County	Vineyard	Viticulture Centre	Acronym	Year of planting	Area (Ha)	Variety	Rootstocks			
Vrancea	Odobești	Odobești	HAG1	2014	1.19	Muscat Ottonel	Kobber t16			
			HAG2	2014	2.15	Sauvignon blanc	Kobber t10 Kobber t905			
			SC VN F2	2008	3.72	Fetească neagră	Kobber 5 BB			
			SC VN F3	2010	3.19	Pinot noir	Kobber 5 BB			
	Panciu	Țifești, Sârbi	PUS	2012	1.53	Sauvignon blanc	SO-4			
						Muscat Ottonel	SO-4			
						Fetească neagră	775 P CFC 83-20			
		Panciu	ICB	2012	2.95	Sauvignon blanc	SO-4			
	Panciu	SC VN F1	2010	3.89	Muscat Ottonel	SO-4				
	Cotești	Vârteșcoiu	COZ1	2011	1.14	Cabernet Sauvignon	SO-4, P1103			
						COZ2	2010	1.59	Muscat Ottonel	TK –WB CKT 16
						SC VN F4	2011	1.92	Chardonnay	Kobber 5BB
						Cârligele	SC VN F7	2010	3.00	Fetească neagră
Dumbrăveni						SC MR GÂR	2008	1.88	Muscat Ottonel	SO-4
Buzău	Cotești	Grebănu	SC VN F10	2010	5.00	Pinot gris Cabernet sauvignon	SO-4			
Vaslui	Huși	Huși	SC VN F12	2009	1.50	Tămâioasă românească cl 36Pt.	SO-4			
			SC VN F13	2009	0.87	Tămâioasă românească cl 36Pt.	SO-4			
			SCH	2008	3.65	Tămâioasă românească cl 36Pt.	Kobber 5 BB; SO-4			
			Traminer roz cl 47	SO-4						

### Results and discussion

The presence of the grapevine leafhopper, *S. titanus* known to be vector of FD phytoplasma (Mori *et al.*, 2002; Galetto *et al.*, 2016), was recorded in all the sixteen vineyard plantations generated through the national conversion program in viticulture, which were surveyed in the

viticulture region Dealurile Moldovei (the North-Eastern part of Romania) in 2016. The distribution of vineyard plantations and *S. titanus* presence are illustrated in Figure 1.

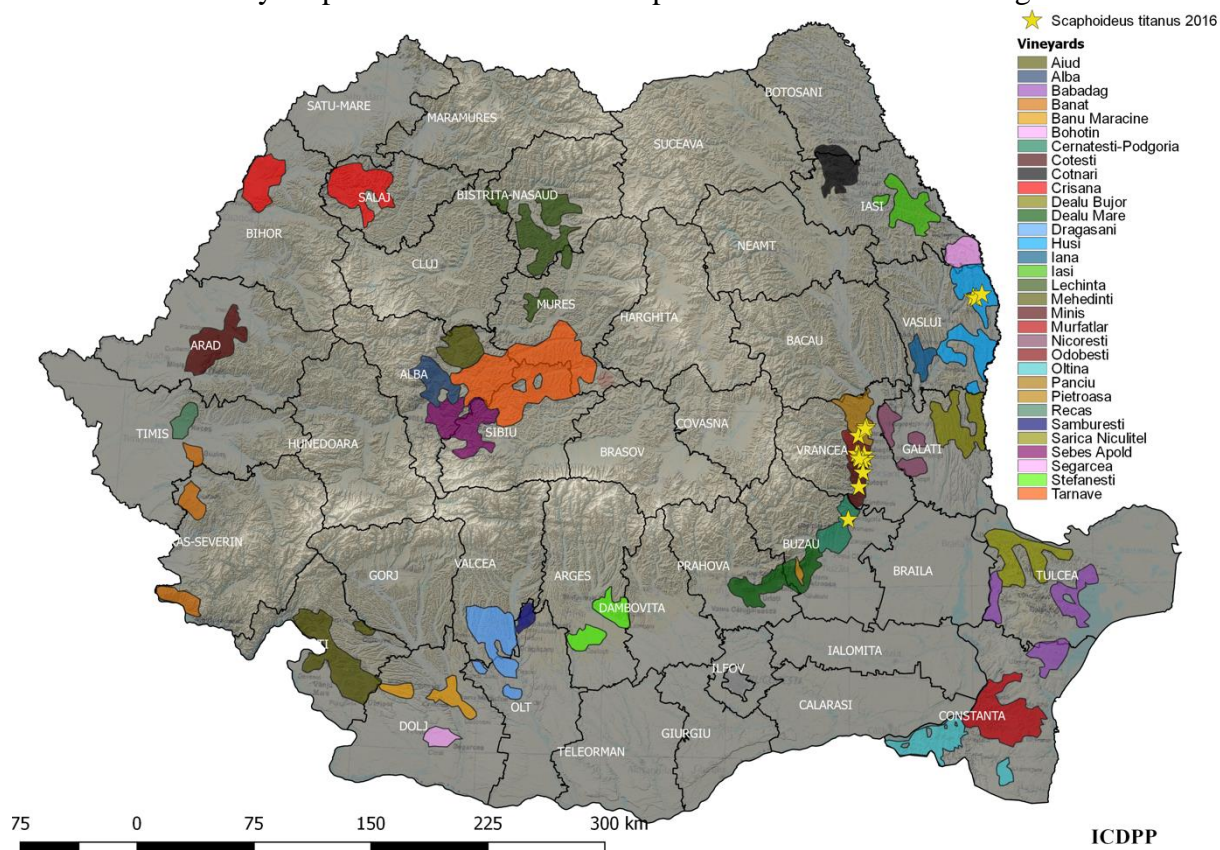


Figure 1. Map of distribution points for *S. titanus* in young vineyard plantations surveyed in 2016 in the viticulture region Dealurile Moldovei (Map performed by V. Fătu).

The whole abundance of *S. titanus* (larvae and adults) in surveyed grapevine plantations is shown in figure 2.

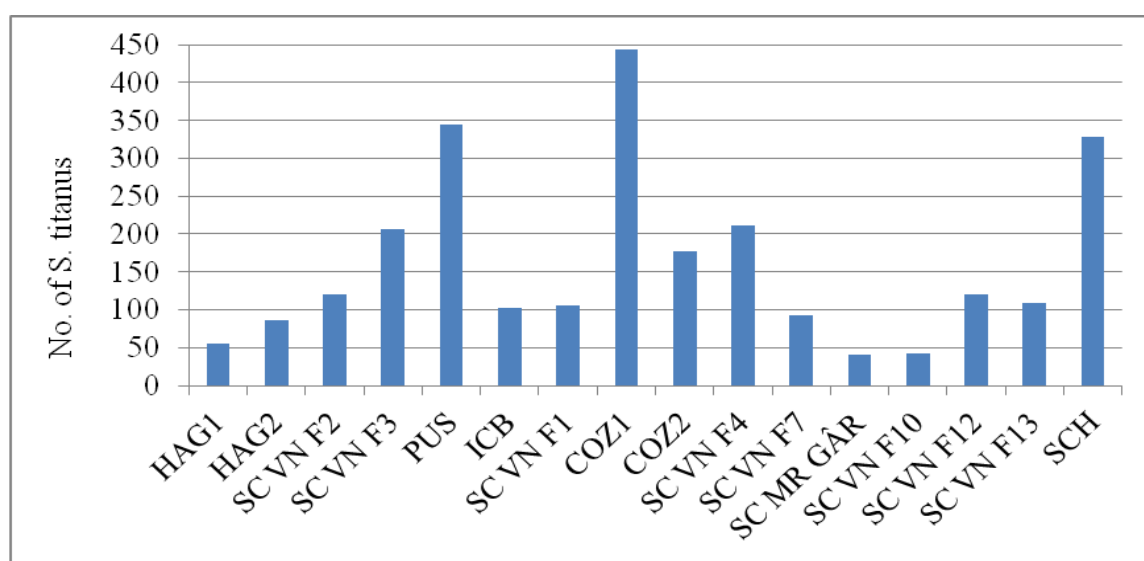


Figure 2. The total number of *S. titanus* collected on yellow sticky traps in the young vineyard plantations in the viticulture region Dealurile Moldovei monitored in 2016.

The population of the pest was variable from one plantation to another. Differences were noted both among grapevine plantations belonging to different vineyards and between plantations in the same vineyard. On the entire survey period, the abundance of the pest fluctuated between 41 and 444 captures per grapevine plantation, with an average density ranged from 8.2 to 88.8 captures per one yellow sticky trap. The lowest levels of abundance were estimated in three grapevine plantations, two situated in Dumbrăveni and Grebănu (Cotești vineyard) and one in Odobești (Odobești vineyard), with 41 and 43 specimens, and 55 specimens per plantation, respectively. The highest presence of *S. titanus* was noted in the grapevine plantation in Vârteșcoiu, (Odobești vineyard) with 444 specimens, followed by two plantations in Țifești Sârbi (Panciu vineyard) and in Huși (Huși vineyard) with 347 and 338 specimens, respectively.

The differences in abundance of the *S. titanus* population could be the result of the characteristics of the vine plantations, such as their age, varieties and origin of planting material, but also of the influence of insecticides against the grapevine moth applied differentially from one plantation to another. *L. botrana* is the most important insect pest in vineyards in Romania, and its control is achieved by an insecticide treatment scheme with one application for each of its three generations. Because currently no insecticide treatments are applied against *S. titanus* in vineyards in Romania, the treatments for *L. botrana* could be interpreted as having influence on *S. titanus*.

Chuche and Thiéry (2014) established a threshold of three adults of *S. titanus* per yellow sticky trap per week for the pest control in vineyards in Bordeaux region. Our capturing data in vineyards from Moldavian hills showed a density of *S. titanus* ranged from 0.51 to 5.55 specimens per trap per week. Only in three out of the sixteen surveyed vineyard plantations, the pest registered a level that exceeded the threshold indicated in France, namely 5.55, 4.34 and 4.23 individuals per trap per day. Thus, the need for insecticide treatments against *S. titanus* in these plantations can be taken into consideration in the following year.

Dynamics of captures of *S. titanus* in the vineyard plantations monitored in 2016 is shown in figure 3.



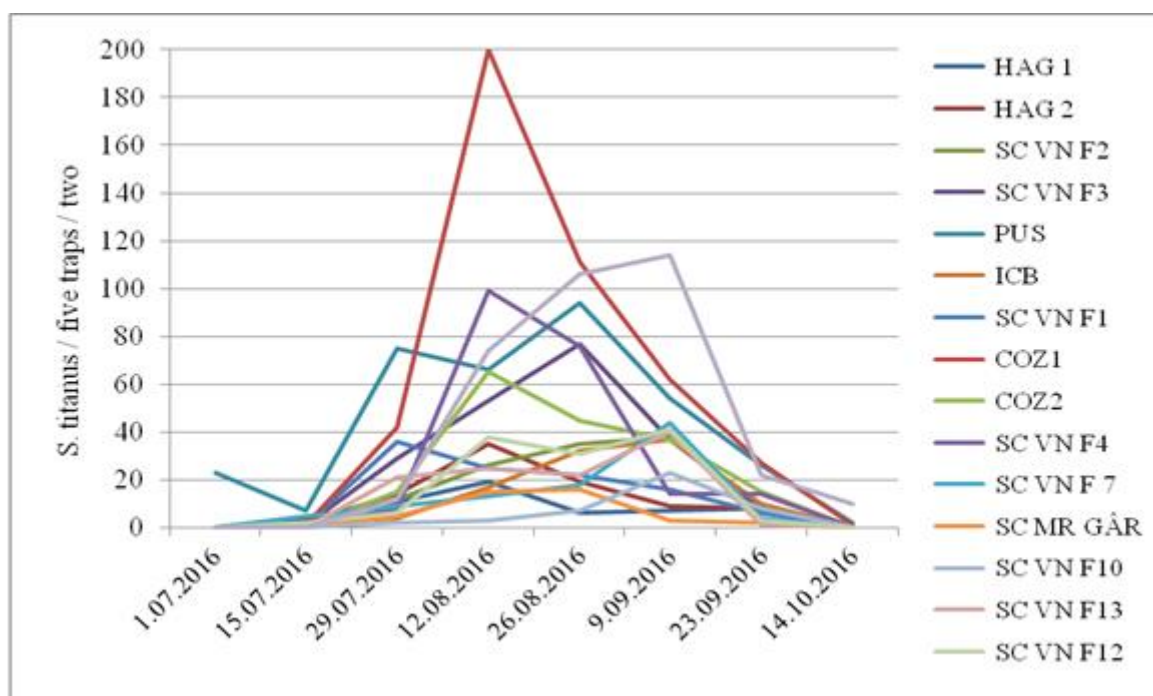


Figure 3. Dynamics of *S. titanus* captures in young vineyard plantations in the viticulture region Dealurile Moldovei in 2016.

According to our results, *S. titanus* was present on yellow sticky traps in vineyard plantations from the middle of June until the middle of October. The date of starting captures varied among the sixteen plantations. The captures of *S. titanus* on yellow sticky traps started to appear during the second part of June in one plantation, the beginning of July in nine plantations and the end of July in the other six. The captures of adults were finished at the end of September for most plantations, except three plantations where the last adults were trapped till the middle of October. The bi-weekly trapping data showed that *S. titanus* reached a maximum in the number of catches during the period from the middle of August to the beginning of September, confirming the results in the literature that showed the insect developing one generation per year (Chuche and Thiéry, 2014; Tóthová *et al.*, 2015).

### Conclusion

The monitoring results showed that the North American grapevine leafhopper *Scaphoideus titanus* was present in all vineyards in the region Dealurile Moldovei surveyed in 2016, newly created within the national program of reconversion and restructuring in Romanian viticulture. There were variations in the abundance of the insect population depending on the age and cultivars of the grapevine plantations. The pest density ranged from 0.51 to 5.55 specimens per trap per week. Grapevine growers are encouraged to monitor the presence of *S. titanus*, to evaluate its population and to decide upon the control measures.

### Acknowledgement

The research was supported by the Ministry of Agriculture and Rural Development, Research Project ADER 4.1.2.

## References

- Bertaccini A., Duduk B. (2009). Phytoplasma and phytoplasma diseases: a review of recent research. *Phytopathologia Mediterranea*, 48, 355–378.
- Bertin S., Guglielmino C.R., Karam N., Gomulski L.M., Malacrida A.R., Gasperi G. (2007). Diffusion of the Nearctic leafhopper *Scaphoideus titanus* Ball in Europe: a consequence of human trading activity. *Genetica*, 131(3), 275-285.
- Boudon-Padieu E. (2005). Phytoplasmas associated to grapevine yellows and potential vectors, *Bulletin O.I.V.*, 79, 311-320.
- Chireceanu C., Ploaie P.G., Gutue M., Nicolae I., Stan C., Comsa M. (2011). Detection of the Auchenorrhyncha fauna associated with grapevine displaying yellows symptoms in Romania. *Acta Phytopathologica et Entomologica Hungarica*, 46 (2), 255-262.
- Chuche J., Thiéry D. (2014). Biology and ecology of the Flavescence dorée vector *Scaphoideus titanus*: a review. *Agronomy for Sustainable Development*, 34: 381–403.
- Galetto L., Miliordos D., Pegoraro M., Sacco D., Veratti F., Marzachi C., Bosco D. (2016). Acquisition of Flavescence Dorée phytoplasma by *Scaphoideus titanus* Ball from different grapevine varieties. *International Journal of Molecular Sciences*, 17(9), 1563-1563. [10.3390/ijms17091563](https://doi.org/10.3390/ijms17091563)
- EPPO (2017) EPPO Global Database (available online). <https://gd.eppo.int>
- Maixner M. (2005). Risks posed by the spread and dissemination of grapevine pathogens and their vectors, pp. 141- 146. In: *Introduction and spread of invasive species, Symposium Proceedings N° 81*, The British Crop Production Council, Alton, Hampshire, UK. 141-146.
- Mori N., Bressan A., Martini M., Guadagnini M., Girolami V., Bertaccini A. (2002). Experimental transmission by *Scaphoideus titanus* Ball of two Flavescence dorée-type phytoplasmas. *Vitis*, 41 (2), 99-102.
- Ploaie P.G. (1981). Mycoplasma-like organisms and plant diseases in Europe. p. 61–104. In: *“Plant Diseases and Vectors: Ecology and Epidemiology”* (K. Maramorosch, K.F. Harris, eds.). Academic Press, New York, USA, 368 pp.
- Riolo P., Minus R.L., Landi L., Nardi S., Ricci E., Righi M., Nunzio I. (2014). Population dynamics and dispersal of *Scaphoideus titanus* from recently recorded infested areas in central-eastern Italy. *Bulletin of Insectology*, 67(1), 99-107.
- Tóthová M., Bokor P., Cagán L. (2015). The First Detection of Leafhopper *Scaphoideus titanus* Ball (Hemiptera, Cicadellidae) in Slovakia. *Plant Protection Science*, 51 (2), 88-93.
- Weintraub P. G., Beanland L. (2006). Insect vectors of phytoplasmas. *Annual Review of Entomology*, 51, 91-111.

## PHYSIOLOGICAL AND BIOCHEMICAL CHANGES IN GRAPEVINE LEAVES AFFECTED BY YELLOWING AND REDDENING SYMPTOMS

Cristina PETRISOR<sup>1\*</sup>, Constantina CHIRECEANU<sup>1</sup>, Teodor PODRUMAR<sup>2</sup>

<sup>1</sup>Research and Development Institute for Plant Protection, Ion Ionescu de la Brad Bdv, No.4, District 1, Bucharest, Romania

<sup>2</sup>The Vine and Wine Research-Development Station Miniş, Ghioroc, Str. Iuliu Maniu, no. 6, 317135, Arad, Romania

\*Corresponding author:crisstop@yahoo.com

### Abstract

Yellowing or reddening of the grapevine leaves, represent a group of diseases which are widely spread in the regions of intensive vine -growing all over the world and are usually associated with phytoplasma etiology. A study was performed to investigate the changes in the content of pigments (chlorophylls, carotenoids), total phenols, and total and reducing sugars in the leaves of the four grapevine cultivars (Pinot Noir, Cabernet Sauvignon, Riesling, Traminer) collected at the Miniş-Maderat vineyard in Western Romania in 2016, naturally affected by symptoms typical to infections with phytoplasma. Quantification of the above mentioned compounds was made using specific spectrophotometric methods. The results showed that the amount of total chlorophyll and carotenoids were markedly reduced in the leaves collected from the symptomatic vine plants of all the varieties studied. In the red varieties affected by the symptoms, a decrease in chlorophyll was observed by approximately 45% compared to healthy plants. Among the varieties analyzed can be observed depending on the chlorophyll content that Riesling is probably more sensitive, compared to red varieties (Pinot Noir, Cabernet Sauvignon) being severely affected by phytoplasma. Similar results were obtained for the content of total phenols compounds. However significant increase in total sugars content was observed in the leaves of the affected vines compared to the healthy ones.

**Keywords:** *chlorophyll, polyphenols, leaves, total sugars, disease*

### Introduction

Different symptoms such as reddening of leaves and stems, the greening of non-green flower organs, overall yellowing, sterility of flowers, formation of bunch fibrous secondary roots, decline and dwarfism of plants are associated with phytoplasma that cause numerous diseases in a diverse ranges of economically important species including crops grapevine, ornamental plants, fruit trees, and vegetables (Martelli and Boudon-Padieu, 2006; Firrao *et al.*, 2007; Bertaccini and Duduk, 2010; Gharechahi *et al.*, 2016; Dermastia *et al.*, 2017).

In grapevine, phytoplasma induce disorder such as leaf yellowing or reddening, leaf rolling, lack or incomplete lignifications and necrosis of shoots, shriveled grapes decrease of yield and/or decline of vineyard. These symptoms suggests that photosynthesis and thus carbohydrate metabolism may be perturbed (Lepka *et al.* 1999; Bertamini and Nedunchezian, 2001a; Bertamini and Nedunchezian, 2001b; Bertamini *et al.*, 2002b; Martelli and Boudon-Padieu, 2006; Musetti, 2009; Rusjan *et al.*, 2012; Ploaie and Chireceanu, 2012; Prezelj *et al.*, 2016; Dermastia *et al.*, 2017). Carbohydrate metabolism is shown to be changed in infected grapevine plants, accumulation of carbohydrate assimilates

in photosynthetic source tissues induces feedback inhibition of photosynthesis causing chlorosis (Bertacini and Duduk, 2010).

Some reports have investigated the biochemical and physiological compounds involved in interactions between many plants and phytoplasma (Leon *et al.*, 1996; Lepka *et al.*, 1999; Bertamini *et al.*, 2002a; Bertamini *et al.*, 2003; Maust *et al.* 2003; Musetti *et al.*, 2004; Junqueira *et al.*, 2004; Musetti, 2009; Rusjan *et al.*, 2012; Hameed *et al.*, 2017).

However, only few studies were found related to biochemical and physiological changes in grapevine plants induced by phytoplasma infections (Bertamini and Nedunchezian, 2001a; Bertamini and Nedunchezian, 2001b; Bertamini *et al.*, 2002a; Rusjan *et al.*, 2012; Prezelj *et al.*, 2016; Punelli *et al.*, 2016). Also, this type of study was not carried out on the cultivars studied by us Pinot Noir, Cabernet Sauvignon, Riesling and Traminer.

The aim of this study was to investigate the physiological and biochemical response induced by yellowing and reddening symptoms associated with phytoplasma infections rate in grapevine leaves of different cultivars (two red cultivars and two white cultivars).

### **Materials and Methods**

The leaves of four grapevine cultivars (Pinot Noir, Cabernet Sauvignon, Riesling, Traminer) analyzed in our study were collected in the 2016 year, from grapevine plants naturally affected by symptoms specific to phytoplasma infections located in vineyards of Experimental Station from area Minis -Maderat (Romania). Leaf pigments, chlorophyll a (Chl a), chlorophyll b (Chl b) and carotenoids (Car) were extracted from infected and uninfected plants, overnight at 4°C with 100% (v/v) acetone, in extraction ratio 1:15 and after crude extracts were centrifuged at 6000 rpm for 20 minutes. Supernatant was used to estimate pigment concentrations spectrophotometrically according to methodology described by Lichtenthaler and Wellburn, 1985. The results were expressed as mg/g fresh weight and calculated based on formulas of Lichtenthaler and Wellburn (1985). Total phenolic compound content was estimated in the healthy and symptomatic grapevine leaves of each cultivars studied by using the method described by Singleton and Rossi, 1965 used Folin- Ciocalteu reagent. Total phenolics express as mg phenols (in terms of catechol) per 100g fresh tissue. Collected leaves with and without yellowing or reddening symptoms were analyzed for reducing sugars and total sugars content. Soluble or reducing sugars were extracted from 0.1 g fresh leaves by boiling in 80% ethanol for 15 min on water bath. Extracts were centrifuged at 2500 rpm for 5 minute for clarification and supernatant decanted and the sediment reextracted twice. Total sugars were assayed using the phenol sulfuric acid method (Dubois, 1956). Reducing sugar contents were assayed using the dinitrosalicylic acid method (Miller, 1959).

### **Results and Discussion**

Pigments, chlorophylls a and b play an important role in light absorption during photosynthesis (Prezelj *et al.*, 2009). Carotenoids are accessory pigments involved in lipid membrane stabilization in chloroplasts and in photosystem protection.

Data obtained showed that, there are significant differences in the chlorophyll content of the leaves between healthy plants and those with symptoms specific to phytoplasma infections (table 1).

In plants without symptoms, total leaf chlorophyll concentration was 2.30 mg/g FW for red cultivars and 2.46 mg/g FW for white cultivars. The total chlorophyll content was reduced around 45% in the symptomatic leaves of red varieties and 50% for white cultivars and this being correlated with leaf discoloration. Leon *et al.*, (1996) reported drastically chlorophyll reduction around 60% in coconut palms tissues affected by lethal yellowing. Among cultivars

analyzed in this study it can be observed depending on the total chlorophyll content that Riesling is probably more sensitive being severely affected by specific symptoms to phytoplasma infections. Zafari *et al.*, (2012) reported that content of total chlorophyll and carotenoids was significantly decreased in phytoplasma infected leaves of lime and the leaves presents chlorosis. Also several investigators have shown that reduction of chlorophylls can interfere in photosynthesis capacity of apple, mungbean leaves, corn, grapevine leaves infected with phytoplasma (Bertamini and Nedunchezian, 2001b; Bertamini *et al.*, 2002b; Bertamini *et al.*, 2003; Junqueira *et al.*, 2004; Hameed *et al.*, 2017). Some authors have argued that decrease in both Chl a and Chl b content could be the result of an enhanced chlorophyllase activity in phytoplasma infected leaves (Bertamini and Nedunchezian, 2001a; Bertamini *et al.*, 2002b). The Chl a/ Chl b ratio, which is used as stress indicator decreased from 2.02 value in leaves without symptoms to 1.5 in symptomatic leaves for all cultivars studied (table1). Similar results have been reported by Bertamini *et al.*, (2001a), Bertamini and Nedunchezian (2001b), Bertamini *et al.* (2002a), Bertamini *et al.*, (2003) and Zafari *et al.* (2012). However, in contradiction with our results, Rusjan *et al.*, (2012) supported that the Bois noir infections did not affected Chl a/Chl b ratio in Chardonnay leaves.

Table 1. Variation of chlorophyll and carotenoids content in symptomatic and healthy grapevine leaves of cultivars studied

Cultivars	Chl a (mg/g FW)	Chl b (mg/g FW)	Chl (a +b) (mg/g FW)	Chl a/ Chl b	Carotenoids (mg/g FW)	Car / Chl(a+b)
Pinot Noir healthy	1.47±0.6	0.73± 0.2	2.20±0.8	2.01	0.47±0.05	0.23
Pinot Noir affected	0.60±0.7	0.38±0.3	0.98±0.7	1.58	0.16±0.08	0.16
Cabernet Sauvignon healthy	1.65±0.6	0.71±0.4	2.36±0.9	2.32	0.35±0.06	0.15
Cabernet Sauvignon affected	0.65±0.3	0.44±0.4	1.09±0.8	1.48	0.15±0.04	0.14
Riesling healthy	1.76±0.7	0.70±0.2	2.46±0.6	2.51	0.47±0.05	0.19
Riesling affected	0.82±0.7	0.48±0.3	1.30±0.7	1.71	0.18±0.07	0.14
Traminer healthy	1.42±0.6	0.53±0.3	1.95±0.9	2.68	0.31±0.05	0.16
Traminer affected	0.49±0.5	0.41±0.4	0.90±0.5	1.20	0.12±0.04	0.13

The data are means ±SE of three replicates of each experiment

According to our results, Car/Chl ratio decreased in leaves affected by symptoms of all cultivars studied. These results are different from those obtained by Bertamini and Nedunchezian, (2001a) and Zafari *et al.*, (2012) which showed as this ratio increased in infected leaves with phytoplasma.

Carotenoids content was decrease from 0.47 mg/g FW in unaffected leaves of Pinot Noir cultivar to 0.16mg/g FW in symptomatic leaves. The carotenoid content of the white cultivars varies in the same way. Thus in symptomatic leaves, carotenoid amount decreased by 40%. Our results are in agreement with the findings of Rusjan *et al.*, (2012) and Zafari *et al.*, (2012).

In our study there was no significant difference in total phenols of symptomatic and non-symptomatic plants (table 2). However, total phenols content decreased slightly in affected leaves compared to healthy leaves for all cultivars studied. This results were similar with those of Musetti *et al.*, 2000 that observed a lower content of phenols in *Catharanthus roseus* phytoplasma infected. However, another studies showed that phenolics content increase in corn, apple, grapevine, coconut palms phytoplasma infected (Leon *et al.*, 1996; Lepka *et al.*, 1999; Maust *et al.*, 2003; Junqueira *et al.*, 2004). Our results demonstrated that symptomatic leaf tissue of all cultivars studied exhibited higher total sugars and reducing sugars content compared with healthy leaves (table 2). This results are in agreement with results of Lepka *et al.*, (1999) and Bertamini and Nedunchezian, (2001a). Accumulation of total sugars in infected leaves is indeed a common effect of phytoplasma infections (Leon *et al.*, 1996; Lepka *et al.*, 1999; Maust *et al.*, 2003; Junqueira *et al.*, 2004). Also, Prezelj *et al.*, (2016) shown that the concentration of reducing sugars in symptomatic leaves of cv. Blaufränkisch infected with FD, are slightly higher, while those of total sugars significantly increase upon infection. On the contrary, Zafari *et al.*, (2012) demonstrated that total soluble sugars and reducing sugars contents decreased in phytoplasma infected lime leaves reached to ca 70% and 60 % of the control value, respectively.

Table 2. Variation of reducing, total sugars and total phenols content in symptomatic and healthy grapevine leaves of cultivars studied

Cultivar	Reducing sugars g/kg FW	Total sugars g/kg FW	Total phenols g/100gFW
Pinot Noir healthy	35.4±1.50	51.2±1.10	0.55±0.02
Pinot Noir affected	49.1±0.90	76.3±1.00	0.40±0.03
Cabernet Sauvignon healthy	38.1±1.08	64.8±1.51	0.40±0.05
Cabernet Sauvignon affected	53.1±0.50	78.1±0.61	0.35±0.05
Riesling healthy	24.8±2.11	40.2±1.70	0.25 ±0.08
Riesling affected	36.3±2.03	60.5±1.09	0.17±0.09
Traminer healthy	27.1±0.25	47.4±1.41	0.35±0.09
Traminer affected	39.7±0.64	64.6±1.30	0.25±1.02

The data are means ±SE of three replicates of each experiment

### Conclusions

Our results indicate that the physiological and biochemical compounds were widely affected in grapevine that develop reddening or yellowing symptoms. These foliar symptoms observed could lead to decrease of yield and vigour of grapevine plants. Symptomatic grapevine plants present an increase concentration of total and reducing sugars and a slightly low phenol content. Also, decrease of phenols in symptomatic leaves was accompanied by decrease of chlorophyll and carotenoids content.

## Acknowledgments

This work was carried out within the ADER 412/2015 research project funded by the Ministry of Agriculture and Rural Development.

## References

- Bertaccini A., Duduk B. (2010). Phytoplasma and phytoplasma diseases: a review of recent Research, *Phytopathol Mediterranea*, 48, 355–378
- Bertamini M., Grando M.S., Nedunchezian N. (2003). Effects of phytoplasma infection on pigments, chlorophyll- protein complex and photosynthetic activities in field grown apple leaves, *Biologia Plantarum*, 47(2), 237-242
- Bertamini M., Grando M. S., Muthuchelian K., Nedunchezian N. (2002a). Effect of phytoplasma infection on photosystem II efficiency and thylakoid membrane protein changes in field grown apple (*Malus pumila*) leaves, *Physiology and Molecular Plant Pathology* 61, 349-356
- Bertamini M., Nedunchezian N., Tomasi F., Grando M. S. (2002b). Phytoplasma [Stolbur-subgroup (Bois Noir-BN)] infection inhibits photosynthetic pigments, ribulose-1,5-bisphosphate carboxylase and photosynthetic activities in field grown grapevine (*Vitis vinifera* L. cv.Chardonnay) leaves, *Physiology and Molecular Plant Pathology*, 61, 357-366.
- Bertamini M., Nedunchezian N., (2001a). Effects of phytoplasma [stolbur-subgroup (Bois-noir-BN) on photosynthetic pigments, saccharides, ribulose 1,5-bisphosphate carboxylase, nitrate and nitrite reductases, and photosynthetic activities in field grown grapevine (*Vitis vinifera* L.cv Chardonnay) leaves, *Photosynthetica*, 39, 119-122
- Bertamini M., Nedunchezian N., (2001b). Decline of photosynthetic pigments, ribulose-1,5-bisphosphate carboxylase and soluble protein contents, nitrate reductase and photosynthetic activities, and changes in thylakoid membrane protein pattern in canopy shade grapevine (*Vitis vinifera* L. cv. Moscato Giallo) leaves, *Photosynthetica*, 39, 527-537
- Dermastia M. Bertacini A., Constable F., Mehle N. (2017). Grapevine yellow diseases and their phytoplasma agents -Biology and Detections, *SpringerBriefs in Agriculture Switzerland*, 47-62
- Dubois M., Gilles K.A., Hamilton J.K., Rebers P.A., Smith F. (1956). Colorimetric method for determination of sugars and related substances, *Analytical Chemistry*, 28, 350-356
- Firrao G. M., Garcia-Chapa M., Marzachi C. (2007). Phytoplasmas: genetics, diagnosis and relationships with the plant and insect host, *Frontiers in Bioscience*, 12,1353-1375
- Gharechahi J., Mardi M., Salekdeh G.H. (2016) Insight into physiological, molecular, and proteomic changes associated with phytoplasma infection in crop plants in G.H. Salekdeh (ed.), *Agricultural Proteomics*, Vol.2, pp. 251-265
- Hameed S., Akhtar K.P., Hameed A., Gulzar T., Kiran S., Yousaf S., Abbas G., Asghar M.J., Sarwar N. (2017). Biochemical changes in the leaves of mungbean (*Vigna radiate*) plants infected by phytoplasma, *Turkish Journal of Biochemistry*, 1-8
- Junqueira, A., Bedendo, I., Pascholati, S. (2004). Biochemical changes in corn plants infected by the maize bushy stunt phytoplasma, *Physiology and Molecular Plant Pathology*, 65, 181-185
- Leon R., Santamaria J., Alpizar L., Escamilla A., Oropeza C. (1996). Physiological and biochemical changes in shoots of coconut palms affected by lethal yellowing, *New Phytologist*, 134, 227–234.

- Lepka, P., Stitt M., Moll E., Seemüller E. (1999). Effect of phytoplasma infection on concentration and translocation of carbohydrates and amino acids in periwinkle and tobacco, *Physiology and Molecular Plant Pathology*, 55, 59–68.
- Lichtenthaler H.K., Wellburn A.R. 1985. Determination of total carotenoids and chlorophyll a and b of leaf extracts in different solvents, *Biochemical Society Transactions*, 11, 591–592
- Martelli G.P., Boudon-Padieu E. (2006). Directory of infectious diseases of grapevines, *Options Méditerranéennes B*, 55, 157-194.
- Maust B.E., Espadas F., Talavera C., Aguilar M., Santamaria J.M., Oropeza, C. (2003). Changes in carbohydrate metabolism in coconut palms infected with the lethal yellowing phytoplasma, *Phytopathology*, 93, 976–981.
- Miller G. L. (1959). Use of dinitrosalicylic acid reagent for determination of reducing sugar. *Analytical Chemistry*, 31, 426-428.
- Musetti R. (2009). Biochemical changes in plants infected by phytoplasmas, in *Phytoplasmas: Genomes, Plant Hosts and Vectors*, P. G. Weintraub and P. Jones, Eds., CABI Publishing, Wallingford, UK1, 35–149
- Musetti R., Di Toppi L.S., Ermacora P., Favali M.A. (2004). Recovery in apple trees infected with the apple proliferation phytoplasma: an ultrastructural and biochemical study. *Phytopathology*, 9, 203–208
- Musetti R., Favali M.A., Pressaco L. (2000). Histopathology and polyphenol content in plants infected by phytoplasma, *Citobios*, 102, 233-147
- Ploaie P.N., Chireceanu C. (2012). Experimental proofs regarding the association of cell wall deficient bacteria (mycoplasma-like organisms, phytoplasmas) with grapevine yellows disease in Romania, *Romanian Biotechnological Letters*, 17(3), 7260-7269
- Prezelj N., Covington E., Roitsch T., Grudnen K., Fragner L., Weckwerth W., Chersicola M., Vodopivec M., Dermastia M. (2016). Metabolic consequences of infection of grapevine (*Vitis vinifera* L.) cv. Modra frankinja with “flavescence dorée” phytoplasma. *Front Plant Science*, 7, 1-19
- Punelli F., Al Hassan M., Fileccia V., Uva P., Pasquini G., Martinelli F. (2016). A microarray analysis highlights the role of tetrapyrrole pathways in grapevine responses to “stolbur” phytoplasma, phloem virus infections and recovered status, *Physiological and Molecular Plant Pathology*, 93, 129-137
- Rusjan D., Halbwirth H., Stich K. Mikulic-Petrovsek M., Veberic R. (2012). Biochemical response of grapevine variety Chardonnay (*Vitis vinifera* L.) to infection with grapevine yellows (“bois noir”), *European Journal of Plant Pathology*, 134, 231–237
- Singleton V.L., Rossi J.A. (1965). Colorimetry of total phenolic with phosphomolybdic phosphotungstic acid reagents, *American Journal Enology & Viticulture*, 16, 144-158
- Zafari S. Niknam V., Musetti R., Noorbakhsh S.N. (2012). Effect of phytoplasma infection on metabolite content and antioxidant enzyme activity in lime (*Citrus aurantifolia*), *Acta Physiologiae Plantarum*, 34(2), 561–568



## EXTRACT VISCOSITY OF FEED INGREDIENTS USED FOR EVALUATION OF ANTINUTRITIONAL PROPERTIES

Rodica CAPRITA<sup>1</sup>, Adrian CAPRITA<sup>2\*</sup>

<sup>1</sup>Department of Biotechnologies, Banat's University of Agricultural Sciences and Veterinary Medicine "King Michael I of Romania" from Timisoara, Romania

<sup>2</sup>Department of Food Technology, Banat's University of Agricultural Sciences and Veterinary Medicine "King Michael I of Romania" from Timisoara, Romania

\*Corresponding author: adi.caprita@gmail.com

### Abstract

The antinutritive effect of soluble non-starch polysaccharides (NSPs) in monogastric animals is mainly associated with their physiological effects on the digestive medium due to their viscous nature. Soluble NSPs increase the viscosity in the small intestine, hampering the digestion process. Insoluble NSPs impede the access of endogenous enzymes to their substrates by physical entrapping. Extract viscosity values of grains could be used as predictors of anti-nutritional properties of NSP in cereals. The study had in view the effect of the extraction conditions and the soluble NSP concentration of the feed water extracts on the dynamic viscosity (DV). The experiments were carried out on samples of forage mixtures with different structures, and different proportions of wheat (WF1 and WF2) and barley (BF1 and BF2). The water-soluble fraction was obtained using a single extraction at a ratio 1:2 (w/v), with (procedure 1) and without (procedure 2) endogenous enzyme inactivation. DV in wheat containing feeds is lower than those in barley containing feeds. The viscosity values of the water extracts obtained after endogenous enzymes inactivation are higher than those obtained without enzymes inactivation, when the soluble NSPs were hydrolyzed and consequently their molecular mass reduced. Higher correlation between dynamic viscosity and cereal content in the feed was observed in procedure 1:  $r = 0.9877$  for BF1,  $r = 0.9885$  for BF2,  $r = 0.9827$  for WF1 and  $r = 0.9887$  for WF2 as compared to procedure 2:  $r = 0.9849$  for BF1,  $r = 0.9348$  for BF2,  $r = 0.8474$  for WF1 and  $0.9454$  for WF2.

**Keywords:** *non-starch polysaccharides, dynamic viscosity, wheat, barley.*

### Introduction

In animal nutrition as "non-starch-polysaccharides (NSP)" are summarized polysaccharides, which cannot be degraded by endogenous enzymes and therefore reach the colon almost indigested (Saki, 2005). Non-starch polysaccharides from various cereal grains are considered to have anti-nutritive effect in poultry nutrition if they are present in diets at high concentrations (Bach Knudsen, 2001). The increase in the digesta viscosity in monogastric animals decreases the nutrient diffusion (Fengler and Marquardt, 1988), reduces the rate of the feed transit (Salih *et al.*, 1991 and increases the microbial growth in the small intestine (Feighner and Dashkevicz, 1988).

The cell wall polysaccharides of cereals are comprised mainly of arabinoxylans and  $\beta$ -glucan, with smaller quantities of cellulose (Lineback and Rasper, 1988). The NSP content and type can also differ among grains. The NSP content relative to dry matter is lower in wheat kernel (11.4%) than in rye (13.2%) and barley (16.7%). Arabinoxylan is the predominant NSP in wheat (6-8%) and rye (8.9%), while  $\beta$ -glucan is the predominant NSP in barley (7.6%) (Schweizer and Würsch, 1981).

These polysaccharides are typically long polymeric carbohydrate chains containing up to several hundred thousand monomeric units (Choct, 1997). Monosaccharides commonly present in cereal cell walls are: (a) *hexoses*: D-glucose, D-galactose, D-mannose, (b) *pentoses*: L-arabinose, D-xylose, and (c) *acidic sugars*: D-galacturonic acid, D-glucuronic acid and its 4-O-methyl ether.

The NSP may be relatively simple, such as the cereal  $\beta$ -D-glucans which are linear polymers of glucose with  $\beta$ -(1-3),(1-4) glycosidic links. The other major cereal polysaccharides, the arabinoxylans, are more complex being composed of two sugars, arabinose and xylose, in a branched structure (Caprita *et al.*, 2010).

The main physicochemical properties of NSP that are of nutritional significance include: (a) hydration properties; (b) viscosity; (c) cation exchange capacity; and (d) organic compound absorptive properties (Smits and Annison, 1996).

The detrimental effect of soluble NSP is mainly associated with the viscous nature of these polysaccharides and their physiological effects on the digestive medium (Caprita and Caprita, 2011). Soluble NSP increases the viscosity of the small intestinal chyme, generally hampering the digestion process, whereas insoluble NSP impedes the access of endogenous enzymes to their substrates by physical entrapping (Bedford, 1995; Steinfeldt *et al.*, 1995). Almost all water-soluble polysaccharides produce viscous solution (Caprita and Caprita, 2012). The viscosity of a polymer solution is directly related to the fundamental molecular properties (molecular conformation, molecular weight, and molecular weight distribution) and concentration of the polymer (Caprita *et al.*, 2011). Extract viscosity values of grains could be used as predictors of anti-nutritional properties of NSP in cereals.

The study had in view the effect of the extraction conditions and the soluble NSP concentration of the feed water extracts on the dynamic viscosity (DV).

## Materials and Methods

Samples of forage mixtures with different structures and different proportions, of wheat (WF1 and WF2), and barley (BF1 and BF2), were milled by a laboratory grinder at a 600  $\mu$ m sieve. The water-soluble fraction was obtained using a single extraction at a ratio 1:2 (w/v), with endogenous enzyme inactivation (procedure 1) and without endogenous enzyme inactivation (procedure 2). In procedure 1 we incubated the sample with 80% (v/v) ethanol at 80°C, then added water to the pellet and incubated it at 40°C for 2 h with constant stirring. In procedure 2 we skipped the incubation step with ethanol. The extracts were centrifuged for 10 minutes at 5,000 rpm and 25°C, using a Hettich 320R centrifuge. Following the centrifugation, an aliquot of 0.5 mL supernatant was taken and the dynamic viscosity determined using a Wells Brookfield Cone/Plate Digital Viscometer, Model DVIII Cone CP-40. Viscosity measurements were carried out at 100 rpm and at a constant temperature of 25°C.

## Results and Discussion

DV in wheat containing feeds is lower than those in barley containing feeds. The viscosity values of the water extracts obtained after endogenous enzymes inactivation are higher than those obtained without enzymes inactivation when the soluble NSPs were hydrolyzed and consequently their molecular mass reduced. DV increased with wheat concentration: from 1.8 cP (WF1 with 0% wheat) to 2.40 cP (WF1 with 40% wheat) and from 1.91 cP (WF2 with 0% wheat) to 2.55 cP (WF2 with 40% wheat) for procedure 1, and from 1.35 cP (WF1 with 0% wheat) to 1.56 (WF1 with 40% wheat) and from 1.16 cP (WF2 with 0% wheat) to 1.38 (WF2 with 40% wheat) for procedure 2 (Figures 1 and 2).

DV increased with barley concentration: from 2.02 cP (BF1 with 0% barley) to 2.54 (BF1 with 30% barley) and from 2.29 cP (BF2 with 0% barley) to 3.06 (BF2 with 40% barley) for procedure 1, and from 1.68 (BF1 with 0% barley) to 2.10 (BF1 with 30% barley) and from 1.57 cP (BF2 with 0% barley) to 2.08 (BF2 with 40% barley) for procedure 2 (Figures 3 and 4).

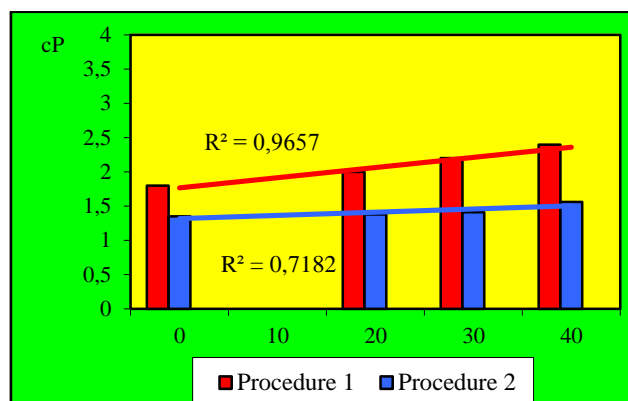


Figure 1. The positive correlation between viscosity and wheat concentration in WF1

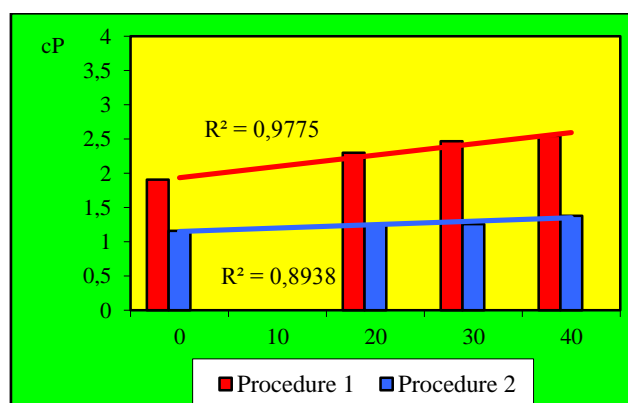


Figure 2. The positive correlation between viscosity and wheat concentration in WF2

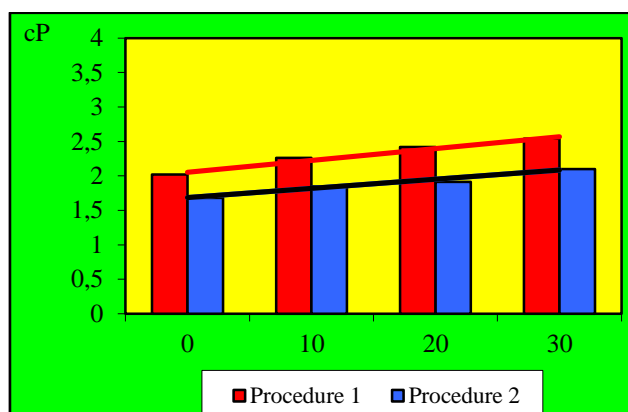


Figure 3. The positive correlation between viscosity and barley concentration in BF1

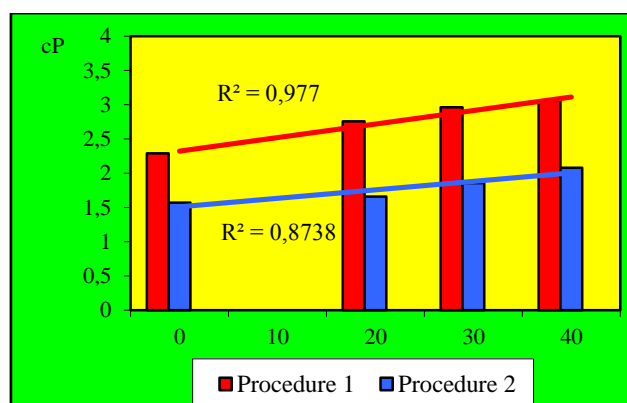


Figure 4. The positive correlation between viscosity and barley concentration in BF2

Higher correlation between dynamic viscosity and cereal content in the feed was observed in procedure 1:  $r = 0.9877$  for BF1,  $r = 0.9885$  for BF2,  $r = 0.9827$  for WF1 and  $r = 0.9887$  for WF2, as compared to procedure 2:  $r = 0.9849$  for BF1,  $r = 0.9348$  for BF2,  $r = 0.8474$  for WF1 and  $r = 0.9454$  for WF2.

### Conclusions

Water extract viscosities correlated well with the wheat and barley concentrations of the feed samples. Higher dynamic viscosities and a better correlation between wheat and barley proportion was obtained when extraction was preceded by inactivation of enzymes.

Procedure without endogenous enzyme inactivation has the advantage that it is faster and does not require ethanol consumption.

### References

- Bach Knudsen K.E. (2001). The nutritional significance of "dietary fiber" analysis, *Animal Feed Science and Technology*, 90, 3-20.
- Bedford M.R. (1995). Mechanism of action and potential environmental benefits from the use of feed enzymes, *Animal Feed Science and Technology*, 53, 145-155.
- Caprita A., Caprita R., Simulescu V.O.G., Drehe R.M. (2010). Dietary fiber: chemical and functional properties, *Journal of Agroalimentary Processes and Technologies* 16 (4), 406-410.
- Caprita R., Caprita A. (2011). Chemical methods for the determination of soluble and insoluble non-starch polysaccharides-review, *Scientific Papers Animal Science and Biotechnologies*, 44(2), 73-80.
- Caprita R., Caprita A. (2012). The variation of relative and reduced viscosity with concentration in wheat and barley aqueous extracts, *Scientific Papers Animal Science and Biotechnologies* 45 (2), 117-120.
- Caprita R., Caprita A., Cretescu I. (2011). Effective extraction of soluble non-starch polysaccharides and viscosity determination of aqueous extracts from wheat and barley. *Lecture Notes in Engineering and Computer Science*, 2194(2), 613-616.
- Choct, M. (1997). Feed non-starch polysaccharides: chemical structures and nutritional significance, *Feed Milling International*, 191, 13-26.
- Feighner S.D., Dashkevicz M.P. (1988). Effect of dietary carbohydrates on bacterial cholytaurine hydrolase in poultry intestinal homogenates, *Applied and Environmental Microbiology*, 54, 334-342.

- Fengler A.I., Marquardt R.R. (1988). Water-soluble pentosans from rye: II. Effects on rate of dialysis and retention of nutrients by the chick, *Cereal Chemistry*, 65, 298-302.
- Lineback D.R., Rasper V.F. (1988). Wheat carbohydrates. In: *Wheat: Chemistry and Technology*, Vol. 1, Y. Pomeranz (ed.), Am. Assoc. Cereal Chem., St. Paul, pp. 277-371.
- Saki A.A. (2005). Effect of wheat and barley viscosity on broiler performance in Hamadan Province, *International Journal of Poultry Science*, 4, 7-10.
- Salih M.E., Classen H.L., Campbell G.L. (1991). Response of chickens fed hull-less barley to dietary beta-glucanases at different ages, *Animal Feed Science and Technology*, 33, 139-149.
- Schweizer T.F., Würsch P. (1981). Analysis of dietary fiber. In: *The Analysis of Dietary Fiber in Food*, W.P.T. James, O. Theander (eds), Marcel Dekker, New York, pp. 203–216.
- Smits C.H.M., Annison G. (1996). Non-starch polysaccharides in broiler nutrition towards a physiologically valid approach to their determination, *World's Poultry Science Journal*, 52, 203–21.
- Steenfeldt S., Knudsen K.E., Boring C.F., Eggum B.O. (1995). The nutritive value of decorticated mill fractions of wheat. 2. Evaluation with raw and enzyme treated fractions using adult cockerels, *Animal Feed Science and Technology*, 54, 249–265.

## EFFECT OF DRY HEAT TREATMENT ON THE DIETARY FIBER IN BARLEY

Rodica CAPRITA<sup>1</sup>, Adrian CAPRITA<sup>2\*</sup>

<sup>1</sup>Department of Biotechnologies, Banat's University of Agricultural Sciences and Veterinary Medicine "King Michael I of Romania" from Timisoara, Romania

<sup>2</sup>Department of Food Technology, Banat's University of Agricultural Sciences and Veterinary Medicine "King Michael I of Romania" from Timisoara, Romania

\*Corresponding author: adi.caprita@gmail.com

### Abstract

Cereal grains are major sources of dietary fiber (DF), an important component of food and an important contributor to human health. Based on their water solubility DF is classified as soluble dietary fiber (SDF) and insoluble dietary fiber (IDF). Barley contains substantial amounts of both SDF and IDF. The predominant water SDF in barley is  $\beta$ -glucan (7.6%). Soluble dietary fibers, such as  $\beta$ -glucans, lower blood cholesterol and glucose concentrations partly because of their capacity to increase the viscosity of intestinal chime. Soluble polysaccharides give viscous aqueous solutions. The physical and physiological properties of  $\beta$ -glucans are of commercial and nutritional importance. Food processing is mostly based on heating. Heat treatment alters the properties of plant cell wall and modifies the composition and solubility of fibers, which modifies the water extract viscosity (WEV). The experiments had in view the effect of dry heat treatment (in forced air oven, and microwave oven) on the SDF fraction in barley, revealed by determination of WEV. The experimental data revealed that thermal processing has a marked effect on the viscosity of SDF. Heat treatment increased WEV and also demonstrated that the proportion of SDF in the total DF content of the cooked flour increased with cooking time. A redistribution of the total DF content from insoluble to soluble components occurs. An increase in WEV of 73% occurred when heating at 150°C for 10 minutes, and of 56% when heating at 180°C for 5 minutes. When heating 90 seconds in microwave, WEV increased with 41%. Further heating (120 seconds) decreased WEV.

**Keywords:** *dietary fiber, barley,  $\beta$ -glucan, water extract viscosity, heat treatment*

### Introduction

The quality of food is strongly related to the nutritional and therapeutic properties, and the effect on consumers' health. Dietary fiber (DF) is an important component of food. DF includes all non-starch polysaccharides resistant to digestion in the small intestine and fermentable in the large intestine. Based on their water solubility, DF is classified as soluble dietary fiber (SDF) and insoluble dietary fiber (IDF) (Chawla and Patil, 2010; Tungland and Meyer, 2002). Soluble fiber includes gums, mucilages, pectin and some hemicelluloses. Insoluble fibers are cellulose, lignin, and the rest of the hemicelluloses; these fibers provide structure to plants (Henley and Misner, 1999; Anderson *et al.*, 2011). Although poor in caloric or nutritional value, food fiber has significant health benefits and may assist weight control. Fiber deficiency is linked to a higher risk of digestive conditions, raised cholesterol levels and some intestinal cancers. Barley contains substantial amounts of both soluble and insoluble dietary fiber. During digestion, soluble fibers turn into gel like substances, slow down digestion process in the stomach and intestines, stabilizing blood glucose levels, and increasing the uptake of minerals and other nutrients. Insoluble fibers consist of the parts of

plants which cannot be digested at all, moving whole through the digestive system; insoluble fibers increase stool volume and stimulate normal bowel contractions thus reducing passage-time through the colon, improving health in the intestinal tract, and reducing digestive complaints (American Heart Association, 2011; Anderson and Bridges, 1988; Esposito *et al.*, 2005). The predominant water SDF in barley is  $\beta$ -glucan (7.6%). Woodward *et al.*, 1983 determined the chemical structure and physicochemical properties of water-soluble barley  $\beta$ -glucans. These glucans consist of a population of molecules with molecular weights ranging from  $10^4$  to  $10^7$  and are responsible for the high viscosity of  $\beta$ -glucan solutions (Caprita and Caprita, 2012). Soluble dietary fibers, such as  $\beta$ -glucans, lower blood cholesterol and glucose concentrations partly because of their capacity to increase the viscosity of intestinal chime. Soluble polysaccharides give viscous aqueous solutions (Caprita *et al.*, 2011a). The viscosity properties depend on molecular weight or molecule size (linear or branched), ionically charged groups, surrounding structures, and concentration of DF (Caprita and Caprita, 2011b). In aqueous solutions, water molecules penetrate the amorphous regions of soluble DF. The increase in viscosity is explained by formation of  $\text{Ca}^{2+}$  bridges and hydrogen bonds, resulting in a loose network that can hold considerable amounts of water (Caprita *et al.*, 2010a; Caprita *et al.*, 2010b; Mongeau, 2003). The physical and physiological properties of  $\beta$ -glucans are of commercial and nutritional importance. Food processing is mostly based on heating. Thermal processing of plant tissues alters the physical and chemical properties of plant cell wall and modifies the composition and solubility of fibers, which modifies the water extract viscosity (WEV) (Izydorczyk *et al.*, 2000, (Caprita and Caprita, 2011a). The experiments had in view the effect of dry heat treatment of barley on the soluble fraction of DF, revealed by determination of WEV.

### Materials and Methods

Barley samples were milled by a laboratory grinder to 500  $\mu\text{m}$  granulation, and thermal processed by heating in a forced air oven, or by exposing to microwave radiations. Samples were heated for 5, 10 and 15 minutes at 150 °C and 180°C in a Froilabo AC60 forced air oven. The microwave treatment was made in a Vortex WD800D-823 oven (800 W and 2450 Hz), for 30, 60, 90 and 120 seconds. The water-soluble fractions were obtained using a single extraction at a ratio of flour to water of 1:2, by shaking the tubes at 150 rpm for 60 minutes at 40°C, using a LabTech LSB-015S water bath. The obtained extracts were centrifuged for 10 minutes at 5,000 rpm and 25°C, using a Hettich 320R centrifuge. The dynamic viscosity was determined using a cone/plate viscometer Brookfield Model DVIII Cone CP-40, at 100 rpm and 25°C, and the relative viscosity was calculated.

### Results and Discussion

Thermal processing of plant tissues alters the physical and chemical properties of plant cell wall. The experimental data reveal that thermal processing increased the soluble dietary fraction in barley. In general, the changes in the DF composition during cooking may be attributed partly to the redistribution of the insoluble and soluble components of DF, and partly to the formation of resistant starch (Caprita *et al.*, 2011b).

The obtained experimental data, presented in Table 1, show the effect of thermal treatment on the soluble fraction of DF in barley, effect revealed by the determined values of the water extract viscosities. The relative viscosity value of water extract from untreated barley flour was 2.95 cP.

Thermal treatment at 150°C produced an increase of water extracts viscosities. The proportion of SDF from total DF increased with the heating time. The experimental data suggest a

conversion of the IDF into SDF. An increased temperature breaks weak bonds between polysaccharide chains and split glycosidic linkages in the DF polysaccharides (Selvendran and Robertson, 1994). As consequence, the architecture of the fiber matrix may be modified and insoluble fiber solubilized (Margareta and Nyman, 2003).

Table 1. Viscosities of water extracts from thermally treated barley flour

Viscosity (cP)	Treatments of barley flour: temp. and time ( minutes and seconds)									
	Forced air oven						Microwave radiations			
	150 °C			180 °C						
	5'	10'	15'	5'	10'	15'	30''	60''	90''	120''
Dynamic viscosity	3.62	3.99	3.59	3.64	3.33	3.01	2.01	2.68	3.34	3.18
Relative viscosity	4.64	5.11	4.60	4.60	4.21	3.81	2.51	3.39	4.17	4.02

The relative viscosity of water extract increased up to 5.11 cP (73% increasing) when barley was heated 10 min. at 150°C, and up to 4.60 cP (56% increasing) when heated at 180°C for 5 minutes. A decrease in WEV was observed when barley was heated 15 minutes at 150°C, and 10 and 15 minutes at 180°C, suggesting formation of water insoluble resistant starch (Figure 1).

The microwave radiations treatment increased WEV up to 4.17 cP (41% increasing) after 90 seconds (Figure 2). Further microwave treatment decreased WEV to 4.02 cP (after 120 seconds).

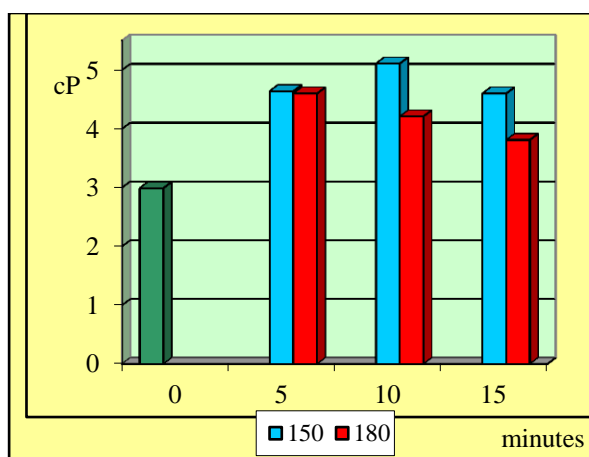


Figure 1. Relative viscosities of water extracts from barley heated in forced air oven at 150°C and 180°C, for 5, 10 and 15 minutes

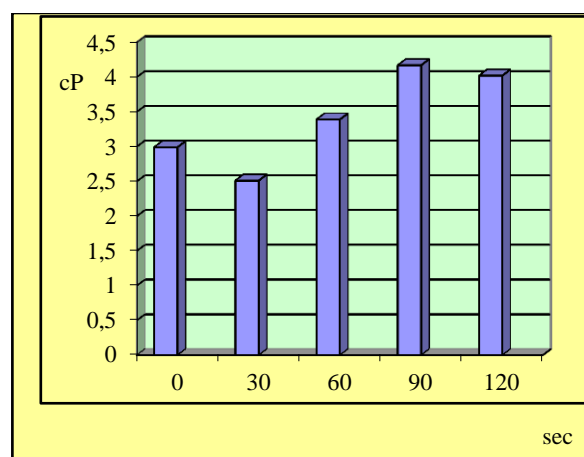


Figure 2. Relative viscosities of water extracts from barley heated in microwave oven for 30, 60, 90 and 120 seconds

### Conclusions

The increase of the soluble dietary fiber proportion in the total dietary fiber content in barley, produced by the thermal treatment for 10 minutes at 150°C, suggests a redistribution of the total dietary fiber content from insoluble to soluble components.

A decrease in water extracts viscosities when barley was heated 15 minutes at 150°C, and 10 and 15 minutes at 180°C, and at microwave treatment for 120 seconds, suggest the formation of water insoluble resistant starch.



## References

- American Heart Association. (2011). Whole grains and fiber, <http://www.americanheart.org/presenter.jhtml?identifier=4574>.
- Anderson J., Perryman S., Young L., Prior S. (2011). Dietary fiber, <http://www.ext.colostate.edu/pubs/foodnut/09333.html>.
- Anderson J.W., Bridges S.R. (1988). Dietary fiber content of selected foods, *American Journal of Clinical Nutrition*, 47, 440-447.
- Caprita A., Caprita R. (2011a). The effect of thermal processing on soluble dietary fibre fraction in wheat, *Journal of Food, Agriculture & Environment*, 9 (3,4), 14-15.
- Caprita A., Caprita R., Simulescu V.O., Drehe R.M. (2010a). Dietary fiber: chemical and functional properties, *Journal of Agroalimentary Processes and Technologies*, 16, 406-410.
- Caprita R., Caprita A. (2011b). Chemical methods for the determination of soluble and insoluble non-starch polysaccharides-review, *Scientific Papers Animal Science and Biotechnologies*, 44(2), 73-80.
- Caprita R., Caprita A. (2012). The variation of relative and reduced viscosity with concentration in wheat and barley aqueous extracts, *Scientific Papers Animal Science and Biotechnologies* 45 (2), 117-120.
- Caprita R., Caprita A., Cretescu I. (2011a). Effective extraction of soluble non-starch polysaccharides and viscosity determination of aqueous extracts from wheat and barley. *Lecture Notes in Engineering and Computer Science*, 2194(2), 613-616.
- Caprita R., Caprita A., Julean C. (2010b). Biochemical aspects of nonstarch polysaccharides, *Scientific Papers Animal Science and Biotechnologies*, 43(1), 368-374.
- Caprita R., Caprita A., Simulescu V.O., Drehe R.M. (2011b). The Effect of Temperature on Soluble Dietary Fiber Fraction in Cereals, *Journal of Agroalimentary Processes and Technologies*, 17 (3), 214-217.
- Chawla R., Patil G.R. (2010). Soluble dietary fiber, *Comprehensive Reviews in Food Science and Food Safety*, 9, 178–196.
- Esposito F., Arlotti G., Bonifati A.M., Napolitano A., Vitale D., Vincenzo F. (2005). Antioxidant activity and dietary fiber in durum wheat bran by-products, *Food Research International*, 38, 1167–1173.
- Henley S., Misner S. (1999). Dietary fiber, <http://ag.arizona.edu/pubs/health/az1127.html>.
- Izydorczyk M.S., Storsley J., Labossiere D., MacGregor A.W., Rosnagel B.G. (2000). Variation in total and soluble  $\beta$ -glucan content in hulless barley: effects of thermal, physical, and enzymic treatments, *Journal of Agricultural and Food Chemistry*, 48, 982–989.
- Margareta E., Nyman G.-L. (2003). Importance of processing for physico-chemical and physiological properties of dietary fibre, *Proceedings of the Nutrition Society*, 62, 187-192.
- Mongeau R. (2003). Dietary fiber. In: Macrae, R. et al. (eds.). *Encyclopedia of Food Science and Nutrition*, New York: Academic Press, pp. 1362–1387.
- Selvendran R.R., Robertson J.A. (1994). Dietary fiber in foods: amount and type. In: Amado R. et al. (eds). *COST-92, Metabolic and physiological aspects of dietary fiber in food*. Luxembourg: Commission of the European Communities, pp. 11-19.
- Tungland B.C., Meyer D. (2002). Non-digestible oligo- and polysaccharides (dietary fiber): their physiology and role in human health and food, *Comprehensive Reviews in Food Science and Food Safety*, 3, 73–77.

Woodward J.R., Fincher G.B., Stone B.A. (1983). Water soluble (1-3)(1-4)- $\beta$ -D-glucans from barley (*Hordeum vulgare*) endosperm. II. Fine structure, *Carbohydrate Polymers*, 3, 207–225.

## OBSERVATIONS ON FLIGHT DYNAMICS OF THE LEAF MINING MOTH - CAMERARIA OHRIDELLA DESCHKA & DIMIC IN 2014-2015

Mihai TĂLMACIU <sup>1\*</sup>, Nela TĂLMACIU <sup>1</sup>, Carmen MIROIU <sup>2</sup>, Monica HEREA <sup>1</sup>

<sup>1</sup> University of Applied Life Sciences and Environment” from IAȘI, Romania

<sup>2</sup> Phytosanitary National Authority– Vaslui Phytosanitary Department., Romania

\*Corresponding author: mtalmaciu@yahoo.fr

### Abstract

The chestnut moth leaf miner, *Cameraria ohridella* Deschka & Dimic represents in the Huși area a dangerous pest, which outbreaks causing damages every year. In this paper flight dynamics the butterflies followed traps type Atra-CAM. The butterflies flight situation is as follows: In 2015 the flight of hibernate generation butterflies started on 8.05, and it is finished on 21.05. The maximum flight curve was recorded on 21.05 when they were captured a total of 389 samples; The flight of the first-generation butterflies has started on the 21.06, and he concluded on 31.07. The maximum flight curve was recorded on 30.06 when they were captured a total of 410 samples; The flight of the second-generation butterflies started on 1.08, and it's concluded on 3.09. The maximum flight curve was recorded on 15.08 when they were captured a total of 400 samples. In 2016 the flight of hibernate generation butterflies began in May, on 09.05, and he finished on on 21.06. The maximum flight curve was recorded on 31.05 when they were captured a total of 380 samples; The flight of first generation butterflies has started on the 26.06, and he finished on on 31.07. The maximum flight curve was recorded on 13.07 when they were captured a total of 290 samples; The flight of second generation butterflies started on 3.08, and he finished on on 15.09. The maximum flight curve was recorded on 15.08 when they were captured a total of 400 samples.

**Keywords:** *flight of butterflies, dynamic, traps, AtraCam.*

### Introduction

*Cameraria ohridella* Deschka & Dimic has as its main host the ornamental chestnut, *Aesculus hippocastanum* L., a common ornamental species in Europe, being preferred in line for the rich shade it gives. The species was reported in Macedonia in 1985 around Lake Ohrid, very close to the border with Albania, and was described as a new species for science a year later. The true origin of the species is not yet known. The genus *Cameraria* is not represented by other species in Europe, but some species belonging to the genus are found in Asia and North America. This supports the hypothesis of the introduction of the species into Albania by Chinese travellers, and after the introduction of the species, the spread of adult birds began, with the expansion of the species area first in the states of the former Yugoslavia in the late 1980s (Skuhavy, 1999). Between 1993 and 1998 it expanded to the Czech Republic, Slovakia, Slovenia, Germany, Hungary, Switzerland and Poland, and between 2002 and 2004 it was reported in Great Britain, Spain, Russia and Denmark and Lithuania. In Romania, the presence of the insect was first reported in the western area of the country, in Timisoara, in 1996, in 1998 being also observed in the centre of the country, in Cluj-Napoca. In 2005, the insect was observed in Vaslui County, and since 2006 the insect fighting warning alerts have begun to be issued.

## Material and methods

To track the dynamics of the butterfly flight, were used the traps with specific pheromones of the Atra-CAM type. They were located in the research area, a trap for each location, park, and alignment. From May to September, readings were made at intervals of 2-4 days, depending on climatic conditions. At 6-week intervals, the pheromone inside the trap also changed (Augustin, 2004). The catches of each reading have been removed. This method was performed the curve of occurrence of butterflies adult and maximum flight course was carried out and the warning chart trebuias of the treatments applied against this pest.

## Results and Discussion

Moth mining of chestnut leaves, *Cameraria ohridella* Deschka & Dimic also represents a dangerous pest in the Husi-Vaslui area, which has spread and caused more and more damage every year.

### 1. THE NATURAL ENVIRONMENT AND THE PEDOCLIMATIC CONDITIONS IN WHICH RESEARCH HAS BEEN

Presentation in brief of Husi area, Vaslui county

The geographic and mathematical position of Husi is at the intersection of the parallel 46°41' north latitude and the meridian of 28°03' east longitude. Geographically, the city is located in the southwestern part of the Husi Depression, a part of the Central Moldavian Plateau, which falls on the Barlad Plateau, as a subdivision of the Moldavian Plateau in northeastern Romania.

In the south-north direction it is between the towns of Galați and Iași (about 130 km and 83 km respectively), and in the east-west direction is approximately equally between the towns of Barlad and Chisinau, at the boundary between the Russian plateau and the Dobrogea.

#### **Climate considerations of agricultural years 2014, 2015 and 2016.**

Analyzing the average temperatures, precipitation and relative humidity in the air during the three years, 2014, 2015 and 2016, during the vegetation period, the following are observed:

- in 2014-2015 (Table 1) the spring was warmer than the normal multiannual period with values between 1.9-3.9°C (March - May), the rainfall exceeded normal, with values between 11.2 mm (March) and 10.3 mm (May) and were below normal in April with a deficit of 11.3 mm, and the monthly average humidity was 74% (March) and 69% (April - May).

The summer is characterized by higher than normal multi-annual temperatures, with values ranging from 0.7 to 2.1°C, and the rainfall recorded a deficit in July and August between 14.22 and 22.3 mm, and in June Exceeded normal by 52.6 mm. September has recorded temperatures that exceeded the multi-annual by 1.1°C and rainfall by 46.3 mm. The absolute minimum temperature was -12.7°C, recorded on January 12; The absolute maximum was + 35.5°C recorded on July 29, and the last spring frost was on March 29, -2.0°C.

Table 1

**WEATHER INFORMATION SYSTEM AGROEXPERT in the agricultural year 2014 – 2015**  
 Agroexpert System Station “Sediu” – Huși

Month	Oct	Nov	Dec	Jan	Feb	Mar	Apr	May	Jun	Jul	Aug	Sep	Total	Vegetation period
Year	2014	2014	2014	2015	2015	2015	2015	2015	2015	2015	2015	2015	12 luni	(IV-IX)
TEMPERATURE(°C)														
Decade I	15,7	10,0	0,1	-4,3	1,7	13,1	8,3	20,0	17,6	20,8	23,2	16,2	11,8	17,7
Decade II	11,6	4,2	-5,6	-2,2	0,1	4,1	10,7	19,2	21,7	21,3	23,1	15,5	10,3	18,5
Decade III	9,6	5,0	-5,6	-2,9	1,7	1,2	17,5	18,6	22,5	21,8	19,9	11,9	10,1	18,7
Monthly average	12,3	6,4	-3,7	-3,1	1,2	6,1	12,1	19,2	20,6	21,3	22,0	14,5	10,7	18,3
Multiannual	9,9	4,2	-0,3	-3,3	-1,6	2,2	10,2	15,7	19,0	20,6	19,9	15,7	9,4	16,9
Deviation	2,4	2,1	-3,4	0,2	2,8	3,9	1,9	2,8	1,6	0,7	2,1	1,1	1,3	1,4
PRECIPITATION(mm)														
Decade II	2,0	46,4	91,4	0,0	32,2	0,8	11,6	0,0	48,8	32,4	0,0	7,2	272,8	100
Decade III	16,0	5,0	6,4	33	4,4	4,6	17,6	3,6	38,6	0,0	0,0	76,4	205,6	136,2
Monthly average	10,6	0,2	24,8	19,4	7,6	31,8	0,7	46,2	45,4	24,6	30,6	6,8	248,7	154,3
Multiannual	12,7	51,6	122,6	52,4	44,2	37,2	29,9	49,8	132,8	57,0	30,6	90,4	727,1	390,5
Deviation	28,6	30,3	27,4	22,8	23,8	26,0	41,2	60,1	80,2	71,2	52,9	44,1	508,6	349,7
Decade II	-15,9	21,3	95,2	29,6	20,4	11,2	-11,3	10,3	52,6	-14,2	-22,3	46,3	218,5	40,8
RELATIVE HUMIDITY (%)														
Decade II	69	83	90	85	86	73	75	54	81	74	60	69	75	69
Decade III	83	91	92	94	87	76	69	62	74	67	55	84	78	69
Monthly average	81	88	98	90	89	75	52	70	72	63	69	74	77	67
Multiannual	78	87	93	90	87	75	65	62	86	68	61	76	77	68
Deviation	76	78	80	82	81	74	69	69	70	70	71	74	74	70
Decade II	2	9	13	8	6	1	-4	-7	16	-2	-10	2	3	-2

Absolute minimum temperature: -12,7 °C = 12 January 2015

Absolute maximum temperature: + 35,2 °C = 29 July 2015

The first frost in the fall: - 2,5 °C = 15 November 2014

The last frost in the spring: - 2,0 °C = 29 March 2015

Table 2

**WEATHER INFORMATION SYSTEM AGROEXPERT in the agricultural year 2015 – 2016**  
 Agroexpert System Station “Sediu” – Huși

Month	Oct	Nov	Dec	Jan	Feb	Mar	Apr	May	Jun	Jul	Aug	Sep	Total	Vegetation period
Year	2015	2015	2015	2016	2016	2016	2016	2016	2016	2016	2016	2016	12 luni	(IV-IX)
TEMPERATURE(°C)														
Decade I	7,2	11,9	-0,1	2,1	-6,6	5,1	9,6	13,1	20,0	21,6	24,2	20,9	10,7	18,2
Decade II	11,9	7,6	-0,4	2,4	1,3	8,7	9,5	14,6	19,4	21,6	23,1	17,9	11,4	17,6
Decade III	12,1	6,6	0,8	-8,4	2,7	9,6	14,0	19,8	18,8	22,5	19,1	13,5	10,9	18,0
Monthly average	10,4	8,7	0,1	-3,9	-0,8	7,8	11,0	15,8	19,4	21,9	22,1	17,4	11,0	17,9
Multiannual	9,9	4,2	-0,3	-3,3	-1,6	2,2	10,2	15,7	19,0	20,6	19,9	15,7	9,4	16,9
Deviation	0,5	4,5	0,4	-0,6	0,8	5,6	0,8	0,1	0,4	1,3	2,2	1,7	1,6	1,0
PRECIPITATION(mm)														
Decade II	1,8	7,8	0,2	0,4	13,2	25,2	5,6	25,2	2,8	10,8	2,0	0,0	95,0	46,4
Decade III	6,8	0,8	2,0	14,4	6,6	3,4	83,2	86,2	9,6	79,0	2,4	0,0	294,4	260,4
Monthly average	0,0	30	0,0	16,6	5,2	1,4	3,4	67,6	7,8	63,0	10,0	8,6	213,6	160,4
Multiannual	8,6	38,6	2,2	31,4	25,0	30,0	92,2	179	20,2	152,8	14,4	8,6	603,0	467,2
Deviation	28,6	30,3	27,4	22,8	23,8	26,0	41,2	60,1	80,2	71,2	52,9	44,1	508,6	349,7
Decade II	-20	8,3	-25,2	8,6	1,2	4,0	51,0	118,9	-60,0	81,6	-38,5	-35,5	94,4	117,5
RELATIVE HUMIDITY (%)														
Decade II	76	80	67	95	92	88	61	73	72	90	62	49	75	69
Decade III	84	97	88	83	95	53	85	80	70	76	64	55	78	72
Monthly average	78	85	95	89	85	65	69	74	67	73	68	65	76	69
Multiannual	79	87	83	89	91	69	72	76	70	80	65	56	76	70
Deviation	76	78	80	82	81	74	69	69	70	70	71	74	74	70
Decade II	3	9	3	7	10	-5	-3	7	0	10	-6	-18	2	0

Absolute minimum temperature: -21,8 °C = 31 January 2016

Absolute maxim temperature: + 35,7 °C =12 august 2016

The first frost in the fall: - 1,6 ° C = 20 october 2015

The last frost in the spring: - 1,6 ° C = 30 marts 2016

- in 2015-2016 (Table 2) the spring was warmer than the normal multiannual period with values between 0.1 - 5.6°C (March - May), precipitation exceeded normal, with values of 4.0 mm in March, 51.0 mm in April and 118.9 mm in May, and the monthly average relative humidity had values below the multiannual average in March and April (-5, respectively, -3 units) and were over multiannual in May with more 7 units.

- The summer is characterized by temperatures that did not exceed the much normal multiannual values, with values ranging from 0.4 - 2.2°C, and the precipitations recorded a deficit in June and August between -60.0 mm and -38, 5 mm, and in July they exceeded normal by 81.6 mm. The month of September recorded temperatures that exceeded the multiannual by 1.7°C and the rainfall had a deficit of - 35.5 mm.

## 2. CONSIDERATIONS ON THE BIOLOGICAL CYCLE AND DYNAMICS OF ADULT FLIGHT *CAMERARIA OHRIDELLA* DESCHKA DIMIČ

The research carried out during the two years was aimed at studying the biological cycle, the dynamics of adult flight, and influencing climatic factors on the species *Cameraria ohridella* Deschka Dimič in order to issue warning bulletins by proposing chemical treatments as measures to limit the population, Climate in the Huși area, Vaslui County.

For the pursuit of *Cameraria ohridella* adult flight, pheromone traps, Atra-CAM, were used. Thus, a trap / location was used, and baits were changed monthly from May to September 2015 and 2016. Adult flight performance ratings were made 3 times a week.

In order to correlate the data obtained with the meteorological data, the sums of the actual temperature ranges (over 12°C.) were calculated for each stage of evolution.

### Dynamics of *Cameraria ohridella* Deschka Dimič adult flight in Husi village in 2015

In 2015 (Table 3), the first generations of the third (hymnal) generation appeared on 05.05, at a  $\Sigma (t_n - t_o) = 118.06^\circ\text{C}$ . The adult adult flight lasted 15 days, between May 12 and June 3, and peaked between May 23 and 26. After June 6, adult flight began to decline, so that for 3 days, June 15-18, there was no flight. Third-generation (G3) adult flight lasted 38 days (04.05-12.06).

Table 3

Flight Dynamics *Cameraria orridella* Deschka Dimič in 2015

G3		G1		G2	
Adult appearance	Adults captured	Adult appearance	Adults captured	Adult appearance	Adults captured
5.05	6	17.06	89	04.08	210
6.05	9	23.06	90	06.08	320
9.05	118	25.06	130	09.08	330
12.05	168	28.06	166	12.08	310
15.05	175	01.07	380	15.08	291
18.05	188	03.07	400	18.08	173
21.05	210	06.07	278	21.08	155
23.05	320	09.07	290	23.08	100
26.05	290	12.07	120	25.08	95
29.05	110	15.07	89	28.08	89
31.05	130	18.07	80	31.08	67
03.06	125	21.07	60	03.09	50
06.06	100	23.07	55	06.09	36
09.06	71	25.07	44	09.09	12
12.06	72	31.07	32	12.09	5
15.06	-	01.08			
$\Sigma(t_n - t_o)$	Flight duration	$\Sigma(t_n - t_o)$	Flight duration	$\Sigma(t_n - t_o)$	Flight duration
110,55 <sup>0</sup> C	38	446,80 <sup>0</sup> C	-	1072,65 <sup>0</sup> C	44

### Dynamics of adult flight of *Cameraria ohridella* Deschka Dimič in Huși, 2016

Butterflies of generation I-a (G1) started the flight on 19.06, at a  $\Sigma (t_n - t_o) = 446,80^\circ\text{C}$ . The adult flight lasted 18 days, between 28 June and 15 July, and the maximum flight was

recorded between 01.06 and 09.07. After 15.06, the flight began to drop, so it overlapped the second generation. The flight time of the first generation cannot be said with precision.

Adults of the second generation appeared on 04.08, at a  $\Sigma (t_n - t_0) = 939.23^\circ\text{C}$ , the flight was recorded between 04-21.08, for 22 days and the maximum was recorded 06-15 August, for 9 days. Adult flight of the 2nd generation (G2) lasted 38 days (04.08 - 12.09) and overlapped with adults of the 1st generation.

In 2016, the first captured adults of the 3rd generation (hymnal) appeared on 10.05, at a  $\Sigma (t_n - t_0) = 85.25^\circ\text{C}$  (Table 4). The adult flight was between May 21 and June 6, for 20 days.

Table 4

**Dinamica zborului *Cameraria ohridella* Deschka Dimič, în anul 2016**

G3		G1		G2	
Adult appearance	Adults captured	Adult appearance	Adults captured	Adult appearance	Adults captured
10.05	<b>30</b>	<b>29.06</b>	157	<b>11.08</b>	100
12.05	50	01.08	166	13.08	<b>320</b>
15.05	122	03.07	<b>186</b>	15.08	<b>300</b>
18.05	180	06.07	<b>381</b>	18.08	<b>310</b>
21.05	<b>315</b>	09.07	<b>400</b>	21.08	<b>192</b>
23.05	<b>388</b>	12.07	<b>378</b>	23.08	<b>173</b>
25.05	<b>310</b>	15.07	<b>290</b>	25.08	<b>125</b>
28.05	<b>260</b>	18.07	<b>220</b>	28.08	<b>100</b>
31.05	<b>350</b>	21.07	<b>200</b>	31.08	95
03.06	<b>110</b>	23.07	<b>190</b>	03.09	71
06.06	<b>100</b>	25.07	<b>160</b>	06.09	13
09.06	81	28.07	75	09.09	12
12.06	18	31.07	50		
15.06	17	03.08	55		
18.06	15	06.08	33		
21.06	-	09.08	24		
25.06	-				
<b>27.06</b>	-				
$\Sigma(t_n - t_0)$	Flight duration	$\Sigma(t_n - t_0)$	Flight duration	$\Sigma(t_n - t_0)$	Flight duration
52,95 <sup>0</sup> C	41	362,36 <sup>0</sup> C	-	783,42 <sup>0</sup> C	27

Flight flight in May was influenced by heavy rainfall for 16 days when 179 mm precipitation occurred. After June 10, adult flight began to decline, so that for 3 days 22 -25 June, no flight was scheduled. The Third Generation Flight (G3) Flight lasted 39 days (10.05 - 18.06).After 25.07, the flight began to decline, but it did not stop, so it overlapped the second generation.

Adults of the second generation began to appear on 11.08, at a point  $(t_n - t_0) = 833.96^\circ\text{C}$ , the flight took place between 13 and 28.08 for 15 days and the maximum flight curve was recorded during the 13 - August 18. Adults flew until 9 September.

**Conclusions**

To monitor the flight dynamics of *Cameraria ohridella* adults, sex-specific Atra-CAM traps were used. So:

in 2015, third-generation adult flight (G3) lasted 38 days; The large flight lasted 15 days between 12 May and 03 June and peaked during the period 23-26 May when 320 and 290 butterflies were collected. For the first generation (G1), the adult flight lasted 18 days between June 28 and July 15, and the maximum flight was recorded on 01 and 03 July. After 15.06, the flight began to drop, but it did not stop, so it overlapped the second generation; The flight of the second generation was recorded during the period 04-21.08 for 22 days and the maximum was recorded during the period 06-15 August for 9 days.

In 2016, the adult flight of the third-generation (third) generation was between May 21 and June 6, for 20 days, the maximum was recorded on May 23. Third-generation (G3) adult



flight lasted 39 days. For generations I (G1), the flight took place between 03 and 25 July, for 22 days and a maximum flight between 06 and 12 July. The flight of adults of the first generation (G1) overlaps the raid of adults of the 2nd generation. Generation II (G2) had a large flight between 13 and 28.08, for 15 days, and the maximum flight curve was recorded during the 13th - August 18 and flew until September 9.

In 2015, temperatures were higher than the normal multiannual temperature, so the absolute minimum temperature was -12.7 After 25.07, the flight began to decline, but it did not stop, so it overlapped the second generation and the absolute maximum was + 35.5°C and the rainfall had a deficit in the months July and August between 14.22 and 22.3 mm.

The year 2016 is characterized by temperatures that did not exceed the much normal multiannual, so the absolute minimum temperature was -21,8 °C and the absolute maximum was + 35,7 °C and the rainfall had a deficit of - 35 , 5 mm.

### References

- Augustin, S., et al (2004). Monitoring the regional spread of the invasive leafminer *Cameraria ohridella* Deschka & Dimic (Lepidoptera: Gracillariidae) by damage assessment and pheromone trapping. *Environ. Entomol.* 33(6), 1584p.
- Ene, M. (1979). Determinator pentru dăunătorii forestieri după vătămări. Editura Ceres, 518 p.
- Pelov V., Tomov R., Trenchev G. (1993). *Cameraria ohridella* Deschka et Dimic (Gracillariidae, Lepidoptera) - new pest on the horse chestnut (*Aesculus hippocastanum*) in Bulgaria. National scientific-technical meeting on forest protection. 30 March, 1993, Sofia, 95p.
- Perju, T., Oltean, I., Oprean, I., Ecobici Monica, (2004) The pests of horse chestnut tree – *Aesculus hippocastanum* L. in Romania. *Journal of Central European Agriculture* 4 (5): 331p.
- Savescu A., Rafaila C., (1980)– Prognosis in plant protection. Editura Ceres, Bucuresti.
- Rakosy L., Goia M. & Kovacs Z. 2003 - Catalogul Lepidopterelor României / Verzeichnis der Schmetterlinge Rumaniens. *Soc. Lepid. Rom. Cluj-Napoca.* 446 p
- Skuhravy, V. V., 1999- Zusammenfassende Betrachtung der Kenntnisse über die Roskastanienminiermotte *Cameraria ohridella* Desch. & Dim. (Lep., Gracillariidae). *Anz. Schädlingskunde* 72, 95p.

## YIELDS AND PATOGENS OF NEW VARIETIES OF BARLEY AND WHEAT DURING 20016 IN DOBROGEA REGION OF ROMANIA

Vasile JINGA<sup>1\*</sup>, Carmen LUPU<sup>1</sup>, Anamaria GIUMBA<sup>2</sup>, Dumitru MANOLE<sup>2</sup>

<sup>1</sup>Research-Development Institute for Plant Protection, Bucharest, Romania

<sup>2</sup>S.C. SPORT AGRA S.R.L. Amzacea, Constanța, Romania

\*Corresponding author: vasilejinga23@gmail.com

### Abstract

The paper aimed to present the main pathogens of two-rowed barley and wheat crops and the yields obtained in 2016 at S.C. SPORT AGRA SRL Amzacea, Constanța district (Romania) on demonstrative plots. Climatic conditions of autumn 2015 and spring 2016 provided a favorable development of the crops. Protection against foliar diseases of the two grain crops was done using three fungicides treatments with Bumper 250 EC, Artea 330 EC and Prosaro 250 EC, no attack of powdery mildew (*Blumeria graminis*) was registered. The attack of *Rhynchosporium secalis* and *Pyrenophora tritici-repentis* in two-rowed barley presented a low level. On wheat, the pathogens *Septoria tritici* and *Pyrenophora tritici-repentis* had low attack levels, except the cultivars Hybiza, Hylux and Avenue with higher attack. The pathogen *Puccinia striiformis* had the lowest values of attack, except the variety Avenue and Pescador. Concerning the correlation between the yields and the pathogens incidence and severity, the lowest yields in wheat crop were obtained with Hybiza (4740 kg/ha) and Avenue varieties (4860 kg/ha). The highest yields were obtained with Genius (8401 kg/ha) and Katarina varieties (8400 kg/ha). For two-rowed barley crop, the lowest yield was 8450 kg/ha for Wendy variety and the best yields were 8800 kg/ha for Henriette variety. Quality indices of wheat grains were between 74.6 for Hylux variety and 81.0% hectoliter mass for WinterGold variety.

**Key words:** *yield, pathogen status, barley varieties, wheat varieties, Dobrogea region, Romania*

### Introduction

In the last 7 years, various grain varieties created by foreign companies have been placed in cultivation without being deeply known their behavior in the climatic conditions of the Romanian district, Dobrogea. Romanian varieties of winter grains occupies a percentage of more than 70% of the cultivated area (Roman Gh. V. et al., 2011). The paper aimed to present the main pathogens of two-rowed barley and wheat crops and the yields obtained in 2016 at S.C. SPORT AGRA SRL Amzacea, Constanța district, on demonstrative plots. 15 varieties of wheat, 3 varieties of two-rowed barley were analyzed regarding their behavior in the climatic conditions from Amzacea area, in agricultural year 2015-2016. The efficiency of integrated control is directly dependent on the biology of the pest, parasite-host plant relationship, being influenced by climatic conditions that characterize a particular crop area or a certain stage of the plant vegetative cycle (Jinga V. et al. 2010, 2014).

## Materials and methods

Experience has been placed on S.C. SPORT AGRA S.R.L. Amzacea, Constanta. The studied crops are winter crops: two-rowed barley and wheat. The experience was situated on a land belonging to the South Dobrogea plateau, represented by cambic chernoziom with a profile deeper than other chernozioms, a blackish-brown soil of 40-50 cm thickness, medium texture (Demeter T., 2009). The content of nutrients was: mobile P index - 72; N index - 4; Humus - 3.11; K index - 200; Neutral pH - 7.2. The climate is deeply temperate continental, with an average annual temperature of 10.7 - 11.7 °C, with a high temperature in the period 20th June to 15th August. Quantity of precipitations during the vegetation period was presented in Table 1.

Table 1. Precipitation during 2015/2016 growing season of barley and wheat (Valul lui Traian Station, Constanta)

	Month											
	Oct.	Nov.	Dec.	Jan.	Febr.	March	Apr	May	June	July	Aug.	
	The growing season 2015/2016: Precipitation (mm) for 10-day periods											Sum
1-10	32.0	0	0	0	12.0	10.0	0	60.0	3.5	56.0	4.0	177.5
11-20	36.0	5.0	12.0	95.0	18.5	19.0	0	21.0	20.0	0	0	226.5
21-30	25.0	11.0	10.0	15.0	0	15.0	20.0	16.0	0	0	0	112.0
Sum	93.0	16.0	22.0	110.0	30.5	44.0	20.0	97.0	23.5	56.0	4.0	516.0
	Average 1961-1990 : monthly values of precipitation (mm)											Sum
	34,3	42,4	41,0	27,7	24,0	29,1	31,8	37,7	47,1	38,9	37,4	464,0
	The growing season 2015/2016: Mean air (°C) for 10-day periods											Mean
1-10	14,2	11,4	6,2	2,5	4,1	6,8	10,3	13,9	19,8	22,6	23,2	12,27
11-20	13,3	11,2	4,4	4,8	5,2	7,9	12,9	16,8	21,4	24,2	22,6	13,15
21-30	12,2	10,8	2,1	4,3	5,4	10,2	13,5	18,7	22,1	23,8	21,4	13,13
Mean	13,2	11,1	4,2	3,9	4,9	8,3	12,2	16,5	21,1	23,5	22,4	12,85
	Average 1961-1990 : monthly values of mean air temperature (oC)											Mean
	11,5	6,5	2,1	0,4	0,9	4,4	9,7	15,3	19,4	21,9	16,9	10,8

This area is the most arid in the country, with 69-year multi-annual average rainfall of 401 liters. Sowing was carried out on 16th October 2015. Treatment of seeds was carried out with Yunta Quattro 373,4 FS (clotianidin 166.7 g/l + imidacloprid 166.7 g/l + protioconazol 33.3 g/l + tebuconazol 6.7g/l) in dose of 1.6 l / ton. Due to the climatic conditions of the year 2016, for the prevention and control of foliar and ear diseases, 3 treatments were performed: Treatment I (14 April) – Bamper 250 EC (propiconazol 250 g/l), 1 l/ha; Treatment II (2 may) – Artea 330 EC (cyproconazole 80 g/l + propiconazol 250 g/l) 0.4 l / ha; Treatment III (21 may) – Prosaro 250 EC (tebuconazole 125 g/l + protioconazole 125 g/l) 0.75 l / ha. Karate Zeon 50 CS (lambda-cyhalothrin 50 g/l), at a dose of 0.75 l/ha were used for specific pest control.

The attack rate was calculated with the formulas  $RA = F \times I / 100$  ( F% –frequency of the attacked organs, I % -intensity of organs' attack).

## Results and discussions

Observations on phytosanitary status of winter crops and collections of biological samples were made on April 2016 (table 2). Technological elements such as: prior crop, basic fertilization, sowing date, amount of seed, emergence date, and plant density were presented in table 3. Due to the high rainfall throughout during April and May, the attack of pathogens that cause diseases in cereal crops was very aggressive, requiring the 3 pesticides treatments. It can be seen that all three treatments reduced the intensity of the attack. Pathogen attack of

*Rhynchosporium* and *Pyrenophora* on two-rowed barley presented a RA (degree attack) low (0.6-2.1%). In the wheat crop, the pathogens *Septoria* and *Pyrenophora* showed attacks low (2-3%), except varieties Hylux (6.4%, 7.0%, respectively) and WinterGold (8.1%, 5.6 %respectively), with greater attack. *Puccinia striiforme* pathogen presented low levels of attack (1.5%), except the variety Avenue (2.5%).

Figures 1-3 distribution:



Fig 1-3: Autumn grain crops – field trial (left) and phytosanitary status (middle and right)

Table 2. Autumn cereals phytosanitary status

Variety	<i>Rhynchosporium secalis</i>			<i>Pyrenophora teres</i>			<i>Pyrenophora graminis</i>		
	F (%)	I (%)	RA (%)	F (%)	I (%)	RA (%)	F (%)	I (%)	RA (%)
<b>TWO-ROWED AUTUMN BARLEY</b>									
Metaxa	50	3	1.5	60	3	1.8	-	-	-
Wendy	30	2	0.6	70	3	2.1	-	-	-
Henriette	20	4	0.8	40	3	1.2	30	3	0.9
<b>WHEAT</b>									
Variety	<i>Septoria</i> sp.			<i>Pyrenophora graminis</i>			<i>Puccinia striiforme</i>		
	F (%)	I (%)	RA (%)	F (%)	I (%)	RA (%)	F (%)	I (%)	RA (%)
Katarina	20	5	1.0	30	5	1.5	-	-	-
Petur	50	8	4.0	60	9	5.4	-	-	-
Genius	60	3	1.8	50	7	3.5	-	-	-
Joker	30	5	1.5	40	5	2	-	-	-
Mulan	30	2	0.6	20	5	1	30	2	0.6
Felix	40	10	4.0	25	10	2.5	30	5	1.5
Hyty	30	3	0.9	20	5	1	-	-	-
Hybiza	50	3	1.5	60	8	4.8	-	-	-
Hylux	80	8	6.4	70	10	7	-	-	-
Avenue	50	2	1.0	60	3	1.8	50	5	2.5
Soobel	50	10	5.0	40	5	2	-	-	-
Sofru	70	10	7.0	80	3	2.4	-	-	-
Solveg	60	5	3.0	70	10	7	-	-	-
WinterGold	90	9	8.1	70	8	5.6	-	-	-
Pescador	50	3	1.5	60	10	6	30	5	1.5

Table 3. Tehnological sheet for autumn crops

Variety	Seed norm (kg /ha)	Date of sowing	Emergence date	Number of plants in the emergence	Number of plants in the spring	Yield (kg / ha)	Quality index U % M HI	
TWO-ROWED BARLEY								
Metaxa	180	19-Oct	28 oct	284	584	8612	13.1	64.0
Wendy	180	19-Oct	28 oct	288	620	8450	12.6	64.2
Henriette	180	19-Oct	28 oct	292	640	8800	12.3	65.0
WHEAT								
Katarina	220	19-Oct	29 oct	372	736	8400	14.8	79.1
Petur	220	19-Oct	29 oct	356	704	8000	14.4	76.4
Genius	220	19-Oct	29 oct	344	680	8401	14.3	80.6
Joker	220	19-Oct	29 oct	372	712	8040	14.7	79.9
Mulan	220	19-Oct	29 oct	352	700	7340	14.1	79.1
Felix	220	19-Oct	29 oct	368	720	6800	14.4	77.0
Hyfi	80	19-Oct	29 oct	152	692	7140	14.5	81.0
Hybiza	80	19-Oct	29 oct	232	670	4740	14.2	76.7
Hylux	80	19-Oct	29 oct	212	682	5465	14.7	74.6
Avenue	180	19-Oct	29 oct	348	696	4860	14.1	75.4
Soobel	180	19-Oct	29 oct	336	672	6702	14.4	80.1
Sofru	180	19-Oct	29 oct	368	700	7544	14.6	77.5
Solveig	180	19-Oct	29 oct	352	684	7122	14.5	77.0
WinterGold	180	19-Oct	29 oct	356	700	6500	14.4	81.0
Pescador	180	19-Oct	29 oct	348	690	6245	14.6	80.0

After the 3 fungicide treatments, foliar diseases were stopped at basal leaves (Figure 2 with details). The last 3 leaves and the ear were protected due to phytosanitary treatments. It contributed to the achievement of high productions of about 8 tons in the two-rowed barley and 4 wheat varieties. Data on yields obtained in experimental plots are shown in Table 3. For two-rowed barley crop, the lowest yield was 8450 kg/ha for Wendy variety and the best yields were 8800 kg/ha for Henriette variety . Quality index 64,0-65,0 The highest yields in wheat were obtained with Genius (8401 kg/ha) and Katarina varieties (8400 kg/ha). Quality indices of wheat grains were between 74.6 for Hylux variety and 81.0% hectoliter mass for WinterGold variety.

### Conclusions

To prevent and control the pathogens that cause diseases in autumn cereal crops were necessary, in climatic conditions of the 2016 year, 3 treatments with fungicides. *Rhynchosporium* and *Pyrenophora* pathogens showed a low degree attack to two-rowed barley. In wheat crop, pathogens *Septoria* and *Pyrenophora* showed reduced attack degrees, as the pathogen *Puccinia striiforme*. The yields obtained in conditions of 2016 ranged from between 8450-8800 kg / ha and quality index 64,0-65,0 for two-rowed barley , and yield between 4740 to 8401 kg / ha for wheat. For all varieties analyzed, hectoliter weight was influenced by rainfall, showing values between 74.6 to 81MHL.

### **Acknowledgements**

This research work was carried in the Scientific Research and Development Contract no. 372 / 18.05.2016 with S.C. Sport Agra SRL Amzacea, Constanta county.

### **References**

- Demeter T.,2009,General pedology, Credis Ed. Bucharest.
- Jinga V., Iliescu H., Stefan S., Sandru L., Andrei A.M., Lixandru M., Lazureanu C., 2010. Pathogens in early stages of winter barley crops - prevention and control. rdipp.ro vol .2.
- Jinga V., Manole T., Gradila M, Dudoiu R., Giumba A.M., Manole D., 2014. Phytosanitary status of autumn cereals in Dobrogea, Romanian Jurnal for Plant Protection,<http://www.ripp.ro/index.php/archive/2014>,on line.
- Roman Gh.V., V. Tabără, T. Robu, P. Pîrşan, M. Ştefan, M. Axinte, Gv. Morar, S. Cernea, 2011. Phtotechnics-Vol I , Cereals and pules for grains. University Publishing Hause, Bucharest.
- Sorheţ C., Borcean I., 2009. Research concerning the behaviour of some winter wheat cultivars with differentiated fertilisation in the flooding valley of the Mureş river. Research Journal of Agricultural Science, 41.

## **EFFECT OF EPIN EXTRA REGULATOR ON DEVELOPMENT OF BARLEY GROWING ON Cd-CONTAMINATED SOIL**

Nadezhda LOI\*, Natalya SANZHAROVA

Russian Institute of Radiology and Agroecology, Obninsk, Russian Federation

\*Corresponding author: loy.nad@yandex.ru

### **Abstract**

Chemical plant protection products, in particular herbicides, whose action can be considered as a kind of stress for the plants, can have a depressive effect on culture. The use of plant growth regulators in the cultivation of grain crops is aimed to obtain agricultural products with a minimum content of toxic and hazardous substances and improving the environmental situation. A presowing treatment of barley seeds, Elf variety, by the growth regulator Epin extra, when herbicide Agritox used for the crop cultivation, significantly increases the root index of plants both growing on soils with the background and increased Cd concentrations. At the same time the using of the growth regulator does not reduce a depressive effect of the herbicide on the photosynthetic activity of 30-day plants. The presence of Cd in soil in high concentration does not significantly affect the accumulation of K and Ca by 30-day plants, and at the same time increases the Mg content in plants. Using of herbicide Agritox leads to a decrease in the productivity of barley varietie Elf on 9-13% when plants grow on soil with the background concentrations of Cd. The shortage of the crop is due to a decrease in the number of grains and their mass in the lateral shoots. High content of Cd ions in soils reduces negative effect of herbicide Agritox. Using plant growth regulator Epin extra does not lead to significant changes in the yields of barley of Elf variety.

**Keywords:** *Growth regulator, Epin extra, Development of barley, Cadmium, Herbicide.*

### **Introduction**

The result of human economic activity is an increase in the technogenic burden on agroecosystems and an increase in the concentrations of pollutants in agricultural soils. Toxicity of heavy metals (HMs) for living organisms are defined as properties and level of concentration of the elements themselves, and their migration ability in various ecosystem components, as well as the degree of accumulation in the tissues and organs of animals and plants (Ulyanenko et al., 2004). It is known that Cd is one of the most phytotoxic pollutants, possessing with a high potential to accumulate in biological objects and having a resemblance to the physiologically important organic compounds in a vegetative organism. The underlying mechanism of toxicity to plants connected with the change of enzyme activity and a violation of metabolic reactions, resulting in the inhibition of photosynthetic processes in the early stages of ontogenesis (Melnychuk, 1990; Chernykh et al., 1999). Wide application in agriculture of various protection Drugs and plants growth regulators (PGR), most of which are biologically active substances (BAS), can lead to changes in absorption plants ions HM (Kabata-Pendias et al., 1989). However, it is known that the use of biologically active substances in processes is designed to ensure the mobilization of nutrients from the soil, change the availability of nutrients, have an impact on migration of easily movable substances, reduce the negative impact on surroundings agrochemicals. Modern technologies of cultivation of grain crops are focused on reception of agricultural production with the

minimum maintenance of toxic and dangerous substances and improvement of ecological conditions. Chemical plant protection products, in particular herbicides, whose action can be considered as a kind of stress for the plant organism, can have a depressive effect on culture. Marked selectivity of action the drugs (Nemchenko, 1994). For example, exceeding the recommended rate of herbicide consumption with the active substance diethylethanolammonium salt, exerted a depressing effect on wheat and maize, but practically did not affect barley plants. The addition of sodium Humate (at a concentration of 0.001%) to the tank mixtures contributed to a decrease of the herbicide inhibitory effect on plants. The purpose of our research was to study the possibility of using the plant growth regulator (Epin extra, S) in order to reduce the negative effect of increased Cd in the soil on the development of barley, when treated with herbicide Agritox, WC.

### Material and Methods

The studies were carried out in a vegetation experiment on spring barley (*Hordeum vulgare* L.) of the Elf variety. The plants were grown in vessels with a capacity of 5 kg sod-podzolic medium loamy soil, containing:  $RN_{KCl}$  - 6.4 mg-eq / 100 g soil; Humus - 2.1%;  $P_2O_5$  - 23.0,  $K_2O$  - 17.0 mg / 100 g of soil.

To ensure the normal development of plants before planting, mineral fertilizers were introduced into the soil in the form of aqueous solutions of  $NH_4NO_3$ , KCl and  $KH_2PO_4$  salts at the rate of N - 1.0 g,  $K_2O$  - 0.7 g and  $P_2O_5$  - 0.7 g per 5 kg of soil (Zhurbickiy, 1968).

Simultaneously with the introduction of batteries into the soil, Cd was added as a solution of the  $Cd(NO_3)_2 \cdot 4H_2O$  salt at a dose of 20 mg / kg soil (designation  $Cd_{20}$ ).

The seeds were pre-treated on a laboratory rotor RVO-64 in all variants of the trial with fungicide Baitan universal, WP (flow rate 2 kg / t) and in some variants (according to the experiment scheme) by the plant growth regulator Epin extra, S (a.s. Epibrassinolide). Epin extra increases the energy of germination of seeds, stimulates the immune system of plants, increases resistance to pathogens and rots, neutralizes the effect of nitrates, HM, radionuclides and other stressful situations. The application rate of the preparation for seed treatment is 200 ml / ton of seeds (Directory of...2015). In the tillering phase, barley plants were treated with herbicide Agritox, WC (a.s. - dimethylamine + potassium + sodium salt, mixture) at a rate of 1.5 l / ha (Directory of...2015).

The scheme of the experiment included five options: 1 - control without seed treatment by the plant growth regulator and without herbicide application (C); 2 - treatment of plants in the tillering phase with a herbicide (H); 3 - presowing seed treatment with the Epin extra preparation, S (hereinafter "Epin") + treatment of plants in the tillering phase with herbicide (E + H); 4 - treatment of plants with a herbicide against the background of Cd ( $Cd_{20}$  + H); 5 - presowing seed treatment by Epin + treatment of plants with herbicide against the background of Cd ( $Cd_{20}$  + E + H). Repeatability is threefold.

During the vegetation period, phenological observations were carried out and the morphometric parameters of plant development (developmental phase, height, leaf surface area (ALS)), raw and air-dry plant masses and water retention capacity were determined. The height of the plants was measured from the soil surface to the end of the last leaf, and, beginning with the stage of earing, to the end of the ear. The plants were selected for analysis (5 per each vessel) at the beginning of the tube exit (30 day old plants) and in the earing phase (60 day old plants).

The morphological indices (Piankov et al., 2000) were calculated: leaf (ratio of the leaves mass to mass of the whole plant), root (ratio of the mass of the underground organs to the mass of whole plant), stem (ratio of the stems mass to the mass of the whole plant) and generative (Generative organ to the mass of the whole plant).



The content of macroelements (Mg, K, Ca) and Cd in 30-day-old barley plants after "wet" ashing was determined by atomic absorption spectrophotometry in an air-acetylene flame using a Perkin-Elmer device.

For the statistical processing of the results by the dispersion method, the Microsoft Excel 97 software package was used..

### Results and Discussion

In the process of monitoring the growth and development of barley during the growing season (from shoots to harvesting), there were no significant differences in the dynamics of changes in plant height when the herbicide Agritox was used and without it (variants C and H).

When growing barley in soil contaminated with Cd at a concentration of 20 mg / kg - about 10 MPC (variant Cd<sub>20</sub> + H), a slowing down of the stages of organogenesis of plants (in comparison with option C) was noted. This was reflected in the height of the plants at the beginning of the earing phase (a decrease of 8-15%). However, at the time of harvesting, the height of the plants when grown on contaminated soil exceeded by an average of 10% the height of the plants in variants with a background content of Cd in the soil. Presowing seed treatment with Epin did not have a positive effect on the height when plants were grown both on the background (E + H) and on the increased Cd content in the soil (Cd<sub>20</sub> + H + E). Analysis of datas from 30 daily plants (Table 1) revealed a statistically significant decrease, compared to the control, of the leaf surface index (ILS) in the variant where barley in the tillering phase was treated with Agritox. In this case presowing seed treatment with the Epin regulator did not reduce the negative effect of the herbicide on the intensity of photosynthetic processes: the incidence of ILS was noted to be 13% with respect to control (the differences were significant at P = 0.05).

Table 1. Indicators of development of 30-days barley plants (development phase - the beginning of the exit into the tube)

Option	ILS (%)	Weight of one plant (g)		Relative content water (%)
		Wet	Dry	
C	66.7	3.9	0.6	84.7
H	59.4*	4.2	0.7	84.4
E + H	57.9*	3.5	0.6	83.2
Cd <sub>20</sub> + H	62.7	3.7	0.6	84.0
Cd <sub>20</sub> + H + E	63.3	3.6	0.6	83.8
SSD <sub>05</sub>	4.6	0.9	0.1	1.7

Here and below: \* - differences with control data are significant at P = 0.05

At the same time, when growing barley in soil contaminated with Cd, no significant effect of Agritox on the photosynthetic activity of 30-day plants was detected, according to the ILS. The growth regulator (Epin) did not introduce additional changes in the value of the indicator. Thus, the negative effect of herbicide application was more significant than the increased content of Cd (about 10 MPC) in the soil.

The treatment of barley with a herbicide, regardless of the presence of Cd in the soil, did not affect the wet and dry biomass, as well as the water retention capacity of plants.

An analysis of the results from development of 60 daily barley plants (spike) showed that presowing seed treatment of PGR ambiguously influenced the morphological development indices. The use of Epinum promoted the root growth index by 6-38% in herbicide variants, regardless of the chemical toxicant content in the soil. In the same variants of the experiment, a decrease in the stem index (by 5%) was noted with no effect on leaf and generative indices

(Table 2). Consequently, the use of the herbicide contributed to an increase in the mass of the roots and a decrease in the weight of the stems.

Table 2. Characteristics of the growth of 60 daily barley plants (development phase - earing)

Option	Plant indices (%)			
	Root	Cauline	Sheet	Generative
C	3.4	61.3	28.6	6.7
H	5.0	60.0	26.3	8.7
E + H	6.3*	58.1*	28.2	8.4
Cd <sub>20</sub> + H	5.3	59.6	28.5	6.5
Cd <sub>20</sub> + H + E	6.9*	58.4*	28.7	6.0
SSD <sub>05</sub>	2.3	2.8	2.7	3.1

The increase of the root index as a result of preseedling seed treatment by Epin is of great importance for the resistance of barley plants to disease control. Plants that have a powerful root system are more enduring to the development of root rot (Geshele, 1971). This indicator breeders are used when selecting plants to create resistant to root rot varieties.

Decrease in the stem index in variants with the use of Epin, in comparison with the control (without negative influence on the development of the generative index), indicates the possibility of using the growth regulator Epin on tall barley varieties in order to reduce their height, i.e. Preseedling seed treatment by Epin, can be a preventive method of combating barley lodging.

It is known that at the same concentration of Cd in the soil, its absorption by different plants can vary greatly. Plants relatively easily absorb from 0.4 to 7% soluble Cd, which is not immobilized in the root system, but moves in the plant, concentrating in different organs in different organs (Lukin et al., 2004). The accumulation of Cd in plants in excess concentrations leads to an imbalance of nutrients, causes a disruption in the synthesis and functions of many physiologically active compounds, as a result of which the intensity of the accumulation of macroelements by plants is changed (Kabata-Pendias et al., 1989).

In our experience, statistically significant differences in the accumulation of Cd in 30 daily barley plants were not detected (Table 3). The presence of Cd in elevated concentrations in the soil did not significantly affect the accumulation of 30 daily plants by K and Ca, while increasing the magnesium content in plants. Mg is an integral part of chlorophyll, and its lack can reduce the photosynthetic activity of plants (Lukin et al., 2004). This correlates with the value of barley ILS when grown on contaminated soil (control level) and with a background metal content below control (Table 1).

Epin did not significantly affected the supply of macroelements from the soil to the plants in the early phases of their development (Table 3).

As is known, the general orientation and magnitude of the effects revealed at the early stages of plant development (at the age of 30 days) and observed at the stage of crop formation are well correlated (Annenkov et al., 1991). This justifies the use of the results obtained on 30 day plants to predict the content of macroelements and Cd in the barley crop.

Table 3. Concentration of macronutrients and Cd in 30-days-old barley plants

Option	Concentration of macroelements (mg / kg x 10 <sup>-3</sup> ):			Concentration of Cd, mg / kg
	K	Ca	Mg,	
C	9.6	13.5	2.0	1.6
H	9.6	12.4	2.1	1.7
E + H	8.2	12.7	2.1	1.6
Cd <sub>20</sub> + H	8.3	12.3	2.2*	56.0*

Cd <sub>20</sub> + H + E	6.8	14.3	2.4*	59.5*
SSD <sub>05</sub>	3.3	3.1	0.2	8.6

By analyzing the structure of barley yield of Elf grade, has been concluded that its productivity was reduced (by 9-13%) in variants using the Agritos herbicide when growing Cd content in soil at the background level (Table 4).

Table 4. Structure of barley yield of Elf (average per plant)

Option	Main Escape			Side shoots	
	The length of the ear (cm)	Number of grains (PC)	Grain weight (g)	Number of grains (PC)	Grain weight (g)
C	7.61	22.67	1.11	22.90	0.92
H	7.65	22.50	1.16	15.62*	0.69*
E + H	7.71	22.19	1.06	16.27*	0.69*
Cd <sub>20</sub> + H	7.96	22.69	1.14	19.21	0.79
Cd <sub>20</sub> + H + E	7.63	22.22	1.11	19.69	0.80
SSD <sub>05</sub>	0.49	1.84	0.11	4.94	0.18

The increased amount of Cd ions in the soil neutralized the negative effect of the herbicide, and the use of Epin did not lead to any changes in the yield of barley of the Elf variety.

### Conclusions

Application of the plant growth regulator Epin for the presowing treatment of barley seeds of the Elf variety contributes to a reliable growth of the root and decrease of the plant stem index when processing the crops with Agritox herbicide, regardless of the Cd content in the soil (background and many times exceeding the MPC), and to increase the Mg accumulation in plants at elevated levels Ions of heavy metal.

The treatment of barley plants in the tillering phase with the herbicide Agritox, WC (in variants without the introduction of Cd into the soil) has an inhibitory effect on the photosynthetic activity (ILS) of 30 daily plants, which affects the yield of the crop (yield reduction by 9-13%). The use of the growth regulator Epin for the treatment of barley seeds at a dose of 200 ml / t does not reduce the negative effect of Agritox herbicide on ILS.

### References

- A directory of pesticides and agrochemicals allowed for use on the territory of the Russian Federation. Moscow: Agrorus, 2015. 735 pp.
- Annenkov B.N., Yudinseva E.V. (1991). Fundamentals of Agricultural Radiology. M.: Agropromizdat, 1991. 287 pp.
- Chernykh N.A., Milashchenko N.Z., Ladonin V.F. (1999). Ecotoxicological aspects of soil contamination with heavy metals. - M.: Agroconsult, 1999. 176 pp.
- Geshele E.E. (1971). Methodical guidelines for the phytopathological assessment of cereals. Odessa, 1971. 179 pp.
- Kabata - Pendias A., Pendias H. (1989). Microelements in soils and plants: Trans. With the English. - Moscow: Mir, 1989. 439 pp.
- Lukin S.V., Kononenko L.A., Miroschnikova Yu.V. (2004). The influence of cadmium on the development of the photosynthetic apparatus and the yield of spring wheat // Agrochemistry, 2004, No. 3, p. 63-68.

- Melnychuk Yu.P. (1990). Effect of cadmium ions on cell division and plant growth. - Kiev: Naukova Dumka, 1990. 148 pp.
- Nemchenko V.V. (1994). Application of herbicides of sulfonylureas on cereals and maize in Zauralye / Abstracts of the reports of the coordination meeting "Improving the control of the phytosanitary condition of agricultural crops with the aim of preventing outbreaks of mass development of diseases, pests and weeds". (Moscow region, Bolshie Vyazemy settlement, VNIIF, July 6-8, 1993). - M., 1994, p. 261-262.
- Pyankov V.I., Ivanov L.A. (2000). Biomass structure in plants of the boreal zone with different types of ecological strategies // Ecology, 2000, No. 1, p. 3 - 10.
- Ulyanenko L.N., Kruglov S.V., Filipas A.S., Pimenov E.P., Loi N.N., Arysheva S.P., Stepanchikova N.S., Dyachenko I.V., Markina A.V. (2004). Features of the accumulation of toxic substances (heavy metals, radionuclides) by crops with the use of chemical plant protection products / Proceedings of the regional competition of scientific projects in the field of natural sciences. - Kaluga, 2004. Issue. 6. P. 330-343.
- Zhurbitsky Z.I. (1968). Theory and practice of the vegetative method. - Moscow: Science. 1968. 206 pp.

## METHOD VALIDATION FOR THE SIMULTANEOUS DETERMINATION OF ACTIVE INGREDIENTS OF ACARICIDE ABAMECTIN AND ETOXAZOLE IN PESTICIDE FORMULATIONS

Sanja LAZIC, Dragana SUNJKA\*, Slavica VUKOVIC

Faculty of Agriculture, University of Novi Sad, Serbia

\*Corresponding author: draganas@polj.uns.ac.rs

### Abstract

Formulation of the products based on active ingredients abamectin and etoxazole and lack of the official CIPAC (*Collaborative International Pesticides Analytical Council*) and/or AOAC (*Association of Official Agricultural Chemists*) methods for their determination as individual components in pesticide products, led to need for the development of new methods. Abamectin is a contact and digestive insecticide/acaricide which belongs to the chemical group of avermectins, while etoxazole is an acaricide belonging to the group of oxazolines. In this study, simple, rapid and precise method for simultaneous determination of abamectin and etoxazole in pesticide products was developed and single-laboratory validated. For the analysis, LC system an Agilent Technologies 1100 Series with Zorbax SB-C18 column (5  $\mu\text{m}$ , 250 mm  $\times$  3 mm i.d.) was used. Analytical standards of abamectin and etoxazole and samples were diluted in acetonitrile and ultrasonically dissolved. The best separation was achieved using a mobile phase consisting of 0.5%  $\text{CH}_3\text{COOH}$ /acetonitrile (30/70), at a flow rate of 0.75 ml/min and UV detection at 254 nm. Column temperature was 25  $^\circ\text{C}$ , injected volume was 1  $\mu\text{l}$ . Retention times for abamectin and etoxazole were 5.348 min and 4.244 min, respectively. Under the selected conditions, the repeatability of the method expressed as relative standard deviation (%RSD) was less than 0.41%. The accuracy of the method, determined from recovery experiments through standard addition procedure, was found to be acceptable.

**Keywords:** *abamectin, etoxazole, HPLC-DAD, determination.*

### Introduction

The quality of pesticide products is crucial for their safe use in agriculture since the inadequate quality of pesticides leads to a number of consequences, such as reduction of its biological efficacy, the occurrence of phytotoxicity to cultured plant, negative impact on the environment. The procedure for quality control of pesticide products is conducted by laboratories that fulfill standards of the system ISO/IEC 17025, which implies the application of validated methods, well-equipped laboratories, and engagement of qualified personnel. Identity and content of the active ingredient, impurities of toxicological significance, physicochemical properties of the product have been tested by use of standard CIPAC (*Collaborative International Pesticides Analytical Council*) or AOAC (*Association of Official Agricultural Chemists*) methods.

However, development of corresponding methods is conditioned by deficiency of standard methods for certain active ingredients, or their combinations in products of different formulations. In order to use the method in a laboratory, with the aim of compliance verification with the prescribed criteria, it must be validated, which includes a set of tests and documentation of the characteristics of the method with the goal to demonstrate that the given

method corresponds to a specific analytical purpose. Use of validated methods is one of the basic requirements of Standard ISO/IEC 17025 and OECD principles of good laboratory practice (GLP).

According to CIPAC, corresponding methods are not available for the analysis of abamectin, a contact and digestive insecticide/acaricide which belongs to the chemical group of avermectins, and etoxazole, an acaricide belonging to the group of oxazolines, as well as for simultaneous determination of these two active ingredients in pesticide formulations.

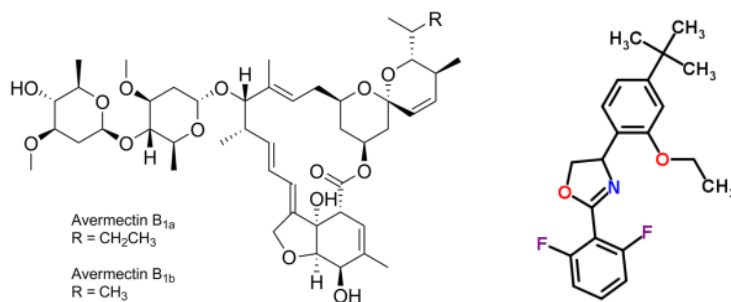


Figure 1. Structural formulas of abamectin and etoxazole

In this study, a simple and precise method for simultaneous determination has been developed for the determination of insecticides abamectin and etoxazole in pesticide products, respecting guidelines FAO/IAEA (2009).

## Material and methods

### Chemicals and standard solutions

Standard solutions of abamectin (98.9%, Dr Ehrenstorfer) and etoxazole (98%, Riedel-DeHaen) were prepared by diluting of a corresponding quantity of analytical standards in acetonitrile. During the analysis, the solutions were kept in dark at 4 °C. A series of solutions in concentrations of 0.1 up to 1.0 mg/ml was prepared by dilution of the standard mixtures. The freshly prepared working solutions were used to establish the precision of the chromatographic system through repeatability testing and to define the linearity of response for each individual component. As certified referent material was not available, samples with the previously determined content of the studied active ingredients were enriched by the known quantity of abamectin and etoxazole analytical standards. The appropriate quantity of a sample (154.2 mg, 141.5 mg, 132.3 mg) was weighted into a volumetric flask and dissolved in acetonitrile. Active ingredients were dissolved by sonication with acetonitrile and directly measured. All solutions were filtered through membrane filter of 0.45 µm and analyzed by HPLC-DAD.

### HPLC analysis

For the analysis, LC system an Agilent Technologies 1100 Series was used. The best separation was achieved using a Zorbax SB-C18 column (5 µm, 250mm × 3 mm internal diameter) and a mobile phase consisting of 0.5% CH<sub>3</sub>COOH/acetonitrile (30/70), at a flow rate of 0.75 ml/min and UV detection at 254 nm wavelength. The column temperature was 25 °C, injected volume was 1 µl.

### Validation of the method

According to IAEA guidelines, validation was performed by check of the following analytical performance parameters - linearity, repeatability of the injection, limits of detection and quantification and accuracy.

## Results and Discussion

The best determination of abamectin and etoxazole was achieved under previously described conditions. Qualitative HPLC analysis of the presence of a certain ingredient was carried out on the basis of retention times, while the quantitative ones were based on the size of the analytical signal. Chromatogram of abamectin and etoxazole standard is presented in Figure 2. Maximum peaks of abamectin and etoxazole were established at 4.244 min and 5.348 min, respectively.

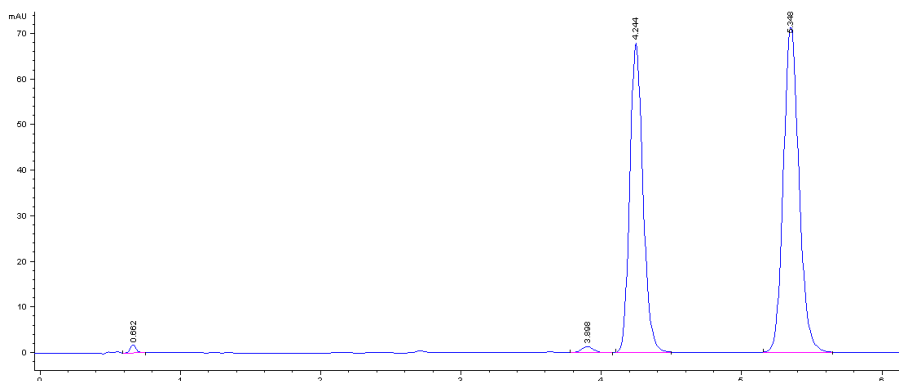


Figure 2. HPLC-DAD chromatogram of abamectin and etoxazole standards mixture in acetonitrile

Except on the basis of retention times, component identification was achieved also by comparison of UV-VIS spectrum of the unknown peak with the spectrum of the referent standard (Dudar, 2009). Figures 3 and 4 present spectra of abamectin and etoxazole analytical standards in acetonitrile solution. On y-axis are given values of the current signal detector (mAU), while on x-axis are wavelength values (nm).

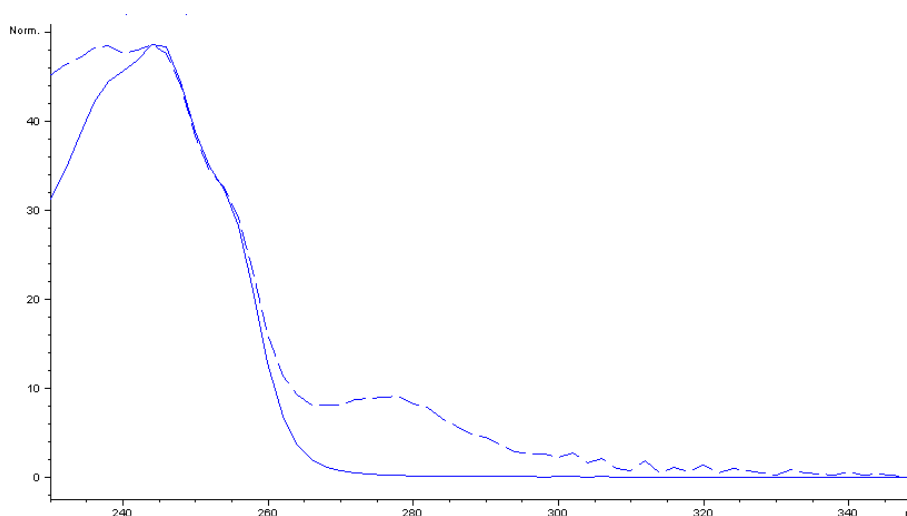


Figure 3. Overlapped UV spectra of *avermectin B<sub>1a</sub>* and *B<sub>1b</sub>* in abamectin, in acetonitrile

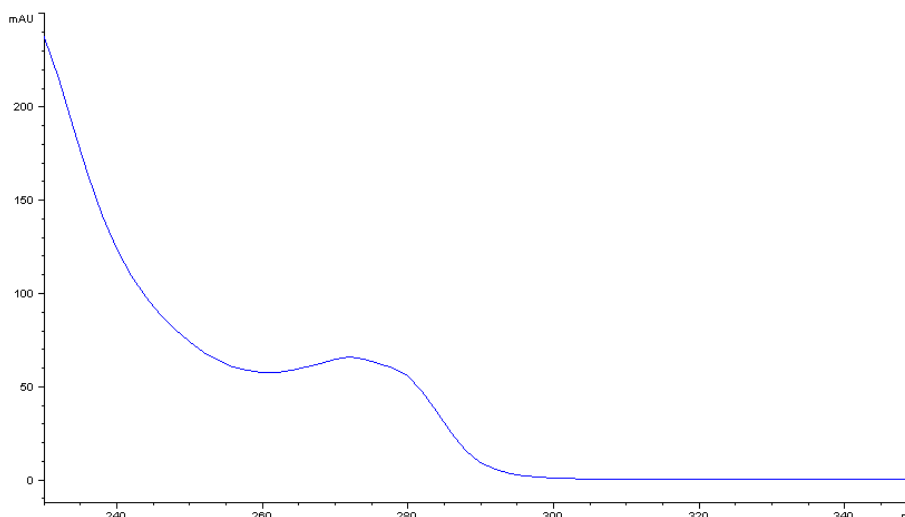


Figure 4. UV spectra of etoxazole in acetonitrile

### Validation parameters

Verification of chromatograph conditions was carried out by check of detector response linearity, repeatability of the injection and accuracy of the method, as well as by determination of detection limit and quantification.

#### Linearity

Linearity is determined by a range of the analytical procedures and it is presented by a regression equation. It is defined as a possibility to detect a signal directly proportional to the concentration or amount of the analyte within the given scope. The linearity range depends on the nature of analytes and detector type. The linearity of detector response was determined on five concentration levels by injecting of the standard abamectrine solution within the range of mass concentrations of 0.1 – 1.0 mg/ml and the standard solution of etoxazole within the range of mass concentrations of 0.1 – 1.4 mg/ml. A calibration curve was defined as dependence of the peak area from concentration and expressed by regression equation with correlation coefficient ( $R^2$ ) (Table 1).

Table 1. Linearity parameters

Abamectin	Etoxazole
$y=1446.0x+30.27$	$y=864.2x+24.14$
$R^2 = 0.996$	$R^2 = 0.997$

The obtained values of regression coefficients suggest that increase of the content of introduced compound is lineary followed by an increase in peak area. For the regression equation, the correlation coefficient of linear dependence for the tested compounds was 0.996, i.e. 0.997, suggesting the high sensitivity of abamectin and etoxazole determination by this method.

#### Repeatability of the injection

Repeatability was determined by injecting of 1  $\mu$ l standard abamectin and etoxazole solution and etoxazolee in the concentration of 0.1715 mg/ml, i.e. 0.2336 mg/ml six times. The injected volume was 1  $\mu$ L. Values of relative standard deviation (RSD, %) of 0.41% and 0.02% for abamectin and etoxazole indicate good reproductivity of determination of these



compounds by the applied method, which was also confirmed by comparison by the demand of the standard ( $RSD \leq 2$ ).

#### Accuracy of the method

As the parameter of the method accuracy extraction yield (Rec, %) was tested for three levels of enrichment. The average recoveries of the three fortification levels were 92.9% for abamectin and 91.6% for etoxazole with RSDs of 2.69% and 0.72%, respectively. The high agreement between the values obtained in the process and the actual value confirms the accuracy of the applied method for the determination of abamectin and ethoxazole in the formulated products.

#### Limit of detection and limit of quantification

The achieved values of the detection limit of 0.05 mg/l and the limit of quantification of 0.12 mg/l indicate the satisfactory sensitivity of the method for abamectin and etoxazole determination in formulated products.

#### Conclusion

For the determination of abamectin and etoxazole there is no validated standard method. In this study, a simple, precise, accurate and selective method for simultaneous determination of the abamectin and etoxazole in formulated pesticide products was developed. According to IAEA-TECDOC-1612, conditions under which the analysis was performed fully meet the standards of HPLC pesticide analysis in formulations. This method could be successfully applied for the quality control of commercial formulation and proved to be convenient and accurate.

#### Acknowledgement

This research is a part of project TR31038 financed by Ministry of Education, Science and Technological Development, Republic of Serbia.

#### References

- Dudar, E. (2009). Principles of developing multi-pesticide methods based on hplc determination. IAEA-TECDOC-1612 Quality Control of Pesticide Products, pp. 35-41.
- FAO (2010). Manual on development and use of FAO and WHO specifications for pesticides. IAEA-TECDOC-1612 (2009). Quality control of pesticide products. International Atomic Energy Agency.
- INTERNATIONAL ORGANIZATION FOR STANDARDIZATION, ISO/IEC 17025:2005 General requirements for the competence of testing and calibration laboratories, Geneva 2005.
- OECD (1998). Series on 'Principles of Good Laboratory Practice and Compliance Monitoring', ORGANIZATION FOR ECONOMIC CO-OPERATION AND DEVELOPMENT No. 1-11, Environmental Directorate, Paris.

## CHEMICAL CONTROL OF DOWNY MILDEW (*Bremia lactucae* Regel) ON LETTUCE

Slavica VUKOVIĆ\*, Nemanja BRZAKOVIĆ, Sanja LAZIĆ, Dragana ŠUNJKA, Antonije ŽUNIĆ

University of Novi Sad, Faculty of Agriculture, Novi Sad, Serbia

\*Corresponding author: vukovic@polj.uns.ac.rs

### Abstract

The most important lettuce pathogens in our agro-ecological conditions are *Bremia lactucae*, causal of downy mildew and *Botrytis cinerea*, causal of gray rot. Bearing in mind the demanding market, different production requirements of lettuce, as well its varieties, biological assays with fungicides are very important. The experiment was set up in 2015, in the locality of Provo (Mačva, western Serbia), in the crop of lettuce Seter variety, using standard OEPP methods. Fungicide based on fosetyl-aluminum (Aliette 80 WP) has been applied in a concentration of 0.31%. Biostimulant (Megafol; applied doses 2 l/ha), and a mixture of fungicide with biostimulant were also used in the bioassay. Foliar treatment of plants was carried out by backpack sprayer, with a consumption of spray liquid of 400 l/ha. The experimental design was a randomized block design with four replications. The efficacy of the fungicide is determined by Abbott, while the significance of differences for the confidence interval of 95% was done using ANOVA. In the laboratory conditions, the physical and chemical properties (pH, suspendability, surface tension and electric-conductivity) of spray liquid fungicide and the mixture of the fungicide + biostimulant have been tested. Fungicide Aliette 80 WP, as well as a mixture of Aliette 80 WP + Megafol, exhibited a high efficiency (from 79.1 to 91.7%) in control of downy mildew (*B. lactucae*). In all treatments where the fungicide, biostimulant as well as mixtures of fungicide + biostimulants were applied, the average weight of lettuce plants (417.3 to 433.3 g) was at a significantly higher level in comparison to the control (403.6 g). Physical and chemical properties of the spray liquids fungicide and mixture of fungicide + biostimulant were within acceptable limits and there is no significant change after 24 hours of standing. Mixtures of fungicide and biostimulant, based on physical and chemical properties exhibited compatibility.

**Key words:** lettuce, *B. lactucae*, fosetyl-aluminum, biostimulant

### Introduction

In Serbia, lettuce growing has a long tradition. Lettuce belongs to the group of leafy and herbaceous vegetables. In past it has been produced for someone's own needs or for the market, today it is intensive production. Lettuce growing is endangered by an increasing number of mainly fungal diseases. According to its significance and frequency of occurrence, the most important lettuce pathogen in our agro-ecological conditions is *Botrytis cinerea*, causal of gray rot. However, in years that favor its' development great losses are also affected by downy mildew, caused by *Bremia lactucae*. Besides, a disease that is regularly occurring in greenhouse lettuce is white mold caused by *Sclerotinia sclerotiorum*. Development of these diseases favor cool and moist conditions during vegetation period and in the lack of adequate protection, a significant and sometimes even total decay of the crop occurs. One of the risks

of fungicide application is also the occurrence of resistant isolates of *Bremia lactucae* and *Botrytis cinerea* toward fungicides that are used for control of these pathogens, which certainly represents a huge problem.

The aim of this study was to determine the efficiency of the product based on fosetyl-aluminum (Aliette 80 WP) aimed for control of lettuce downy mildew (*Bremia lactucae*) in filed products from locality Provo (Mačva, West Serbia), according to the standard EPPO methods applied individually and in a mixture of fungicide with foliar biostimulant (Megafol). In order to provide possible recommendations for their joint application, the aim was also to determine the compatibility of fungicide and foliar biostimulant mixture.

### Material and Methods

The trial was set up at locality Provo, Serbia. Lettuce (*Lactuca sativa* L.), variety Seter, was sown in containers made of Styrofoam with 200 of 5 cm<sup>3</sup> volume holes in each; sowing was performed on 15<sup>th</sup>, February 2015. A substrate Klasman Potgrund H was used for sowing. Lettuce seedlings were planted in open field on 10<sup>th</sup> April 2015; the inter-row distance was 30 cm, and the distance between plants 25 cm, which provided a canopy of 11 plants per square meter, i.e. 110,000 plants per hectare. Right after planting lettuce was watered by artificial rain micro-sprinklers. During vegetation period, lettuce crop has been regularly irrigated due to the lack of participations during that period. Twenty days after planting, following the development of a leaf rosette, a 400-kg ha<sup>-1</sup> nitrogenous minerals fertilization was carried out. With the aim of lettuce protection against downy mildew (*B. lactucae*), lettuce was treated by the product Aliette 80 WP (fosetyl-aluminum 800 g kg<sup>-1</sup>) applied in recommended concentration of 0.31%, i.e. 1.24 kg ha<sup>-1</sup>. Fungicide application was carried out by back-pack sprinkler Villager 16, of 16 L volume, with working pressure of 3 bars. The quantity of the applied working liquid was 400 L ha<sup>-1</sup>, with the use of recommended product concentrations. In field trials the fungicide was added a foliar fertilizer, i.e. the biostimulant Megafol in the amount of 2 L ha<sup>-1</sup>. The experimental design in the field was a randomized block design with four replications per variant (EPPO Standards, 2012). One plot contained 80 plants per repetition.

The first lettuce treatment was carried out six days after planting (16<sup>th</sup>, April 2015), and the second one 15 days after the first (1<sup>st</sup>, May 2015). Five evaluations of the intensity of the disease occurrence were performed according to the standard EPPO method (EPPO Standards, 2004). The evaluations were done according to the scale for evaluation of the disease intensity; plants were divided into five groups – to those that had up to 5% damages on leaves caused by downy mildew, plants with 5-10% of damages, 10-25%, 25-50%, and plants with 50-75% of damages. Evaluations were carried out by visual observation of symptoms on lettuce leaves. The first evaluation was conducted before the first treatment, i.e. on 16<sup>th</sup>, April, 2014, the second was carried out seven days after the first treatment, i.e. on 23<sup>rd</sup>, May 2015, the third one after the second treatment, i.e. on 1<sup>st</sup>, May 2015, the fourth fourteen days after the second treatment, i.e. on 15<sup>th</sup>, May 2015, and the fifth evaluation followed ten days after the previous, i.e. on 25<sup>th</sup>, May 2015. After application of fungicides, biostimulants and mixtures of fungicides and biostimulants according to the standard EPPO method (EPPO Standards, 2014), eventual occurrence of phytotoxicity on lettuce plants has also been monitored. Disease intensity expressed in % was calculated according to Townsend-Heuberger, and fungicide efficacy according to the formula of Abbott-a (Wentzel, 1963). The achieved results were statistically analyzed by the method of variance analysis (ANOVA). During lettuce picking, individual measurements of each head mass (g) was performed.

In Laboratory for Biological Research and Pesticides of the Faculty of Agriculture in Novi Sad, pH value, suspendability, surface tension and electrical conductivity of fungicide spray

liquids, foliar fertilizers and their mixtures in water (from locality Provo) also used in field trials have been determined. All studies of physical and chemical properties of spray liquids were carried out in three replications. Methods for studies of physical and chemical properties of pesticide formulations are prescribed by the Regulations on the methodology and documentation for pesticide testing (Anonimus, 2001).

## Results and Discussion

### Fungicide efficacy in lettuce protection against *B. lactucae*

Results of the study of the intensity of the occurrence of downy mildew in lettuce crop, as well as the efficacy of the applied fungicide Aliette 80 WP, individually or in mixture with foliar fertilizer Megafol in control of downy mildew causer (*B. lactucae*), are presented in Tables 1-5.

In the first evaluation which was carried out immediately after the treatment, the disease intensity was low, being in average 1.3-1.8%.

In Table 1 are presented results of biological assays seven days after fungicide application. The disease intensity in control was 7.2%, while it was 1.4-1.5% in fungicide treated plots. In variants in which only fungicide Aliette 80 was applied, as well as in a variant in which Aliette 80 WP + Megafol were sprayed, the disease intensity was on the significantly lower level in comparison to the control. The applied fungicide showed the efficacy of 79.1-80.5%.

**Table 1.** Intensity of the disease on leaf and efficiency of fungicide Aliette 80 WP in suppression of *B. lactucae* (23.04.2015.)

Treatment	Application rate kg, L ha <sup>-1</sup>	Intensity of the disease (%)	Efficiency (%)
Aliette 80 WP	1.24	1.4 b	80.5
Megafol	2.0	6.5 a	9.7
Aliette 80 WP + Megafol	1.24+2.0	1.5 b	79.1
Control	/	7.2 a	/
LSD (0.05)		0.80	

During the third evaluation, it was ascertained that the average disease intensity in control was 10.5%, and in variants in which Aliette 80 WP and Aliette 80 WP + Megafol were applied it was 1-1.1%, also on significantly lower level in regard to the control. Efficacy of the applied fungicide in control of downy mildew causer in lettuce was 90.5%, while in the variant in which a mixture of Aliette 80 WP + Megafol was applied, it was 91.4%. As it could be expected, in the variant in which the only biostimulant was used, the effect was missing (Table 2).

**Table 2.** Intensity of the disease on leaf and efficiency of fungicide Aliette 80 WP in suppression of *B. lactucae* (01.05.2015.)

Treatment	Application rate kg, L ha <sup>-1</sup>	Intensity of the disease (%)	Efficiency (%)
Aliette 80 WP	1.24	1.0 b	90.5
Megafol	2.0	9.5 a	9.5
Aliette 80 WP + Megafol	1.24+2.0	0.9 b	91.4
Control	/	10.5 a	/
LSD (0.05)		1.20	

In Table 3, the disease intensity of downy mildew in lettuce 14 days after the second treatment that was in control 15.1% is given, and in variants in which the fungicide (Aliette 80 WP) was used individually or in a mixture with foliar fertilizer (Aliette 80 WP + Megafol) in comparison to the control it was on significantly lower level of 1.3-1.5%. The applied fungicide showed efficacy of 90.1 – 91.3%

**Table 3.** Intensity of the disease on leaf and efficiency of fungicide Aliette 80 WP in suppression of *B. lactucae* (15.05.2015.)

Treatment	Application rate kg, L ha <sup>-1</sup>	Intensity of the disease (%)	Efficiency (%)
Aliette 80 WP	1.24	1.3 b	91.3
Megafol	2.0	13.5 a	10.6
Aliette 80 WP + Megafol	1.24+2.0	1.5 b	90.1
Control	/	15.1 a	/
LSD (0.05)		1.90	

During the fifth evaluation of the effects, the disease intensity in control was 20.5%, while in variants in which Aliette 80 WP and Aliette 80 WP + Megafol were applied it was on the significantly lower level in regard to the control with 1.7-2.0% (Table 4).

**Table 4.** Intensity of the disease on leaf and efficiency of fungicide Aliette 80 WP in suppression of *B. lactucae* (25.05.2015.)

Treatment	Application rate kg, L ha <sup>-1</sup>	Intensity of the disease (%)	Efficiency (%)
Aliette 80 WP	1.24	1.7 b	91.7
Megafol	2.0	18.5 a	9.8
Aliette 80 WP + Megafol	1.24+2.0	2.0 b	90.2
Control	/	20.5 a	/
LSD (0.05)		2.70	

Based on the studies of the intensity of downy mildew occurrence in lettuce after use of fungicide Aliette 80 WP and mixture of Aliette 80 WP + Megafol, it can be concluded that fungicide showed satisfactory efficacy in control of *B. lactucae* in lettuce in locality Provo,

and there were no negative effects of the use of mixture of fungicide and biostimulant, nor there were recorded phytotoxic changes in lettuce crop of the variety Seter. Susceptibility studies of 134 isolates of fungus *B. lactucae*, collected from lettuce crop from California, showed significantly reduced susceptibility of this fungus to fosetyl-aluminum. Even 50% of isolates exhibited fosetyl-aluminum tolerance, and 40% moderate susceptibility (Brown et al., 2004). During 2012, Stević et al. (2014) studied efficacy of fungicide based on pyraclostrobin + boscalid in control of downy mildew causer (*B. lactucae*) in lettuce. Depending on the locality, the studied fungicide achieved the high efficacy of 93.6-97.4% in control of lettuce downy mildew causer.

### **Impact of fungicide and biostimulant on yield of salad crop**

Based on average lettuce plants weight measured during picking, it was ascertained that the highest plant weight of 433.3 g per plant was recorded in a variant in which a mixture of the fungicide Aliette 80 WP + Megafol was applied, while the lowest plant weight of 403.6 g was in control. In variants in which fungicide, biostimulant, as well as mixtures of fungicide and biostimulant were applied, the average lettuce plant weight was on the significantly higher level in comparison to the control. The achieved results are in accordance with studies of Vinković et al. (2013) who studied the impact of biostimulants, among which was also Megafol, to the index of leaf area of the tomato crop. They concluded that plants treated by biostimulants have a significantly higher index of leaf area in regard to plants from control variant.

### **Physical and chemical properties of spray liquid of fungicides and mixtures of fungicides and biostimulants**

The pH value of well water from locality is 6.4 (weakly acid), while the pH of spray liquid of fungicides Aliette 80 WP (4.3), as well as mixture Aliette 80 WP + Megafol (4.7) is acid. Electric-conductivity of well water from locality Provo, immediately after preparation was  $1050.0 \mu\text{S cm}^{-1}$ , while for the other fungicide spray liquids it was about  $1425 \mu\text{S cm}^{-1}$ . The introduction of biostimulant Megafol in fungicide spray liquid increases their electric-conductivity ( $1838.7 \mu\text{S cm}^{-1}$ ) so it is even higher than the electric-conductivity of the biostimulant itself ( $1612.3 \mu\text{S cm}^{-1}$ ).

Surface voltage of well water from the locality Provo, immediately after preparation was  $65.6 \text{ mJ m}^{-2}$ , of fungicide spray liquid  $36.6 - 37.8 \text{ mJ m}^{-2}$ , of biostimulant  $46.7 \text{ mJ m}^{-2}$ , while the surface voltage of fungicide and biostimulant mixture was  $35.3 - 38.0 \text{ mJ/m}^2$  (Table 5). After 24h of the standing of fungicide and mixtures of fungicide and biostimulant, there were no significant changes of physical and chemical properties.

**Table 5.** Physico-chemical properties of working fluids of fungicides, biostimulators and their mixtures (immediately after preparation)

Sample	Concentration (%)	pH	Electrical conductivity ( $\mu\text{S cm}^{-1}$ )	Surface tension ( $\text{mJ m}^{-2}$ )
Aliette 80 WP	0.31%	4.3	1425.0	36.3
Megafol	0.5%	6.5	1612.3	46.7
Aliette 80 WP + Megafol	0.31%+0.5%	4.7	1838.7	35.3
Control (Water well - Provo)	/	6.4	1050.0	65.6

Spray liquid of fungicides, as well as their mixtures with biostimulant in well water from the locality Provo, achieved suspendability in the allowed limits, which in all cases was above 60%. The low prescribed suspendability limit is 60% (Anonimus, 2001).

Based upon the above presented, physical and chemical properties of fungicide spray liquids and their mixtures with biostimulant depend on components in a mixture, as well as on physical and chemical properties of water used for the preparation of spray liquids. (Vuković, 2011).

### Conclusions

Based upon studies and achieved results in control of downy mildew causer (*Bremia lactucae*) in lettuce crop, the following can be concluded:

Fungicide based on fosetyl-aluminum (Aliette 80 WP), as well as the mixture Aliette 80 WP + Megafol, showed high efficacy of 79.1-91.7%, depending on time of evaluation, in control of downy mildew causer (*B. lactucae*) in lettuce from locality Provo, and there were no negative effects of fungicide and biostimulant mixture.

After use of fungicide Aliette 80 WP and mixtures with biostimulant Megafol, there were no phytotoxic effects in lettuce crop of the variety Seter.

In all variants in which fungicide, biostimulant, as well as mixture of fungicide and biostimulant were applied, the average lettuce plant weight was on significantly higher level in comparison to the control. The applied fungicide and biostimulant had impact on a significant increase in salad yield.

Physical and chemical properties (pH, suspendability, surface tension and electric-conductivity) of fungicide spray liquid and the mixture of the fungicide + biostimulant (Megafol) were within allowed limits and there has been no significant changes after 24 hours of standing. Based on physical and chemical properties, fungicide and biostimulant mixtures showed compatibility

### Acknowledgement

This study is a part of the project III46008, funded by the Ministry of Education, Science and Technological Development of the Republic of Serbia.

## References

- Anonimus (2001). Rules on methods for testing pesticides. Official Gazette FRY, 63/2001.
- Brown, S., Koike, S., Ochoa, O., Laemmlen F., Michelmore R. (2004). Insensitivity to the Fungicide Fosetyl-Aluminum in California Isolates of the Lettuce Downy Mildew Pathogen, *Bremia lactucae*. *Plant Disease*, 88, 5, 502-508.
- EPPO Standards (2004). Downy mildews of lettuce and other vegetables. PP 1/65(3), EPPO Standards, Fungicides and Bactericides, vol. 2, 83-87.
- EPPO Standards (2012). Design and analysis of efficacy evaluation trials. PP 1/152(4), EPPO Bulletin, 42 (3), 367–381.
- EPPO Standards (2014). Phytotoxicity assessment, PP 1/135(4). EPPO Bulletin, Vol 44 (3), 265-273.
- Stević M., Šević M., Vukša P. (2014). Efficiency of the combination of pyraclostrobin + boscalid in the suppression of gray rot and downey mildew, *Plant doctor*, 42, 4, 308-31.
- Vinković, T., Parađiković, N., Teklić, T., Tkalec, M., Josipović, A. (2013). Influence of biostimulators on leaf surface index in tomato. 48th Croatian & 8th International Symposium on Agriculture, Dubrovnik, Croatia, Proceedings, 358-362.
- Vuković, S. (2011). Biological effects of pesticides depending on the water quality. Doktorska disertacija, Univerzitet u Novom Sadu, Poljoprivredni fakultet, Novi Sad.
- Wentzel, H. (1963). re Pflanzenschutz nachrichten Bayer. The basic Principles of Crop Protection Field Trials.



## COMPARATIVE ANALYSIS OF GROWTH INHIBITION OF *FUSARIUM OXYSPORUM* CAUSED BY *PSEUDOMONAS* SPP. AND *BACILLUS SUBTILIS*

Goran ALEKSIĆ<sup>1\*</sup>, Slobodan KUZMANOVIĆ<sup>1</sup>, Mira STAROVIĆ<sup>1</sup>, Magdalena KNEŽEVIĆ<sup>2</sup>, Dragana JOŠIĆ<sup>2</sup>

<sup>1</sup>Institute for Plant Protection and Environment, Belgrade, Serbia

<sup>2</sup>Institute of Soil Science, Belgrade, Serbia

\*Corresponding author: algoran@sezampro.rs

### Abstract

Biological control of plant diseases by using microorganisms provides a possible alternative to the use of chemicals in agriculture. Microbial biopesticides originate mostly from bacteria (78%). The wilt-inducing strains of *Fusarium oxysporum* are responsible for severe damage of many economically important plant species. The aim of this study was to examine effect of indigenous rhizobacteria *Pseudomonas* spp. and *Bacillus subtilis* against *F. oxysporum in vitro*. The antagonistic activities of several *Pseudomonas* strains and different concentration of *B. subtilis* strain obtained from rhizosphere of clover, maize and alfalfa were evaluated for antagonistic activity against *F. oxysporum* originating from potato. The antagonistic activity was studied by using dual culture method on Waksman agar. The results were shown as percentage of inhibition of the fungal growth. All tested bacterial strains possess several biocontrol traits. *Pseudomonas* strain K24 was the most effective, causing 78.97% of fungal growth inhibition. *Pseudomonas* B25, isolated from clover rhizosphere, and M28 isolated from rhizosphere of maize, were less effective (53.33 and 51.11%, respectively). *B. subtilis* strain Bs13 (in concentration of  $8 \times 10^6 \text{CFU mL}^{-1}$ ) inhibited fungal growth up to 73%. The antifungal effects of six lower concentrations (from  $1 \times 10^5$  to  $4 \times 10^6 \text{CFU mL}^{-1}$ ) inhibited fungal growth over 50%. The lower concentrations exhibited a minor levels of inhibition compared to the difenoconazol used as standard, which showed 68% of inhibition. Strains K24 and Bs13, originating from alfalfa rhizosphere, were more effective than difenoconazol. *Pseudomonas* sp. K24 ( $1 \times 10^6 \text{CFU mL}^{-1}$ ) showed higher effectiveness in inhibition of *F. oxysporum* than *B. subtilis* Bs13 ( $8 \times 10^6 \text{CFU mL}^{-1}$ ) and difenoconazol. The results obtained in this study are promising and support the importance of further *in vivo* investigations of the antifungal capacity of indigenous rhizobacteria.

**Keywords:** *rhizobacteria, antagonistic activity, Fusarium oxysporum, Pseudomonas, Bacillus subtilis*

### Introduction

The application of fungicides against phytopathogenic fungi in order to reduce the damages has been compromised by evolution of pathogen resistance to many fungicides. Over the past 20 years, biological control has been found to be effective in controlling some plant disease (Peighami-Ashnaei et al., 2009). Control of phytopathogenes by biological agents is environmentally benign in comparison to the classical chemical control methods (Hassanein et al., 2009). The biopesticides characteristics include low-residue, high-performance efficacy and less toxic effects (Mnif and Dhouta, 2015).

The most commonly used microbial biopesticides contain a wide array of bacteria, including Gram positive *Bacillus* spp. and Gram negative *Pseudomonas* spp. *Bacillus subtilis* is

commonly found in various ecological niches and does not have any history of pathogenicity. It was shown to be a potential biocontrol agent against phytopathogenic fungi (Ongena et al., 2007), especially *Fusarium* spp. (Chen et al., 2010; Liu et al., 2010; Velho et al., 2011). *Pseudomonas* genus is one of the most heterogeneous and ecologically significant groups of bacteria. Some members of this genus are considered to be phytopathogenic, while other strains and species can have important bioremediation and biocontrol potential. They produce diverse metabolites including mycolytic enzymes and secondary active metabolites which have the ability to reduce plant infections caused by fungal growth.

*Fusarium* spp. are widespread fungi, which can cause diseases on economically significant plants (Wang et al. 2011). *Fusarium* genus fungi are already reported to cause seed “rot” disease that affect different stages of the host, such as seeds, seedlings and the crowns of developing plants (Moya-Elizando, 2013).

*Fusarium* dry rot is caused by several species, including *Fusarium oxysporum* Schlech. Potato dry rot usually occurs during storage and can lead to losses in crop quality and yield. It is responsible for severe vascular wilts, and can cause rots of tubers. Yield reduction caused by dry rot has been estimated to 6% in average, with losses up to 25% in some cases (Gashari, Gherbawy 2013). In 2000., almost complete loss of stored commercial potatoes varieties was reported in Turkey (Eken et al., 2000).

In this study, we compare the influence of *Pseudomonas* spp. and *Bacillus subtilis* to the inhibition of *Fusarium oxysporum* growth originating from potato tubers.

### Materials and methods

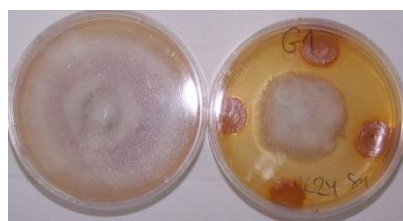
The *Fusarium* strain used in this study is a part of the collection of the Institute for Plant Protection and Environment, Belgrade, Serbia. It is originating from infected potato tuber. The fungus has been already morphologically identified as *F. oxysporum*. The fungus was grown on PDA medium.

Bacterial strains belong to the Project III46007 collection (Institute of Soil Science). *Pseudomonas* strains were isolated from rhizosphere of clover (B25), maize (M28) and alfalfa (K24). *Bacillus subtilis* strain Bs13 was isolated from alfalfa rhizosphere. All strains were chosen for this study based on their biocontrol potential, detected earlier for several phytopathogenic fungi (unpublished data). *Pseudomonas* B25 was isolated from clover rhizosphere, M28 from rhizosphere of maize, while K24 and Bs13 were originating from alfalfa rhizosphere. Bacteria were grown in liquid King’s B medium (KB) for 24h at 26<sup>0</sup>C. Concentration of bacterial suspension was determined spectrophotometrically and diluted to appropriate concentration.

Inhibition of the pathogenic fungi *F. oxysporum* was performed on Waksman agar (WA). Ten microliter of each culture was applied near the edges of the WA plate. One hour later, a 5 mm diameter of circular plug, from an actively growing fungal culture on PDA, was placed on the surface of fresh WA at the center, according to Anjaiah et al. (1998). All treatments consisted of three Petri plates, and experiments were repeated three times. Petri plates containing only fungal mycelia were used as a control. The inhibition of the fungal growth was determined after 7 days incubation at 26<sup>0</sup>C. Inhibition was expressed as percentage of radial growth inhibition (PIRG) and was measured by using the following formula  $PIRG \% = 100 \times (R_1 - R_2) / R_1$ , where R1 was the radial distance of the fungal growth in control and R2 represented the radial distance of the fungal growth in the direction of the antagonist.

## Results and discussion

The inhibition of *F. oxysporum* growth by *B. subtilis* and *Pseudomonas* spp. strains was determined after a week of incubation. The percentage of *F. oxysporum* mycelial inhibition induced by different concentrations of *B. subtilis* and three *Pseudomonas* spp. strains: B25, K24 and M28 is shown in Table 1 and Figure 1. The highest percentage of growth inhibition - 78.97% was observed for *Pseudomonas* strain K24. The highest concentrations of *B. subtilis* showed the strongest inhibition of mycelial growth -73%. All tested concentrations of *B. subtilis* and applied concentration of *Pseudomonas* spp. induced growth inhibition over 50%. *Pseudomonas* K24 and the highest concentrations of *B. subtilis* had better antifungal effect than difenoconazol, used as standard.



**Figure 1.** Antagonistic effect of *Pseudomonas* sp. strain K24 against *F.oxysporum*

**Table 1.** Percentage of *F. oxysporum* growth inhibition by using different concentrations of *B. subtilis* and three isolates of *Pseudomonas* spp.

Treatment	Strain	Concentration CFU ml <sup>-1</sup> /%	Inhibition (%)
<i>Bacillus subtilis</i>		8x10 <sup>6</sup>	73.00
		4x10 <sup>6</sup>	62.16
		2x10 <sup>6</sup>	62.16
		1x10 <sup>6</sup>	60.81
		5x10 <sup>5</sup>	54.05
		2,5x10 <sup>5</sup>	52.70
		1x10 <sup>5</sup>	51.35
<i>Pseudomonas</i>	B25	1x10 <sup>6</sup>	53.33
	K24	1x10 <sup>6</sup>	78.97
	M28	1x10 <sup>6</sup>	51.11
<b>Difenoconazol</b>		0.03%	68.92

Many reports indicate that different bacterial strains from genus *Bacillus* and *Pseudomonas* can be used as biocontrol agents against *Fusarium* wilt disease of many field crops, including potato (Puopolo et al, 2011; Susilowati et al, 2011; Crane et al, 2013; Schisler et al., 2016). Recep et al. (2009) tested eight different *Bacillus* and *Pseudomonas* species for antifungal activity in *in vitro* conditions against *Fusarium* spp. causal agent of dry rot disease of potato. The strongest antagonism was observed for one of the *Bacillus* strains, while *Pseudomonas* strains had medium antagonistic activity against *F. oxysporum* originating from potato tubers. In our previous investigation, several *Pseudomonas* strains reduced disease incidence on cardoon caused by *Alternaria tenuissima* (Jošić et al., 2012). Indigenous *Bacillus* sp. Q3 caused stimulation of marshmallow seed germination and reduction of seed infection by several phytopathogenic fungi (Starović et al., 2013).

The use of bacterial biocontrol agents in controlling potato dry rot disease has aroused great attention, due to its applicability in postharvest conditions which provide an ideal niche for biocontrol agents. In this study, we demonstrated that all tested bacteria show satisfactory activity against the same pathogen *in vitro*. In further research, *in vivo* assay will be performed in order to evaluate the efficacy of K24 strain against pathogen originating from different hosts.

### Conclusion

All tested bacterial strains induced inhibition of *F. oxysporum* growth over 50%. *Pseudomonas* strain K24 had better inhibitory effect than *Bacillus subtilis* Bs13 and other *Pseudomonas* strains, as well as than difenoconazol. This strain will be used in further research of determination of its potential as biocontrol agent for managing *Fusarium* species causing dry rot.

### Acknowledgement

This work was supported by the Ministry of Education, Science and Technological Development, Republic of Serbia, Projects grants TR 31018 and III46007.

### References

- Anjaiah V., Koedam N., Nawak-Thompson B., Lopez JE., Hofte M., Tambong JT., Cornelis P. (1998). Involvement of phenazines and anthranilate in the antagonism of *Pseudomonas* and *Pythium* spp. *Molecular Plant-Microbe Interactions*, 11: 847-854.
- Chen F., Wang M., Zheng Y., Luo J., Yang X., Wang X. (2010). Quantitative changes of plant defense enzymes and phytohormone in biocontrol of cucumber *Fusarium* wilt by *Bacillus subtilis* B579. *World Journal of Microbiology and Biotechnology*, 26: 675-684.
- Crane J.M., Gibson R.H., Bergstrom G.C. (2013). Iturin Levels on Wheat Spikes Linked to Biological Control of *Fusarium* Head Blight by *Bacillus amyloliquefaciens*. *Biological Control*, 103: 146-155.
- Eken C., Demirci E., Sahin F. (2000). Pathogenicity of the fungi determined on tubers from potato storages in Erzurum, Turkey. *Journal of Turkish Phytopathology*, 29 (2-3): 61-69.
- Gashari R., Gherbawy Y. (2013). Pathogenicity of Some *Fusarium* Species Associated with Superficial Blemishes of Potato Tubers. *Polish Journal of Microbiology*, 62 (1): 59-66.
- Hassanein W.A., Awany N.M., El-Moughith A.A., Salah El-Dien S.H. (2009). Characterization and Antagonistic Activity of Metabolite Produced by *Pseudomonas aeruginosa* Sha8. *Journal of Applied Sciences Research*, 5: 392-403.
- Jošić D., Protolipac K., Starović M., Stojanović S., Pavlović D., Miladinović M., Radović S. (2012). Phenazines Producing *Pseudomonas* Isolates Decrease *Alternaria tenuissima* Growth, Pathogenicity and Disease Incidence on Cardoon. *Archives of Biological Sciences, Belgrade*, 64: 1495- 1503.
- Liu B., Huang L., Bauchenauer H., Kang Z. (2010). Isolation and partial characterization of an antifungal protein from the endophytic *Bacillus subtilis* strain EDR4. *Pesticide Biochemistry and Physiology*, 98: 305-311.
- Mnif I., Dhouta G. (2015). Potential of bacterial derived biopesticides in pest management. *Crop Protection*, 77: 52-64.

- Moya-Elizando E.M. (2013). Fusarium crown rot disease: Biology, interactions, management and function as a possible sensor of global climate change. *Ciencia e Investigación Agraria*, 40: 235-252.
- Ongena M., Jourdan E., Adam A. (2007). Surfactin and fengycin lipopeptides of *Bacillus subtilis* as elicitors of induced systemic resistance in plants. *Environmental Microbiology* 9: 1084–1090.
- Peighamai-Ashnaei S, Sharifi-Tehrani A., Ahmadzadeh M., Behboudi K. (2009). Interaction of different media on production and biocontrol efficacy of *Pseudomonas fluorescens* P-35 and *Bacillus subtilis* B-3 against grey mould of apple. *Journal of Plant Pathology*, 91: 65-70.
- Puopolo G., Raio A., Pierson L.S., Zoina A. (2011). Selection of a new *Pseudomonas chlororaphis* strain for the biological control of *Fusarium oxysporum* f. sp. *radices-lycopersici*. *Phytopathologia Mediterranea*, 50: 228-235.
- Recepko, Fikretin S., Erkol, D., Cafer E. (2009). Biological control of the potato dry rot caused by *Fusarium* species using PGPR strains. *Biological Control*, 50: 194-198.
- Schisler D.A., Slininger P.J., Olsen N.L. (2016). Appraisal of selected osmoprotectants and carriers for formulating Gram-negative biocontrol agents active against *Fusarium* dry rot on potatoes in storage. *Biological Control*, 98: 1-10.
- Starović M., Jošić D., Pavlović S., Dražić S., Poštić D., Popović T., Stojanović S. (2013). The effect of IAA producing *Bacillus* sp. Q3 strain on marshmallow seed germination. *Bulgarian Journal of Agricultural Science*, 19(3): 572-577.
- Susilowati A., Wahyudi A.T., Lestari Y., Suwanto A., Wiyono S. (2011). Potential *Pseudomonas* Isolated from Soybean Rhizosphere as Biocontrol against Soilborne Phytopathogenic Fungi. *HAYATI Journal of Biosciences*, 18: 51-56.
- Velho R.V., Medina L.F., Segalin J., Brandelli A. (2011). Production of lipopeptides among *Bacillus* strains showing growth inhibition of phytopathogenic fungi. *Folia Microbiologica*, 56: 297-303.
- Wang H., Xiao M., Kong F., Chen S., Dou H.T., Sorrell T., Li R.Y., Xu Y.C. (2011). Accurate and practical identification of 20 *Fusarium* species by seven-locus sequence analysis and reverse line blot hybridization, and an in vitro antifungal susceptibility study. *Journal of Clinical Microbiology*, 49:1890-1898.

## PHYSICAL AND CHEMICAL QUALITY PARAMETERS OF HONEY FROM CENTRAL SERBIA

Goran JEVTIĆ<sup>1\*</sup>, Bojan ANĐELKOVIĆ<sup>1</sup>, Snežana BABIĆ<sup>1</sup>, Dragoslav ĐOKIĆ<sup>1</sup>, Nebojša NEDIĆ<sup>2</sup>, Kazimir MATOVIĆ<sup>3</sup>, Nada PLAVŠA<sup>4</sup>

<sup>1</sup>Institute for Forage Crops - Kruševac, Serbia

<sup>2</sup>Faculty of Agriculture - Zemun, University of Belgrade, Serbia

<sup>3</sup>Specialist Veterinary Institute –Kraljevo, Serbia

<sup>4</sup>Faculty of Agriculture, University of Novi Sad, Serbia

\*Corresponding author: goran.jevtic@ikbks.com

### Abstract

In this paper, analyzes were conducted on the false acacia, meadow, and mixed honey and honeydew from the territory of Central Serbia. Honey was obtained from the area which is bordered to the east by Mojsinjske mountains and Jastrebac, from the south and west by the mountains of Kopaonik and Goč, and from the north by Resavske mountains. Quality parameters of honey (ash, water, acid, and total reducing sugars, sucrose and diastase activity) were determined by the methods from the Rulebook of honey quality (Sl. SCG, 2003). Total nitrogen was determined by micro-Kjeldahl method, phosphorus was determined by spectrophotometry, and potassium by AAS method. Most of the analyzed honeys met both domestic (which are somewhat sharper for individual parameters) and EU standards. Deviation was present in two samples of the mixed honey, where total acidity exceeded both standards and in two samples of honeydew, where results for this parameter exceeded the domestic standard. It was found that the type of honey significantly ( $p < 0.05$ ) influences the amount of ash, total acidity, diastase number and amount of reducing sugars. False acacia honey had high P content ( $73.3 \text{ mgkg}^{-1}$ ) and honeydew had the highest N ( $937.8 \text{ mgkg}^{-1}$ ) and K ( $84.1 \text{ mgkg}^{-1}$ ). The amount of N, K and Mg significantly ( $p < 0.01$ ) depended on the type of honey and the differences in the amount of phosphorus did not show statistical significance. False acacia honey had the most of Na and Fe, meadow honey had the highest content of Zn and honeydew had the most of Mn.

**Keywords:** *honey, Central Serbia, physical and chemical parameters, macro - and micro-elements.*

### Introduction

Honey is a sweet, thick, crystallized, viscous product that honey bees make from the nectar of flowers of honey plants or secretions from the live parts of the plants that bees collect, add their own specific substances to it, transform and store in the honeycomb cells to mature (Sl list SCG, 2003). Honey is the natural sweet substance produced by honey bees from the nectar of plants, secretions of living parts of plants or excretion products of insects that live on plant parts, which the bees collect, transform with the addition of their specific substances are deposit in honeycomb, dehydrate, leave stored in the honeycombs to ripen and mature (Codex Alimentarius, 2001). Honey is a high quality food product which quality is determined based on the contents of carbohydrates, water, protein, minerals, pH, vitamins, organic acids, the presence of HMF (Hydroxymethylfurfural) and the enzyme activity (Bogdanov, 2007). Natural honey represents the most complete and highest quality food for both honey bees and for humans. In addition to the carbohydrate component, honey contains many other

substances that are important in human nutrition. This is primarily related to the proteins (Christov & Silitskaya, 1952), acids (Nelson & Mottern, 1931), mineral materials, i.e. macro and micro elements, and in a small but measurable amount, vitamins (Haydak et al., 1942, Kitzes et al., 1943), enzymes (White, 1975) and other substances that may be found in foods. When it comes to honey bee nutrition, their requirement for carbohydrates are completely satisfied by consumption of honey, while other ingredients that are necessary for normal activity (primarily proteins, minerals, vitamins, etc.) are far less represented in honey and the honeybees meet needs for them by consuming pollen (Adekanmbi & Ogundipe, 2009).

Quality control of honey is very important for the protection of consumers, but also because of the development of production and processing methods and use of honey. Consumers expect to that information on the quality and origin of honey present in the market are available, based on the quality indicators marked on the label, which are analyzed as suggested by the European Union directive (EU, 2002). The lack of certain micro-elements (Mn, Fe, Cu, Zn and Se) can cause serious health disorders people (Fraga, 2005)

The aim of this study was to determine the physical and chemical characteristics and the amount of macro- and micro-elements in honey from Central Serbia. Given the fact that lately there is an increasing demand for honey from Serbia, we wanted to determine whether and how it meets the qualitative criteria set in our country and in the EU.

### **Materials and methods**

In this paper, 60 honey samples (21 of false acacia honey, 15 of meadow honey, 11 of mixed honey and 13 of honeydew) were analyzed which were obtained from beekeepers from Central Serbia. Honey is derived from the area bordered by Mojsinjske mountains and Jastrebac from the east, Kopaonik and Goč mountains from the south and west and with Resavke mountains from the north. The apiary in the Duboka near Pojate had the lowest altitude (150m) and the apiary with the highest altitude in Kriva Reka, Kopaonik (1191m).

Considering the physico-chemical quality of the honey, following indicators were determined: ashes, water content, acidity, diastase activity, reducing sugars and sucrose. All analyzes were done according to the Regulations on quality and other requirements for honey and other bee products, products based on honey and other bee products (Sl. list SCG 45/03, 2003). Total nitrogen was determined by micro-Kjeldahl method, phosphorus by the spectrometric method of the SRP, ISO (6491:2003), and potassium and the macro and micro elements were determined by AAS method (AAS-Perkin Elmer 1100 B USA). Each sample was done in three replications. ANOVA was done using the computer program Statistica 8.0 (StatSoft) in completely randomized design in three replications.

### **Results and discussion**

#### **Quality parameters of honey**

The average amount of ash in the analyzed honeys was 0.51% (Table 1). The highest ash content was found in honeydew 0.61%, and at the lowest (0.31%) was determined in acacia honey. The amounts of ash in the meadow and mixed honey were almost the same.

One honeydew sample had 0.96% of ash which is allowed for this type of honey considering EU and national standards. Similar results were listed by many authors (Mendes et al., 1998; Golob & Plestenjak, 1999; Šarić et al., 2005; Kahraman et al., 2010). The high ash content in honeydew was also determined in the research of Thrasyvoulou & Manikis (1995).

The water content in honey is a very important factor when it comes to storing honey, because there is a possibility of its decay (fermentation) due to increased humidity. In

addition, the moisture content may influence the crystallization of honey. In the observed honeys average 18.9% of water was determined. The lowest water content was found in false acacia honey (18.3%) while other honeys had a very small difference for this parameter. All observed honeys were very uniform which is shown by a very low coefficient of variation (CV = 4.57 to 6.04%). In the studied samples there were none that deviated from Rulebook which allows the honey to contain up to 20% of water. Most authors agree that naturally matured honey from the hive contains 16-18% water (Devillers et al., 2004; Conti i sar., 2007; Nedić i sar., 2007; Marghitas et al., 2010). By analyzing monofloral honeys, Persano Oddo et al., (1995) determined that false acacia honey and honeydew have less than 18% water.

Table 1. Average values of indicators of quality of honey from Central Serbia.

Honey type	Trait	Ash (%)	Water 21 <sup>0</sup> C (%)	Acidity mmol/kg	Diastase activity	Reduc. sugars(%)	Sucrose (%)
<b>False acacia</b>	<b>Average</b>	<b>0.31</b>	<b>18.3</b>	<b>17.7</b>	<b>9.9</b>	<b>68.9</b>	<b>4.86</b>
	SD	0.12	0.79	8.0	1.1	2.8	2.62
	CV%	39.8	5.2	45.3	11.3	4.0	53.9
	Min-Max	0.12-0.53	17.0-19.6	9.0-32.2	8.3-11.8	65.6-78.2	1.2-9.0
<b>Meadow</b>	<b>Average</b>	<b>0.55</b>	<b>19.1</b>	<b>30.9</b>	<b>11.5</b>	<b>68.8</b>	<b>2.64</b>
	SD	0.19	1.1	5.1	2.9	1.7	1.46
	CV%	35.2	5.8	16.4	15.6	2.4	51.4
	Min-Max	0.32-0.95	16.5-19.9	21.9-36.2	8.2-14.5	66.2-70.9	1.2-4.7
<b>Honey dew</b>	<b>Average</b>	<b>0.61</b>	<b>19.0</b>	<b>36.6</b>	<b>19.4</b>	<b>64.3</b>	<b>3.18</b>
	SD	0.22	1.1	9.3	4.8	2.6	1.73
	CV%	36.7	6.0	25.5	23.6	3.9	54.5
	Min-Max	0.19-0.96	17.0-19.9	24.9-49.6	10.8-26.3	61.7-70.8	0.8-6.0
<b>Mixed</b>	<b>Average</b>	<b>0.55</b>	<b>19.1</b>	<b>41.1</b>	<b>15.9</b>	<b>70.5</b>	<b>3.04</b>
	SD	0,11	0.86	6.1	3.7	3.6	1.29
	CV%	20,3	4.5	14.7	18.5	5.1	42.5
	Min-Max	0.42-0.77	18.4-19.9	34.0-70.9	9.2-19.2	66.5-75.7	1.8-4.7
<b>Total average</b>		<b>0.51</b>	<b>18.9</b>	<b>31.6</b>	<b>14.2</b>	<b>68.1</b>	<b>3.43</b>
<b>F-test</b>		4.13*	1.62 <sup>ns</sup>	18.36*	3.83*	3.22*	2.98*

Honey naturally contains acids, but the problem arises when their quantity increases, which indicates deterioration of honey (fermentation). In the analyzed honeys, the highest acidity was measured in mixed honey (41.1 mmol/kg), and the lowest in false acacia honey, but that honey also had the highest coefficient of variation. A high coefficient of variation for the honey acidity, as well as for HMF content and diastase activity were cited by Esti et al., (1997) in the research of the Italian honey. This amount of total acidity does not meet the national standards which are slightly more stringent and allow 40 mmol/kg, while it is acceptable according to the standards of the EU (allowing the acidity of up to 50 mmol/kg). Honeys from this region can have a higher acidity than the national standards specify (Lazarević et al., 2012) in which the amount of acid in honey can range from 7.8 to 42.7 mmol/kg. Analyzed mixed honeys had a slightly higher acidity due to one sample that significantly exceeded standards (70.9 mmol/kg). The high acidity of honey may be a sign of poor storage or storage in inadequate packaging, so there was degradation of honey. Persano Oddo et al., (1995) stated 8-19 mmol/kg for the acidity of false acacia honey, and 17-57 mmol/kg for honeydew, depending on the origin of honeydew. In studies by Tucak et al., (2000), acidity was very similar to our results. The lower level of acidity was stated by Finola et al. (2007), and higher by Rodriguez et al. (2004).



Diastase activity (diastase number) was in average 14.2, the lowest in acacia honey and the highest in the honeydew. National standards do not allow that the diastase number be lower than 8, which was met by all analyzed samples. There are two samples (false acacia (8.3) and meadow (8.2)) which were very close to the lower limit but they meet the standard. Some authors report a considerably higher diastase number than the one obtained in our studies (Devillers et al., 2004; Kirsa et al., 2011). Very high diastase number (50.42) was found by Dezmiorean et al., (2010), in honey from common heather (*Calluna vulgaris*), and even higher value was found by Costa et al., (1999), in some honeys from Brazil.

The amount of reducing sugars ranged from 61.7% to 78.2%. The highest amount of reducing sugars was detected in mixed honey and the minimal was in honeydew. All honeys fulfilled standards that require that a minimum of reducing sugars be 65% in honey and not less than 60% in honeydew. Very similar results were given by Šarić et al., (2005) and Persano Oddo et al., (2004). Mladenović et al. (2012) found a somewhat higher amount of reducing sugars in honey, and Conti et al., (2007) reported significantly higher content (77.60 to 83.80%). Jevtić et al. (2002) have found that the natural honey contains 77.7% of reducing sugars.

Sucrose level depends on the degree of honey maturity, as well as on the origin of nectar. In all samples, the average level of sucrose was 3.43%. Considering that the standards allow for false acacia honey and honeydew of having up to 10% of sucrose, and all other honeys to have up to 5%, the analyzed samples showed no deviation from the standard. Very similar results were reported by Cantarelli et al. (2008) and Kirsa et al., (2011). Devillers et al. (2004) found a significantly lower percentage of sucrose, and Mladenović et al. (2012) found an even lower content than them (0.2%).

Analysis of variance in single-factor experiment showed that all differences between the different types of honey for all of the observed parameters were statistically significant ( $p < 0.05$ ) except for the amount of water in honey, where there was no significance (Table 1).

### Macro-elements in honey

The highest amount of nitrogen (N) was found in honeydew, while meadow and forest honey had nearly identical amounts of this element, and it was reduced in false acacia honey (Table 2). The amount of nitrogen had very high interval of variation that ranged from 150 mgkg<sup>-1</sup> in false acacia to 1120 mgkg<sup>-1</sup> in honeydew. The highest variation in the quantity of this element was determined in false acacia indicating an extremely high coefficient of variation (CV = 40.9%). For false acacia honey Jevtić et al., (2011) reported an average of 360 mgkg<sup>-1</sup> of N.

The amount of phosphorus (P) ranged from 48.0 to 73.3 mgkg<sup>-1</sup>. The highest P content was found in false acacia honey, and the lowest was in meadow honey, while the honeydew and mixed honey were quite similar considering this element in both the average and extreme values. Cantarelli et al. (2008) reported an average of 28.20 ± 20.64 mgkg<sup>-1</sup> of phosphorus, and Atanassova et al. (2009) indicated that the amount of phosphorus in honey from Bulgaria was in the range of 28.4 to 72.8 mgkg<sup>-1</sup>. Sulbarán de Ferrer et al. (2004) found significantly greater amount of P (1642 ± 32 mgkg<sup>-1</sup>) in the Venezuelan honey.

Table 2. Macro-elements in honey from Central Serbia

Honey type	Parameter-Element	N (mgkg <sup>-1</sup> )	P (mgkg <sup>-1</sup> )	K (mgkg <sup>-1</sup> )	Ca (mgkg <sup>-1</sup> )	Mg (mgkg <sup>-1</sup> )
False acacia	<b>Average</b>	<b>295.2</b>	<b>73.3</b>	<b>199.0</b>	<b>32.7</b>	<b>7.6</b>
	SD	119.2	26.9	149.3	15.3	9.4
	CV%	40.9	36.8	75.0	46.8	122.5
	Min-Max	150 - 540	0.0-120	62.8 – 602.7	3.9-54.6	0.6-47.2
	<b>Average</b>	<b>528.0</b>	<b>48.1</b>	<b>365.0</b>	<b>15.9</b>	<b>12.4</b>

<b>Meadow</b>	SD	141.7	8.7	778	9.3	13.0
	CV%	26.8	18.2	21.3	59.3	104.6
	Min-Max	220 - 680	40 - 60	254- 517	7.1-34.3	1.5-39.8
<b>Honeydew</b>	<b>Average</b>	<b>937.8</b>	<b>68.9</b>	<b>842.1</b>	<b>22.3</b>	<b>32.6</b>
	SD	216.6	31.4	257.3	13.3	17.1
	CV%	23.1	45.6	30.5	59.5	52.5
	Min-Max	520 - 1120	40-130	424-1272	8.2-41.8	2.8-57.7
<b>Mixed</b>	<b>Average</b>	<b>528.3</b>	<b>62.5</b>	<b>465.3</b>	<b>24.2</b>	<b>15.9</b>
	SD	153.9	30.6	144.8	11.3	6.3
	CV%	29.1	49.0	31.1	46.6	39.6
	Min-Max	340 - 820	40 - 130	351-772	12.6-44.6	8.5-27.7
<b>Total average</b>		<b>572.33</b>	<b>62.17</b>	<b>468.9</b>	<b>23.8</b>	<b>17.1</b>
<b>F-test</b>		34.41**	2.07 <sup>ns</sup>	29.62**	3.53*	8.68**

After the nitrogen which was the most represented of the analyzed elements, potassium (K) was found to be in the second place. The highest K content was found in honeydew, and the lowest was in false acacia honey, while mixed and meadow honeys were considerably more varied considering amounts of this element compared with the amount of phosphorus. False acacia honey had the least amount of K but it also showed the highest variation of this element (IV = 62.8 to 602.8 and CV = 75%). Slightly lower value for K, in relation to our research, was determined by Yilmaz & Yavuz (1999). Similar values for this element were found by Chakir et al., (2011), while Tucak et al., (2000) argue that in Croatia, dark honeys have much less K compared to the light honeys, which was not confirmed in our research. Substantially higher amounts of K in false acacia honey were noted by Gulfra et al., (2010).

In the observed honeys, an average of 23.8 mgkg<sup>-1</sup> of calcium was determined, the highest amount was in false acacia honey (32.67 mgkg<sup>-1</sup>), and the lowest in the meadow honey (15.9 mgkg<sup>-1</sup>). The amount of this element in honeydew and mixed honey was almost identical. The average amount of magnesium was 17.1 mgkg<sup>-1</sup>, the highest was in honeydew, and the lowest was in false acacia honey. Kirska et al. (2011) found twice as high Ca content while Mg content and intervals of variation of these elements in Lithuanian honey were very similar. Emmeretz (2010) in New Zealand honeydew found significantly lower calcium content (7.41 mgkg<sup>-1</sup>) and a significantly higher content of magnesium (86.33 mgkg<sup>-1</sup>).

Analysis of variance of single-factor experiment showed that the differences in the amount of N, K and Mg were highly significant (p <0.01), while in the Ca (p <0.01) they were significant, and the differences in the amount of P were not statistically significant.

### Micro-elements in honey

Considering micro-elements in the analyzed honeys, it was determined that Na had the highest presence of Na (Table 3), and Cu had the lowest, while the amounts of Fe, Mn and Zn were very similar. False acacia honey was full of sodium and iron while the other honeys have almost identical content of these two elements. False acacia and meadow honeys have the same amount of zinc, while honeydew and mixed honey had almost half as much of this element. Manganese amount was the highest in honeydew and the least was false acacia honey. Copper was found in nearly identical amounts in all analyzed honeys. Conti et al. (2007) found average of 6.28 mgkg<sup>-1</sup> of Fe, 0.59 mgkg<sup>-1</sup> and Mn of 1.15 mgkg<sup>-1</sup> Cu in false acacia, mixed honey and honeydew, which is quite different from the results obtained in our studies. While Atanassova (2009) states very similar results for the amount of Na, Fe, Mn and Zn in honey from Bulgaria. Bogdanov et al. (2007) found that mixed flower honey contains 5 times more iron and zinc, and twice as much manganese and copper in relation to the false

acacia honey. Stankovska et al. (2008) obtained 0.69 mgkg<sup>-1</sup> Cu in honey from Macedonia, which is as twice as in honey which was the object of our study. Analysis of variance showed that the differences in the amount of Na and Mg were very significant, and in an amount of Fe, Zn and Cu differences were not significant. Especially important is the amount of Mn in honeydew (about 3 mgkg<sup>-1</sup>), because by the consumption of 100 g of honey per day about 15-20% of a need for this element is satisfied (Food and Nutrition Board, 2000; Food and Nutrition Board, 2001).

Table 3. Micro-elements in honey from Central Serbia

Honey type	Parameter-Element	Na mgkg <sup>-1</sup>	Fe mgkg <sup>-1</sup>	Zn mgkg <sup>-1</sup>	Mn mgkg <sup>-1</sup>	Cu mgkg <sup>-1</sup>
<b>False acacia</b>	<b>Average</b>	<b>42.3</b>	<b>3.9</b>	<b>2.1</b>	<b>0.4</b>	<b>0.3</b>
	SD	16.3	4.0	0.9	0.7	0.2
	CV%	38.5	102.4	40.8	153.7	79.3
	Min-Max	16.1-81.3	1.4-20.2	0.6-3.4	0-3.4	0.1-0.8
<b>Meadow</b>	<b>Average</b>	<b>17.6</b>	<b>2.8</b>	<b>2.1</b>	<b>1.1</b>	<b>0.2</b>
	SD	8.9	1.5	1.9	0.8	0.1
	CV%	50.3	56.0	86.5	71.2	41.7
	Min-Max	10.7-42.5	1.4-6.9	0.6-7.1	0.2-2.6	0.1-0.4
<b>Honeydew</b>	<b>Average</b>	<b>17.7</b>	<b>3.0</b>	<b>1.3</b>	<b>3.0</b>	<b>0.3</b>
	SD	4.9	0.8	0.4	2.4	0.1
	CV%	27.9	26.7	31.4	79.9	23.1
	Min-Max	9.9-26.9	2.3-4.8	0.8-2.3	0.4-8.5	0.2-0.3
<b>Mixed</b>	<b>Average</b>	<b>17.9</b>	<b>2.8</b>	<b>1.1</b>	<b>1.1</b>	<b>0.3</b>
	SD	9.5	0.9	0.2	1.2	0.2
	CV%	52.9	32.7	19.7	112.0	72.7
	Min-Max	4.9-36.2	1.9-4.8	0.9-1.4	0.2-3.5	0.1-0.7
<b>Total average</b>		<b>23.9</b>	<b>3.1</b>	<b>1.7</b>	<b>1.4</b>	<b>0.3</b>
<b>F-test</b>		13.56**	0.42 <sup>ns</sup>	2.39 <sup>ns</sup>	7.42**	0.76 <sup>ns</sup>

### Conclusion

Based on the analysis of the quality of honey (false acacia, meadow, mixed and honeydew), produced on apiaries in Central Serbia the following conclusions can be drawn:

- The vast majority of the analyzed honeys are compliant to both domestic and EU standards that consider the quality of honey.
- Deviation existed in two samples of mixed honey considering total acidity which exceeded EU standards that are somewhat lower than domestic, and two samples of honeydew that exceeded national standards.
- Variance analysis shown that all of the observed parameters, except the amount of water, had significant differences depending on the type of the analyzed honey.
- False acacia honey had the highest amount of phosphorus, while honeydew had the highest amount of nitrogen and potassium.
- An analysis of variance revealed that differences in an amount of N and C in the different honeys were statistically significant.
- Of all observed micro-elements, false acacia honey had the highest amounts of Na and Fe, while meadow and false acacia honeys. Honeydew had the highest levels of Mn, while Cu was almost equally represented in all analyzed types of honey.

## Acknowledgments

The authors thank the Ministry of Education, Science and Technological Development of Republic of Serbia who funded this research as part of the project TR-31057.

## References

- Adekanmbi, O. H., & Ogundipe, O. (2009). Nectar Sources for the Honey Bee (*Apis mellifera adansonii*) Revealed by Pollen Content. *Notulae Botanicae Horti Agrobotanici Cluj-Napoca* 37(2):211-217.
- Atanassova, J., Yurukova, L., & Lazarova, M. (2009): Palynological, physical, and chemical data on honey from the Kazanlak region (Central Bulgaria). *Phytologica Balcanica* 15 (1): 107 – 114.
- Bogdanov, S. (2007): Bee products and health. Proceedings of XV Scientific Symposium with International Participation, "Production and promotion of honey and honeybees". 10-11 February. Faculty of Agriculture, Zemun, p. 95-108.
- Cantarelli, M.A., Pellerano, R.G., Marchevsky, E.J., & Camiña, J.M. (2008). QUALITY OF HONEY FROM ARGENTINA: STUDY OF CHEMICAL COMPOSITION AND TRACE ELEMENTS. *The Journal of the Argentine Chemical Society – Vol. 96 - N° (1-2)*, 33-41.
- Chakir, A., Romane, A., Barbagianni, N., Bartoli, D., & Paola, F.(2011). Major and Trace Elements in Different Types of Moroccan honeys. *Australian Journal of Basic and Applied Sciences*, 5(4): 223-231.
- Christov, V., & Silitskaya, N. (1952): Chemical composition of floral honeydew honeys. *Pchelovodstvo* 29: 14-16s.
- Codex Alimentarius (2001): Codex standard for honey codex stan 12-1981.
- Conti, M.E., Stripeikis, J., Campanella, L., Cucina, D., & Tudino, M. B. (2007). Characterization of Italian honeys (Marche Region) on the basis of their mineral content and some typical quality parameters. *Chemistry Central Journal* 2007 Vol. 1. 14. Published online 2007 June 7. doi: 10.1186/1752-153X-1-14.
- Costa, L. S. M., Albuquerque, M. L. S., Trugob, L. C., Quinteiro, L. M. C., Barth, O. M., & Ribeiro, M. (1999). Determination of non-volatile compounds of different botanical origin Brazilian honeys. *Food Chemistry*, 65, 347–352.
- Dezmirean, D., Marghitas, Al. L., Bobis, O., Stan, L., Bonta, V., Maghear, O., Dinita, G., & Morar, O. (2010). Physical-Chemical Attributes and Mineral Content of Heather Honey (*Calluna vulgaris*). *Bulletin UASVM Animal Science and Biotechnologies*, 67(1-2), 163-168.
- Devillers, J., Morlot, M., Pham-Delegue, M. H., & Dore, J. C. (2004). Classification of monofloral honeys based on their quality control data. *Food Chemistry*, 86, 305–312.
- Esti, M., Panfili, G., Marconi, E., & Trivisonno, M. C. (1997). Valorization of the honeys from the Molise region through physico-chemical, organoleptic and nutritional assessment. *Food Chemistry*, 58(1–2), 125–128.
- European Union Directive (EU). (2002). Council Directive 2001/110/EC relating to honey. *Official Journal of the European Communities*; L-10, 47-52.
- Finola, M. S., Lasagno, M. C., & Marioli, J. M. (2007). Microbiological and chemical characterization of honeys from central Argentina. *Food Chemistry*, 100, 1649–1653.
- Fraga C. G. (2005):Relevance, essentiality and toxicity of trace elements in human health. *Molecular Aspects of Medicine* 26, 235–244.

- Food and Nutrition Board, 2000. Dietary Reference Intakes for Vitamin C, Vitamin E, Selenium, and Carotenoids. National Academy Press, Washington, DC.
- Food and Nutrition Board, 2001. Dietary Reference Intakes for Vitamin A, Vitamin K, Arsenic, Boron, Chromium, Copper, Iodine, Iron, Manganese, Molybdenum, Nickel, Silicon, Vanadium, and Zinc. National Academy Press, Washington, DC.
- Golob, T., & Plestenjak, A. (1999). Quality of Slovene Honey. *Food technol. biotechnol.* 31 (3) 195-201.
- Gulfra, M., Iftikhar, F., Raja, S., Asif, S., Mehmood, S., Anwar Z., & Kaukob, G. (2010): Quality assessment and antimicrobial activity of various honey types of Pakistan. *African Journal of Biotechnology* Vol. 9(41), pp. 6902-6906.
- Haydak, M.H., Palmer, L.S., Tanqaray, M.C., & Vivini, A.E. (1942): Vitamin content of honey. *J. Nutr.* 23.
- Jevtić, G., Mladenović, M., Gajić, D. & Ignjatović, S. (2002): Production of express honey based on skimmed, non-fat milk and fruit juice. *Biotechnology in animal husbandry*, Vol.18, No 5-6, p. 343-349.
- Jevtić, G., Anđelković, B., Marković, J., Anđelković, S., & Nedić, N. (2011): Quality of false acacia honey from Rasina district in Serbia. 1th World Congress on Hygienic Engineering and Design, Ohrid, Republik of Macedonia 22-24. September. *JOURNAL OF HYGIENIC ENGINEERING AND DESIGN*, 278-283.
- Kahraman, T., Buyukunal, S.K., Vural, A., & Altunatmaz, S.S. (2010). Physico-chemical properties in honey from different regions of Turkey. *Food Chemistry*; Vol.123, Issue 1, 41-44.
- Kirsa, E., Palla, R., Martverka, K., & Laosa, K. (2011). Physicochemical and melissopalynological characterization of Estonian summer honeys. 11th International Congress on Engineering and Food (ICEF11), 22-26 May, Athens, Greece. *Procedia Food Science* 1, 616-624.
- Kitzes, G., Schuette, H.A., & Elvehjem, C.A. (1943): The B vitamins in honey. *J. Nutr.* 26:(3), 241-250.
- Lazarević, B K., Andrić, F., Trifković, J., Tešić, Ž., & Milojković-Opsenica, D. (2012). Characterisation of Serbian unifloral honeys according to their physicochemical parameters. 6th International Conference on Water in Food. *Food Chemistry* Volume 132, Issue 4, 2060–2064
- Marghitas, L. A., Dezmirean, D. S., Pocol, C. B., Ilea, M., Bobis, O., & Gergen, I. (2010): The Development of a Biochemical Profile of Acacia Honey by Identifying Biochemical Determinants of its Quality. *Not. Bot. Hort. Agrobot. Cluj* 38 (2), Special Issue, 84-90.
- Mendes, E., Brojo, P. E., Ferreira, I. M. P. L. V. O., & Ferreira, M. A. (1998). Quality evaluation of Portuguese honey. *Carbohydrate Polymers*, 37(3), 219–223.
- Mladenović, M., Milosavljević, S., Dugalić-Vrndić, N., & Keckeš, J. (2012). Chemical quality parameters of the commercial Serbian unifloral honeys. *Apimondia Symposium APIECOTECH “The Role of Beekeeping Technologies, Health Care of Beest and Environment in the Quality of Bee Products February 18-19, Belgrade, Serbia*, 80-89.
- Nedić, N., Mladenović, M., & Rašić, S. (2007): Study of some quality parameters of forest on the market. *Proceedings of XV Scientific Symposium with International Participation, “Production and promotion of honey and honeybees”*. 10-11 February. Faculty of Agriculture, Zemun, p. 136-141.
- Nelson, E.K., & Mottern, H.H. (1931): Some organic acids in honey. *Ind. Eng. Chem.* 23, (3), pp 335-336.
- Persano, Oddo, L., Piazza, M.G., Sabatini, A.G., & Accorti, M. (1995). Characterization of unifloral honeys. *Apidologie.* 26, 453-465.

- Persano, Oddo, L., & Piro, R. (2004). Main European unifloral honeys descriptive sheets. *Apidologie*, 35:S38-S81.
- The Official Gazette SCG (2003): Rulebook on quality and other requirements for honey, products based on honey and other honeybee products. The Official Gazette SCG 45/03.
- Rodriguez, G. O., Ferrer, B. S., Ferrer, A., & Rodriguez, B. (2004). Characterization of honey produced in Venezuela. *Food Chemistry*, 84, 499–502.
- Stankovska, E., Stafilov, T., & Šajn, R. (2008). Monitoring of trace elements in honey from the Republic of Macedonia by atomic absorption spectrometry. *Bulletin of Environmental Monitoring and Assessment*, Volume 142, Numbers 1-3, 117-126.
- Sulbarán de Ferrer, B., Ojeda de Rodríguez, G., Peña, J., Martínez', J., & Morán, M. (2004). Mineral content of the honey produced in Zulia state. Venezuela. *Archivos Latinoamericanos de Nutricion*. Volumen 54, Numero 3. 14. 114-122.
- Thrasylvoulou, A., & Manikis, J. (1995): Some physicochemical and microscopic characteristics of Greek unifloral honeys. *Apidologie*, 26, 1995., 441-452.
- Tucak, Z., Tucak, A., Puškadija, Z., & Tucak, M. (2000). NUTRITIOUS – HEALING STRUCTURE OF SOME KINDS OF HONEY IN EASTERN CROATIA. *Poljoprivreda /Agriculture*. 6(1), 129-131.
- White, J.W. Jr. (1975). COMPOSITION AND PHYSICAL PROPERTIES OF HONEY In E. Crane, ed., *Honey Review*, p. 157-239. Heinemann, London.
- Yilmaz, H., & Yavuz, O. (1999). Content of some traces metals in honey from southeastern Anatolia. *Food Chemistry*, 65, 475–476.
- Šarić, G., Matković, D., Hruškar, M., & Vahčić, N. (2008). Characterization of Croatian Honey by Physicochemical Parameters. *Food Technol. Biotechnol.* 46, (4) 355–367.

## EFFECT OF DRYING MODE ON THE CHANGES OF VIRGINIA TOBACCO TYPE CHEMICAL COMPOSITION

Gordana KULIĆ\*, Vesna RADOJIČIĆ, Nemanja MANDIĆ, Maja MALNAR

University of Belgrade, Faculty of Agriculture, Belgrade – Zemun, Serbia

\*Corresponding author: gkulic@agrif.bg.ac.rs

### Abstract

Virginia type of tobacco is used in the highest percentage in the mixture for making cigarettes. Important factors for the formation of quality features of Virginia are environmental conditions of manufacturing but preferably the well regulated drying process. Drying of these tobacco types is performed in special dryers with controlled conditions (flue curing-FC). Since the price of energy source for drying process participate the greatest deal in total expenses during the production and processing of tobacco, the scope of the experiment was to determine the possibilities of drying tobacco in a natural condition (air curing-AC).

Material for research the first-class middle leaves of Virginia tobacco type, variety Heveshi - 9, were produced in Vojvodina area (Srem - Maradik), vintage 2015.

The experimental results showed that the way of drying affects the appearance and color of leaves, chemical characteristics of tobacco and duration of the drying process. Considerable differences of chemical composition between flue curing and air curing tobacco were found as follows (% in dry matter): 2.03 and 2.25 (nicotine), 1.80 and 2.73 (total N), 0.87 and 2.06 (protein N), 5.46 and 6.60 (total proteins), 19.39 and 1.96 (reducing sugars), 11.61 and 15.43 (ash), 1.48 and 8.91 (sand), 5.19 and 5.92 (pH), respectively. The leaves dried in natural condition (AC) had dark color (dark Virginia) and rough nervation. Although drying in a natural condition brings cost savings in energy, the process is longer by 24 days comparing to flue curing.

**Keywords:** *drying, flue-curing (FC), air curing (AC), Virginia, chemical composition*

### Introduction

First steps in production of Virginia in the Republic of Serbia were taken in 1960's (Popović, 2000). More intensive production began in the eighties and has continued until today.

Virginia type of tobacco contains large leaves; it has lemon yellow to golden yellow color, specific flavor and pleasant tobacco smell. This type of tobacco represents a very important component in a blend for the cigarettes. Due to the high content of soluble carbohydrates, Virginia tobacco is the main precursor for the components which contribute to the taste of tobacco smoke. In addition, this type of tobacco has good cutting properties, which makes it a binding material inside the cigarette and makes it prevent falling other components out of cigarette. Mentioned properties are influenced either by genetics or the curing method. Virginia tobacco type, due to its characteristics, is used in the preparation of high quality cigarette blends of American type (in which may comprise up to 60% of mixture), and exclusively as a material for the cigarettes of English (the Virginia type).

Due to increasing yearly demands for this tobacco type on both, domestic and foreign markets, it is important to determine processing parameters influencing significantly on obtaining the raw material of highest possible quality. The significance of Virginia tobacco type resembles in technological properties such as voluminous and combustion properties, percent of fibre and fractions, but first of all in its taste, which makes this tobacco

indispensable raw material in the production of cigarettes (Radojičić, 2016). Based on data of Statistical Office of the Republic of Serbia, the total yield of Virginia tobacco in year 2014 was 9341 tons, in year 2015 it was 8776 tons (Statistical Yearbook of the Republic of Serbia, 2016).

Due to morphological characteristics, Virginia tobacco type has large leaves. In accordance with technological classification it belongs to FC types of tobacco, i.e. type of tobacco that is dried under controlled conditions (in special dryers), in which drying parameters can be regulated.

Tobacco production requires a lot of work from the beginning of seeding, transplanting, cultivating of the crops, harvesting stringing, drying and delivering of yellow leaves. The quantity and the quality of the leaf, after drying, affect its use value. Drying tobacco is often crucial operation that defines quality, and hence the selling price. For all mentioned reasons it is important to apply the optimal drying regime, which for Virginia tobacco type is drying in a stream of conditioned air (Popović, 2000). However, for this method of drying, the largest shares in production expenses are energy costs. They comprise from 26 to 28% of the total costs (Radojičić, N. 2011), which is understandable due to high price of energy sources and high consumption per unit of product (1m<sup>3</sup> of natural gas is consumed for drying of 1 kg of tobacco). Besides, the high price of the dryer is also large expense for the middle size producer. Therefore the scope of this work was to examine the possibilities of other methods of curing Virginia type of tobacco.

In developing countries, due to lack of funds for the purchasing of energy sources, drying in natural conditions (in the sun or in the shade) are widely spread. It is known that Virginia tobacco type can be dried in the sun. Under conditions of this type of drying, the leaf has darker color, and they are mainly used for making the mixture for a pipe or cigar (Voges, 1984). However, the literature review authors found no data about air curing of Virginia tobacco type. Therefore, the aim of this experiment was to determine the possibilities of drying the Virginia in the natural condition (AC), and to compare the chemical properties to properties of a standard tobacco dried in the special dryers. These results may indicate the possible use value of this raw material relevant to the manufacturers.

### **Materials and methods**

As a material in this work the first-class leaves of medium insertion of Virginia tobacco type, the variety Heveshi - 9, produced in the Vojvodina area (Srem - Maradik), of harvest year 2015 were used. The leaves are harvested at the stage of technological maturity, strung and dried in two different ways:

- The first sample was dried in the special dryer T - 42, under a stream of heated air, in a controlled condition (FC).
- The second sample is dried under the influence of the ambient air, in the shade, without the influence of additional sources of heat (AC).

Chemical parameters were determined by methods described in sources as follows: nicotine (ISO, 2881, 2007), total nitrogen, protein nitrogen and total proteins (Radojičić, 2011), reducing sugars (SRPS E.P3.115, 1965), ash (SRPS E.P3.117, 1965), sand (ISO 2817, 2007) and pH (SRPS E.P3.116, 1965).

The experiment was carried out in Maradik, municipality of Inđija. Analysis of chemical quality parameters of dried leaves was carried out in the Tobacco Laboratory, Faculty of Agriculture, and University of Belgrade. Methods used are given in Table 1. All analyzes were done in five repetitions. Data obtained from the experiments were analyzed and the results were expressed as mean value  $\pm$  SD. Statistics were performed using SPSS 17.0 t - test to compare differences between samples.



## Results and discussion

Results showed that the applied methods of drying affect the color of dried leaves, the changes in chemical characteristics of tobacco and duration of the drying process.

- The leaves dried in a special dryer T- 42 with heated air, under controlled conditions had a light yellow color (bright Virginia) with a fine and thin nervature.
- The leaves dried in a natural condition (AC) had dark color (dark Virginia), rough nervature.
- The drying process under controlled conditions lasted for 127 hours (6 days) and the air curing process lasted for 30 days.

Table 1 shows the mean values of the studied chemical characteristics of the Virginia tobacco type, dried in two different ways.

Table 1. Chemical composition of Virginia tobacco type (% in dry matter)

Drying	Nicotine	Total nitrogen	Protein nitrogen	Total proteins	Reducing sugars	Ash	Sand	pH
Flue curing	2.03	1.80	0.87	5.46	19.39	11.61	1.48	5.19
Air curing	2.25	2.73	2.06	6.60	1.96	15.43	8.91	5.92

\* pH in units

Based on the results shown in Table 1, it is clearly seen that the mean values of six parameters observed (nicotine, total nitrogen, protein nitrogen, total proteins, ash, and sand) are higher in tobacco dried in natural condition (AC) comparing to FC. In contrast, the content of reducing sugars and the pH value are lower for tobacco, dried in natural conditions (AC).

Statistical comparison of the chemical characteristics of tobacco in relation to the method of drying is presented in Tables 2 and 3.

Based on the ANOVA test, it can be concluded that there is a statistically significant difference between the mean values of the chemical composition depending on the applied drying process. In terms of the content of nicotine and pH value there is significant difference at the 0.05 level, while for all other components difference is significant at the 0.01 level.

Among samples, the lowest difference was observed in the content of nicotine (0.22). The difference in the content of total nitrogen is 0.93. This is indication that physiological strength and sharpness of tobacco smoke dried in a natural condition (AC) is different comparing to FC. Beljo et al. (1998) reported that the content of total nitrogen in the Virginia tobacco can be in the range between 1.53%-2.38%. Based on the values shown in Tables 1 and 3 it can be concluded that drying in natural conditions (AC) yields the increased value of total nitrogen. As drying process influences the changes in the content of total proteins in leaf, it means that drying is a critical step in processing. In the dark Virginia content of total proteins is increased by 1.41 compared to bright Virginia. It is considered that the optimum value for the highest quality of flue cured tobacco between 4.5%-5.5% (Stanković, 2000). The data from Tables 1 and 3 indicate more extensive degradation of total proteins affected by drying in a stream of heating air.

Table 2. Descriptive Statistics

	Group Statistics				
	Sample	N	Mean	Std. Deviation	Std. Error Mean
Nicotine	Virginia bright	5	2.0300	.03606	.02082
	Virginia dark	5	2.2533	.04726	.02728
Total nitrogen	Virginia bright	5	1.8033	.04509	.02603
	Virginia dark	5	2.7333	.04933	.02848
Protein nitrogen	Virginia bright	5	.8700	.03000	.01732
	Virginia dark	5	2.0633	.04509	.02603
Total proteins	Virginia bright	5	5.4600	.04583	.02646
	Virginia dark	5	6.6033	.00577	.00333
Reducing sugars	Virginia bright	5	19.3933	.44433	.25654
	Virginia dark	5	1.9567	.03512	.02028
Ash	Virginia bright	5	11.6133	.03215	.01856
	Virginia dark	5	15.4333	.16442	.09493
Sand	Virginia bright	5	1.4833	.04933	.02848
	Virginia dark	5	8.9133	.05033	.02906
pH	Virginia bright	5	5.1900	.05568	.03215
	Virginia dark	5	4.9200	.04359	.02517

Table 3. Independent Samples Test

	Levene's Test for Equality of Variances		t-test for Equality of Means				
	F	Sig.	t	df	Sig. (2-tailed)	Mean Difference	Std. Error Difference
Nicotine	.416	.554	-6.508	4	.003*	-.22333	.03432
Total nitrogen	.153	.716	-24.102	4	.000**	-.93000	.03859
Protein nitrogen	.420	.552	-38.163	4	.000**	-1.19333	.03127
Total proteins	5.729	.075	-42.875	4	.000**	-1.14333	.02667
Reducing sugars	11.060	.029	67.758	4	.000**	17.43667	.25734
Ash	7.613	.051	-39.494	4	.000**	-3.82000	.09672
Sand	.016	.906	-182.607	4	.000**	-7.43000	.04069
pH	.143	.725	6.614	4	.003*	.27000	.04082

\*\* p< 0.01

\*p< 0.05

The most prominent difference among samples is in the content of reducing sugars. For bright Virginia type, sugar content is 19.39%, while for dark it is only 1.96% (Table 1). The difference of 17.44 (Table 3) shows that longer drying process caused an almost complete breakdown of the reducing sugars (Brown, 1990). According to Dixon (2000), pH value for Virginia tobacco is between 5 and 6. Based on values in Table 1, the pH value for the sample of bright Virginia was lower (5.19), in comparison with the sample of dark Virginia (5.92). This result is a direct consequence of the extremely large reduction of reducing sugars compared to a slight increase in the content of nitrogen compounds. Alteration of these parameters indirectly causing a sense of sharpness and a stronger smoke during inhalation. The difference in ash content is 3.82 (Table 3). A sample of bright Virginia has proportionately smaller amount of mineral matter comparing to the dark Virginia, which means that the decomposition of organic matter during drying in a natural condition (AC) was more complete. The resulting ash content in both experimental samples was within the limits for Virginia type of tobacco (Alić-Džemidžić et al., 2002; Radojičić, 2016). Sand content was significantly higher in the dark Virginia (difference is 7.43), almost beyond all known

literature data. It is assumed that the sample had significantly more impurities because drying in an unprotected area.

### **Conclusion**

Based on the results of this research which aim was to figure the possibilities of curing Virginia tobacco type under natural conditions (AC) it can be concluded:

Significant differences in the duration time of the drying process exist, as well as difference between sensory and chemical characteristics among Virginia tobacco type dried in a conventional manner (in a special dryer) compared with tobacco dried in natural condition (AC).

Although drying in a natural condition (AC) brings cost savings in energy, the process is longer by 24 days compared to drying in a special dryer. Leaves dried in special dryers under controlled conditions had light yellow color (bright Virginia) with a fine and thin nervature, whereas those dried in natural condition had dark color (dark Virginia) and rough nervature.

Nicotine, total nitrogen, protein nitrogen, total proteins, ash, and sand were higher in tobacco dried in shadow (AC), but reducing sugars and pH value were smaller. As a general conclusion can be observed that drying of Virginia in natural condition is completely changing its sensory and chemical properties, which is the reason of approaching to the characteristics of dark tobacco.

### **Acknowledgments**

Authors are grateful to the Ministry of Education, Science and Technology Development of Republic of Serbia, for their support (Project No. 46010).

### **References**

- Alić-Đemidžić, N., Beljo, J., Velagić-Habul, E. (2002). Practicum for quality control in tobacco industry. Tobacco factory, Sarajevo. [in Bosnian]
- Brown, C. L. (1990). The Design of Cigarette. North Carolina.
- Beljo, J., Delač, S., Vuletić N. (1998). The quality of flue-cured tobacco depending on visual indicators produced in Croatia. *Agricultural Scientific Review*, 63(4), 213-218. [in Serbian]
- Dixon, M., Lambing, K., Seeman, J.I. (2000). On the Transfer of Nicotine from Tobacco to the Smoker. A Brief Review of Ammonia and „pH” Factors. *BeitrTabakforschInt* 19 (2), 103-113.
- SRPS E.P3.115, (1965). Chemical methods for testing quality of tobacco raw materials and products – Determination of reduced material content in tobacco.
- SRPS E.P3.116, (1965). Chemical methods for testing quality of tobacco raw materials and products – Determination of pH values in tobacco.
- SRPS E.P3.117, (1965). Chemical methods for testing quality of tobacco raw materials and products - Determination of ash content in tobacco.
- Popović, R. (2000). Production of Virginia tobacco type, book. TAKT, Belgrade. [in Serbian]
- Radojičić, V. (2011). Quality control of tobacco. Practicum in Tobacco Processing Technology. University of Belgrade, Faculty of Agriculture, Belgrade. [in Serbian]
- Radojičić, N. (2011). Production of tobacco - organizational and economic aspects. *Bulletin for alternative plant species*, 43(84), 1-24. [in Serbian]
- Radojičić, V. (2016). Tobacco technology, book. University of Belgrade, Faculty of Agriculture, Belgrade. [in Serbian]

- SRPS ISO 2881,(2007).Tobacco and tobacco products – Determination of alkaloid content – Spectrometric method.
- SRPS ISO 2817,(2007).Tobacco and tobacco products – Determination of silicated residues insoluble in hydrochloric acid.
- Stanković, T. (2000).Technological characteristics and use value of certain varieties of Virginia produced in Yugoslavia, *Tutun Tobacco*50 (11-12), 248-269.
- Statistical Yearbook of the Republic of Serbia, Statistical Office of the Republic of Serbia 2016. [in Serbian]
- Voges, E. (1984).Tobacco Encyclopedia. Part II, Articles. *Tobacco Journal International*, Germany.

## EFFECTIVENESS OF *PSEUDOMONAS CHLORORAPHIS* K24 AGAINST *RHIZOCTONIA ZEA*E ISOLATED FROM CORIANDER SEEDS

Dragana JOŠIĆ<sup>1</sup>, Snežana PAVLOVIĆ<sup>2</sup>, Mira STAROVIĆ<sup>3</sup>, Magdalena KNEŽEVIĆ<sup>1\*</sup>, Aleksandra STANOJKOVIĆ-SEBIĆ<sup>1</sup>, Radmila PIVIĆ<sup>1</sup>

<sup>1</sup>Institute of Soil Science, Teodora Drajzera 7, 11000 Belgrade, Serbia

<sup>2</sup>Institute for Medical Plant Research "Dr Josif Pančić", Tadeuša Koščuška 8, 11000 Belgrade, Serbia

<sup>3</sup>Institute for Plant Protection and Environment, Teodora Drajzera 9, 11000 Belgrade, Serbia

\*Corresponding author: knez.magdalena@gmail.com

### Abstract

Coriander (*Coriandrum sativum* L.) is an annual herb that belongs to the *Apiaceae* family. This herb is used for treating various diseases and disorders in the folk medicine over the century. The ripe fruits have a distinctive sweet citrus-mint aroma and have been valued as a spice. *Rhizoctonia* sp. is a plant-pathogenic fungus which attacks a wide range of crop and aromatic plants, including coriander. *Rhizoctonia* persists in the soil in a form of resistant sclerotia. *R. solani* causes damping-off disease on coriander; seeds and seedlings are particularly susceptible to this fungus. The aim of this study was to test various *Pseudomonas* strains and their extracellular products on the growth of phytopathogenic fungi isolated from coriander seeds and to evaluate several strains as potential biocontrol agents. *Rhizoctonia zea*e was isolated from infected seeds and characterized based on macroscopic and microscopic morphology. Among 142 strains of *Pseudomonas* spp., only 11 showed inhibition of fungal growth. *P. chlororaphis* strain K24 was the most effective, showing the fungal growth inhibition in all tested fraction: 65.86% for cell culture ( $10^6$  CFUml<sup>-1</sup>), 57.77% for cell-free supernatant (CFS), 55.77% for CFS-EDTA and 50.48% for thermo-stable fraction of cell-free supernatant. Because of its strong inhibition activity toward *Rhizoctonia zea*e, *P. chlororaphis* strain K24 can be used in seeds treatment to enable fungi-clean seeds and to prevent the introduction of the disease into new fields.

**Keywords:** *Coriandrum sativum* L., seed infection, *Rhizoctonia zea*e, *Pseudomonas chlororaphis*, antifungal activity.

### Introduction

Plant pathogenic fungi are one of the most pronounced issues in modern agriculture. During the last century, different kinds of pests and chemicals were massively used for suppression of plant pathogenic fungi which cause crop deterioration. However the excessive use of pests and chemicals which are necessary for good yield, can induce negative side effects in the field, and can even potentially cause crop failure. Microbiological biocontrol aroused as one of the most promising strategies for suppressing phytopathogenic fungi, without using potentially harmful chemicals (Whipps, 2001).

Coriander is an annual herb, which can be planted during summer or winter. Fruits and green parts of the plant are used as folk medicine for treating external ulcers, halitosis and rheumatism and for improving general health of the digestive tract (Diederichsen A., 1996). Coriander leaves are proven to be a valuable source of polyphenols and as natural antioxidants (Wangensteen et al., 2004). Essential oils isolated from coriander plant have strong antimicrobial activity against pathogenic microorganisms such as bacteria from *Bacillus*, *Clostridium*, *Enterobacter*, *Erwinia*, *Escherichia*, *Klebsiella*, *Staphylococcus*,

*Streptococcus* genus (Baratta et al., 1998). Coriander is also highly valued as spice due to its pleasant flavour determined by specific essential oil composition.

*Rhizoctonia* sp. is plant-pathogenic fungi which attack a wide range of crop and aromatic plants. This fungus is a natural disease-inducing agent of coriander plants which induce crop deterioration. *Rhizoctonia* sp. is known as stalk rot pathogen which induces plant diseases such as seed decay, dumping of seedlings, root rot, hypocotyl and stem cankers (Parmeter J.R., 1970).

Some of the bacteria which belong to *Pseudomonas* genus have been already used as microbiological fungal control agents against wide spectra of fungal species, including *Rhizoctonia*. *P. chlororaphis* produces substances such as antibiotics phenazines (phenazine-1-carboxamine, phenazine-1-carboxylic acid, 2-hydroxy-phenazine-1-carboxylic acid, 2-hydroxy-phenazine), enzymes (chitinases, proteases, etc) and hydrogen cyanide, which probably underlie its strong antifungal activity (Chin-A-Woeng et al., 2005; Pierson and Pierson, 2010).

The aim of this study was to test various *Pseudomonas* strains and their extracellular products on the growth of phytopathogenic fungi isolated from coriander seeds and to evaluate several strains as potential biocontrol agents and to determine whether it can be used in seeds treatment to enable fungi-clean seeds and to prevent the introduction of the disease into new fields.

### Material and Methods

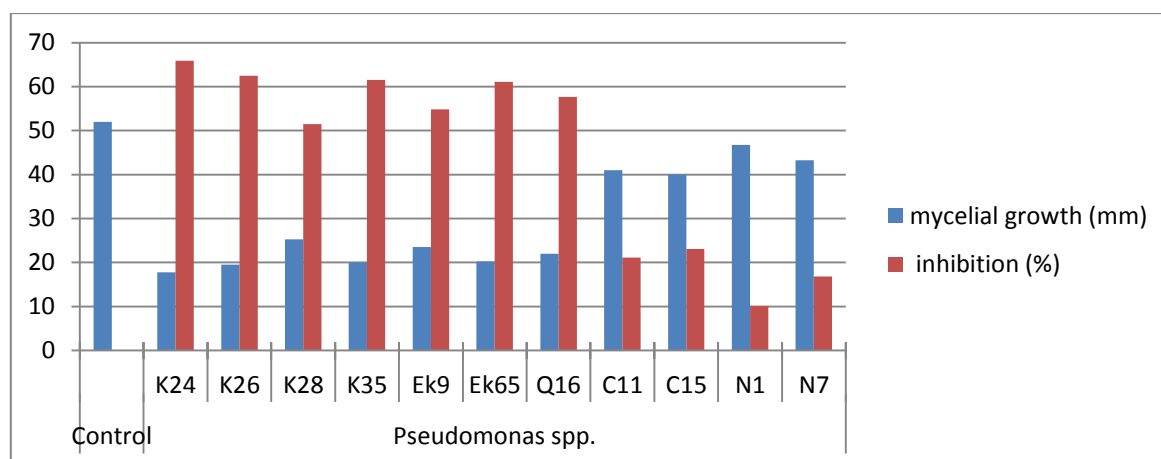
Coriander (*Coriandrum sativum* L.) seeds were obtained from Institute for Medical Plant Research "Dr Josif Pančić", Serbia. *Pseudomonas* spp. strains used in this research are a part of III46007 Project collection, Institute of Soil Science, Belgrade, Serbia.

Initial screening of 142 bacterial isolates was performed in order to determine the best bacterial inhibitors to be used in further research. *P. chlororaphis* K24, as the most efficient strain from initial screening, was tested in a form of cell culture ( $10^6$  CFUml<sup>-1</sup>), cell-free supernatant (CFS), CFS-EDTA and heat-stable fraction of cell-free supernatant (HSAF). Cells-free supernatant fraction was obtained by centrifuging bacterial suspension ( $10^6$  CFUml<sup>-1</sup>) at 13000 rpm for 5 min. Supernatant was then re-centrifuged in centrifugal filter tubes with 0.22 µm micro-porous membrane (Millipore). CFS-EDTA was obtained by adding 1 mM EDTA in CFS. Thermo-stable fraction of cell-free supernatant was obtained by heating bacterial supernatant at 70°C for 30 min.

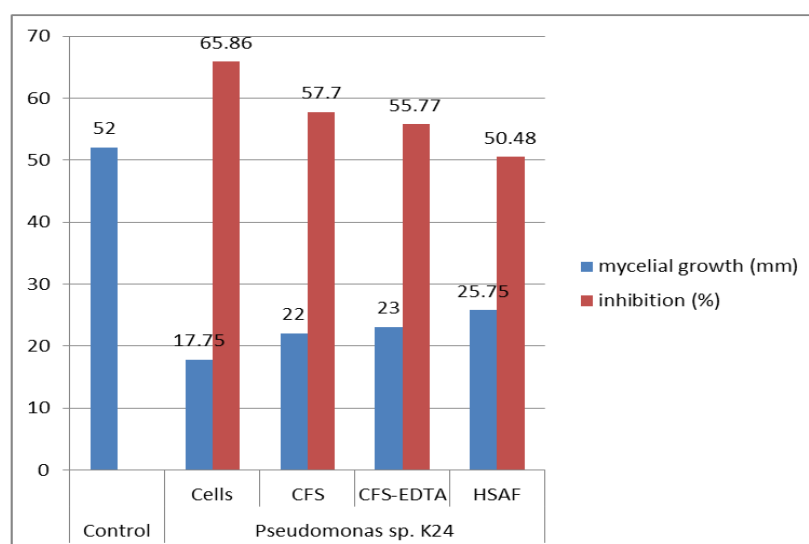
*Rhizoctonia zeae* was isolated from infected seeds and characterized based on macroscopic and microscopic morphology. Experiment was performed on Waksman agar (Minkwitz and Berg 2001). For the control sample, only fungus was applied on the centre of Petri dish. For test samples, *R. zeae* was also applied on the centre, while 10 µl ( $10^5$  CFUml<sup>-1</sup>) of different fractions of *P. chlororaphis* were applied in a form of drops, near the edges of Petri dish. Test and control samples were then incubated on 26°C, for 7 days. After incubation, the growth of *R. zeae* was measured in mm, and percentage of inhibition for each bacterial fraction was calculated by the following formula: % Inhibition = [(Control - Treatment)/Control] x 100 (Ogbebor and Adekunle, 2005). Each test was performed in two independent experiments and results were expressed as mean values.

## Results and Discussion

Based on the results of initial screening, only 11 out of 142 tested strains showed inhibitory activity against *R. zae*. Out of 11 strains with antifungal activity, *P. chlororaphis* K24 showed the best results, and was selected for further examination in this research (Figure 1). All tested fractions of this strain showed strong potential in reduction of fungal growth (Figure 2). Cell culture in concentration of  $10^6$  CFUml<sup>-1</sup> showed the best potential and reduced fungal growth for 34.25 cm in comparison with the control. CFS-EDTA and CFS gave similar results, and reduced fungal growth for 29 and 30 cm, respectively. HSAF showed the weakest potential and reduced fungal growth for 56.25 cm, in comparison with control.



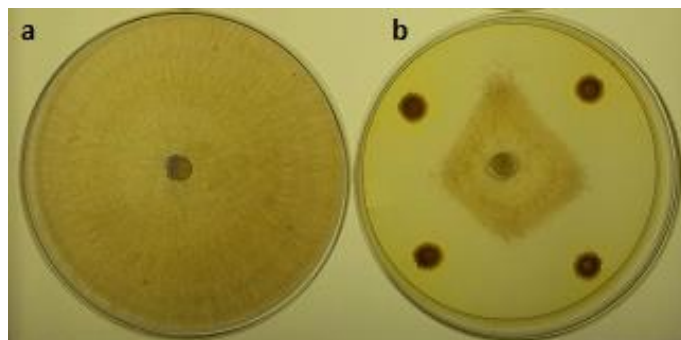
**Figure 1.** Antifungal activity of *Pseudomonas* spp. strains toward *Rhizoctonia zae*



**Figure 2.** Growth and inhibition of *Rhizoctonia zae* by cell culture and culture fraction of *Pseudomonas chlororaphis* K24

All tested fractions showed strong inhibition potential against *R. zae* (Figure 3). Inhibition rate for all fractions was over 50% (Figure 2). Cell culture inhibited the growth of *R. zae* up to 65.86% and displayed the best activity. Values of inhibition of fungal growth for CFS and

CFS-EDTA were similar (57.7% and 55.77%, respectively). HSAF had the weakest activity of all tested fractions, with inhibition of fungal growth up to 50.48%.



**Figure 3.** Reduction of fungal growth

a: *Rhizoctonia zeae* ; b: *Rhizoctonia zeae* and *Pseudomonas chlororaphis* K24

There are few studies showing that bacteria from the *Pseudomonas* genus can be used for biocontrol of *Rhizoctonia*. A study conducted on *P. fluorescens* and *R. solani* isolated from rice seeds indicated that the strong antifungal activity of *P. fluorescens* against this pathogen is probably caused by high levels of bacterial metabolites such as  $\beta$ -1,3-glucanase, salicylic acid and hydrogen cyanide (Nagarajkumar et al., 2004). Similar results were obtained in another study by using the same strain (Garbeva et al., 2004). It was found that the production of chitinases probably underlies the strong antifungal effects of *P. fluorescens* against *R. solani* isolated from potato. A study conducted by Berta et al. (2005) indicated that *P. fluorescens* can inhibit intraradical root infections up to 92.3% in tomato, caused by *R. solani*. Treating coriander seeds with *Pseudomonas* spp. strains in a form of foliar spray or talk reduces incidence of crown gall up to almost 50% (Kumar et al., 2014). In the same study, it was also shown that treating seeds with *Trichoderma* spp. have slightly better effect on reducing crown gall incidence, in comparison with *Pseudomonas* spp. treatment. Applied to coriander seeds, *P. putida* reduces wild incidence up to almost 90%, and also increases plant height, weight and overall yield (Singh et al., 2010).

Our previous research indicated that *P. chlororaphis* K24 strain is also efficient against *Alternaria* sp., *Phoma* sp. and *Drechslera tetramera* isolated from anise seeds, with inhibition of fungal growth up to 40%, 50% and 69.23%, respectively (Stanojkovic Sebic et al., 2015). Zdravkovic and authors (2015) have also tested inhibitory effects of *P. chlororaphis* K24 strain fractions against *Fusarium acuminatum*, *Botrytis cinerea* and *Aspergillus niger* isolated from cucumber. K24 strain was the most efficient bacterial strains tested, with inhibition of fungal growth up to 81.49%. Furthermore, K24 had the strongest inhibitory effect against all tested pathogens when tested in a form of cell culture. This strain also had the weakest activity when applied as HSAF against *F. acuminatum*, *Botrytis cinerea*, which also corresponds to results obtained in our study.

### Conclusions

Cell culture of *P. chlororaphis* K24 in a concentration of  $10^6$  CFUml<sup>-1</sup> can be considered as a strong inhibitor of *R. zeae* growth. CSF and CSF-EDTA fractions had similar intermediate effect, while HSAF showed the weakest activity against this pathogen. Due to its strong inhibition activity against *Rhizoctonia zeae*, *P. chlororaphis* strain K24, especially when applied as a cell culture, can be used in seeds treatment for preventing fungal growth, and for



prevention of disease introduction into the new fields. Further research is necessary in order to examine all potentially beneficial properties of K24 strain.

### **Acknowledgements**

This research was financially supported by the Ministry of Education, Science and Technological Development of the Republic of Serbia, as a part of Project III46007.

### **References**

- Baratta M.T., Dorman H.J., Deans S.G., Biondi D.M., Ruberto G. (1998). Chemical Composition, Antimicrobial and Antioxidative Activity of Laurel, Sage, Rosemary, Oregano and Coriander Essential Oils. *Journal of Essential Oil Research*, 10(6), 618-627.
- Berta G., Sampo S., Gamalero E., Massa N., Lemanceau P. (2005). Suppression of Rhizoctonia Root-rot of Tomato by *Glomus mossae* BEG12 and *Pseudomonas fluorescens* A6RI Is Associated with Their Effect on the Pathogen Growth and on the Root Morphogenesis. *European Journal of Plant Pathology*, 111 (3), 279-88.
- Chin-A-Woeng T.F.C., Broek D., Lugtenberg B.J.J., Bloemberg G.V. (2005). The *Pseudomonas chlororaphis* PCL1391 Sigma Regulator *psrA* Represses the Production of the Antifungal Metabolite Phenazine-1-Carboxamide. *The American Phytopathological Society*, 18(3), 244-253.
- Diederichsen A. (1996). Coriander (*Coriandrum sativum* L.). Promoting the conservation and use of underutilized and neglected crops. Institute of Plant Genetics and Crop Plant Research, Gatersleben/ International Plant Genetic Resources Institute, Rome.
- Garbeva P., Veen J. A., Elsas J.D. (2004). Assessment of the diversity, and antagonism towards *Rhizoctonia solani* AG3, of *Pseudomonas* species in soil from different agricultural regimes. *FEMS Microbiology Ecology*, 47(1), 51-64.
- Kumar G., 2, Yadav S.K., Patel J.S., Sarkar A., Awasthi L.P. (2014). Management of Stem Gall Disease in Coriander Using *Pseudomonas* and *Trichoderma* (Bioagents) and Fungicides. *Journal OF Pure and Applied microbiology*, 8(6).
- Minkwitz A., Berg G. (2001). Comparison of antifungal activities and 16S ribosomal DNA sequences of clinical and environmental isolates of *Stenotrophomonas maltophilia*. *Journal of Clinical Microbiology*, 39, 139-145.
- Nagarajkumar M., Bhaskaran R., Velazhahan R. (2004). Involvement of secondary metabolites and extracellular lytic enzymes produced by *Pseudomonas fluorescens* in inhibition of *Rhizoctonia solani*, the rice sheath blight pathogen. *Microbiological Research*, 159(1), 73-81.
- Ogbebor N., Adekunle A.T. (2005). Inhibition of conidial germination and mycelial growth of *Corynespora cassiicola* (Berk and Curt) of rubber (*Hevea brasiliensis* muell. Arg.) using extracts of some plants, *African Journal of Biotechnology*, 4, 996-1000.
- Parmeter J.R. (1970). *Rhizoctonia Solani*, Biology and Pathology. University of California Press, California, USA.
- Pierson L.S., Pierson E.A. (2010). Metabolism and function of phenazines in bacteria: impacts on the behaviour of bacteria in the environment and biotechnological processes. *Applied Microbiology and Biotechnology*, 86(6), 1659-1670.
- Singh K.A., Banwasi R., Jangre A. (2010). Effect of rhizobacteria on wilt suppression, growth promotion and yield of coriander and fennel. *Journal of Biological Control*, 24 (3): 276-278.

- Stanojkovic Sebic A., Pavlovic S., Starovic M., Pivic R., Postic D., Lepsanovic Z., Josic D. Indigenous *Pseudomonas chlororaphis* affects growth of *Alternaria* sp., *Phoma* sp. and *Drechslera tetramera* from Anise. Book of Proceedings Fifth International Scientific Agricultural Symposium „Agrosym 2014“. Jahorina, October 23-26, 2014. pp: 582-587.
- Wangensteen H., Samuelsen A.B., Malterud K. E. (2004). Antioxidant activity in extracts from coriander. *Food Chemistry*, 88(2), 293-297.
- Whipps J.M. (2001). Microbial interactions and biocontrol in the rhizosphere. *Journal of Experimental Botany*, 52 (1), 487-511.
- Zdravkovic J., Ugrinovic M., Zdravkovic M., Djordjevic S., Pavlovic S., Josic D. (2015). In vitro and in vivo effects of *Pseudomonas* spp. and *Bacillus* sp. on *Fusarium acuminatum*, *Botrytis cinerea* and *Aspergillus niger* infecting Cucumber. *Pesticidi i fitomedicina*, 30(3), 169-178.

## EFFECT OF CASING AND TOASTING REGIME ON BURLEY TOBACCO TYPE COMPOSITION

Maja MALNAR<sup>1\*</sup>, Vesna RADOJIČIĆ<sup>1</sup>, Nemanja MANDIĆ<sup>1</sup>, Gordana KULIĆ<sup>1</sup>, Marija SRBINOSKA<sup>2</sup>

<sup>1</sup>University of Belgrade, Faculty of Agriculture, Belgrade-Zemun, Serbia

<sup>2</sup>University St. KlimentOhridski – Bitola, Scientific Tobacco Institute – Prilep, TheFormer Yugoslav Republic of Macedonia

\*Corresponding author: mmaja@outlook.com

### Abstract

Tobacco leaf contains more than 3000 compounds that influence the quality of tobacco. The total content of all the constituents of tobacco leaves, and their mutual interactions affects the quality of the cigarettes, as a final product. Addition of sauces made from sugar either fruit components can change the chemical composition of tobacco, with the appropriate temperature regime in order to improve quality. The scope of this study was to examine the effect of casing (sauce application), and toasting regime to the chemical composition of the Burley tobacco, originating from Macedonia. Five groups of samples were made, which were toasted under the different regimes (temperature, time of toasting and thickness of the layer of tobacco). The variations of the chemical composition within the group were followed and compared with a control sample that was not submitted to the process of casing neither toasting. Casing and toasting affected the change of chemical composition of tobacco in terms of increasing the content of moisture, soluble sugars, reducing the content of nicotine and nitrogen compounds as well as decreasing of the total protein levels. Changes in ash content and pH values have no linear character and depend on heating treatment. Changes of any parameter during the toasting process result in changing of the chemical composition of tobacco. They are most pronounced when the toasting of tobacco is carried at lower temperature, but in prolonged time in the toaster, in a thin layer of tobacco.

**Key words:** *Burley tobacco, moisture content, soluble sugars, nicotine, nitrogen compounds*

### Introduction

Tobacco, an herbaceous plant of the *Nicotiana tabacum* family originates from the tropical part of the Americas. Today, the tobacco plant is cultivated worldwide and primarily used because of its stimulant effect. Burley tobacco is a large leaf tobacco. According to technological classification Burley tobacco is in the AC tobacco group (air cured tobacco), which is dried in the air and in the shade. This type of the tobacco has excellent absorption capacity, thus it is used as a sauce bearer, mostly made from sugar or fruit ingredients. Burley tobacco is used for manufacturing American blend type of cigarettes, where it makes up to 30% of the mixture. The chemical composition of tobacco leaves affects its external appearance and physical properties. Also, the chemical composition of tobacco leaves determines the complex effect of the tobacco smoke on human senses and central nervous system of a smoker. Analysis of tobacco leaf chemical composition shows that it contains more than 3000 components, which influence the tobacco quality. However, the quality of tobacco leaves is determined not only by the sum of its ingredients but also with their mutual ratios. Tobacco contains different nitrogen compounds which significantly impact its quality. The high protein content in tobacco gives an unpleasant taste and smell of the smoke, and it is

considered a negative characteristic. Ammonia also adversely affects the quality because it increases the pH value of the smoke. The most important compounds of the tobacco are alkaloids because they determine the tobacco leaves quality, and at the same time alkaloids in the tobacco smoke provide physiological stimulus, which makes smoke pleasant and pleasurable. The main alkaloid is nicotine, but there are normicotine, nicotirine, myosamine, anabasine and anatabine, as well. However, although the nicotine is an essential factor of the tobacco quality, high nicotine content makes smoke unpleasant, with astringent and bitter taste. Carbohydrates are important components of tobacco leaf as they represent almost one-half of the total organic matter in tobacco. Soluble sugars have a positive effect on the tobacco quality since they prevent the transfer of ammonia or other bases to the smoke, and thereby improving the taste and aroma of the tobacco smoke. The sugar esters are commonly used for this purpose since they are important precursors of aroma. Given that the tobacco leaf has a very complex chemical composition, some of its components could make a problem during the processing. In order to improve the quality of tobacco blends a special group of additives is applied at the tobacco leaves through the casing process. The largest part of casing (sauce) comprise sugars (25–65% of the casing weight), above all the invert sugars. Other components of the sauce are various herbal or fruit extracts, organic acids, amino acids, vegetable oils with unsaturated fatty acid glycerin esters. The sauce added to tobacco during toasting process reacts with tobacco components and provides compounds with favorable sensory characteristics. As noted, Burley tobacco is very convenient for casing process because it has a very porous structure, which can absorb up to 25% of the casing weight. The technological process comprises adding the casing and then tobacco is toasted meaning that tobacco mixture is submitted to a heating temperature (100–150<sup>0</sup>C) for a short time. Heating the tobacco improves penetration of the casing elements into the leaf tissue, absorption from the surface of the leaves, and the onset of sugars and amino component interaction. This leads to changes in the chemical composition of tobacco blends improving the sensory properties, especially the distinctive tobacco smoke taste. The aim of this paper was to examine the effect of the casing (sauce application), and toasting regimes (temperature, time of toasting and thickness of the layer of tobacco) to the chemical composition of the Burley tobacco.

### **Material and methods**

The starting material for analyses was Burley tobacco from the Former Yugoslav Republic of Macedonia, which a tobacco factory procures for the routine production. The material corresponds to the first class of tobacco (SRPS E.P1.113, 2004), which means that the leaf tissue is soft, with considerable content, brown without defects or damages.

Five groups of tobacco samples were prepared for the experiments. A sauce was applied to each sample group. The sauce was prepared customarily. The composition of sauce represents a factory secret and it is not publicly available. After the sauce addition, all sample groups were toasted on different regimes, as shown in the scheme of the experiment (Table 1). A control sample was not submitted to the process of casing or toasting.

After toasting experimental samples and control sample were chemically analyzed. The moisture content was calculated at two levels: A (starting humidity) and B (final humidity), using standardized methods (Radojičić, 2011).

Table 1. The diagram of the experiment

Sample group	Sample number		Toasting of tobacco samples (treatments):					
			Temperature in °C - Duration in min - Layer thickness in cm					
			1	2	3	4		
I	1	2			115 - 15 - 3	115 - 20 - 4	-	-
II	1	2	3		120 - 20 - 3	125 - 20 - 3	130 - 20 - 3	-
III	1	2	3	4	135 - 15 - 2	135 - 15 - 4	135 - 20 - 2	135 - 20 - 4
IV	1	2	3	4	115 - 20 - 2	115 - 20 - 4	135 - 20 - 2	135 - 20 - 4
V	1	2	3		120 - 15 - 3	120 - 20 - 3	120 - 30 - 3	

Nicotine level was determined using an UV spectrophotometer (SRPS ISO 2881, 2007). Reducing carbohydrates were determined using the method by Bertrand (SRPS E.P3.115, 1965), and ash content by burning samples on 600°C (SRPS E.P3.117, 1965). The pH value was measured directly with the pH meter (SRPS E.P3.116, 1965). Total nitrogen content was determined by the Kjeldahl method (SRPS E.P3.112, 1965; Radojičić, 2011).

Based on these results, we compared the chemical composition of all experimental groups with the control sample. Afterward, effects of temperature, toasting duration, and tobacco layer thickness were examined in all Burley tobacco samples.

### Results and Discussion

Table 2 shows the results of examination in the samples.

Table 2. Impacts of applied treatments (Table 1) on tobacco properties

Sample group	Tobacco samples (samples A: starting humidity; samples B: final humidity)											
	1	2	3	4	1	2	3	4	1	2	3	4
	Moisture of A samples (%)				Moisture of B samples (%)				Ash (%)			
Control	10.15	-	-	-	-	-	-	-	18.56	-	-	-
I	38.91	31.00	-	-	23.11	24.63	-	-	18.41	18.39	-	-
II	32.98	30.59	37.71	-	19.74	24.43	21.14	-	18.60	18.58	18.66	-
III	39.05	28.12	28.59	35.04	20.00	25.78	17.09	20.16	18.67	18.80	18.91	18.85
IV	38.16	36.78	34.85	29.24	21.43	21.75	17.66	20.60	18.13	17.92	18.11	17.85
V	35.00	30.11	37.31	-	20.75	19.53	22.40	-	17.99	18.63	18.98	-
	pH*				Total nitrogen (%)				Protein nitrogen (%)			
Control	5.37	-	-	-	4.05	-	-	-	2.05	-	-	-
I	5.44	5.42	-	-	4.00	3.87	-	-	1.80	1.92	-	-
II	5.38	5.40	5.42	-	3.84	3.80	3.30	-	2.00	1.90	1.90	-
III	5.40	5.42	5.45	5.42	3.62	3.80	3.40	3.81	2.06	2.00	1.99	1.99
IV	5.30	5.37	5.25	5.24	3.86	3.80	3.76	3.77	2.00	2.00	2.03	2.05
V	5.40	5.42	5.45	-	3.65	3.60	3.00	-	2.04	2.01	1.99	-
	Total protein (%)				Soluble carbohydrates (%)				Nicotine (%)			
Control	13.02	-	-	-	0.01	-	-	-	1.44	-	-	-
I	11.25	11.00	-	-	4.10	4.00	-	-	1.26	1.20	-	-
II	12.50	11.87	11.87	-	3.12	3.10	3.00	-	1.40	1.38	1.34	-
III	12.87	12.50	12.44	12.44	3.80	3.88	4.00	3.88	1.32	1.40	1.20	1.38
IV	12.50	12.50	12.68	12.81	2.87	2.10	2.60	2.00	1.40	1.42	1.37	1.42
V	12.75	12.47	12.43	-	4.10	3.26	2.43	-	1.40	1.38	1.28	-

\* pH in units

The results of control sample were confirms results from the literature (Radojičić, 2011). The results of all experimental sample groups showed that when the sauce was added the moisture content increased by 27%–29% compared with the control sample. The increase of moisture was the most prominent in the first and third sample groups. When we analyzed groups separately, the largest increase in moisture by about 29% was observed for samples 1A from the first group. In the second group, the moisture content was the highest in the sample 3A, and it is about 27% greater than in the control sample. In the third group of samples, the largest moisture increase by 29% was observed in the sample 1A. The sample 1A, within the fourth group of samples, showed the largest increase of the moisture content of 28%. In the fifth sample group, the largest increase in moisture content was observed in the sample 3A, being about 27%. Moisture content in the toaster output ranged from 17%–26%, which is consistent with the literature data (Đulančić, 2014). From the results of the chemical analysis of the raw control material and the chemical analysis of every sample group given in Table 2, we concluded that casing and toasting caused an ample change of the tobacco chemical composition. In comparison to the control sample the direct consequence was the evident change of the sugar content in the selected samples within each group. The sugar content increased by approximately 4% for the first and third group of samples, by 3% for the second group, by 2% in the fourth and by 2.4% to 4% for the fifth group of samples. Compared to the control sample, nicotine content decreased by 0.3% within the first group of samples, by 0.2% within the second group of samples. Nicotine content was slightly decreased in the samples in the third, fourth and fifth group. The total proteins content decreased by about 1.6% in the samples of the first group, approximately 0.7% in the second group, and by 0.3% in the samples of the fourth group. Changes in the protein content in the samples in the third and fifth group were insignificant. Casing and toasting of the tobacco leaves had a negligible influence on the protein nitrogen content, ash, and the pH value of the samples. The refined information about the effect of temperature, the duration of the toasting, and the thickness of the tobacco layers was acquired analyzing the individual experimental sample groups. In the first group, the toasting time and thickness of the tobacco were altered, keeping the constant temperature (115°C). When this group of samples was compared to the control sample the distinguishing feature was a slight reduction of the nicotine, the proteins, all the nitrogen components, the ash, and the pH, as well as an increase in sugar content. For the second group of samples, in which we observed influence of the temperature changes at the constant toasting duration and the thickness of the tobacco layer, it is noted that the increase of temperature reduced content of the sugar, the nicotine, all the nitrogen components, especially proteins, and an increase in the pH. However, increasing the temperature above 125°C did not cause further reduction in protein and nitrogen compounds content. In the samples of the third group of the samples we studied the influence of the changed toasting duration and changed tobacco layer thickness at the two different heat levels. In this case extending the toasting duration combined with a thin tobacco layer lead to a more pronounced reduction in the nicotine content. The protein content decreased with the toasting duration increase, regardless of the thickness of the tobacco layer. A thinner tobacco layer together with a prolonged toasting duration has lead to an increase in sugar content. In the fourth group, we examined the influence of temperature and tobacco layer thickness changes at an unchanged toasting duration. Samples at the higher temperature and in the thinner tobacco layer showed a lower nicotine content. The temperature rise increased the protein-nitrogen and total protein content, regardless of the thickness of the tobacco layer. The reduction of sugar content responded to the increment of the tobacco layer thickness. In the fifth group of samples, the toasting duration was varied, while the temperature and the tobacco layer thickness were constant. Prolonging the toasting duration time caused a pronounced reduction of the nicotine content,

the total protein, and the sugar content, while the ash content and pH value were marginally increased.

### **Conclusion**

Based on the results of this study it can be concluded:

Addition of casing and change in any of the toasting parameters changed the tobacco chemical composition. Changes in the chemical composition of tobacco are most prominent when the toasting of tobacco is carried at a lower temperature, but with prolonged toaster time in a thin tobacco layer. Observing all the parameters of the toasting process, which take into account the energy consumption and time savings due to the thickness of the tobacco layer, according to the quality of the obtained tobacco it can be concluded that sample number 1 from the second group of samples had the best characteristics. The differences of chemical composition between this sample and the control were found as follows (% in dry matter): 1.40 and 1.44 (nicotine), 3.84 and 4.05 (total nitrogen), 2.00 and 2.05 (protein nitrogen), 12.50 and 13.02 (total proteins), 3.12 and 0.01 (soluble carbohydrates), 18.60 and 18.56 (ash), 5.38 and 5.37 (pH), respectively. Reducing the content of nitrogenous substances and increasing the sugar content contributes to better sensory characteristics of tobacco. The nicotine content is slightly reduced which means tobacco will maintain the necessary physiological strength during the smoking process. Contrary to that the soluble carbohydrates content is increased which will improve the taste and smell of tobacco smoke.

### **Acknowledgments**

Authors are grateful to the Ministry of Education, Science and Technology Development of Republic of Serbia, for their support (Project No. 46010).

### **References**

- Dulančić, N. (2014). Processing and manufacturing of tobacco, book. University of Sarajevo, Faculty of Agriculture and Food Sciences, Sarajevo. [in Bosnian]
- SRPS E.P3.112, (1965). Chemical methods for testing quality of tobacco raw materials and products - Determination of nitrogen content in tobacco
- SRPS E.P1.113, (2004). Unfermented tobacco in leaf. Burley type of tobacco, Specification.
- Lin, S., Zhang, X., Song, S., Hayat, K., Eric, K., Majeed, H. (2015). Tobacco alkaloids reduction by casings added/enzymatic hydrolysis treatments assessed through PLSR analysis. *Regulatory Toxicology and Pharmacology*.
- Miao, M.M., Li, L., Shen, Q. P., Liu, C. B., Li, Y. K., Zhang, T., Zhang, F. M., He, P., Wang, K. M., Zhu, R. Z., Chen, Y. K., Yang, G. Y. (2015). Anti-TMV activity flavones from the leaves of Yunnan local air cured tobacco, PR China.
- Nikolić, M. (2004). Technology of tobacco manufacturing, book. University of Belgrade, Faculty of Agriculture. [in Serbian]
- Popović, R. (2000). Production of Virginia tobacco type, TAKT, Belgrade. [in Serbian]
- Radojičić, V. (2011). Quality control of tobacco. Practicum in Tobacco Processing Technology. University of Belgrade, Faculty of Agriculture, Belgrade. [in Serbian]
- Radojičić, V. (2016). Tobacco technology, book. University of Belgrade, Faculty of Agriculture, Belgrade. [in Serbian]
- Rodgman, A., Perfetti, A.T. (2013). The Chemical Components of Tobacco and Tobacco Smoke, CRS Press, Taylor & Francis Group, London.
- SRPS ISO2881, (2007). Tobacco and tobacco products - Determination of alkaloid content - Spectrometric method

- SRPS E.P3.115,(1965).Chemical methods for testing quality of tobacco raw materials and products - Determination of reduced material content in tobacco
- SRPS E.P3.117,(1965).Chemical methods for testing quality of tobacco raw materials and products - Determination of ash content in tobacco
- SRPS E.P3.116,(1965).Chemical methods for testing quality of tobacco raw materials and products - Determination of pH values in tobacco
- SRPS E.P3.113,(1965).Chemical methods for testing quality of tobacco raw materials and products - Determination of protein content in tobacco



## EFFECTS OF SULFONYLUREA HERBICIDES ON INORGANIC PHOSPHORUS IN MAIZE LINES

Milan BRANKOV \*, Vesna DRAGIČEVIĆ, Milena SIMIĆ, Miodrag TOLIMIR, Jelena MESAROVIĆ

Maize Research Institute „Zemun Polje“, Belgrade, Serbia

\*Corresponding author: mbrankov@mrizp.rs

### Abstract

Knowledge about maize inbred lines response to herbicides could give large advantage in weed control and avoid potential problems with low selectivity in field production. In general, herbicides have lower selectivity to maize inbred lines, when compared to hybrids.

Response of seven maize inbred lines to sulfonylurea herbicides was evaluated in two years field experiment. Years differed, accordingly to meteorological parameters. Two sulfonylurea herbicides - nicosulfuron and foramsulfuron were applied in stage 15-16 (BBCH scale). Herbicides were applied in recommended dose for use in hybrid maize and in double dose. Herbicides did not caused significant visual damages to tested lines (2-3 weeks after treatments), only slight symptoms occurred, typical for applied herbicides, with complete plant recovering observed in second visual evaluation (2-3 weeks after the first). Only in several cases, applied herbicides, mainly foramsulfuron influenced grain yield decrease, especially when it was applied in double dose. On the other hand, according to the regression analyses, significant dependence between inorganic phosphorus content (samples 48 h after treatments) and grain yield were observed in four lines, what can be one of detoxification, i.e. tolerance reactions to herbicide application.

**Key words:** *herbicides, maize lines, grain yield, inorganic phosphorus*

### Introduction

Production of maize hybrids is one of the most profitable branches in agriculture. On the other hand, this production can be limited due to various factors. These factors can be abiotic and biotic. In the case of biotic factors, weeds are one of the most important factors, which could be limiting in maize hybrids production. Another disadvantage of this production is based on its own technology (Pavlov et al., 2008). In breeding process maize plants becomes homozygote. This process is associated with inbreeding, which contributes to the expression of many recessive traits. Homozygote plants are smaller than hybrid, they have slower germination and development and in line crop weeds have more free space for their growth and development (Stefanović et al., 2007). Homozygote plants also have higher susceptibility to biotic and abiotic factors, including higher sensitivity towards herbicides, compared to hybrid crop. High grain yields in maize hybrid production are associated with weed control. Herbicide application is the most important measure for weed control. As it is mentioned, line plants are sensitive to herbicides and their application can cause problems in production. There were notices of crop injuries with leaf deformation, smaller plants, and even total plant destruction (Stefanović et al., 2006; Malidža, 2007). These problems can be avoided in case of previous plants testing to herbicides, at least for two years in field conditions, to avoid yield losses.

The aim of this study was to test seven maize inbred lines to two sulfonylurea herbicides in recommended and double doses, to test possible phytotoxic effect and their influence on grain yield, as well as on changes in content of inorganic phosphorus 48 h after herbicide application.

### Material and Methods

Two years field experiment was set up on Maize Research Institute “Zemun Polje” (near Belgrade, Serbia), during 2015 and 2016. In both years, winter wheat was preceding crop. Two sulfonylurea herbicides were applied in recommended and double dose for application in hybrid maize. The experiment was conducted by RBCD design with four replications: main plots encompassed 4 rows of each line, while subplots included two herbicides and control, without herbicide application. The sowing was performed at the end of April in 2015 and at the middle of April in 2016, due to the meteorological conditions, while the herbicides were applied in the 5–6 leaf phase. In period of 2-3 weeks after herbicide application visual plant injuries were determined (scale 1-9), and at the end of vegetation, grain yield was measured and calculated to 14% of moisture. The content of inorganic phosphorus was determined from the plant shoots, 48 h after herbicide application, by method Dragičević et al. (2011). Dependences between grain yield and inorganic phosphorus were obtained by correlation analyses.

**Meteorological conditions.** The experimental years were similar accordingly to the average temperature and precipitation sum (Table 1). The main differences were expressed between first (April-June) and second (July-October) part of vegetative period, when average monthly temperatures were slightly lower in the first part of 2015 and higher during the second part of 2015, when compared to 2016. 2015 was also characterized with the lower precipitation sum during anthesis period (Jun-July) in regard to 2016.

Table 1. Meteorological condition during experiment (April-October) in 2015 and 2016, at Zemun Polje

Month	IV	V	VI	VII	VIII	IX	X	Aver./Sum
Year	Monthly average temperatures							
2015	12.9	19.1	22.1	26.4	25.7	20.2	12.4	19.8
2016	15.3	17.6	23	24.2	22.3	19.4	11.2	19.0
	Precipitation sum							
2015	19.7	97.8	31.1	7.2	56	73.6	65.1	350.5
2016	51.9	47.4	107.4	33.6	43.2	36.6	60.3	380.4

### Results and discussion

Applied herbicides caused significant injuries in three maize lines in 2015. The highest damages were recorded in line L3 with nicosulfuron application. Double dose of nicosulfuron caused moderate damages. Lines L4 and L5 had a slight damages induced by herbicides application, while other lines (L1, L2, L6 and L7) did not react significantly on herbicides. In second year of experiment (2016) applied herbicides caused lesser damages in comparison with previous year. It is important to underline that the highest damages were recorded in line L4, especially in double dose of foramsulfuron (Table 2). Maize response to herbicides depends to some extent on meteorological conditions (Brankov, 2016), also genotype plays important role in tolerance to herbicides. Other researchers indicated that sulfonylurea

herbicides cause the highest problems with phytotoxicity expression in this production area (Stefanovic et al., 2010).

Table 2. Visual plant damages

2015	Herbicides			
Inbred line	Nicosulfuron RD	Nicosulfuron DD	Foramsulfuron RD	Foramsulfuron DD
L1	1	1	1	1
L2	1.5	1.5	1.5	2
L3	3.25	6	4	3
L4	3	3.25	3	3.25
L5	2	2	3	3.5
L6	1	1	1	1
L7	1	1	1	1
2016	Herbicides			
Inbred line	Nicosulfuron RD	Nicosulfuron DD	Foramsulfuron RD	Foramsulfuron DD
L1	1	1	1	2
L2	1	1	1	1
L3	1	1.5	3.5	5
L4	1	1.5	1.25	1.5
L5	1.5	1	1	2.25
L6	1	1	1.25	1
L7	1.5	1.25	1.25	1

Meteorological conditions affect the grain yield, especially in first year when lower yields were recorded. Due to drought, i.e. interaction of small amount of precipitation and high temperatures during anthesis period, the yield of line L6 was failed. Significant yield reduction was recorded in following treatments: L3 – DD of nicosulfuron, L4 - RD nicosulfuron. In other treatments applied herbicides did not significantly influenced observed parameter. In second year, both doses of foramsulfuron decreased grain yield in line L1. Recommended dose of foramsulfuron decreased grain yield in line L5. Double dose of nicosulfuron significantly influenced grain yield in line L7. In other lines and treatments there was no significant influence of applied herbicides on observed parameter (Table 2). Grain yield is one of the most important traits that could be affected by herbicides. In case of short term stress, plants are able to recover themselves and to continue further development. On the other hand, in case of permanent stress plant are under severe influence of herbicides and they cannot recover easily, so one of the results is grain yield loss (de Carvalho, 2007). Brankov et al. (2015) also indicated that sulfonylurea herbicides caused in the most cases decrease of grain yield in maize inbred lines.

The results presented in table 4 indicated significant correlation between grain yield and content of inorganic phosphorus in maize leaves. The highest significant and negative correlation was obtained in lines L2 (-0.93) and L6 (-0.78), as a lines with the lowest grain yield obtained in 2015. On the other hand, significant and positive correlation between observed parameters was recorded only in line L1 (0.58) with also reduced grain yield values, particularly in 2016 and in foramsulfuron treatment. These results could be good indicators of plants reaction to herbicide stress. Brankov et al., (2015) also indicated role of phosphorus (phytic and inorganic) in their study, claiming that this compounds are important factor in maize tolerance to herbicides.

Table 3. Grain yield (t ha<sup>-1</sup>) of maize inbred lines

Herbicide Inbred line	2015				
	Control	Nicosulfuron RD	Nicosulfuron DD	Foramsulfuron RD	Foramsulfuron DD
L1	1.23±0.29	1.78±0.21	1.95±0.24	1.65±0.20	1.62±0.29
L2	1.50±0.36	1.29±0.57	1.59±0.59	1.20±0.52	1.36±0.52
L3	1.63±0.38	1.36±0.27	1.16±0.49	1.79±0.75	1.47±0.67
L4	2.26±0.30	1.62±0.46	2.98±0.89	2.98±0.21	2.75±0.35
L5	2.88±0.47	3.38±0.44	3.48±0.59	3.26±0.57	2.84±1.10
L6	0±0.0	0±0.0	0±0.0	0±0.0	0±0.0
L7	3.97±0.47	4.38±0.58	4.37±0.79	4.15±0.43	3.87±0.75
Average	1.92	1.97	2.21	2.14	1.99
2016					
L1	2.43±0.48	2.75±0.89	2.62±0.65	1.88±0.59	1.95±0.80
L2	3.93±0.66	3.54±0.81	3.58±0.99	4.08±0.38	3.95±0.70
L3	4.00±0.57	4.80±0.54	4.42±0.50	4.23±0.52	4.71±0.68
L4	4.13±0.38	4.48±0.32	4.26±0.61	4.35±0.34	4.71±0.42
L5	5.10±1.13	5.35±0.31	4.49±1.14	4.08±1.01	5.27±1.08
L6	5.85±0.68	6.00±0.30	5.78±0.55	6.00±0.79	5.58±0.84
L7	4.05±1.56	3.82±0.37	3.30±0.61	4.06±0.39	4.38±0.47
Average	4.21	4.39	4.06	4.1	4.36

Table 4. Correlation between grain yield and inorganic phosphorus content in maize shoot

L1	L2	L3	L4	L5	L6	L7
0.58*	-0.93*	-0.49	-0.06	0.004	-0.78*	-0.11

### Conclusions

According to obtained data, application of herbicides from sulfonylurea group can cause some plant injuries on maize inbred lines, so caution is needed to prevent possible yield decrease or loss. Grain yield was reduced in small number or treatments what indicates good maize tolerance to tested herbicides. Analysis of inorganic phosphorus can be a useful tool for better understanding early signs of herbicides in plants leaves.

### Acknowledgements

This study was supported by Ministry of Education, Science and Technological Development, Republic of Serbia through project TR 31068. Special thanks to Agroecology and Cropping Practice Group members for support.

### References

- Brankov M., Simić M., Dragičević V., Vrbničanin S., Spasojević I. (2015). Genotype dependent tolerance to herbicides of maize (*Zea mays*, L) inbred lines. *Genetika*, 47 (1): 97-106.
- Brankov, M. (2016): Effects of herbicides and foliar fertilizers on maize inbred lines. Doctoral dissertation. University of Belgrade, Faculty of Agriculture, 1-121
- de Carvalho, J.P., Nicolai, M., Rodrigues Ferreira, R., de Oliveira Figueira, A.V., Christoffoleti, P.C. (2009): Herbicide selectivity by differential metabolism: Considerations for reducing crop damages. *Science Agriculture*. (Piracicaba, Braz.), 66 (1): 136-142.

- Dragičević, V., Sredojević, S., Perić, V., Nišavić, A., Srebrić, M. (2011): Validation study of a rapid colorimetric method for the determination of phytic acid and inorganic phosphorus from seeds. *Acta Periodica Technologica*, 42: 11-21.
- Malidža, G. (2007): Selectivity of sulfonylurea herbicides towards maize as affected by genotype and soil insecticide. Doctoral dissertation, University of Belgrade, Faculty of Agriculture, 1-82.
- Pavlov, M., Saratlić, G., Videnović, Ž., Stanišić, Z. (2008): A model for successful utilisation of a high genetic potential of maize yield. *Genetika*, 40 (2): 191-203.
- Stefanović, L., Simić, M., Dragičević, V. (2010): Studies on maize inbred lines susceptibility to herbicides. *Genetika*, 42 (1): 155-168.
- Stefanović, L., Simić, M., Milivojević, M., Mišović, M. (2006): The manifestation of symptoms of herbicide (sulfonylurea) phytotoxic effects in their application in seed maize crop. *Acta Herbologica*, 15 (1): 35-46
- Stefanović, L., Simić, M., Rošulj, M., Vidaković, M., Vančetović, J., Milivojević, M., Mišović, M., Selaković, D., Hojka, Z. (2007): Problems in weed control in Serbian maize seed production. *Maydica*, 52: 277-280.

## FIRST REPORT OF THE NATURAL OCCURRENCE OF THE TELEOMORPH OF LEPTOSPHAERIA MACULANS ON OILSEED RAPE IN SERBIA

Petar MITROVIĆ\*, Ana MARJANOVIĆ–JEROMELA

Institute of Field and Vegetable Crops, Novi Sad, Serbia

\*Corresponding author: petar.mitrovic@ifvcns.ns.ac.rs

### Abstract

*Leptosphaeria maculans* (anamorph *Phoma lingam*) causes blackleg disease of oilseed rape. The teleomorph stage of the blackleg pathogen on oilseed rape in Serbia has been reported for the first time. Plant remains of oilseed rape, with clear symptoms of disease were collected in the locality Crvenka brought to the Institute of Field and Vegetable Crops and placed on the soil surface. Immediately, in the vicinity of plant remains, Burkards spore catcher (Burkard Manufacturing Co.Ltd) was placed. Due to the lack of precipitation during October, the stem was sprayed with water (3 to 5 mm/m<sup>2</sup>) every 2 to 3 days. Microscopic examination of tape from Burkards spore catcher was carried out every 7 days. This paper studied the morphological characteristics of pseudothecia, asci and ascospores (size, shape, color and structure). In addition to morphological characteristics, pathogenic properties were investigated by applying a suspension of 10<sup>5</sup> ascospores in the cotyledons. Based on the conducted tests, the presence of a teleomorph stage of fungi *Leptosphaeria maculans* in Serbia was determined.

**Key words:** ascospore, *Leptosphaeria maculans*, pseudothecia, morphological characteristics.

### Introduction

Stem canker or blackleg is economically the most important disease of oilseed rape in Europe, Australia and North America (Fitt et al., 2006). This disease is caused by two types of plant pathogenic fungi belonging to the genus *Leptosphaeria*: *Leptosphaeria maculans* (Desm.) ces. and de Not anamorf *Phoma lingam* (Tode. Fr.) Desmas, which causes severe basal stem canker or the blackleg (Johnson & Lewis, 1994) and *Leptosphaeria biglobosa* Shoemaker and Brun, which is associated with upper stem lesions, usually causing less damage. However, serious damages may cause in countries with high summer temperatures (Huang et al. 2005; Fitt et al., 2006). Both species also occur in Africa, Central and South America and Asia (Anon. 2004 loc cit Fitt et al., 2006). From the epidemiological point of view, stem canker is the most important disease of rapeseed worldwide (Howlett et al., 2001; Gosende et al., 2003). The intensity of the disease depends on climatic factors, agro-technical practice and varietal tolerance (Howlett, 2004; Sosnowski et al., 2004; Aubertot et al., 2006). Tode (1791) cit. loc. Pound, 1947) described blackleg on the dead stem of cabbage and its causal agent was called *Sphaeria lingam*. Given that the fungus was found on a dead stem cabbage, it was considered a saprophytic organism. However, Desmazières (1849 cit. Loc Pound 1947) found the same fungus during the growing season (on living plants), after which it was renamed to the genus *Phoma*. Afterwards, Rostrup (1894 cit. Loc Pound 1947) in Denmark detected the same disease on a white radish and the pathogen was described as *Phoma napobrassicae* Rostrup. However, Henderson (1918 loc cit. Pound in 1947) stated that there is a considerable evidence that *P. napobrassicae* is actually a species of *Phoma lingam*. Smith (1956) found the teleomorph stage of *Leptosphaeria maculans* on the stems of rapeseed in New Zealand. The

fungus is naturally maintained by pycnidia, mycelium and pseudothecia. The pycnidia are usually transmitted on seed while pseudotheciae are present in plant remains. Under favorable conditions of temperature and high relative humidity, pycnidia and pseudothecia release a large amount of pycnospores and ascospores (Williams, 1992). Sowing infected seeds, pycnidia under the influence of soil moisture release conidia, which can infect hypocotyl and cause symptoms in the form of lesions on the cotyledons (Barbetti & Khangura, 2000 cit. Loc. West et al., 2001). Pycnospores role in the epidemiology of the disease is slightly significant/insignificant in Western Europe, but is very important in Western Australia (West et al., 2001). In the UK and other Western European countries, ascospores are the main source of inoculum for the occurrence of stem canker of rapeseed (McGee 1977; Gladders & Musa 1980; Schramm & Hoffmann 1991). After harvest, fungus on infected stems is maintained in the form saprophytic mycelium (Williams, 1992). Shortly after the harvest, pseudothecia may be visible on the lower parts of the stem (area of disease symptoms), while on the upper part of the stem, they are formed a few weeks later (Hammond 1985 cit. Loc. West et al., 1999). The fungus can survive several years in plant residues (Petrie, 1986). However, the greatest release of the ascospores is in the first year after the harvest (McGee, 1977; Sosnowski et al., 2006; Naser et al., 2008). Temperature and humidity are the main factors which influence the maturation of pseudothecia and the release of ascospores (Peres & Poisson, 1997). Pseudothecias are formed at temperatures from 15<sup>0</sup>C to 20<sup>0</sup>C, and the conditions are quite similar for both species (*L. maculans*, *L. biglobosa*), while *L. biglobosa* forms a very slowly pseudothecia at a temperature below 10<sup>0</sup>C (Toscano-Underwood et al., 2003). In conditions of Central and Western Europe the release of ascospores is starting in September or October, and the latest 1 to 2 months later (Thürwächter et al., 1999), while in the arid regions of Western Australia, pseudothecia formation and the release of ascospores begins 18 months after the harvest (Gladders et al., 2006). In Eastern Europe the release of ascospores is recorded even in April the following year (Fitt et al., 2006). Airborne ascospores fall to leaf surface and in favorable conditions, they infect leaves via stomata or injuries, causing the first visible symptoms (Hammond & Lewis, 1987).

### Material and Methods

The presence of teleomorph stage (*L. maculans*) was investigated in the following way:

1. Plant remains with a clear symptoms of the disease were collected at locality Crvenka (Vojvodina province, Serbia), in plastic bags (Magyar et al., 2006). The material was brought to the Institute of Field and Vegetable Crops and placed on the soil surface. In the vicinity of the plant residues, a Burkard spore catcher (Burkard Manufacturing Co.Ltd) was placed (McGee 1977; Thürwächter et al., 1999) (fig 1).



Fig.1. Burkard spores catcher

The experiment was set on 10<sup>th</sup> October in 2009. Due to the lack of precipitation during October, the stems were sprayed with water (3 to 5 mm/m<sup>2</sup>) every 2 to 3 days (Peres et al., 1999). Binocular view of the tape was carried out every 7 days. Based on the binocular observations (fig.1) 5 stems of rapeseed were placed in plastic bags (a total of 5 bags) at an oblique angle, and 25 to 30 ml of distilled water was added. The bags are partially closed and in the upright position placed in a controlled environment with a 12 h photoperiod. Night temperature was adjusted from 8 to 10<sup>o</sup>C and daily from 13 to 15<sup>o</sup>C. Distilled water is added to provide the necessary moisture for the formed pseudothecia, asci and ascospores and for collection of ascospores during their release, which were later used to verify the pathogenicity. The first observation was done after 5 days and subsequent observations were carried out every 2 days. After the appearance of ascospores, pseudothecia, asci and ascospores were measured and structure and forms ascospores were studied. In addition to morphological characteristics, pathogenic properties of ascospores were investigated as follows: in the pots, which were pre-filled with sterile compost, 5 seedlings of rapeseed variety Banačanka were planted in one pot. One repetition consisted of three pots. Cotyledons from 3 pots were injured with a sterile needle. At the injured area, 5 ml of a suspension of ascospores 10<sup>5</sup> was applied with a micropipette (Koch et al., 1989). In the following treatment, cotyledons from 3 other pots were also injured, but inoculation is done by spraying the cotyledons hand sprayer. In the third group of plants inoculation is done by spraying without harming the cotyledons. The inoculated plants, together with the control treatment, were placed in the controlled environment at 15<sup>o</sup>C and 95% RH for 24 hours and then were transferred to the greenhouse. The first review of the plant was carried out after 5 days and the occurrence of symptoms and changes in plants were observed in the next 20 days. Re-isolation of the pathogen from the diseased part is performed after the appearance of symptoms. Ascospores suspension was prepared as follows: under binocularas, pseudotecie were separated together with parts of the plant tissue, from the rest of the stems, using a lance with a needle and placed in distilled water (Mengistu et al., 1993). This mixture was transferred into a test tube and hand-shaken. Then, the contents of the tube together with a spore suspension were filtered through a sieve (140 MESH) in order to separate pseudothecia and asci from the ascospores. With a hemocytometer ascospores concentration was adjusted to approximately 10<sup>5</sup> per ml. Ascospores suspension was transferred in controlled conditions at temperature of 15<sup>o</sup>C for 48 h. After germination of ascospores, the pathogenicity tests was performed.



## Results and Discussion

The presence of ascospores of pathogenic fungi *L. maculans* in Serbia was detected in two ways, as described in materials and methods. The first occurrence of ascospores, based on microscopic examination tape (Burkard catcher spores), was recorded on 13<sup>th</sup> November in 2009. After the first appearance of ascospores (13<sup>th</sup> November), the observations were carried out every 7 days until 20<sup>th</sup> December 2009. In this period, the strongest release of ascospores was registered in late November and early in December. Due to the low temperature and later snowfalls the monitoring of the release of ascospores was interrupted, and continued in the spring of next year (from 20<sup>th</sup> May). For the same plot remains during the spring of 2010 the first release was observed at the end of March and early April. During the autumn and the spring, microscopic examinations revealed that the majority of ascospores is released in the second part of the day.

The first binocular examination of the infected stems of rapeseed from plastic bags, for the presence of pseudothecia, in laboratory conditions was carried out after 5 days, during 2009. Subsequent observations were carried out every 48h, and the first occurrence of ascospores was registered after 11 days. Pseudothecia on stem immersed, later becoming erumpent, globose shape, black color with protruding ostioles, with diameter 313 to 532  $\mu\text{m}$  (fig. 2). Ostioles occurred at the moment of release of ascospores (fig. 3).

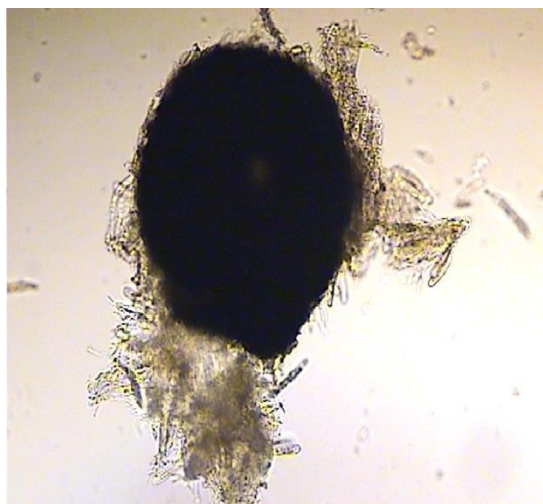


Fig. 2. *L. maculans*  
Pseudothecia fungus

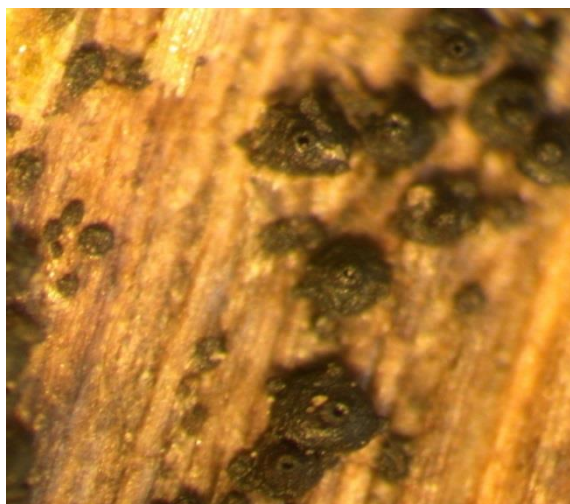


Fig. 3. *L. maculans*  
Pseudothecias with form ostioles

Asci cylindrical to clavate, sessile or short stipitate, 8 ascospores, diameter 16,72–21,39  $\mu\text{m}$  x 90,00–130,00  $\mu\text{m}$  (Fig. 4). Ascospores in asci are arranged in two rows. Ascospores biserial, cylindrical to ellipsoidal, ends mostly rounded yellow brown slightly or not constricted at the central septum, guttulate 6–10,5  $\mu\text{m}$  x 42–74  $\mu\text{m}$  (Fig. 5). With aging septa and oil drops are difficult to spot.



Fig. 4. *L. maculans*  
Ascus fungi



Fig. 5. *L. maculans*  
Ascosporesfungi

#### ***Test of pathogenicity***

Pathogenicity of ascospores was tested on cotyledons of oilseed rape, variety Banaćanka. The first occurrence of symptoms could be observed already after 5 days in the form of chlorosis around the injured part. At plants where the conidia suspension was sprayed, spots on cotyledons occurred later. Later, after all three methods of inoculation of the cotyledons were performed, the center spot is assumed grayish color with necrotic edge (Fig.6). The appearance of pycnidia was observed 15 days after the inoculation. Re-isolation on PDA was obtained conidial stage of the fungus which has been described under the name of *Phoma lingam* (Todd Fr.) Desmaz.



Fig. 5. *L. maculans*

Symptoms on cotyledons of oilseed rape (right) – uninoculated control plants (left)

In Serbia (Vojvodina preovine) ascospores of *L. maculans* are released except in the autumn and during spring, usually in April and May, which is in agreement with the results of (Gladolers & Musa 1980; Fitt et al, 2006). Ascospores infected leaves via stomata, or injuries

(Hammond et al., 1985) but in the spring, except leaves, infects stems, branches, flowers and pods, causing characteristic symptoms of the disease. After the harvest, on the diseased part of the oilseed rape stems, during the autumn or the following spring, fungi exists in the form of saprophytic mycelia and in the plant tissue, the pseudothecia is formed. Pseudothecia are roundish in shape, black color with protruding ostioles, diameter 313 to 532  $\mu\text{m}$ , which is in accordance with (Holliday & Punithalingam 1972; Williams, 1992). Asci are cylindrical to clavate, sessile or short stipitate, diameter 16,72–21,39 x 90–160  $\mu\text{m}$ . In ascus, 8 ascospores are found. Ascospores are biseriata, cylindrical to ellipsoidal, and mostly are rounded yellow brown color with 5 septa, diameter 6–10,5 x 42–74  $\mu\text{m}$ . Similar data were recorded by Punithalingam and Holliday (1972); Williams (1992) and Magyar et al. (2006). The initial symptoms of the cotyledons (infected ascospore) occur in the form of a pale greenish spot (West et al., 1999, 2001). At a later stage, the infected tissue necrosis in the central part of the spot is formed as well as pycnidia. After the occurrence of pycnidia, isolation was carried out on PDA medium and the obtained conidial stage of the fungus is described under the name *Phoma lingam* (Todd Fr.) Desmaz.

### Conclusion

Based on this research, pathogenic fungus *Leptosphaeria maculans*, except conidial stage, forms teleomorph stage (pseudothecia with asci and ascospore) in Serbia.

### Acknowledgements

This study is part of the TR31025 project supported by the Ministry Education, Science and Technological Development of the Republic of Serbia.

### References

- Aubertot, J.N., West, J.S., Bousset-Vaslin L., Salam, M.U., Barbetti, M.J., Diggle, A.J (2006): Improved resistance management for durable disease control: a case study of *Phoma* stem canker of oilseed rape (*Brassica napus*). *Eur. J. Plant Pathol.* 114: 91–106.
- Fitt B D L, Brun H, Barbetti J M, Rimmer R S (2006): World-wide importance of *phoma* stem canker (*Leptosphaeria maculans* and *L. biglobosa*) on oilseed rape (*Brassica napus*). *European Journal of Plant Pathology* 114: 3-15.
- Gladders P, Musa T M (1980): Observations on the epidemiology of *L. maculans* stem canker in winter oilseed rape. *Plant Pathology* 29: 28-37.
- Gladders P, Evans N, Marcroft S, Pinochet X (2006): Dissemination of information about management strategies and changes in farming practices for the exploitation of resistance to *Leptosphaeria maculans* (*phoma* stem canker) in oilseed rape cultivars. *European Journal of Plant Pathology* 114: 117-126.
- Gosende S, Penaud A, Aubertat J N, Schnieder O, Pinochet X (2003): Evolution of soil surface oilseed rape stubbles and their ability to produce spores of *Leptosphaeria maculans*: preliminary results. 11th International Rapeseed Congress Proceeding 41166-1168, Denmark.
- Hammond K E, Lewis B G (1987a): The establishment of systemic infection in leaves of oilseed rape by *Leptosphaeria maculans*. *Plant Pathology* 36: 135-147.
- Hammond K E, Lewis B G (1987b): Variation in stem infections caused by aggressive and non-aggressive isolates of *Leptosphaeria maculans* on *Brassica napus* var. *oleifera*. *Plant Pathology* 36: 3653-3665.

- Howlett B J, Idnurm A, Pedras M S C (2001): *Leptosphaeria maculans* the causal agent of blackleg disease of Brassicas. *Fungal Genet. Biol.* 33: 1-14.
- Howlett B J(2004): Current knowledge of the interaction between *Brassica napus* and *Leptosphaeria maculans*. *Can. J. Plant Pathol.* 26: 245–252.
- Huang Y J, Fitt B D L, Jedruczka M, Dakowska S, West J S, Gladders P, Steed J M, Li Z Q (2005): Patterns of ascospore release in relation to phoma stem canker epidemiology in England(*Leptosphaeria maculans*) and Poland (*L. biglobosa*). *European Journal of Plant Pathology* 111: 263-277.
- Johnson R D, Lewis B G (1994):Variation in host range, systemic infection and epidemiology of *Leptosphaeria maculans*.*Plant Pathology* 43:269-277.
- Koch E, Badaway A M H, Hope H H (1989): Differences between aggressive and non aggressive single spore lines of *Leptosphaeria maculans* in cultural characteristics and phytotoxin production. *J. Phytopathol.* 124: 52-62.
- Magyar D, Barasits T, Fischl G, Fernando W G D (2006): First report of the natural occurrence of the teleomorph of *Leptosphaeria maculans* on oilseed rape and airborne dispersal of ascospores in Hungary. *J. Phytopathology* 154: 428-431.
- Mengistu A, Rimmer S R, Williams P H (1993): Protocols for in vitro sporulation Ascospore release sexual mating and fertility in crosses of *Leptosphaeria maculans*. *Plant Disease* 77: 538-540.
- McGee D C (1977):Blackleg (*Leptosphaeria maculans* (Desm.) Ces. et de Not.) of rapeseed in Victoria: sources of infection and relationships between inoculum environmental factors and disease severity. *Australian Journal of Agriculture Research*28:53-62.
- Naseri B, Davidson J A, Scott E S (2008): Survival of *Leptosphaeria maculans* and associated mycobiota on oilseed rape stubble buried in soil. *Plant Pathology* 57: 280-289.
- Naseri B, Davidson J A, Scott E S (2009): Maturation of pseudothecia and discharge of ascospores of *Leptosphaeria maculans* on oilseed rape stubble. *Eur. J. Plant Pathol.* 125: 525-531.
- Pérés A, Poisson B (1997):Phoma du colza: avancees en epidemiologie. *CETIOM –Olkoscope*40: 37-40.
- Pérés A, Poisson B, Le Sourn, Maisonnewe C(1999):*Leptosphaeria maculans*: effect of temperature rainfall and humidity on the formation of pseudothecia. *Proceedings of the 10th International Rapeseed Congress Canberra Australia*
- Petrie G A (1986):Consequences of survival of *Leptosphaeria maculans* (blackleg) in canola stubble residue through an entire crop rotation sequence. *Canadian Journal of Plant Pathology*8:353 (Abstract).
- Pound S G (1947): Variability in *Phoma lingam*. *Journal of Agricultural Research* 75(4): 113-133.
- Punithalingam E, Holliday E (1972):*Leptosphaeria maculans* CMI Descriptions of pathogenic fungi and Bacteria. No. 331.
- Schramm H, Hoffmann G H (1991):Biologische Grundlagen zur integrierten Bekämpfung von *Phoma lingam* (teleomorph *Leptosphaeria maculans* (Desm.) Ces & deNot.) dem Erreger der Wurzelhals- und Stengelhals an Winterraps. *Zeitschrift für Pflanzenkrankheiten und Pflanzenschutz*98: 581-596.
- Smith H C (1956):*Leptosphaeria nepi* the pericetial form of *Phoma lingam* causing dry-rot disease of Brassicas. *New Zealand Science Review* 14: 116-117.
- Sosnowski M R, Scott E S, Ramsey M D (2004): Infection of Australian canola cultivars (*Brassica napus*) by *Leptosphaeria maculans* is influenced by cultivar and environmental conditions. *Austral. Plant Pathol.* 33: 401-411.

- Sosnowski M R, Scott E S, Ramsey M D (2006): Survival of *Leptosphaeria maculans* and soil on residues of *Brassica napus* in South Australia. *Plant Pathology* 55: 200-206.
- Thürwächter F, Garbe V, Hoppe H H (1999): Ascospore discharge leaf infestation and variations in pathogenicity as criteria to predict impact of *Leptosphaeria maculans* on oilseed rape. *Journal of Phytopathology* 147: 215-222.
- Toscano-Underwood C, Huang Z J, Fitt B D L, Hall M A (2003): Effects of temperature on maturation of pseudothecia of *Leptosphaeria maculans* and *L. biglobosa* on oilseed rape stem debris. *Plant Pathology* 52: 726-736.
- West S J, Biddulph J E, Fitt B D L, Gladders P (1999): Epidemiology of *Leptosphaeria maculans* in relation to forecasting stem canker severity on winter oilseed rape in the UK. *Ann. Appl. Biol.* 135: 535-546.
- West S J, Kharbanda D P, Barbeti J M, Fitt B D L (2001): Epidemiology and management of *Leptosphaeria maculans* (phoma stem canker) on oilseed rape in Australia Canada and Europe. *Plant Pathology* 50: 10-27.
- Williams P H (1992): Biology of *Leptosphaeria maculans*. *Canadian Journal of Plant Pathology* 14: 30-35.

## **THE EFFECTS OF IRRIGATION ON THE STRUCTURAL STABILITY OF MICROAGGREGATES AND THE RISK OF SOIL CRUSTING IN THE MORAVICA ADMINISTRATIVE DISTRICT IN THE REPUBLIC OF SERBIA**

Radmila PIVIĆ\*, Zoran DINIĆ, Jelena MAKSIMOVIĆ, Dragana JOŠIĆ, Aleksandra STANOJKOVIĆ-SEBIĆ

Institute of soil science, Teodora Drajzera 7, Belgrade, Serbia

\*Corresponding author: drradmila@pivic.com

### **Abstract**

During 2016, on agricultural soils of Moravica Administrative District, under irrigation systems were carried out research of the effects to the structural stability of micro aggregates and the risk of crust formation of the irrigation measures applied. Soil samples were sampled in a disturbed condition from the surface horizon at a depth of 0-30 cm from twenty locations. Level of stability of micro aggregates, expressed by Vageler's scale, is determined based on the ratio of total content of the particles of clay in the soil sample prepared with pyrophosphate, and the content of clay particles in a suspension of soil prepared with the water. The risk of the soil crusting was determined according to a Van der Watt & Claassen pattern based on the ratio between the content of organic matter, and total content of the clay and dust particles in soil samples. Based on processed result, it was prepared an assessment of whether and how irrigation affects the structure of soils type fluvisol, vertisol, humogley, cambisol and stagnosol, on which the research were conducted. The obtained results, shows that the tested soil samples, according to the classification by level of stability of micro aggregates by Vagler-in, are belonging to the level of very stable aggregates. In relation to the risk of crust, 50.00% of the samples had a high risk area, 37.50% borderline risk, and at the 12.50% of the samples, a risk of crust was at a low level.

**Key words:** *irrigation, structural aggregates stability, soil crusting*

### **Introduction**

Each type of soil is characterized by a particular structure and it represents an important morphological and genetic mark of the soil. It is an important factor of fertility of agricultural soil and is gradually created by the complex of physical and chemical processes. The stability of structural aggregates, according to Vučić (1992), is considered to be the key of the fertility of the soil. It is a dynamic determinant especially in the surface horizon, which depends on the characteristics of the soil, climate and processing conditions. As a result of soil processing, stability of aggregates rapidly decreases, while the size of dry aggregates increases. Determination of the stability of the structural aggregates of the soil is important for finding the best solution for maintaining the soil in the most favorable condition for its processing and plant production in general. Creating a structure is a very complex process that depends on the interaction of the type of soil, cement agents, soil management and ecological conditions. A favorable soil structure should be maintained and adversely repaired (Belić et al., 2004).

The factors of stability of the structure of the space are: cohesion, humus content in humus materials, calcium, iron, soil fauna, clay and others, while factors of instability of the structure can be caused by: rain and hail, saturated soil, sodium, acid humus (Pavićević, 1972).

Irrigation, in general, are defecting the structure and this phenomenon is observed in almost all types of soil. Sprinklings are disrupting structures less, while and the most disruptions are by irrigation which considers flooding and overflowing. Structural aggregates are saturated with water and this makes soil particles separated from one another in the swelling process. In a humid state, such soils are glued and in the dry state are prone to grudging.

Soil structure is an important factor of fertility of agricultural soil which is gradually formed by the complex physical and chemical processes. The influence of different cropping systems leads to changes in soil structure (Ćirić et al., 2013).

Soil structure is a key determinant of soil fertility and agricultural productivity, and is thus of great ecological significance. Structural status (shape, size) and stability of structural aggregates are key factors of soil fertility, which significantly affect the sustainability of crop production (Amezketta, 1999; Bronicki and Lal, 2005; Nešić et al., 2014). Creating structures (Tisdall and Oades, 1982; Oades and Waters, 1991) is a very complex process which depends on the interaction between soil types, cement agents, soil management and environmental conditions. Soil structure is very dynamic dimension, especially in the humus horizon which changes under the influence of climatic factors, crops and processing (Vučić, 1964). Favorable soil structure is necessary to preserve and unfavorable to improve (Belić et al., 2004). The most significant properties for the evaluation of soil structure are the content of macro-aggregates, their mechanical strength and water stability, as well as porosity (Sorochkin, 1991). The factors affecting soil structure and aggregate composition are tillage, irrigation and climate (Gérif et al., 2001, Gajić et al., 2006). Soil aggregate stability declines rapidly as the consequence of cropping, and the diameter of dry aggregates increases (Kandelero and Murer, 1993; Shepherd et al., 2001). Soil organic matter (SOM) is an essential, but transient component of the soil that controls many physical, chemical and biological properties in the soil (Carter, 1996). Soil structure and SOM content are considered important indicator of soil in agricultural soil (Lal and Kimble, 1997, Gajić et al., 2006). The lower stability is usually associated with a decrease in SOM content and significantly affects plant development.

The data obtained by determining the stability of micro aggregates contribute in defining clearer and more complete overview of the soil structure. In soils with less stable micro aggregates it is reduced the share of stable macro aggregates (Belić et al., 2004). Based on the stability of the micro aggregates it can be predicted the risk of erosion (Igwe and Obalum, 2013). Micro aggregates are mainly formed by coagulation of colloids or colloids and opposite-charged ions, and also can be formed by fragmentation of macro aggregates.

### **Material and Methods**

The Moravica Administrative District is located in the central part of the Republic of Serbia and includes the following municipalities: Gornji Milanovac, Čačak, Lučani and Ivanjica. It extends from 43°52' to 44°16' north latitude and from 19° 55' to 20°38' east longitude, covers about 3.016 km<sup>2</sup>, and the arable agricultural soil covers about 104.032 ha.

Most of the area are meadows and pastures, then plowed and gardens, and then orchards and vineyards. The total number of locations where observations were performed during July 2016, was twenty. Part of it was under irrigation systems (drop by drop and sprinkling) and part of it was provided for the application of irrigation systems. Soil samples in the disturbed state were analyzed from a depth of 0-30 cm.

Climatic data were processed on the basis of data taken from the yearbooks of Hydro meteorological Institute (RHMZ [www.hidmet.gov.rs](http://www.hidmet.gov.rs), accessed May 2017). The data from weather stations Kragujevac and Požega (MS Kragujevac location: 44° 02' latitude and 20°

56' latitude, 185 m above sea level, MS Požega location: 43° 51' latitude and 20° 02' latitude, 310 m above sea level), for a series of 21 years of observation.

The characteristics of the climate of the study area are presented by processing the following indicators (Belanović, 2012):

- Lange's (Kf) rainfall factor, representing the relationship between annual rainfall and mean annual air temperature.

- De Marton's drought index, derives from equation:

$$I_m = \frac{12 \cdot P_m}{10 + T_m}$$

Where:  $I_m$  – monthly drought index by De Marton,

$P_m$  – average monthly precipitations,

$T_m$  – average monthly air temperature.

-Climate diagram by Walter, obtained on the basis of average mean monthly air temperature values and average mean monthly precipitation values in relation 3:1.

Preparation of collected soil samples implied processes of drying, grinding and screening following the laboratory analysis. The samples were air-dried at room temperature. A portion of the sample was sieved through 0.25 mm sieve. The content of organic matter (SOM) was determined by Kotzman, JDPZ (1966).

Determination of physical characteristics of the soil included analysis of the stability of structural aggregates in 20 samples of soil material. The principle of determination was based on an analysis of the relationship between the total content of particles smaller than 0.002 mm (clay) in the soil sample prepared with sodium pyrophosphate ( $\text{Na}_4\text{P}_2\text{O}_7 \times 10 \text{H}_2\text{O}$ ) and the content of these particles in the suspension of soil prepared with water ( $\text{H}_2\text{O}$ ).

The stability of the micro aggregate is calculated according to the Vageler's index of their stability ( $S_s$ ) according to the formula:

$$S_s = (\text{FP} - \text{FNP}) / \text{FP} \times 100,$$

Where: FP (%) - particles smaller than 0.002 mm in the soil material prepared with ( $\text{Na}_4\text{P}_2\text{O}_7 \times 10 \text{H}_2\text{O}$ );

FNP (%) - particles smaller than 0.002 mm in the soil material prepared with  $\text{H}_2\text{O}$ . Risk of the soil crusting R(%) is determined according to formula Van der Watt & Claassen (1990):

$$R = \text{SOM} \times 100 / (\text{clay} + \text{silt}),$$

Where:

SOM content of organic matter in the soil (%);

Clay + Silt - content of certain mechanical fraction (%).

## Results and discussion

Air temperature and amount of precipitation are climatic elements of areas that have a dominant influence on the intensity and ability to perform intensive agricultural production, and are conditioned by geographical position, geographical latitude, altitude, relief formations, and distance from water resources as well as wind influences.

Based on the above criteria, each area has its specificities and diverse climatic characteristics. None of the above-mentioned climate indicators is sufficient to independently characterize the climate of an area, for better understanding of climate characteristics, it is more convenient to use them together.

The climate of the Moravica region is moderately continental. The collected climatic parameters for the period of observation 1994-2015, due to differences in the configuration of the terrain, were processed for two parts: for the flatland data collected from the meteorological station Kragujevac and for the hilly-mountain part, the data from the metrology station Požega.



The average annual amount of precipitation registered at MS Kragujevac was 627.5 mm, while on MS Požega the value of this parameter was 709.2 mm. Average precipitation during the vegetation period (April-September) at the MS Kragujevac is 366.1 mm and 261.4 mm in the off-season (October-March), and on MS Požega during the vegetation period (April-September) 416.9 mm and 292.3 mm in the extra vegetation period. Within MS Kragujevac, the most probable is the month of June, with an average precipitation of 66.6 mm (MS Požega 80.1 mm). The average annual duration of sunshine during the day at MS Kragujevac is 5.5 hours (MS Požega 4.16 hours), with the highest hours of sunshine in July, 9.49 h (MS Požega 7.73 h), and at least during December 2.0 h (MS Požega 1.04 h). The average annual air temperature at the MS Kragujevac is 11.48 °C (MS Požega 9.59 °C), with the coldest January (1.41 °C), (MS Požega -0.95 °C) and the warmest July with registered 21.62 °C, (MS Požega 19.54 °C). The average annual wind speed registered within the MS Kragujevac is 1.2 ms<sup>-1</sup>, with the brightest March (1.7 ms<sup>-1</sup>) and the smallest August (0.8 ms<sup>-1</sup>), while in the MS Požega the average annual wind speed 0.6 ms<sup>-1</sup>, with the brightest March and April (0.9 ms<sup>-1</sup>) and the smallest December, January and October (0.4 ms<sup>-1</sup>).

The rainfall factor in Lange, obtained by processing the data from MS Kragujevac is  $K_f = 54.7$ , and for MS Požega,  $K_f = 73.9$ , which indicates that the investigated area at lower altitudes belongs to the climatic field of the semiarid climate, while in the higher regions predominate conditions of semihumidic climate.

De Marton's index from the processed data from MS Kragujevac, points to the conclusion that irrigation in addition to precipitation needs to be included from May to October. Based on the parameters processed, it can be concluded that water is lacking both in winter and summer, almost the whole vegetation period. In higher areas, irrigation in addition to precipitation should be included during August.

The Walter diagram points that drought occur in the lower parts of the investigated area in the middle of August. In hilly-mountain areas, data from MS Požega, are determining that the water deficit occurs in mid-July and lasts until the first week of September. Such conditions are unsuitable for fruit and vegetable production, so in the period of deficiency it is necessary to provide some type of irrigation as a complement to precipitation.

In the soil samples it was determined the stability of structural aggregates. The principle of determination was based on an analysis of the relationship between the total content of particles smaller than 0.002 mm (clay) in the soil sample prepared with sodium pyrophosphate ( $\text{Na}_4\text{P}_2\text{O}_7 \times 10 \text{H}_2\text{O}$ ) and the content of these particles in the suspension of soil prepared with water ( $\text{H}_2\text{O}$ ).

The stability level of the micro aggregate is estimated by using the classification by Vageler (JDPZ, 1997), shown on Table 1.

Table 1. Classification of stability level of the structure micro aggregate in soil

Index of stability of micro aggregates (Ss)	Level of stability by Vagler
<10	totally unstable
10-20	unstable
20-30	low stable
30-50	slightly stable
50-70	rather stable
70-90	stable
>90	very stable

The risk of soil crust formation is high if the value of R is less than 5%, on the borderline if R is 7% and low if R is greater than 9% (quote Ćirić et al., 2012).

The examined parameter is important, since, for example, by treating soil in a dry condition, structural aggregates are dispersed, and rain or irrigation on the surface of the soil, are formatting of a thick and hard suborach that can affect the uneven growth of cultivated plants, or the absence of plant development. The table 2. shows, locations of the samples, type of soil and existence of irrigation systems.

Table 2. List of locations of samples, type of soil and existence of irrigation systems.

No.	Location	Coordinates		Soil types	Existence of irrigation systems
		X	Y		
1	G.Milanovac	455866	4871915	Fluvisol	n/a
2	G.Milanovac	456320	4872628	Vertisol	n/a
3	G.Milanovac	456735	4875391	Stagnosol	n/a
4	Grabovica	458624	4873964	Vertisol	n/a
5	Sinoševići	451896	4878789	Stagnosol	n/a
6	Katićevo	453489	4878938	Stagnosol	yes
7	Baluga Lj.	453749	4859484	Humogley	n/a
8	Baluga	453879	4858635	Fluvisol	yes
9	Mrčajevci	461084	4854817	Humogley	yes
10	Mrčajevci	462421	4856394	Vertisol	yes
11	Mojsinje	456961	4859734	Humogley	yes
12	Prijevor	444198	4861628	Stagnosol	yes
13	Jezdina	444598	4856397	Vertisol	yes
14	Lučani selo	432845	4855741	Cambisol	n/a
15	Tijanje	438473	4852561	Stagnosol	yes
16	Puhovo	433799	4852271	Stagnosol	n/a
17	Markovica	437864	4855970	Stagnosol	n/a
18	Kotrža	439198	4839179	Fluvisol	yes
19	Ivanjica	435532	4828005	Fluvisol	yes
20	Baluga	454089	4857910	Fluvisol	n/a

Results of performed analysis of 20 soil samples in disturbed condition are shown in Table 3.

The results of the analysis showed that the soil samples have stable to very stable level of stability micro aggregates, except of the sample No.16 which has very stabile value of this parameter (Ss=60.20).

Soil organic matter is a key attribute of soil quality that affects the aggregation and aggregate stability (Franzluebbbers, 2002). In the analyzed samples organic matter content is in the range from low to high content, which is correlation with a certain value of the risk of crust formation. In the analyzed samples the risk of the soil crusting was in limit values 50.00% of the samples had a high risk area, 37.50% borderline risk, and at the 12.50% of the samples, a risk of crust was at a low level.

Table 3. Locations of sampling and examined parameters

No.	Clay (%) <sup>*</sup>	Clay (%) <sup>#</sup>	Ss	Index of stability of micro aggregates	Silt (%)	C (%)	SOM (%)	R (%)	Risk of the soil crusting
1	5.9	29.3	79.86	stable	29.2	1.47	2.49	4.26	High risk
2	8.3	41.1	79.81	stable	29.7	2.69	4.23	5.97	Borderline risk
3	7.3	39.0	81.28	stable	37.1	1.83	3.15	4.14	High risk
4	9.2	38.2	75.92	stable	36.0	2.08	3.59	4.83	High risk
5	0.8	28.5	97.19	very stable	26.4	2.72	4.69	8.54	Borderline risk
6	4.5	31.1	85.53	stable	44.5	2.05	3.53	4.67	High risk
7	4.8	35.5	86.48	stable	26.9	1.83	2.75	4.41	High risk
8	2.4	28.5	91.58	very stable	30.2	1.20	1.89	3.22	High risk
9	1.8	18.9	90.48	very stable	30.2	1.71	2.73	5.56	Borderline risk
10	8.1	42.6	80.99	stable	27.8	3.54	5.22	7.41	Borderline risk
11	9.6	43.2	77.78	stable	31.4	1.62	2.79	3.74	High risk
12	5.4	35.8	84.92	stable	30.5	2.43	4.19	6.32	Borderline risk
13	8.1	36.4	77.75	stable	27.1	1.75	2.79	4.39	High risk
14	4.5	26.4	82.95	stable	37.5	1.09	1.88	2.94	High risk
15	3.5	24.3	85.60	stable	26.9	2.12	3.65	7.14	Borderline risk
16	3.9	9.8	60.20	stable-very	53.6	1.58	2.72	4.30	High risk
17	3.5	27.3	87.18	stable	34.8	2.32	4.00	6.44	Borderline risk
18	0.3	11.5	97.39	very stable	26.5	1.19	1.49	3.92	High risk
19	0.3	12.9	97.67	very stable	29.9	2.98	5.14	12.00	Borderline risk
20	1.6	24.8	93.55	very stable	26.1	1.34	2.10	4.13	High risk

**Ss** - Index of stability of micro aggregates;

**\*** - Content of clay (%) determined by preparation with water;

**#** - Content of clay (%) determined by preparation with  $\text{Na}_4\text{P}_2\text{O}_7 \times 10 \text{H}_2\text{O}$ ;

**R** (%) - Risk of the soil crusting;

**SOM** - Content of organic matter in the soil (%).

### Conclusion

Based on the results of observations carried out on the soil type fluvisol, vertisol, humogley, cambisol and stagnosol (WRB, 2014), where drip irrigation method is implemented or planned for implementation, in the area of Moravica Administrative District, it is evident that some locations requires the application of complex measures of soil reclamation in order to repair the adverse water- physical Properties (heavy soils such as stagnosol, vertisol and humogley). Stability of structural aggregate, designated in the subsurface horizon of test profile indicates for all samples tested, that according to the classification by degree of stability of microaggregates by Vagler, all samples belongs to stable or a very stable aggregates. Only one sample with the number of the profile 16, where the micro aggregates are rather stable. The tested samples of the investigated profiles (surface horizon), compared to the risk of crust formation time, showing 50.00% of the tested samples are in the high risk area; 37.50% marginal risk of crust formation, while in 12.50% of samples tested have low risk of crust formation. Some of the measures to be taken in the event of the identified high-risk and of the border of the crust formation time for reduction of the problems, the soil processing should be performed in the most favorable humidity conditions, by calcification of acidic soils, by application of humus-rich fertilizers and humus substances.

### Acknowledgment

Project No. TP 37006 is funded by the Ministry of Education, Science and Technological Development, Republic of Serbia.

## References

- Amezketta, E. (1999): Soil aggregate stability: A review. *J. Sustain. Agric.* 14, 83–151.
- Belanović, S. (2012): Soil reclamation practicum, University of Belgrade, Faculty of Forestry (in Serbian).
- Belić, M., Pejić, B., Hadžić, V., Bošnjak, Đ., Nešić, Lj., Maksimović, L., Šeremešić, S. (2004): Irrigation effects on chernozem structure. "Proceedings", Institute of field and vegetable crops, Novi Sad, vol. 40:129-141, (in Serbian).
- Bronick, C.J., Lal, R. (2005): Soil structure and management: a review. *Geoderma*,124:3-22.
- Carter, M. R. (1996): Analysis of soil organic matter storage in agroecosystems. In Carter, M.R.&Stewart, B.A. (eds) *Structure and organic matter storage in agricultural soils*, pp. 3-14. (Advances in soil science) CRC Pres, Inc.
- Ćirić, V., Manojlović, M., Belić, M., Nešić, Lj., Šeremešić, S. (2012): Aggregate Stability and Sealing Risk of Solonetz under Different Land Use Regimes. *Field and Vegetable Crops Research*, 49(3), 243-249, (in Serbian).
- Ćirić, V., Belić, M., Nešić, Lj., Savin, L., Simikić, M., Gligorić, R., Šeremešić, S. (2013): Structural stability of chernozem under different Production systems, *Cont.agr.engng*.39(3): 177-186, (in Serbian).
- Franzluebbers, A. J. (2002). Water infiltration and soil structure related to organic matter and its stratification with depth. *Soil and Tillage Research*, 66(2): 197-205.
- Gajić, B., Dugalić, G., Đurović, N. (2006). Comparison of soil organic matter content, aggregate composition and water stability of gleyic fluvisol from adjacent forest and cultivated areas. *Agronomy Research* 4(2): 499-508.
- Gérif, J., Richard, G., Dürr, C., Machet, J. M., Recous, S., Roger-Estrade, J. (2001): A review of tillage effects on crop residue management, seedbed conditions, and seedling establishment. *Soil Till. Res.*61:13-32.
- Igwe, C. A., Obalum, S. E. (2013): Microaggregate Stability of Tropical Soils and its Roles on Soil Erosion Hazard Prediction. Chapter in Book: *Advances in Agrophysical Research*, by Dobrzański, S. Grundas and A. Stepniewski, InTech.
- Yugoslav Society for Soil Surveying JDPZ (1966): Group of authors, *Soil Survey Manual*, Volume I, Chemical Methods of Soil Survey, Belgrade, (in Serbian).
- JDPZ (1997): Group of authors, *Methods of research and determination of physical properties of the Soil*, Novi Sad, (in Serbian).
- Kandeler, E., Murer, E. (1993): Aggregate stability and soil microbial processes in a soil with different cultivation. *Geoderma*, 56:503–513.
- Nešić, Lj., Belić, M., Savin, L., Ćirić, V., Stefanović, M., Manojlović, M. (2014): Effect of organic production on soil structure. *Bulg. J. Agric. Sci.*, 20: 1168-1174.
- Oades J.M, Waters A.G. (1991): Aggregate hierarchy in soils. *Australian journal of Soil Research*, 29: 815-828.
- Pavićević Nikola (1972): *Soil physics*, Beograd-Zemun, (in Serbian).
- Sorochkin, V. M. (1991): On the question how to choose indices for agronomical evaluation of the soil structure. *Soil Sci.* 7:50–58 (in Russian).
- Shepherd, T. G., Saggar, S., Newman, R. H., Ross, C. W., Dando, J. L. (2001): Tillage-induced changes to soil structure and organic carbon fractions in New Zealand soils. *Aust. J. Soil Res.* 39:465–489.
- Tisdall, J.M, Oades, J.M. (1982): Organic matter and water-stable aggregates in soils. *Journal of Soil Science*, 33: 141-163.
- Van der Watt H. V. H., Claasens A. S. (1990): Effect of surface treatment on soil crusting and infiltration. *Soil Technol.* 3, 241-251.

- Vučić N. (1964): Water features of chernozems and meadow blacklands and their significance for irrigation in the irrigation area of Bačka, Contemporary Agriculture - special edition, number 1, Novi Sad, (in Serbian).
- Vučić N., Marić V. (1992): Hygiene of soil. Vojvodina Academy of Sciences and Arts, (in Serbian).
- WRB (2014): World reference base for soil resources - international soil classification system for naming soils and creating legends for soil maps. Food and Agriculture Organization of the United Nations, Rome, <http://www.fao.org/3/a-i3794e.pdf>.

## PRELIMINARY IDENTIFICATION OF EUROPEAN CORN BORER PHEROMONE RACES AND FLIGHT DYNAMICS IN BEČEJ, NORTHERN SERBIA

Snežana TANASKOVIĆ<sup>1\*</sup>, Branka POPOVIĆ<sup>1</sup>, Sonja GVOZDENAC<sup>2</sup>, Zsolt KARPÁTI<sup>3</sup>, Csengele BÓGNAR<sup>3</sup>, Matthias ERB<sup>4</sup>

<sup>1</sup>University of Kragujevac, Faculty of Agronomy in Čačak, Cara Dušana 34, Čačak, Serbia

<sup>2</sup>Institute of Field and Vegetable Crops, Maksima Gorkog 30, Novi Sad, Serbia

<sup>3</sup>Department of Zoology, Plant Protection Institute Hungarian Academy of Sciences, Budapest, Hungary

<sup>4</sup>Functional Plant Biology, Institute of Plant Sciences, University of Bern, Switzerland

\*Corresponding author: stanasko@kg.ac.rs

### Abstract

European corn borer (ECB) is a pest of maize present worldwide in maize fields. It is a polyphagous pest, but maize (*Zea mays*) is the main reproductive host. In Europe and North America Z, E and H phero-races are determined. The aim of the study was to identify the presence and flight dynamics of different ECB races in main maize production region in Serbia. In an experimental field (Bečej, northern Serbia) delta pheromone traps and lures of all three strains (Csalomon, Hungary) were placed. Empty traps were the control. Traps were inspected weekly and sticky bases replaced or cleaned, while lures were replaced monthly. Observation indicates the presence of all three pheromone races in northern Serbia. The largest number of caught ECB males belonged to Z strain (total 102 specimens), 12 specimens belonged to H strain and the smallest number (3 specimens) to E strain. The first catches of Z males were registered on 2<sup>nd</sup> June (3 specimens) and the last on 9<sup>th</sup> October (34), the largest number was caught on 16<sup>th</sup> August (54). First specimens of E strain were caught on 16<sup>th</sup> August (2) and second on 9<sup>th</sup> October (1 specimen). Catches on H traps were registered on 16<sup>th</sup> (9) and 27<sup>th</sup> August (3 specimens). According to these preliminary results, the highest number of caught specimens on the territory of Vojvodina belongs to the Z pheromone strain of ECB. Detailed GSMS analyses will precisely identify which ECB strains are present in northern Serbia and confirm these preliminary results.

**Keywords:** *European corn borer, Pheromone traps, Flight dynamics, Pheromone races GSMS analysis.*

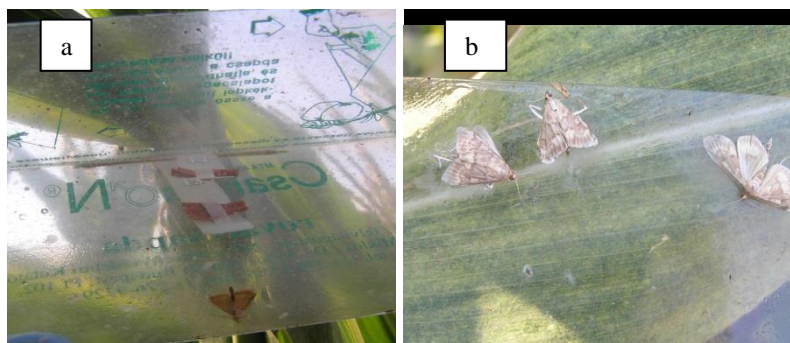
### Introduction

The European corn borer, *Ostrinia nubilalis* Hübner (Lepidoptera, Crambidae), is of agricultural significance in Northern hemisphere, including Europe, Asia, Africa, America, Japan (Beck, 1987). It is a polyphagous herbivore (Mason *et al.*, 1996). It affects maize production, but beside the maize as nutritive and reproductive plant, ECB, can feed and multiply on more than 224 plants including sorghum, cotton, potatoes, paper, hop (Lewis, 1975; Marcon *et al.*, 1999; Ponsard *et al.*, 2004). The ECB is native to Europe and its presence in European entomofauna was established around the 1500 year (Beck, 1987; Bethenod *et al.*, 2005). The first identification of ECB as economically important maize pest was in 1835 in France (Coffrey and Worthley, 1927). In maize production, the monitoring of flight dynamics is usually carried out by light traps, sex pheromone traps or a combination of sex pheromone and attractant multi-baited traps. When sex pheromone baited traps are used for monitoring of moths flight, it is crucial that the pheromone blend used as a bait in the traps is representative blend for the local European corn borer population (Sorenson *et al.*, 1992; Bourguet *et al.*, 1999). Although moth catches in pheromone-baited traps do not indicate at

the intensity of larval infestation that will subsequently develop, monitoring of moth flights provides valuable information on the time of oviposition i.e. indicate precisely at time of moth presence in the field. In that way, these traps could be useful for timely insecticide application in the field and provide efficient control. For insects, sex pheromones represent typically blend of small numbers of volatile organic compound, so even the small change in ratio or identity of the blend can affect the nature of the response (Olsson *et al.*, 2010). ECB consists of two sympatric races and each use opposite ratios of components in the similar pheromone blends (Olsson *et al.*, 2010). The Z strain uses a 3:97 ratio of E: Z-11 tetradecenyl acetate while the E strain uses a 99:1 ratio of the E: Z isomers (Kluns and Cooperators, 1975; Glover *et al.*, 1987). Male response to female pheromone production are identical in each of this races, but E strain males have been shown to respond to a wider range of blend ratios than Z males (Linn *et al.*, 1997). In the France, ECB strain development depends on the host and reproductive plants. ECB-Z race feeds and develops exclusively on maize while E race develops on hop (*Humulus lupulus*) and mugwort (*Artemisia absinthium*) (Malausa *et al.*, 2007a; Pelozuelo *et al.*, 2004; Rak Cizej *et al.*, 2013). In the USA, both races develop on maize (Dopman *et al.*, 2010). The first presence of ECB, Z races, in the Balkans was identified on the territory of Belgrade and Osijek (Anglade *et al.*, 1984). ECB moths live 10 days on average, with the highest activity during the night (Hill, 1987). High humidity and good nutrition have the positive effects on life and fertility of this pest (Leahy and Andow, 1994). Different climatic conditions, vegetation and maize production in different region had the influence to appearances of a different number of generations per year (Bača *et al.*, 2002). On the territory of Serbia, from one dominate generation, ECB today can produce more generations per year (Vajgnad, 2010) i.e. up to four.

### Material and method

The experiment in the field was carried out from April 18<sup>th</sup> to October 1<sup>st</sup> 2016 i.e. from sowing to harvest. It was performed in Bečej, Vojvodina province, Northern Serbia. For the experiment, Serbian cultivar NS-640 was chosen. An experiment was set up in the field with low WCR natural infestation. Pheromone traps for ECB were placed (May 25<sup>th</sup>, 2016) at the edges of maize field with 15 steps i.e. at least 10m between (Picture 1). Pheromone traps were used for all three different races of ECB (Z, E and H) and empty traps as control traps, labeled with C, were placed as well. Traps are obtained from Institute for plant protection, Budapest, Hungary. They were labeled according to lure i.e. E - strain lures (1:99 Z11-14Ac: E11-14Ac), Z-strain lures (97:3 Z11-14Ac: E11-14Ac), H - strain lures (50:50 Z11-14Ac: E11-14Ac) and C - control or empty traps. On sticky bases for all traps, RAG egér (BIOTOLL) was used as a glue. The field was inspected every week from installment of traps to harvest. In each field inspection, sticky bases in all type of pheromone traps were inspected as well, the presence of ECB was recorded and sticky surfaces were replaced.



Pictures 1. Delta pheromone trap (a) and ECB males on sticky bases (b)

## Results and discussion

According to the obtained data from the field, the number of caught ECB specimens was fluctuating during the vegetation period in 2016. The biggest number of caught specimens was on August 16<sup>th</sup> in Z pheromone traps with 54 ECB males registered (Figure 1). The first catch in Z traps was on June 3<sup>rd</sup> (3 specimens) and the latest was on September 10<sup>th</sup> with 34 specimens registered (Figure 1). The smallest catch was on 9<sup>th</sup> and 15<sup>th</sup> June with one registered specimen (Figure 1).

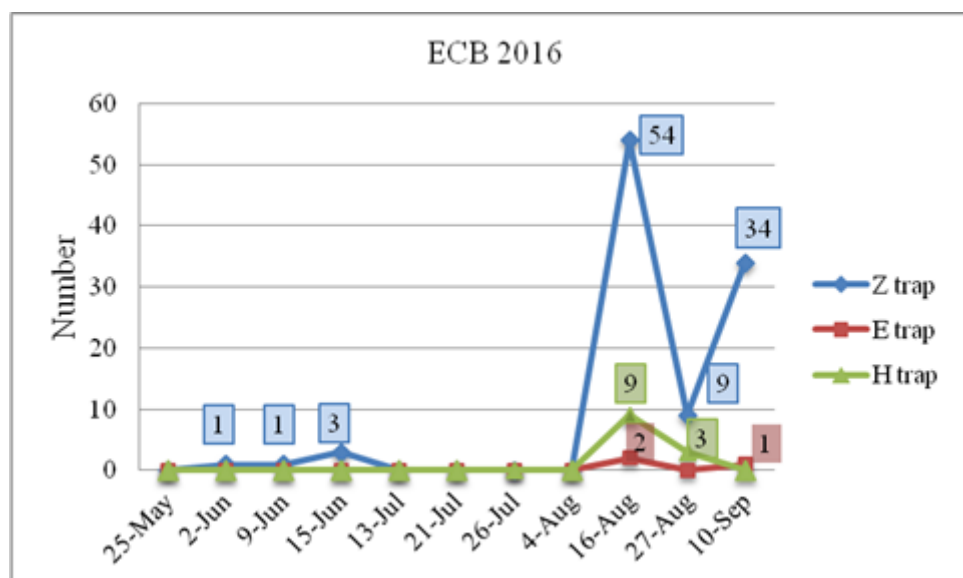


Figure 1. Flight dynamic of European corn borer

During the field inspection, caught specimens were also registered on E and H traps (Figure 1). The first registered caught on E trap was on August 16<sup>th</sup> with 2 specimens and the second and last, on September 10<sup>th</sup> with only one registered specimen (Figure 1). The first catches on H traps were on 16<sup>th</sup> August (9 specimens) and the second and last was 27<sup>th</sup> August with registered 3 specimens (Figure 1). According to Tanasković *et al.* (2017), the first catch during 2014 on the territory of Vojvodina was on 17<sup>th</sup> July with registered 1 specimen. During 2015 the first catch was registered on 23<sup>rd</sup> June (four specimens). The same authors record the latest catches in Vojvodina province in 2014 on August 20<sup>th</sup> (4 specimens) and in 2015 on September 10<sup>th</sup> (11 specimens). According to the number of caught specimens in all three types of pheromone traps (Z, E and H), the largest number of caught ECB males belonged to Z strain with registered 102 specimens during the vegetation period in 2016 (Figure 2). In E traps, only 3 specimens were registered and in H pheromone traps 12 specimens (Figure 2). According to these preliminary results, the largest number of caught specimens on the territory of Vojvodina belongs to the Z pheromone strain of ECB. These results are in accordance with research of Tanasković *et al.* (2017) regarding the preliminary identification of ECB strains in Vojvodina in 2014 and 2015.



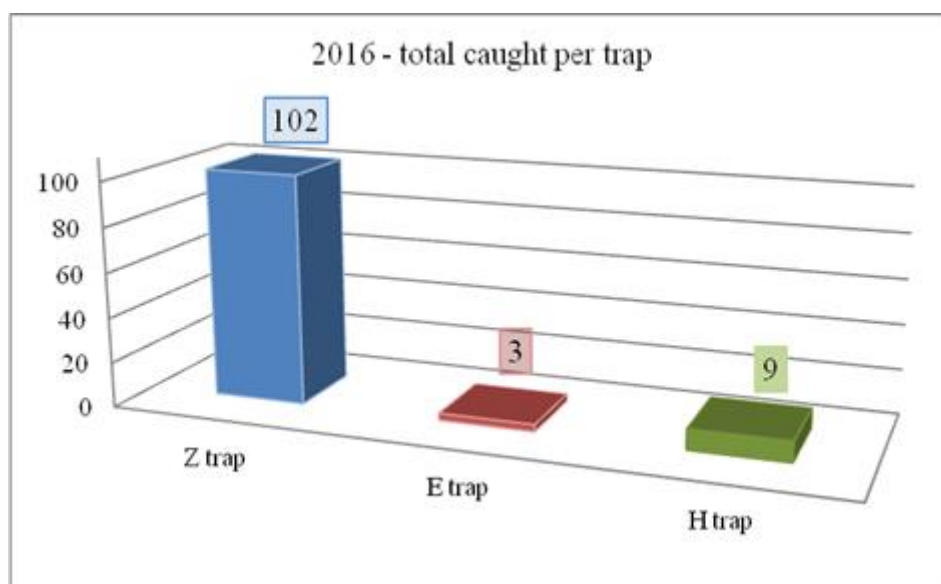


Figure2. Total number of caught European corn borer males per strain in pheromone traps.

Behavior and flight dynamics of ECB depend on temperature, humidity and also nutrition. During research in Poland, authors concluded that average daily temperature, number of rainy and windy days have obvious effect on the flight dynamics of ECB (Bereś, 2011). In the same research, during 2006, 2007 and 2008, a significantly lower number of caught ECB moths was recorded than during our research. Precisely, in Poland, 24, 12 and 9 specimens were caught per year, respectively. In Vojvodina province, according to the data from light traps and research of Čamprag (2002) and Vajgnad (2010), the flight of the first generation was registered on May 1<sup>st</sup> and the flight of second generation was in mid of July - beginning of August.

During our research period, we the first catch in pheromone traps on 2<sup>nd</sup> Jun, which is one month later than in research of Čamprag (2002) and Vajgnad, (2010). Also, the flight was prolonged, but ECB flight in cold period was longer than in warm, rainy period with hot and drought weather (Kania, 1961). Empirical data indicate that climatic factors have the big influence of population dynamics of ECB flight (Cordero *et al.*, 1998). This is completely accorded with our results.

These results represent preliminary identifications of ECB strains presence in maize field in Bečej region. Detailed GS-MS analysis will confirm preliminary strain identification of caught specimens.

### Conclusion

This research and literate data indicate that the use of pheromone traps in the field is a necessary predictive and preventive measure, for confirmation of ECB presence in the field. In further research, we will continue to follow the influence of ECB on plant damages and yield losses in a maize field.

### Acknowledgement

These results are the part of SCOPES project "Understanding plant-mediated interactions between two major maize pests of Eastern Europe - From phytochemical patterns to management recommendations". Project No. IZ73Z0\_152313/1 project.

## References

- Anglade, P., Stockel, J., I.W.G.O. cooperators (1984). Intraspecies sex-pheromone variability in the European corn borer, *Ostrinia nubilalis* Hbn (Lepidoptera, Pyralidae), *Agronomy*, 4(2):183–187.
- Bača, F., Almaši, R., Čamprag, D., Sekulić, R., (2002). Štetočine kukuruza i njihovo suzbijanje. Bolesti, štetočine i korovi kukuruza i njihovo suzbijanje, Novi Sad, 2002, 263 str.
- Beck, S.D. (1987). Developmental and seasonal biology of *Ostrinia nubilalis*. *Agric Zoo1 Rev* 2: 59–96.
- Bereš, P.K. (2012). Flight Dynamics of *Ostrinia nubilalis* Hbn (Lep., Crambidae) based on the light and pheromone trap catches in Nienadowka (South-Eastern Poland) in 2006–2008. *Journal of Plant Protection Research*, 52(1): 130–138. doi:10.2478/v10045-012-0021-8.
- Bethenod, M.T., Thomas T. Y., Rousset, F., Frérot, B., Pélozuelo, L., Genestier, G., and Bourguet, D. (2005). Genetic isolation between two sympatric host plant races of the European corn borer, *Ostrinia nubilalis* Hübner. II: assortative mating and host-plant preferences for oviposition 264–270. doi:10.1038/2004.
- Bourguet, D., Trouvé, C., Pinte S., Bethenod, M.T., Frérot, B., (1999): European corn borer in the hop fields of northern France. *Phytoma*, No. 517:48–49.
- Čamprag, D., (2002). Štetočine kukuruza. Bolesti, štetočine i korovi kukuruza i njihovo suzbijanje, Novi Sad, pp 269–271.
- Coffrey, D., Worthley, L. H., (1972). A progress report on the investigation of the European corn borer (USDA) Bull. 1476, 155pp.
- Cordero A., Malvar R.A., Butrón A., Revilla P., Velasco P., Oradás A. (1998). Population dynamic and life-cycle of Corn Borers in South Atlantic European coast. *Maydica* 43. 5–12.
- Dopman EB, Robbins PS, Seaman A (2010). Components of reproductive isolation between North American pheromone strains of the European corn borer. *Evolution* 64:881–902.
- Glover T, Tang X, Roelofs W (1987). Sex pheromone blend discrimination by male moths from E and Z strains of European Corn Borer. *J Chem Ecol*, 13(1):143–151.
- Hill, D. S. (1987). *Agricultural insect pests of temperate regions and their control*. Cambridge University Press. 1–659.
- Kluns J, Cooperators: Insect sex pheromones (1975). Intraspecific pheromonal variability of *Ostrinia nubilalis* in North America and Europe. *Environ Entomol* 1975, 4:891–894.
- Leahy, T. C., Andow, D. A. (1994). Egg weight, fecundity and longevity are increased by adult feeding in *Ostrinia nubilalis* (Lepidoptera: Pyralidae). *Ann. Entomol. Soc. Am.* 87: 342–349.
- Lewis, L. C. (1975). Natural regulation of crop pests in their indigenous ecosystems and in Iowa agrosystems: bioregulation of economic insect pests. *Iowa State J. Res.* 49: 435–445.
- Linn C. Jr., Young M., Gendle M., Glover T., Roelofs W. (1997). Sex pheromone blend discrimination in two races and hybrids of the European Corn Borer moth, *Ostrinia nubilalis*. *Physiol Entomol* 1997, 22:212–223.
- Malausa T, Dalecky A, Ponsard S, Audiot P, Streiff R, Chaval Y, Bourguet D (2007). Genetic structure and gene flow in French populations of two *Ostrinia* taxa: host races or sibling species? *Mol Ecol* 16:4210–422.

- Marcon, P. C. R. G., Taylor, D. B., Mason, C. E., Hellrnich R. L. and Siegfried B. D. (1999). Genetic similarity among pheromone and voltinism races of *Ostrinia nubilalis* (Hubner) (Lepidoptera: Crambidae) *Insect Molecular Biology* 8(2), 213–221 University of Nebraska Lincoln.
- Mason, C. E., Rice, M. E., Calvin, D. D., Van Duyn, J. W., Showers, W. B., Hutchison, W. D., Witkowski, J. F., Higgins, R. A., Onstad, D. W. and Dively, G. P., (1996). European corn borer ecology and management. North Central Regional Extension Publication 327 revised. Iowa State University, Ames.
- Olsson S.O., Kesevan S., Groot T.A., Dekker T., Heckel D.G., Hansso S.B. (2010). *Ostrinia* revisited: Evidence for sex linkage in European Corn Borer *Ostrinia nubilalis* (Hubner) pheromone reception *BMC Evolutionary Biology* 2010, 10:285 <http://www.biomedcentral.com/1471-2148/10/285>.
- Pelozuelo L, Malosse C, Genestier G, Guenego H, Frerot B (2004). Host-plant specialization in pheromone strains of the European corn borer *Ostrinia nubilalis* in France. *J Chem Ecol* 30:335–352.
- Ponsard, S., Bethenod, M. T., Bontemps, A., Pélozuelo, L., Souqual, M. C., Bourguet, D. (2004). Carbon stable isotopes: a tool for studying the mating, oviposition, and spatial distribution of races of European corn borer, *Ostrinia nubilalis*, among host plants in the field *Canadian Journal of Zoology*, 82(7): 1177–1185, 10.1139/z04-075.
- Rak Cizej, M., Cilenšek, A., Persolja, J., (2014): Monitoring the European corn borer (*Ostrinia nubilalis* Hübner) on hops (*Humulus lupulus* L.) with sex pheromone traps in Slovenia. *IOBC-WPRS Bulletin*, 99, 129–132.
- Sorenson, C.E., Kennedy, G.G., Duyn, W. van, Bradley, J.R. Jr, Walgenbach, J.F. (1992): Geographical variation in pheromone response of the European corn borer, *Ostrinia nubilalis*, in North Carolina. *Entomologia Experimentalis et Applicata*, 64(2):177–185.
- Tanasković S., Popović B., Gvozdenac S., Karpati Z., Bognar C., Erb M. (2017). Western corn rootworm and european corn borer – flight dynamics in Vojvodina province, Serbia. *International Symposium “Trends In European Agriculture Development” 11th Edition, Session 4: Biology Applied in Agriculture*, pp, 10.
- Vajgnad, D., (2010). Flight dynamic of Lepidoptera of economic importance in Sombor during 2010 and forecast for 2011. *Acta entomologica Serbica*, 15(2): 205–219.

## PLANT PATHOGENIC FUNGI CAUSERS: FUNGAL DISEASES OF THE HAIRY VETCH IN SERBIA

Tanja VASIĆ<sup>1\*</sup>, Vesna KRNJAJA<sup>2</sup>, Snežana BABIĆ<sup>1</sup>, Jordan MARKOVIĆ<sup>1</sup>, Jasmina MILENKOVIĆ<sup>1</sup>, Dragan TERZIĆ<sup>1</sup>, Sanja ŽIVKOVIĆ<sup>3</sup>

<sup>1</sup>Institute for Forage Crops, Kruševac, Serbia

<sup>2</sup>Institute for Animal Husbandry, Autoput 16, 11080 Belgrade, Serbia

<sup>3</sup>Faculty of Agriculture, Belgrad-Zemun, 11080 Belgrade-Zemun, Serbia

\*Corresponding author: tanja.vasic@ikbks.com

### Abstract

(*Vicia villosa* Roth.), is a vining, winter-active legume. It may be annual or biennial. Hairy vetch is a widely grown forage crop, although outside cultivation it is often considered to be a weed. It belongs in the legume family, Leguminosae (also known as Fabaceae). Hairy vetch is very similar to tufted vetch (*Vicia cracca*), the most noticeable difference being that tufted vetch has a smooth stem. It is a legume, grown as a forage crop, fodder crop, cover crop, and green manure. Diseases caused by phytopathogenic fungi every year have a significant impact on yields and quality of the final product to a greater or lesser degree. They can also affect trade plant material and cause the expansion of the disease in new areas where legumes are grown. There has not been a systematic research of hairy vetch mycoflora in Serbia. This research aims to present the results of preliminary research of mycopopulation of 15 different genotypes of hairy vetch. Total of 600 plant parts have been analyzed and 7 genera of fungi are isolated: *Fusarium*, *Phytophthora*, *Rhizoctonia*, *Phoma*, *Verticillium*, *Sclerotinia* and *Botrytis*. On plants from which the fungi were isolated, there were macroscopically clearly visible symptoms of infection. Symptoms in the form of color changes on stems and lateral branches have been identified.

**Key words:** *phytopathogenic fungi, hairy vetch, Serbia*

### Introduction

Hairy vetch (*Vicia villosa* Roth.) is annual plant from the legume family (Fabaceae) and originates from the temperate zone of Europe and Asia. It has a special place in the provision of animal fodder in the zone of moderate climate. It belongs to high-quality protein fodder plants (Mišković, 1986). Hairy vetch fixes large amounts of nitrogen (N) that help meet N needs of the following crop, protects soil from erosion, helps improve soil tilth, and provides weed control during its vigorous growth in the spring and when left as a dead mulch at the soil surface. Hairy vetch can also be grazed or harvested as forage. Research has shown that hairy vetch mulch can increase main crop disease resistance and prolong leaf photosynthesis of the following crop (Campiglia *et al.*, 2010). The diseases of legumes caused by phytopathogenic fungi occur, in a stronger or weaker intensity, regularly every year in all areas of the world. They have a significant impact on the reduction of potential yield of these cultures, but also the quality of the final product, trade of plant material and expansion of legumes into new areas (Porta-Puglia and Aragona, 1997). Vetch and bean anthracnose is caused by the fungus *Ascochyta fabae* Speg. (teleomorph *Didymella fabae* G.J. Jellis & Punith.) (Tivoli *et al.*, 2006). *Uromyces viciae-fabae* (Pers.) J. Schröt. is the causal agent of the rust in hairy vetch and bean and has a wide range of hosts, species from the genera *Pisum*, *Lathyrus* and *Lens* (Sillero and Rubiales, 2014). Two *Fusarium* species were determined on

the cultivated legumes seeds, *F. verticillioides* and *F. proliferatum*, respectively (Miličević *et al.*, 2013).

Similarly, *Erysiphe pisi*, *Botrytis cinerea*, *Rhizoctonia solani*, *Cercospora medicaginis*, *Pseudopeziza medicaginis*, *Sclerotinia trifoliorum*, *Stemphylium botryosum*, *Verticillium albo-atrum*, *Aphanomyces euteiches* as well as *Phytium*, *Leptosphaerulina*, *Phoma*, *Phytophthora* and *Alternaria* species are significant disease agents in hairy vetch, spread in all production areas (Morgan and Johnson, 1965; Stovold and Walker, 1980; Hughes and Grau, 2007; Villegas-Fernández and Rubiales, 2011; Salam *et al.*, 2011; Sillero and Rubiales, 2014). In case of severe infections a serious damage to hairy vetch seedlings could be caused. Considering the importance of hairy vetch as a fodder crop in Serbia, the aim of this study was to identify phytopathogenic fungi as casual agents of diseases in hairy vetch for a clearer perception of problems (the extinction of plants, reducing yields, deterioration of the quality of feed and other) arising as a result of the presence those fungi.

### Material and methods

For the mycopopulations study, samples were collected from the six experimental plant genotypes of hairy vetch (*Vicia villosa* Roth.) originating from Australia, nine wild-genotype originating from Serbia, from the Rasina region. The samples were collected between May and June 2015 at the location of the Institute for forage crops in Globoder. Parts of plants are carefully washed under running water. After washing, the parts of stem and roots are cut to piece of 0.5-1 cm in size. Prepared samples of roots and stems were disinfected with 96% ethanol for 10 seconds and with 1% sodium hypochlorite (NaOCl) for 1 minute and then washed three times in sterile distilled water. They were then dried on sterile filter paper and placed on potato dextrose agar (PDA) with streptomycin. Five pieces of the plant parts (roots and tree) were placed in each Petri dish in four replications. They were kept in a thermostat at 25 °C in 12 h light / 12 h night regime. The observations were performed every 3 days, and the majority of mycelium samples were developed up to 14 days. Developed mycelia were screened to a new PDA substrate and, after an initial grow, the peak part of the mycelium was reseeded on PDA again.

Microscopic examination was performed using microscopes Olympus CX31. Morphological identification of fungi to the genus was carried out using a standard key. Calculated by the frequency of isolation in % according to the formula Vrandečić *et al.* (2011):

$$(\%) \text{ Isolation frequency} = \frac{\text{Number of segments containing the fungal species}}{\text{Total number of segments used in the isolation}} \times 100$$

### Results

In the study of mycopopulations of hairy vetch genotypes, total of 600 parts of the plant were analyzed. On all plants from which fungi were isolated, there were clear symptoms on stems in the form of spots and necrotic lesions. From these plants, fungi from genus *Fusarium*, *Phytophthora* and *Botrytis* were isolated. Also, in large number of plants, there were necrosis with white airy mycelium in the lower third of stems and fungi from the genus *Sclerotinia* were isolated from those plants. In some plants, black fruiting bodies (pycnidia) were observed on stems, which have been found to belong to the genus *Phoma* (Table 1).

**Table 1.** Frequency of fungal isolation on hairy vetch

Genotypes	Number of samples		Fungi species - stem	(%) Isolation frequency	Fungi species - root	(%) Isolation frequency
	Plant part - stem	Plant part - root				
<i>Vicia villosa</i> (A)	20	20	<i>Fusarium</i> sp.	25	<i>Rhizoctonia</i> sp. <i>Fusarium</i> sp.	35 15
<i>Vicia villosa</i> (A)	20	20	<i>Fusarium</i> sp.	20	<i>Rhizoctonia</i> sp. <i>Fusarium</i> sp.	40 20
<i>Vicia villosa</i> (A)	20	20	<i>Fusarium</i> sp.	30	<i>Rhizoctonia</i> sp.	50
<i>Vicia villosa</i> (A)	20	20	<i>Verticillium</i> sp. <i>Fusarium</i> sp.	30 10	<i>Fusarium</i> sp. <i>Sclerotinia</i> sp. <i>Phytophthora</i> sp.	25 10 10
<i>Vicia villosa</i> (A)	20	20	<i>Sclerotinia</i> sp. <i>Phytophthora</i> sp. <i>Verticillium</i> sp.	5 5 20	<i>Fusarium</i> sp. <i>Phytophthora</i> sp.	5 45
<i>Vicia villosa</i> (A)	20	20	<i>Sclerotinia</i> sp. <i>Fusarium</i> sp. <i>Botrytis</i> sp.	5 5 15	<i>Rhizoctonia</i> sp.	25
<i>Vicia villosa</i> (S)	20	20	<i>Fusarium</i> sp. <i>Sclerotinia</i> sp. <i>Phytophthora</i> sp.	5 20 5	<i>Fusarium</i> sp. <i>Botrytis</i> sp. <i>Phytophthora</i> sp.	10 15 10
<i>Vicia villosa</i> (S)	20	20	<i>Fusarium</i> sp.	35	<i>Fusarium</i> sp.	10
<i>Vicia villosa</i> (S)	20	20	<i>Fusarium</i> sp. <i>Sclerotinia</i> sp.	5 20	<i>Rhizoctonia</i> sp.	20
<i>Vicia villosa</i> (S)	20	20	<i>Sclerotinia</i> sp.	10	<i>Rhizoctonia</i> sp. <i>Fusarium</i> sp.	15 5
<i>Vicia villosa</i> (S)	20	20	<i>Phoma</i> sp. <i>Botrytis</i> sp. <i>Sclerotinia</i> sp.	20 5 5	<i>Verticillium</i> sp. <i>Fusarium</i> sp.	20 15
<i>Vicia villosa</i> (S)	20	20	<i>Botrytis</i> sp. <i>Sclerotinia</i> sp. <i>Fusarium</i> sp.	15 10 10	<i>Sclerotinia</i> sp.	25
<i>Vicia villosa</i> (S)	20	20	<i>Botrytis</i> sp. <i>Sclerotinia</i> sp.	15 35	<i>Sclerotinia</i> sp. <i>Fusarium</i>	15 25
<i>Vicia villosa</i> (S)	20	20	<i>Sclerotinia</i> sp. <i>Fusarium</i> sp.	25 5	<i>Sclerotinia</i> sp.	30
<i>Vicia villosa</i> (S)	20	20	<i>Sclerotinia</i> sp.	25	<i>Rhizoctonia</i> sp. <i>Sclerotinia</i> sp.	15 10

The symptoms of a light to dark brown necrosis on the root system of the plants are observed and from these plants fungi of the genera *Fusarium*, *Phytophthora* and *Rhizoctonia* were isolated. Decolorisation of the conduction tissues on root system was observed in a large

number of plants and from these plants fungus of the genus *Verticillium* was isolated (Table 1). The results indicate that hairy vetch is vulnerable to the attack of a large number of phytopathogenic fungi that can have a significant impact on reducing its yield and quality.

### Discussion

In all the plants from which isolations were conducted there were clearly visible symptoms of the disease present. In these studies, there was difference in frequency of isolation of some genera of phytopathogenic fungi in both Australian and Serbian populations. It was observed that in the genotypes that originated in Serbia fungi of genus *Botrytis*, *Rhizoctonia*, *Fusarium* and *Sclerotinia* were frequently isolated. Also genera *Verticillium*, *Sclerotinia*, *Fusarium*, *Rhizoctonia* and *Phytophthora* were frequently isolated from Australian genotypes. Genera *Fusarium*, *Phytophthora*, *Rhizoctonia*, *Phoma*, *Verticillium*, *Alternaria*, *Sclerotinia*, *Botrytis* and *Ascochyta* were dominant in annual and perennial legumes worldwide (Tivoli *et al.*, 2006; Villegas-Fernández and Rubiales, 2011; Salam *et al.*, 2011; Sillero and Rubiales, 2014, Vasić *et al.*, 2015). Miličević *et al.* (2013) determined two *Fusarium* species *F. verticillioides* and *F. proliferatum* on vetch seed in Croatia. While Salam *et al.* (2011) cited genera *Ascochyta* and *Botrytis*, especially species *Ascochyta fabae* Speg. (teleomorph: *Didymella fabae*) and *Botrytis fabae*, *Botrytis cinerea* as significant pathogens on fava bean in Australia. It is important to mention that the parasites of the genus *Botrytis* overwinter in the form of sclerotia or mycelium into plant residues in the soil (Davidson *et al.*, 2004). So, for these reasons, it is recommended to utilize crop rotation of four years, when it comes to the sowing of vetch after the fava bean and pea (Salam *et al.*, 2011). Salam *et al.* (2011) also cited *Phoma medicaginis* var. *pinodella* and *Ascochyta pisi* as significant pathogens in pea. *Phytophthora medicaginis* was recorded on chickpea in Australia and it was also found that this parasite can infect other types of legumes (Salam *et al.*, 2011). *Sclerotinia trifoliorum* Eriks. often causes serious problems in many legumes in Greece (Lithourgidis *et al.*, 2005). *Rhizoctonia solani* Kühn is soil parasite that can cause serious problems in many legumes, especially on fava bean (Assunção *et al.*, 2011). In Canada, 304 fava bean genotypes were tested on the resistance to *R. solani* and only five of them were identified with high resistance (Rashid and Bernier, 1993). Ligoxigakis *et al.* (2002) determined the *V. dahliae* as a parasite on vetch and other legumes in Greece.

### Conclusion

This paper presents the preliminary results of mycopopulations of 20 experimental hairy vetch genotypes. Hairy vetch is very important forage crop and its importance as animal feed is growing within our country. This work is the beginning of a more comprehensive study of phytopathogenic fungi on hairy vetch. So far, there were no significant researches in this direction in Serbia, so the future researches related to hairy vetch will go in the direction of selection of genotypes with increased tolerance to fungal diseases.

### Acknowledgments

This work was funded by the Ministry of Education, Science and Technological Development Republic of Serbia, project TR 31057.

### References

- Assunção I. P., Nascimento L.D., Ferreira M.F.; Oolivira F.J., Michereff S.J., Lima G.S.A. (2011): Reaction of faba bean genotypes to *Rhizoctonia solani* and resistance stability. *Horticultura Brasileira* 29: 492-497.

- Campiglia E., Caporali F., Radicetti E., Mancinelli R. (2010): Hairy vetch (*Vicia villosa* Roth.) cover crop residue management for improving weed control and yield in no-tillage tomato (*Lycopersicon esculentum* Mill.) production. Volume 33, Issue 2, Pages 94–102.
- Davidson J.A., Pande S., Bretag T.W., Lindbeck K.D., Krishna-Kishore G. (2004): Biology and Management of *Botrytis* spp. in legume crops. In: Elad Y, Williamson B, Tudzynski P, Delen N (eds) *Botrytis: biology, pathology and control*. Kluwer Academic Publishers, Dordrecht, pp 295–318.
- Hughes T. J., Grau C. R. (2007): *Aphanomyces* root rot or common root rot of legumes. The Plant Health Instructor. DOI: 10.1094/PHI-I-2007-0418-01.
- Ligoxigakis E.K., Vakalounakis D.J., Thanassouloupoulos C.C. (2002): Host Range of *Verticillium dahliae* in cultivated species in Crete. *Phytoparasitica* 30(2):141-146.
- Lithourgidis A.S., Roupakias D.G., Damalas C.A. (2005): Inheritance of resistance to sclerotinia stem rot (*Sclerotinia trifoliorum*) in faba beans (*Vicia faba* L.). *Field Crops Research*, Volume 91, Issues 2–3, pp 125–130.
- Miličević T., Kaliterna J., Ivić D., Stričak A. (2013): Identification and occurrence of *Fusarium* species on seeds of common vetch, white Lupine and some wild legumes. *Agriculture*, 19 (1) 25-32.
- Mišković B. (1986): Forage crops. Scientific book, Belgrade. pp 23-48. (1-503).
- Morgan F. L., Johnson H. W. (1965): *Phytophthora* root and crown rot of Vetch. *Plant Disease Reporter*, Vol. 49 No. 1 pp. 84-88.
- Porta-Puglia A., Aragona M. (1997): Improvement of grain legumes - General part: diseases. *Field Crops Research* 53: 17-30.
- Rashid K. Y., Bernier C. C. (1993): Genetic diversity among isolates of *Rhizoctonia solani* and sources of resistance in *Vicia faba*. *Canadian Journal of Plant Pathology* 15: 23-28. SALT GA. 1982.
- Salam M.U., Davidson J.A., Thomas G.J., Ford R., Jones R.A.C., Lindbeck K. D., MacLeod W. J., Kimber R.B.E., Galloway J., Mantri N., van Leur J.A. G., Coutts B.A., Freeman A.J., Richardson H., Aftab M., Moore K.J., Knights E.J., Sillero J.C., Rojas-Molina M.M., Emeran A.A., Rubiales D. (2011): Rust resistance in faba bean. *Grain Legumes*, No. 56: 27-28.
- Sillero J.C., Rubiales D. (2014): Response of *Vicia* species to *Ascochyta fabae* and *Uromyces viciae-fabae*. *Czech J. Genet. Plant Breed.*, 50: 109–115.
- Stovold G., Walker J. (1980): A preliminary note on *Botrytis* spp. affecting *Vicia* in Australia. *Australasian Plant Pathology*, Volume 9, Issue 2, pp 10.
- Tivoli B., Baranger A., Avila C.M., Banniza S., Barbetti M., Chen W.D., Davidson J., Lindeck K., Kharrat M., Rubiales D., Sadiki M., Sillero J.C., Sweetingham M., Muehlbauer F.J. (2006): Screening techniques and sources of resistance to foliar diseases caused by major necrotrophic fungi in grain legumes. *Euphytica*, 147: 223–253.
- Villegas-Fernández A. M., Rubiales D. (2011): Chocolate spot resistance in faba bean. *Grain Legumes*, No. 56: 29-30.
- Vasić T., Milenković J., Lugić Z., Terzić D., Stanisavljević R., Blagojević M., Đokić D. (2015): Mycopopulation of different vetch genotypes in Serbia. *Plant protection*. Belgrade. Vol. 66 (1), No291, 45-50.
- Vrandečić K., Čosić J., Jurković D., Poštić J. (2011): Mycopopulation of medicinal plants in Croatia. *Agriculture*, 17 (2) 18-21.



## ESSENTIAL OILS AS AN ALTERNATIVE BACTERICIDES AGAINST SOFT-ROT BACTERIA, *PECTOBACTERIUM CAROTOVORUM* SUBSP. *CAROTOVORUM*

Tatjana POPOVIĆ<sup>1\*</sup>, Igor KOSTIĆ<sup>2</sup>, Zoran MILIĆEVIĆ<sup>1</sup>, Katarina GAŠIĆ<sup>1</sup>, Miroslav KOSTIĆ<sup>3</sup>, Marina DERVIŠEVIĆ<sup>2</sup>, Slobodan KRNJAJIĆ<sup>2</sup>

<sup>1</sup>Institute for Plant Protection and Environment, Belgrade, Serbia

<sup>2</sup>University of Belgrade, Institute for Multidisciplinary Research, Belgrade, Serbia

<sup>3</sup>Institute of Medical Plan Research " Dr Josif Pančić", Belgrade, Serbia

\*Corresponding author: tanjaizbis@gmail.com

### Abstract

Bacterial soft-rot disease caused by *Pectobacterium carotovorum* subsp. *carotovorum* is a very destructive disease with a diverse host range in agricultural crops, during the plant growth in the field and in storage. Control, usually based on the use of chemical products, is not satisfactory because of their harmful effect on human health and environment, as well as the possibility for pathogen resistance development. Therefore, developing of new natural products (such as essential oils-EOs, plant extracts etc.) with a sufficient efficacy in control of the disease was imposed. The current study included *in vitro* testing of bactericidal activity of 51 different oils against *P. c.* subsp. *carotovorum*, using an agar-diffusion assay. Bacterial suspension was mixed in Nutrient Agar to final concentration of  $10^7$ - $10^8$  cells/mL and poured in sterilized Petri plates ( $\varnothing$  90 mm). After media solidified, sterile filter paper discs ( $\varnothing$  5 mm) were placed on the surface of the Petri plates and supplemented with 20  $\mu$ L of each tested oils. The experiment was performed in a completely randomized design. The results were expressed as a width of inhibition zone (mm) and analyzed by one-factor analysis of variance by using the software package Statistica 7.0 (StatSoft, Inc.). Results showed that the 7 most efficient EOs against *P. c.* subsp. *carotovorum* (*Thymus vulgaris*, *Cinnamomum cassia*, *Cassia angustifolia*, *Origanum vulgare*, *Boswellia serrata*, *Eucalyptus globulus*, *Satureja montana*, respectively) achieved inhibition zone greater than 20 mm. Inhibition zones in the range of 15-20 mm were achieved by 8, 10-15 mm by 9, and less than 10 mm by 6 EOs. The rest of 21 Eos did not show any bactericidal effect.

**Keywords:** *in vitro*, bacteria, inhibition, essential oils.

### Introduction

Soft rot phytopathogens are responsible for several macerating diseases that can occur during the plant growth in the field but is more common during transport and in storage (Babadoost, 1990; Des Essarts *et al.*, 2016). The *Pectobacterium* bacteria (*Pectobacterium carotovorum* subsp. *carotovorum*, *P. atrosepticum*, *P. wasabiae*, *P. carotovorum* subsp. *brasiliense*) are among the most important responsible for these disease on a wide range of crop and ornamental plants (Babadoost, 1990). The damage caused by these pathogens remains an important issue in many countries worldwide (Des Essarts *et al.*, 2016). The bacteria attack succulent, tender tissues of storage organs (tubers, fruits, roots, bulbs, corms, rhizomes), as well as buds, stems, petioles and leafstalk tissues. The disease initially starts on leaves and stems in form of small, water-soaked, translucent lesions that rapidly enlarge in diameter and depth. The infected tissue becomes watery. Slimy bacteria exudates and cellular debris frequently ooze out from cracks in the tissues. Within one to three days, fleshy organs may rot

and collapse. Decaying tissue gives off a characteristically putrid odour which comes from saprophytic bacteria that are growing in the decomposing tissues (Babadoost, 1990). Control of soft rot pathogens is based on agricultural practices (eradication of diseased plants, removal and destroying of crop residues, crop rotation) and chemical control commonly based on the use of copper based products. The increasing interest in natural products as an alternative in disease control is mainly due to their low impact on the human health and environment (Jeong *et al.*, 2009; Mohan *et al.*, 2011). Natural substances such as essential oils (EOs) often function as antibacterial, antiviral, antimycotic, antitoxigenic, antiparasitic, and insecticidal or inducing resistance in plants through activation of biochemical defence pathways (Deans and Ritchie, 1987; Mihaliak *et al.*, 1991; Isman, 2000; Burt, 2004; Freeman and Beattie, 2008). EOs are aromatic and volatile oily liquids as products of secondary metabolism of aromatic plants, formed in special groups of cells and commonly concentrated in one particular region such as leaves, bark or fruit (Gutierrez *et al.*, 2008). They present complex mixtures of natural components among which predominate terpenes, terpenoids, aromatic and aliphatic components (Pichersky *et al.*, 2006; Bakkali *et al.*, 2008). These are particularly present in families: *Lamiaceae*, *Asteraceae*, *Lauraceae*, *Zingiberaceae*, *Myrtaceae*, *Rutaceae*, *Apiaceae* and *Pinaceae* (Gorunović and Lukić, 2001). The antibacterial effect of EOs and their components against soft rot pathogens was reported by some authors (Kalemba and Kunicka, 2003; El-Zemity *et al.*, 2008; de Lira Guerra *et al.*, 2014; Umunna and Anselem, 2014). Considering that soft rot disease is a one of limiting factor in the many crop production worldwide and the fact that effective control measures are insufficiently, the aim of this work was to evaluate the inhibitory potential of some EOs on the growth of soft rot pathogen, *P. c.* subsp. *carotovorum* by *in vitro* assay.

### Material and Methods

For the experiment the EOs of *Abies alba*, *Abies sibirica*, *Anethum graveolens*, *Boswellia carteri*, *Boswellia serrata*, *Cananga odorata*, *Cassia angustifolia*, *Cedrus atlantica*, *Cinnamomum cassia*, *Cinnamomum verum*, *Citrus bergamia*, *Citrus x limon*, *Citrus x sinensis*, *Coriandrum sativum*, *Cupressus sempervirens*, *Curcuma longa*, *Cymbopogon flexuosus*, *Cymbopogon martinii*, *Eucalyptus globulus*, *Foeniculum vulgare*, *Gaultheria procumbens*, *Jasminum grandiflorum*, *Juniperus communis*, *Juniperus virginiana*, *Laurus nobilis*, *Lavandula angustifolia*, *Lippia citriodora*, *Melaleuca alternifolia*, *Melaleuca quinquenervia*, *Mentha x piperita*, *Myristica fragrans*, *Nigella sativa*, *Ocimum basilicum*, *Origanum vulgare*, *Pelargonium graveolens*, *Petroselinum crispum*, *Pimpinella anisum*, *Pinus nigra*, *Pinus mugo*, *Pinus sylvestris*, *Piper nigrum*, *Pogostemon patchouli*, *Ravensara aromatica*, *Rosmarinus officinalis*, *Salvia sclarea*, *Santalum album*, *Satureja montana*, *Syzygium aromaticum*, *Thymus vulgaris*, *Vanilla planifolia* and *Zingiber officinale* were used. The strain of *P. carotovorum* subsp. *carotovorum* (KFB85) was obtained from the culture collection of the Faculty of Agriculture in Belgrade (Serbia). For use in the experiment, the strain was grown onto Nutrient Agar for 48 h at 26°C.

The inhibitory effect of the EOs on the growth of *P. c.* subsp. *carotovorum* was evaluated by Agar-diffusion assay. Bacterial suspension was mixed in Nutrient Agar to final concentration of  $10^7$ - $10^8$  cells/mL and poured in sterilized Petri plates (ø 90 mm). After media solidified, sterile filter paper discs (ø 5 mm) were placed on the surface of the Petri plates and supplemented with 20 µL of each of 51 tested oils. There were four replicates for each tested oil. As positive and negative controls served plates with and without bacterial culture in medium treated with sterile distilled water, respectively.

The experiment was performed in a completely randomized design. The presence/absence and the diameter of inhibition halos (mm) were determined 72 hours after incubation at 26°C.

Data were analyzed by one-factor analysis of variance by using the software package Statistica 7.0 (StatSoft, Inc.).

### Results and Discussion

Results showed that the 7 most efficient EOs against *P. c. subsp. carotovorum* (*Thymus vulgaris*, *Cinnamomum cassia*, *Cassia angustifolia*, *Origanum vulgare*, *Boswellia serrata*, *Eucalyptus globulus*, *Satureja montana*, respectively) achieved inhibition zone greater than 20 mm (Table 1). Inhibition zones in the range of 15-20 mm were achieved by 8 (*Melaleuca alternifolia*, *Rosmarinus officinalis*, *Anethum graveolens*, *Syzygium aromaticum*, *Laurus nobilis*, *Ravensara aromatica*, *Pimpinella anisum*, *Cinnamomum verum*), 10-15 mm by 9 (*Gaultheria procumbens*, *Cymbopogon martinii*, *Lavandula angustifolia*, *Cedrus atlantica*, *Citrus bergamia*, *Ocimum basilicum*, *Pinus sylvestris*, *Mentha x piperita*, *Lippia citriodora*), and less than 10 mm by 6 EOs (*Boswellia carteri*, *Pelargonium graveolens*, *Foeniculum vulgare*, *Pinus nigra*, *Cymbopogon flexuosus*, *Myristica fragrans*).

The rest of 21 EOs (*Cananga odorata*, *Nigella sativa*, *Santalum album*, *Coriandrum sativum*, *Petroselinum crispum*, *Citrus x limon*, *Citrus x sinensis*, *Zingiber officinale*, *Piper nigrum*, *Salvia sclarea*, *Abies alba*, *Juniperus communis*, *Abies sibirica*, *Pinus mugo*, *Cupressus sempervirens*, *Juniperus virginiana*, *Melaleuca quinquenervia*, *Pogostemon patchouli*, *Curcuma longa*, *Jasminum grandiflorum*, *Vanilla planifolia*) did not show any bactericidal effect.

Table 1. Inhibition zone in mm ( $\bar{X} \pm SE$ ) caused by the influence of the tested EOs. F relation and P value from ANOVA; df – number of degrees of freedom. Experimental groups with the same letter in column are not significantly different (Duncan Multiple Range Test,  $P < 0.05$ )

EOs	Inhibition zone (mm)
	$\bar{X} \pm SE$
<i>Rosmarinus officinalis</i>	1.83 ± 0.03ef
<i>Eucalyptus globulus</i>	2.03 ± 0.03cd
<i>Ocimum basilicum</i>	1.23 ± 0.03ij
<i>Lavandula angustifolia</i>	1.33 ± 0.03ij
<i>Pimpinella anisum</i>	1.53 ± 0.03gh
<i>Thymus vulgaris</i>	2.97 ± 0.03a
<i>Melaleuca alternifolia</i>	1.93 ± 0.03cde
<i>Syzygium aromaticum</i>	1.77 ± 0.07ef
<i>Lippia citriodora</i>	1.03 ± 0.03kl
<i>Laurus nobilis</i>	1.70 ± 0.07fg
<i>Boswellia serata</i>	2.07 ± 0.07cd
<i>Citrus bergamia</i>	1.27 ± 0.03ij
<i>Cymbopogon flexuosus</i>	0.93 ± 0.03l
<i>Cymbopogon martinii</i>	1.37 ± 0.03hi
<i>Myristica fragrans</i>	0.87 ± 0.03l
<i>Origanum vulgare</i>	2.60 ± 0.06b
<i>Satureja montana</i>	2.03 ± 0.07cd
<i>Pinus sylvestris</i>	1.17 ± 0.09jk
<i>Pinus nigra</i>	0.93 ± 0.03l
<i>Cedrus atlantica</i>	1.27 ± 0.07ij
<i>Foeniculum vulgare</i>	0.93 ± 0.03l
<i>Gaultheria procumbens</i>	1.37 ± 0.03hi
<i>Mentha x piperita</i>	1.17 ± 0.03jk
<i>Cinnamomum verum</i>	1.53 ± 0.03gh

<i>Cinnamomum cassia</i>	2.80 ± 0.06ab
<i>Pelargonium graveolens</i>	0.93 ± 0.03l
<i>Ravensara aromatica</i>	1.67 ± 0.07fg
<i>Boswellia carteri</i>	0.97 ± 0.03l
<i>Cassia angustifolia</i>	2.73 ± 0.03ab
<i>Anethum graveolens</i>	1.80 ± 0.12ef
F	87
P	< 0.0001
df	29, 60

There are a lot of reports on the use of EOs on several pathogenic bacteria. Deans and Ritchie (1987) cited ten most inhibitory EOs against 25 bacterial genera and the most comprehensively inhibitory extracts were angelica (against 25 genera), bay (24), cinnamon (23), clove (23), thyme (23), almond (bitter) (22), marjoram (22), pimento (22), geranium (21) and lovage (20). Recently, many studies have been specified the bactericidal activity of thyme as a promising active ingredient effective against a wide range of plant pathogenic bacteria (Deans and Ritchie, 1987; Kalemba and Kunicka, 2003; Alamshahi *et al.*, 2010; Lucas *et al.*, 2012; Rojas *et al.*, 2014; Alamshahi and Nezhad, 2015). Kalemba and Kunicka (2003) reviewed that besides thyme, EOs of cinnamon, clove and mint were found to possess the strongest antimicrobial properties among many tested bacteria.

Potential antibacterial properties of EOs against *P. carotovorum* in *in vitro* trials were described by some researchers; *c. Thymus vulgaris*, *Rosmarinus officinalis*, *Coriandrum sativum*, *Cuminum cyminum* by Alamshahi *et al.* (2010); cinnamon, clove, chenopodium, caraway, rosemary and thyme oils by El-Zemity *et al.* (2008); *Thymus vulgaris*, *Artemisia kermanensis*, *Lavandula officinalis*, *Rosemarinus officinalis*, *Eucalyptus caesia* by Mehrorosh *et al.* (2014); *Syzygium cumini* by Elansary *et al.* (2012); *Ziziphora clinopodioides* by Ozturk and Ercisli (2007). *Thymus vulgaris* compared to other extracts, possess the best inhibitory effect on *P. carotovorum* in the lowest concentration (Mehrrosh *et al.*, 2014). Results given by Nezhad *et al.* (2012) distinguish thyme as a most active for antibacterial activity against soft rot pathogen (*P. carotovorum*) and bacterial wilt pathogen (*Ralstonia solanacearum*); in the next positions were *Coriandrum sativum*, *Cuminum cyminum* and *Rosmarinus officinalis*; oil from *Eucalyptus globulus* was insignificant. Jeong *et al.* (2009) showing that EO from *Cymbopogon citrates* effectively inhibited the growth of *P. carotovorum* in a dose-dependent fashion, and 0.5% of the oil inhibited the growth of bacteria completely.

Variation in the potency of the EOs as well as in the sensitivity pattern of the test organisms was found by Umunna and Anselem (2014). Authors report *Zingiber officinale* oil to be most effective in the inhibition of *Erwinia* pathogen in the *in vitro* trials, but oils of *C. citratus* and *Azadirachta indica* in the *in vivo* experiment. *In vivo* trials given by Alamshahi and Nezhad (2015) showed that greenhouse experiments treatment by thyme EO caused a significant reduction in soft rot (*P. carotovorum*) and bacterial wilt (*R. solanacearum*) incidence on potato by 41 and 44%, respectively. Pradhanang *et al.* (2003) were found that *R. solanacearum* populations declined to undetectable levels in thymol, palmarosa oil, and lemongrass oil treatments showing that tomato seedlings transplanted in soil treated with EOs (700 mg/L of thymol oil, 700 ml/L of palmarosa oil, and 700 ml/L of lemongrass oil) were free from bacterial wilt and 100% of plants in thymol treatments were free of disease. De Lira Guerra *et al.* (2014) evaluated the action of 11 EOs in reducing soft rot in Chinese cabbage by spraying plants and found that spraying with the oils of bergamot, copaiba, *Eucalyptus citriodora*, spearmint and sweet orange has potential in the control of this disease.

Soft-rot or blackleg disease on potato could be controlled by using of EOs such as garlic (Nassar *et al.*, 2013) or thyme (Alamshahi *et al.*, 2010), respectively. Considering that thyme showed strong antibacterial activity against the *P. carotovorum* in our study and studies given by other authors it should be considered as a promising active ingredient for developing a new product for the disease control. Also, it should be remark that antimicrobial, antioxidant or other biological activities of natural EOs may be subject to change, based on vary in the chemical composition of the oil that may be observed due to the origin, their locality, the environmental conditions, and the stage of development of the collected plant material (Gulluce *et al.*, 2003).

### Conclusion

According to the obtained results, EOs of *Thymus vulgaris*, *Cinnamomum cassia*, *Cassia angustifolia*, *Origanum vulgare*, *Boswellia serrata*, *Eucalyptus globulus* and *Satureja montana* potentially might be used as antibacterial agents against plant pathogenic bacterium *P. c. subsp. carotovorum* for further analysis *in vivo* studies. Development of EOs as natural antimicrobial agents has a potential for further developing in agricultural pest management.

### Acknowledgment

This work was supported by the Ministry of Education, Science and Technological Development, Republic of Serbia, Projects No.III43010 and No.III43001.

### References

- Alamshahi L., Nezhad M.H. (2015). Effect of Essential Oils of Five Medicinal Plants on Two Microbial Diseases of Potato and Tomato under Laboratory and Field Condition. *International Journal of Agriculture Innovations and Research*, 4(2), pp. 390-395.
- Alamshahi L., Nezhad M.H., Panjehkeh N., Sabbagh S.K., Sadri S., (2010). Antibacterial Effects of Some Essential Oils on the Growth of *Pectobacterium carotovorum* subsp. *carotovorum*. *The 8th International Symposium on Biocontrol and Biotechnology*, pp. 170-176.
- Babadoost M., (1990). Bacterial soft rot of vegetables, fruits and ornamentals. *Plant disease*. University of Illinois Extension, College of Agriculture, Consumer and Environmental Sciences. <https://ipm.illinois.edu/diseases/rpds/943.pdf>
- Bakkali F., Averbeck S., Averbeck D., Idaomar M. (2008). Biological effects of essential oils—a review. *Food and chemical toxicology*, 46(2), pp. 446-475.
- Burt S. (2004). Essential oils: their antibacterial properties and potential applications in foods - a review. *International journal of food microbiology*, 94(3), pp. 223-253.
- Deans S.G., Ritchie G. (1987). Antibacterial properties of plant essential oils. *International journal of food microbiology*, 5(2), pp. 165-180.
- Des Essarts Y.R., Cigna J., Quêtu-Laurent A., Caron A., Munier E., Beury-Cirou A., Hélias V., Faure D. (2016). Biocontrol of the potato blackleg and soft rot diseases caused by *Dickeya dianthicola*. *Applied and environmental microbiology*, 82(1), pp. 268-278.
- Elansary H.O., Salem M.Z., Ashmawy N.A., Yacout M.M. (2012). Chemical composition, antibacterial and antioxidant activities of leaves essential oils from *Syzygium cumini* L., *Cupressus sempervirens* L. and *Lantana camara* L. from Egypt. *Journal of Agricultural Science*, 4(10), p. 144.
- El-Zemity S.R., Radwan M.A., El-Monam Mohamed S.A., Sherby S.M. (2008). Antibacterial screening of some essential oils, monoterpenoids and novel N-methyl carbamates based

- on monoterpenoids against *Agrobacterium tumefaciens* and *Erwinia carotovora*. Archives of Phytopathology and Plant Protection, 41(6), pp. 451-461.
- Freeman B.C., Beattie G.A. (2008). An Overview of Plant Defenses against Pathogens and Herbivores. The Plant Health Instructor. DOI: 10.1094/PHI-I-2008-0226-01
- Gorunović S.M., Lukić B.P. (2001). Farmakognozija. Farmaceutski fakultet, Univerzitet u Beogradu, Beograd.
- Guerra M.D.L., Guerra Y.D.L., Souza E.B.D., Mariano R.D.L.R. (2014). Essential plant oils in reducing the intensity of soft rot in Chinese cabbage. Revista Ciência Agronômica, 45(4), pp. 760-766.
- Gulluce M., Sokmen M., Daferera D., Agar G., Ozkan H., Kartal N., Polissiou M., Sokmen A., Sahin F. (2003). In-vitro antibacterial, antifungal and antioxidant activities of the essential oil and methanol extracts of herbal parts and callus cultures of *Satureja hortensis* L. J. Agric. Food Chem., 51(14), pp. 3958-3965.
- Gutierrez J., Barry-Ryan C., Bourke P. (2008). The antimicrobial efficacy of plant essential oil combinations and interactions with food ingredients. International journal of food microbiology, 124(1), pp. 91-97.
- Isman M.B. (2000). Plant essential oils for pest and disease management. Crop protection, 19(8), pp. 603-608.
- Jeong M.R., Park P.B., Kim D.H., Jang Y.S., Jeong H.S., Choi S.H. (2009). Essential oil prepared from *Cymbopogon citrates* exerted an antimicrobial activity against plant pathogenic and medical microorganisms. Mycobiology, 37(1), pp. 48-52.
- Lucas G.C., Alves E., Pereira R.B., Perina F.J., Souza R.M.D. (2012). Antibacterial activity of essential oils on *Xanthomonas vesicatoria* and control of bacterial spot in tomato. Pesquisa Agropecuária Brasileira, 47(3), pp. 351-359.
- Mehrorosh H., Gavanji S., Larki B., Mohammadi M.D., Karbasiun A., Bakhtari A. (2014). Essential oil composition and antimicrobial screening of some Iranian herbal plants on *Pectobacterium carotovorum*. Global Nest J, 16, pp. 240-250.
- Mihaliak C.A., Gershenzo J., Croteau R. (1991). Lack of rapid monoterpene turnover in rooted plants, implication for theories of plant chemical defense. Oecologia, 87(3), pp. 373-376.
- Mohan M., Haider S.Z., Andola H.C., Purohit V.K. (2011). Essential oils as green pesticides: for sustainable agriculture. Research Journal of Pharmaceutical, Biological and Chemical Sciences, 2(4), pp. 100-106.
- Nassar A.M., Abbassy M.A., Masoud S.A., Ghoneim M.M. (2013). Natural extracts of mushroom and garlic as bactericide alternatives against potato soft-rot bacteria, *Erwinia carotovora* subsp. *carotovora*. Journal of Agriculture and Environmental Sciences, Damanshour University, Egypt, Vol.12(3), pp. 1-18.
- Nezhad M.H., Alamshahi L., Panjehkeh N. (2012). Biocontrol efficiency of medicinal plants against *Pectobacterium carotovorum*, *Ralstonia solanacearum* and *Escherichia coli*. Open. Conf. Proc. J., 3, No. Suppl. 1-M8, pp. 46-51.
- Ozturk S., Ercisli S. (2007). Antibacterial activity and chemical constitutions of *Ziziphora clinopodioides*. Food Control, 18, pp. 535-540.
- Pichersky E., Noel J.P., Dudareva N., (2006). Biosynthesis of plant volatiles: nature's diversity and ingenuity. Science, 311, pp. 808-811.
- Pradhanang P.M., Momol M.T., Olson S.M., Jones J.B. (2003). Effects of plant essential oils on *Ralstonia solanacearum* population density and bacterial wilt incidence in tomato. Plant Disease, 87, pp. 423-427.
- Rojas F., Corzo L., Sánchez P., Brito D., Montes D.O., Martínez Y., Pino P. (2014). Antibacterial activity of essential oils against *Pectobacterium carotovorum* subsp. *carotovorum*. Revista de Protección Vegetal, 29(3), pp. 197-203.

Umunna O.E., Anselem A.B. (2014). Control of Postharvest Rot of Sweetpotato (*Ipomoea batatas* Lam.) Tuber in Vitro and in Vivo. *Journal of Agriculture and Sustainability*, 6(1), pp. 50-68.

## POSSIBILITY OF DRYING BURLEY TOBACCO TYPE IN A SOLAR DRYER

Vesna RADOJIČIĆ<sup>1\*</sup>, Gordana KULIĆ<sup>1</sup>, Nemanja MANDIĆ<sup>1</sup>, Maja MALNAR<sup>1</sup>, Nermina ĐULANČIĆ<sup>2</sup>

<sup>1</sup>University of Belgrade, Faculty of Agriculture, Belgrade-Zemun, Serbia

<sup>2</sup>University of Sarajevo, Faculty of Agriculture and Food Science, Sarajevo, Bosnia and Herzegovina

\*Corresponding author: mntabacco@agrif.bg.ac.rs

### Abstract

The aim of this experiment was to determine the possibility of drying Burley tobacco type in a solar drier, monitoring the parameters of the drying process and determination of the physical, chemical and sensory characteristics of tobacco. As a material we used Burley tobacco, the lower middle leaves from the production areas of Šabac (Serbia), vintage 2013. Drying was carried out in a solar passive-active drier F-1 at the Faculty of Agriculture, University of Belgrade. The results represent that drying was 16 days shorter comparing to the standard process of air curing Burley tobacco type. It has been found that the physical, chemical and sensory properties of the solar dried tobacco differ in relation to standard Burley. In general, the increase of equilibrium moisture content and quantity of soluble sugars, pH reduction, reduction of nitrogen components and ash quantity can be marked as a positive results. Such tobacco, due to acidic reaction, will be more pleasant to smoke compared to standard air curing Burley. In contrast, increasing the thickness of the leaf, the specific mass and the body fullness is a negative outcome, because such tobacco has worse cutting properties, lower filling power during cigarette making, which all result in an increased amount of smoke. According to the criteria for classification of Burley tobacco, and sensorial characteristics it is classified in third quality group. Burley tobacco type obtained in the experiment described could find its use in cigarettes blends, which opens up opportunities for further research.

**Keywords:** *solar dryer, Burley tobacco, chemical properties, physical properties, sensory properties*

### Introduction

Drying is the first technological operation during tobacco processing, which, in most cases is done by the manufacturer. It is the most important step, because it determines the direction of the transformation of substances present in tobacco leaf and directly affects the quality of the final product (Wiernik et al., 1996). The process of tobacco drying and the changes which will take place in the tobacco leaf depend on the mode of drying and the state of the material. In order to perform drying of tobacco leaves properly, it is necessary to provide conditions which will enable the removal of the excess moisture in a way to get a final product with the desired sensory characteristics, as well as with relevant chemical and physical properties (Radojičić, 2016). Burley has big leaves that are naturally dried by air curing. Drying is slower, and due to the more extensive oxidation process the leaf gets deeper brown color, which is preferred for this type of raw material. This drying process should give the tobacco which has medium or full tissue, with a thin and soft nervature, with superior elasticity (Đulančić, 2014). Although exhibition and desiccation are not strictly separated by the terms of the embodiment of the process, dry Burley can be divided into the following stages: the



stage of yellowing, the color fixation stage and the stage of the final drying of leaf and midrib (Tomić, 1973; Voges, 1984).

The aim of this experiment was to determine the possibility of drying Burley tobacco type in a solar dryer, through monitoring the parameters of the drying process and determination physical, chemical and sensory characteristics of the tobacco. Possibility use solar energy is becoming more attractive in industry and the crop materials processing. The reason for this is the fact that solar energy represents inexhaustible, economically viable, and at the same time the cleanest source of energy. Previous experiments on fruit, vegetable and herb drying in a solar dryer indicate that, except form the shortening of the drying process period, acceptable results could be achieved.

### **Materials and methods**

Material that we used is Burley tobacco type, the lower middle leaves, from the production area of Šabac (Serbia), vintage 2013. Tobacco was dried in a solar passive-active dryer F-1, at the Faculty of Agriculture, University of Belgrade. Preparation of the tobacco for drying was as it follows: each tobacco leaf was cut in half following its length and the midrib so that we obtained the same number of halves with or without the midrib. After that, the tobacco is strung so that each and every set (bandelier or string of tobacco) represented the same number of the above mentioned halves. Prepared strings were hung indoors for two days to perform the process of yellowing. On the third day strings were hung in a solar dryer. During the experiment the following parameters of the process were measured:

IDK ( $W m^{-2}$ ) – the intensity of the direct solar radiation in the level of the collector

Idk ( $W m^{-2}$ ) – the intensity of the diffuse solar radiation in the level of the collector

IGK ( $W m^{-2}$ ) – solar radiation in the level of the collector

IDH ( $W m^{-2}$ ) – the intensity of the direct solar radiation in the horizontal level of the collector

Idh ( $W m^{-2}$ ) – the intensity of the diffuse solar radiation in the horizontal level of the collector

IGH ( $W m^{-2}$ ) – global solar radiation on a horizontal level of the collector

$\varphi$  ok. – relative humidity of the outside air at the entrance to the absorber

$\varphi$  iz. – relative humidity at the outlet from the chamber dryer

W(%) – moisture in materials

Measuring of the intensity of direct and diffuse solar radiation is conducted with a solarimeter Kipp und Zonen 683132 with a pyranometer Microva AL 4CM-683297. When the diffuse radiation was measured we used a cover. The temperature and the relative humidity of air at the entrance in the absorber and the outlet of the chamber, as well as the temperature in the material were controled with a thermometer K-TYPE 5115; microprocessor - moisture meter, model No. RS7825PS, CE ISO-2178 mini meteorological station Kestrel 4000, Nielsen - Kellerman. Moisture in the material was determined by the standard method of periodic sampling (Radojičić, 2011). Physical properties that were determined in this experiment were: leaf thickness, tissue fullness, equilibrium moisture content and specific weight relative to the standard (Radojičić, 2011). On the other hand, measured chemical parameters were the following ones: pH, nicotine, total nitrogen, protein nitrogen, starche, soluble sugars and ash content according to the current ISO standards. All analyzes were done in five repetitions. Sensory characteristics and quality were evaluated according to classification criteria for tobacco leaves (JUS.E.P1.113: 2004). Statistical analysis were carried out with SPSS 17.0 software.

### **Results and discussion**

As shown in Table 1 and Table 2, the total duration of the drying process of the Burley tobacco type in a combined passive-active solar dryer F-1 lasted for a total of 12 days.

Table 1. Parameters followed during the first stage of tobacco drying

day	time	IdK W m <sup>-2</sup>	Idk W m <sup>-2</sup>	IGK W m <sup>-2</sup>	IDH W m <sup>-2</sup>	Idh W m <sup>-2</sup>	IGH W m <sup>-2</sup>	φ ok. %	φ iz. %	t ok. °C	t iz. °C	t mat. °C	W %
I	10.00	636.2	273.8	910	562.4	297.6	860.0	64	52	23.0	34.0	35.0	86.60
	11.00	682.9	262.6	945.5	630.4	253.9	884.3	62	50	23.4	35.5	35.5	
	12.00	551.6	253.9	805.4	525.3	245.2	770.4	68	47	24.5	33.0	34.5	84.29
	13.00	446.5	262.6	709.1	420.2	253.8	674.0	67	47	25.2	34.5	34.5	
	14.00	446.5	201.3	647.8	402.7	218.8	621.5	65	43	24.5	32.8	29.7	81.10
	15.00	166.3	122.6	288.9	148.8	105.0	253.8	64	42	25.0	30.0	29.7	
	16.00	288.9	131.3	420.2	280.2	122.6	402.7	65	42	25.5	31.1	29.7	80.60
II	10.30	604.1	192.6	796.7	569.0	192.6	761.6	65	48	24.0	32	35.5	80.18
	11.30	761.7	227.6	989.3	700.4	210.1	910.5	69	48	25.2	41	40.3	
	12.30	779.2	236.4	1015	726.6	210.1	936.7	62	47	26.1	42	42.3	
	13.30	761.7	192.6	954.3	744.2	183.8	928.0	60	40	27.5	45	43.3	80.06
	14.30	665.4	157.6	822.9	630.4	166.3	796.7	60	37	27.8	43	41.4	
	15.30	586.6	148.8	735.4	569.0	131.1	700.3	57	35	28.0	38	41.3	79.41
	16.30	472.7	122.6	595.3	464.0	113.8	577.8	56	33	28.0	38	37.5	
III	10.00	717.9	157.6	875.5	656.6	148.8	954.2	64	44	25.0	32.5	39.4	79.19
	11.00	796.7	157.6	954.3	779.2	148.8	928.0	63	42	26.3	36.0	41.3	
	12.00	822.9	157.6	980.5	770.4	148.8	919.2	61	42	27.5	35.0	42.3	
	13.00	805.5	175.1	980.6	787.9	166.3	954.2	60	40	28.6	39.0	44.2	74.56
	14.00	726.6	157.6	884.2	709.1	166.3	875.4	61	39	29.6	39.6	45.2	
	15.00	665.4	157.6	823.0	630.3	166.3	796.6	61	38	28.5	37.5	43.3	
	16.00	534.1	148.8	682.9	499.0	140.0	639.0	62	35	28.9	36.4	33.6	73.33
17.00	315.2	87.5	402.7	280.1	78.8	358.9	62	35	28.0	35.6	34.5		
IV	10.00	752.9	166.3	919.2	700.4	166.3	866.7	59	41	21.5	31.0	37.5	72.51
	11.00	849.2	175.1	1024.3	779.2	166.3	945.5	64	40	22.2	31.3	37.5	
	12.00	866.7	183.8	1050.5	831.7	166.3	998.0	69	39	23.6	40.8	44.2	
	13.00	884.2	166.3	1050.5	849.2	166.3	1015.5	60	38	24.0	38.5	42.3	72.32
	14.00	744.2	131.3	1006.8	735.4	122.6	858.0	60	36	25.5	37.4	43.3	
	15.00	656.6	140.1	796.7	639.1	122.6	761.7	58	36	24.3	37.8	42.3	
	16.00	577.8	105.1	682.8	612.8	105.0	717.8	58	33	24.0	38.0	41.3	68.81
V	10.00	849.2	393.9	1243.2	770.4	385.2	1154.6	68	45	24.0	37.0	41.3	67.72
	11.00	963.1	271.4	1234.5	849.2	175.1	1024.3	69	41	24.9	42.8	42.3	
	12.00	928.0	113.8	1041.8	831.7	87.5	919.2	70	41	26.0	44.5	45.2	
	13.00	919.3	87.5	1006.8	866.7	78.8	945.5	68	39	26.6	48.6	45.2	61.16
	14.00	831.7	96.3	928.0	805.5	87.5	893.0	64	36	27.4	46.0	44.2	
	15.00	671.4	87.5	761.6	630.4	78.8	709.2	64	34	26.8	44.5	39.4	
	16.00	428.9	96.3	525.2	420.2	87.5	507.7	62	34	26.8	38.2	38.4	44.95
VI	10.00	717.9	131.3	849.2	709.1	122.6	831.7	59	42	26.8	38.4	42.3	38.46
	11.00	849.2	113.8	963.0	787.9	113.8	901.7	64	40	28.0	38.6	44.2	
	12.00	884.2	140.1	1024.3	814.2	122.6	936.8	63	38	29.6	43.5	45.2	
	13.00	875.5	131.3	1006.8	831.7	105.0	936.7	60	36	31.6	39.4	47.1	35.08
	14.00	814.2	78.8	892.9	709.1	78.8	787.9	61	35	33.5	46.6	48.1	
	15.00	717.9	61.3	779.2	665.4	52.5	717.9	60	35	31.8	39.0	47.1	
	16.00	595.3	61.3	656.6	551.5	43.7	595.3	63	32	31.1	39.5	44.2	30.57

Before the beginning of drying process, tobacco was standing for 2 days (48 hours) in a closed room in order to finish the yellowing process. During this time the leaves crinkled and became bright green with yellow hues. In the classical method of drying yellowing stage lasts up to 15 days, and the leaves have a light brown color at the end. After that, tobacco had been placed for 12 more days (288 hours) in the solar dryer. During these days, the active dry (insolation duration) lasted for 58 hours. Compared with the classical drying of the Burley tobacco type in natural conditions (air curing-AC), which takes an average of 30 days, this process lasted significantly shorter (16 days less).

On the first day after placing of the tobacco strings in the dryer, the tops and edges of the leaves began to receive yellow color, while the next day they turned dark yellow and started to curl. On the third day, the color of the leaves was uniform dark yellow. On the fourth day of the drying process, some parts of the leaves obtained light brown color. During that day the leaves evenly darkened and continued to curl. On the fifth day we noticed that the leaves on the upper strings got darker more intensively than those on the lower strings. The reason for this might be the higher air temperature in the upper part of the dryer, because air that is heated in the absorber when passing through the dryer is additionally heated by direct sunlight through the transparent walls of the dryer. On the sixth day leaves completely curled, lost its shine and continued to darken. There was an increase in the percentage of dark spots on the leaves.

Table 2. Parameters followed during the second stage of tobacco drying

day	time	IDK W m <sup>-2</sup>	Idk W m <sup>-2</sup>	IGK W m <sup>-2</sup>	IDH W m <sup>-2</sup>	Idh W m <sup>-2</sup>	IGH W m <sup>-2</sup>	φ ok. %	φ iz. %	t ok. °C	t iz. °C	t mat. °C	W %
X	10.00	857.9	306.4	1164.3	814.2	297.7	1119.4	74	49	23.0	32.4	36.5	
	11.00	805.4	271.4	1076.8	796.7	297.7	1094.4	70	48	25.0	36.2	36.5	41.0
	12.00	866.7	210.1	1076.8	822.9	157.6	980.5	69	45	27.5	43.0	38.4	
	13.00	884.2	175.1	1059.3	849.2	175.1	1024.3	69	39	28.6	38.5	40.4	
	14.00	814.2	175.1	989.3	787.9	166.3	954.2	65	38	29.6	39.6	4.04	
	15.00	656.6	122.5	779.2	621.6	87.5	709.1	65	36	28.5	36.5	41.3	
	16.00	586.6	113.8	700.4	499.0	105.0	604.0	64	36	28.9	32.5	37.5	32.1
	17.00	297.6	78.8	376.4	262.2	70.0	332.6	64	35	27.0	32.5	36.5	
XI	10.00	551.5	192.6	744.1	525.3	183.8	7.901	64	44	23.5	34.2	35.5	
	11.00	604.1	236.4	840.5	569.0	218.8	787.8	68	43	25.2	35.0	36.5	26.8
	12.00	779.2	253.8	1033.1	752.9	236.4	989.3	66	40	27.0	36.5	40.4	
	13.00	796.7	166.3	963.0	779.2	157.6	936.8	65	38	29.0	37.0	41.3	
	14.00	866.7	140.1	1006.7	857.9	113.8	971.7	64	38	29.4	42.2	43.3	
	15.00	814.2	87.5	901.7	717.9	78.8	796.7	61	37	30.2	41.0	43.3	21.0
	16.00	446.5	122.6	569.1	411.5	105.0	516.6	61	34	29.6	40.2	41.3	
	17.00	166.3	78.8	245.1	157.6	61.3	218.9	61	34	28.0	38.0	40.4	
XII	10.00	542.8	253.9	796.7	481.5	175.1	656.6	64	41	25.0	32.0	35.5	17.91
	11.00	665.4	166.3	831.7	630.4	157.6	788.0	69	38	25.8	36.6	36.5	
	12.00	726.6	148.8	875.4	709.1	140.0	849.0	66	38	27.0	39.0	40.4	
	13.00	840.5	183.8	1024.3	822.9	166.3	989.2	61	38	29.6	47.5	41.3	
	14.00	822.9	157.6	980.5	796.7	148.8	945.5	60	35	31.0	47.0	43.3	12.43
	15.00	674.1	192.6	866.7	674.1	183.8	857.9	60	34	30.0	46.6	44.2	
	16.00	332.7	105.0	437.7	315.2	96.3	411.9	60	32	29.0	45.0	44.2	8.12

The next three days (seventh, eighth and ninth day), we did not performe measuring due to unfavorable weather conditions (cloudy with a chance of rain). Dryer was only occasionally

uncovered. During this time, most of the leaves got a brown color, while the midrib obtained a dark yellow color.

On the tenth day of the drying process we continued measuring (Table 2). We noted that side of the leaf facing the front of the dryer, which is exposed to direct sunlight squander, got more intensely darker than those facing the door at the back of the chamber. The midrib dried slowly and with difficulty. At the end of the twelfth day the drying process was completed. The leaves got brown. The midrib breaks under pressure.

The initial humidity of the tobacco leaves when entering the solar dryer was 86.6%. During the first four days of drying, moisture had been gradually and smoothly decreasing to 68.81%. After that, the process of moisture reduction intensified. At the end of the sixth day of drying, the moisture content in tobacco decreased to 30.57%. The next three days, due to adverse weather conditions (low temperature and increased relative humidity of the outside air), the moisture in the material increased to 43.71%. When drying process continued and weather conditions were appropriate, moisture content in the material decreased with greater intensity, so at the end of the twelfth day of drying it resulted in 8.12%.

**Physical characteristics of tobacco** Table 2 shows mean values of the examined physical characteristics of the Burley tobacco type dried in a solar dryer, as well as standard values for the tobacco dried in natural conditions (air curing-AC).

Table 2. Physical characteristics of Burley tobacco type

Mode of drying	Leaf thickness (mm)	Tissue fullness (g/cm <sup>3</sup> )	Specific weight (g/cm <sup>3</sup> )	Equilibrium moisture content (%)
Solar dryer	0.15	0.87	1.69	19.11
Air curing	0.12	0.37	1.55	16.84

Our results imply that significant changes did occur in physical characteristics of the leaf. Leaf tissue of the test sample was thicker than the standard one, which means that the decomposition of the material did not happen. Thickness of the leaf is inversely proportional to its quality and refers to its woody part. Such tobacco will be harder to cut and will have lower filling power compared with the tobacco dried in natural conditions. Furthermore, the tissue fullness and the specific weight in the solar dried tobacco was also higher than the standard. This differences are important because they cause higher tobacco density, which leads to increased draw resistance of cigarette smoke. This is due to high temperatures and shortened process of yellowing. Tobacco with higher specific weight provides more products in the process of cigarette burning. Taking all previously mentioned into account, the increase in the leaf thickness, tissue fullness and specific weight can be regarded as negative features.

In contrast, the increase in equilibrium moisture content can be considered as a positive result. The reason for this might be the shorter duration of yellowing, as well as the faster drying of the Burley tobacco in a solar dryer. All of this has prevented degradation of colloidal components, in particular pectins, which are responsible for this quality parameter (Davis and Nielsen, 1999).

**Chemical characteristics of tobacco**

The Table 3 shows the mean values of the measured chemical characteristics of the Burley tobacco type dried in a solar dryer, as well as standard values for the tobacco dried in natural conditions.

Table 3. Chemical characteristics of Burley tobacco type (%)

Mode of drying	pH	Nicotine	Total nitrogen	Protein nitrogen	Starch	Soluble sugars	Ash
Solar dryer	5.71	2.71	3.88	1.52	2.97	3.96	17.49
Air curing	5.80	2.91	3.96	1.77	0.60	0.21	21.53

\*pH in units

According to data in presented in Table 3, the pH value, nicotine, total nitrogen, protein nitrogen and ash content of the solar dried Burley tobacco was lower compared with the standard. These results are in agreement with the literature data (Radojičić, 2016), that the nicotine loss is greatest when dried in the sun. The ash content was also significantly reduced due to the drying process. According to the literature, if the drying takes longer, processes that alter the material are deeper, and will result in higher ash content (Burton et al., 1983). In contrast, the amount of starch and soluble sugars was higher than the standard. The increase in the amount of starch is a result of the shorter duration of yellowing. During this process, starch is decomposed completely under the influence of hydrolytic enzymes, which was omitted in this experiment. On the other hand, the increased soluble sugar content is a result of shorter drying process in the solar dryer. According to its genetic characteristics, Burley tobacco type has the least amount of carbohydrates compared with other tobacco types (Radojičić and Đukić, 1999). Because the drying in natural conditions lasts the longest, even this small amount can be almost completely decomposed. Since Burley contains a very small amount of sugar (literally in trace), the amount of 3.96% is significant.

### **Sensory properties of tobacco**

According to the standard JUS.E.P1.113: 2004 and after the completion of the drying process in the solar dryer, we evaluated the sensory characteristics of tobacco leaves and classified it in the third class. In case we dry the medium insertions of Burley in natural conditions, and follow all the process parameters during different phases of the drying operation, we could obtain I class tobacco leaves. Such a result would be a financial loss of about 5 euro per kg of tobacco.

### **Conclusion**

According to the results of the research we conducted on investigating the possibility of drying Burley tobacco in a solar dryer, we can conclude:

- 1.The duration of the drying process in a solar dryer was 16 days shorter compared with the standard process of drying in natural conditions (air curing-AC).
  - 2.The capacity of the dryer we used was relatively small. Given the size of the leaves of Burley tobacco, we managed to dry only two strings of tobacco leaves.
  - 3.The intensity of solar radiation varies during the day and depends on weather conditions and the position of the dryer. An active drying step lasts for only 8 hours per day. Parameters of the outside air (temperature, relative humidity) are also variable. It is therefore impossible to establish constant conditions in the dryer.
  - 4.Changes in the physical characteristics of the tobacco are as it follows: tissue fullness, leaf thickness, specific weight and equilibrium moisture content were higher compared with the standard.
  - 4.We also observed changes in chemical characteristics: the pH value, nicotine, total nitrogen, protein nitrogen and ash content was lower of the solar dried Burley tobacco compared with the standard. In contrast, the amount of starch and soluble sugars was higher.
- In general, as positive results, we can outline the following ones: the increase in the equilibrium moisture content, as well as the increase in soluble sugars, the reduction in pH and the reduction in nitrogen components.
- 5.Based on the the classification criteria for Burley tobacco according to its sensory characteristics, it was classified in the III quality group.

### **Acknowledgments**

Authors are grateful to the Ministry of Education, Science and Technology Development of Republic of Serbia, for their support (Project No. 46010).

### **References**

- Burton, H.R., Bush, L.P., Hamilton, J.L. (1983). Effect of curing on the chemical composition of burley tobacco. *Rec. Adv. Tob. Sci.* 9, 91-153.
- Davis, D., Nielsen, M.T. (1999). *Tobacco - Production, Chemistry and Technology*, book. Blackwell Science Ltd, Oxford, UK.
- Đulančić, N. (2014). *Processing and manufacturing of tobacco*, book. University of Sarajevo, Faculty of Agriculture and Food Sciences, Sarajevo. [in Bosnian]
- JUS.E.P1.113:2004. Unfermented tobacco in leaf. Burley type of tobacco, Specification.
- Radojičić, V., Djukić, M. (1999). A contribution to the study of changes in the dry matter of tobacco plants during drying in the shade. *Tutun Tobacco* 49 (11-12), 211-216.
- Radojičić, V. (2011). *Quality control of tobacco. Practicum in Tobacco Processing Technology*. University of Belgrade, Faculty of Agriculture, Belgrade. [in Serbian]
- Radojičić, V. (2016). *Tobacco technology*, book. University of Belgrade, Faculty of Agriculture, Belgrade. [in Serbian]
- Tomić, LJ. (1973). *Technology of tobacco processing*, book, Građevinska knjiga, Belgrade. [in Serbian]
- Voges, E. (1984). *Tobacco Encyclopedia. Part II, Articles*. Tobacco Journal International, Germany.
- Wiernik, A., Christakopoulos, L.J., Wahlbreg, I. (1996). Effect of air-curing on the chemical composition of tobacco. *Rec. Adv. Tob. Sci.* 21, 39-80.

## ALOE VERA PLANT: CHEMICAL ANALYSIS

Francisco Javier TOLEDO MARANTE\*, Ruggero ZENI, Julio Alberto TOLEDO  
MEDIAVILLA

Department of Chemistry, University of Las Palmas de Gran Canaria, Canary Islands, Spain

\*Corresponding author: franciscojavier.toledo@ulpgc.es

### Abstract

The Aloe vera plant (*Aloe barbadensis* Mill.) has been used in functional nutrition for decades. The plant produces a colorless extract composed of three fractions of different molecular sized mucopolysaccharides, and two aloin fractions (Aloe-emodin and barbaloin/isobarbaloin). While the first three are beneficial for human health - they stimulate the immune system - the last two produce diarrhea symptoms and, possibly, nephritic problems. The aim of this work was to chemically analyze the fresh juice contained in the plant, so as to identify and quantify the mucopolysaccharide (AVMP) and the aloin (the anthrachinon Aloe-emodin, barbaloin and isobarbaloin) on a regular and temporary basis (monthly, for a year). An analytical method capable of identifying and quantifying has been developed, based on the HPLC technique. For this, an OHPak SB-806 HQ Shodex column was installed in a VWR-Hitachi, Elite La Chrom liquid chromatograph, equipped with a pump, an automatic injector, a refraction index detector and an UV detector. Fresh Aloe vera leaves were collected monthly at the home property of Antonio del Rosario (Arinaga, Gran Canaria, Canary Islands). The concentration of AVMP fluctuated throughout the year between  $940 \pm 40$  and  $21600 \pm 700$  ppm, and yielded an annual average of  $5500 \pm 700$  ppm, whereas the aloin fluctuated during the same period between  $130 \pm 15$  and  $776 \pm 17$  ppm, yielding an average value of  $464 \pm 17$  ppm.

**Keywords:** *Aloe vera*, Chemical analysis, Mucopolysaccharide, Aloin, Spain.

### Introduction

*Aloe vera* (L) Burm. f. (Liliaceae) or *Aloe barbadensis* Miller is a medicinal plant used in folk medicine for the treatment of diverse illnesses. It is also used in the cosmetic industry and in dietary supplements. “Aloe Vera Gel”, “Latex” or “Juice”, and “Aloe” are different commercial products that can be obtained from the leaves of *A. vera* (WHO, 1999). These and other *A. vera* preparations contain aloin, polysaccharides, monosaccharides, organic acids, and other minor compounds (WHO, 1999). There are a few reports of Aloe preparations inducing elevations in hepatic enzymes (Yang *et al.*, 2010). On the other hand, in kidney disorders, excessive doses could theoretically cause nephritis (Maschio, 2006). The correct individual dose (posology) is the smallest amount required to produce the desirable physiological effect, not overcoming the higher doses recommended of 10-30 mg aloin per day (WHO, 1999). Some countries have established control tests. For example, the risk assessment of the *A. vera* plant for food supplements is listed in the document “Drogelisten” (Gry *et al.*, 1998). “Drogelisten” is a list of risk assessments performed by the Danish Food Institute. The maximum dosage of Aloin permitted in Denmark is 16.7 ppm in gel form, or 0.1 ppm in food and beverages. On the other hand, the EEC Council Directive 88/388 fixed their maximum allowable concentration values for aloin in food and beverages (0.1 ppm) and in alcoholic drinks (50 ppm). This indicates that it is necessary to establish control measures

for the *A. vera* plant's active substances, as much for the plant itself as for the numerous preparations that are currently available on the market. It's with this perspective that we have endeavored to undertake the project of reviewing the analytical methods that are currently applicable, as well as developing a new analytical method based on the size-exclusion chromatography technique (SE-HPLC).

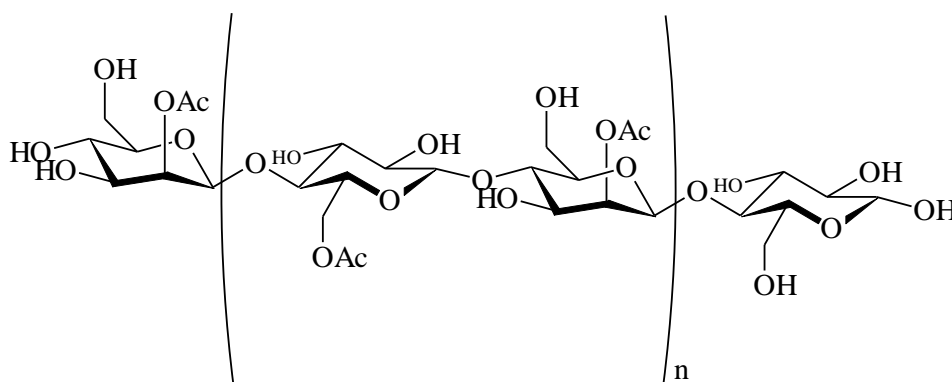
### Materials and Methods

Sodium azide, Aloe-emodin and barbaloin were supplied by Sigma-Aldrich (Biosigma, Spain). Manapol was supplied by Carrington Laboratories (USA). HPLC grade water was supplied by Scharlau (Melcan, Spain) and was used to prepare samples, standards, and eluents. To samples/standard solutions, sodium azide was added (0.5% w/v). A column was then installed to perform size exclusion chromatography (SEC), specifically, the Shodex OHpak SB-806 HQ, in a UHPLC VWR-Hitachi, Elite La Chrom model, equipped with a pump, an automatic injector, a refraction index detector (IR, T = 35 °C) and an ultraviolet detector (UV,  $\lambda = 355 \text{ nm}$ ). The fresh *A. vera* leaves were then collected from Mr. Antonio del Rosario's farm (in Arinaga, Gran Canaria, Spain). Once their skin was removed, their flesh was put into a blender and diluted with water (1:1), then filtered with membrane filters of 0.80 - 1.2  $\mu\text{m}$  (Sartorius stedim biotech, Minisart model). The resulting viscous liquid [0.5 x (juice + gel)] was injected directly into the chromatograph. An authentic sample of *Aloe vera* mucilaginous polysaccharide (AVMP) in its Manapol version, was used as a model to deduce the calibration curves for the three fractions of the same, corresponding to three median molecular sizes ( $t_r = 7.7, 11.2$  y  $11.3$  minutes) (Table 1). To prepare the AVMP dissolution model at 0,2%, we weighed 20,0 mg of Manapol and dissolved it in 10 mL of water (with sodium azide, 0.5 % w/v). For the dilution, successive dissolution models were prepared. The dissolution models were injected in triplicate. Other models (mannose, glucose, ascorbic acid, guar, Aloe-emodin and barbaloin) were prepared at the initial concentration level of 2.0  $\text{mg}\cdot\text{mL}^{-1}$ .

### Results and Discussion

*Aloe vera* mucilaginous polysaccharide (AVMP) is the component that creates the characteristic viscosity of the "Aloe vera Gel" that's freshly extracted from the fresh plant, which presents a concentration that fluctuates around 5000 ppm. This initial concentration of AVMP falls quickly because of a process of depolymerization, due to the acidic condition of the gel (Toledo Marante, 2003). Since the AVMP is an active ingredient that's very important in the composition of the gel (Song *et al.*, 2001), its rapid decomposition creates the so-called "stabilization problem" (Yaron, 1991, 1993; Yaron *et al.*, 1992; Toledo-Marante, 2003). Numerous American researchers have proposed a method for measuring the quality of products derived from the *A. Vera* plant (Pelley *et al.*, 1993). They consist of comparing the product to a "standard". That *Standard A. vera*, was proposed according to the recommendations of the International Aloe Science Council (IASC). As soon as this procedure was adopted, it became possible to confirm suspicions that the quality of *A. vera* is frequently manipulated. AVMP, in reality, is not a unique polysaccharide, but is rather a mixture of them (Gowda *et al.*, 1979; Madis *et al.*, 1989; Yaron, 1991, 1993; Yaron *et al.*, 1992; Lee *et al.*, 1997; Song *et al.*, 2001). In said mixture, multiple elements were identified such as glucomannans, acemannan, and others. These compounds differ in their glucose-to-mannose ratios and acetyl contents. The structure of acemannan (Figure 1) consists of a long chain of polydispersed  $\beta$ -(1  $\rightarrow$  4) linked mannan polymers. The sugar and acetyl group in the molecule were linked by molar ratio of 3:1 (Lee *et al.*, 1997).





I

Figure 1.- Acemannan

A spectrophotometric analytical method for the determination of total polysaccharides was described (Eberendu and McAnalley, 1994; Leyes *et al.*, 2000). A quantitative method using size exclusion chromatography (SEC) analysis was performed to determine the concentration of AVMP in *A. vera* extracts (Toledo-Marante, 2011). Nuclear magnetic resonance spectroscopy ( $^1\text{H-NMR}$ ) was applied to secure the quality and the presence of natural components, e.g., acemannan in commercial *A. vera* products (Diehl and Teichmuller, 1998). This analytical technique is so powerful that it permits us to identify and majorly natural products present, as well as diverse chemical compounds that are produced and present, and accumulate through enzymatic and microbial degradation during the post-harvest period (Table 3). Other artificial additives can also be identified and analyzed, having usually been added as preservatives (benzoic acid sodium salt, sorbic acid potassium salt), antioxidants (ascorbic acid), acidulents (citric acid) or thickeners (maltodextrin, glycerine) (Bozzi *et al.*, 2007; Toledo-Marante, 2010).

On the other hand, the different mono- and di-saccharides that are present in their free form in the plant, or those that result from the depolymerization of the polysaccharides can be analyzed by high performance anion exchange chromatography with pulsed amperometric detection (HPAE-PAD) (Bozzi *et al.*, 2007).

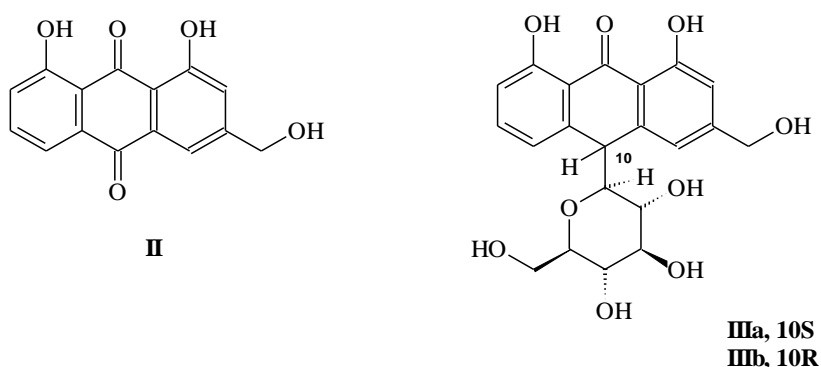


Figure 2.- Aloe-emodin (II), barbaloin (IIIa) and isobarbaloin (IIIb)

Aloin is composed, as its major and active principles, by Aloeemodin (II,  $2 \times 10^{-3}$  % w/w) and barbaloin/ isobarbaloin (IIIa + IIIb,  $44 \times 10^{-3}$  % w/w). These polyphenols are laxative/ cathartic compounds (Ishii *et al.*, 1998; Murray, 2013) and are quite stable in their solid

phases (Reynolds, 1994); Nevertheless, they undergo rapid decomposition when in solution (Zonta *et al.*, 1995).

Thin-layer chromatography and microchemical analyses are employed for the qualitative analysis for the presence of these phenols, and quantitative analysis of total anthracene glycosides, calculated as barbaloin, is performed by spectrophotometry (WHO, 1999); this can also be analysed by reversed-phase high-performance liquid chromatography (RP-HPLC) and similar techniques (Zonta *et al.*, 1995; Bozzi *et al.*, 2007).

With the objective of reducing the number of instruments used to analyze *A. vera*, we applied the High-Performance Liquid Chromatography (HPLC) with columns of the “Size Exclusion Chromatography” (SEC) type. Those columns separated the analytes from the sample depending on their molecular size. Yet, within the column, the analytes suffered from intermolecular forces in their stationary phase. This is why we consider that by using two aligned detectors, one that’s UV-visible and the other a refraction index (IR), we could separate, with a single chromatographic analysis, that is, with a single injection, the different fractions of the AVMP as well as the different components that make up the aloin. For this, an OHPak SB-806 HQ Shodex column was installed in a VWR-Hitachi, Elite La Chrom liquid chromatograph, equipped with an automatic injector, a refraction index detector (IR) and a UV detector. The analytical method was easy to calibrate thanks to commercial models or patterns (Table 1), and even the x axis of the resulting chromatogram ( $t_r < 12$  minutes) could inform us regarding the molecular size of each AVMP fraction. To calibrate said x axis, there are various gel permeation chromatography standards that exist on the market. The obtained analytical results are indicated in Table 2.

Table 1. Analytical data of the method applied (HPLC-UV/IR)

Compound	*Tr (minutes)	Calibration equation	Detector used
AVMP, fraction A (n=n <sub>1</sub> )	7.7	$C \text{ (ppm)} = 2.3287 \times 10^{-3} \times A - 11.0760$ (R <sup>2</sup> =0.9997)	IR
AVMP, fraction B (n=n <sub>2</sub> )	9.9	$C \text{ (ppm)} = 2.3348 \times 10^{-3} \times A - 7.5463$ (R <sup>2</sup> =0.9998)	IR
AVMP, fraction C (n=n <sub>3</sub> )	11.2	$C \text{ (ppm)} = 2.4906 \times 10^{-3} \times A - 28.4463$ (R <sup>2</sup> =0.9930)	IR
Monosaccharides (Man + Glc + ...)	11.5	**C (ppm) = $1.3904 \times 10^{-3} \times A + 2.3326$ (R <sup>2</sup> =0.9998)	IR
Aloe-emodin (II)	14.8	$C \text{ (ppm)} = 2.2651 \times 10^{-5} \times A + 4.7377$ (R <sup>2</sup> =0.9969)	UV
Barbaloin (IIIa) + Isobarbaloin (IIIb)	19.1	$C \text{ (ppm)} = 2.2140 \times 10^{-5} \times A + 5.7822$ (R <sup>2</sup> =0.9996)	UV

\*The retention times of fractions A/B/C of AVMP can fluctuate with the n value.

\*\*Calibration equation for mannose.

Table 2. Concentrations (ppm±sd) obtained for major analyzed compounds (HPLC-IR/UV)

Month	AVMP, fraction A (I, n=n <sub>1</sub> )	AVMP, fraction B (I, n=n <sub>2</sub> )	AVMP, fraction C (I, n=n <sub>3</sub> )	*Monosaccharides (Man + Glc +...)	Aloe-emodin (II)	Barbaloin (IIIa) + Isobarbaloin (IIIb)
Jan	188±9	1267±10	880±50	20100±1200	21±14	420±14
Feb	173±9	1347±11	1540±70	20900±1300	14±15	352±14
Mar	133±9	1146±10	20400±700	28400±1700	19±15	446±15
Apr	359±10	1406±11	10600±400	27400±1700	13±14	295±14
May	73±8	205±4	660±40	4300±300	23±15	107±12
Jun	28±8	123±4	880±50	7100±400	18±15	425±15
Jul	325±10	799±4	2500±100	26600±1600	27±15	591±16
Aug	272±9	387±5	3390±140	23200±1400	38±15	536±15
Sep	200±13	218±13	3000±120	24600±1500	6±7	218±13
Oct	789±13	2520±17	2590±110	24700±1500	36±15	740±17
Nov	143±9	675±7	3360±130	20200±1200	29±15	494±15
Dec	111±8	962±8	2830±120	18500±1100	28±15	665±16

\*Expressed in ppm of mannose.

Table 3. Analytes that appear during the post-harvest period, and their analysis.

Compound	Analytical method
Monosaccharides	HPLC, RP-HPLC, HPAE-PAD and <sup>1</sup> H-NMR δ 5,22 (1H); δ 3,79 – 3,20 (6H)
Acetic acid	<sup>1</sup> H-NMR δ 1,90
Pyruvic acid	<sup>1</sup> H-NMR δ 2,49
Lactic acid	<sup>1</sup> H-NMR δ 1,45 (3H); 4,40 (1H)
Fumaric acid	<sup>1</sup> H-NMR δ 6,80
Succinic acid	<sup>1</sup> H-NMR δ 2,67
Formic acid	<sup>1</sup> H-NMR δ 8,42

### Conclusion

*Aloe vera* produces a juice (latex+gel) that's composed of three fractions of mucopolysaccharides (I) of different molecular sizes, and two aloin fractions, constituted by aloemodin (II), barbaloin (IIIa)/ and isobarbaloin (IIIb) compounds. An HPLC–UV/IR method was set up to verify the presence of both fractions (AVMP and aloin). It has the necessary specificity, precision, accuracy, and linearity to resolve the major industrial problems. Fresh *Aloe vera* leaves were collected monthly and analyzed. The concentration of AVMP fluctuated throughout the year and yielded an annual average of 5500 ± 700 ppm, whereas the aloin fluctuated during the same period yielding an average value of 464 ± 17 ppm.

### References

- Bozzi A., Perrin C., Austin S., Vera F.A. (2007). Quality and authenticity of commercial Aloe Vera gel powders. Food Chemistry, Vol. 103, pp. 22-30.
- Diehl B. and Teichmuller E.E. (1998). Aloe vera, quality inspection and identification. Agro Food Industry Hi-Tech, Vol. 9 (No. 1), pp. 14-16.
- Eberendu A.N.R. and McAnalley B.H. (1994). Colorimetric assay for bioactive polysaccharide. Patent US5512488. Carrington Laboratories, Inc.

- Gowda D.C., Neelisiddaiah B., Aujaneyalu Y.V. (1979). Structural studies of polysaccharides from Aloe vera. *Carbohydrate Research*, Vol. 72, pp. 201-205.
- Gry J., Hallas-Møller T., Pedersen E., Pilegaard K., Strubeattached M. (1998). *Drogelisten*. Danish Food Institute.
- Ishii Y., Takino Y., Toyo'oka T., Tanizawa H. (1998). Studies of Aloe. VI. Cathartic effect of isobarbaloin. *Biological & Pharmaceutical Bulletin* Vol. 21 (No. 11), pp. 1226-1227. DOI:10.1248/bpb.21.1226.
- Lee S.Y., Ryu L.W., Shim C.S. (1997). Purification and characterization of bioactive compound acemannan from Aloe Vera. *Saengyak Hakhoechi*, Vol. 28 (No. 2), pp. 65-71.
- Leyes E.A.R., Chanfrau J.E.R., Ruiz Z.P., Pavon V. (2000). Determination of total polysaccharides in liquid gel from Aloe vera L. used for the formulation of dietetic products. *Alimentaria (Madrid)*, Vol. 313, pp. 79-81.
- Madis V.H., Omar M.M., Madis V. (1989). Aloeferon isolation, manufacture, and applications. Patent US 4861761. Madis Dr. Laboratories Inc.
- Maschio G. (2006) Le erbe medicinali una trappola per il rene (Medicinal plants, a trap for kidneys). *Rene & Salute*. No. 1 (April).
- Murray M.T. (2013). Aloe vera (Cape Aloe). In: Pizzorno J.E. and Murray M.T. (Eds). *Textbook of Natural Medicine*. 4th edition. Elsevier, pp. 578.
- Pelley R.P., Wang Y.T., T.A. Waller T.A. (1993). Current status of quality control of Aloe barbadensis extracts. *Seifen Oele Fette Wachse (SOFW Journal)*, Vol. 119, pp. 255–260.
- Reynolds T. (1994). A chromatographic examination of some old samples of drug Aloes. *Pharmazie*, Vol. 49 (No. 7), pp. 524-529.
- Song Y., Li Y., Qin H., Wan Y. (2001). Isolation and identification of neutral polysaccharide from Aloe vera. *Zhongcaoyao*, Vol. 32 (No. 6), pp. 491-493.
- Toledo-Marante F.J. (2003). Los polisacáridos mucilaginosos de Aloe vera (AVMP): estabilidad [Aloe vera mucilaginous polysaccharides (AVMP): stability]. Technical Report. Universidad de Las Palmas de Gran Canaria. DOI: 10.13140/RG.2.2.18915.14881
- Toledo-Marante F.J. (2010). Informe sobre la utilización de Resonancia Magnética Nuclear (RMN) en el estudio de los Polisacáridos Mucilaginosos de Aloe vera (AVMP) [Report on the use of Nuclear Magnetic Resonance (NMR) to the study of Aloe vera mucilaginous polysaccharides (AVMP)]. Technical Report. Universidad de Las Palmas de Gran Canaria. DOI: 10.13140/RG.2.2.20592.87049.
- Toledo-Marante F.J. (2011). Informe sobre la utilización de Cromatografía Líquida de Alta Eficacia (HPLC) en el estudio de los Polisacáridos Mucilaginosos de Aloe vera (AVMP) [Report on the use of High Performance Liquid Chromatography (HPLC) to the study of Aloe vera mucilaginous polysaccharides (AVMP)]. Technical Report. Universidad de Las Palmas de Gran Canaria. DOI: 10.13140/RG.2.2.12204.26243.
- WHO (1999). *World Health Organization Monographs on Selected Medicinal Plants*, Vol. 1, pp. 33 (Aloe). Geneva. ISBN: 9241545178.
- Yang H.N., Kim D.J., Kim Y.M., Kim B.H., Sohn K.M., Choi M.J., Choi Y.H. (2010). Aloe-induced toxic hepatitis. *Journal of Korean Medical Science*, Vol. 25 (No. 3), pp. 492-495.
- Yaron A. (1991). Aloe vera: chemical and physical properties and stabilization. *Israel Journal of Botany*, Vol. 40 (No. 3), pp. 270.
- Yaron A., Cohen E., Arad S.M. (1992). Stabilization of Aloe vera gel by interaction with sulphated polysaccharides from red microalgae and with xanthan gum. *Journal of*

- Agricultural and Food Chemistry, Vol. 40 (No. 8), pp. 1316-1320.  
DOI: 10.1021/jf00020a004.
- Yaron A. (1993). Characterization of Aloe vera gel before and after auto degradation, and stabilization of the natural fresh gel. *Phytotherapy Research*, Vol. 7, pp. S11-S13.  
DOI:10.1002/ptr.2650070706.
- Zonta F., Bogoni P., Masotti P., Micali G. (1995). High-performance liquid chromatographic profiles of Aloe constituents and determination of aloin in beverages, with reference to the EEC regulation for flavoring substances. *Journal of Chromatography A*, Vol. 718 (No. 1), pp. 99-106. DOI: 10.1016/0021-9673(95)00637-0.

## EXPERIMENTAL MANUFACTURING OF KOURDASS, A TRADITIONAL SALTED DRIED MEAT PRODUCT

Sanâa CHERROUD<sup>1</sup>, Abdelhay ARAKRAK<sup>1</sup>, Maryam BENBACHIR<sup>2</sup>, Mohammed BAKKALI<sup>1</sup>, Amin LAGLAOUI<sup>1</sup>, Sidonia MARTÍNEZ<sup>3</sup>, Lucía GÓMEZ-LIMIA<sup>3</sup>, Inmaculada FRANCO<sup>3</sup>, Noemi COBAS<sup>3\*</sup>

<sup>1</sup>Research team in biotechnology and engineering of biomolecules (ERBGB), Faculty of Sciences and Technics of Tangier BP 416. University of Abdel Malek Essaâdi, Morocco

<sup>2</sup>Laboratory of Biochemistry and Neurosciences - FSTT of Settat, Morocco

<sup>3</sup>Food Technology, Faculty of Sciences, University Campus As Lagoas s/n, 32004 Ourense, University of Vigo, Spain

\*Corresponding author: ncobas@uvigo.es

### Abstract

Among the most commonly consumed meat in the Morocco, lamb meat plays an important role as both a fresh or like a processed product. Kourdass is a traditional meat product made with lamb intestines, liver, lung and fat. The meat is sliced, salted, spiced and coated in the rumen before exposed to the sun for drying. Currently, a lot of works show the quality of several dried meat products through the studying of different parameters, such as the amine content. These compounds are produced naturally by animal, plant and microorganism metabolism. Furthermore, there are not enough data about kourdass. The aim of this work was to study changes in the content of biogenic amines during the ripening of kourdass. Trials of kourdass-making were carried out in a laboratory with a traditional procedure. Batches of six kilograms, each containing fresh sheep meat, were purchased directly from a slaughterhouse. The batches were sampled at different times to follow up the modifications in the amine contents. During ripening, the total amine content increased significantly ( $P < 0.05$ ). The results indicated that spermine and tyramine were the most abundant biogenic amines in the fresh meat. Together with tryptamine, these compounds make up the majority at the end of the manufacturing process. Histamine and agmatine levels remained very low throughout repining, and exhibited no quantitatively relevant changes. Total content of biogenic amines was 101.72 mg/kg. It is low in comparison with other meat products. In conclusion biogenic amines quantification indicates the hygienic quality of manufacturing processes.

**Key words:** *Lamb meat, Biogenic amines, Kourdass, Food quality.*

### Introduction

It is well known that the North African countries have an important and ancient tradition in food technology. And although the diet in these countries is typically Mediterranean (Benkerroum, 2013; Alexandratos, 2006; Padilla *et al.*, 2005), it is very influenced by religion. The halal food market has grown strongly over recent decades (ITC, 2015). But the relation between halal product, with respect to slaughter ritual, and the economic difficulties to some small producers, makes doubt about the quality and safety of this kind of food. Traditional meat products represent an important group among Halal products. They are characterized by handmade manufacturing usually in small-scale units, following spontaneous fermentation by their particular microbiota. Salting, sun-drying and using spices and herbs were added to these traditional meat products, initially to provide flavour and aroma. But they also contribute to the improvement of food safety and keeping quality (Benkerroum, 2013).

One of them is the Kourdass. It is a traditional meat product made in Morocco. The biochemical and microbiological phenomena that take place throughout the manufacturing process are responsible for the organoleptic quality of the final product. The lack of knowledge about these changes, the heterogeneity of the product and the questionable quality of some units prevent its diffusion to wider markets. Biogenic amines are basic nitrogen compounds usually formed by decarboxylation of free amino acids. Elevated concentrations of biogenic amines must be avoided, not only because of the unfavourable effects on flavor. They are dangerous for human health. Biogenic amines affect blood pressure, and excessive quantities in food can trigger migraines, gastric and intestinal problems and allergic responses in sensitive people (Stratton *et al.*, 1991; Taylor, 1985; Smith, 1981). During ripening of meat products, the proteins undergo degradation processes. Large peptides are first generated and then degraded into oligopeptides, and these are in turn degraded to free amino acids. And these last degradation products are then catabolised, giving rise to different compounds such as ammonia,  $\alpha$ -ketoacids, methylketones and amines. In meat products, formation of biogenic amines is largely associated with the activity of microorganisms present in meat (Paulsen and Bauer, 1997; Shalaby, 1996). In raw-cured sausages, microorganisms of the *Enterobacteriaceae* family have been revealed to have a high capacity for producing biogenic amines, particularly putrescine and cadaverine (Bover-Cid *et al.*, 2001; Silla Santos, 1998). Ripening of sausages provides conditions that are very favourable for the production of biogenic amines, due to the active growth of microbial populations, acidification and proteolysis. Different measures have been taken with the aim of preventing or minimizing formation of biogenic amines during the manufacture of raw-cured sausages, such as improved hygiene in production plants, the use of starter cultures formed by lactic acid bacteria with acidifying capacity, and the use of certain preservatives (Bover-Cid *et al.*, 2001). Although such practices usually reduce the production of biogenic amines, they do not totally prevent the production, and moreover, the increased proteolysis that results from the use of starter cultures may actually increase the availability of amino acids precursors. Complete inhibition of biogenic amine formation during production of sausages, without any adverse effects, is desirable. However, production of biogenic amines is an extremely complex phenomenon that depends on several variables such as the growth kinetics of the microorganisms and their proteolytic and decarboxylase activities. In order to design strategies for specific inhibition of the production of these compounds, it is essential to obtain information about the potential production of biogenic amines by the microorganisms present in fermented meat products and about the growth phase during which maximum production takes place. This work forms part of a wider study of both the microbiological and biochemical processes that occur during the manufacture of kourdass. And the main objective of the present paper was to obtain information about the changes in biogenic amine content during the manufacturing process.

## **Materials and methods**

### **Samples**

Fresh sheep loins and rib meat were purchased from the slaughterhouse of Tangier (Morocco). A total of 6 kg of meat was used in the elaboration of two batches of kourdass. All meat was allowed to mature for 24 h at room temperature (around 25°C). After this time, the meat was cut into small pieces, were salted and spiced with garlic, pepper, paprika, coriander and cumin. Finally, it was allowed to macerate for 24 h. Firstly The seasoned meat was, wrapped with the rumen and then were sealed with the intestine. Each roll was sun-dried for 20 days. All the determinations were performed within 20 days of drying.

In each batch, samples were taken before beginning of the ripening process and after 2, 4, 8, 12, 16 and 20 days of sun-ripening. Each sample consisted of one whole kourdass piece. Once in the laboratory, outer casing was removed and the rest of the meat product was minced.

#### Biogenic amines determination

Separation, identification and quantification of the biogenic amines were carried out by HPLC, following the procedure described by Eerola et al. (1993), with a Spectra System chromatograph (Thermo Finnigan, San José, CA, USA) equipped with a SCM 1000 degasser, a P4000 pump, an AS 3000 automatic injector and a Photodiode Array UV6000LP detector. Separation of the different biogenic amines was carried out on a reverse phase C18 mod Kromasil 100 column (25 cm, 4 mm ID) (Teknokroma S. Coop. C. Ltda., San Cugat del Vallés, Barcelona, Spain). The temperature of the column was  $40 \pm 1$  °C and the wavelength of the detector 254 nm. The chromatographic conditions used are described in Table 1; a solution of 0.1 M ammonium acetate was used as eluent A, and acetonitrile as eluent B.

Table 1. Chromatographic conditions used in the determination of the biogenic amines.

Time (min)	Flow (mL/min)	% Eluent A	% Eluent B
0	1.00	50	50
19.00	1.00	10	90
20.00	1.00	50	50
30.00	1.00	50	50

A standard solution containing appropriate amounts of agmatine, tryptamine, 2-phenylethylamine, putrescine, cadaverine, histamine, tyramine, spermidine, spermine and 1,7-diaminoheptane (as internal standard) was used to quantify the biogenic amines present in the samples.

All the samples and standards were injected at least in duplicate in different days. Repeatability tests were performed by injecting a standard and a sample consecutively six times in a day. Reproducibility tests were also carried out by injecting the standard and the sample twice a day for three days, under the same experimental conditions. There were no significant differences ( $P < 0.05$ ) in the results obtained in these tests.

Samples were analysed in triplicate and the results were expressed as an average value in mg/kg. All statistical analyses were performed using the Statistica 5.1 computer program for Windows (Statsoft Inc, Tulsa, OK, USA). Significant differences between samples were determined using an analysis of variance (ANOVA) followed by Fisher's least-significant difference (LSD) test.

#### Results and discussion

The changes in the content of biogenic amines during manufacture of kourdass are shown in Table 2. The main biogenic amines in the fresh pieces were spermine, followed by tyramine and tryptamine. The average total biogenic amines content increased significantly ( $P < 0.05$ ) from  $28,0 \pm 3,53$  mg/kg in the fresh pieces to  $101,7 \pm 10,2$  mg/kg at the end of the sun-drying stage. In general, the accumulation of biogenic amines at the end of the ripening was low. The content of each biogenic amine showed great variability at each sampling time. And the total amine concentration (101.7 mg/kg) was lower than other meat products evaluated for different authors. For example, Dos Santos *et al.* (2015) studied some Italian-type salami brands sold in Niteroi (Brazil) and they found total levels over 303 mg/kg.



Tyramine and spermine were the main biogenic amines in all samples. This result coincides with the profile of amines reported by Trevino *et al.* (1997) in cervelat sausage, but with a lot differences about their contents. Tyramine is one of the most relevant vasoactive amines present in food (Paulsen *et al.*, 2012). In kourdass, it increased during the sun-drying. Although, the concentration after 20 days of sun-drying were 30.5 mg/kg. And it is lower than contents of Spanish sausages, such as “chorizo” (76.5-477.8 mg/kg) and “salchichón” (67.5-465.2 mg/kg) (Hernández-Jover *et al.*, 1997).

The sum of vasoactive biogenic amines (VBA) is considered as a good indicator of practical and high-quality handling in the preparation of meat products. The limit of VBA is considered 200 mg/kg (Eerola *et al.*, 1998). In the case of our study, no samples exceeded this limit and the final product showed values around 60.6 mg/kg.

Table 2. Changes in biogenic amine content (expressed as mg/kg) during the sun-drying process of kourdass (average values  $\pm$  standard deviation).

Biogenic Amines	0	2	4	8	12	16	20
Tryptamine	6.18 $\pm$ 1.31 <sup>a</sup>	8.70 $\pm$ 0.52 <sup>a</sup>	11.5 $\pm$ 0.98 <sup>b</sup>	14.7 $\pm$ 0.82 <sup>c</sup>	17.4 $\pm$ 1.22 <sup>d</sup>	20.6 $\pm$ 0.87 <sup>e</sup>	23.6 $\pm$ 0.89 <sup>f</sup>
Phenylethylamine	0.69 $\pm$ 0.12 <sup>a</sup>	1.11 $\pm$ 0.51 <sup>ab</sup>	1.79 $\pm$ 0.23 <sup>b</sup>	2.91 $\pm$ 0.54 <sup>c</sup>	3.86 $\pm$ 0.33 <sup>d</sup>	4.59 $\pm$ 0.42 <sup>d</sup>	5.63 $\pm$ 0.45 <sup>e</sup>
Putrescine	0.21 $\pm$ 0.18 <sup>a</sup>	0.40 $\pm$ 0.15 <sup>a</sup>	0.77 $\pm$ 0.19 <sup>b</sup>	1.21 $\pm$ 0.27 <sup>c</sup>	1.78 $\pm$ 0.42 <sup>c</sup>	2.51 $\pm$ 0.19 <sup>d</sup>	2.58 $\pm$ 0.22 <sup>d</sup>
Cadaverine	0.43 $\pm$ 0.25 <sup>a</sup>	1.28 $\pm$ 0.23 <sup>b</sup>	1.87 $\pm$ 0.43 <sup>b</sup>	2.48 $\pm$ 0.42 <sup>c</sup>	3.52 $\pm$ 0.19 <sup>d</sup>	4.29 $\pm$ 0.19 <sup>e</sup>	5.65 $\pm$ 1.00 <sup>f</sup>
Histamine	ND	0.22 $\pm$ 0.11 <sup>a</sup>	0.26 $\pm$ 0.07 <sup>a</sup>	0.52 $\pm$ 0.18 <sup>b</sup>	0.61 $\pm$ 0.15 <sup>bc</sup>	0.73 $\pm$ 0.1 <sup>c</sup>	0.90 $\pm$ 0.06 <sup>d</sup>
Agmatine	ND	ND	ND	ND	0.35 $\pm$ 0.14 <sup>a</sup>	0.39 $\pm$ 0.17 <sup>a</sup>	0.28 $\pm$ 0.15 <sup>a</sup>
Tyramine	8.23 $\pm$ 1.62 <sup>a</sup>	13.8 $\pm$ 0.82 <sup>b</sup>	16.8 $\pm$ 1.04 <sup>c</sup>	20.2 $\pm$ 1.16 <sup>d</sup>	23.8 $\pm$ 1.07 <sup>e</sup>	27.3 $\pm$ 1.14 <sup>f</sup>	30.5 $\pm$ 0.97 <sup>g</sup>
Spermidine	1.44 $\pm$ 0.26 <sup>a</sup>	2.07 $\pm$ 0.31 <sup>ab</sup>	2.67 $\pm$ 0.45 <sup>b</sup>	3.54 $\pm$ 0.27 <sup>c</sup>	5.06 $\pm$ 0.37 <sup>d</sup>	6.00 $\pm$ 0.91 <sup>de</sup>	6.94 $\pm$ 0.18 <sup>e</sup>
Spermine	10.8 $\pm$ 0.51 <sup>a</sup>	15.9 $\pm$ 1.16 <sup>b</sup>	17.8 $\pm$ 0.50 <sup>b</sup>	19.9 $\pm$ 1.22 <sup>cd</sup>	20.9 $\pm$ 2.29 <sup>d</sup>	23.1 $\pm$ 0.60 <sup>e</sup>	25.6 $\pm$ 0.88 <sup>e</sup>
Total	28.0 $\pm$ 3.53 <sup>a</sup>	43.6 $\pm$ 5.33 <sup>b</sup>	53.5 $\pm$ 6.29 <sup>c</sup>	65.5 $\pm$ 7.34 <sup>dc</sup>	77.4 $\pm$ 8.09 <sup>de</sup>	89.5 $\pm$ 9.15 <sup>ef</sup>	101.7 $\pm$ 10.2 <sup>f</sup>
VBA	15.1 $\pm$ 3.05 <sup>a</sup>	23.8 $\pm$ 1.96 <sup>b</sup>	30.3 $\pm$ 2.32 <sup>c</sup>	38.3 $\pm$ 2.7 <sup>d</sup>	45.7 $\pm$ 2.77 <sup>e</sup>	53.2 $\pm$ 2.43 <sup>f</sup>	60.6 $\pm$ 2.37 <sup>g</sup>

a–g Values in the same row (corresponding to the same parameters) not followed by a common letter differ significantly ( $P < 0.05$ ); ND: No Detected; VBA: Sum of tyramine, histamine, tryptamine, and 2-phenylethylamine

Spermine appears naturally in fresh meat (Lorenzo *et al.*, 2007). It is the second more concentrated in Kourdass (25.62 mg/kg). This result was in accordance with the reported by Eerola *et al.* (1998) in finish dry sausages (19-48 mg/kg).

Histamine and agmatine were not detected at the first sampling point. Agmatine not was found until 12 days of ripening, with final content around 0.28 mg/kg. While, histamine was detected after two days of sun-drying. Although, its content was not raised too much in the final product (0.90 mg/kg). Histamine is toxic when large doses enter the circulatory system (FAO/WHO, 2013). Nevertheless, there is no regulation on the limit content of histamine.

Cadaverine and putrescine are two other biogenic amines found in fermented meat products. Lorenzo *et al.* (2008) found important concentrations of putrescine and cadaverine in Spanish traditional sausages, such as “androlla” (215.4 mg/kg and 232.4 mg/kg, respectively). Their results were significant higher than the contents obtained in kourdass. On the other hand, the cadaverine content is similar to the range values reported for Hernández-Jover *et al.* (1997) in “chorizo” (3.9-34.9 mg/kg) and for Shalaby (1993) in Egyptian dry sausages (5.6-38.5

mg/kg). Putrescine contents, showed by these authors, were higher than the results in kourdass.

### **Conclusion**

Meat sausages, free of biogenic amines and without any adverse effects, are desirable. However, the synthesis phenomenon of these compounds involves several variables difficult to control. In order to design strategies for specific inhibition of the production of amines, it is essential to obtain information about the presence of these compounds in fermented meat products and about the ripening phase during which maximum production takes place. In all case, the amine content in kourdass is lower than values reported for a more meat products with a high consumption. These results indicate that kourdass, made with ribs and loins of lamb, meets the safety and quality requirements demanded by the consumer.

### **References**

- Alexandratos N. (2006). The Mediterranean diet in a world context. *Public Health Nutrition* 9, 111–7
- Benkerroum, N. (2013). Traditional fermented foods of North African countries: technology and food safety challenges with regard to microbiological risks. *Comprehensive Reviews in Food Science and Food Safety* 12, 54-89.
- Bover-Cid S., Izquierdo-Pulido M., Vidal-Carou M.C. (2001). Changes in biogenic amine and polyamine contents in slightly fermented sausages manufactured with and without sugar. *Meat Science* 57, 215-221.
- Dos Santos L.F.L., Mársico E.T., Lázaro C.A., Teixeira R., Doro L., Júnior C.A.C. (2015). Evaluation of biogenic amines levels, and biochemical and microbiological characterization of Italian-type salami sold in Rio de Janeiro, Brazil. *Italian Journal of Food Safety* 4, 137-141.
- Eerola S., Hinkkanen R., Lindfors E., Hirvi T. (1993). Liquid chromatographic determination of biogenic amines in dry sausages. *Journal-AOAC International*, 76, 575-575.
- Eerola H.S., Sagués A.R., Hirvi T.K. (1998). Biogenic amines in Finnish dry sausages. *Journal of Food Safety* 18, 127-138.
- FAO/WHO (2013). Public Health Risks of Histamine and other Biogenic Amines from Fish and Fishery Products. Meeting report. Food and Agriculture Organization of the United Nations/World Health Organization, Rome.
- Hernández-Jover T.H., Izquierdo-Pulido M., Veciana-Nogués M.T., Mariné-Font A., Vidal-Carou M.C. (1997). Effect of starter cultures on biogenic amine formation during fermented sausage production. *Journal of Food Protection* 60, 825-830.
- International Trade Centre (2015). From niche to mainstream – Halal Goes Global. International Trade Centre (ITC) XIV, Geneva.
- Lorenzo J.M., Martínez S., Franco I., Carballo J. (2007). Biogenic amine content during the manufacture of dry-cured lacón, a Spanish traditional meat product: Effect of some additives. *Meat Science* 77, 287-293.
- Lorenzo J.M., Martinez S., Franco I., Carballo J. (2008). Biogenic amine content in relation to physico-chemical parameters and microbial counts in two kinds of Spanish traditional sausages. *Archiv für Lebensmittelhygiene* 59, 70-75.
- Padilla M, Sid-Ahmad Z, Wassef HH (2005). Consumption and food security in the Mediterranean. In: Hervieu B, Allaya M, editors. *Agri-Med: agriculture, fishery, food and sustainable rural development in the Mediterranean region*. CIHEAM. Paris (France). Annual Report N° 7, Section III. p 226-80.

- Paulsen P., Bauer F. (1997). Biogenic amines in fermented sausages, II: Factors influencing the formation of biogenic amines in raw fermented sausage. *Fleischwirtschaft* 77, 362-364.
- Paulsaen P., Grossgut R., Bauer F., Rauscher-Gabernig E. (2012). Estimates of maximum tolerable levels of tyramine content in foods in Austria. *Journal of food and nutrition research* 51, 52-59.
- Shalaby A.R. (1993). Survey on biogenic amines in Egyptian foods: Sausage. *Journal of the Science of Food and Agriculture* 62, 291-293.
- Shalaby A.R. (1996). Significance of biogenic amines to food safety and human health. *Food Research International* 29, 675-690.
- Silla Santos M.H. (1998). Amino acid decarboxylase capability of microorganisms isolated in Spanish fermented meat products. *International Journal of Food Microbiology* 39, 227-230.
- Smith T.A. (1981). Amines in food. *Food Chemistry* 6, 169-200.
- Stratton J.E., Hutkins R.W., Taylor S.L. (1991). Biogenic amines in cheese and other fermented foods: a review. *Journal of Food Protection* 54, 460-470.
- Taylor S.L., World Health Organization (1985). Histamine poisoning associated with fish, cheese, and other foods. World Health Organization, Geneva.
- Trevino E., Beil D., Steinhart H. (1997). Formation of biogenic amines during the maturity process of raw meat products, for example of cervelat sausage. *Food Chemistry* 60, 521-526.

## CHEMICAL COMPOSITION OF ESSENTIAL OIL OF ANISE, CUMIN, FENNEL AND PARSLEY SEEDS

Guilles FIGUEREDO<sup>1</sup>, Fahad AL JUHAIMI<sup>2</sup>, Pierre CHALARD<sup>1</sup>, Mehmet Musa ÖZCAN<sup>3\*</sup>, Jean Claude CHALCHAT<sup>4</sup>

<sup>1</sup>Lexva Analytical 460 street of Montant 63110 Beaumont, France

<sup>2</sup>Department of Food Science & Nutrition, College of Food and Agricultural Sciences, King Saud University, Riyadh-Saudi Arabia

<sup>3</sup>Department of Food Engineering, Faculty of Agriculture, University of Selcuk, 42071 Konya, Turkey

<sup>4</sup>Laboratory of Chemistry of Essential Oils University Blaise Pascal of Clermont, Aubiere Cedex, France

\*Corresponding author: mozcan@selcuk.edu.tr

### Abstract

The essential oils of seeds of anise, cumin, fennel and parsley provided from Saudi Arabia were extracted by hydrodistillation, and analysed by GC and GC-MS. The percentage yields of the essential oils from seeds were 0.81%, 1.28%, 0.64 % and 0.52% v/w, respectively. The major constituents varied depending on species. The oil was colourless to pale-yellow in colour. More than 90% of the studied essential oils constituents were identified. It seems that there were partly similarities among chemical compositions of the four essential oils. In some of essential oils, the main constituents accounted for more than 60% of total oil, e.g., anise and fennel (E-anethole 93.00% and 62.63%, respectively). The main components were E-anethole (93.00%),  $\gamma$ -himachalene (2.85%), methyl chavicol (1.13%) and appiol (0.22%) in anise oil; E-anethole (62.63%), fenchone (13.27%), methyl chavicol (11.19%) and limonene (7.98%) in cumin oil;  $\beta$ -pinene (36.46%),  $\gamma$ -terpinene (36.29%), p-cymene (10.43%), terpinene-7-al- $\gamma$  (3.48%), sabinene (2.02%) and  $\alpha$ -pinene (1.92%) in fennel oil and  $\alpha$ -pinene (39.27%),  $\beta$ -pinene (29.61%), limonene (9.73%), myristicin (6.70%), appiol (4.75%), myrtenal (1.82%) and sabinene (1.59%) in parsley oil.

**Key words:** *spice seeds, essential oil, composition, methyl chavicol, E-anethole, anise (Pimpinella anisum), cumin (Cuminum cyminum), fennel (Foeniculum vulgare), Parsley (Petroselinum crispum Mill.)*

### Introduction

Parsley (*Petroselinum crispum* Mill.) is a biennial plant growing to 0.3-0.6 m long. It is frequently used as a garnish or as a flavoring in salads and many cooked dishes and also used for medicinal purposes (Akgül, 1993; Özcan, 2004). The dried leaves known as parsley flakes are particularly used in the instant food sector as an ingredient to flavor soups and sausages (Soysal, 2004). Fennel (*Foeniculum vulgare*) is a perennial or annual herbaceous and a typical aromatic plant that grows in several regions all over the world (Özcan et al. 2006; Özcan & Chalchat, 2006). Fennel oil is used in cooking and for correcting less pleasant odours and flavours in oral and medicinal preparations (Baytop, 1984; Akgül, 1986). Fennel has been prescribed as a muscle relaxant, a weak diuretic, carminative and a mild stimulant (Duke, 1988). There are usually considerably variations in the major components of *Foeniculum vulgare* Mill. subsp. *piperitum* (Ucria) Count fruits in north of France were reported to be limonene (52.4 and 56.9 %), piperitenone oxide (21.5 and 14.2%) and  $\gamma$ -terpinene (12.1 and 5.1 %) (Badoc et al. 1994). In previous investigation on the essential oil of *F. vulgare* subsp. *piperitum* fruits, methyl chavicol (47.09 %), limonene (29.07 %), fenchone (13.43 %) and fenchly acetate (exo) (1.95 %) were found to be the major

components (Özcan & Akgül, 2001). Many species of *Pimpinella* L. (Apiaceae) are agronomically important, particularly those with distinctive aromas and flavours. The most widely known and cultivated *Pimpinella* species is *P. anisum* (Crellin & Philpott, 1990; Tabanca et al. 2003). In addition, essential oils of some *Pimpinella* species have been used to treat sedative, antidepressant, carminative, antiseptic, diuretic, mutagenic, pectoral, tonic and stimulant properties (Ross et al. 1980; Twaij et al. 1987; Miller & Murray, 1998). Different species of *Pimpinella* can be annuals, biennials and perennials and are generally characterised by the presence of fibrous collars at the top of the root stock (Matthew, 1972).

The aim of this study was to determine the essential oil compositions of *P.anisum*, *P.crispum*, *F.vulgare* and *C.cuminum* growing in Saudi Arabia.

### Material and Methods

Plant fruits (anise, cumin, fennel (sweet) and parsley) were provided from Saudi Arabia in June 2013. The plant was identified by Dr Dural and a voucher specimen (SA1, SA2, SA3 and SA4) was deposited at the herbarium of Selçuk University, Faculty of Agriculture, Department of Food Engineering, in Konya, in Turkey. The aerial parts of anise, cumin, fennel (sweet) and parsley plant seeds were extracted by using a Clevenger type apparatus for 4 h. The obtained essential oils (0.81%, 1.28%, 0.64 % and 0.52%, respectively; v/w) were dried over anhydrous sodium sulfate, and stored at -18 °C until GC/MS analysis. The essential oil were analysed on a Agilent gas chromatograph Model 6890, equipped with a DB5 MS column (30 m X 0,25 mm, 0,25 µm), programming from 50°C (5 min) to 300°C at 5°C/ min, 5 min hold. The essential oil is diluted in hexane: 1/30. The essential oil were analysed on a Agilent gas chromatograph Model 7890, coupled to a Agilent MS model 5975, equipped with a DB5 MS column (30 m X 0.25 mm, 0.25 µm), programming from 50°C (5 min) to 300°C at 5°C/ mn, 5 min hold. Helium as carrier gas (1,0 ml/min); injection in split mode (1: 100); injector and detector temperature, 250 and 280°C respectively. The essential oil is diluted in hexane: 1/30. The components were identified by comparing linear Kovats indices (KI), their retention times (RT) and mass spectra with those obtained from the authentic samples and/or the MS library. The percentage composition of the essential oil was computed from GC peak areas without correction factors (Adams, 2001).

### Results and Discussion

The essential oils analysed by GC/MS for determination of their components and results are given in Table 1 as a relative peak area of each constituent.

Table 1. Essential oil composition of some aromatic plant seeds (%)<sup>a</sup>

RT	KI	Components	Anise	Cumin	Fennel	Parsley
5.31	925	α-thujene	-	0.74 <sup>b</sup>	- <sup>c</sup>	0.39
5.47	931	α-pinene	0.05	1.92	0.56	39.27
5.78	947	Camphene	-	-	0.09	0.29
6.25	972	Sabinene	-	2.02	0.16	1.59
6.35	976	β-pinene	-	36.46	0.11	29.61
6.58	992	Myrcene	-	2.26	0.43	0.73
6.87	1005	α-phellandrene	-	0.79	0.07	-
6.91	1011	δ-3-carene	-	0.10	-	-
7.07	1018	α-terpinene	-	0.24	-	-
7.22	1026	p-cymene	-	10.43	0.15	1.07
7.37	1030	eucalyptol	-	0.39	0.17	-
7.30	1031	Limonene	-	0.75	7.98	9.73

7.31	1032	$\beta$ -phellandrene	-	0.58	0.43	0.61
7.42	1040	Z- $\beta$ -ocimene	-	-	0.47	-
7.60	1050	E- $\beta$ -ocimene	-	-	0.03	-
7.82	1057	$\gamma$ -terpinene	-	36.29	0.17	1.23
8.28	1088	terpinolene	-	0.08	-	-
8.36	1087	fenchone	-	-	13.27	-
8.57	1100	linalool	0.27	-	-	-
9.30	1144	camphre	-	-	0.21	-
9.43	1159	pentylbenzene	-	-	-	0.10
9.45	1160	pentylcyclohexadiene	-	-	-	0.17
9.83	1174	Terpinen-4-ol	-	0.06	-	-
10.05	1193	myrtenal	-	-	-	1.82
10.08	1195	Methyl chavicol	1.13	-	11.19	-
10.09	1196	p-menth-3-en-7-al	-	0.34	-	-
10.26	1198	estragol	-	-	0.10	-
10.55	1217	Acetate de fenchyl exo	-	-	0.13	-
10.75	1239	cuminaldehyde	-	2.45	0.55	-
10.85	1251	Z-anethole	0.21	-	0.14	-
10.90	1253	Anisaldehyde	0.19	-	0.22	-
11.40	1283	E-anethole	93.00	-	62.63	-
	1287	$\alpha$ -terpinene-7-al	-	0.58	-	-
11.43	1290	$\gamma$ -Terpinene-7-al-	-	3.48	-	-
12.15	1339	$\delta$ -elemene	0.08	-	-	0.10
12.58	1380	Daucene	-	-	-	0.09
	1391	$\beta$ -elemene	0.06	-	-	-
13.11	1418	$\beta$ -caryophyllene	-	-	-	0.13
13.49	1446	Sesquisabinene B	-	-	-	0.16
13.51	1450	$\alpha$ -himachalene	0.30	-	-	-
13.86	1479	$\gamma$ -himachalene	2.85	-	-	-
13.90	1480	Germacrene-D	0.10	-	-	-
13.97	1486	$\beta$ -selinene	-	-	-	0.54
	1489	Zingiberene	0.32	-	-	-
13.99	1493	Methyl-(E)iso-eugenol	0.04	-	-	-
14.05	1494	$\alpha$ -selinene	-	-	-	0.09
14.11	1499	$\beta$ -himachalene	0.18	-	-	-
14.18	1508	$\beta$ -bisabolene	0.21	-	-	-
14.17	1509	Z- $\alpha$ -bisabolene	-	-	-	0.06
14.34	1520	Myristicin	0.08	-	-	6.70
14.61	1554	Elemicin	-	-	-	0.19
15.31	1594	Carotol	-	-	-	0.07
16.08	1681	Appiole	0.22	-	-	4.75
17.72	1823	Pseudoisoeugeyl methylbutyrate-E	2- 0.43	-	-	-
<b>Total</b>			99.70	99.95	99.26	99.48

\*nonidentified; RT: retention time; KI: Kovats indices.

<sup>a</sup>Compound listed in the order of elution from a HP-5MS column.

<sup>b</sup>Each compound is mean of two values

<sup>c</sup>non-identified

The oil yields of the seeds of anise, cumin, fennel (sweet) and parsley were 0.81%, 1.28%, 0.64 % and 0.52%, v/w, respectively. A total of 18, 19, 22 and 24 compounds which account for about 99.70%, 99.95%, 99.26 % and 99.48 % of the essential oils of anise, cumin, fennel and parsley, respectively. The oil was colourless to pale-yellow in colour. More than 90% of the studied essential oils constituents were identified. It seems that there were partly

similarities among chemical compositions of the four essential oils. In some of essential oils, the main constituents accounted for more than 60% of total oil, e.g., anise and fennel (E-anethole 93.00% and 62.63%, respectively). The main components were E-anethole (93.00%),  $\gamma$ -himachalene (2.85%), methyl chavicol (1.13%) and appiol (0.22%) in anise oil; E-anethole (62.63%), fenchone (13.27%), methyl chavicol (11.19%) and limonene (7.98%) in cumin oil;  $\beta$ -pinene (36.46%),  $\gamma$ -terpinene (36.29%), p-cymene (10.43%), terpinene-7-al- $\gamma$  (3.48%), sabinene (2.02%) and  $\alpha$ -pinene (1.92%) in fennel oil and  $\alpha$ -pinene (39.27%),  $\beta$ -pinene (29.61%), limonene (9.73%), myristicin (6.70%), appiol (4.75%), myrtenal (1.82%) and sabinene (1.59%) in parsley oil. Romeilah et al., (2010) reported that parsley oil contained 18.23% apiol, 16.16% alpha-pinene, 11.16% beta-pinene and 3.23% limonene. The same researchers determined 60.01% cuminaldehyde, 6.12% caryophyllene oxide, 4.89%  $\beta$ -pinene, 4.11% geranyl acetate and  $\beta$ -caryophyllene in *Cuminum cyminum* seed oil (Romeilah et al. 2010). Arslan et al. (2004) determined that essential oil content of *P.anisum* leave varied from 1.3 to 3.7%. The major compounds of *Pimpinella tirupatiensis* are beta-bisabolene (9.2%), delta-3-carene (8.9%), cis-carveol (6.7%), elemol (5.8%), delta-cadinol (4.4%), methyl-geranate (4.3%) and gamma-nonolactone (3.4%) (Bakshu and Raju,2002). The major component of the essential oil of *P.anisum* was *trans*-anethole (78.63-95.21%) (Arslan et al. 2004). Başer et al. (1992) reported that cumin seed oil contained 19.25-27.02% cuminaldehyde, 7.06-14.10% alpha-terpinene, 4.61-12.01% p-cymene and 2.98-8.90% beta-pinene. Arslan et al. (1989) reported the percentage of anethole to be 86 to 88% in sweet fennel oil and 74% in bitter fennel oil while limonene was only 4 and 2% respectively in sweet and bitter fennel oil. These results are in agreement with many authors like the following; the E-anethole was found as the main component in anise and fennel oils (Damayanti and Setyawan, 2012); the main compound of parsley seeds was alpha-pinene in cumin oil was determined as a dominant compound (Başer et al. 1992; Li and Zi-Tao, 2004; Behera et al. 2004). It was reported that the chemical composition of oils are very variable according to seed oils. The environmental conditions and nutritional status of the plant caused to this fact. Plant varieties effected oil chemical contents, composition of oils.

### Conclusion

The seeds of anise, cumin, fennel and parsley contained 0.81%, 1.28%, 0.64 % and 0.52% v/w essential oils, respectively. The main components were E-anethole (93.00%) in anise oil; E-anethole (62.63%), fenchone (13.27%) in cumin oil;  $\beta$ -pinene (36.46%),  $\gamma$ -terpinene (36.29%) in fennel oil and  $\alpha$ -pinene (39.27%),  $\beta$ -pinene (29.61%) in parsley oil.

### Acknowledgement

The authors would like to extend their sincere appreciation to the Deanship of Scientific Research at King Saud University for its funding the Research group NO (RG-1435-049).

### References

- Adams, R. (2001). Essential oil components by Quadrupole GC/MS. Allured Publishing Corp., Carol Stream, IL, USA.
- Akgül, A. (1986). Studies on the essential oils from Turkish fennel seeds (*Foeniculum vulgare* Mill. var. dulce). In: Brunke,E.J. & Walter de Gruyter (Eds) Progress in Essential Oil Research, (pp. 487-489). Berlin.
- Akgül, A. (1993). Spice Science and Technology. Publ. No15,(1993), Turkish Association of Food Technologists Press, Ankara (in Turkish)

- Arslan, N., Bayrak, A., & Akgül, A. (1989). The yield and components of essential oil in fennels of different origin (*Foeniculum vulgare* Mill) grown in Ankara conditions. *Herba Hungarica* Vol 28(3), pp. 27-31.
- Arslan, N., Gürbüz, B., & Sarıhan, E.O. (2004). Variation in essential oil content and composition in Turkish anise (*Pimpinella anisum* L.) populations. *Turkish Journal of Agriculture Forestry* Vol 28, pp. 173-177.
- Badoc, A., Deffieux, G., Lamarti, A., Bourgeois, G., & Carde, J. -P. (1994). Essential oil of *Foeniculum vulgare* M var. *piperitum* (Ucria) Cout fruit. *Journal of Essential Oil Research*, Vol 6, pp. 333-336.
- Bakshu, L. Md. & Raju, R.R.V. (2002). Essential oil composition and antimicrobial activity of tuberous roots *Pimpinella tirupatiensis* Bal. & Subr., an endemic taxon from eastern ghats, India. *Flavour and Fragrance Journal* Vol 17, pp. 413-415.
- Başer, K.H.C., Kürkçüoğlu, M., & Özek, T. (1992). Composition of the Turkish cumin seed oil. *Journal of Essential Oil Research* Vol 4(2), pp. 133-138.
- Baytop T. (1984). Treatment with Plants in Turkey. İstanbul Univ Publ Nu 3255 İstanbul, Turkey., (in Turkish).
- Behera, S., Nagarajan, S., Jagan Mohan, L. (2004). Microwave heating and conventional roasting of cumin seeds (*Cuminum cyminum* L) and effect on chemical composition of volatiles. *Food Chemistry* Vol 87, pp. 25-29.
- Damayanti, A., & Setyawan, E. (2012). Essential oil extraction of fennel seed (*Foeniculum vulgare*) using steam distillation. *International Journal of Science Engineering* Vol 3(2), pp. 12-14.
- Duke, J.A. (1988). Handbook of medicinal herbs. CRC Pres, Boca Raton, FL, pp 198-199.
- Li, R., Zi-Tao, J. (2004). Chemical composition of the essential oil of *Cuminum cyminum* L. from China. *Flavour and Fragrance Journal* Vol 19, pp. 311-313.
- Miller, L.G., Murray, M.V. (2004). Herbal Medicines. New York: The Hawort Press, p.74.
- Özcan, M. (2004). A review on parsley (*Petroselinum crispum* Mill.) and its many uses. *Obst Gemuse-und Kartoffelverarbeitung*, vol 89(2/3), pp.22-26.
- Özcan, M. M., Chalchat, J. C., Arslan, D., Ateş, A., & Ünver, A. (2006). Comparative essential oil composition and antifungal effect of bitter fennel (*Foeniculum vulgare* ssp. *piperitum*) fruit oils obtained during different vegetation. *Journal of Medicinal Food* Vol 9(4), pp. 552-561.
- Özcan, M., & Akgül, A. (2001). Chemical composition of the essential oil of bitter fennel (*Foeniculum vulgare* subsp. *piperitum*). *Journal of Spices Aromatic Crops* Vol 10(1), pp. 49-50.
- Özcan, M.M., & Chalchat, J. C. (2006). Effect of collection time on chemical composition of the essential oil of *Foeniculum vulgare* subsp. *piperitum* growing wild in Turkey. *Eur Food Research and Technology* Vol 224, pp. 279-281.
- Romeilah, R.M., Fayed, S. A., & Mahmoud, G. I. (2010). Chemical compositions, antiviral and antioxidant activities of seven essential oils. *Journal of Applied Sciences Research* Vol 6(1), pp. 50-62.
- Ross, S. A., El-Keltawi, N. E., & Megalla, S. E. (1980). Antimicrobial activity of some Egyptian aromatic plants. *Fitoterapia* Vol 51, pp.201-205.
- Soysal, Y. (2004). Microwave drying characteristics of parsley. *Biosystem Engineering* Vol 89, pp. 167-173.
- Tabanca, N., Bedir, E., Kırırmer, N., Başer, K. H. C., Khan, M. R., Jacob, M. R., & Khan, I. A. (2003). Antimicrobial compounds from *Pimpinella* species growing in Turkey. *Planta Medica* Vol 69, pp.933-938.
- Twaij, H. A., Elisha, E. E., Khalid, R. M., & Paul, N. J. (1987). Analgesic studies on some Oraqi medicinal plants. *International Journal of Crude Drug Research* Vol 25, pp. 251-254.



## ANTIFUNGAL EFFECT OF SALVIA SCLAREA L. ESSENTIAL OIL ON GROWTH OF FUSARIUM OXYSPORUM F. SP.RADICIS-LYCOPERSICI JARVIS & SHOEMAKER AND VERTICILLIUM DAHLIAE (KLEB.)

Melih YILAR\*, Yusuf BAYAN

Department of Plant Protection, Faculty of Agricultural, Ahi Evran University, Kirsehir, Turkey

\*Corresponding author: melih.yilar@ahievran.edu.tr

### Abstract

Antifungal activities of *Salvia sclarea* L. on *Fusarium oxysporum* f. sp.*radicis-lycopersici* Jarvis & Shoemaker and *Verticillium dahliae* (Kleb.) were investigated in 2017 year. The plant essential oil was hydro-distilled in Clevenger's apparatus from the air-dried aerial parts. Plant essential oils at 0.5, 1, 2, 4, 8 µl/petri dishes concentrations were applied to determine their inhibition effects on mycelium growth of plant pathogenic fungi under laboratory conditions. Petri dishes were incubated at 25±2 °C for 7 days. Mycelium growth was measured by digital calipers and the inhibition rates were calculated. The *S. sclarea* essential oil caused inhibitory effects on mycelium growth of plant pathogenic fungi. Antifungal activity displayed differences according to increasing essential oil concentration and fungi. According to the results, mycelium growth of *Verticillium dahliae* and *Fusarium oxysporum* f. sp.*radicis-lycopersici* was decreased with increase in dose of *S. sclarea* essential oil. The mycelium growth of *Verticillium dahliae*, *Fusarium oxysporum* f. sp.*radicis-lycopersici* was decreased at 8 µl/petri dishes concentration, 46.49%, 39.06% respectively. In conclusion, this study has been shown that *S. sclarea* essential oil has a phytotoxic effect on plant pathogenic fungi.

**Keywords:** Antifungal activity, essential oil, *Salvia sclarea*, sage.

### Introduction

*V. dahliae* is a soil borne wilt disease which possess economic importance for various agricultural products (Demirci and Genç, 2009). The disease gets more fundamental because no fungicide exists to recover the plant infected with *Verticillium* and no specific symptoms have been determined (Rus et al., 2015). An additional disease which limits the production on the total cultivated area is the fungal disease caused by soil borne *Fusarium* spp. *Fusarium* spp. not only causes paleness in several products, but also produces mycotoxin in stored wheat. Even if pathogen is not a host plant for long periods of time, it can conserve its endurance. Chemicals are not preferred because soil borne diseases do not have an effective chemical control and its negative impact of the used chemicals on soil, human and non-target organisms in the surrounding (Sharma et al., 2017).

Thus, various applications are implemented in addition to alternative cultural precautions instead of synthetic pesticides used for chemical control. Studies are conducted on plant metabolites and plant based medicines which are considered to be less harmful to human health and the environment than synthetic pesticide which is one of these applications (Shaaya et al., 1991; Kordali et al., 2007; Kordali et al., 2009; Urzúa et al., 2010; Onaran 2016). Therefore, studies on the effect of different plant extracts and essential oils embodied in the flowering aerial parts on plant diseases are prioritized. Plant essential oils and extracts are of

potential use in the control of plant diseases because they have not shown a negative effect on human health and environment, and no problems on residues of the products were observed. Comprised of distinctly different components and having a complex mixture, plant essential oils can be found in several plant families (Karasu and Öztürk, 2014). Lamiaceae is one of the families which includes fundamental medical flavour plants (Mamadaliyeva et al., 2017). The Lamiaceae family comprises of 236 species, including the *Salvia* species, and 7133 types (Harley et al., 2004). Possessing rich essential oil content, the *Salvia* species contain 900 types (Tohma et al., 2016). 95 types of the *Salvia* species exist in Turkey with an endemism rate of 51%. *Salvia sclarea* L., which is two-year, shortlived or perennial and can grow up to 1 m (Özer, 2016), is one of the most demanded Mediterranean plant types (Dogan et al., 2015). *Salvia* species are commonly used in cosmetics perfumery, food industry and medicine (Yilar and Kadioglu, 2016). Previous biological studies have reported that the *Salvia* species are antibacterial, antifeedant, antioxidant, antiviral, antimicrobial, antifungal and herbicidal (Kawahara et al., 2004; Fraga et al., 2005; Lakhali et al., 2013; Tada et al., 1994; Karcioğlu et al., 2011; Abu-Darwish et al., 2013; Uremis et al., 2009). The present study explored the potential of antifungal *S. sclarea* essential oils on *Fusarium oxysporum* f. *sp. radices-lycopersici* jarvis&shoemaker and *Verticillium dahliae* (Kleb.) which are significant plant pathogens.

### Material and Methods

**Plant Material and Extraction of Essential Oils:** *S. sclarea* plants were obtained during their flowering stage in the 2015 vegetation period in the Province of Tokat. The essential oil of the shadow-dried plants was retrieved with the use of the neo-clevenger device and hydro-distillation method. The obtained essential oils were preserved at +4 °C until the activity work.

**Fungus Cultures:** The fungi of plant pathogen used in the study (*Verticillium dahliae* and *Fusarium oxysporum* f. *sp. radices-lycopersici*) were obtained from the stock cultures in Phytopathology laboratories of the Department of Plant Protection, Faculty of Agriculture, Ahi Evran University.

**Antifungal Testing:** The prepared PDA's were poured into 60 mm plastic petri, 10 ml per petri. Sterile blotting paper were attached on the petri capsules and the specified doses (0.5 µl, 1 µl, 2 µl, 4 µl, 8 µl) of essential oil were soaked by the blotting paper with the help of micropipettes. 10 µl sterile purified water was soaked as the control group. The petri were sealed with paraffin film and left for incubation at 25 °C. The development of mycelium of the diseases was measured with a digital caliper seven days after the application. The application was replicated three times and repeated two times. The percentage of interference rate of the essential oils was calculated according to the formula below.

$$MGI=100\times(DC -DT)/DT$$

I: Blocking percentage compared to the control (Mycelium development)

DC: Mycelium development in the control

DT: Mycelium development in essential oil applications

## Results and Discussion

The results of the antifungal effect of *Salvia sclarea* essential oil on *Fusarium oxysporum f. sp. radicans-lycopersici* Jarvis & shoemaker and *Verticillium dahliae* (Kleb.) were presented in Table 1.

An antifungal effect was found in the tested fungi of plant pathogen from *Salvia sclarea* essential oils. The negative effect on the development of mycelium was positively related to the dose of the oil applied. No effect was observed of *S. sclarea* essential oils on mycelium development of *V. dahliae* in 0.5 and 1 µl/petri doses. However, the *V. dahliae* mycelium development was inhibited in the doses of 2, 4 and 8 µl by 26, 16, 37.50 and 46.50 %, respectively (Table 1).

Similar results were noted with the plant pathogen *Fusarium oxysporum f.sp. radicans-lycopersici*. Yet, it was found that this pathogen is more sensible to plant essential oils than *V. dahliae*. The lowest antifungal effect of the *S. sclarea* essential oil on the *Fusarium oxysporum f.sp. radicans-lycopersici* mycelium development was observed to be in the 0.5 µl/petri doses with an interference rate of 1.81, and in the 8 µl doses with an interference rate of 39.06 (Table 1).

Table 1. The effect of *Salvia sclarea* essential oil on the mycelium development of *Fusarium oxysporum f. sp. radicans-lycopersici* jarvis&shoemaker and *Verticillium dahliae* (Kleb.)

Doses	<i>Verticillium dahliae</i>		<i>Fusarium oxysporum f. sp. radicans-lycopersici</i>	
	MG(mm)	MGI(%)	MG(mm)	MGI(%)
Control	60.00a*	0.00	44.67a	0.00
0.5µl	60.00a	0.00	43.86a	1.81
1µl	60.00a	0.00	43.20a	3.29
2µl	44.30b	26.16	37.26b	16.58
4µl	37.50c	37.50	32.89c	26.37
8µl	32.10d	46.50	27.22d	39.06

\*Means in the same column with the same letter were not significantly different by ANOVA( $\alpha=0.005$ )

Plant essential oils and essential oil components possess antimicrobial activities which enable their use as biofumigant against several pre- and post harvest diseases of economically important plants (Siripornvisal, 2010). Consequently, the present study revealed the antifungal activities of *S. sclarea* essential oil of important plant pathogens.

Similar studies were conducted by various researchers on *Fusarium oxysporum f. sp. radicans-lycopersici* and *V. dahliae*, and the antifungal effects of plant essential oils were reported. Besides the change of plant essential oils and extracts of *Salvia officinalis*, *S. cryptantha* and *S. tomentosa* on the mycelium development of *Fusarium oxysporum f. sp. radicans-lycopersici* based on the increasing doses, extracts and essential oils, antifungal activities were observed (Yilar and Kadioglu, 2016). Yilar et al. (2016) stated that the *Vitex agnus-castus* L. and *Myrtus communis* L. essential oils interfered the development of mycelium of *Fusarium oxysporum f. sp. radicans-lycopersici* and *Verticillium dahliae* by 70.70%-100%; 93.00%-100%, respectively, compared to the control group. In a similar study, the *Heracleum platytaenium* Boiss essential oil inhibited the development of mycelium of *V. dahliae* and *Fusarium oxysporum f. sp. radicans-lycopersici* in the 10 µl doses by 73.25% and 100%, respectively (Bayan et al., 2016).

Additionally, Arslan and Dervis (2010) revealed that the *Origanum onites*, *O. syriacum*, *O. minutiflorum*, *O. vulgare*, *O. marjorana*, *Thymus vulgaris*, *T. serpyllum*, *Rosmarinus*

*officinalis*, *Salvia officinalis* and *Micromeria fruticosa* essential oils inhibited the mycelium development of *Verticillium dahliae*. Likewise, it was reported that the *Origanum majorana* L. essential oil inhibited the development of mycelium of *Verticillium dahliae* in the 0.5 mg·L<sup>-1</sup> and 1 mg·L<sup>-1</sup> doses, and the MIC concentration of this disease was 5 mg·L<sup>-1</sup> (Rus et al., 2015).

### Conclusions

The results of the present study revealed that the *S. sclarea* essential oil possesses an antifungal effect on *Fusarium oxysporum f. sp. radices-lycopersici* and *V. dahliae*. These and similar results of studies is of great importance in today's development of the negative effects of pesticides, which are commonly used in the control of fungal plant pathogens in agricultural products, on the environment and human health.

### References

- Abu-Darwish, M.S., Cabral, C., Ferreira, I.V., Gonçalves, M.J., Cavaleiro, C., Cruz, M.T., Al-bdour, T.H. and Salgueiro, L. (2013). Essential oil of common sage (*Salvia officinalis* L.) from Jordan: Assessment of safety in mammalian cells and its antifungal and anti-inflammatory potential. *BioMed Research International*. 1-9.
- Arslan M., Dervis S. (2010). Antifungal activity of essential oils against three vegetative-compatibility groups of *Verticillium dahliae*. *World Journal Microbiol Biotechnol*, 26:1813–1821.
- Bayan Y., Yilar M., Onaran A. (2016). Antifungal activity and chemical composition of the essential oil of *Heracleum platytaenium* Boiss. *Egyptian Journal of Biological Pest Control*, 26(2): 237-240.
- Demirci E., Genc T. (2009). Vegetative compatibility groups of *Verticillium dahliae* isolates from weeds in potato fields. *Journal of Plant Pathology*, 91 (3): 671-676.
- Dogan G., Hayta S., Yuce E., Bagci E. (2015). Composition of the essential oil of two *Salvia* taxa (*Salvia sclarea* and *Salvia verticillata* subsp. *verticillata*) from Turkey. *Natural Science and Discovery*, 1(3): 62-67.
- Fraga, B.M., Díaz, C.E., Guadaño, A. and González-Coloma, A. (2005). Diterpenes from *Salvia broussonetii* transformed roots and their insecticidal activity. *J. Agric. Food Chem.* 53: 5200-5206
- Harley R.M., Atkins S., Budantsev A., Cantino P.D., Conn B.J., Grayer R., Harley M.M., de Kok R., Krestovskaja T., Morales R., Paton A.J., Ryding O., Upson T. (2004). *Labiatae*. In: Kubitzki, K. (ed.), *The Families and Genera of Vascular Plants*, vol. 7, pp. 167-275. Springer-Verlag, Berlin.
- Karasu K., Öztürk E. (2014). Antimicrobial and antioxidant effects of medicinal and aromatic plants in poultry. *Turkish Journal of Agricultural and Natural Sciences Special Issue*, 2: 1766-1772.
- Karçioğlu, L., Tanis, H., Çömlekçioğlu, N., Diraz, E., Kireççi, E. and Aygan, A. (2011). Antimicrobial activity of *Salvia trichoclada* in Southern Turkey. *International Journal of Agriculture & Biology*. 13: 134-136
- Kawahara, N., Tamura, T., Mayumi, I., Hosoe, T., Kawai, K., Sekita, S., Satake, M. and Goda, Y. (2004). Diterpenoid glucosides from *Salvia greggii*. *Phytochemistry*. 65: 2577-2581.
- Kordali, Ş., Kotan, S. and Çakır, A. (2007). Screening of antifungal activities of 21 oxygenated monoterpenes in-vitro as plant disease control agents. *Allelopathy Journal*. 19(2):373-392.

- Kordali, Ş., Çakır, A., Akcin, T.A., Mete, E., Akcin, A., Aydın, T. ve Kılıç, H. (2009). Antifungal and herbicidal properties of essential oils and n-hexane extracts of *Achillea gypsicola* Hub-Mor. and *Achillea biebersteinii* Afan. (Asteraceae). *Industrial Crops and Products*, 29, 562-570.
- Lakhal, H., Ghorab, H., Chibani, S., Kabouche, A., Semra, Z., Smati, F., Abuhamdah, S. and Kabouche, Z. (2013). Chemical composition and biological activities of the essential oil of *Salvia officinalis* from Batna (Algeria). *Der Pharmacia Lettre*. 5 (3): 310-314
- Mamadaliyeva N.Z., Akramov D.K., Ovidi E., Tiezzi A., Nahar L., Azimova S.Z., Sarker S.D. (2017). Aromatic medicinal plants of the Lamiaceae family from Uzbekistan: ethnopharmacology, essential oils composition, and biological activities. *Medicines*, 4, 8.
- Onaran A. (2016). In vitro antifungal activities of some plant extracts against plant pathogenic fungi in Turkey. *Egyptian Journal of Biological Pest Control*, 26(1):111-114.
- Özer H. (2016). Sage species growing natively around Erzurum and their medicinal properties. *Tarla Bitkileri Merkez Araştırma Enstitüsü Dergisi*, 25 (Özel sayı-2):340-345. (Review).
- Rus C.F., Pop G., Alexa E., Şumălan R.M., Copolovici, D.M. (2015). Antifungal activity and chemical composition of *Origanum majorana* L. essential oil. *Research Journal of Agricultural Science*, 47 (2):179-185.
- Siripornvisal S. (2010). Antifungal activity of Ajowan oil against *Fusarium oxysporum*. *KMITL Sci. Tech. J.*, 10 (2):45-51.
- Shaaya, E., Ravid, U., Paster, N., Juven, B., Zisman, U., Pissarev V. (1991). Fumigant toxicity of essential oils against four major stored-product insects. *Journal of Chemical Ecology*, 17(3): 499-504.
- Sharma, A., Rajendran, S., Srivastava, A., Sharma, S., Kundu B. (2017). Antifungal activities of selected essential oils against *Fusarium oxysporum* F.Sp. *lycopersici* 1322, with emphasis on *Syzygium aromaticum* essential oil. *J. Biosci. Bioeng.*, 123 (3): 308-313.
- Tada, M., Okuno, K., Chiba, K., Ohnishi, E. and Yoshii, T. (1994). Antiviral diterpenes from *Salvia officinalis*. *Phytochemistry*. 35: 539-541.
- Tohma H., Köksal E., Kılıç Ö., Alan Y., Yılmaz M.A., Gülçin I., Bursal E., Alwasel S.H. (2016). RP-HPLC/MS/MS analysis of the phenolic compounds, antioxidant and antimicrobial activities of *Salvia* L. Species. *Antioxidants*, 5, 38.
- Uremis, I., Arslan, M., Uludag, A. and Sangun, M.K. (2009). Allelopathic potentials of residues of 6 Brassica species on johnsongrass [*Sorghum halepense* (L.) Pers.]. *African Journal of Biotechnology*. 8(15): 3497-3501.
- Urzúa A., Santander R., Echeverría J., Cabezas N., Palacios S.M., Rossi Y. (2010). Insecticide properties of the essential oils from *Haplopappus foliosus* and *Bahia ambrosoides* against the house fly, *Musca Domestica* L. *J. Chil. Chem. Soc.* 55: 392–395.
- Yılar M., Kadioglu I. (2016). Antifungal activities of some *Salvia* species extracts on *Fusarium oxysporum* f.sp. *radicis-lycopersici* (FORL) mycelium growth In-vitro. *Egyptian journal of biological pest control*. 26(1): 115-118.
- Yılar M., Bayan Y., Onaran A. (2016). Chemical composition and antifungal effects of *Vitex agnus-castus* L. and *Myrtus communis* L. plants. *Not. Bot. Horti. Agrobi.*, 44(2):466 - 471

## MORPHOLOGICAL AND MOLECULAR IDENTIFICATION OF *FUSARIUM* spp. CAUSING DISEASES IN STRAWBERRY

Müge DOĞANER<sup>1</sup>, Mahmood AYYAZ, Sibel DERVIŞ<sup>2</sup>, Çiğdem ULUBAŞ SERÇE<sup>1</sup>

<sup>1</sup>Niğde Ömer Halisdemir University, Natural Science Institute, Plant Production and Technologies Department  
51240 Niğde, Turkey

<sup>2</sup>Mardin Artuklu University, Vocational School of Kızıltepe, Department of Plant and Animal Production, 47000  
Mardin, Turkey

\*Corresponding author: muge1293@gmail.com

### Abstract

Soil-born fungal diseases cause significant losses in strawberry culture and *Fusarium* is one of the most important among them. The present study was conducted to investigate *Fusarium* species causing wilting in strawberry plants. Morphological and molecular detection of different *Fusarium* species related to wilting diseases in strawberries was objective of the study. The fungal isolates were collected from the main strawberry growing areas in Anamur and Silifke districts of Mersin province, Gazipaşa and Aydıncık districts of Antalya province, and Sultanhisar district of Afyon province. Total of 300 samples were analyzed morphologically and 39% of them found infected with *Fusarium* species. The pathogenicity of six morphologically distinct *Fusarium* isolates were tested utilizing root dipping to spore suspension method using strawberry variety “Festival”. After pathogenicity tests, total DNA from mycelial cultures of six *Fusarium* isolates were extracted and ribosomal DNA ITS region was amplified using ITS6/4 primers by PCR. The amplicons were sequenced and obtained DNA sequences were blasted in NCBI and Fusarium ID GeneBanks. The sequences of all morphologically identified *Fusarium* isolates showed 99-100% identity with the *Fusarium* species deposited in NCBI. Furthermore, the investigated *Fusarium* species were identified as *Fusarium oxysporum*, and *F. proliferatum* according to NCBI but *F. incarnatum-equiseti* species complex and *F. concolor* according to Fusarium ID.

**Key words:** *Fusarium* spp., ITS, Molecular diagnosis, Pathogenicity, PCR, Strawberry.

### Introduction

The strawberry (*Fragaria* spp.) belongs to family *Rosaceae*. It is a perennial plant with an herbaceous characteristic. It can be grown in a wide variety of ecological conditions of the world due to their high adaptability (Stewart and Folta, 2010). Since 1960's, strawberry is grown as economical crop in Turkey. Maas (1998) reported that soil-borne fungal pathogens are the most destructive diseases causing quality and quantity decrease in strawberry production in the world, and the most detrimental ones are i.e., *Colletotrichum*, *Pythium*, *Rhizoctonia*, *Phytophthora* and *Verticillium* genera and *Fusarium oxysporum* f. sp. *fragariae* is considered responsible for causing wilting in strawberries. Black root rot disease caused by *Rhizoctonia*, *Pythium*, *Cylindrocarpon* and *Fusarium* species is also known as a root disease complex affecting strawberry production worldwide and causes significant yield losses (Martin 2000, Manici *et al* 2005). *Fusarium* species can adapt various kinds of climatic conditions and are responsible to cause various diseases in targeted crop. In case of severe infection, yield losses can reach up to 50 percent in strawberry (Maas, 1998).

The correct identification and diagnosis of targeted pathogen is one of the important steps towards management practices (Khiyani *et al.*, 2014). Although, the conventional fungal

identification methods are also significant but also have various limitations. Because achieving the results in such techniques requires both experience and time, and the results could vary according to the investigators (Garcia *et al.*, 2013). The recent advances in molecular biology helped in developing new identification methodologies and simultaneously have also enabled the rapid and reliable identification of fungi. Nowadays, PCR and DNA sequencing based techniques are being widely used for fungal identification (Arvanitis *et al.*, 2014).

In molecular studies of fungal genomic system, 18S rDNA and Internal Transcribed Spacer (ITS) in ribosomal DNA (rDNA) are the most preferred genomic regions. ITS, is a non-encoded region, that evolves more rapidly and is suitable for comparing fungal species within same races of species (Schoch *et al.*, 2012). Such advancement in molecular methods has enabled accurate disease diagnosis of fungi in a short period by minimizing the chances of misidentification. For this reason, present study was designed to diagnose *Fusarium* species from the collected strawberry samples by using PCR technique.

### Materials and Methods

The *Fusarium* isolates have been isolated from strawberry plants showing wilting symptoms. The plants were collected from Anamur and Silifke districts of Mersin province, Gazipaşa and Aydınçik districts of Antalya province, and Sultanhisar district of Afyon province during 2014 (Figure 1). The roots of wilted plant samples were washed under tap water and root samples (1-2 cm) were taken using sterile blades. The root samples were kept in 0.5% sodium hypochlorite solution for 5 minutes and washed three times with distilled water for surface sterilization, after drying of the samples they were incubated at 27°C for 5-7 days on Petri dishes containing potato dextrose agar (PDA) media having 100 mgL<sup>-1</sup> streptomycin sulfates. Microconidia or macroconidia were collected from developed colonies and transferred to new petri dish containing (PDA) for purification purpose. Pure cultures were obtained from the colonies of *Fusarium* isolates by the single spore isolation method (Choi *et al.*, 1999). The samples from pure culture were preserved in tubes containing PDA at 5°C for further studies.



Figure 1. *Fusarium* isolates studied in this research

### Pathogenicity Test

The pathogenicity test was conducted on strawberry plants (variety Festival) by using 6 *Fusarium* isolates possessing different morphology. The selected isolates developed on PDA at 25 °C for 7 days before pathogenicity test. The spore suspension was adjusted to  $1 \times 10^6$  conidia by counting hemocytometer. The roots of strawberry plants were cut to 6 cm length and immersed in spore suspension for 30 mins. The control plants were immersed in sterile water. Following inoculation, plants were planted with a pot of 15 cm in diameter containing a mixture of peat:perlite (1: 1). The pots were maintained under controlled conditions at  $27 \pm 2^\circ\text{C}$  and 12:12 h light:dark photoperiod and irrigated regularly. The experiment was set up in

three repetitions and repeated two times. The pathogenicity was evaluated using 0-5 scale (0 = no symptom, 1 = 1-2 leaves yellowed, 2 = all leaves deformed, 3 = chlorosis and early plant wilt, 4 = necrosis and all plant wilted, 5 = dead plant) two months after inoculation (Nam *et al.*, 2009). The scale data was evaluated by Oneway- ANOVA statistical analysis. Re-isolation of the fungi was carried out from the roots and crowns of the inoculated plants.

#### Molecular analysis

The fungal DNA extraction was performed using the DNA extraction kit according to the manufacturer defined protocols (Qiagen). The concentration of DNA was measured using spectrophotometer (ThermoFisher®) and adjusted to 20 ng/μl. A total of 50 μl PCR reaction mixture included 5 μl of 10 mM dNTPs, 3 μl of 50 mM MgCl<sub>2</sub>, 5 μl of 10 μM Primer ITS6 and ITS4, 0.5 μl of Taq DNA polymerase (Invitrogen) and 3 μl of DNA. The amplification condition was pre-denaturation at 94 °C for 3 mins, 35 cycles consisting of 30s at 94 °C, 30s at 55 °C and 60s at 72 °C, followed by 10 mins at 72°C for final extension. The PCR product was electrophoresed on 1.5% agarose gel. The staining was performed using Ethidium Bromide solution. The visualization was performed under UV.

The obtained DNA amplicons were directly sent to a DNA sequencing company (Medsantek, Istanbul) for DNA sequencing from both ends. Sequence assembly of forward and reverse contigs of DNA sequences were performed by Mega 7 software (Kumar *et al.*, 2016). The final obtained consensus sequences were searched by Basic Local Alignment Search Tool (BLAST) option of National Center for Biotechnology Information (NCBI).

#### Results and Discussion

The *Fusarium* isolates were confirmed according to the shape and color of mycelium developed in culture. These isolates were; A39- dark, thick vein and purple color, A28-light, thin vein and pinkish purple color, E27-fine vein and purple color, G02-fine vein and purple color, E26-thick vein and purple color, E30-thick vein and purple color (Figure 2). Spore size of *Fusarium* isolates prepared in Lam-lamel preparation was determined by micromicroscope. A39 - 6x3 μm, E26 - 5x2 μm, E27 - 7x3 μm, E28 - 5x3 μm, E30 - 9x3 μm, and G02 - 6x2 μm (Figure 3).



Figure 2. *Fusarium* culture and fungi isolated root samples.



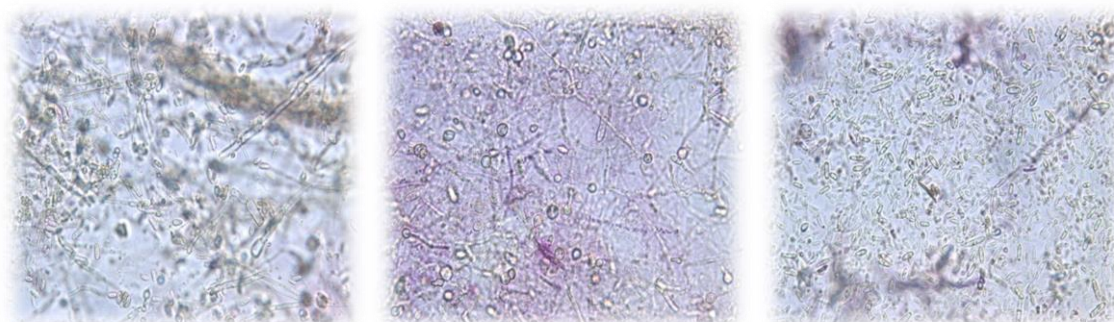


Figure 3. *Fusarium* microconidia and macroconidia.

In pathogenicity tests, the strawberry plants inoculated with *Fusarium* isolates were dead in two months. Root rot and discoloration of sectional cross of crowns were observed on diseased plants (Figure 4). According to statistical analysis, there is no significant differences among the variations because the significance value was lower than 0.05. The experiment is homogenous and the all isolates were pathogenic due to causing the disease on experimental plants.



Figure 4. Pathogenicity tests of *Fusarium* isolates (left) and root and crown symptoms of *Fusarium* isolate (right).

The DNA concentrations of the *Fusarium* isolates obtained from DNA extraction were varied as 22-107 ng/ $\mu$ L. After the PCR analysis, 600 bp length amplicons were obtained on agarose gel (Figure 5). The consensus nucleotides were A39 463 bp, E26, E27 and E28 542 bp, E30 and G02 556 bp after trimming and contig assembly. Among these isolates A39, E28, E26 and E27 were 99.94%, E30 and G02 were 99.82% identical by multiple alignment analysis. The all six sequence multiple alignment analysis exhibited 96.33% identity. As a result of the blast analysis of the consensus sequences in NCBI database, A39, E28, E27, E30 isolates exhibited 99% identity with *F. oxysporum*, E26 and G02 isolates had 99% identity with *F. proliferatum* isolates (Table 1). However, blast analysis in Fusarium ID database diagnosed our isolates as a different *Fusarium* species from NCBI database. By this analysis, A39, E28, E27, E30 isolates matched with *F. incarnatum-equiseti* species complex in 94.84-95.59% range of identity. E26 and G02 isolates had 96.95% and 97.22% identity with *F. concolor* isolates, respectively.

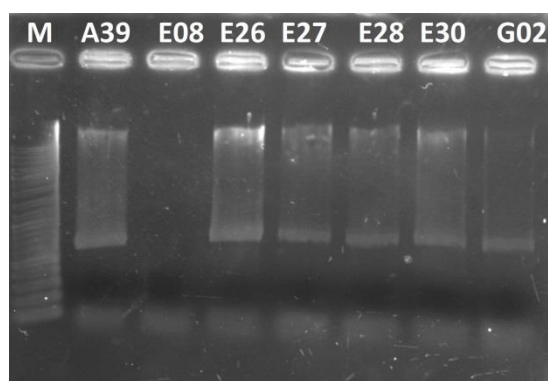


Figure 5. PCR amplification of Fusarium isolates using ITS6 / ITS4 primers.

Isolate name / sequence length	NCBI Blast Analysis	Sequence coverage / Identity (%)	Fusarium ID Blast Analysis	Sequence coverage / Identity (%)
A39, 463 bp	<i>F. oxysporum</i>	(1-463 bp) 100	<i>F. incarnatum-equiseti</i> species complex	1-463 bp 94.84
E26, 542 bp	<i>F. oxysporum</i>	(1-542 bp) 99	<i>F. incarnatum-equiseti</i> species complex	(1-542 bp) 95.59
E27, 542 bp	<i>F. oxysporum</i>	(1-542 bp) 99	<i>F. incarnatum-equiseti</i> species complex	(1-542 bp) 95.41
E28, 542 bp	<i>F. oxysporum</i>	(1-542 bp) 99	<i>F. incarnatum-equiseti</i> species complex	(1-542 bp) 95.59
E30, 556 bp	<i>F. proliferatum</i>	(1-556 bp) 99	<i>F. concolor</i>	(1-359 bp) 96.95
G02, 556 bp	<i>F. proliferatum</i>	(1-556 bp) 100	<i>F. concolor</i>	(1-359 bp) 97.22

Table 1. The results of Blast analysis in two different database.

### Conclusions

The rDNA genes have been commonly used in identification and taxonomic studies. In this study these genes were confirmed to be particularly appropriate for the purpose of providing target sequences for molecular detection. So this study is helpful to understand the actual cause as well as the causal organism of the disease and can further support and strengthen the fact that *Fusarium* sp. is the actual causal organism of this disease. As we provided different results by blasting different databases, the further studies have to be conducted on focusing the other gene sequencing such as Beta tubulin, translation elongation factor 1 –alpha, and calmodulin.

### References

- Afzal, M. B. S., Shad, S. A., Abbas, N., Ayyaz, M., & Walker, W. B. (2015). Cross-resistance, the stability of acetamiprid resistance and its effect on the biological parameters of cotton mealybug, *Phenacoccus solenopsis* (Homoptera: Pseudococcidae), in Pakistan. *Pest management science*, 71(1), 151-158.
- Arvanitis, M., Anagnostou, T., Fuchs, B. B., Caliendo, A. M., & Mylonakis, E. (2014). Molecular and nonmolecular diagnostic methods for invasive fungal infections. *Clinical microbiology reviews*, 27(3), 490-526.

- Ayyaz, M., Nadeem, M., & Begum, H. A. (2017). Screening of okra varieties resistance against insect pests under agro climatic conditions of Dera Ismail Khan, Pakistan. *Russian Agricultural Sciences*, 43(2), 149-152.
- Baig, F., Ayyaz, M., & Javed, H. (2015). Screening of Different Groundnut, *Arachis hypogaea* L.(Fabaceae: Fabales) Cultivars Against Red Hairy Caterpillar, *Amsacta albistriga* W.(Arctiidae: Lepidoptera) Population in Relation to Leaf Infestation, Physico-morphic Characters, Abiotic Factors and Yield. *Pakistan J. Zool*, 47(6), 1691-1698.
- Benlioglu S., Yıldız A. and Döken T. 2004. Studies to determine the causal agents of soil borne fungal diseases of strawberries in Aydın and to control them by soil disinfection. *Journal of Phytopathology*.
- Botha A., Denman S., Lamprecht S. C., Mazzola M. and Crous P. W. 2003. Characterisation and pathogenicity of *Rhizoctonia* isolates associated with blackroot rot of strawberries in the Western Cape Province, South Africa. *Australasian Plant Pathology*.
- Cengiz Ö. And Aslantaş R. 2007. Determination of the variation of the yield and quality of the rye grown in the conditions of Erzurum in the season and its relation with the climate data. V. Turkey National Garden Plants Congress Reports, 04-07 September 2007, Erzurum
- Choi, Y. W., Hyde, K. D., & Ho, W. H. (1999). Single spore isolation of fungi. *Fungal diversity*.
- Dinler, H. (2014). Research on the detection of soil-borne fungal agents in strawberry fidelites (Doctoral dissertation, Adnan Menderes University).
- DURAK, Emre DEMİRER, and Erkol DEMİRCİ. "Pathogenicity of *Fusarium* Species Isolated from Strawberry Plants in Erzurum Province." *Plant Protection Bulletin* 54.3 (2014).
- García, M. I., Rodríguez, S., & Muñoz-Bellido, J. L. (2013). Identification of fungal clinical isolates by matrix-assisted laser desorption ionization-time-of-flight mass spectrometry.
- Genç T. 2012. Vegetative harmonization groups, pathogenicity and biological struggle of *Verticillium dahliae* Kleb isolated from strawberry plants in Erzurum and Erzincan provinces. Doctoral thesis, Ataturk University Institute of Science and Technology, Erzurum.
- Gerlach W. And Nirenberg H. 1982. The Genus *Fusarium*, a Pictorial Atlas. *Biologische Bundesanstalt Land- and Forst wirtschaft Inst. Mikrobiologie, Berlin-Dahlem, Germany*.
- Golzar H., Phillips D. And Mack S. 2007. Occurrence of strawberry rot and crown rot in Western Australia. *Australasian Plant Disease Notes*.
- Gürer M. and Coskun H. 1993. Occurrence of strawberry diseases in Turkey. 6th International Congress of Plant Pathology, 28 July–6 August.
- Khiyami, M. A., Almoammer, H., Awad, Y. M., Alghuthaymi, M. A., & Abd-Elsalam, K. A. (2014). Plant pathogen nanodiagnostic techniques: forthcoming changes?. *Biotechnology & Biotechnological Equipment*, 28(5), 775-785.
- Kumar S, Stecher G, and Tamura K ( 2016) MEGA7: Molecular Evolutionary Genetics Analysis version 7.0 for bigger datasets *Molecular Biology and Evolution* 33:1870-1874
- Malik, M. U., Javed, H., & Ayyaz, M. (2015). Evaluation of different groundnut *Arachis hypogaea* L. cultivars against termites, *Odontotermes obesus* (Rambur) in Rawalpindi, Pakistan. *Turkish Journal of Agriculture-Food Science and Technology*, 3(6).
- Matsubara Y., Hirano I., Sassa D. And Koshikawa K. 2004. Increased tolerance to *Fusarium* wilt in mycorrhizal strawberry plants raised by capillary watering methods. *Environmental Control in Biology*.

- Nadeem, M., Ayyaz, M., & Begum, H. A. (2015). Comparative efficacy of neem oil and lambda-cyhalothrin against whitefly (*Bemisia tabaci*). *Russian agricultural sciences*, 41(2-3), 138-145.
- Pastrana, A. M., Basallote-Ureba, M. J., Aguado, A., Akdi, K., & Capote, N. (2016). Biological control of strawberry soil-borne pathogens *Macrophomina phaseolina* and *Fusarium solani*, using *Trichoderma asperellum* and *Bacillus* spp. *Phytopathologia Mediterranea*, 55(1), 109.
- Pinkerton J. N., Ivors K. L., Reeser P. W., Bristow P. R. And Windom G. E. 2002. The use of soil solarization for the management of soil borne plant pathogens in strawberry and redraspberry production. *PlantDisease*.
- Schoch, C. L., Seifert, K. A., Huhndorf, S., Robert, V., Spouge, J. L., Levesque, C. A., ... & Miller, A. N. (2012). Nuclear ribosomal internal transcribed spacer (ITS) region as a universal DNA barcode marker for Fungi. *Proceedings of the National Academy of Sciences*, 109(16), 6241-6246.
- Stewart, P. J., & Folta, K. M. (2010). A review of photoperiodic flowering research in strawberry (*Fragaria* spp.). *Critical reviews in plant science*, 29(1), 1-13.

## **A SURVEY STUDY: PEST PROBLEMS AND PEST MANAGEMENT STRATEGIES OF FARMERS IN BURSA PROVINCE (TURKEY)**

Nabi Alper KUMRAL\*, Gözde KILINC, Aykut SELVI, Beyza Nur OZDEMIR, Bilge Ece UNVEREN, Halil İbrahim BOZOGULLARI, Harun DEMIREL, Mert DEMIREL, Pınar BALTA, Sertac PAT, Ugur Deniz KOCAK

Department of Plant Protection, Faculty of Agriculture, Uludag University, Bursa, Turkey

\*Corresponding author: akumral@uludag.edu.tr

### **Abstract**

Climate condition of Bursa province (Turkey), characterized with temperate and humid conditions, is ideal for growing many cultivated plants. This climate also enables quickly development of many insect and mite pests and they generally cause high economic damage in these plants. Although the Turkish Food, Agriculture and Livestock Ministry has been regulated Integrated Pest Management programs and registered new synthetic insecticides to target specific as well as biorational, biotechnological and biological products, the usage habits of these products by growers has not been determined in Bursa, yet. This face to face survey study aims to evaluate both common pests and their management strategies based on grower declarations in Bursa from October 2016 to April 2017. Among 542 growers, most of respondents were middle and old aged (40-50 years old in 34%; 50< years old in 49%) and low education level (86% graduated from primary school). Reflecting production pattern of the region, 15 and 14% of our participants have grown olive and wheat, respectively. Among other 26 cultural plants, the second common species were corn, tomato, cherry, sunflower and pepper with 5-9% of all participants. Moth (14.5%), fruit fly (13.8%) and mite (10.2%) species were reported as key pests. While most of the respondents (90.8%) have used just synthetic insecticides to these pests, few participants have applied biotechnical materials (%1.6), microbial toxins (4.6%) and botanical extracts (4.6%) self-prepared from stinging nettle, tobacco and chili pepper. An aqueous extract obtained from cigarette butt was the most common usage of nicotine extract. Except these traditional method, all of respondents declared that they have never used any commercial biological and botanical products. It seems that Bursa farmers are not aware of registered environmental friendly products against above mentioned pests. In order to change this situation, further education and advertising activities about new environmentally compatible pest management strategies should be performed in Bursa.

**Keywords:** *Botanical insecticides, Bursa, Pest management, Survey, Synthetic insecticides*

### **Introduction**

Bursa province (Turkey) is characterized by temperate and humid climatic features, which enables growing a variety of cereal, vegetable and fruit crops throughout the year. More than twenty-five kinds of crops are economically grown (TUIK, 2016). Depending on temperate and humid climatic condition of the region, insect and mite pests are main problem in growing these crops (Gencer *et al.*, 2005; Kumral and Kovanci, 2007; Kovanci and Kumral, 2008; Kovanci *et al.*, 2010). Consequently, insecticides and acaricides are the most commonly used pest control tools based on Turkey's statistically records (FAO, 2014; TUIK, 2016). Although there are numerous scientific notes and introduction brochures on existing plant

pests in the region (Anonymous, 2017), Bursa farmers' knowledge level about major pests and their pest control attitudes and practices against them have not ever examined. However, the Turkish Food, Agriculture and Livestock Ministry (FALM) has been regulated Integrated Pest Management programs for four decades and registered various synthetic insecticides as well as biorational, biotechnological and biological products (Anonymous, 2017), but the usage habits of these products by growers has not been determined in Bursa, yet. Since years, producers have been made many decisions about how to control pests and which control tools to use against pests. But, there is very little information about their control tactics and preferential decisions. Generally, cost, efficiency, accessibility and simplicity in implementation of the pest management products are guided to farmers' pest management decisions. Therefore, because synthetic pesticides are quick acting and cheap, these chemicals have been used more frequently (Simon, 2014). However, the widespread use of these synthetic compounds can cause serious ecological problems due to kill non-target organisms and to threat human health. The other issues are pesticide residues on crops and resistance developing of the pests to these compounds (Simon, 2014). There is no evidence on the awareness level of Bursa farmers about adverse effects of pesticides on environment and human health. Prior to the discovery of these products, plant-derived botanical insecticides were the main insecticidal compounds used by farmers. Because overwhelming superiority of synthetic pesticides (%33 organo-phosphates; 9% synthetic pyrethroids; 4% carbamates; %53 IGRs, neonicotinoids and others) in the world pesticide market, the consumption of botanical and biological products had been just 0.54% of the world market (FAO 2014; Simon 2014). Similarly, among 225 active substances, the majority of insecticides are organo-phosphates (64%), synthetic pyrethroids (11%), neonicotinoids (16%) and others (9%) in Turkey (Anonymous, 2017). Furthermore, the restriction of pesticide use in agriculture by the European Union has increased the interest in alternative management options (Freier and Boller, 2009). One hundred and eighty active substances which are hazardous on non-target organisms and environment have been forbidden by FALM and simultaneously 13 microbial products, 2 botanical insecticides, 6 pheromones mediated mating disruption, 5 attract-kill and 25 colour traps, and 22 predator and parasitoid biological control agents are registered against numerous pests within last decade in Turkey (Anonymous, 2017). Except for marketing statistics, we have poor information about actual use of these compounds by Bursa's farmers. A survey study was conducted to assess the knowledge level of Bursa's farmers on the main pests and their management practices.

The aim of this research is to obtain data to determine the most consumed pesticides and alternative pest management tools. In addition, the second aim of this study is to learn whether the farmers still use any traditional botanical pesticides.

### **Material and Methods**

Data of the present study are provided from face to face farmers' survey from 9 districts of Bursa province (Turkey) during 2016-2017. Five hundred and forty two farmers who cultivated different plants belong to cereals, vegetables and fruits were randomly selected for this survey. For analysing effects of socio-economic factors on results of this study, some parameters like age, education and income were collected independent variables. However, lands were classified into four different categories according to agricultural practices: (1) conventional land (intensively synthetic pesticide use), (2) traditional land (rarely synthetic pesticides and combined botanicals) and (3) GLOBALGAP lands (Good agriculture practise certificate) (4) organic lands (certificated as organic farmer). Data on insecticide use of the farmers was computed and categorized into three levels: (1) Those who know the used pesticide name (2) Those who do not know the used pesticide name (3) Those who use

pesticides based on advices of experts. Also, the data on main pest problems of farmers were collected. Based on the data, the pest problems were classified according to their pest statuses: (1) key pests (which cause economic damage at each year) and (2) occasional pests (which are only occasionally reach economic injury level). However, their other pest management practices and traditional botanical pesticides that they used based on anonymous information were requested from farmers. Minimum sample size was calculated as 42 for each district based on the method of Vural (2012). In order to explore whether different socio-economic groups of respondents differed with respect to the data, some cross-tabulations were done in SPSS version 23 testing for significance with chi-square test.

## Results and Discussion

Among 542 growers, most of respondents were middle and old aged (34% 40-50 years old; 49% 50< years old) and low education level (86% graduated from primary school). The most of respondents' income varied between 5000-7500 €/year. Reflecting production pattern of the region (TUIK, 2016), the current study shows that 15 and 14% of our participants have grown olive and wheat, respectively. Except for these crops, most of the growing crops were corn (8.7%), tomato (7.8%), cherry (9.1%), pepper (5.4%) and sunflower (4.8%). The other crops were barley, alfalfa, sugar beet, onion, grape, fig, plum, almond, walnut, melon, watermelon, chick-pea, artichoke, strawberry, eggplant and bean with 0.1-3.6% of respondents. When asked to pest problems, moth (14.5%), fruit fly (13.8%) and mite (10.2%) species were reported as key pests (Table 1). Depending on crop species, some respondents described these as occasional pests (Table 1). In both cases, the most important pests ranged as both moths (23.5%), fruit flies (20.3%) and mites (17.0%), respectively. From the reported pest problems, 8 species considered key pests *Cydia pomonella* (L.) (Lepidoptera: Tortricidae), *Helicoverpa armigera* (Hübner) (Lepidoptera: Noctuidae), *Prays oleae* (Bernard) (Lepidoptera, Yponomeutidae), *Ostrinia nubilalis* (Hübner) (Lepidoptera: Pyralidae), *Anarsia lineatella* (Zeller) (Lepidoptera: Gelechiidae), *Bactrocera oleae* (Rossi) (Diptera: Tephritidae), *Rhagoletis cerasi* (L.) (Diptera: Tephritidae) and *Tetranychus urticae* Koch (Acari: Tetranychidae). In accordance with previous researches obtained from the region, the study showed that these are the most important pests (Karsavuran and Durmusoglu, 2004; Gencer *et al.*, 2005; Kovanci and Kovanci, 2006; Kumral and Kovanci, 2007; Kovanci and Kumral, 2008; Kovanci *et al.*, 2009; Kovanci *et al.*, 2010). Because moths and fruit flies are among the most widespread pests in Bursa, synthetic pyrethroids and neonicotinoids were the most commonly used insecticides having been employed by more than 65% of the respondents (Table 2). In fact, IGRs, Organo-phosphates and Ryanodines were also used against these pests with approximately rate of 22% of farmers. In addition, Tetraonic and Tetramic acid derivatives and some microbial toxins were used for control of mite pests. Thus, the results of pesticide use are harmonious with pest problems reported by respondents. More than one-tenth of the respondents used highly hazardous insecticides (Organo-phosphates) against these pests. As a positive reflection of the FALM's ban policy on hazardous insecticides, it was seen that the use of highly hazardous insecticides at the region was lower compared to average use rate of world (FAO, 2014). One of the socio-economic variables, age, showed significantly relationship with insecticide knowledge ( $X^2= 20.821$ ;  $P=0.002$ ), but there was no statistically relationship with pest knowledge and production practice type (Table 3). The current study shows that up to 40 years old farmers have more insecticide knowledge probably based on their experience. Other variables, education, showed no significantly important relationship with three independent variables (Table 4). Lastly, the income of farmers were significantly affected their insecticide knowledge and production practice type ( $X^2= 80.203$ ;  $P<0.01$ ,  $X^2= 78131$ ;  $P<0.01$ , Table 4). The survey results indicated

that low- income farmers do not know insecticides or use according to adviser comments. However, low-income farmers prefer more conventional type.

Table 1. Pest problems in Bursa province, based on a farmer survey in 2016-2017.

Pest Problem	Percent of farmers considering pest problem (%)		
	key pests	occasional pests	total
Mites	10.2	6.8	17.0
Moths	14.5	9.0	23.5
Fruit flies	13.8	6.5	20.3
Shield bugs	5.9	4.6	10.5
Aphids	4.9	6.2	11.1
White flies	1.8	0.6	2.4
Thrips	0.7	0.3	1.0
Pysillds	2.1	0.5	2.6
Coleopters	2.2	2.2	4.4
Coccids and diaspid	2.7	4.5	7.2

Table 2. Insecticide use of farmers in Bursa province, based on a farmer survey in 2016-2017.

Chemical group	Active ingredient	Percent of farmers (%)
<b>Synthetic pyrethroids</b>		<b>37.46</b>
	Deltamethrin	25.73
	Cypermethrin	5.86
	Lambda cyhalothrin	4.89
	Alphacypermethrin	0.65
	Cyfluthrin	0.33
<b>Neonicotinoids</b>		<b>28.33</b>
	Thiacloprid	19.54
	Acetamiprid	5.86
	Imidacloprid	0.98
	Thiamethoxam	1.95
<b>Organo-phosphates</b>		<b>10.75</b>
	Chlorpyrifos-ethyl	0.98
	Dimethoate	9.77
<b>Insect Growth Regulators (IGRs)</b>		<b>10.10</b>
	Pyriproxyfen	10.10
<b>Tetronic and Tetramic acid derivatives</b>		<b>3.27</b>
	Spiromesifen	0.33
	Spirotetramat	0.33
	Spinoteram	2.61
<b>Microbials toxins</b>		<b>4.56</b>
	Abamectin	1.95
	Spinosad	2.61
<b>Ryanodines</b>		<b>0.98</b>
	Chlorantraniliprole	0.98
<b>Botanicals</b>		<b>4.57</b>
	Pyrethrin extract	0.33
	Nicotine extract (cigarette butts)	2.28
	Urtica extract (stinging nettle)	0.98
	Chili pepper extract	0.98
<b>Biotechnical products</b>	Repellents or attractant traps	<b>1.6</b>



Table 3. The effect of farmer's age on their pest knowledge, insecticide knowledge and production type

	Age	20-30	30-40	40-50	50<	Pearson $X^2$	df	P
	N, Number of farmers (%)							
Pest knowledge	know	17(3.2)	68(12.8)	175(32.9)	249(46.8)	2.783	3	0.426
	dont know	0	1 (0.2)	8 (1.5)	14 (2.6)			
Insecticide knowledge	know	11(2.1)	43 (8.1)	117(22.0)	124(23.3)	20.821	3	0.002
	don't know	1(0.2)	13 (2.4)	43 (8.1)	90 (16.9)			
	used with advice	5 (0.9)	13(2.4)	23 (4.3)	49 (9.2)			
Production type	conventional land	17(3.2)	59(11.1)	157(29.5)	234(44.0)	5.38	6	0.496
	traditional land	0	10 (1.9)	25 (4.7)	29 (5.5)			
	GLOBALGAP land	0	0	0	0			
	organic land	0	0	1(0.2)	0			

Table 4. The effect of farmer's education on their pest knowledge, insecticide knowledge and production type

	Education	None	Primary school	High school	Bachelor science	Pearson $X^2$	df	P
	N, Number of farmers (%)							
Pest knowledge	know	0	444(81.9)	68(12.5)	4(0.7)	0.891	2	0.641
	don't know	0	24(4.4)	2(0.4)	0			
Insecticide knowledge	know	0	251(46.3)	47(8.7)	4(0.7)	7.769	4	0.100
	dont know	0	135(24.9)	15(2.8)	0			
	used with advice	0	82(15.1)	8(1.5)	0			
Production type	conventional land	0	409(75.5)	64(11.8)	4(0.7)	8.937	4	0.063
	traditional land	0	59 (10.1)	5(0.9)	0			
	GLOBALGAP land	0	0	0	0			
	organic land	0	0	1(0.2)	0			

Table 5. The effect of farmer's income on their pest knowledge, insecticide knowledge and production type

	Income (€/year)	2500-5000	5000-7500	7500-10000	10000<	Pearson $X^2$	df	P
	N, Number of farmers (%)							
Pest knowledge	know	105 (19.4)	120 (22.1)	40 (7.4)	19 (3.5)	3.418	4	0.490
	dont know	4 (0.7)	4 (0.7)	2 (0.4)	0			
Insecticide knowledge	know	52 (9.6)	72 (13.3)	28 (5.2)	10 (1.8)	80.203	8	<0.01
	don't know	32 (5.9)	9 (1.7)	7 (1.3)	8 (5.3)			
	used with advice	25 (4.6)	43 (7.9)	7 (1.3)	1 (0.2)			
Production type	conventional land	107 (19.7)	124 (22.9)	42 (7.7)	19 (3.5)	78.131	8	<0.01
	traditional land	2 (0.4)	0	0	0			
	GLOBALGAP land	0	0	0	0			
	organic land	0	0	0	0			

## Conclusions

The current study showed that most farmers (91%) use synthetic insecticides against pests and depending on their age and income level a significant part of the farmers do not know the name of insecticide used. According to FALM's regulations, insecticides should be recommended by an adviser, but the results show us that farmers are not aware of the adverse effects of the compound on environment and humans. They also are not aware of registered environmentally safe many products against above mentioned key pests in Turkey. Although it is reported that few microbial, botanical, and repellent or attractant-trap combinations are used but the attempts are not adequate to provide the safety of non-target organisms. In order to change this situation, further education and advertising activities about new environmentally compatible pest management strategies should be performed in Bursa.

## References

- Anonymous (2013). Banned pesticides list. The Turkish Food, Agriculture and Livestock Ministry, Plant Protection Department. <http://www.tarim.gov.tr/Konu/934/Yasaklanan-Bitki-Koruma-Urunleri-Aktif-Madde-Listesi>.
- Anonymous (2017). The database of plant production products. <https://bku.tarim.gov.tr/>
- FAO (2014). Food and Agriculture Organization, Pesticide consumption statistics. <http://www.fao.org/faostat/en/#home>
- Freier B., Boller E.F. (2009). Integrated pest management in Europe – history, policy, achievements and implementation, In Peshin, R. & Dhawan, A.K. (eds.), “Integrated pest management: dissemination and impact”, Vol. 2., Springer, Dordrecht, The Netherlands, pp. 435–454.
- Gencer N.S., Coşkuncu K.S. and Kumral N.A. (2005). Determination of harmful and beneficial fauna in fig orchards in Bursa province. *Ondokuz Mayıs Üniversitesi, Ziraat Fakültesi Dergisi*, 20(2), 24-30.
- Karsavuran Y. and Durmuşoğlu E. (2004). Studies on the possibilities of using pheromone trap for the determination of application time against *Helicoverpa armigera* (Hüb.) (Lepidoptera: Noctuidae) on processing tomato in Mustafakemalpaşa (Bursa, Turkey). *Turkish Journal of Entomology*, 28(4), 253-266
- Kovancı O.B. and Kovancı B. (2006). Effect of altitude on seasonal flight activity of *Rhagoletis cerasi* flies (Diptera: Tephritidae). *Bulletin of Entomological Research*, 96(4), 345-351.
- Kovancı B. and Kumral N.A. (2008). Insect pests in olive groves of Bursa (Turkey). *Acta Horticulturae*, 791, 569-576.
- Kovancı O.B., Gencer N.S. and Larsen T.E. (2009). The deposition and retention of a microencapsulated oriental fruit moth pheromone applied as an ultra-low volume spray in the canopy of three peach cultivars. *Bulletin of Insectology*, 62(1), 69-74.
- Kovancı O.B., Kumral N.A. and Larsen T.E. (2010). High versus ultra-low volume spraying of a microencapsulated pheromone formulation for codling moth control in two apple cultivars. *International Journal of Pest Management*, 56(1), 1-7.
- Kumral N.A. and Kovancı B. (2007). The diversity and abundance of mites in agrochemical-free and conventional deciduous fruit orchards of Bursa, Turkey. *Turkish Journal of Entomology*, 31 (2), 83-95.
- Simon J.Y. (2014). *The toxicology and biochemistry of insecticides*. CRC press, London, UK.
- TUIK (2016). Turkish Statistical Institute. <http://www.tuik.gov.tr/>
- Vural, H. 2012. *Statistics of Agriculture and Food Economy*. Uludağ University Agricultural Faculty, No: 107, Bursa, Turkey, 115p.

## FIELD RESPONSE OF BUPRESTID BEETLE, *ANTHAXIA (ANTHAXIA) ANATOLICA ANATOLICA* CHEVROLAT, TO SYNTHETIC SEMIOCHEMICALS

Nimet Sema GENÇER<sup>1\*</sup>, İrem ALTIN<sup>2</sup>, Nabi Alper KUMRAL<sup>1</sup>, Bilgi PEHLEVAN<sup>1</sup>

<sup>1</sup>Department of Plant Protection, Faculty of Agriculture, Uludag University, Bursa, Turkey

<sup>2</sup>Department of Plant Protection, Faculty of Agriculture, Namık Kemal University, Tekirdağ, Turkey

\*Corresponding author e-mail: nsgencer@uludag.edu.tr

### Abstract

Many buprestid species use visual cues to locate hosts and potential mates. Standard yellow sticky cards tend to capture less buprestid individuals than blue traps. Since some semiochemicals are attractive to buprestid adults, they can be used for trapping them. The hypothesis of this study was to test if trapping capacity of buprestid adults on yellow traps can be increased by semiochemicals. In Bursa region of northwestern Turkey, we investigated the variation in adult captures of a common buprestid beetle, *Anthaxia anatolica anatolica*, on yellow sticky traps baited with synthetic semiochemicals, methyl salicylate (MeSA), benzaldehyde (Be), linalool (L) and farnesene (F) alone and their binary combinations (MeSA + Be; MeSA + F; MeSA + L; F + Be; Be + L; F + L). The study was conducted at three plots in an apple orchard in Bursa, Turkey in 2013. Buprestids were monitored weekly at each plot. In field studies, 52% of jewel beetles were attracted to the synthetic semiochemical formulations. The highest number of adults was caught in traps with Be (2.4 adults/trap), followed by those with F (1 adult/trap) and MeSA + F (0.7 adults/trap) combination. The lowest number of buprestid adults was observed in MeSA + L (0.2 adult per trap), followed by the Be + L (0.3 adults per trap) combinations. Overall, yellow sticky traps impregnated with Be were significantly more attractive to *A. anatolica anatolica* adults compared with other traps. The effects of benzaldehyde on other harmful buprestid species should be investigated in future studies.

**Keywords:** *Attractant, benzaldehyde, buprestid, semiochemicals, sticky trap*

### Introduction

Jewel beetles (Buprestidae) one of the most beautiful families of the Coleoptera. It is a large one, containing over 15,000 described species and divided into five subfamilies. The entire family includes 185 genera (Levey, 1977). Larvae whitish, flat, with a long, thin abdomen and expanded prothorax, without legs, a small dark head retracted into prothorax (Volkovich, 2006). Nearly of all Buprestidae larvae feed within plant tissues. Many young adult species of Buprestidae feed on shoots and branches of tree before copulating and oviposition (Haak and Slanxsky, 1987). *Anthaxia* is the common and quite rich genus in Turkey. The first study made by Bily (1984) has made great contribution to the richness of Turkish fauna. Lodos and Tezcan (1992) cited 69 *Anthaxia* species from Turkey. In another study, 39 species of *Anthaxia* (subgenus *Anthaxia*) have been evaluated (Karaman and Tezcan, 1998). Ulay and Tezcan (1998) cited 22 species *Anthaxia* (subgenus *Haplanthaxia*) from Turkey. One of the common species in the genus, *A. (Anthaxia) anatolica anatolica* Chevrolat distributes Armenia, Azerbaijan, Bulgaria, Georgia, Greece and Turkey (Bily, 1997). *Ferula communis*, *F. nidiflora*, *Hippomarathrum bocconeii*, *H. pterochloenum*, *Magydaris tomentosa*, *Scorodosma foetida* and *Thapsia villosa* were recorded as host plants of species (Curletti,

1994). But there has been performed no study about the biology and ecology of *A. (A.) anatolica anatolica*, yet.

Semiochemicals are cue chemicals used to convey information between plant, pests and their predators or parasitoids. They are typically volatile compounds released after pest damage that are active at low concentrations. Herbivore-induced plant volatiles (HIPVs) released while any herbivore damages a plant. Therefore, HIPVs are secondary protection system in plants which provides to signal to natural enemies of pests (Mumm and Dicke 2010; Rodriguez-Sauna *et al.*, 2012). But, an important noted that the volatiles were able to attract some phytophagous species such as thrips *Frankliniella occidentalis* (Pergande) (Thysanoptera: Thripidae), Green leaf bug, *Apolygus lucorum* (Meyer-Dür) (Hemiptera: Miridae) and Plum curculio, *Conotrachelus nenuphar* (Herbst) (Coleoptera: Curculionidae), (Roditakis and Lykouressis, 1996; Sun *et al.*, 2014; Leskey and Wright, 2004). These volatiles could be used to collect and monitor *Anthaxia* adults. It is critical decision to select the right compound or compound combinations. Because, plants have more than 1000 kinds of HIPVs and various volatiles can be composed by combining hundreds of volatiles (Gaquerel *et al.*, 2009; Kaplan 2012). Many HIPVs have been studied and they are addressed some compounds i.e. methyl salicylate (MeSA), benzaldehyde (Be), linalool (L) and farnesene (F). In recent years, field experiments on HIPVs (or a combination of HIPVs) have been shown that the effectiveness of the volatile varied depends on insect species and volatile combination (Leskey and Wright, 2004). To collect and monitor the specimens in field, developing a new method will be made great contribution to the richness of Turkish fauna. In this study, we used field trapping (yellow sticky trap) as a method to investigate beyond attraction response of *A. (A.) anatolica anatolica* to synthetic HIPVs, alone and in dual combinations.

## Material and Methods

Field studies were carried out in 1- ha apple orchard (5 years old, Granny Smith cv.) of the Uludag University Agricultural Faculty in Bursa (Turkey) from early May to early July 2013. Synthetic formulations of four HIPVs, linalool (L) (97% purity) (Acros Organics, Belgium), benzaldehyde (Be) (99.5% purity) (Merck, USA), methyl salicylate (MeSA) (99% purity) (Acros Organics, Belgium), farnesene (F) (95% purity) (Sigma-Aldrich, USA) and a solvent that was for the most part hexane (Merck, USA) (99.5% purity) were used in this research. Separately (L, Be, MeSA, F) and dual combinations (MeSA+Be; MeSA+F; MeSA+L; F+Be; Be+L; F+L) of these compounds were processed in hexane solutions. Every HIPV was diluted one-to-one in hexane.

Buprestid adults were monitored weekly at every site (involving controls) by yellow sticky cards (28x23 cm, Trece Inc., USA) hanged to an apple tree stem at 2 m above from the ground. Yellow sticky cards that attached to each HIPV were placed 15 m apart (James, 2005). Ten combinations were examined to find out the reaction of the beetles to yellow sticky cards with 5 ml glass vials (consisting 1 ml of applicant HIPV solutions and 1ml of hexane to dilute refined chemicals were left with just 2 ml hexane for control). The glass vials which have volatile compounds were refilled every week and every trap was relocated weekly from May to July in 2013. Three repeats for each of the ten applications and the controls were applied. Buprestids caught in each trap, was counted and recorded weekly in the field and laboratory.

Statistical analysis was performed using analysis of variance (ANOVA) (JMP, version 7: SAS Institute Cary, USA). Mean number of adults in traps were transformed using square root ( $x + 1$ ), excluding weekly comparison, before ANOVA. The least significance difference test (Fisher's protected LSD) was used to test for differences among the accession means and the

controls. Means were separated by the least significance difference test (SAS Institute Inc. 1985) ( $P = 0.05$ ). Likewise the mean insect numbers on traps with each HIPV combination and their control were also compared by a pairwise paired sample  $t$  test.

## Results and Discussion

The Jewel beetle *A. (A.) anatolica anatolica* was attracted and caught to solo and dual combinations of the synthetic HIPVs in the apple tree orchard (Table 1). A mean number adult *A. (A.) anatolica anatolica* in the traps baited with the HIPVs varied with caught of 0.2-2.4 adults per trap in the apple tree orchard (Table 1). They were also attracted to the control traps including just hexane with caught of 0.7 adults per week. The highest number of adults caught by HIPVs was a Be (2.4 per trap), followed by F (1 per trap) and the MeSA+F (0.7 per trap) combination and control (0.7 per trap). The lowest adult number was observed in MeSA+L traps, followed by the benzaldehyde+linalool (0.3 per trap) combinations. Among all of the HIPVs, benzaldehyde was highly attracted to the beetle compared with the other baited traps. The highest number of adult captures occurred in the benzaldehyde baited traps. We found significant effects among the different HIPVs and their dual combinations in attracting adults of *A. (A.) anatolica anatolica* ( $F_{10,389} = 0.03$ ,  $P = 0.001$ ). These effects were examined in the late May and the first half of June (Figure 1). According to LSD test, among the HIPVs and dual combinations, only benzaldehyde is the most significant HIPV statistically in attracting adults of *A. (A.) anatolica anatolica* (Table 1). Among the HIPVs except benzaldehyde and control, there is no significant difference statistically between HIPVs and control traps in the Jewel beetle captures. Moreover, when traps has compared with their controls by paired sample  $t$  test, there were statistically significant more adults of *A. (A.) anatolica anatolica* was attracted to benzaldehyde baited sticky traps compared with control traps (Table 1).

Other HIPVs traps were not significantly different in captures of adults of *A. (A.) anatolica anatolica* compared to control traps containing only hexane. Lure of benzaldehyde to natural enemies *Chrysopa sinica* Tjeder (Neuroptera: Chrysopidae), *Aphidius sp.* (Hymenoptera: Braconidae) and *Coccinella septempunctata* L. (Coleoptera: Coccinellidae) was shown in olfactometer and electroantennogram tests (Han and Chen, 2002) and *Stethorus punctum picipes* (Casey) (Coleoptera: Coccinellidae), *Orius tristicolor* (White) (Hemiptera: Anthocoridae), and flies in Tachinidae and Sarcophagidae families in the field study (James, 2005). The same situation was found for Green leaf bug, *Apolygus lucorum* (Meyer-Dür) (Hemiptera: Miridae) and the plum curculio, *Conotrachelus nenuphar* (Herbst) (Coleoptera: Curculionidae). Benzaldehyde baited traps with a pheromone (grandisoic acid) was reported a valuable tool for monitoring of the adult plum curculio move to apple orchards (Leskey and Wright, 2004; Prokopy *et al.*, 2004). Benzaldehyde was lured to the Green leaf bug, *A. lucorum* (Sun *et al.*, 2014). In the current field study, benzaldehyde attracted the *A. (A.) anatolica anatolica*. Our result about the attractiveness of the benzaldehyde was similar to those reported by authors above. This result is the first record for *Anthaxia* and is supposed to be the first record for Buprestidae family.

In the apple orchard, the mean seasonal abundances of *A. anatolica anatolica* captured in sticky traps baited with single and dual combinations of synthetic HIPVs are presented in Figure 1. During the experiment, in traps baited with HIPVs and control, the density of adults peaked in 23 May and then decreased rapidly in 30 May. The population density of *A. (A.) anatolica anatolica* began to increase again beginning June and reached two peaks in 6 and 13 June (Figure 1). After that point, the population began to decline. Significant differences were found among weekly captures of *A. (A.) anatolica anatolica* in methyl salicylate, benzaldehyde, linalool, farnesene alone, their dual combination (MeSA+Be; MeSA+F;

MeSA+L; F+Be; Be+L; F+L) and control traps during May- July 2013 ( $F_{109,290} = 5.09$ ,  $P < 0.01$ ). The highest peak of adult captures occurred in benzaldehyde traps on 23 May (12 per trap), 6 Jun (4 per trap), 13 Jun (5 per trap) and farnesene traps on 23 May (5 per trap) (Figure 1). When the highest numbers of adult captures in traps have a peak, average temperature was 24.6 °C (min 12.8, max 33.2) in May. After 6 June population decreased because of 23 mm

Table 1. Mean captures of *Anthaxia (Anthaxia) anatolica anatolica* in sticky traps with synthetic HIPVs during early May-early July 2013.

Mean $\pm$ SE number of adults per trap			
Treatment	HIPVs <sup>b</sup>	Control	Pr>T <sup>a</sup>
MeSA	0.6 $\pm$ 0.2 (bc)	0.6 $\pm$ 0.3	0.9684
Linalool	0.5 $\pm$ 0.2 (bc)	1.2 $\pm$ 0.7	0.3326
Farnesene	1.0 $\pm$ 0.4 (b)	1.0 $\pm$ 0.3	0.6710
Benzaldehyde	2.4 $\pm$ 0.8 (a)	0.5 $\pm$ 0.2	0.0425 <sup>x</sup>
Benzaldehyde+ Linalool	0.3 $\pm$ 0.2 (bc)	0.7 $\pm$ 0.4	0.4197
Farnesene+Benzaldehyde	0.5 $\pm$ 0.2 (bc)	0.8 $\pm$ 0.6	0.6882
MeSA+ Farnesene	0.7 $\pm$ 0.3 (bc)	0.2 $\pm$ 0.1	0.1343
MeSA+ Benzaldehyde	0.5 $\pm$ 0.1 (bc)	1.2 $\pm$ 0.4	0.1154
Farnesene+Linalool	0.6 $\pm$ 0.2 (bc)	0.3 $\pm$ 0.3	0.3950
MeSA+Linalool	0.2 $\pm$ 0.1 (c)	0.3 $\pm$ 0.3	0.7022
Control	0.7 $\pm$ 0.1 (bc)	-	-

<sup>a</sup>Within lines, Paired sample t test performed on the data.

<sup>b</sup>Within column, Analysis of variance (ANOVA) was performed on the data. Means were separated by the least significant difference (LSD) test. Different letters denote significant differences between HIPVs and control ( $P < 0.05$ ).

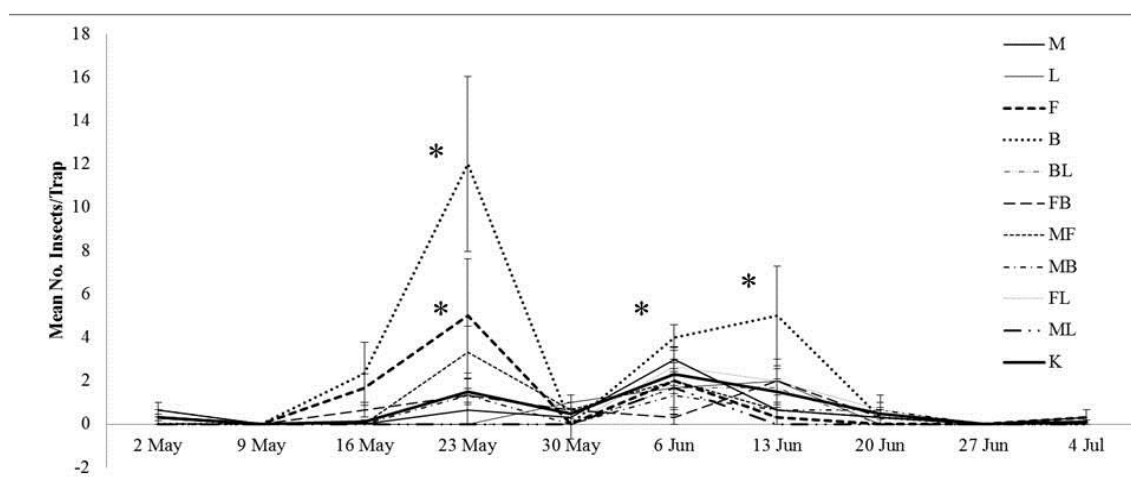


Figure 1. Mean captures per trap of *Anthaxia (Anthaxia) anatolica anatolica* in sticky traps with synthetic HIPVs methyl salisylate (MeSA), benzaldehyde (Be), linalool (L) and farnesene (F) alone and their dual combination (MeSA+Be; MeSA+F; MeSA+L; F+Be; Be+L; F+L) during May- July 2013. \*Significant  $P > 0.05$  by Student's *t*-test.

heavy rains. Lelito *et al.* (2008) analysed the different ways of trapping emerald ash borers (EAB), *Agrilus planipennis* Fairmaire (Coleoptera: Buprestidae), by testing blue and yellow

sticky cards. The lure of *A. planipennis*, to pheromone was showed in field examinations applying baited green sticky traps (Ryall *et al.*, 2012). Trap colour is a significant cause effecting capture in traps, by two colours determined as very appealing purple (Crook *et al.*, 2008; Francese *et al.*, 2008). Purple colored traps are especially appealing to female beetle (Francese *et al.*, 2008), while green colored traps are more efficient at trapping male beetle (Lelito *et al.*, 2008) monitoring of *A. planipennis*. Traps placed in the mid-canopy of ash trees (13 m) caught significantly more beetles than those placed at ground level, because the most adult buprestids active in the tree canopy (Francese *et al.*, 2008). On the other hand, the place of the trap has been already an important issue. In this study, the HIPVs that hanged 2 meters high could be tested by hanging in other altitudes to reach the highest number of captures.

### Conclusions

During the experiment, the highest peak of adult captures occurred in benzaldehyde traps on 23 May (12 individual/per trap), 6 Jun (4 individual/per trap), 13 Jun (5 individual/per trap) and farnesene traps on 23 May (5 individual/per trap). This study seems to be quite effective at pulling in *A. (A.) anatolica anatolica* by benzaldehyde baited traps. This case is promising since benzaldehyde baited yellow sticky traps can be used to collect and monitoring the adult species. May be this combination will be examined for other buprestids of such harmful species *Agrilus* sp. and *C. tenebrionis* whom no effective control methods are currently available and they are important agricultural pests.

### Acknowledgements

Our special thanks to Mark Volkovitch (Zoological Institute, Academy of Sciences USSR GUS-199034 Leningrad, Russia) and Dr. S. Bily (Prague- The Czech Republic) for identifying and confirmation of *A. (A.) anatolica anatolica*. We thank the Uludag University Scientific Research Project Unit - Turkey (Project Grant No. UAP (Z) - 2010/45) for fund.

### References

- Bily S. (1984). Taxonomical and biological notes on Buprestidae from Turkey (Coleoptera). *Türkiye Bitki Koruma Dergisi*, 143-149.
- Bily S. (1997). World Catalogue of genus *Anthaxia* Eschscholtz, 1829 (Coleoptera, Buprestidae). *Folia Heyrovskyana*, 2, 190.
- Crook D.J., Krimian A., Francese J., Fraser I., Poland T.M., Sawyer A.J. and Mastro V.C. (2008). Development of a host-based semiochemical lure for trapping emerald ash borer *Agrilus planipennis* (Coleoptera: Buprestidae). *Environmental Entomology*, 37, 356-365.
- Curletti G. (1994). I Buprestidi d'Italia. Catalogo, Tassonomico, Sinonimica, Biologico, Geonemico. *Monografie di Natura Bresciana*, 19, 318.
- Francese J.A., Oliver J.B., Fraser I., Lance D.R., Youssef N., Sawyer A.J. and Mastro V.C. (2008). Influence of trap placement and design on capture of the emerald ash borer (Coleoptera: Buprestidae). *Journal of Economic Entomology*, 101, 1831-1837.
- Gaquerel E., Weinhold A. and Baldwin I.T. (2009). Molecular interactions between the specialist herbivore *Manduca sexta* (Lepidoptera, Sphingidae) and its natural host *Nicotiana attenuata*. VIII. An unbiased GCxGC-ToFMS analysis of the plants elicited volatile emissions. *Plant Physiology*, 149, 1408-1423.

- Haak R.A., Slansky F. (1987). Nutritional ecology of wood feeding Coleoptera, Lepidoptera, and Hymenoptera. In: Slansky F. and J.G. Rodriguez (eds): Nutritional Ecology of Insects, Mites and Spiders, and related invertebrates. John Wiley, New York, 449–486.
- Han B., Chen Z. (2002). Behavioral and electrophysiological responses of natural enemies to synomones from tea shoots and kairomones from tea aphids, *Toxoptera aurantii*. *Journal of Chemical Ecology*, 28, 2203–2219.
- James D.G. (2005). Further field evaluation of synthetic herbivore-induced plant volatiles as attractants for beneficial insects. *Journal of Chemical Ecology*, 31, 493-508.
- Kaplan I. (2012). Attracting carnivorous arthropods with plant volatiles: The future of biocontrol or playing with fire? *Biological Control*, 60, 77-89.
- Karaman Ş., Tezcan S. (1998). Contribution to the study of the genus *Anthaxia* (subgenus *Anthaxia* s.str.) Eschscholtz, 1829 (Coleoptera: Buprestidae) of Turkey. *Türkiye Entomoloji Dergisi*, 22(1), 19-35.
- Lelito J.P., Fraser I., Mastro V.C., Tumlinson J.H. and Baker T.C. (2008). Novel visual-cue-based sticky traps for monitoring of emerald ash borers, *Agrilus planipennis* (Col., Buprestidae). *Journal of Applied Entomology*, 132, 668-674.
- Leskey T.C., Wright S.E. (2004). Monitoring Plum Curculio, *Conotrachelus nenuphar* (Coleoptera: Curculionidae), populations in apple and peach orchards in the Mid-Atlantic. *Journal of Economic Entomology*, 97(1), 79-88.
- Levey B. (1977). Coleoptera Buprestidae Handbooks for the identification of British insects. Royal Entomological Society of London 5, 1-11.
- Lodos N., Tezcan S. (1992). Türkiye Buprestidae (Coleoptera) faunasının genel durumu ve zoocoğrafik yönden değerlendirilmesi. *Ege University, Ziraat Fakültesi Dergisi*, 29(1), 15-22.
- Mumm R., Dicke M. (2010). Variation in natural plant products and the attraction of bodyguards involved in indirect plant defense. *Canadian Journal of Zoology*, 88, 628-667.
- Prokopy R.J., Jacome I., Gray E., Trujillo G., Ricci M. and Pinero J. (2004). Using odor-baited trap trees as sentinels to monitor plum curculio (Coleoptera: Curculionidae) in apple orchards. *Journal of Economical Entomology*, 97, 511-517.
- Roditakis N.E., Lykouressis D.P. (1996). Prospects for the use of volatile chemicals and a new pyrrole in integrated pest management of western flower thrips. *Acta Horticulturae*, 431, 513-520.
- Rodriguez-Saona C., Blaauw B.R. and Isaacs R. (2012). Manipulation of natural enemies in agroecosystems: Habitat and semiochemicals for sustainable insect pest control, In M.L. Larramendy and S. Soloneski [Ed.], *Integrated Pest Management and Pest Control - Current and Future Tactics*, Intech electronic Books.
- Ryall K.L., Silk P.J., Mayo P., Crook D., Khrimian A., Cosse A.A., Sweeney J. and Scarr T. (2012). Attraction of *Agrilus planipennis* (Coleoptera: Buprestidae) to a volatile pheromone: Effects of release rate, host volatile, and trap placement. *Environmental Entomology*, 41(3), 648-656.
- Sun Y., Yu H., Zhou J.J., Pickett J.A. and Wu K. (2014). Plant volatile analogues strengthen attractiveness to insect. *Plos One*, 9(6), e99142.
- Ulay S.M., Tezcan S. (1998). Contribution to the study of the genus *Anthaxia* Eschscholtz, 1829 (subgenus *Haplanthaxia* Reitter, 1911) (Coleoptera: Buprestidae) of Turkey. *Türk Entomoloji Dergisi*, 22(2), 109-121.
- Volkovich M.G. (2006). Catalogue of Palaearctic Coleoptera. Buprestidea, *Apollo Books* 3: 417.



## POSTHARVEST QUALITY OF NON-ASTRINGENT ‘FUYU’ PERSIMMON FRUITS AS AFFECTED BY DIFFERENT DOSES OF 1-METHYLCYCLOPROPENE (1-MCP)

Adem DOGAN, Qasid ALI, Mehmet Seekin KURUBAS, Mustafa ERKAN\*

Department of Horticulture, Faculty of Agriculture, Akdeniz University, 07059 Antalya, Turkey

\*Corresponding author: erkan@akdeniz.edu.tr

### Abstract

Non-astringent ‘Fuyu’ persimmon fruits were harvested at optimal harvest maturity and randomly divided into four groups. The three groups of fruits were treated with 156.25, 312.5 and 625 ppb 1-MCP, respectively at 5°C for 24 h. The fourth group of fruits considered as control fruit. The treated and non-treated (control) fruits were stored at 0±1°C and 90±5% relative humidity for 3 months. After the cold storage, fruits were also kept at 20°C for additional 3 days to simulate their shelf-life period. Fruits were removed from different storage conditions at 30 days intervals and weight loss, fruit firmness, skin colour, soluble solids, titratable acidity and decay development during storage were studied. Furthermore, respiration rate and ethylene production of persimmon fruits were also recorded. The lowest weight loss, decay development, respiration rate, ethylene production and the maximum titratable acidity, fruit firmness, L\*, h° and C\* values were recorded in the fruits treated with 625 ppb 1-MCP. The fruits treated with the highest 1-MCP dose (625 ppb) showed better performance as compared with other 1-MCP treatments in terms of keeping the best postharvest quality of persimmon fruits during cold storage and shelf life conditions. On the basis of our results it is recommended to use 625 ppb 1-MCP for obtaining better postharvest quality in non-astringent ‘Fuyu’ persimmon fruits during long term storage.

**Keywords:** *Persimmon, storage, quality, shelf life, ethylene, respiration*

### Introduction

Fruits and vegetables play a vital role in human diet and regular consumption of these commodities help in decreasing the risk of cancer, cardiovascular, Alzheimer diseases and slow down the factors involved in aging (Liu, 2013). According to statistics of 2014, the production of persimmon constitutes 5.190.624 ton/year. China ranks 1<sup>st</sup> place and South Korea stood at 2<sup>nd</sup> with share of 73.3% and 8.3% in world production, respectively (Anonymous, 2014a). Researches on how to increase persimmon production in Turkey is still ongoing. According to 2014, the cultivated persimmon growing area in Turkey is 2.062 ha with production of 33.470 ton/year (Anonymous, 2014b). As the production increase it needs to find out the best storage conditions of persimmon fruits to regulate its long term storage and marketing. The main postharvest problems of persimmon fruits are their relatively short shelf-life period and quality losses (weight loss, bruising, blemishing, fruit softening, etc.) after harvest which decreases the marketing value and shorten its storage period. Like all other horticultural crops, persimmon fruits should be cooled as soon as possible to maintain its postharvest quality. On the other hand, it is also possible to decrease these losses by using appropriate postharvest applications (Yildiz *et al.*, 2002). The storage period of fruits after harvest varies due to the production of ethylene. 1-Methylcyclopropene (1-MCP) that reduces the effects of ethylene has been used on fruits, vegetables and ornamental plants against ripening and senescing. The influence of 1-MCP varies from species, variety and storage

conditions (normal atmosphere, modified atmosphere, control atmosphere and dynamic control atmosphere). According to Watkins and Miller (2005), 1-MCP decelerates ethylene production, respiration rate, colour changes, softening, ripening and senescence. Deterioration rate in horticultural crops is closely related to temperature and respiration rate (Kader, 2002). Kilinc and Cakli (2001) reported that, cold storage is the most reliable technique to preserve the quality of fresh produces. Many studies have been conducted regarding temperature conditioning, 1-MCP treatment, MAP and CA storage. But, there still exist the need to know about postharvest physiology of persimmon fruits. So, the objective of this research was to find out the optimum 1-MCP dose during long term storage of persimmon fruit to maintain its postharvest quality.

### **Materials and methods**

‘Fuyu’ variety of persimmon was used in the experiment. Fruits were harvested at optimal harvest maturity in Denizli, Turkey and immediately transported to Akdeniz University, Department of Horticulture postharvest physiology laboratory for storage operations. After cooling, fruits were randomly divided into four groups. Three doses (156.25, 321.5 and 625 ppb) of 1-MCP (Smartfresh™) and control groups were tested. For 1-MCP treatment, persimmon fruits of each treatment were kept in gas tight containers of 1m<sup>3</sup> volume in plastic crates. Fruits were treated with 1-MCP for 24 hours at 5°C. After treatments, fruit stored at 0-1°C temperature and 90-95% relative humidity for 3 months. Different physiological and chemical analysis was conducted at the interval of 30 days.

For weight losses, persimmon fruits were weighed before storage with the digital scale of 0.01 g sensitivity. During the storage period, fruits were re-weighed again and weight loss was calculated as a percentage of the initial weight. Digital refractometer was used to measure the amount of total soluble solids (TSS) and TSS was expressed as a percentage. For titratable acidity (TA), 2 ml juice+38 ml distilled water titrated with 0.1 N NaOH by using pH meter and calculated as % malic acid/100 ml juice. Fruit firmness was measured by peeling of fruit at three different equatorial sections with the help of Olcweuiz Guss fruit texture analyzer with 7.9 mm plunger. Measured values were expressed in Newton (N). Variations in fruit colour were recorded with the help of Minolta CR-400 branded (MINOLTA Camera Co, LTD Ramsey, NJ) instrument. The results were determined as L, Chroma (C\*) and Hue angle ( $h^\circ$ ). Amount of decayed fruits were observed with visual observation and numbers given as percentage.

The respiration rate and ethylene production of fruits were determined at the interval of two days by using a Gas Chromatography (GC) (Thermo Electron S.p.A., Strada Rivoltana, Milan, Italy). For that purpose, fruits of known volume and weight were kept in air-tight containers having a volume of 5 L for 1 hour at 20°C temperature. Sample of 1ml gas were taken through a gas-tight syringe from the headspace of air tight container and injected into the GC for analysis of ethylene and respiration. External standards were used for the quantification of the resulted peaks. Measurement of quality attributes was done at day 0, 60 and 90. Furthermore, after each storage period, fruits were removed and kept at 20°C for 3 days to simulate a performance of shelf life. Completely Randomized Design was used with three replications and each replication contained 15 fruits. Duncan’s test was conducted for comparing means varied significant or non-significant. Values obtained were evaluated with SAS program.

## Results and Discussion

### Weight loss

Statistical significance of different doses of 1-MCP on weight losses was recorded. On 30<sup>th</sup> day of storage 2.46% weight loss was noted which increased to 4.93% after 90<sup>th</sup> day of storage, means that rises in weight losses occurred in parallel with storage extension. Control fruits had the highest weight loss with 5.51%. 1-MCP treatments decreased the weight losses as compared to control. The use of 625 ppb 1-MCP had the lowest weight loss with 2.61% (Table 1). The similar trend was obtained in shelf-life conditions as well where control group had the maximum weight losses with 6.83% and 625 ppb 1-MCP treatment had the lowest weight loss (3.42%). During storage increases in weight loss occurs due to respiration and loss of water (Yener, 2013). Use of 1-MCP decelerated weight losses in our study. The reason of this could be 1-MCP may have been slow down the respiration of the fruits.

### Total soluble solids (TSS)

Effects of 1-MCP treatments on TSS were found to be statistically significant. Initial value for TSS was 15.39% at harvest. At 30 and 90 days of storage showed decrease to 14.44% and 15.36%, respectively. Comparing to control group 1-MCP treatment slowed down the decrease of TSS. Control group had the lowest amount of TSS with 14.13%. Effects of 1-MCP doses on TSS were found to be statistically significant as well. TSS was 15.39% at harvest and declined to 14.76% at the end of 90+3 days shelf-life period. During shelf life period no statistical differences were found among 1-MCP doses (Table 2). Wright and Kader (1997) reported that the use of 1-MCP played an effective role in preserving amount of TSS which is related to slowing down the respiration rate and water loss. On this aspect, our findings were in agreement with Kuzucu and Kaynas (2002).

### Titrateable acidity (TA)

The effect of 1-MCP doses on the amount of TA has been found statistically significant. Decreases in TA were observed with the extension of storage duration (Table 1). Initial TA of the fruits at harvest was 0.143% (as malic acid) and reduced to 0.074% at the end of the storage. 625 ppb 1-MCP had the maximum TA (0.105%) whereas control group had the lowest amount of TA with 0.098%. Amount of TA at harvest was 0.143% and during the 60+3 days storage there were a decrease (0.068%) and then an increase to 0.080% of TA was observed at 90+3 days of storage in shelf-life conditions (Table 2). No statistical difference was found among the 1-MCP doses and 156.25 ppb dose of 1-MCP had the lowest TA (0.085%) during at shelf-life. Decreases in the amount of TA and decomposition of organic acids during storage due to respiration were observed by Echeverria and Valich (1989). Guillén *et al.* (2006) reported that sugar and organic acids concentration in the fruits and vegetables are affected by ethylene production during storage. The results of these researchers were in agreement with the findings of our study.

### Fruit firmness

Initial firmness of fruits at harvest was 108.52 N and declined to 33.49 N after 90 days of storage. Fruits treated with 625 ppb 1-MCP were more firmer (74.13 N) than the control group which recorded 46.3 N (Table 1). Fruit firmness at harvest was 108.52 N and declined to 23.21 N after 90+3 days of shelf-life conditions. 1-MCP dose of 625 ppb had the highest fruit firmness of 60.09 N followed by 312.5 ppb 1-MCP. The lowest fruit firmness of 42.60 N was noted in control fruits (Table 2). The fruit firmness showed a decrease with ripening and prolonging storage duration which showed similarity with the observations found by Ozdemir *et al.* (2009). Karacali (2012) also explained this reduction in fruit firmness and he stated that because of cells enlargement and intercellular spaces, the breakdown of pectin, hemicelluloses and the decrease in resistance of cell wall may have resulted fruit firmness. Significant effect of 1-MCP was found in preservation of fruit firmness. The treatments

resulting slowing down the respiration and decreasing the weight loss showed positive effects on maintaining fruit firmness.

#### **Fruit colour ( $L^*$ , $h^\circ$ , $C^*$ )**

Decreases in  $L^*$  values occurred with prolonging the storage duration. The  $L^*$  values of persimmon fruits at harvest was 61.55 and declined to 52.28 by 90 days of cold storage. The maximum  $L^*$  value of 58.77 was recorded in 625 ppb 1-MCP treated fruit and the control group had the minimum  $L^*$  value of 55.63 (Table 1). Extending in storage period resulted in declining  $L^*$  values. The  $L^*$  value of fruits at harvest was 61.55 and decreased to 51.35 after 90+3 days of shelf life conditions. 625 ppb 1-MCP treatment had the highest  $L^*$  value which was 56.63 and the lowest  $L^*$  was 53.77 in control group (Table 2).

Prolonging storage duration induced a decrease in  $h^\circ$ . The  $h^\circ$  at harvest was 79.46° and reduced to 67.46° at 90 days of storage period. 1-MCP dose of 625 ppb gave the highest  $h^\circ$  value of 74.42° whereas the lowest  $h^\circ$  was recorded in control group which was 69.43 (Table 1). Storage duration and 1-MCP doses had statistically significant on  $h^\circ$  values. The 1-MCP dose of 625 ppb had the highest  $h^\circ$  value of 71.46° while the lowest  $h^\circ$  value of 68.01° was noted in control group (Table 2). Storage duration significantly affected  $C^*$  values. During storage period, reduction in  $C^*$  values occurred and  $C^*$  value of 59.03 were noted initially and then decreased to 51.10 by 90 days of storage. 1-MCP dose 625 ppb had the highest  $C^*$  value of 56.49 while control group gave the lowest  $C^*$  value of 54.26 (Table 1). In shelf-life conditions,  $C^*$  value of 59.03 were noted initially and reduced to 46.72 by 90+3 days of storage. 625 ppb dose of 1-MCP had the maximum  $C^*$  value of 53.42 whereas minimum  $C^*$  value of 48.70 was noted in control fruit (Table 2). Extension in storage period resulted in reduction of  $L^*$ ,  $C^*$  and  $h^\circ$  values of skin colour. During the storage of fruits changes in colour from green-orange to orange was observed. The results reported by Yener (2013) were in parallel with our results regarding the importance of 1-MCP application in maintaining effects of skin colour. Koyuncu *et al.* (2005) reported that darkening in colour was attained by MAP treatment during storage. Kuzucu and Kaynas (2002) stated that different packaging treatments effected the storage duration, ripening and quality of persimmon fruits. They also reported the fluctuations in skin colour during storage. Their findings were in agreement with the results of our study. Besada *et al.* (2010) reported that prolonging the storage duration resulted a decrease in  $h^\circ$  values of persimmon fruit. According to Woolf *et al.* (1997)  $L^*$ ,  $C^*$  and  $h^\circ$  values show a decrease during persimmon storage and our results was in parallel with the findings of their experimental results.

#### **Decay development**

Increases in the amount of decayed fruits were observed in the study and decay injury was 10.59% at 90 days of storage. Control group had the maximum decayed fruit of 10.08% followed by 7.19% noted in 312.5 ppb dose of 1-MCP. 625 and 312.5 ppb 1-MCP applications had the lowest deteriorated fruits comparing to control group (Table 1). During shelf-life conditions the effect of 1-MCP doses on decay development was statistically significant. Storage extension resulted an increase in the amount of decayed fruits that reached to 8.94% and 16.93% by the end of 60+3 and 90+3 days of shelf-life, respectively. Control group had the maximum (15.89%) of decay, followed by 312.5 ppb dose of 1-MCP with 11.18% (Table 2). Sakaldas (2014) studied the effects of different doses of 1-MCP on postharvest quality in 'Deveci' pears and he reported that 625 ppb and 1250 ppb doses of 1-MCP gave better results in terms of preventing decay development in pears.

**Table 1.** The effects of different 1-MCP doses on some quality parameters of ‘Fuyu’ persimmon fruits stored at 0°C

Texting index	Treatments	Storage time (Days)				Mean (Treat.)
		0	30	60	90	
<b>Weight loss (%)</b>	625 ppb	-	1.72	2.55	3.55	<b>2.61d<sup>1</sup></b>
	312.5 ppb	-	2.01	3.45	4.16	<b>3.21c</b>
	156.25 ppb	-	2.50	3.90	4.75	<b>3.72b</b>
	Control	-	3.60	5.67	7.26	<b>5.51a</b>
	<b>Mean (Sto. time)</b>	-	<b>2.46c</b>	<b>3.89b</b>	<b>4.93a</b>	
<b>TSS (%)</b>	625 ppb	15.39	14.17	15.25	15.90	<b>15.18b</b>
	312.5 ppb	15.39	14.50	16.15	16.75	<b>15.70a</b>
	156.25 ppb	15.39	15.03	15.10	15.35	<b>15.22b</b>
	Control	15.39	14.07	13.62	13.45	<b>14.13c</b>
	<b>Mean (Sto. time)</b>	<b>15.39a</b>	<b>14.44c</b>	<b>15.03b</b>	<b>15.36a</b>	
<b>TA (%)</b>	625 ppb	0.143	0.121	0.080	0.075	<b>0.105a</b>
	312.5 ppb	0.143	0.101	0.084	0.072	<b>0.100bc</b>
	156.25 ppb	0.143	0.101	0.089	0.078	<b>0.103ab</b>
	Control	0.143	0.099	0.079	0.071	<b>0.098c</b>
	<b>Mean (Sto. time)</b>	<b>0.143a</b>	<b>0.106b</b>	<b>0.083c</b>	<b>0.074d</b>	
<b>Fruit firmness (N)</b>	625 ppb	108.52	73.94	59.95	54.13	<b>74.13a</b>
	312.5 ppb	108.52	53.08	44.65	38.83	<b>61.27b</b>
	156.25 ppb	108.52	45.57	37.07	27.69	<b>54.71c</b>
	Control	108.52	37.23	26.64	13.31	<b>46.43d</b>
	<b>Mean (Sto. time)</b>	<b>108.52a</b>	<b>52.45b</b>	<b>42.08c</b>	<b>33.49d</b>	
<b>L*</b>	625 ppb	61.55	60.17	58.63	54.72	<b>58.77a</b>
	312.5 ppb	61.55	58.82	56.08	52.59	<b>57.26b</b>
	156.25 ppb	61.55	57.51	55.17	51.44	<b>56.42c</b>
	Control	61.55	56.27	54.34	50.37	<b>55.63d</b>
	<b>Mean (Sto. time)</b>	<b>61.55a</b>	<b>58.19b</b>	<b>56.06c</b>	<b>52.28d</b>	
<b>h°</b>	625 ppb	79.46	75.46	72.27	70.48	<b>74.42a</b>
	312.5 ppb	79.46	72.92	68.59	67.99	<b>72.24b</b>
	156.25 ppb	79.46	71.35	67.93	66.71	<b>71.36b</b>
	Control	79.46	68.56	65.09	64.63	<b>69.43c</b>
	<b>Mean (Sto. time)</b>	<b>79.46a</b>	<b>72.07b</b>	<b>68.47c</b>	<b>67.46c</b>	
<b>C*</b>	625 ppb	59.03	58.40	54.36	54.15	<b>56.49a</b>
	312.5 ppb	59.03	57.01	53.62	51.25	<b>55.23b</b>
	156.25 ppb	59.03	57.29	53.73	50.14	<b>55.05b</b>
	Control	59.03	56.37	52.75	48.88	<b>54.26c</b>
	<b>Mean (Sto. time)</b>	<b>59.03a</b>	<b>57.27b</b>	<b>53.62c</b>	<b>51.10d</b>	
<b>Decayed fruit (%)</b>	625 ppb	-	0.00	0.00	2.89	<b>0.96c</b>
	312.5 ppb	-	0.00	2.89	9.86	<b>4.25bc</b>
	156.25 ppb	-	0.00	8.22	13.34	<b>7.19ab</b>
	Control	-	0.00	13.99	16.26	<b>10.08a</b>
	<b>Mean (Sto. time)</b>	-	<b>0.00b</b>	<b>6.28a</b>	<b>10.59a</b>	

TSS, total soluble solids; TA, titratable acidity; h°, hue angle; C\*, Chroma; L\*, Lightness, Sto.: storage

<sup>1</sup>The values within a column and row with different letters are significantly different at P ≤ 0.05 according to the Duncan's multiple range test.

**Table 2.** The effects of different 1-MCP doses on some quality parameters of ‘Fuyu’ persimmon fruit kept at 20°C for 3 days (at shelf-life)

Texting index	Applications	Storage time (Days)				Mean (Treat.)
		0	30+3	60+3	90+3	
<b>Weight loss (%)</b>	625 ppb	-	2.59	3.25	4.43	<b>3.42d<sup>1</sup></b>
	312.5 ppb	-	3.06	4.12	5.71	<b>4.29c</b>
	156.25 ppb	-	3.46	4.78	6.13	<b>4.79b</b>
	Control	-	4.74	7.03	8.71	<b>6.83a</b>
	<b>Mean (Sto. time)</b>	-	<b>3.46c</b>	<b>4.80b</b>	<b>6.24a</b>	
<b>TSS (%)</b>	625 ppb	15.39	14.63	15.55	15.35	<b>15.23a</b>
	312.5 ppb	15.39	15.07	15.60	14.85	<b>15.23a</b>
	156.25 ppb	15.39	14.50	15.25	15.55	<b>15.17a</b>
	Control	15.39	13.67	13.55	13.30	<b>13.98b</b>
	<b>Mean (Sto. time)</b>	<b>15.39a</b>	<b>14.47c</b>	<b>14.99b</b>	<b>14.76b</b>	
<b>TA (%)</b>	625 ppb	0.143	0.085	0.071	0.084	<b>0.096a</b>
	312.5 ppb	0.143	0.097	0.062	0.079	<b>0.095a</b>
	156.25 ppb	0.143	0.070	0.063	0.079	<b>0.089b</b>
	Control	0.143	0.085	0.075	0.078	<b>0.095a</b>
	<b>Mean (Sto. time)</b>	<b>0.143a</b>	<b>0.084b</b>	<b>0.068c</b>	<b>0.080b</b>	
<b>Fruit firmness (N)</b>	625 ppb	108.52	52.82	45.73	33.31	<b>60.09a</b>
	312.5 ppb	108.52	42.26	37.36	27.69	<b>53.96b</b>
	156.25 ppb	108.52	38.50	28.54	19.61	<b>48.79c</b>
	Control	108.52	29.55	20.10	12.25	<b>42.60d</b>
	<b>Mean (Sto. time)</b>	<b>108.52a</b>	<b>40.78b</b>	<b>32.93c</b>	<b>23.21d</b>	
<b>L*</b>	625 ppb	61.55	56.15	55.19	53.64	<b>56.63a</b>
	312.5 ppb	61.55	54.64	54.29	51.78	<b>55.57b</b>
	156.25 ppb	61.55	53.33	54.54	50.96	<b>55.10b</b>
	Control	61.55	52.97	51.57	49.00	<b>53.77c</b>
	<b>Mean (Sto. time)</b>	<b>61.55a</b>	<b>54.27b</b>	<b>53.90b</b>	<b>51.35c</b>	
<b>h°</b>	625 ppb	79.46	70.85	68.89	66.64	<b>71.46a</b>
	312.5 ppb	79.46	68.75	67.01	65.35	<b>70.14b</b>
	156.25 ppb	79.46	67.89	66.33	64.09	<b>69.44b</b>
	Control	79.46	66.93	63.88	61.79	<b>68.01c</b>
	<b>Mean (Sto. time)</b>	<b>79.46a</b>	<b>68.60b</b>	<b>66.53c</b>	<b>64.47d</b>	
<b>C*</b>	625 ppb	59.03	52.31	52.05	50.29	<b>53.42a</b>
	312.5 ppb	59.03	47.02	47.60	46.37	<b>50.00b</b>
	156.25 ppb	59.03	47.85	46.82	45.79	<b>49.87bc</b>
	Control	59.03	45.84	45.50	44.45	<b>48.70c</b>
	<b>Mean (Sto. time)</b>	<b>59.03a</b>	<b>48.26b</b>	<b>47.99b</b>	<b>46.72c</b>	
<b>Decayed fruit (%)</b>	625 ppb	-	0.00	0.00	5.67	<b>1.89c</b>
	312.5 ppb	-	0.00	5.54	11.09	<b>5.54bc</b>
	156.25 ppb	-	0.00	10.89	22.65	<b>11.18ab</b>
	Control	-	0.00	19.33	28.33	<b>15.89a</b>
	<b>Mean (Sto. time)</b>	-	<b>0.00c</b>	<b>8.94b</b>	<b>16.93a</b>	

TSS, total soluble solids; TA, titratable acidity; h°, hue angle; C\*, Chroma; L\*, Lightness, Sto.: storage  
<sup>1</sup>The values within a column and row with different letters are significantly different at P ≤ 0.05 according to the Duncan's multiple range test.

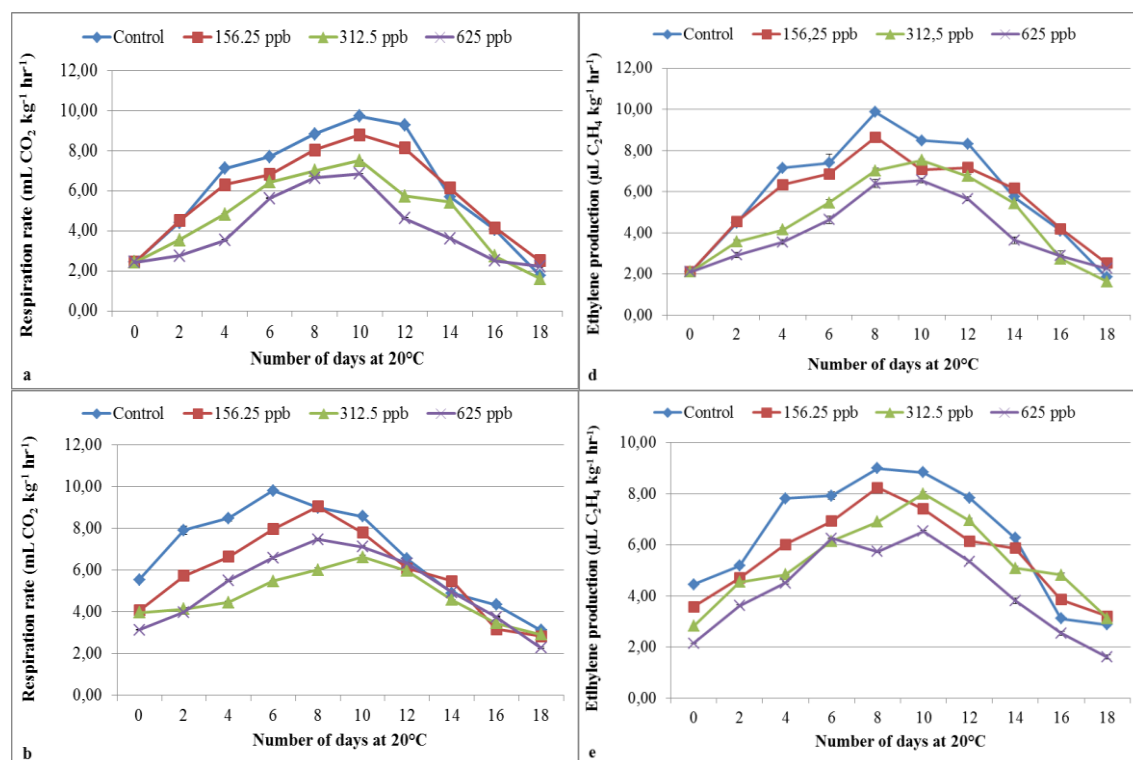
### Respiration rate (CO<sub>2</sub> production)

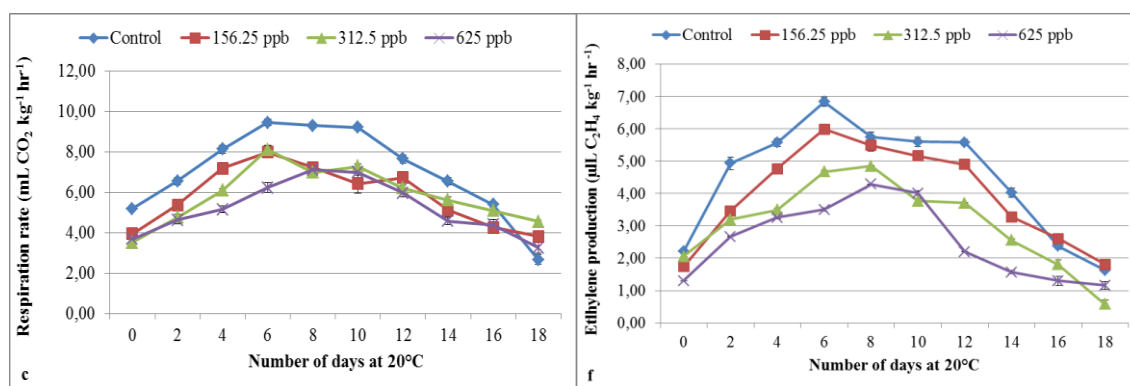
All the treatments reached to maximum climacteric on the 10<sup>th</sup> day of storage. The control group produced maximum CO<sub>2</sub> (9.74 ml CO<sub>2</sub> kg<sup>-1</sup>hr<sup>-1</sup>) while 1-MCP treatment of 625 ppb had the minimum CO<sub>2</sub> production (6.85 ml CO<sub>2</sub> kg<sup>-1</sup>hr<sup>-1</sup>) as shown in Figure 1a. Variations in CO<sub>2</sub> production occurred at the 60 days of storage at 0°C (Fig. 1b). Control fruit had the maximal respiration on 6<sup>th</sup> day, 156.25 ppb had maximum respiration on 8<sup>th</sup>, whereas 312.5 ppb and 625 ppb 1-MCP treated fruits had climacteric maximum on 10<sup>th</sup> day of storage. The

highest respiration rate was calculated in control group. CO<sub>2</sub> production in ‘Fuyu’ fruits treated with different levels of 1-MCP doses and stored at 0°C for 90 days were shown in Figure 1c. Control, 156.25 and 312.5 ppb 1-MCP doses attained climacteric maximum on 6<sup>th</sup> day of storage whereas 625 ppb dose of 1-MCP had maximum climacteric on 8<sup>th</sup> day of storage. Control group had the highest respiration rate (9.46 ml CO<sub>2</sub> kg<sup>-1</sup>hr<sup>-1</sup>) compared to 1-MCP treated fruits. Fruits of 625 ppb 1-MCP dose recorded the lowest respiration rate (7.12 ml CO<sub>2</sub> kg<sup>-1</sup>hr<sup>-1</sup>). In general, the fruits treated with 1-MCP decreased the CO<sub>2</sub> production. Similarly, 1-MCP treatments resulted a decrease in CO<sub>2</sub> production as compared to the control group this means that 1-MCP plays an effective role in increasing the shelf-life of ‘Fuyu’ persimmons. During storage, 625 ppb 1-MCP exhibited the lowest CO<sub>2</sub> production among the treated groups.

### Ethylene (C<sub>2</sub>H<sub>4</sub>) production

Fruits treated with 156.25 ppb 1-MCP and control group gave the maximum C<sub>2</sub>H<sub>4</sub> production on 8<sup>th</sup> day while fruits treated with 312.5 and 625 ppb 1-MCP doses reached a peak on 10<sup>th</sup> day. The control group had the highest (9.86 μL C<sub>2</sub>H<sub>4</sub> kg<sup>-1</sup>hr<sup>-1</sup>) and 625 ppb dose of 1-MCP had the lowest (6.55 μL C<sub>2</sub>H<sub>4</sub> kg<sup>-1</sup>hr<sup>-1</sup>) C<sub>2</sub>H<sub>4</sub> production as shown in Figure 1d. Control and 156.25 ppb 1-MCP treatment groups produced the highest amount of C<sub>2</sub>H<sub>4</sub> on 8<sup>th</sup> day while 312.5 and 625 ppb 1-MCP doses had the highest C<sub>2</sub>H<sub>4</sub> production on 10<sup>th</sup> day. At 60<sup>th</sup> day of storage, maximum (8.99 μL C<sub>2</sub>H<sub>4</sub> kg<sup>-1</sup>hr<sup>-1</sup>) C<sub>2</sub>H<sub>4</sub> production was in control group and 1-MCP dose of 625 ppb had the minimum (6.53 μL C<sub>2</sub>H<sub>4</sub> kg<sup>-1</sup>hr<sup>-1</sup>) C<sub>2</sub>H<sub>4</sub> production (Fig. 1e). At 90<sup>th</sup> day of storage, C<sub>2</sub>H<sub>4</sub> production reached a peak in control fruits and 156.25 ppb 1-MCP dose reached on 6<sup>th</sup> day whereas 312.5 and 625 ppb 1-MCP doses had maximum C<sub>2</sub>H<sub>4</sub> productions on 8<sup>th</sup> day (Fig. 1f) Control group had maximum C<sub>2</sub>H<sub>4</sub> production (6.84 μL C<sub>2</sub>H<sub>4</sub> kg<sup>-1</sup>hr<sup>-1</sup>) while 625 ppb of 1-MCP dose was noted to have minimum (4.29 μL C<sub>2</sub>H<sub>4</sub> kg<sup>-1</sup>hr<sup>-1</sup>) C<sub>2</sub>H<sub>4</sub> production.





**Figure 1.** Effects of different 1-MCP doses on respiration rate (a: day 0, b: day 60, c:90 day) and ethylene production (d: day 0, e: day 60, f: day 90) in ‘Fuyu’ persimmon fruits at different storage periods.

### Conclusions

1-MCPTreatments in persimmon fruits reduced weight loss, maintained total soluble solids content, titratable acidity, skin colour and slowed down the rate of respiration and ethylene production. According to the findings obtained, 625 ppb dose of 1-MCP was found to be the most appropriate dose in keeping the best quality of ‘Fuyu’ persimmons during the long term storage.

### References

- Anonymous (2014a). <http://www.fao.org/faostat/en/#data/QC>. (Accessed: July 2017).
- Anonymous (2014b).<http://rapory.tuik.gov.tr/07-07-2017-17:31:261870833349513245616765422563.html>. (Accessed: July 2017).
- Besada C., Jackman R.C., Olsson S., Woolf A.B. (2010). Response of Fuyupersimmons to ethylene exposure before and during storage. *Postharvest Biology and Technology*, 57(2), 124-131.
- Echeverria E., Valich J. (1989). Enzymes of sugar and acid metabolism in stored Valencia oranges. *Journal of the American Society for Horticultural Science*, 114, 445–449.
- Guillén F., Castillo S., Zapata P.J., Martínez-Romer D., Serrano M., Valero D. (2006). Efficacy of 1-MCP treatment in tomato fruit. 2. Effect of cultivar and ripening stage at harvest. *Agricultural and Forest Meteorology*, 42, 235-242.
- Kader A.A. (2002). *Postharvest Technology of Horticultural Crops*, Regents of the University of California, Division of Agricultural and Natural Resources, Oakland, CA, USA.
- Karacali I. (2012). Storage and marketing of horticultural products. Ege University, Faculty of Agriculture, Bornova/İzmir, 494, 486.
- Kilinc B., Çakli Ş. (2001). Effects of packaging techniques on microbial flora of fish and shellfish. *Ege Journal of Fisheries and Aquatic Sciences*, 18, (1-2), 279-291.
- Koyuncu M.A., Savran E., Dilmaçunal T., Kepenek K., Cangı R., Çağatay Ö. (2005). Cold storage of some varieties of persimmon. *Akdeniz University Journal of the Faculty of Agriculture*, 18(1), 15-23.
- Kuzucu F.C., Kaynaş K. (2002). The effect of different packaging types on storage duration, maturity and quality in persimmon. II. Bahçe Ürünlerinde Muhafaza ve Pazarlama Sempozyumu, Çanakkale, 240-248.
- Liu R.H. (2003). Health benefits of fruit and vegetables are from additive and synergistic combinations of phytochemicals. *The American journal of clinical nutrition*, 78(3), 517-520.



- Ozdemir A.E., Candir E.E., Toplu C., Kaplankiran M., Yildiz E., Inan C. (2009). The effects of hot water treatments on chilling injury and cold storage of Fuyu persimmons. *African Journal of Agricultural Research*, 10: 1058-1063.
- Sakaldas M. (2014). Effects of 1-methylcyclopropene applications on the postharvest quality of "Deveci" pear variety grown in Canakkale Region during storage. *COMU Journal of Agriculture Faculty*. 2 (1): 109–116.
- Watkins C.B., Miller W.B. (2005). 1-Methylcyclopropene (1-MCP) based Technologies for storage and shelf life extension. *ActaHortic.*, 687: 217-224.
- Woolf A.B., Ball S., Spooner K.J., Lay-Yee, M., Ferguson I. B., Watkins C. B., Forbes S.K. (1997). Reduction of chilling injury in the sweet persimmon Fuyu' during storage by dry air heat treatments. *Postharvest Biology and Technology*, 11(3), 155-164.
- Yildiz M., Kinay P., Yildiz F. (2002). Standing of biological struggle in control of postharvest diseases and the situation in Turkey. II. Bahçe Ürünlerinde Muhafaza ve Pazarlama Sempozyumu, Çanakkale, 45 s.
- Yener T. (2013). Effect of different postharvest applications on the storage of persimmon (*Diospyros kaki L.*) Yüksek Lisans Tezi, Bahçe Bitkileri Anabilim Dalı Uludağ Üniversitesi, 149 s.

## IMPACT OF DIFFERENT DOSES OF 1-METHYLCYCLOPROPENE (1-MCP) ON POSTHARVEST QUALITY OF ASTRINGENT ‘HACHIYA’ PERSIMMONS

Qasid ALI, Adem DOGAN, Mehmet Seekin KURUBAS, Mustafa ERKAN\*

Department of Horticulture, Faculty of Agriculture, Akdeniz University, 07059 Antalya, Turkey

\*Corresponding author: erkan@akdeniz.edu.tr

### Abstract

Astringent ‘Hachiya’ persimmon fruits were harvested at optimal harvest maturity and divided into four groups for treatment with different 1-MCP doses. The following doses of 1-MCP 0 ppb (control), 156.25 ppb, 312.5 ppb and 625 ppb were tested for postharvest quality of ‘Hachiya’ persimmons. 1-MCP treatments were carried out at 5°C for 24 h. Treated and untreated (control) fruits were stored at 0±1°C and 90±5% relative humidity for 3 months. Fruits were held at 20°C for 3 days after the cold storage with the aim of determining the shelf-life performance. Fruits were removed from storage conditions at 30 days of intervals and weight loss, fruit firmness, skin colour, soluble solids content, titratable acidity, decay development during storage and shelf-life conditions were noted. Furthermore, respiration rate and ethylene production of persimmon fruits were also recorded. The fruits treated with the highest 1-MCP dose (625 ppb) gave better results regarding the lowest weight loss and decay development. The use of 625 ppb 1-MCP also resulted the highest soluble solids, fruit firmness, L\*, h° and C\* values, respectively, as compared to the other treatments during the cold storage and shelf-life. Minimum respiration rate and ethylene production were recorded in the fruits treated with 1-MCP dose of 625 ppb. Thus, it can be concluded that 625 ppb 1-MCP can be used for the effective treatment of astringent ‘Hachiya’ persimmons during 3 months cold storage.

**Keywords:** *Persimmon, postharvest, ethylene, respiration, 1-MCP*

### Introduction

Large number of fruits species can be grown in Turkey thanks to its geomorphologic, topographic and climatic advantages. Turkey is also the origin of many fruits and vegetables. Persimmon growing in Turkey is still in developmental stages concerning its production numbers. Persimmon is cultivated globally on 802.458 ha land with the production of 4.056.987 tons annually (Anonymous, 2014a). Persimmons are grown on 2.062 ha and its production constitutes 33.470 tons/year by the end of 2014 in Turkey (Anonymous, 2014b). Major importers of persimmon from Turkey are Kuwait, Jordan, Germany and Switzerland (Anonymous, 2012c). Despite increases in the production, persimmon fruits have some problems to overcome during the postharvest stages such as standardization, storage, marketing and transportation. The main postharvest problems of persimmon fruits are the short shelf life and quality losses including weight loss and fruit softening, etc. that decreases its marketing value and postharvest life. These postharvest problems can be reduced or overcome by using some postharvest treatments (Yildiz *et al.*, 2002). Many factors directly or indirectly contribute to the long or short life span of horticultural produces. Many techniques have been developed to decrease postharvest losses. The use of 1-MCP controls or slows down the negative effects of ethylene on fruit softening and ripening. Effects of 1-MCP vary from species, variety and storage conditions. 1-MCP retards ethylene and CO<sub>2</sub> production,

colour changes, softening, ripening and aging (Watkins and Miller, 2005). Cold storage technique have been the most effective and efficient method to maintain the quality of fresh fruits and vegetables (Kilinc and Cakli, 2001). Despite of improvement in the cultivation of persimmon, the problems like short shelf life, short marketing period and various factors (weight loss, fruit softening, changes in the skin and flesh of fruit, etc.) decrease its marketing value. Avoiding such problems and increasing the shelf life of this nutritious fruit will provide economic advantages and will allow emergence of new markets. Different studies being conducted on maintaining the postharvest life and preserving the quality of persimmon fruits. However, there is still need of enough research to be done. The objective of this study was to elucidate the postharvest performance of astringent 'Hachiya' persimmon fruits by using different 1-MCP doses.

### Materials and methods

The fruits were harvested at optimal maturity stage and 'Hachiya' persimmon fruits (*Diospyros kaki* L.) were used in the experiment. After pre-cooling the fruits were divided into four groups for postharvest treatments. The first, second and third group of fruits were treated with 156.25 ppb, 312.5 ppb and 625 ppb 1-MCP (SmartFresh™), respectively. Untreated fruits were considered as control group. For 1-MCP treatments, the fruits were kept in plastic crates in air tight containers having volume of 1m<sup>3</sup>. 1-MCP treatment was carried out at 5°C for 24 hours. After 1-MCP treatments the fruits were stored for 3 months at 0-1°C temperature with 90±95% relative humidity. Quality assessments were carried out at 30-day intervals for each replication of 8 fruits. After each storage period (30-day intervals), 12 fruits out of 24 were removed and kept at 20°C for 3 days to simulate a period of shelf-life and then analyzed. Weight losses of fruits were determined by using digital scale (sensitive to 0.01g) and weight losses were expressed in percentage. Total soluble solids (TSS) content were measured with a digital Refractometer (Hanna HI96801, Hanna Instruments, USA) and means were then calculated in percentage. Titratable acidity (TA) of juice samples was measured with a pH-meter (Inolab pH 720, WTW, Germany). TA was determined by titrating 2 mL of fruit juice in 38 mL of distilled water with 0.1 N NaOH to an end point of pH 8.1 and expressed as % malic acid/100 ml juice. Fruit firmness was measured with the help of fruit texture analyzer (plunger with 7.9 mm diameter) by peeling at three different equatorial sections of the fruit. The measured values were given in Newton (N). The changes in skin colour of the fruits were assessed by the help of Minolta CR-400 (MINOLTA Camera Co, LTD Ramsey, NJ) chromameter. The results were expressed as *L*\*, chroma (*C*\*) and Hue angle (*h*°). Decay development of fruits was observed through visual observation and the amount of fruits deteriorated were given in percentage. The respiration rate and ethylene production of fruits were determined at the interval of two days end of the 0, 60 and 90 days of storage by using a GC (Thermo Electron S.p.A., Strada Rivoltana, Milan, Italy). For that purpose fruits of known volume and weight were kept in air tight container with volume of 5 L for 1 hour at 20°C. Sample of 1ml headspace gas were taken through a gas-tight syringe from the atmosphere of air-tight container and injected into the GC for analysis of ethylene and CO<sub>2</sub>. Experiment was conducted according to completely randomized design with three replications and each replication had 8 fruits. Means were compared by using Duncan's test to find significant differences. The data obtained was evaluated by using SAS program.

## Results and Discussion

### Weight loss

Increases in weight losses occurred with the extension of storage duration. Mean value of 2.45% recorded for weight loss after storage of 30 days and increased to 5.98% at 90 days of storage (Table 1). The highest(5.67%)and the lowest(3.23%) mean values for weight losses were noted in control and 625 ppb 1-MCP treated fruits. Similarly, and additional3 days storage at shelf-life conditions resulted an increase in weight loss with maximum mean weight loss of 7.24% recorded in control group and the minimum mean weight loss (4.72%)found in 625 ppb 1-MCPdose (Table 2). Respiration and water loss results an increase in weight losses of fruits and vegetables (Yener, 2013). 1-MCP prevented weight losses in our study which could be because 1-MCP slows down the respiration rate of fruits.

### Total soluble solids (TSS)

TSS content increased from 17.57% to 19.02% and then a slight decrease to 15.64% was recorded after 0, 30 and 90 days of cold storage, respectively. Maximum mean (17.80%) of TSS followed by 17.55% was noted in 625 and 312.5 ppb1-MCP treated fruits compared to control (Table 1). Likewise, TSS content increased from 17.57% to 18.04% at 30+3 days, followed by a slight decrease in TSS of 15.25% then to 13.96% in 60+3 and 90+3 days of storage in shelf life conditions, respectively. The highest (17.33%) TSS in 625 ppb 1-MCP andthe lowest TSS (15.45%) wererecorded in control group (Table 2). 1-MCP was effective in maintenance of TSS content during storage and shelf life conditions. In our study the amount of TSS content decreased by the extension of storage period which was in agreement with the results of Kuzucu and Kaynas (2002).

### Titratable acidity (TA)

TA of the persimmon fruits declined with prolonging the storage duration. TA of fruits at harvest was 0.184%and decreased to 0.143, 0.111and 0.066% after 30, 60 and 90 days of storage, respectively (Table 1). The highest TA (0.130%) in 625 ppb and the lowest (0.119%) TA was calculated in 156.25 ppb 1-MCPTreated fruits. TA levels of the fruits reduced throughout the shelf life conditions as well. The TA content of the fruits at harvest was 0.184% and exhibit a decline to 0.108% followed by 0.085%, 0.050% 30+3, 60+3 and 90+3 days of storage at shelf-life, respectively. Maximum mean of TA (0.121%) in 625 ppb 1-MCP treatment and minimum TA (0.092%)was calculated in control group (Table 2).In our study, 1-MCP was effective in preservation of TA. Reduction in the amount of TA is related to the decomposition of organic acids during respiration (Echeverria and Valich, 1989). Guillen *et al.* (2006) observed that a rise in the ethylene production of fruits and vegetables affected the amount of sugar and organic acids. Results obtained by these researchers were also in parallel with our study.

### Fruit firmness

A decrease in fruit firmness was observed with 70.01 N at harvest and declined to 44.44 N followed by 27.43 N and 12.31 N at 30, 60 and 90 days of cold storage, respectively. The highest fruit firmness of 43.89 N in 625 ppb 1-MCP treated fruits whereas the lowest mean (34.34 N)was recorded in controlgroup (Table 1). In the same way, reduction in flesh firmness occurred with the extension of storage at shelf-life periods.Fruits of 625 ppb 1-MCP treatment were more firmer (30.49 N) thanthe control fruits observed to be less firmer (23.61 N) as shown inTable 2.Reduction in fruit firmness could be because of enlargement in cells, intercellular spaces, breakdown of pectin, hemicelluloses and diminishing resistance of wall (Karacali, 2012). 1-MCP was effective in keeping the fruit firmness. Slow respiration rate and low water loss were maintained in preserving the firmness of fruit.

### **Fruit colour ( $L^*$ , $h^\circ$ , $C^*$ )**

$L^*$  values of fruits declined with the extension of cold storage duration. Initial  $L^*$  value of fruits at harvest was 66.88 and decreased to 64.52 followed by 56.04, 50.70 at 30, 60 and 90 days of storage period, respectively. Maximum mean value of  $L^*$  was 61.10 in 625 ppb 1-MCP treatment while minimum mean value (58.00) was noted in control group. No significant difference was found between 156.25 ppb and 312.5 ppb doses of 1-MCP (Table 1). Similar trend was also found at shelf-life conditions.  $L^*$  value of fruits at harvest was 66.88 and decreased to 55.56, 52.52 and 47.57 after 30+3, 60+3 and 90+3 days of storage, respectively. Fruits with 625 ppb 1-MCP had the highest mean value (57.81) of  $L^*$  and the lowest mean value (52.92) was calculated in control group (Table 2).

Hue angle ( $h^\circ$ ) declined with the extension of storage duration. Hue angle value at harvest was  $82.99^\circ$  and declined to  $74.56^\circ$  followed by  $71.80^\circ$  and  $69.40^\circ$  at 30, 60 and 90 days of storage, respectively. The maximum mean value of  $76.86^\circ$  in 625 ppb 1-MCP treatment whereas minimum mean for  $h^\circ$  was  $72.47^\circ$  noted in control group (Table 1). In the same manner, reduction in  $h^\circ$  was observed during at shelf-life conditions. Initial  $h^\circ$  at harvest was  $82.99^\circ$  and declined to  $72.49^\circ$  followed by  $68.04^\circ$  and  $66.13^\circ$  by 30+3, 60+3 and 90+3 days of storage, respectively. The highest mean value ( $74.41^\circ$ ) was recorded in 625 ppb 1-MCP whereas the lowest ( $70.46^\circ$ ) for  $h^\circ$  was measured in control (Table 2).

Decrease in  $C^*$  values were noticed as the storage duration prolonged.  $C^*$  value recorded at harvest was 65.77 and reduced to 62.17, 50.51 and 40.86 at 30, 60 and 90 days of cold storage, respectively. The highest mean value for  $C^*$  was 56.81 in 625 ppb 1-MCP treatment while the lowest (52.22)  $C^*$  was noted in control group (Table 1). Likewise, decline in the values of  $C^*$  occurred in parallel to increase in shelf-life periods. Initial  $C^*$  value of fruits at harvest was 65.77 and reduced to 44.69 followed by 39.92 and 34.54 after 30+3, 60+3 and 90+3 days of storage, respectively. The maximum mean value of 49.15 for  $C^*$  in 625 ppb 1-MCP whereas the minimum  $C^*$  was noted in 43.03 in control group (Table 2). In our study prolonging storage duration showed a decline in  $C^*$ ,  $L^*$  and  $h^\circ$  values and a change in colour from green-orange to orange was noticed. MAP and cold storage treatment with extending storage durations resulted in dark skin colour in fruits (Koyuncu *et al.*, 2005). Kuzucu and Kaynas (2002) explained the effects of different types of packaging on storage duration, ripening and quality where they obtained fluctuated skin colour values during the storage.

### **Decay development**

No decay development occurred during the first 30 days of storage while 28.61% of decay was recorded at 90 days of cold storage. Generally, 1-MCP treated fruits had less decay development. Maximum decay percentage was 25.91% in control group whereas minimum decay injury of 5.84% calculated in 625 ppb 1-MCP treatment (Table 1). Increases in decayed fruits were observed in parallel with prolonging shelf-life periods. Mean for number of decayed fruits recorded after 30+3 days of shelf-life was 2.46% and rose to 19.34% followed by 47.82% at 60+3 and 90+3 days of shelf life periods, respectively (Table 2). Sakaldas (2014) reported that 625 and 1250 ppb 1-MCP treatment had a positive effect on preservation of postharvest quality of persimmon fruits.

**Table 1.** The effects of different 1-MCP doses on some quality parameters of ‘Hachiya’ persimmon fruits stored at 0°C

Texting index	Treatments	Storage time (Days)				Mean (Treat.)
		0	30	60	90	
Weight loss (%)	625 ppb	-	1.81	3.61	4.27	3.23d <sup>1</sup>
	312.5 ppb	-	2.24	4.64	5.56	4.15c
	156.25 ppb	-	2.58	5.12	6.28	4.66b
	Control	-	3.15	6.05	7.79	5.67a
	<b>Mean (Sto. time)</b>	-	<b>2.45c</b>	<b>4.86b</b>	<b>5.98a</b>	
TSS (%)	625 ppb	17.57	18.37	18.50	16.78	17.80a
	312.5 ppb	17.57	19.03	17.73	15.87	17.55a
	156.25 ppb	17.57	18.53	17.57	15.57	17.31ab
	Control	17.57	20.13	15.07	14.33	16.78b
	<b>Mean (Sto. time)</b>	<b>17.57b</b>	<b>19.02a</b>	<b>17.22b</b>	<b>15.64c</b>	
TA (%)	625 ppb	0.184	0.151	0.111	0.075	0.130a
	312.5 ppb	0.184	0.149	0.102	0.065	0.125ab
	156.25 ppb	0.184	0.140	0.098	0.054	0.119b
	Control	0.184	0.133	0.132	0.072	0.130a
	<b>Mean (Sto. time)</b>	<b>0.184a</b>	<b>0.143b</b>	<b>0.111c</b>	<b>0.066d</b>	
Fruit firmness (N)	625 ppb	70.01	49.58	38.77	17.20	43.89a
	312.5 ppb	70.01	45.86	27.64	12.91	39.11b
	156.25 ppb	70.01	43.46	23.34	10.59	36.85b
	Control	70.01	38.85	19.95	8.55	34.34c
	<b>Mean (Sto. time)</b>	<b>70.01a</b>	<b>44.44b</b>	<b>27.43c</b>	<b>12.31d</b>	
L*	625 ppb	66.88	65.46	57.89	54.18	61.10a
	312.5 ppb	66.88	64.92	56.11	51.74	59.91b
	156.25 ppb	66.88	64.19	55.81	49.64	59.13b
	Control	66.88	63.53	54.35	47.25	58.00c
	<b>Mean (Sto. time)</b>	<b>66.88a</b>	<b>64.52b</b>	<b>56.04c</b>	<b>50.70d</b>	
h°	625 ppb	82.99	78.08	74.64	71.73	76.86a
	312.5 ppb	82.99	74.99	71.56	69.70	74.81b
	156.25 ppb	82.99	74.19	71.69	69.54	74.60b
	Control	82.99	70.99	69.29	66.62	72.47c
	<b>Mean (Sto. time)</b>	<b>82.99a</b>	<b>74.56b</b>	<b>71.80c</b>	<b>69.40d</b>	
C*	625 ppb	65.77	64.10	52.87	44.50	56.81a
	312.5 ppb	65.77	62.51	51.17	43.67	55.78ab
	156.25 ppb	65.77	61.76	50.33	40.11	54.49b
	Control	65.77	60.31	47.66	35.15	52.22c
	<b>Mean (Sto. time)</b>	<b>65.77a</b>	<b>62.17b</b>	<b>50.51c</b>	<b>40.86d</b>	
Decayed fruit (%)	625 ppb		0.00	4.33	13.19	5.84b
	312.5 ppb		0.00	7.30	20.44	9.25b
	156.25 ppb		0.00	10.19	28.97	13.05b
	Control		0.00	25.89	51.85	25.91a
	<b>Mean (Sto. time)</b>		<b>0.00c</b>	<b>11.93b</b>	<b>28.61a</b>	

TSS, total soluble solids; TA, titratable acidity;  $h^\circ$ , hue angle;  $C^*$ , chroma;  $L^*$ , lightness; Sto.: storage

<sup>1</sup>The values within a column and row with different letters are significantly different at  $P \leq 0.05$  according to the Duncan's multiple range test.

**Table 2.** The effects of different 1-MCP doses on some quality parameters of ‘Hachiya’ persimmon fruits kept at 20°C for 3 days

Texting index	Treatments	Storage time (Days)				Mean (Treat.)
		0	30+3	60+3	90+3	
Weight loss (%)	625 ppb	-	3.16	4.92	6.09	<b>4.72d<sup>1</sup></b>
	312.5 ppb	-	3.46	5.91	7.70	<b>5.69c</b>
	156.25 ppb	-	3.74	6.87	7.93	<b>6.18b</b>
	Control	-	4.38	7.16	10.17	<b>7.24a</b>
	<b>Mean (Sto. time)</b>	<b>-</b>	<b>3.69c</b>	<b>6.21b</b>	<b>7.97a</b>	
TSS (%)	625 ppb	17.57	17.80	17.37	16.60	<b>17.33a</b>
	312.5 ppb	17.57	17.97	16.14	13.80	<b>16.37b</b>
	156.25 ppb	17.57	17.93	14.17	13.00	<b>15.67c</b>
	Control	17.57	18.47	13.33	12.43	<b>15.45c</b>
	<b>Mean (Sto. time)</b>	<b>17.57a</b>	<b>18.04a</b>	<b>15.25b</b>	<b>13.96c</b>	
TA (%)	625 ppb	0.184	0.130	0.102	0.066	<b>0.121a</b>
	312.5 ppb	0.184	0.114	0.093	0.048	<b>0.110b</b>
	156.25 ppb	0.184	0.103	0.087	0.045	<b>0.105b</b>
	Control	0.184	0.086	0.057	0.042	<b>0.092c</b>
	<b>Mean (Sto. time)</b>	<b>0.184a</b>	<b>0.108b</b>	<b>0.085c</b>	<b>0.050d</b>	
Fruit firmness (N)	625 ppb	70.01	23.67	14.55	13.74	<b>30.49a</b>
	312.5 ppb	70.01	14.53	11.72	10.60	<b>26.72b</b>
	156.25 ppb	70.01	13.20	11.01	7.96	<b>25.55b</b>
	Control	70.01	10.16	8.10	6.18	<b>23.61c</b>
	<b>Mean (Sto. time)</b>	<b>70.01a</b>	<b>15.39b</b>	<b>11.34c</b>	<b>9.62c</b>	
L*	625 ppb	66.88	58.87	55.11	50.40	<b>57.81a</b>
	312.5 ppb	66.88	57.17	53.19	48.85	<b>56.52b</b>
	156.25 ppb	66.88	55.61	51.97	46.61	<b>55.27c</b>
	Control	66.88	50.58	49.81	44.42	<b>52.92d</b>
	<b>Mean (Sto. time)</b>	<b>66.88a</b>	<b>55.56b</b>	<b>52.52c</b>	<b>47.57d</b>	
h°	625 ppb	82.99	74.01	71.09	69.55	<b>74.41a</b>
	312.5 ppb	82.99	72.54	68.94	67.58	<b>73.01b</b>
	156.25 ppb	82.99	72.28	66.25	65.57	<b>71.77c</b>
	Control	82.99a	71.14	65.88	61.84	<b>70.46d</b>
	<b>Mean (Sto. time)</b>	<b>82.99a</b>	<b>72.49b</b>	<b>68.04c</b>	<b>66.13d</b>	
C*	625 ppb	65.77	47.82	44.04	38.99	<b>49.15a</b>
	312.5 ppb	65.77	46.05	43.31	37.15	<b>48.07a</b>
	156.25 ppb	65.77	43.14	38.30	31.45	<b>44.66b</b>
	Control	65.77	41.75	34.05	30.55	<b>43.03c</b>
	<b>Mean (Sto. time)</b>	<b>65.77a</b>	<b>44.69b</b>	<b>39.92c</b>	<b>34.54d</b>	
Decayed fruit (%)	625 ppb		1.42	6.38	22.10	<b>9.97c</b>
	312.5 ppb		0.00	6.44	37.78	<b>14.74bc</b>
	156.25 ppb		2.89	14.80	42.52	<b>20.07b</b>
	Control		5.55	49.72	88.89	<b>48.05a</b>
	<b>Mean (Sto. time)</b>		<b>2.46c</b>	<b>19.34b</b>	<b>47.82a</b>	

TSS, total soluble solids; TA, titratable acidity; h°, hue angle; C\*, chroma; L\*, lightness, Sto.: storage

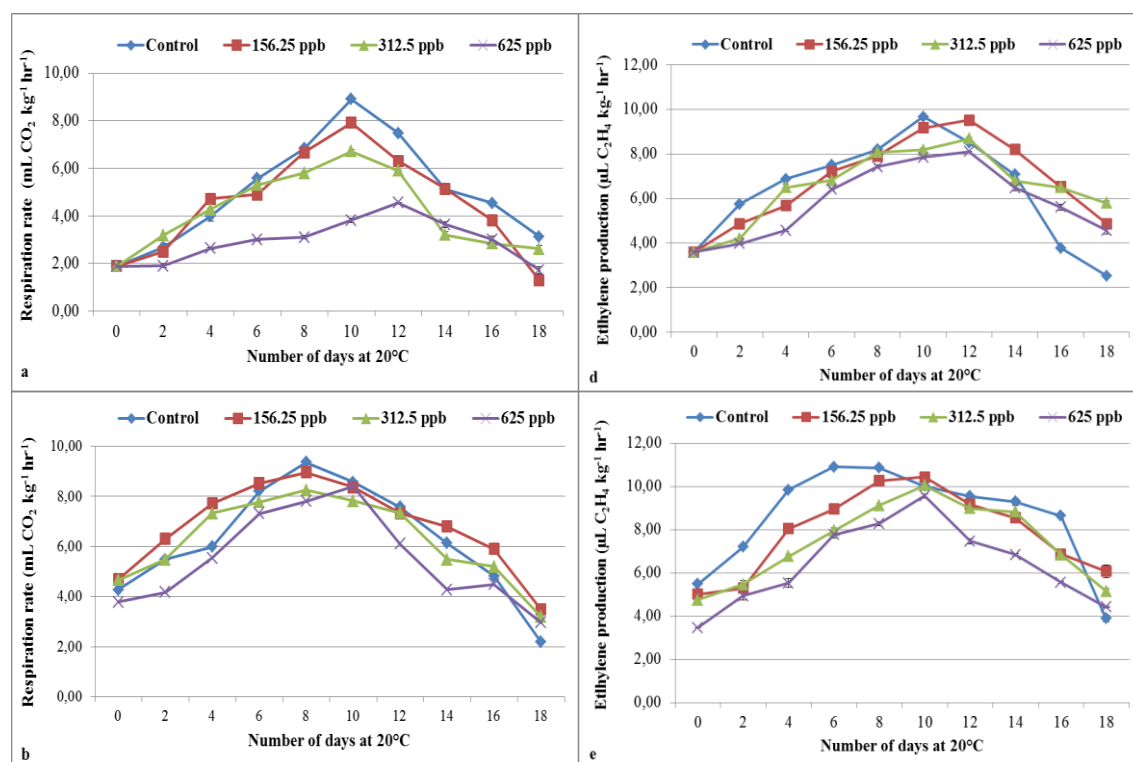
<sup>1</sup>The values within a column and row with different letters are significantly different at P ≤ 0.05 according to the Duncan's multiple range test.

**Respiration rate (CO<sub>2</sub> production)**

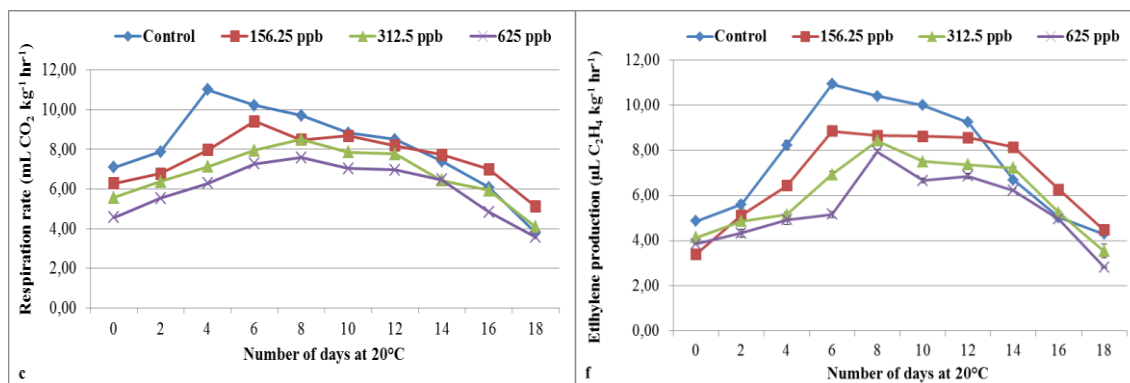
Variations occurred in respiration rate were given in Figure 1a. Control, 156.25 and 312.5 ppb 1-MCP treated fruits reached a maximum climacteric at 10<sup>th</sup> day. However, fruits treated with 625 ppb 1-MCP had climacteric maximum on 12<sup>th</sup> day. Maximum CO<sub>2</sub> production (8.90 mL CO<sub>2</sub> kg<sup>-1</sup> hr<sup>-1</sup>) was in control fruits whereas minimum CO<sub>2</sub> production of 4.55 mL CO<sub>2</sub> kg<sup>-1</sup> hr<sup>-1</sup> was recorded in 625 ppb 1-MCP treatment at harvest. Respiration rate of the fruits at 60 days of storage were illustrated in Figure 1b showed that control, 156.25 and 312.5 ppb 1-MCP treated fruits had maximum climacteric on 8<sup>th</sup> day. However, 625 ppb 1-MCP treated fruits attained climacteric maximum on 10<sup>th</sup> day. Control group had the highest CO<sub>2</sub> production (9.36 mL CO<sub>2</sub> kg<sup>-1</sup> hr<sup>-1</sup>) compared to 1-MCP treated fruits. The lowest CO<sub>2</sub> production (8.39 mL CO<sub>2</sub> kg<sup>-1</sup> hr<sup>-1</sup>) was noticed in 625 ppb 1-MCP. CO<sub>2</sub> production of the fruits at 90 days of storage was presented in Figure 1c. Control and 156.25 ppb 1-MCP treatment had maximal climacteric on 4<sup>th</sup> and 6<sup>th</sup> day while both 312.5 and 625 ppb 1-MCP had climacteric maximum on 8<sup>th</sup> day, respectively. The highest CO<sub>2</sub> productions in control group (11.01 mL CO<sub>2</sub> kg<sup>-1</sup> hr<sup>-1</sup>) while the lowest CO<sub>2</sub> production was noted in 625 ppb of 1-MCP treatment dose (7.58 mL CO<sub>2</sub> kg<sup>-1</sup> hr<sup>-1</sup>).

### Ethylene (C<sub>2</sub>H<sub>4</sub>) production

Ethylene production of persimmon fruits at harvest was presented in Figure 1d. Control group attained maximum C<sub>2</sub>H<sub>4</sub> production on day 10<sup>th</sup>, whereas all doses of 1-MCP treated fruits reached maximum C<sub>2</sub>H<sub>4</sub> production on 12<sup>th</sup> day of storage. The highest value of 9.66 μL C<sub>2</sub>H<sub>4</sub> kg<sup>-1</sup> hr<sup>-1</sup> was recorded in control group and the lowest C<sub>2</sub>H<sub>4</sub> production of 8.10 μL C<sub>2</sub>H<sub>4</sub> kg<sup>-1</sup> hr<sup>-1</sup> were recorded in 625 ppb 1-MCP dose. C<sub>2</sub>H<sub>4</sub> production at 60 days of storage was given in Figure 1e. Control fruits reached to maximum C<sub>2</sub>H<sub>4</sub> production on 6<sup>th</sup> day while 1-MCP treated groups attained maximal C<sub>2</sub>H<sub>4</sub> production on 10<sup>th</sup> day.







**Figure 1.** Effects of different 1-MCP doses on respiration rate (a: day 0, b: day 60, c: day 90) and ethylene production (d: day 0, e: day 60 and f: 90 day) in ‘Hachiya’ persimmon fruits at different storage periods.

After 60 days of storage the maximum  $C_2H_4$  production of  $10.91 \mu L C_2H_4 kg^{-1} hr^{-1}$  in control group whereas minimum  $C_2H_4$  production of  $9.56 \mu L C_2H_4 kg^{-1} hr^{-1}$  was found in 625 ppb 1-MCP treatment.  $C_2H_4$  production after 90 days of storage at  $0^\circ C$  were exhibited in Figure 1f showed that fruits of control and 156.25 ppb 1-MCP treatment reached to maximum  $C_2H_4$  production on 6<sup>th</sup> day while fruits with 312.5 and 625 ppb 1-MCP attained maximum  $C_2H_4$  production on 8<sup>th</sup> day. The maximal amount of  $C_2H_4$  production ( $10.94 \mu L C_2H_4 kg^{-1} hr^{-1}$ ) in control group however minimal  $C_2H_4$  production ( $7.95 \mu L C_2H_4 kg^{-1} hr^{-1}$ ) was obtained in fruits treated with 625 ppb 1-MCP. In our study it was found that 1-MCP dose of 625 ppb had the lowest amount of ethylene production and respiration rate. In many fruits and vegetables, 1-MCP generally slows down ethylene synthesis by blocking ethylene action. Furthermore, it decreases  $CO_2$  production, which indicates its positive impact on increasing the storage duration and shelf life period.

### Conclusions

Persimmon fruits treated with 1-MCP dose of 625 ppb had minimum weight loss, decay development, respiration rate and ethylene production. Whereas maximum soluble solids content, fruit firmness,  $L^*$ ,  $C^*$  and  $h^\circ$  values during both cold storage and shelf life were also recorded at 625 ppb 1-MCP treated fruits. On the basis of results obtained it is recommended to use 625 ppb of 1-MCP for keeping the best postharvest quality of ‘Hachiya’ persimmons during 3 months storage.

### References

- Anonymous (2014a). <http://www.fao.org/faostat/en/#data/QC>. (Accessed: July 2017).
- Anonymous (2014b). <http://rapory.tuik.gov.tr/07-07-201717:31:261870833349513245616765422563.html>. (Accessed: July 2017).
- Anonymous (2012c). Persimmon cultivation. [www.cameronur.com](http://www.cameronur.com) (Accessed: July 2017).
- Echeverria E., Valich J. (1989). Enzymes of sugar and acid metabolism in stored Valencia oranges. *Journal of the American Society for Horticultural Science*, 114, 445–449.
- Guillén F., Castillo S., Zapata P.J., Martínez-Romer D., Serrano M., Valero D. (2006). Efficacy of 1-MCP treatment in tomato fruit. 2. Effect of cultivar and ripening stage at harvest. *Agricultural and Forest Meteorology*, 42, 235-242.
- Karacali I. (2012). Storage and marketing of horticultural products. Ege University, Faculty of Agriculture, Bornova/İzmir, 494, 486.
- Kilinc B., Çakli Ş. (2001). Effects of packaging techniques on microbial flora of fish and shellfish. *Ege Journal of Fisheries and Aquatic Sciences*, 18, (1-2), 279-291.

- Koyuncu M.A., Savran E., Dilmaçunal T., Kepenek K., Cangi R., Çağatay Ö. (2005). Cold storage of some varieties of persimmon. *Akdeniz University Journal of the Faculty of Agriculture*, 18(1), 15-23.
- Kuzucu F.C., Kaynaş K. (2002). The effect of different packaging types on storage duration, maturity and quality in persimmon. II. Bahçe Ürünlerinde Muhafaza ve Pazarlama Sempozyumu, Çanakkale, 240-248.
- Sakaldas M. (2014). Effects of 1-methylcyclopropene applications on the postharvest quality of "Deveci" pear variety grown in Canakkale Region during storage. *ÇOMÜ Ziraat Fakültesi Dergisi (COMU Journal of Agriculture Faculty)*, 2 (1): 109–116.
- Watkins C.B., Miller W.B. (2005). 1-Methylcyclopropene (1-MCP) based Technologies for storage and shelf life extension. *ActaHortic.*, 687: 217-224.
- Yildiz M., Kinay P., Yıldiz F. (2002). Standing of biological struggle in control of postharvest diseases and the situation in Turkey. II. Bahçe Ürünlerinde Muhafaza ve Pazarlama Sempozyumu, Çanakkale, 45 s.
- Yener T. (2013). Effect of different postharvest applications on the storage of persimmon (*Diospyros kaki L.*) Yüksek Lisans Tezi, Bahçe Bitkileri Anabilim Dalı Uludağ Üniversitesi, 149 s.

## IDENTIFICATION OF WEED SEEDS CONTAMINATING WHEAT GRAIN

Sibel UYGUR\*

Çukurova University, Agricultural Faculty, Department of Plant Protection, Adana, Turkey

\*Corresponding author: [suygur@cu.edu.tr](mailto:suygur@cu.edu.tr)

### Abstract

The most important feature of weeds compared to cultivated plants, is that they have very high seed output and their longevity in the soil. The first step for the successful management of weeds is using weed-free crop seed. In modern agriculture, separation between weed seed and crop seed was minimized during the seed production and packaging. This study was conducted to identify weed seed contamination in wheat grains between 2014-2016. The wheat samples (average two kg) were taken from randomly selected six (in total 18) wheat grain sellers (crop seed or feed wheat seed) in the Adana province of Turkey. They were brought to the laboratory and examined for any weed seeds. As a method, the wheat grains and weed seed were separated using different sized sieves, then identified using different sources and collections. Corncockle (*Agrostemma githago* L., Caryophyllaceae), Goosegrass (*Galium aparine* L., Rubiaceae), Field bindweed (*Convolvulus arvensis* L., Convolvulaceae), Jointed goatgrass (*Aegilops cylindrica* Host., Poaceae), Wild oat (*Avena sterilis* L., Poaceae), Italian thistle (*Carduus pycnocephalus* L., Asteraceae), Thistles (*Centaurea* spp., Asteraceae), Curly duck (*Rumex* spp., Polygonaceae) were found the most common weed seeds in the samples. Among these important weeds, Field bindweed is only perennial herbaceous weed which reproduces by seeds and rhizomes. On the other hand, some weed seeds are poisonous for both humans and livestock such as Corncockle.

**Keywords:** *Weed, Seed, Grain, Wheat, Corncockle.*

### Introduction

Wheat is one of the main agricultural products that hold an important place in human nutrition. It is affected by both abiotic and biotic factors (weed, insect and fungus pests) during the cultivation. Weeds are an important pest group in wheat farming. The management of weeds in the wheat field has been particularly difficult in the last two decades because of herbicide resistance.

Adana province is located in the Mediterranean part of Turkey and the center of Çukurova Delta, which is a main agricultural area of Turkey. According to data from TÜİK (2015), total agricultural area is 4.891.150 da in Adana. Wheat, citrus, corn, olive, sunflower and watermelon are the main crops. But wheat growing areas has been decreased last couple years. The main reason was herbicide resistant weed species. Wild oat (*Avena sterilis*) and Wild mustard (*Sinapis arvensis*) are two important resistant weeds against ALS and ACCase herbicides (Uygur et al., 2012). So, successful management of wheat weeds are very important including prevention methods. Weed free crop seeds are the first step in the weed management programs. Planting crop seeds containing weed seeds has been the most common methods of spreading weeds for centuries (Wicks et al., 1995).

This study was planned to learn and identify which weed species mixed with wheat grain can be carried to the field. Even wheat grain for animal feeding can be brought these weed seeds to the fields.

## Material and Methods

The wheat samples were taken from randomly selected six (in total 18 samples) wheat grain sellers (crop seed or feed wheat seed) in the Adana province of Turkey to identify weed seed contamination in wheat grains between 2014-2016. All samples were taken just after weed harvest. Average weight of each sample was two kg. They were brought to the laboratory and examined for any material. In the first step; soil, straw and stone material, and other pests (especially weevils and snails) were removed by visually. Then wheat grains and weed seed were separated using different sized sieves. Same kind of seeds was collected in a small petri dish, then identified using different sources (Davis, 1965-2000; Hanf, 1990; Lionakis Meyer and Effenberger, 2010) and weed science laboratory collection.

## Results and Discussion

Fifty four weed species (14 monocots and 40 dicots) were separated and identified from the samples (Table 1 and Table 2). In general weed species were represented the all geographic regions of Turkey. It means that, some of these wheat grain samples came from different parts of Turkey. The most common weeds in the wheat grains according the frequency (found min. 5 samples) were Jointed goatgrass (*Aegilops cylindrica*), Corncockle (*Agrostemma githago*), Wild oat (*Avena sterilis*), Italian thistle (*Carduus pycnocephalus*), Field bindweed (*Convolvulus arvensis*), Goosegrass (*Galium aparine*), Darnel ryegrass (*Lolium temulentum*), Wild mustard (*Sinapis arvensis*), Johnsongrass (*Sorghum halepense*), Narbon vetch (*Vicia narbonensis*) and Common vetch (*V. sativa*). They are also serious competitor weeds in the wheat fields. *A. githago* and *L. temulentum* were reported as poisonous plant in Turkey (Ozturk et al., 2008).

Table 1. Identified Monocotyledonous Weed Species in Wheat Grain Samples.

Weed Species	Samples (6 x 3 years)																	
	2014						2015						2016					
	1	2	3	4	5	6	1	2	3	4	5	6	1	2	3	4	5	6
<i>Alopecurus myosuroides</i> Huds.	-	-	-	-	-	-	-	-	-	-	-	-	-	+	-	-	-	-
<i>Aegilops cylindrica</i> Host.	-	+	+	+	+	+	+	+	+	-	+	-	-	-	-	-	-	-
<i>Avena fatua</i> L.	-	-	+	-	-	-	-	-	-	-	-	-	-	-	-	-	-	-
<i>Avena sterilis</i> L.	+	+	-	+	+	+	+	-	+	-	+	+	-	+	+	+	+	+
<i>Bromus arvensis</i> L.	+	-	+	-	+	-	-	+	-	-	+	-	-	-	-	-	-	-
<i>Bromus inermis</i> Leysser	-	-	-	-	-	-	-	-	-	-	-	-	-	+	-	-	+	-
<i>Hordeum murinum</i> L.	+	-	-	-	-	-	-	-	-	-	-	-	-	-	-	-	-	-
<i>Lolium perenne</i> L.	+	-	-	-	-	-	-	-	-	-	-	-	-	+	-	-	+	-
<i>Lolium temulentum</i> L.	+	-	-	-	+	-	-	-	-	-	-	-	-	-	+	+	-	+
<i>Phalaris canariensis</i> L.	-	-	-	-	-	-	-	-	-	-	-	-	-	-	+	-	-	-
<i>Phalaris minor</i> Retz.	-	+	-	-	-	-	-	-	-	-	-	-	-	-	-	-	-	+
<i>Poa trivialis</i> L.	+	-	-	-	-	-	-	-	-	-	-	-	-	-	-	-	-	-
<i>Setaria glauca</i> (L.) P.Beauv.	-	+	-	-	-	-	-	-	-	-	-	-	-	-	-	-	-	-
<i>Sorghum halepense</i> (L.) Pers.	+	-	-	-	+	-	-	-	-	-	-	-	+	+	-	+	+	-

Table 2. Identified Dicotyledonous Weed Species in Wheat Grain Samples.

Weed Species	Samples (6 x 3 years)																	
	2014						2015						2016					
	1	2	3	4	5	6	1	2	3	4	5	6	1	2	3	4	5	6
<i>Abutilon theophrasti</i> Med.	-	-	-	-	-	-	+	-	-	-	-	-	-	-	-	-	-	-
<i>Agrostemma githago</i> L.	-	-	-	+	+	-	-	+	+	-	-	-	+	-	+	-	-	-
<i>Bifora radians</i> Bieb.	-	+	-	+	-	-	+	-	+	-	-	-	-	-	-	-	-	-
<i>Boreava orientalis</i> Jaub. & Spach.	-	-	-	-	-	-	-	-	+	-	-	-	-	-	-	-	-	-
<i>Carduus pycnocephalus</i> L.	-	+	+	+	-	-	-	+	+	-	-	+	+	-	-	-	-	-
<i>Caucalis platycarpus</i> L.	-	-	-	-	-	-	-	-	+	-	-	-	-	-	-	-	-	-
<i>Centaurea cyanus</i> L.	-	-	+	-	-	-	-	+	-	-	-	-	-	-	-	-	-	-
<i>Centaurea diffusa</i> Lam.	-	+	+	-	-	-	-	-	-	-	-	+	-	-	-	-	-	-
<i>Centaurea solstitialis</i> L.	-	-	-	-	-	+	-	-	+	-	-	-	-	-	-	-	-	-
<i>Chenopodium album</i> L.	-	-	-	-	-	-	-	-	-	-	-	-	-	-	-	-	-	+
<i>Chenopodium murale</i> L.	-	+	-	+	+	-	-	-	-	-	-	-	-	-	-	-	-	-
<i>Chrysanthemum coronarium</i> L.	-	-	-	-	-	-	-	-	-	-	-	-	+	-	-	-	-	-
<i>Conicum maculatum</i> L.	-	+	-	-	-	-	-	-	+	-	-	-	-	-	-	-	-	-
<i>Consolida</i> sp.	-	+	-	-	-	-	+	-	-	-	-	-	-	-	-	-	-	-
<i>Convolvulus arvensis</i> L.	+	+	+	+	-	+	+	+	-	-	+	+	+	+	+	+	+	+
<i>Coronopus squamatus</i> (Forssk.) Asch.	-	-	-	-	-	-	-	-	-	-	-	-	+	-	-	-	-	-
<i>Daucus carota</i> L.	+	-	-	-	-	-	-	+	-	-	-	-	-	-	-	-	-	-
<i>Descrunia sophia</i> (L.) Webb.	-	-	-	-	-	-	-	-	-	-	-	-	-	-	-	-	+	-
<i>Echinops sphaerocephalus</i> L.	-	-	-	-	-	-	-	-	-	+	-	-	-	-	-	-	-	-
<i>Fumaria officinalis</i> L.	-	+	-	-	+	-	-	-	-	-	-	-	-	-	-	-	-	-
<i>Galium aparine</i> L.	+	+	+	-	+	+	+	+	+	+	+	+	-	-	+	+	-	-
<i>Galium tricornutum</i> Dandy	+	-	-	-	-	-	-	-	-	-	-	-	-	-	-	-	-	-
<i>Glaucium corniculatum</i> (L.) Rud.	-	-	-	-	-	-	-	-	-	+	-	-	-	-	-	-	-	+
<i>Malva sylvestris</i> L.	+	-	-	-	-	-	+	-	-	+	-	-	-	-	-	-	-	-
<i>Medicago sativa</i> L.	-	-	+	-	-	-	-	+	-	-	-	-	-	-	-	-	-	-
<i>Myagrimum perfoliatum</i> L.	+	-	-	-	-	-	-	-	-	-	-	-	-	-	-	-	-	-
<i>Neslia paniculata</i> (L.) Des.	-	-	-	-	-	-	-	+	-	-	-	-	-	-	-	-	-	-
<i>Polygonum aviculare</i> L.	-	-	-	-	-	-	-	-	+	+	-	+	-	-	-	-	-	-
<i>Raphanus raphanistrum</i> L.	-	-	-	-	-	-	-	-	-	-	-	-	-	+	-	+	+	-
<i>Ranunculus arvensis</i> L.	-	-	-	-	-	-	-	-	+	-	-	-	-	-	-	-	-	-
<i>Rumex acetosella</i> L.	-	-	-	-	-	-	+	-	-	-	-	+	-	-	-	-	+	-
<i>Rumex obtusifolius</i> L.	-	+	-	-	-	+	-	-	-	+	-	-	-	-	-	-	-	-
<i>Scabiosa rotata</i> Bieb.	+	-	-	-	-	-	-	-	-	-	-	-	-	-	-	-	-	-
<i>Silybum marianum</i> (L.) Gaertn.	-	-	-	-	-	-	-	-	-	-	-	-	+	-	+	-	-	+
<i>Sinapis arvensis</i> L.	+	+	+	-	-	-	+	+	-	+	+	-	-	+	-	+	+	+
<i>Vicia narbonensis</i> L.	-	-	+	-	+	+	-	+	-	+	+	+	-	-	-	-	-	-
<i>Vicia sativa</i> L.	-	-	+	+	-	-	-	+	+	-	+	-	-	-	-	-	-	-
<i>Tragopogon</i> sp.	-	-	+	-	-	-	-	-	-	-	-	-	-	-	-	-	-	-
<i>Vaccaria pyramidata</i> Med.	-	-	-	-	-	-	-	-	+	-	-	-	-	-	-	-	-	-
<i>Xanthium strumarium</i> L.	-	-	-	-	-	-	-	-	-	-	-	-	+	-	-	-	-	-

In another province of Turkey, Kahramanmaraş, *Sinapis arvensis* was found the highest number of weed seeds in wheat grain (165.0 seeds /kg). *Hordeum vulgare*, *Lolium temulentum*, *Boreava orientalis* and *Galium tricorntum* were found as important weeds similarly (Tursun et al., 2006).

### Conclusions

Successful management of weeds is not only by using mechanical tools and chemicals. Weed-free crop seed must be the first prevention method during all crop cultivation. In modern agriculture, separation between weed seed and crop seed was minimized during the seed production and packaging. However, some weed seeds are still problematic in the wheat grain. While wheat seeds are being prepared for seed or animal feeding, weed seeds are transported along with them. The weed seeds, which are not in a zone, are transported to other areas. On the other hand, seeds of resistant weed species such as Wild mustard can be carried with grains to the herbicide resistance free wheat fields. As a sample, Guncan (1980), in his large scale project show that, the farmers could be transferred 14500 weed seeds per decare in the case of sowing wheat without being cleaned. Starting from the wheat harvest, the grains must be cleaned using different kind of separator, and, observed by farmers and technical staff in the seed seller and companies.

### References

- Davis, P. H. (1965-2000). Flora of Turkey and East Aegean Island. Vo:1-11, Edinburgh University Press.
- Guncan, A., 1980. Anadolu'nun Doğusunda Buğday Ürününe Karışan Yabancı Ot Tohumları, Bunların Yoğunlukları ve Önemlilerinin Oluşturdukları Bitki Toplulukları Üzerinde Bir Araştırma (An Investigation on Weed Seeds Contaminating Wheat Yields in the Eastern Anatolia and Their Densities, and Weed Communities of Important Ones). Atatürk Üniv. Ziraat Fak, Bitki Koruma Bölümü. Erzurum, 48 s.
- Hanf, M. (1990). Ackerunkrauter Europas mit ihren Keimlingen and Samen. BLV Verlagsgesellschaft, 496 p.
- Lionakis Meyer, D.J., Effenberger, J. (2010). California Noxious Weed Disseminules Identification Manual. California Department of Food & Agriculture, Plant Pest Diagnostics Center – Seed Laboratory, CA-USA, 63 p.
- Ozturk, M., Uysal, I., Gucl, S., Mert, T., Akcicek, E., Celik, S. (2008). Ethnoecology of Poisonous Plants of Turkey and Northern Cyprus. Pak. J. Bot., 40(4): 1359-1386, 2008.
- TUIK (2017). Türkiye İstatistik Kurumu Verileri (Datas from Turkish Statistical Institute). Adana ili Tarımsal Yatırım Rehberi. Gıda, Tarım ve Hayvancılık Bakanlığı, Strateji Geliştirme Başkanlığı.  
[https://www.tarim.gov.tr/SGB/TARYAT/Belgeler/il\\_yatirim\\_rehberleri/adana.pdf](https://www.tarim.gov.tr/SGB/TARYAT/Belgeler/il_yatirim_rehberleri/adana.pdf)
- Tursun, N., Kantarcı, Z., Seyithanoğlu, M. (2006). Kahramanmaraş'ta Buğday Ürününe Karışan Yabancı Ot Tohumlarının Belirlenmesi (Determination of Weed Seeds Contaminating Wheat Grain in Kahramanmaraş Province). KSÜ. Fen ve Mühendislik Dergisi,9(2), 110-115.
- Uygur, S., Ayata, M. U., Aksoy, E., Koseoğlu, C., Borazan, M., Gurbuz, R., Uygur, F. N. (2013). Preliminary dates on mapping of herbicide resistance *Avena sterilis* L. and *Sinapis arvensis* L. biotypes in wheat fields of Adana province/Turkey, 16 th EWRS (European Weed Research Society) Symposium, 24-27 June 2013 Samsun, Turkey, 288.
- Wicks, G.A., Burnside, O.C., Felton, W.L. (1995). Mechanical Weed Management in Handbook of Weed Management Systems (ed.by A.E. Smith). New York, USA, 51-100.

## PRETREATMENT INFLUENCE ON THE DRYING RATE AND BIOACTIVE COMPOUNDS OF DRIED FIGS

Luziana HOXHA\*, Renata KONGOLI

Faculty of Biotechnology and Food, Agricultural University of Tirana, Albania

\*Corresponding author: hoxhaluziana@hotmail.com

### Abstract

Figs are delicious dried fruit consumed, and occupy a special place of importance in nutrition, and have numerous health benefits to offer as well, associated this with the presence of bioactive compounds. The aim of this paper was to investigate the influence of different alkaline solutions used as pretreatment on the drying rate and bioactive compounds content. The selected fig variety was “Roshnik” variety, and was studied in a batch operation in a laboratory dryer, at a preset drying temperature of 60 °C and constant air velocity. The constants of drying kinetics and mean apparent diffusivity of moisture for all pretreatment were calculated. Dipping figs in NaCl, CaCO<sub>3</sub>, K<sub>2</sub>CO<sub>3</sub>, and lye solution increased the drying rate. Figs dried in 50248-61808 seconds depending on pretreatment for the same drying process parameters. The results showed that figs dipped in a 1% solution of potassium carbonate and sodium chloride to have shorter drying time. Also, application of 0.2 % of K<sub>2</sub>S<sub>2</sub>O<sub>5</sub> resulted to increase the quality of dried products. Applications of pretreatment should be taken under consideration for application to food processors for figs drying as they influenced positively in increasing the drying rate and the quality of the dried figs.

**Keywords:** *Ficus carica*, drying rate, pre-treatment, polyphenols

### Introduction

Figs (*Ficus carica* L.) are a widespread species commonly grown, especially in warm, dry climates, and mainly in Mediterranean countries, where they occupy an important role of diet (author).

Figs are widely consumed fresh, as they naturally have a short post-harvest life; also they are very popular as dried fruit. Drying is one of the important preservation methods employed for storage of figs since the dawn of civilization. Fig fruit can be dried either by traditional methods (sun drying) or in conventional hot-air dryers (Babalís *et al.*, 2006). However, the research on drying figs is limited (Piga *et al.* 2004; Doymaz, 2005; Xanthopoulos *et al.*, 2007, 2009, 2010). Papoff *et al.*, (1998) tried to dehydrate figs with an industrial dehydrator, and gained very good results in terms of drying times and microbial stability, but structure collapse occurred and figs have some problems with the sensorial properties.

Drying cause physical, chemical and biochemical changes in addition to some undesirable alterations such as textural and color changes (Xanthopoulos *et al.*, 2010). Such changes may be influenced by using pre-treatment, causing a shorter drying time and a reduction in adverse changes that occur during drying compared to untreated fruits (Lewicki, 2006). Several studies have tested various pre-treatment with the aim to reduce peel resistance of the final dried product or to weaken it and to water transfer from the inside of the product to the surface, increasing likewise the drying rate (Doymaz, 2007).

In recent years, several data have been generated on the polyphenol constituents in a variety of food materials, including figs. *Ficus* species are rich source of naturally occurring

antioxidants of which phenolic compounds and flavanoids play a vital role in preventing innumerable health disorders related to oxidative stress including cardiovascular diseases (Sirisha *et al.*, 2010). Slatnar *et al.*, (2011) compared for the first time the phenolic content between fresh and dried fruit. However, only a few studies have investigated the effect of drying on polyphenols of figs.

The lack of a drying system applicable for figs in industrial level in Albania encouraged us to investigate the influence of different pretreatment in the drying performance and phenolic content of figs (*Ficus carica*), and several drying tests have been carried out in a laboratory dryer, with the attempt to achieve shorter drying time and offering the best quality dried products.

## Materials and methods

### Plant material

The local variety of *Ficus carica* named “Roshnik” (yellow skin colour and red pulp) was selected for this study. Its cultivation area is Roshnik village (40°42'51.56"N 19°58'48.02"E) in Berat region (Albania) and sun-dried figs are traditional products of this region. Fruits were harvested at the end of August 2017 at optimal maturity and immediately transported to the laboratory. The selection of fruits was done based on weight in order to ensure a uniform size, appearance, maturity, and health conditions.

### Sample preparation and drying conditions

Before drying, fruits were pre-treated as: blanching in boiling water with 1% alkaline solution (lye, CaCO<sub>3</sub>, K<sub>2</sub>CO<sub>3</sub>, and NaCl) for 1 min, cooling to 25±2 °C using tap water (blanching water to fruit ratio was 12:1), also, fruit were dipped in 0.2% K<sub>2</sub>S<sub>2</sub>O<sub>5</sub> (KMS) for 1 min. Also, untreated samples was used as control (sample code C), and only treated with KMS (sample code C-KMS).

Fruits were dried in a laboratory dehydrator. Fruits were placed on three shelves per treatment (the drier can hold ten shelves). Hot air dehydrator was a closed cabinet with a fan inside to blow the air “horizontally” across the shelves (fruits were set on shelf inside the drying chamber). The ambient air temperature was 25°C, while drying air was heated electrically to a 60°C adjusted temperature, with air relative humidity approximately 40% (at the beginning) and 10% (at the end) and flowed to the fruits with a constant speed 1 m/s. Air recycling system allowed the mixing of exhaust air with fresh air, which was then reheated and redirected to the product.

### Preparation of extracts

Methanol extracts were prepared by extracting 1 ± 0.001 g grinded fig samples with 10 mL of aqueous methanol 80% (v/v), homogenized for 1 minute using Ultra-Turrax T-25 (Ika-Labortechnik, GR), with speed set 11000 rpm, and centrifuged using centrifuge Eba 21 (Hettich, GR) for 15 min at 4500 rpm. This process was repeated three times and supernatants were collected and analyzed. Extracts of fresh and dried fig samples were prepared separately. All samples were analyzed in triplicate.

### Assessments and determinations

The weight of the dried sample was measured using a precision balance with an accuracy of 0.01 g, having a maximum capacity of 3000 g. The weight of the material was measured in fixed time intervals and recorded as a function of drying time. The drying data from the different drying tests were then expressed as moisture ratio MR versus drying time and drying rate DR versus drying time.



The moisture content has been determined both for the fresh and for the final dehydrated products (AOAC, 2000).

pH value was determined using pH meter UB-10 (UltraBasic, Denver Instrument) (AOAC 2000), total acidity (expressed as % citric acid) was determined by titrating with 0.1N NaOH (AOAC 2000).

Total phenolic content of the extracts was determined according to the method of Singleton and Rossi's (1965) with some modification and results were expressed as *gallic acid equivalents* (mg GAE 100 g<sup>-1</sup> DM<sup>-1</sup> (dry matter of sample). Total flavonoid content was measured using AlCl<sub>3</sub>, a colorimetric method (Zubair *et al.*, 2013), and results were expressed as (+) *catechin equivalents* (mg CE 100 g<sup>-1</sup> DM<sup>-1</sup> of sample). Total anthocyanin's content was measured according to the pH differential method (Cheng and Bren, 1991). Absorbance of extracts was measured at 520 nm and 700 nm in buffers at pH 1.0 and pH 4.5 where absorbance was:  $A=(A_{520}-A_{700})_{pH\ 1.0}-(A_{520}-A_{700})_{pH\ 4.5}$ , (with molar extinction coefficient of 26.900 and molecular weight of 449.2). Results were expressed as *cyanidin-3-glucoside equivalents* (mg C3G 100 g<sup>-1</sup> DM<sup>-1</sup> of sample).

### Results and Discussion

The results are given on Table 1 and Figures 1-5. The weight of pre-selected fig fruits was 14.33 ± 1.25 g, skin colour yellow and red pulp. The drying time took approximately 50248-61808 seconds. The reduction of drying time was attributed to pre-treatment applied. This finding was in accordance with other studies (Piga *et al.*, 2004; Lewicki, 2006).

In general the physico-chemical parameters of final dried product were more concentrated due to the drying process, compared to fresh fruit, so the dry matter was 31.34 ±0.19% increased to 75.87±0.19%, The total soluble solids (TSS) of fresh fruit was 27°Brix, and the higher content of total soluble solids make it more suitable for drying. Titratable acidity expressed as citric acid was 0.19 %±0.005 citric acid (CA) increased to 0.61±0.015% CA. Also, the sugar/acid ratio for our selected fresh fig variety was 142.10, and the higher the ratio, the sweeter are the fruits. Accordingly, after drying process the pH values were decreased with increase of total acidity from 5.01±0.01 to 4.35±0.005. The above data were in the range reported (Piga *et al.*, 2004, Slatnar *et al.*, 2011) for this fruit species.

On the Table 1 are shown the codes of pre-treated samples, and the drying time for each case:

Table 1. Codification of pre-treated fig fruits samples and drying time

Pretreatment (bleaching in 1% alkaline solution)	Code of pre-treated samples	Drying time (sec)	Code of samples (dipping in 0.2% KMS)	Drying time (sec)
Control	C	60785	C-KMS	61808
Lye	BL	56105	BL-KMS	56452
CaCO <sub>3</sub>	BCa	57060	BCa-KMS	59651
K <sub>2</sub> CO <sub>3</sub>	BK	55965	BK-KMS	56858
NaCl	BNa	50248	BNa-KMS	51965

In the figure 1 are expressed the drying curves, and was noted that the values of moisture ratio decreased rapidly, with consequent increase of the drying rate.

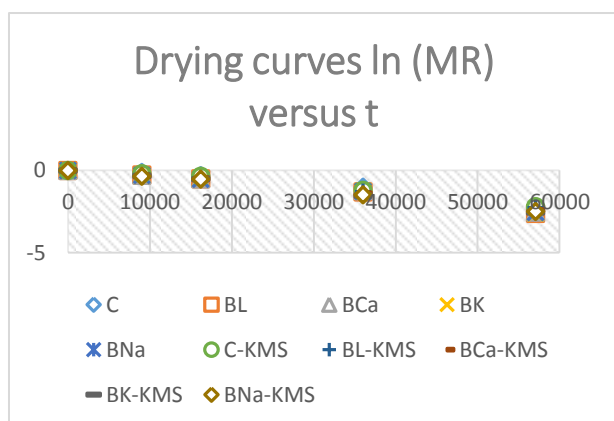


Fig.1: The experimental ln (MR) values against drying time in sec

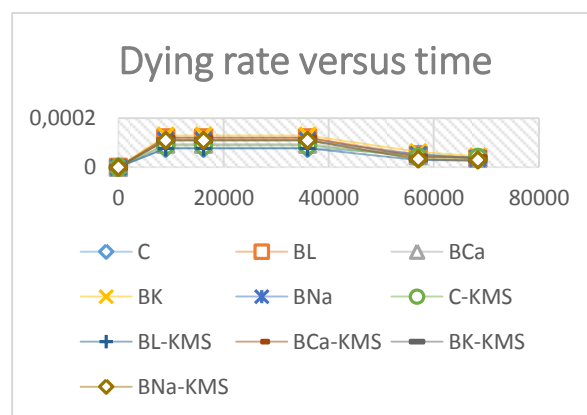


Fig. 2: Figure 2: The values of drying rate against time in sec

Pretreatment favored water mobility and increased drying rates in comparison with those untreated, and BK-KMS and BNa-KMS samples had greater drying rate and the final dried product was the best quality compared to other samples. Also, the untreated dried samples resulted the browning due to high amount of sugars in particular reducing sugars which have the ability to interact with amino acids (nonenzymatic browning reaction). Also, the long drying time for control samples (C) affected more the color compared to C-KMS and other pretreated samples. The application of pre-treatment minimized adverse changes and played a positive role in color retention, shape, and a soft structure according to the order: C<BL<BCa<BNa<BK, and samples dipped in KMS resulted in better color retention, maintained the shape and reduced firmness.

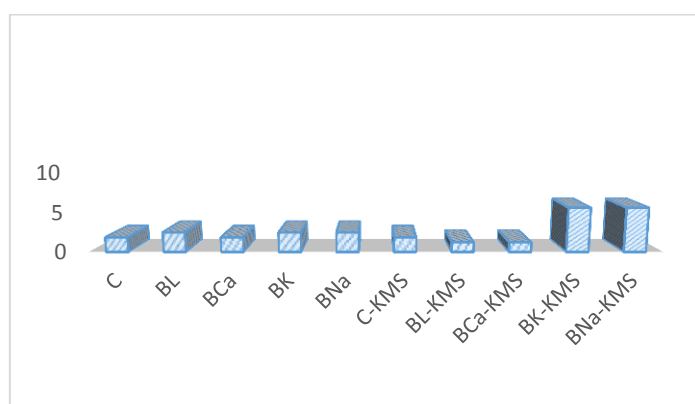


Figure 3: The estimated  $De_{eff}$  values  $\times 10^{-10} \text{ m}^2/\text{s}$  for the studied samples

The effective water diffusivity was calculated employing the method of slopes. (Perry,1997; Saravacos, 2001), but the method of slopes can only estimate the initial effective water diffusivity since the shrinkage effect cannot be considered. The calculated  $De_{eff}$  values varied from  $1.25 \times 10^{-10} \text{ m}^2/\text{s}$  to  $5.62 \times 10^{-10} \text{ m}^2/\text{s}$  for the studied cases. The estimated  $De_{eff}$  values lie within the general range of  $10^{-11}$  to  $10^{-8} \text{ m}^2/\text{s}$  of food materials (Zogzas et al., 1996).

#### Bioactive Compounds

A number of studies have shown that the presence of phenolic compounds in food and especially in fruit can be particularly important for consumers, because of their beneficial health properties.

The drying method applied had a depleting effect on anthocyanins content, and the pre-treatment applied did not affect the content of anthocyanins in the dried product.

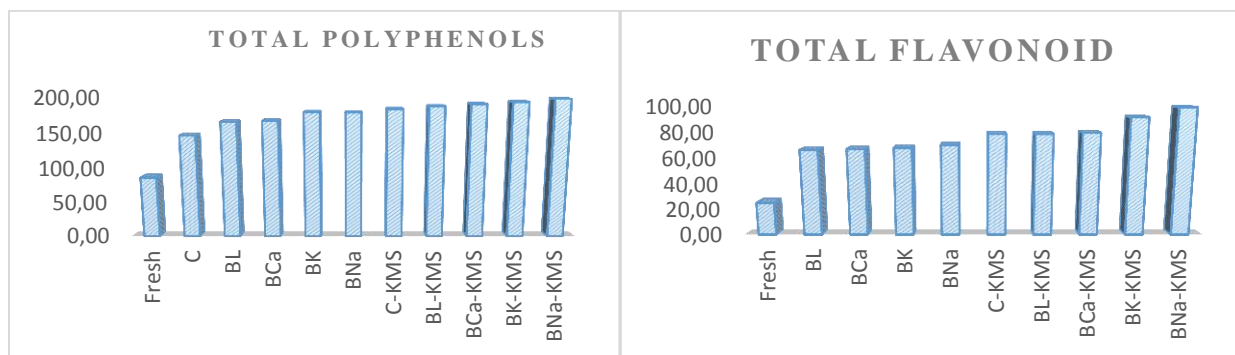


Fig. 4: Total polyphenolic content expressed mg GAE 100 g<sup>-1</sup> DM<sup>-1</sup>

Fig. 5: Total flavonoid content expressed mg CE 100 g<sup>-1</sup> DM<sup>-1</sup>

Results showed that figs are rich sources of phenolics, and drying increased their concentration, and between dried samples there were slight differences in values. It was noted that samples dipped in alkaline solution and KMS had greater values than control samples, where BK-KMS and BNa-KMS had the highest values from 192.68 to 196.97 mg GAE 100 g<sup>-1</sup> DM<sup>-1</sup> and from 91.24 to 98.63 mg CE 100 g<sup>-1</sup> DM<sup>-1</sup>.

### Conclusion

From the drying kinetic of figs was seen that drying took place during the falling rate period. The mean effective water diffusivity of whole figs was estimated from drying kinetics. The main advantage of this method was its simplicity and ability to estimate D values. The calculated *Deff* values varied from 1.25 x 10<sup>-10</sup> m<sup>2</sup>s<sup>-1</sup> to 5.62 x 10<sup>-10</sup> m<sup>2</sup> s<sup>-1</sup> for the studied cases, that lie in general range for food materials. Pretreatments reduced the drying duration, favoring water mobility and increasing drying rates in comparison with those untreated. The main quality changes were browning of the peel, especially for nontreated figs. The application of pre-treatment minimized adverse changes and played a positive role in color retention, shape, and a soft structure according to the order: C<BL<BCa<BNa<BK, and samples dipped in KMS resulted in better color retention, maintained the shape and reduced firmness. Furthermore, was noted that samples dipped in alkaline solution and KMS had higher total phenolic content than control samples. The results of this work showed that pre-treatment applications reduced drying time and offered better quality of dried fig fruits, and the tested alkaline solution should be taken under consideration for application as pre-drying treatment, to food processors for figs drying in Albania.

### References

- AOAC International. 2000. Official methods of analysis of AOAC International. 17th edition. Gaithersburg, MD, USA, Association of Analytical Communities.
- Babalís S.J., Papanicolaou E., Kyriakis N., Belessiotis V.G. (2006). Evaluation of thin-layer drying models for describing drying kinetics of figs (*Ficus carica*). *Journal of Food Engineering*, vol. 75, no. 2, pp. 205–214.
- Cheng G.W. and Breen, P.J. (1991). Activity of phenylalanine ammonia-lyase (PAL) and concentrations of anthocyanins and phenolics in developing strawberry fruit. *Journal of the American Society for Horticultural Science*, vol.116, pp. 865–869.
- Doymaz I. (2005). Sun drying of figs: an experimental study. *Journal of Food Engineering*, vol.71, pp 403–407.

- Doymaz I. (2007). Influence of pretreatment solution on the drying of sour cherry. *Journal of Food Engineering*, vol.78, pp. 591–596.
- Lewicki P.P. (2006). Design of hot air drying for better foods. *Trends in Food Science & Technology*, vol. 17, pp. 153–163.
- Papoff C.M., Battacone G., Agabbio M. (1998). The influence of industrial dehydration on quality of fig fruits. *Acta Horticulturae*, vol. 480, pp. 233–237.
- Perry R.H., Green D.W. (1997). *Perry's Chemical Engineers' Handbook*, 7th Ed. McGraw-Hill, New York.
- Piga F., Pinna I., Özer K.D., Agabbio V., Aksoy U. (2004). Hot air dehydration of figs (*Ficus carica* L.): drying kinetics and quality loss. *International Journal of Food Science & Technology*, vol. 39, pp. 793–799.
- Price W.E., Sabarez H.T., Storey R., Back P.J. (2000). Role of the waxy skin layer in moisture loss during dehydration of prunes, *Journal of Agricultural and Food Chemistry*, vol.48, pp. 4193–4198.
- Re R., Pellegrini N., Proteggente A., Pannala A., Yang M., Rice-Evans C. (1999). Antioxidant activity applying an improved ABTS radical cation decolorisation assay. *Free Radical Biology and Medicine*, vol. 26, pp.1231-1237.
- Singleton V.L., Rossi J.A. (1965). Colorimetry of total phenolics with phosphomolybdic-phosphotungstic acid reagents. *American Journal of Enology and Viticulture*, vol. 16, pp. 144-158.
- Sirisha N., Sreenivasulu M., Sangeeta K., Chetty C. (2010). Antioxidant Properties of *Ficus* Species – A Review. *International Journal of PharmTech Research*, vol. 2, pp. 2174-2182.
- Slatnar A., Klancar U., Stampar F., Veberic R. (2011). Effect of Drying of Figs (*Ficus carica* L.) on the Contents of Sugars, Organic Acids, and Phenolic Compounds. *Journal of Agricultural and Food Chemistry*, vol. 59, no. 21, pp. 11696-702.
- Xanthopoulos G., Oikonomou N., Lambrinos G. (2007). Applicability of a single-layer model to predict the drying rate of whole figs. *Journal of Food Engineering*, vol. 81, pp. 553–559.
- Xanthopoulos G., Yanniotis S., Lambrinos Gr. (2009). Water diffusivity and drying kinetics of air drying of figs. *Drying Technology*, vol. 27, pp. 502–512.
- Xanthopoulos G., Yanniotis S., Lambrinos Gr. (2010). Study of the drying behaviour in peeled and unpeeled whole figs. *Journal of Food Engineering*, vol. 97, pp. 419–424.
- Zogzas N.P., Maroulis Z.B., Marinos-Kouris D. (1996). Moisture diffusivity data compilation in foodstuffs. *Drying Technology*, vol. 14, no. 10, pp. 2225–2253.
- Zubair M., Hassan S., Rizwan K., Rasool N., Riaz M., Zia-Ul-Haq M., Defeo V. (2013). Antioxidant potential and oil composition of *Callistemon viminalis* leaves. *The Scientific World Journal*, pp. 1–8.

## WHY *APHIS SPIRAECOLA* (HEMIPTERA: APHIDIDAE) IS BECOMING THE MOST DOMINANT PEST ON CITRUS IN ALGERIA?

Zine Eddine LABDAOUI, Yamina GUENAOUI\*

Department of Agronomy, University Ibn Badis of Mostaganem, Algeria

\*Corresponding author: yguena@yahoo.fr

### Abstract

In the last few years the aphid *Aphis spiraecola* Patch (Hemiptera: Aphididae) has become the most abundant pest in Algeria. Its population dynamics is connected with favourable factors (young shoots of *Citrus* and suitable climatic factors) or unfavourable factors causing its death as unsuitable natural enemies or high temperatures. The objective of this work was to evaluate the potential of parasitoids associated with *A. spiraecola* for understanding why this aphid species was not efficiently controlled by natural enemies. This study was carried out during the spring leaf-flushing period in 2016 and 2017 in 02 orchards located in 02 sites situated in the Mostaganem region. Sampling of 100 infested young leaves weekly taken from 10 citrus trees in each site showed the predominance of *A. spiraecola* with high densities reaching at least 150 aphids per leaf (10 individuals per cm<sup>2</sup>). The total parasitism rate remained below 3%. We identified two primary parasitoid species *Lysiphlebus testaceipes* Cresson and *Binodoxys angelicae* Haliday (Hymenoptera: Braconidae) and 6 secondary parasitoid species (hyperparasitoids) with the first record in Algeria of an hyperparasitoid belonging to Charipinae (Hymenoptera: Fitigidae). The parasitism rate in the plantation conducted under a conventional management with sprays of insecticides was by far lower than parasitism rate obtained under ecological management. Protection of *Citrus* from *A. spiraecola* feeding is becoming very difficult because of several factors such as early presence of hyperparasitoids in orchard, relative failure of the development of *L. testaceipes* with a high number of aborted mummies (without adult emergence) and the possible presence of endosymbionts in aphids providing protection against parasitic wasps.

**Keywords:** *Citrus* aphids, *Aphis spiraecola*, *Lysiphlebus*, hyperparasitoid abundance, biological control failure.

### Introduction

The green citrus aphid (*Aphis spiraecola* Patch) is among the most damaging aphid species in Algeria, because high populations feed on tender shoots (young leaves, buds, flowers) and spring time attacks are the most deleterious causing distorted foliage and dropping of flowers. It is one of the four main species recorded in Algeria (Mostfaoui et al., 2014; Labdaoui and Guenaoui, 2015). It has a very large indirect impact as it is one of the principal vector of the citrus tristeza virus CTV (Blackman and Eastop, 2000, Addante et al., 2009) with *Toxoptera citricidus* (Kirkaldy) which had been reported in several Mediterranean countries but not yet detected in Algeria. In the Mediterranean region, *A. spiraecola* is one of the most abundant on *Citrus* in Turkey (Satar et al., 2014) and according to Blackman et Eastop (1984) it was found on over 65 plant genera including important crops (*Malus* sp., *Prunus* sp., *Pyrus* sp.). In Spain, it had displaced the native and previously dominant species *Toxoptera aurantii* becoming the most important citrus aphid species after 1960 (Gomez Marco, 2015); with the rational use of pesticides implemented in Spanish citrus, *A. spiraecola* had become the most abundant and harmful aphid species (Hermoso de 2014; Labdaoui and Guenaoui, 2015). The

need of control aphids has always been of central importance in citriculture with an increasing goodwill to promote alternatives measures to chemical control in the framework of sustainable IPM strategies. The objective of this work was to understand why *A. spiraecola* is not enough controlled by its natural enemies. We need to provide more information for a better knowledge about the interactions between native parasitoids and *A. spiraecola* in order to use this information for developing another measure of control without reducing natural biodiversity and in the same time promote the development of sustainability in orchards. We tried to understand the relationships within the the influence of hyperparasitoids appears to be quite complex (Boenisch et al., 1997).

## Material and methods

### Orchards

This study was carried out in 2 citrus orchards (*Citrus clementina* and *Citrus sinensis* Var. Thomson) grafted on *Citrus aurantium* located in Mostaganem region (northwestern Algeria) where the climate is classified as Mediterranean. The clementina orchard named A (more 30 years old) is located at Mazaghran vicinity (35°53' 30.49"N - 0° 5'7.94"E, 1.12 ha) and belongs to the farm of the university of Mostaganem; the orchard was free of pesticides since at least three years. The orange orchard named B (more 15 years old) is a private crop located at Sirat vicinity (35°43' 34.8"N 0°12' 25.5"E, 2.10 ha); this orchard was conducted according to the conventional system with pesticides sprays against several pests.

### Citrus sampling

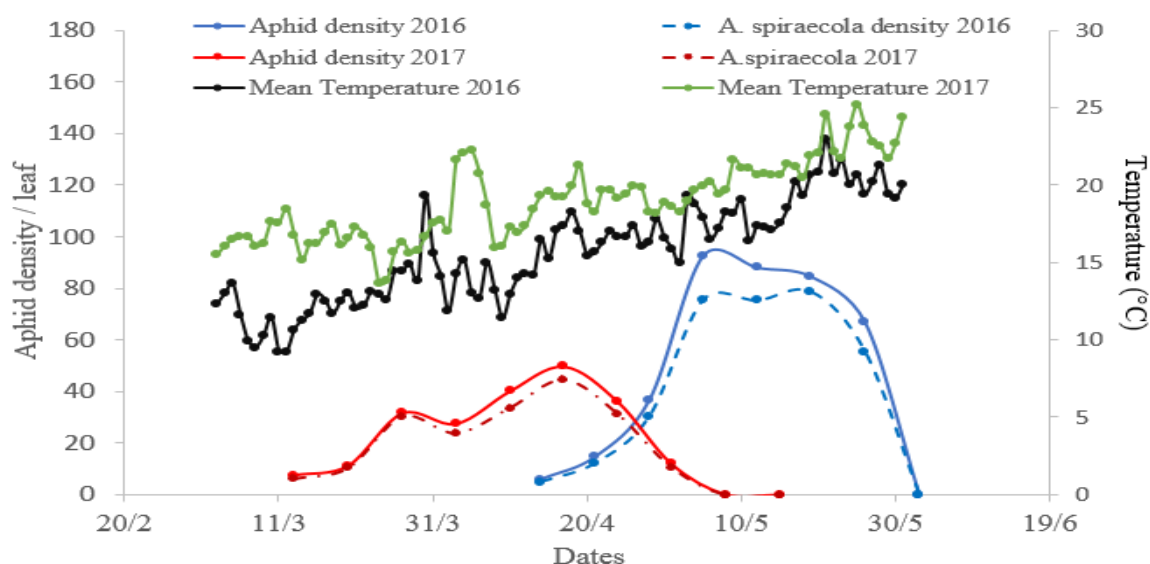
Both orchards were weekly sampled during the leaf flushing period of 2016 and 2017. Ten trees were sampled per orchard and ten tender leaves per tree were randomly cut and placed in a labelled transparent bag with all needed information on samples. They were brought to the laboratory where visual inspection and observation under a stereo-microscope were made to determine the identity of aphid species and of parasitoids using different keys. Full mummies were singly and smoothly put in a gelatin capsule and kept until emergence of parasitoids (primary or secondary wasps). The parasitized aphids were left in the rearing room until mummification. The mummies without emergence were left and counted as aborted mummies

## Results and discussion

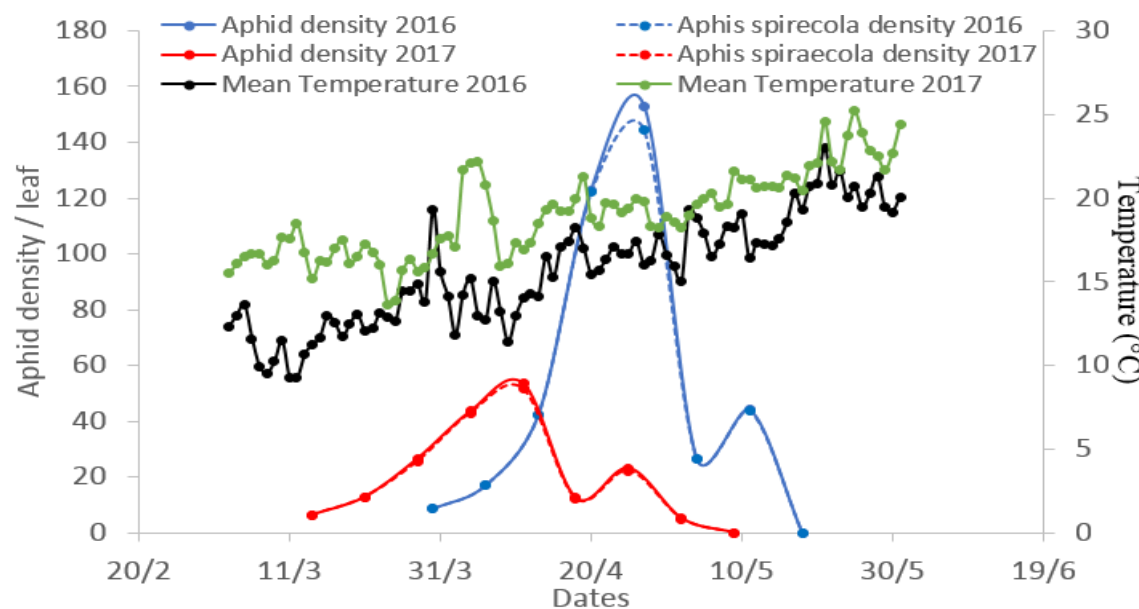
### Aphids:

The aphid populations increased rapidly during 2016 in both sites, resulting in crowding with more winged aphids (alate form) that must alight on citrus with new shoot growth to establish new colonies. We observed the dominance of *A. spiraecola* in both sites and both years with a high percentage varying between 95 and 100% of the total. *A. spiraecola* densities were higher for both sites in 2016. In 2017 mean temperatures were higher, favourating a precocious aphid infestation but keeping aphid densities lower than in 2016.

In site A: results (figure 1) showed a maximum number of aphids varying between 75.63 and 78.77 aphids equivalent to about 6 aphids/ cm<sup>2</sup> during the period from 5<sup>th</sup> May to 19<sup>th</sup> May 2016 and a peak of 44.41 individuals equivalent to 4 aphids/ cm<sup>2</sup> at 17<sup>th</sup> April 2017.



**Fig.1:** Aphid density/ leaf at Mazaghran location (site A) (2016- 2017)



**Fig.2:** Aphid density / leaf at Sirat location (site B) (2016- 2017)

In site B, the aphid *A. spiraecola* densities reached a peak of 144.38 individuals/ young leaf equivalent to 10 aphids/ cm<sup>2</sup> in 2016 and to 51.48 individuals/ young leaf equivalent to 6 aphids/ cm<sup>2</sup> in 2017 (Fig.2). The difference between years is related to climate. Temperatures in 2017 were higher than in 2016 and more suitable for the beginning of flushing and aphid infestation but aphid density were lower because of high temperatures at mid- April leading to a decline of aphid populations. The optimal range of temperature for *A. spiraecola* population growth was estimated between 20 and 30°C (Wang and Tsai, 2000).

## Primary parasitoids

In this study only *Lysiphlebus testaceipes* and *Binodoxys angelicae* (Hymenoptera: Braconidae: Aphidiinae) were found on *A.spiraecola* with a very low parasitism rate remaining below 3% in both sites, not exceeding 0,76% in the sprayed orchard during the investigated period (Figure 3). In Spain, on *A.spiraecola* Gomez et al.,(2016) recorded only *B. angelicae*. In Tunisia, during the period 2010-2011 four primary parasitoids of *A. spiraecola* were recorded (Sellami et al., 2013) and interestingly *L. testaceipes* was found being the predominant primary parasitoid. Initially *L.testaceipes* has been introduced from Cuba to Southern France in 1973 to control *Toxoptera aurantii* (Boyer de Fonscolombe) and *A. spiraecola* as a biological control agent of Citrus in the Mediterranean area (Stary et al., 1988). It has rapidly become widespread and exploited a large number of aphid species in Europe and in Africa Sometimes it could be difficult to identify the species without DNA analyses (Stary et al., 2014). In Algeria it was recorded on several aphid species on diverse host plants (Laamari et al., 2011). The Algerian *L. testaceipes* population recorded in the area of this study is able to complete its development on *A.spiraecola* but a large part of mummies remained full without adult emergence. It is not easy to determine the real causes of this failure.

The figure 3 shows the different rates of the two primary parasitoids, hyperparasitism and mummies remained full without any adult emergence. This last aspect was more dominant varying between 70% to 87%. These results could explain the biological control failure occurring in citrus orchards.

We compared the rate of mummies with adult emergence and without emergence . Analysis by ANOVA showed no significant differences in the ratio of emerged parasitoids at both dates ( $p = 0,442$ ) . The number of non emerged adults was significant ( $p= 0,003$ ) on 05/05 may (date before treatment) and was highly significant ( $p < 0, 0001$ ) on 12/05 may (date after treatment). This could be explained by a more important mortality rate of parasitoids inside the mummy.

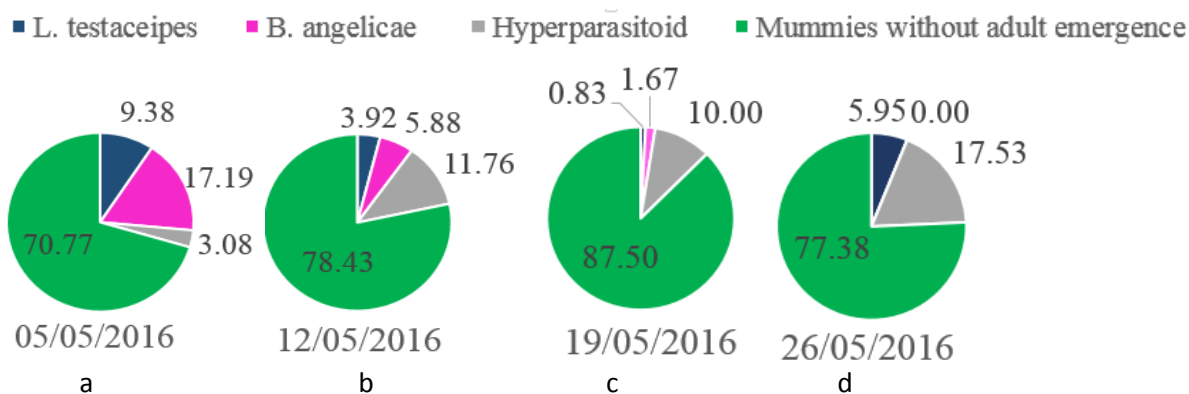


Figure 3( a,b c, d): Rate parasitism (site A) 2016



■ L. testaceipes ■ B. angelicae ■ Hyperparasitoid ■ Mummies without adult emergence

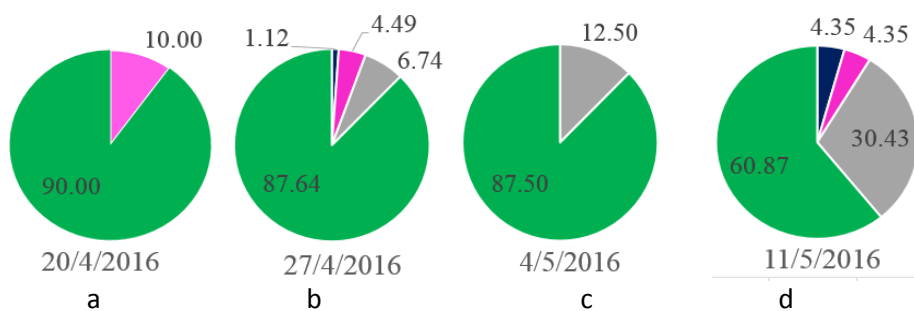


Figure 4 ( a,b,c,d ): Rate parasitism (site B) 2016

■ L. testaceipes ■ Hyperparasitoid ■ Mummies without adult emergence

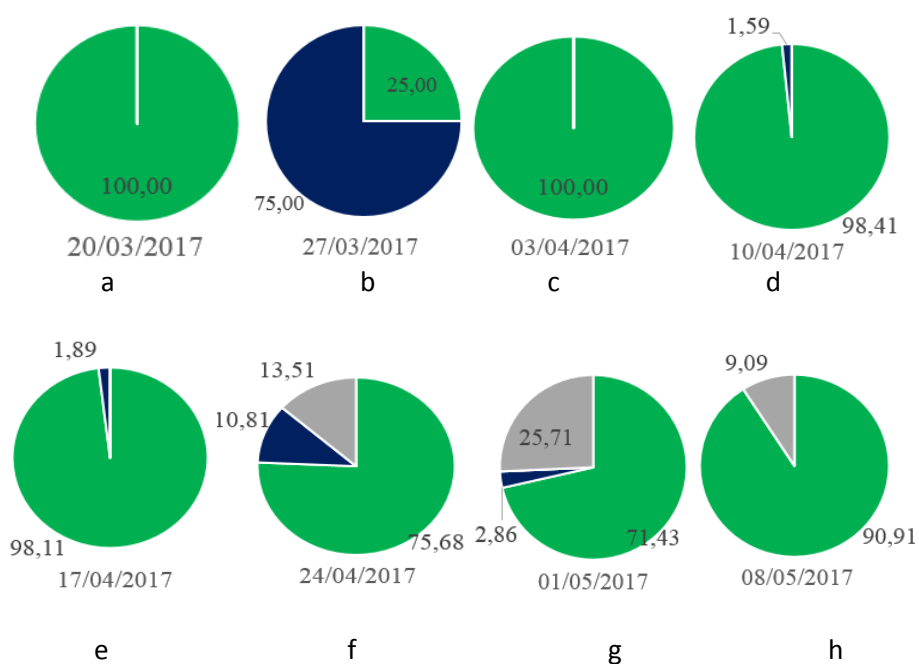


Figure 5 (a,b,c,d,e,f,g): Rate parasitism (site A) 2017

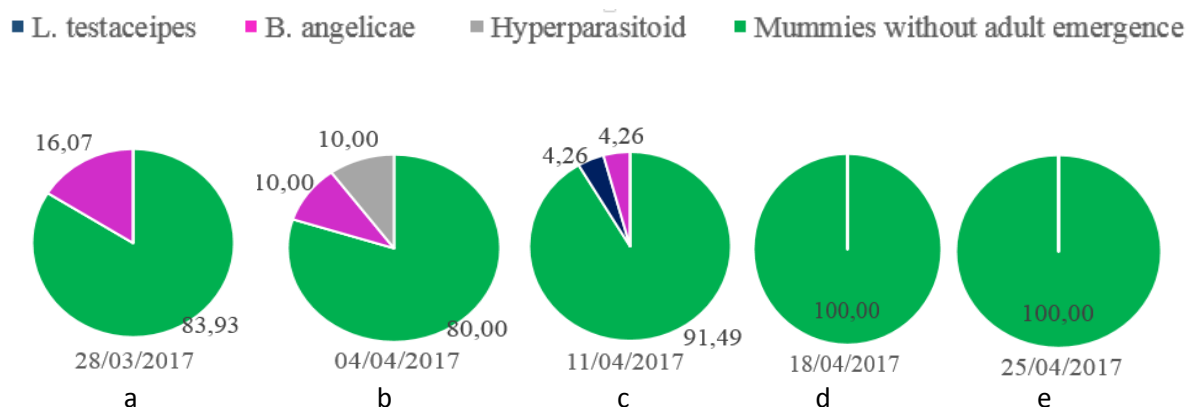


Figure 6 (a,b,c,d,e): Rate parasitism (site B) 2017(Mummies)

### Hyperparasitism

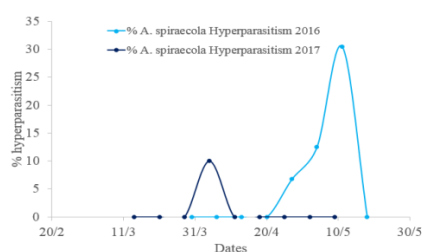


Figure 7 : Hyperparasitism rate (site A)

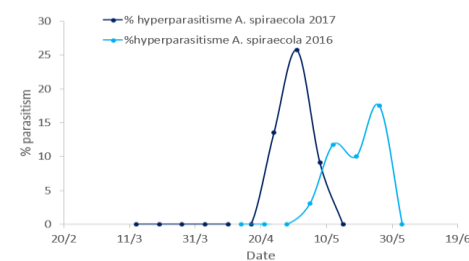


Figure 8 : Hyperparasitism rate (site B).

The hyperparasitism rate on *A. spiraecola* differed between sites and years (Figures 7, 8). In 2016 rate of hyperparasitoids reached 30% at site B and 18% in site A. At least six hyperparasitoid species were recorded from *A. spiraecola* mummies: Two species belonging to *Alloxysta* genus, *Asaphes vulgaris* (Walker), *Pachyneuron aphidis* (Bouche) were recorded in both sites and at site A were recorded *Phaenoglyphis villosa* (Hartig) and a first record from Algeria of *Phaenoglyphis heterocera* (Hartig, 1841) (Ferrer-Suay et al., 2017). A part of hyperparasitoids remained unidentified.

It is well known that the efficiency of primary parasitoids as control agents is affected negatively by high levels of hyperparasitism (Holler, 1993; Sullivan et Volk, 1999). The ecological advantage of the hyperparasitoid presence to an aphid may be due to its negative influence on the primary parasitoids. Hyperparasitoids kill developing parasitoid larvae; their volatils can incite to have escape behaviour in primary parasitoids (Holler et al., 1994). In certain conditions hyperparasitism can impact a parasitoid biological agent and disturb biological control (Schooler et al., 2011). The hyperparasitoid may have a direct effect on the behavioural response of aphids. For instance a single alate *Sitobion avenae* reproduced earlier more offspring in the vicinity of virgin hyperparasitoid females (*Dendrocerus carpenter*) compared with control aphids without hyperparasitoids (Boenisch et al., 1997). Aphids may harbour a wide of variety of facultative bacterial endosymbionts. Several have the ability to protect their hosts against parasitoids (Vorburger, 2014).

## Conclusion

The aphid *A.spiraecola* was found highly predominant varying between 95 and 100%.The two primary parasitoid species *L.testaceipes* and *B. angelicae* are not efficient for control of *A.spiraecola* because they prefer *A.gossypii* or *Toxoptera aurantii* as hosts. Even in orchard free of pesticides the parasitism rate on *A.spiraecola* was very low (3%).The most number of mummies remained full without adult emergence. It is not sure that this biological control failure could be related with presence of defensive symbionts providing aphids with protection against their natural enemies. In addition, these two parasitoid species were early attacked by hyperparasitoids. Because there are few effective parasitoids of *A.spiraecola* in the Mediterranean region it will be interesting to try using another natural enemy with combination with means as providing alternative food for predators by managing the ground cover favouring production of nectar and pollen for natural enemies in early spring with when needed use of chemical control with selective insecticides. In the same time we have to prevent the occurrence of *Toxoptera citricidus* finding new solutions.

## Acknowledgments

We would like to express our gratitude to Dra Mar Ferrer-Suay from Universitat of Valencia, faculty of biological Sciences,(Spain) for the identification of hyperparasitoids from Algeria. We also thank Bernard Chaubet from INRA Rennes (France) for the confirmation of the identity of the primary parasitoids.

## References

- Addante, R., Djelouah, K., & D'Onghia, A. M. (2009). Citrus aphids in Italy: historical review. Options Méditerranéennes–Citrus Tristeza Virus and Toxoptera citricidus: a serious threat to the Mediterranean Citrus industry, 65, 63–68.
- Blackman,R.L., Eastop V.F.(2000); Aphids on the world's crops: an identification and information guide,2 nd edition. John Wiley and Sons, Ltd,Chichester
- Boenisch, A., Petersen, G., & Wyss, U. (1997). Influence of the hyperparasitoid *Dendrocercus carpenteri* on the reproduction of the grain aphid *Sitobion avenae*. Ecol. Entomol., 22(1), 1–6.
- Ferrer-Suay M., Selfa J., Labdaoui M.Z., Guenaoui Y.& Pujade-Villar. (2017). First record of *Phaenoglyphis heterocera* (Hartig, 1841) (Hymenoptera: Cynipoidea: Figitidae: Charipinae) from Algeria. Butlletí de la Institució Catalana d'Història Natural. 81: 17–18.
- Gomez Marco F. (2015). Integrated Pest Management of *Aphis spiraecola* (Hemiptera: Aphididae) in clementines: enhancing its biological control. PhD thesis. Universitat Politècnica de València (Spain). 202p
- Gómez-Marco, F., Urbaneja, A., Jaques, J. A., Rugman-Jones, P. F., Stouthamer, R., & Tena, A. (2015). Untangling the aphid-parasitoid food web in Citrus: Can hyperparasitoids disrupt biological control? *Biological Control*, 81, 111–121.
- Hermoso De Mendoza A., Arouni R., Belliure B., Carbonell E. A. et Pérez-Panadés J. (2006). Intervention thresholds for *Aphis spiraecola* (Hemiptera: Aphididae) on Citrus clementina. *Journal of economic entomology*, 99(4), 1273–1279.
- Holler, Borgemeister,C.,Haardt,H.,&Powell,W.(1993).The relationship between primary parasitoids and hyperparasitoids of cereal aphids:an analysis of field data. *Journal of Animal Ecology*,12-21.
- Höller, C., Micha, S. G., Schulz, S., Francke, W., & Pickett, J. A. (1994). Enemy-induced dispersal in a parasitic wasp. *Cellular and Molecular Life Sciences*, 50(2), 182–185.

- Labdaoui M.Z & Guenaoui Y., (2015). The aphids infesting Citrus orchards and their natural enemies in the Northwestern Algeria. Sixth International Scientific Agricultural Symposium Agrosym 2015, 787–792.
- Laamari M.S.Tahar-Chaouche, H.Merouani,S. Ghodbane N.Khenissa et P.Stary (2011): Interactions trophiques entre pucerons et hymenoptères parasitoïdes observés en milieu naturels et cultivés dans l' Est algérien, Faunistic Entomol., 63 (3), 115–120.
- Mostfaoui H., L. Allal-Benfekih, Z.E. Dzazouli, D. Petit, G. Saladin.(2014). Why the aphid *Aphis spiraeicola* is more important on Clementine tree than *Aphis gossypii*? C.R. Biologies 337,123–133.
- Petrović-Obradović, O., Vukašinić, D., Vučetić, A., Milovanović, P., & Krnjajić, S. (2009). *Aphis spiraeicola* patch.-new pest of apple in Serbia. Biljni Lekar, 37(1), 7–10.
- Satar S., G.Satar, M.Karacaoglu, N.Uygun, N. Kavalliaratos, P.Stary and C.G. Athanassiou. Parasitoids and Hyperparasitoids on Aphids infesting citrus in east Mediterranean region of Turkey.Journal of Insect Science 14 (178) 2014.
- Schooler S.S, P. De Barro, Ives, A.R, (2011). The potential for hyperparasitism to compromise biological control: Why don't hyperparasitoids drive their primary parasitoid hosts extinct? Biological Control, 58, 167–173.
- Sellami, E. L., Delvare, G., & Chermiti, B.(2013). Parasitoids and hyperparasites of citrus aphids in northern east of Tunisia (Cap Bon). IOBC-WPRS Bulletin, 95, 131–139.
- Starý, P., Lyon, J. P., & Leclant, F. (1988). Biocontrol of aphids by the introduced *Lysiphlebus testaceipes* (Cress.)(Hym., Aphidiidae) in Mediterranean France. Journal of Applied Entomology, 105(1-5), 74–87.
- Starý, P., Kavalliaratos, N. G., Petrović, A., Žikić, V., Rakhshani, E., Tomanović, S., Tomanović Ž. et Havelka, J. (2014). Interference of field evidence, morphology, and DNA analyses of three related *Lysiphlebus* aphid parasitoids (Hymenoptera: Braconidae: Aphidiinae). Journal of Insect Science, 14(171), 1–6.
- Sullivan, D.J., Völkl, W., 1999. Hyperparasitism: multitrophic ecology and behavior. Annu. Rev. Entomol. 44, 27.
- Tang, Y. Q., & Yokomi, R. K. (1996). Biology of *Aphelinus spiraeicolae* (Hymenoptera: Aphelinidae), a parasitoid of the spirea aphid (Homoptera: Aphididae). Environmental entomology, 25(2), 519–523.
- Vorburger C. (2014). The evolutionary ecology of symbiont-conferred resistance to parasitoids in aphids. Insect Science institute of Zoology, Chinese Academy of Sciences, 21,251-264.
- Wang J. J., & Tsai, J.H. (2000). Effect of temperature on the biology of *Aphis spiraeicola* (Homoptera: Aphididae). Annals of the Entom. Society of America, 93(4), 874-883.

## TEXTURAL PROPERTIES OF WHITE CHEESE MADE OF INFRA RED PASTEURIZED MILK AND AGED IN POTASSIUM CHLORIDE (KCL) SUBSTITUTED BRINE

Simin HAGH NAZARI\*<sup>1</sup>, Mohammad Reza AZIMI<sup>2</sup>, Sajjad VALINEZHAD<sup>1</sup>

<sup>1</sup>Department of Food Science and Technology, Faculty of Agriculture, University of Zanjan, Zanjan, Iran

<sup>2</sup>Cultivation Department, Faculty of Agriculture, University of Zanjan, Zanjan, Iran.

\*Corresponding author:haghazari.simin@znu.ac.ir

### Abstract

At present time the new methods are replacing the traditional food technologies which they have potential to reduce production costs. Using infrared irradiation heat for milk pasteurization as a technology with the high thermal efficiency can be a good alternative to traditional methods of milk processing. In addition by replacing potassium chloride instead of sodium chloride in the formula of the salt water of white cheese, the adverse health effects resulting from the consumption of sodium chloride can be prevented.

In this investigation, by using the infrared radiation heat, raw cow milk prepared of Zanjan University animal husbandry was pasteurized and then white cheese produced from it in 2016. The white cheese was placed in four different formulations of brine containing 1) NaCl: KCl, 10:0 percent 2) NaCl: KCl, 7.5: 2.5 percent, 3) NaCl: KCl, 5:5 percent and 4) NaCl: KCl, 0:10 percent for 21 days at a temperature of 8° C. Then the texture characteristics of the cheeses were evaluated. Texture analysis of cheese showed that by reducing the amount of sodium chloride, the strength of cheese texture decreases and there was a significant difference between the strength of two types produced cheeses.

**Key Words:** *NaCl, KCl, White Cheese, Brine, Infrared pasteurizing*

### Introduction

Cheese is the ripened or unripen soft, semi-hard, hard, or extra-hard product, which may be coated, and in which the whey protein/casein ratio does not exceed that of milk (CODEX GENERAL STANDARD FOR CHEESE. 283-1978)<sup>7</sup>. Cheese contains less water than milk, and so has different organoleptic properties and shelf life than milk (Walstra et al., 2006). Cheese is a rich source of protein, fat, calcium, phosphorus, riboflavin and other vitamins. Also it can be more useful than milk in high protein diets, also its proteins are highly digestible (Renner, 1993).

Traditional production of white cheese in brine has been popular for centuries in small-scale cow keeping farms and that way it was difficult to set the standard for the properties and composition of the cheese. Along with the recent developments in dairy product processing industry and with the integration of mechanization and automation, large-scale production of cheese became possible (Ozer, 2014).

Salting is an important stage in the process of cheese. History of salt used as an additive is related to 3,000 years before Christ (Woodin, 1981; Durack et al., 2008). Salt is considered as an additive commonly used in the food industry and plays a vital role in the food processing including food protection, helping to improve the flavor, the impact on proteolysis, water

---

<sup>7</sup>. [www.fao.org/input/download/standards/175/CXS\\_283e.pdf](http://www.fao.org/input/download/standards/175/CXS_283e.pdf)

activity and strength in the tissue (Reddy and Marth, 1991; Guinee, 2004a; Guinee and Fox, 2004). Salt provides about 90 percent of the sodium in the human diet (He et al., 2012). In the structure of the salt, the sodium intake is very important to control the membrane potential of the cell and absorption of nutrients in the small intestine. In order to maintain the blood volume, osmotic pressure on the cell and also transportation of nervous signals, sodium is essential (Strazzullo et al., 2009; He and MacGregor, 2010).

Although salt plays an important role during food processing, but has been known to be a major risk for diseases such as osteoporosis due to urinary excretion of calcium chloride, kidney stones and high blood pressure (Beumi et al., 2002; Kotchen, 2005 ; Massey, 2005; Heaney, 2006). World Health Organization has recommend food manufacturers to reduce the use of salt (WHO, 2007). Meat, dairy, bakery and other food products, each include a different percentages of sodium uptake by the body in different classes in the world for example, the daily intake of sodium through cheese in England, France, America and Australia, have been reported 7.8, 9.2, 8.2 and 5% namely (Meneton et al., 2009; Anderson et al. , 2010). So many efforts have been made for producing of low-salt cheese using different techniques such as reducing the amount of salt or partial replacement of salt in cheese with other materials (Guinee and O'Kennedy, 2007). Reducing the salt content of the Cheddar cheese and the effects of these changes on the chemical composition, proteolysis, sensory properties and microbial growth were done by Schroeder and colleagues (1988b). Replacing salt with other materials such as potassium chloride, calcium chloride and magnesium chloride may be considered as a successful strategy to reduce the amount of salt (Kilcast and den Ridder, 2007).

Also partial replacement of sodium chloride with potassium chloride revealed that the quality of the cheese has not significantly changed (Guinee, 2004b). Potassium chloride salt is acknowledged as a potential alternative to sodium chloride in cheese making. Increasing potassium intake has been reported as a protection factor for people with hypertension (Fregly, 1981; Reddy and Marth, 1991). A mixture of potassium chloride and sodium chloride has been successfully used in cheese production and no adverse effects have been reported on the quality of the cheese (Fitzgerald and Buckley, 1985). Several studies have been also made on the effect of replacing sodium chloride with potassium chloride on the properties of Cheddar (Reddy and Marth, 1993a), feta cheese (Katsiari, et al., 1997; 2000a), Kefalograviera cheese (Katsiari et al., 2001a), and Fynbo cheese (Zorrilla and Rubiolo, 1994; Zorrilla et al., 1996), but there is not any investigation on white cheese made of IR pasteurized milk and aged in KCl substituted brine.

Infrared heating is an alternative preservation method with higher thermal efficiency which transfers thermal energy in the form of electromagnetic waves. Recent applications of infrared heating indicate this technology is a viable alternate for the pasteurization of liquid foods, in addition it can decontaminate foodstuffs in both liquid and solid foods with retaining higher levels of health promoting compounds (Hagh Nazari. 2014).

The aim of this research is to study the effects of replacement of NaCl with KCl salt on the textural properties of ripened white brined cheese made from pasteurized milk using infrared irradiation.

### **Materials and Methods**

Cheese making method: for the preparation of cheese, raw milk from the dairy farm of Zanjan University was prepared. Raw milk was pasteurized using flavor wave Turbo device that emits infrared waves at 72 ° C for 15 seconds has shown in figure 1. The temperature of the process was checked by a digital thermometer model TES made in China. For comparing and evaluating the effects of the pasteurization methods, the milk was also pasteurized using

classic (conventional) methods. After pasteurization of milk, 200 ml of milk was poured in lidded plastic containers of the same shapes in 3 replicates equaled 24 samples.



Figure 1: Flavor wave Turbo device

After the milk temperature reached to 35 ° C; the kefir starter solution to the volume of 2 ml along with calcium chloride to the amount of 0.02% of the milk were added to the pasteurized milk. The samples were transferred to an incubator made in Memmert Company in Germany at 35°C. And 20 minutes after adding the starter, the fungal rennet Valiren made in America was added to the amount of 0.0025 gr to each container at 35°C.

After clot formation, clots were left without cutting for 12 hours in 18°C to continue fermentation, coagulating and dewatering. The resulting clots were transferred to salt solutions containing: 1) NaCl: KCl, 10:0 percent 2) NaCl: KCl, 7.5: 2.5 percent, 3) NaCl: KCl, 5:5 percent and 4) NaCl: KCl, 0:10 percent for 21 days at a temperature of 8° C. After ripening, tissue analysis was conducted on the cheese.

Chemical tests: measurement of chemical compounds was conducted by AOAC methods (AOAC, 2012). Moisture, fat and protein contents were measured using the oven at 102 degrees Celsius, Gerber method, and Kjeldahl method respectively. PH was measured by Professional portable milk pH Meter HI98162 provided by Hanna Company.

Texture analysis: For this purpose the texture analyzer device TA.HD plus made in Stable Micro Systems Company in England was used for tissue analysis (TPA test).The speed of probe coming down was set on 5 mm / sec.

Statistical analysis: factorial experiments were conducted in a completely randomized design with three replications. The statistical comparison was done using the Mstat-C software via Duncan's method.

## **Results and discussion**

The comparison of the clots formed from pasteurized milk using infrared radiation (1) and Classic method (2) shows that the volume of the Infrared irradiated samples are smaller with higher coherence and solidity.

✚ Texture analysis:

The results of texture analysis are shown in Figure 2. Description of the charts and data extracted from the analysis are reported in bellow of the tables.

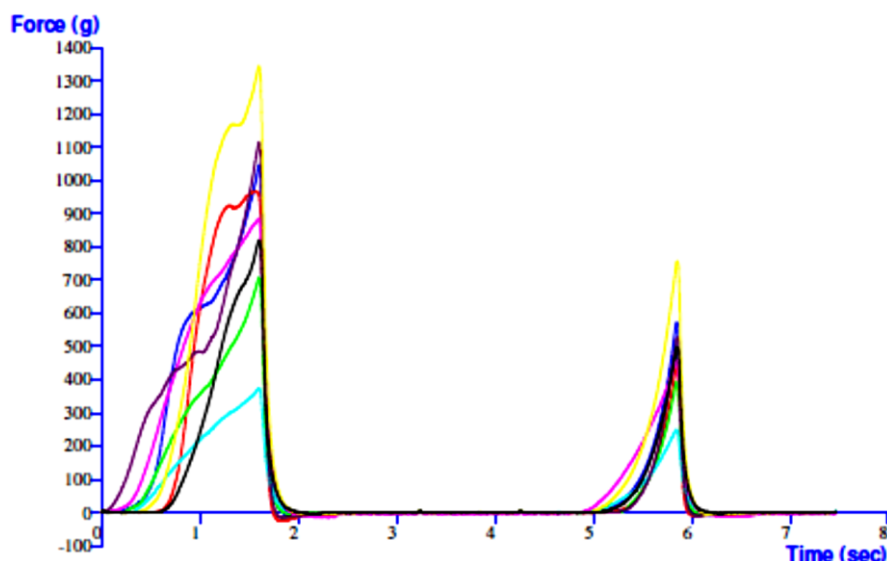


Figure 2: Texture analysis curves of the clots formed from pasteurized milk using infrared radiation (1: left) and Classic method (2: right) at 72° C for 15 seconds. The color description of Texture analysis is as follows:

Number of Formul	Color	Brined Formulations	Methods of Milk
1	Yellow	10% NaCl	IR
2	Violet	7.5:2.5 % - NaCl:KCl	IR
3	Blue	5:5 % - NaCl:KCl	IR
4	Red	10% KCl	IR
5	Pink	10% NaCl	Classic
6	Black	7.5:2.5 % - NaCl:KCl	Classic
7	Green	5:5 % - NaCl:KCl	Classic
8	Sky blue	10% KCl	Classic

Results of the area under the curve of the cheese samples in texture analysis show the difference in firmness and resistance to breakdown between the two methods of milk pasteurization. Data and graph obtained from tissue analysis shows that by reducing the amount of NaCl in the brine formulation, the area under the graph and the force required to breakdown of the texture of cheese is reduced. Also cheeses made from pasteurized milk using infrared radiation are more resistant to breakdown than cheeses made from pasteurized milk using the classic method. The reason of these differences can be due to high calcium concentration in cheese and its role in the increasing the coherence and strength of the cheese texture made from pasteurized milk using infrared radiation than of the classical method product because calcium chloride helps the tissue solidarity.

Overall, comparison of data means resulting from the analysis of the cheese characteristics show that the cheeses made from two types of pasteurized milk and different brine formulations only differ significantly in the firmness and resistance to breakdown between the two cheese preparation methods. Also changing the formula of the brine had no significant effect on the microbial load.

**✚ The use of potassium chloride in the formula of the cheese brine:**

The reason of the replacement of sodium chloride with potassium chloride, is achieving a product that reduces harmful effects to health caused by the consumption of sodium chloride.



In addition to the fact that the product is supposed to be acceptable in terms of evaluated properties. The results of the analysis showed that the only difference between white cheeses produced in different brine formulas is in their firmness. Reduced sodium salt cheese is very soft, bitter, less salty, and has a strong off-flavor and shorter shelf life (Ying Lu, 2012). Potassium chloride (KCl) has a similar structure and salty flavor as sodium chloride (salt) and partial replacement of salt with potassium chloride can be used to lower salt content in foods. Moreover, potassium can lower the blood pressure and the risk of heart disease or stroke. Thus, potassium chloride is a potential substitution for salt in cheese. In general, from this study it can be concluded that changing the formulation of the used brine only affects the cheese texture and has no effects on other properties.

#### **✚ Effects of brine formula on The cheese texture**

in 1998 and 2000, Katsiari pointed out that the changes in the amount of fat, protein and other compounds of cheese occurred by the lipolysis, proteolysis, lactic acid production and other reactions happened during the ripening period not due to brine formula. Although added calcium chloride can effect on cheese density and volume of cheese due to participating in paracaseinate calcium clots which induce the syneresis reaction improve (Fuca, 2012).

The effect of different levels of salt in the brine solution in this investigation shows that at high levels of sodium chloride, the cheese firmness is greater than the other brine formulas. In confirmation of this; results of Katsiari's study in 1998, 2000 and 2001 shows a decrease in firmness by reducing the amount of sodium chloride in cheese. He also showed that by reducing the amount of sodium chloride, the texture becomes softer due to reduction of syneresis and remaining more moisture in the texture of the cheese. In terms of chemical composition, according to the anions of both compounds being the same, cations can be checked on the solubility of the two compounds. The Sodium ion has a smaller radius than the potassium ion. Under the rule of Fajanz rules, the ionic potential of the sodium ion is more than the potassium ion. Sodium ions form a stronger bond with chlorine. By increasing salt in the cheese, the syneresis also increases. Potassium chloride salt is more soluble in the aqueous phase of the cheese and treatments containing potassium chloride salts are softer and have a lower hardness (Katsiari et al., 1998, 2000, 2001). The effect of partial substitution of NaCl with KCl on texture profile and microstructure of Halloumi cheese also was recorded by Ayyash et al., in 2010. They investigate the effect of NaCl substitution with KCl on the microstructure of cheeses. Hardness, cohesiveness, and gumminess of cheese decreased significantly during storage period with the same salt treatment, whereas adhesiveness significantly increased (Ayyash et al., 2010). They resulted that the microstructure of all cheeses became more closed and compact with storage period. Color values and texture parameters of NIR-treated (50-s treatment) ham slices were not significantly ( $P > 0.05$ ) different from those of no treated samples (Won Ha, 2012). Also according to the table 1, due to the lower destruction of the compounds of the milk in the infrared radiation method, there isn't any reduction of dry mass content. In addition this investigation showed that cheeses produced from milk pasteurized using the infrared irradiation was firmer compared to the cheeses produced using the classic method. All above studies confirms this project's results due to the higher efficiency and saving energy consumption via IR assisted systems in comparison of classic method of pasteurization.

### **Conclusion**

In general, from this study it can be concluded that changing the formulation of the used brine only affects the cheese texture and has no effects on other properties.

Effects of brine formula on the cheese texture shows that at high levels of sodium chloride, the cheese firmness is greater than the other brine formulas.

The effect of infrared radiation in cheese production showed no significant difference between the cheeses produced from pasteurized milk using the infrared and classic methods but the pasteurization process of milk is approximately 75% faster than the classic method due to the high heat performance in the infrared radiation.

### References

- Aly M. E. (1995). An attempt for producing low-sodium Feta type cheese. *Food Chem.* 52: 295-299.
- Anderson, C. A., Appel, L. J., Okuda, N., Brown, I. J., Chan, Q., Zhao, L., Ueshima, H., Kesteloot, H., Miura, K., Curb, J. D., Yoshita, K., Elliott, P., Yamamoto, M. E., Stamler, J. (2010). Dietary sources of sodium in China, Japan, the United Kingdom, and the United States, women and men aged 40 to 59 years: the INTERMAP study, *J. Am. Diet. Assoc.* 110: 736–745.
- Ayyash, M.M, Sherkat, F., Francis, P. Williams R.P. W. Shah N.P. (2011). The effect of sodium chloride substitution with potassium chloride on texture profile and microstructure of Halloumi cheese. Volume 94, Issue 1, Pages 37–42.
- AOAC. (1995). Official Methods of Analysis. AOAC International, Arlington, VA.
- Buemi, M., Senatore, M., Corica, F., Aloisi, C., Romeo, A., Tramontana, D., et al. (2002). Diet and arterial hypertension: Is the sodium ion alone important. *Medicinal Research Reviews*, 22(4): 419–428.
- Binker, E. F., and Kolari, O. E. (1975). The history and use of nitrate and nitrite in the curing of the meat. *Food Cosmet. Toxicol*, 13: 655-661.
- Durack, E., Alonso-Gomez, M., and Wilkinson, M. G. (2008). Salt: A review of its role in food science and public health. *Current Nutrition and Food Science*, 4: 290 - 297.
- Fitzgerald, E. and Buckley, J. (1985). Effect of total and partial substitution of sodium chloride on the quality of Cheddar cheese. *Journal of Dairy Science*, 68:3127-3134.
- Fregly, M. J. (1981). Sodium and potassium. *Annual Review Nutrition*, 1: 69-93.
- Fucà N, McMahon DJ, Caccamo M, Tuminello L, La Terra S, Manenti M, Licitra G. *J Dairy Sci.* 2012 Jan;95(1):460-70. doi: 10.3168/jds.2011-4438. PMID: 22192226.
- Guinee, T. P., & O’Kennedy, B. T. (2007). Mechanisms of taste perception and physiological controls. In: T. P. Guinee, & B. T. O’Kennedy (Eds.), *Reducing salt in foods: Practical strategies* (pp. 246-287). Boca Raton LA, USA: CRC Press.
- Guinee, T. P. (2004a). Salting and the role of salt in cheese. *International Journal of Dairy Technology*, 57: 99-109.
- Guinee, T. P. (2004b). Scrap the salt: as concern about the high salt content of cheese rises. *Dairy Industries International*, 69: 36 - 38.
- Guinee, T. P., and Fox, P. F. (2004). Salt in cheese: Physical, chemical and biological aspects. Pages 207-259 In *Cheese: Chemistry, physics and microbiology General aspects*. Vol. 1. 3 ed. P. F. Fox, P. McSweeney, L. H., Cogan, T. M., and Guinee, T. P., edr. Elsevier Academic Press, London, UK.
- Hagh Nazari, S. (2014). Impact of using infrared irradiation energy in food processing. *Energy Education Science and Technology Part A: Energy Science and Research*. Volume (issues) 32(2): 1387-1396.
- Heaney, R. P. (2006). Role of dietary sodium in osteoporosis. *J. Am. Coll. Nutr.* 25: 271–276.
- He, F. J., MacGregor, G. A. (2010). Reducing population salt intake worldwide: from evidence to implementation, *Prog. Cardiovasc. Dis.*, 52: 363 – 382.

- Institute of Standards and Industrial Research of Iran N° 4413: 2010, Milk and milk products- Detection of Salmonella, 1<sup>st</sup> – Revision.
- Institute of Standards and Industrial Research of Iran N° 2406: 2008, Microbiology of milk and milk products-Specifications. 2nd revision, Karaj. 2008.
- Institute of Standards and Industrial Research of Iran N° 10154: 2007, Milk and milk products – Enumeration of colony-forming units of yeasts and/or molds-colony - Count Technique at 25°C. 1<sup>st</sup> – Edition.
- Institute of Standards and Industrial Research of Iran N° 6083-3: 2006, Microbiology of food and animal feeding stuffs- Horizontal method for the enumeration of positive Staphylococci –coagulase (Staphylococcus aureus and other species)-Part 3: Detection and MPN technique for low numbers. 1<sup>st</sup> – Edition.
- Institute of Standards and Industrial Research of Iran N° 5486-1, 2: 2002, Milk and milk product, Enumeration of coliforms part 2: Most probable number technique at 30°C. 1<sup>st</sup> – Edition.
- Institute of Standards and Industrial Research of Iran 5234: 2000, Milk and milk products – enumeration of presumptive Escherichia coli - MPN technique.
- ISO 6611:2004 (IDF 94: 2004). Milk and milk products -- Enumeration of colony-forming units of yeasts and/or moulds -- Colony-count technique at 25 degrees C.
- ISO 6785:2001 (IDF 93: 2001). Milk and milk products -- Detection of Salmonella spp.
- ISO 11866-1:2005 (IDF 170-1: 2005). Milk and milk products -- Enumeration of presumptive Escherichia coli -- Part 1: Most probable number technique using 4-methylumbelliferyl-beta-D-glucuronide (MUG).
- ISO 11866-2:2005 (IDF 170-2: 2005). Milk and milk products -- Enumeration of presumptive Escherichia coli -- Part 2: Colony-count technique at 44 degrees C using membrane.
- Jae-Won Ha, Sang-Ryeol Ryu and Dong-Hyun Kang. (2012). Evaluation of Near-Infrared Pasteurization in Controlling Escherichia coli O157:H7, Salmonella enterica Serovar Typhimurium, and Listeria monocytogenes in Ready-To-Eat Sliced Ham. Appl. Environ. Microbiol. 78:18 6458-6465.
- Kamleh, R., Olabi, A., Toufeili, I., Daroub, H., Younis, T. and Ajib, R. (2015), The effect of partial substitution of NaCl with KCl on the physicochemical, microbiological and sensory properties of Akkawi cheese. J. Sci. Food Agric., 95: 1940–1948. doi:10.1002/jsfa.6906.
- Katsiari, M. C., Voutsinas, L. P., Alichanidis, E., & Roussis, I. G. (1997). Reduction of sodium content in Feta cheese by partial substitution of NaCl by KCl. *International Dairy Journal*, 7(6-7): 465-472.
- Katsiari, M. C., Voutsinas L. P., Alichanidis E., Roussis G. (1998). Manufacture of Kefalograviera cheese with less sodium by replacement of NaCl with KCl. *Food Chem.*, 61: 63-70.
- Katsiari, M. C., Voutsinas, L. P., Alichanidis, E. and Roussis, I. G. (2000). Proteolysis in reduced sodium Feta cheese made by partial substitution of NaCl by KCl. *International Dairy Journal*, 10: 635-646.
- Katsiari, M. C., Voutsinas, L. P., Alichanidis, E. and Roussis, I. G. (2001). Lipolysis in reduced sodium Kefalograviera cheese made by partial substitution of NaCl with KCl. *Journal of Food Chemistry*, 72: 193-197.
- Kilcast, D. and den Ridder, C. (2007). Sensory issues in reducing salt in food products Pages 201-220 In Reducing Salt in Foods: Practical Strategies. Kilcast, D. and Angus, F., edr. CRC Press LLC, Washington DC, USA.
- Kotchen, T. A. (2005). Contributions of sodium and chloride to NaCl-induced hypertension. *Hypertension* 45: 849–850.

- Krishnamurthy, K., Khurana, H.K., Soojin, J., Irudayaraj, J. and Demirci, A. (2008). Infrared Heating in Food Processing: An Overview. *Comprehensive Reviews in Food Science and Food Safety*, 7, 2-13. <http://dx.doi.org/10.1111/j.1541-4337.2007.00024.x>.
- Massey, L. K. (2005). Effect of dietary salt intake on circadian calcium metabolism, bone turnover, and calcium oxalate kidney stone risk in postmenopausal women. *Nutr. Res.* 25: 891–903.
- Meneton, P., Lafay, L., Tard, A., Dufour, A., Ireland, J., Menard, J., Volatier, J. L. (2009). Dietary sources and correlates of sodium and potassium intakes in the French general population, *Eur. J. Clin. Nutr.*, 63: 1169–1175.
- Nakata, Tubasa. Okamoto, Arisa. Sawai, Jun, Kikuchi, Mikio (2015). Effects of Far-Infrared Irradiative Heating Pasteurization on Fungi T. *Journal of Biosciences and Medicines*, 2015, 3, 60-65.
- Reddy, K. A., and Marth, E. H. (1993). Lipolysis in Cheddar cheese made with sodium chloride, potassium chloride or mixtures of sodium and potassium chloride. *Milchwissenschaft*. 48: 488-493.
- Reddy, K. A., and Marth, E. H. (1991). Reducing the sodium content of foods: A review. *Journal of Food Protection*. 54: 138-150.
- Renner, E. (1993). Nutritional aspects of cheese. In: P. F. Fox (Ed), *cheese: chemistry, physics and microbiology Vol 1*(pp, 557-559). London: Elsevier applied science.
- Schroeder, C. L., Bodyfelt, F. W., Wyatt, C. J., & McDaniel, M. R. (1988). Reduction of sodium chloride in cheddar cheese: effect on sensory, microbiological, and chemical properties. *Journal of Dairy Science*, 71(8): 988-993.
- Strazzullo, P., D'Elia, L., Kandala, N. B., Cappuccio, F. P. (2009). Salt intake, stroke, and cardiovascular disease: meta-analysis of prospective studies. *BMJ*, 339: 1 – 9.
- Walstra, P., Wouters, J., & Geurts, T. (2006). Principles of Cheese Making. In P. Walstra, J. Wouters, & T. Geurts, *Dairy Science and Technology* (pp. 577-582). NW: Taylor & Francis Group, LLC.
- World Health Organization. 2007. Reducing salt intake in populations: Report of a WHO forum and technical meeting. Accessed August 7, 2008. [http://www.who.int/dietphysicalactivity/reducingsaltintake\\_EN.pdf](http://www.who.int/dietphysicalactivity/reducingsaltintake_EN.pdf).
- Woodin, G. B. (1981). Salt maintains essential role as excess use is criticized. *Journal of Food Development*, 15: 38-41.
- Ying, Lu. Effects of Sodium Chloride Salting and Substitution with Potassium Chloride on Whey Expulsion of Cheese. Thesis for Master of Science. 2012. Utah State University.
- Zorrilla, S. E., Castelao, E. L., De Pianta, D., & Rubiolo, A. C. (1996). Proteolysis during ripening of low-fat Fynbo cheese salted with a mixture of NaCl and KCl. *The Australian Journal of Dairy Technology*, 51: 6-7.
- Zorrilla, S. E., and Rubiolo, A. C. (1994). Modeling NaCl and KCl movement in Fynbo cheese during salting. *J. Food Sci.* 59:976–980.

## CORRELATION BETWEEN INDIGENOUS AND COMMERCIAL STRAINS OF YEAST IN THE PRODUCTION OF WINE FROM THE GRAPE VARIETY VRANEC

Kire PETROV<sup>1\*</sup>, Fidanka ILIEVA<sup>2</sup>, Violeta DIMOVSKA<sup>2</sup>, Nataša GUNOVA<sup>2</sup>

<sup>1</sup>Winery “Tikves” 810 No.2. 1000 Skopje, Republic of Macedonia

<sup>2</sup>University “GoceDelcev”, Faculty of Agriculture, KrsteMisirkov bb, 2000 Stip, Republic of Macedonia

\*Corresponding author: kire.petrov@tikves.com.mk

### Abstract

This scientific research determined the impact of indigenous and commercial yeast strain on the production of wine from the grape variety Vranec, grown on Crveni bregovi locality, near Negotino, at an altitude of 250 m. The main objective was to display the correlation between indigenous yeast strains F-8 and F-78 with the commercial strain D-80 (Lallemand). The domestic yeast F-8 and F-78 were previously isolated at the Tikves wine region, Republic of Macedonia. The main purpose of this research is to make a comparison between the wine produced from indigenous yeast strains F-8 and F-78 with the commercial strain D-80. The chemical analysis of the wine, monomeric anthocyanins, polyphenolic composition, and the color intensity of the wine produced from the domestic yeast strains, were compared with the wine produced from the commercial yeast strain. The basic parameters, such as alcohol, sugar, total acids, volatile acids, pH, free/total SO<sub>2</sub>, were determined applying international methods of analysis of wines and musts (OIV methods). The correlation value between the main parameters was obtained by using the statistical analysis of the results obtained by applying the software package SPSS 19. The analysis shows that there is a correlation between the analyzed parameters of the wine from the grapevine Vranec, among different strains of yeasts. The Pearson's coefficient of correlation ( $\rho$ ), between wine Vranec from F-8 and D-80 is (.996) which means high correlation value. Also, the Pearson's coefficient of correlation ( $\rho$ ), between wine Vranec from F-78 and D-80 is (.999) which means really high correlation value.

**Keywords:** *indigenous yeasts, wine, Vranec, anthocyanins.*

### Introduction

Vranec is one of the most important red grape varieties in Republic of Macedonia, grown in all vineyards, mostly in the Tikveš wine region. (Ivanova et al.,2014).

In the modern stage of wine production, selected wine yeasts are used, which leads to significant technological progress. The main reasons are: fast and effective controlled alcoholic fermentation of the grape must with a high concentration of sugars, resistance to high concentrations of ethanol and SO<sub>2</sub>, and resistance at higher temperatures during fermentation. The increasing use of these commercial yeasts, leads to a loss of indigenous strains of yeasts. The selection of indigenous strains of yeasts with good characteristics, can be successfully shown through the production of quality wines. It would have improved the biodiversity of a region, would be enriched biological heritage, which is of particular importance in the production of wines of controlled origin. (Ilieva et al.,2016).

Domestication of wine yeast, while inadvertent until recent decades, has generated strains that differ considerably from “wild” *S. cerevisiae* strains. Inoculations of “wild” *S. cerevisiae* yeasts can influence the process of fermentation and greatly affect the quality of the wine. Isolating strains from successful fermentations for inoculation in subsequent vintages was

being practiced during winemaking in order to avoid unwanted malolactic or acetic fermentation. Largely, the specifics and the most important quality characteristics of the wine are due to the natural microflora of the grape of the viticulture region. (Ilieva et al.,2013). Furthermore, *S. cerevisiae* strains selected from the indigenous population of domestic winemaking enable the alcoholic fermentation to proceed more effectively in comparison with commercial yeast strains. (Settanni et al., 2012).

Polyphenols are large and complex group of compounds responsible for the characteristics, quality and colour of the grape and wines. Polyphenolic constituents are classified as flavonoids and non-flavonoids, which contribute to wine sensory characteristics, especially to colour, flavour and astringency. (Ivanova et al.,2015). Anthocyanins are characterized as 3-monoglucosides, 3-acetylglucosides, 3-p-coumaroylglucosides and 3-caffeoylglucosides of cyanidin, delphinidin, peonidin, petunidin and the dominant, malvidin. (Ivanova et al.,2011).

Yeast interact with phenolic compounds and could influence the wine colour. (Mazauric and Salmon, 2005). At the beginning of fermentation, yeast cell wall can absorb anthocyanins and other polyphenolic compounds, influencing the colour. (Morata et al., 2003).

The main purpose of this research is to make a comparison between the wine produced from indigenous yeast strains F-8 and F-78 with the commercial strain D-80.

### **Material and method**

The newly isolated yeast strains were obtained by spontaneous fermentation of grape must from Vranec and Cabernet Sauvignon varieties collected from ten different micro-regions in Macedonia. The grapevines from both varieties grown in “Barovo” micro-region were the richest sources of yeast strains. (Ilieva et al., 2016). The isolation of the yeast was previously executed according to the method of KOH (Bambalov et al., 1996).

From this, were isolated 80 new strains, among F-8 and F-78. (Ilieva et al.,2015). These two strains of yeast F-8 and F-78, and the commercial D-80 (Lallemand) were used for this research.

The wines was produced from the grape variety Vranec, grown on Crveni bregovi locality, near Negotino, at an altitude of 250 m. The grapes were harvested at optimal maturity and transported to the winery. Then, grapes were crushed, followed with addition of SO<sub>2</sub> (20 mg/kg). Vranec grapes from harvest 2016 were equally allocated to the lots, in order to make similar fermentation conditions. The destemmed grape grains were crushed with manual crusher. After crushing, 20 mg/kg free SO<sub>2</sub> was added in the must and it was transferred into 20 L PET bottles. After two hours, the must was inoculated with culture of the selected strain F-8 and F-78. Similar to the other bottles grapes must, were inoculated with the other commercial strain of yeast D-80. The period of maceration of wine was 16 days. During the fermentation, wines were be “pumped-over” four times a day. After the fermentation, the wines were transferred to tanks for stabilization and aging.

The determination of the amount of alcohol was performed ebulliometrically with Dujardin - Salleron ebulliometer and for determination of reducing sugars was used Schoorle method.

Determination of titratable and volatile acidity of trial wines was performed by the previous method (Boulton, 1980). The color Intensity (IC) was measured spektrophotometrically at 420 nm (yellow color), 520 nm (red color), 620 nm (blue color) by UV spectrophotometer Shimadzu 1800, Shimadzu Corporation, Kyoto, Japan.

Determination of total polyphenols, anthocyanins, color intensity was performed by applying spectrophotometric methods. Thus, for determination of total phenolics, the Folin-Chiocalteu method was used, measuring the absorbance at wavelength od 765 nm. For anthocyanin analysis, wine was diluted with solution of ethanol/water/HCL=70/30/1 and absorbance was measured on 540.

The monomeric anthocyanins, polyphenolic content, color and other oenochemical characteristics of the wines produced from domestic isolated strains of yeasts were also compared with the wines produced from commercial yeast strain D-80.

The correlation value between the main parameters was obtained by using the statistical analysis of the results obtained by applying the software package SPSS 19. Comparing the Pearson's coefficient of correlation we can see which parameters have higher correlation. If  $\rho = 1$ , it means that there is a perfect linear correlation, i.e. the growth of the one variable means growth of other variables. If  $\rho = 0.5 - 0.9$ , there is close correlation. If  $\rho = 0.2 - 0.5$ , then the correlation is weak, but there is still correlation between variables. Of course, negative values,  $\rho = -1$  means inversely proportional connection.

### Results and Discussion

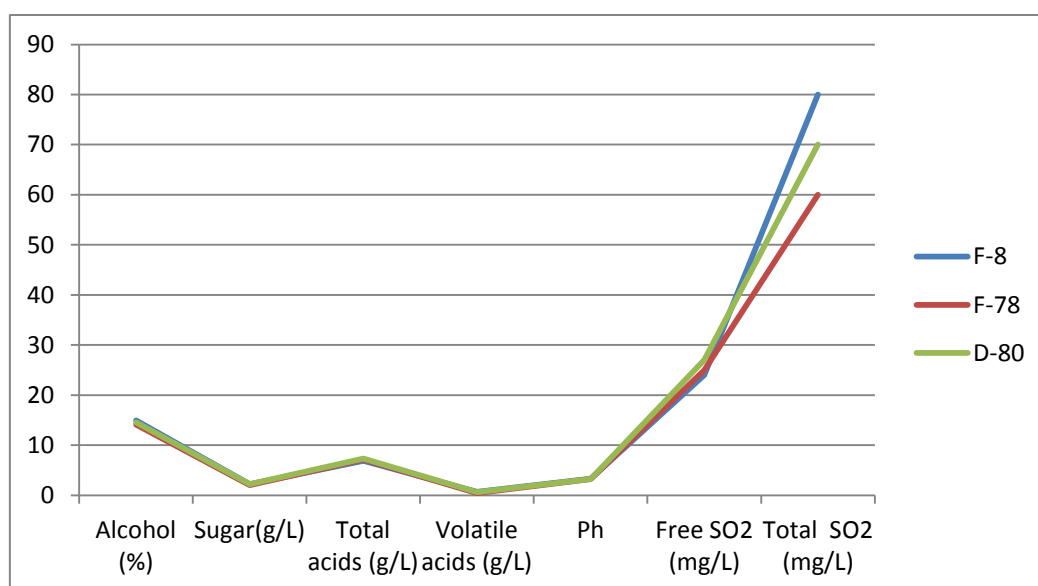
The basic parameters, such as alcohol, sugar, total acids, volatile acids, pH, free/total SO<sub>2</sub>, were determined applying international methods of analysis of wines and musts (OIV methods). Detailed overview of the main chemical parameters measured for wines produced from three different strains of yeasts is shown in Table 1. The wine Vranec produced from the isolated strain of yeast F-8, has the highest % of alcohol (14,96), but the wine produced from the strain of yeast F-78, smallest % of alcohol (14,11). The wines produced from the strains of yeasts F-8 and D-80 have the same concentration of sugar (2,2 g/L). The highest concentration of total acids has the wine produced from commercial strain of yeast D-80 (7,34 g/L) with pH= 3,24, the smallest concentration of total acids the wine from F-8 (6,89 g/L) with pH=3,32. The wines produced from the strains of yeasts F-8 and D-80 have the highest concentration of volatile acids(0,68/0,61).

Table 1. Chemical characteristic of wine Vranec produced by indigenous strains of yeasts F-8, F-78 and commercial D-80.

Wine	Yeast	Alcohol (%)	Sugar(g/L)	Total acids (g/L)	Volatile acids (g/L)	Ph	Free SO <sub>2</sub> (mg/L)	Total SO <sub>2</sub> (mg/L)
Vranec	F-8	14,96	2,2	6,89	0,68	3,32	24	80
Vranec	F-78	14,11	2,0	7,13	0,43	3,26	25	60
Vranec	D-80	14,53	2,2	7,34	0,61	3,24	27	70

On the graph 1. is displayed the chemical characteristic of wine Vranec produced by indigenous strains of yeasts F-8, F-78 and commercial D-80.

Between three types of wines produced from the different strains of yeasts, we can conclusion high correlation on the chemical characteristic. There is a small difference on the chemical parameters between wine produced from indigenous and commercial strains of yeasts, because the wines were produced from the same grapevariety and locality. The day of maceration was the same (16 days) for the three types of wine. The temperature of fermentation was the same 23-24<sup>0</sup> C .



Graph 1. Chemical characteristic of wine Vranec produced by indigenous strains of yeasts F-8, F-78 and commercial D-80.

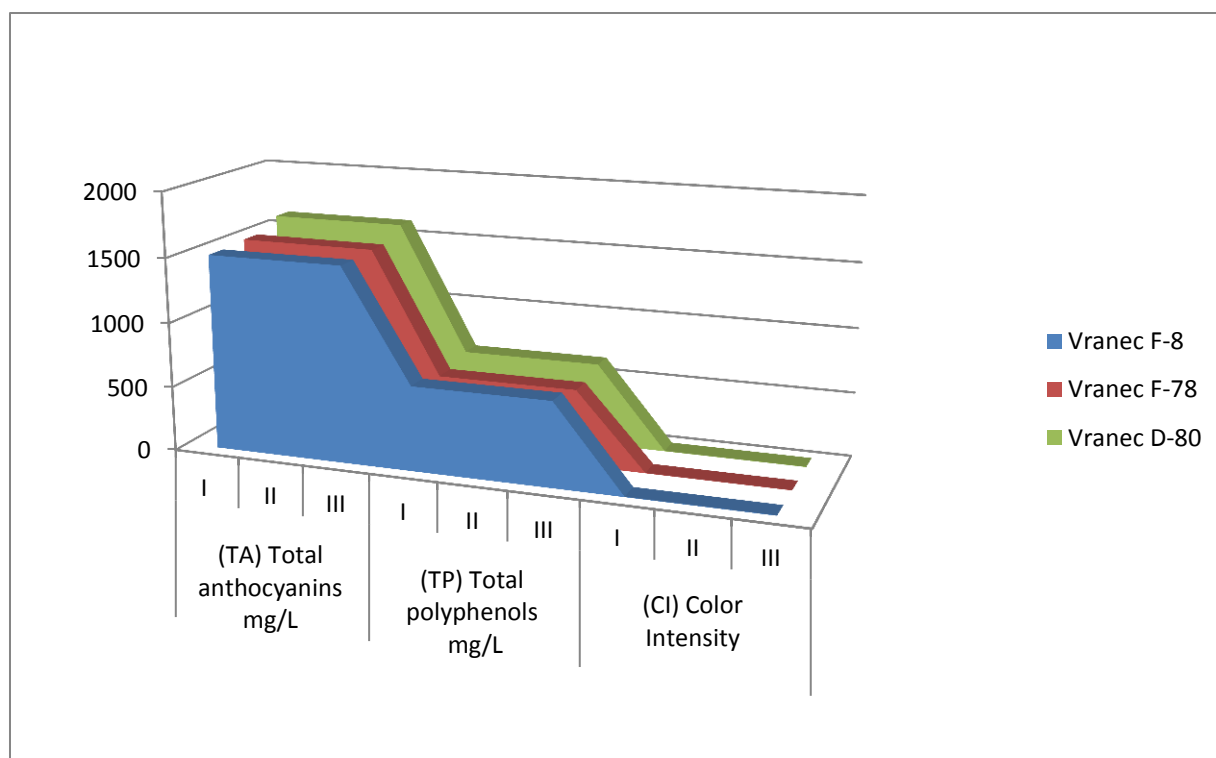
Table 2. Content of total phenolics (TP), total anthocyanins (TA), color intensity (CI) in wine Vranec produced by indigenous strains of yeasts F-8, F-78 and commercial D-80 of three replicates.

Wine	Yeast	(TA) Total anthocyanins mg/L			(TP) Total polyphenols mg/L			(CI) Color Intensity		
		I	II	III	I	II	III	I	II	III
Vranec	F-8	1513,0	1512,2	1511,8	652,7	653,1	653,9	3,1289	3,1253	3,1213
Vranec	F-78	1528,3	1525,4	1523,1	583,2	583,5	584,1	2,1058	2,1026	2,1013
Vranec	D-80	1618,6	1617,0	1615,4	636,2	636,8	637,2	2,3798	2,3657	2,3614

In Table 2, is detailed overview the content of total phenolics (TP), total anthocyanins (TA), color intensity (CI) in wine Vranec produced by indigenous strains of yeasts F-8, F-78 and commercial D-80 of three replicates. The total anthocyanins (TA) have the highest concentration in wine produced from commercial strain of yeast D-80, and the smallest from indigenous strain of yeast F-8. The content of total phenolics (TP) have the highest concentration in wine produced from indigenous strain of yeast F-8, and the smallest from indigenous strain of yeast F-78. The intensity of color was the highest in wine produced from indigenous strain of yeast F-8, and the smallest from indigenous strain of yeast F-78.

There exist a difference on chemical parameters (TA/TP/IC) between three types of wine, but the differences between the three replicates of wines is a small.





Graph 2. The graph shows the content of total phenolics (TP), total anthocyanins (TA), color intensity (CI) in wine Vranec produced by indigenous strains of yeasts F-8, F-78 and commercial D-80 of three replicates.

On the graph 2. is displayed the the content of total phenolics (TP), total anthocyanins (TA), color intensity (CI) in wine Vranec produced by indigenous strains of yeasts F-8, F-78 and commercial D-80 of three replicates.

Between three replicates of wines produced from the same strains of yeasts, we can conclusion a small difference at all parameters. There exist a difference on chemical parameters (TA/TP/IC) between three types of wine.

Table 3. Display of Pearson's coefficient of correlation ( $\rho$ ) received from corelation between wines Vranec produced from indigenous (F-8/F-78) and commercial (D-80) strains of yeasts.

		Correlations		
		D80	F78	F8
D80	Pearson Correlation	1	,999**	,996**
	Sig. (2-tailed)		,000	,000
	N	7	7	7
F78	Pearson Correlation	,999**	1	,993**
	Sig. (2-tailed)	,000		,000
	N	7	7	7
F8	Pearson Correlation	,996**	,993**	1
	Sig. (2-tailed)	,000	,000	
	N	7	7	7

\*\* . Correlation is significant at the 0.01 level (2-tailed).

The correlation value between the main parameters was obtained by using the statistical analysis of the results obtained by applying the software package SPSS 19. The analysis

shows that there is a correlation between the analyzed chemical parameters of the wine from the grapevine Vranec, among different strains of yeasts.

Display of Pearson's coefficient of correlation ( $\rho$ ) received from correlation between chemical parameters from all three types of wines produced from indigenous and commercial strains of yeasts is given in Table 3. The analysis indicates that there is a high correlation value between three types of wine (from F-8/F-78/D-80). Because the main objective to this research is to make a correlation between Vranec produced from indigenous strains of yeasts F-8/F-78 and Vranec produced from commercial D-80, we showed that there is a close correlation. The Pearson's coefficient of correlation ( $\rho$ ), between wine Vranec from F-8 and D-80 is (.996) which means high correlation value. Also, the Pearson's coefficient of correlation ( $\rho$ ), between wine Vranec from F-78 and D-80 is (.999) which means really high correlation value.

### **Conclusion**

This scientific research determined the impact of indigenous and commercial yeast strain on the production of wine from the grape variety Vranec, grown on Crveni bregovi locality, near Negotino, at an altitude of 250 m. The main objective was to display the correlation between indigenous yeast strains F-8 and F-78 with the commercial strain D-80 (Lallemand).

A comparison was made between the domestic yeasts F-8 and F-78, previously isolated at the Tikves wine region, Republic of Macedonia and commercial strain D-80. There is a small difference on the chemical parameters between wines, because the wines were produced from the same grapevariety and locality, also the same days of maceration (16 days) and temperature of fermentation 23-24 °C

The analysis shows that there is a correlation between the analyzed parameters of the wine from the grapevine Vranec, among different strains of yeasts. The main purpose of this research is to make a comparison between the wine produced from indigenous yeast strains F-8 and F-78 with the commercial strain D-80. The Pearson's coefficient of correlation ( $\rho$ ), between wine Vranec from F-8 and D-80 is (.996) which means high correlation value. Also, the Pearson's coefficient of correlation ( $\rho$ ), between wine Vranec from F-78 and D-80 is (.999) which means really high correlation value.

With this scientific research we concluded a very high connectivity between wine Vranec produced from indigenous yeast strains F-8 and F-78 with the commercial strain D-80 (Lallemand).

### **References**

- Bambalov G. Spasov H. Cvetanov O. Bambalov K. (1996). New strains of yeast for the production of red wines, *Viticulture and winemaking*, 5,22-26.
- Ilieva F. Velickovska S. Dimovska V. Mirhosseini H. Spasov H. (2016). Selection of 80 newly isolated autochthonous yeast strains from the Tikveš region of Macedonia and their impact on the quality of red wines produced from Vranec and Cabernet Sauvignon grape varieties. *Food Chemistry*,216.309-315.
- Ilieva F. Velickovska S. Dimovska V. Mirhosseini H. Spasov H. (2015). The impact of some wine-making practices on the quality of Vranec red wines from Macedonia produced by the newly-selected local strain "F-78". *Food Chemistry*,194.1123-1131.
- Ilieva F. Ivanova P.V. Dimovska V. Mitrev S. Karov I. Spasov H. (2013). Influence of autochthonous yeasts on the quality of wines from Vranec and Cabernet Sauvignon varieties. 24<sup>th</sup> International scientific-Expert Conference of Agriculture and Food Industry-Sarajevo,220-225.

- Ivanova-Petropulos, V. Bogeva E. Stafilov T. Stefova M. Siegmund B. Pabi N. Lankmayr E.(2014). Study of the influence of maceration time and oenological practices on the aroma profile of Vranec wines. *Food Chemistry*,165.506-514.
- Ivanova-Petropulos, V., Hermosín-Gutiérrez, I., Boros, B., Stefova, M., Stafilov, T., Vojnoski, B.,Kilár, F. (2015). Phenolic compounds and antioxidant activity of Macedonian red wines. *Journal of Food Composition and Analysis*, 41, 1–14.
- Ivanova V.Stefova M. Vojnski D. Dornyei A. Mark L. Dimovska V. Stafilov T. Kilar F.(2011). Identification of polyphenolic compounds in red and white grape varieties grown in R.Macedonia and changes of their content during ripening. *Food Research Int.*, Vol.44; pp 2851-2869.
- Mazauric J.P. Salmon J. M (2005).\_Interactions between Yeast Lees and Wine Polyphenols during Simulation of Wine Aging: I. Analysis of Remnant Polyphenolic Compounds in the Resulting Wines. *J. Agric. Food Chem.*, 53 (14), pp 5647–5653.
- Morata A . Gomez – Coroves M. C. Suberviola J. Bartolome B. (2003). Adsorption of anthocyanins by yeast cell walls during the fermentation of red wines. . *J. Agric. Food Chem.*, 51, pp 4084–4088.
- Settanni, L., Sannino, C., Francesca, N., Guarcello, R., & Moschetti, G. (2012). Yeast ecology of vineyards within Marsala wine area (western Sicily) in two consecutive vintages and selection of autochthonous *Saccharomyces cerevisiae* strains. *Journal of Bioscience and Bioengineering*, 114, 606–614.

## PATHOGENICITY OF *CONIELLA MUSAIENSIS* VAR. *HIBISCI*, A CAUSAL AGENT OF ROSELLE LEAF SPOT DISEASE IN MAKURDI, CENTRAL NIGERIA

Kparev-wua David APEYUAN<sup>1</sup>; Okechukwu Alphonso NWANKITI<sup>2</sup>; Apeh Ocheigwu Hyacinth OLUMA<sup>3</sup>, Ebenizer Jonathan EKEFAN<sup>2</sup>

<sup>1</sup>Department of Integrated Science, College of Education, Katsina-Ala, Benue State.

<sup>2</sup>Department of Crop and Environmental Protection University of Agriculture, Makurdi, Benue State.

<sup>3</sup>Department of Biological Sciences, University of Agriculture, Makurdi, Benue State.

\*Correspondent Author: apeyuandavid@yahoo.com

### Abstract

A leaf spot disease was observed in Benue State, Nigeria in the 2013 cropping season. Leaves of infected plants appeared water-soaked. These are usually small, irregular and light brown. These spots increased in size covering the leaf surface and bleaching it. These spots eventually become darkened, necrotic and distorted. Affected leaves last for only three days and dropped off. The pathogen was isolated from infected leaves, seeds, crop debris and soil on potato dextrose agar supplemented with streptomycin sulphate (PDAS). The pathogen was identified as *Coniella musaiensis* var. *hibisci* by the Global Plant Clinic in the United Kingdom (GPCW No. /w 9181). Symptoms were reproduced 24 hours after artificially inoculating wounded leaves of the accessions (Acc<sub>1</sub>, Acc<sub>3</sub> & Acc<sub>4</sub>) tested. No significant (p=0.05) difference was noticed among the accessions with regards to disease severity. The infected leaves were defoliated after 72 hours. It was noticed that the disease did not spread to newly emerged leaves after the dropping of the infected ones. Progression ceases once there is low humidity. This fungus has been previously reported elsewhere in the country but this is its first report in Benue State, Nigeria

**Keywords:** leaf spot, *Coniella musaiensis* var. *hibisci*, *Hibiscus sabdariffa* L., accession, inoculation.

### Introduction

Roselle (*Hibiscus sabdariffa* L.) is an important vegetable crop in Nigeria. It belongs to the family Malvaceae. More than 300 accessions of it can be found now around the world, growing in both tropical and sub-tropical regions. Most accessions are used as ornamental plants, but the swollen red calyces of the sabdariffa type have economic, nutritional and medicinal values (Tindall, 1983; Morton, 1987; Sharoff, 1996; Onyenekwe, 1998; Alegbejo, 2000 and Qi *et al.*, 2005). According to Schippers 2000, Roselle is ranked the third most important vegetable in most Nigerian markets, coming after tomatoes and okra in that order. Nigeria is not listed among producing nations which is an indication that the production in the country has not been placed on international scale. Nevertheless, meaningful and substantial production has been reported in the country mainly in the Guinea and Sudan savanna zones with major growing areas being Niger, Kogi, Oyo, Kaduna, Bauchi and Kwara States (Alegbejo, 2000).

The crop has not yet attained its full economic potentials in the country yet there are challenges militating against its optimal growth and development. This leaf disease caused by *Coniella musaiensis* var. *hibisci* is a major constraint (Alegbejo, 2000) and management of the disease has to start with ascertaining the pathogenicity of the causal agent.

Therefore the aim of the study was to establish the identity and ascertain the pathogenicity of the causal agent.

## Materials and Methods

### Isolation of the *Coniella musaiensis* var. *hibisci*

The pathogen was isolated from infected leaves in the 2013 cropping season using the method described by Agrios (2005) in the advance pathology laboratory of University of Agriculture Makurdi, Nigeria. Infected leaves were collected from the field at four locations, placed in envelopes and carried to the laboratory. The infected leaves were thoroughly washed in distilled water. Several small sections (5mm<sup>2</sup>) were cut, using sterile scissors, from the margin of the infected lesions to contain both diseased and healthy portions of the tissue. The sections were surface sterilized with a dilution of common household bleach (0.5 % active sodium hypochlorite) at the ratio of 1:10 for 1 minute and blotted dry on clean sterile filter papers. The sections were transferred to Petri dishes (4 per dish) containing potato dextrose agar supplemented with 0.1mg/l streptomycin sulphate (PDAS) using sterile forceps. The plates were incubated for seven days at room temperature. Colonies of the organism were sub-cultured by using a sterile needle to remove small portions of the growth and transferring them to fresh PDAS plates, a method described by Collins and Lyne (2004). Subsequent sub-culturing was done until pure cultures were obtained. The pure cultures were sub-cultured into several new plates of PDAS and maintained for use. Characters like color of culture, growth pattern, and type of fruiting structure were examined. Slides were also made from the pure cultures and examined under a stereomicroscope for characterization of the organism. These characters were used in conjunction with reference publications to identify the organism. Cultures of the organism and infected leaves were sent to Global Plant Clinic in United Kingdom for confirmation of the identity of the pathogen. This isolation was done on both red and green Roselle collected from four locations of Katsina-Ala, Gboko, Vandeikya and Makurdi Local Government Areas in Benue State, central Nigeria. The result was used to confirm whether it is the same organism that is causing this disease at these different locations and in these three accessions of the plant.

### Preparation of spore suspension

Two weeks old pure cultures were scooped into an electric blender and 250ml of sterile distilled water was added and blended for 15 minutes to expose the spores that were held inside fruiting bodies or the pycnidia. The suspension obtained was filtered using sterile cheesecloth to remove mycelial fragments. The spore concentration was adjusted to  $78 \times 10^4$  spores/ml of the isolate using a haemocytometer.

### Inoculation of healthy plants

Seeds of three accessions were planted on the 20<sup>th</sup> of July 2013 in polythene bags and allowed to grow for two weeks. They were thinned to two per bag and allowed to grow for additional two weeks. Each accession received four treatments of sprayed intact leaves with water (WIN), sprayed injured leaves with water (WIJ), sprayed intact leaves with inoculums (IIN) and sprayed injured leaves with inoculums (IJ). This was replicated three times given a total of twelve observations arranged in a complete randomized design (CRD) in the screen house. The plants were covered for 48 hours with a black polythene sheet to increase humidity and enhance infection. The inoculated plants were observed daily for the development of the symptoms. Disease severity rating was taken after 48 hours and one week. Infected leaves were collected and the pathogens re-isolated and compared with the original isolates. The inoculum was considered pathogenic with the severity rating of between 2 and 5 as described by Mohanan *et al.* (1989) as shown in **Table 1**. In every case, a score of 5 represented total collapse of all leaves and death of the plant.

Table 1: Table of Disease Descriptive scale.

Disease Score	%of leaves with symptoms	Remarks
1	0	No infection
2	1-20	Slight infection
3	21-50	Moderate infection
4	51-70	Severe infection
5	71-100	Very severe infection

#### Data analysis

All data collected were subjected to analysis of variance using GenStat 5 version 3.2, 1995 (Laws Agricultural trust: Rothamsted Experimental Station, UK)

### Results and Discussion

This study identified the causal agent as being *Coniella musaiensis* var. *hibisci* which was confirmed by the Global plant clinic in the United Kingdom. Cultural characteristics were used in the identification of the causal agent. A pure culture of the fungus on PDAS (Plates 1) is whitish. The mycelia are profusely branched and septate as shown in Plate 2. Old cultures of the fungus produced spiny globolous dark pycnidia (Plate 3) which houses rod shaped spores (plate 4)

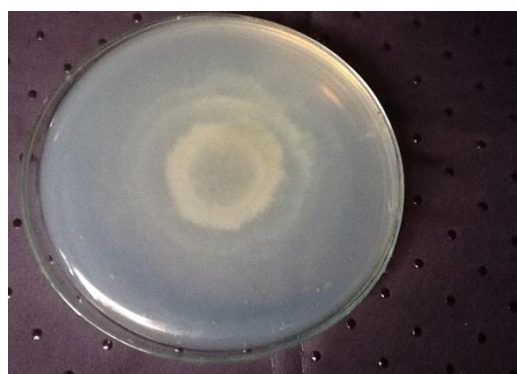


Plate 1. Pure culture of *C. musaiensis*

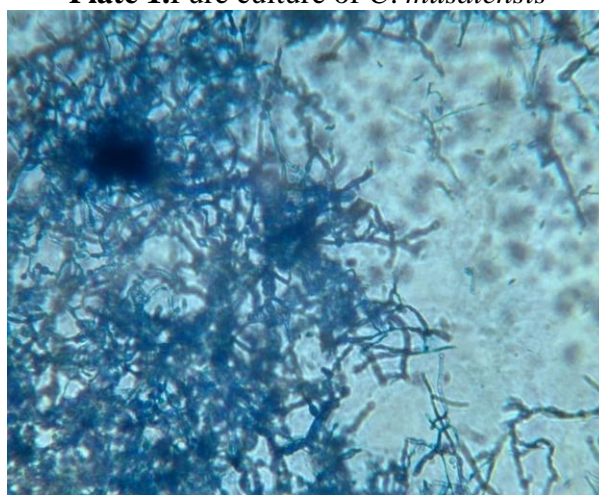


Plate 2: *Coniella* Mycelia (40 x) on Potato Dextrose Agar Supplemented with Streptomycin Sulphate

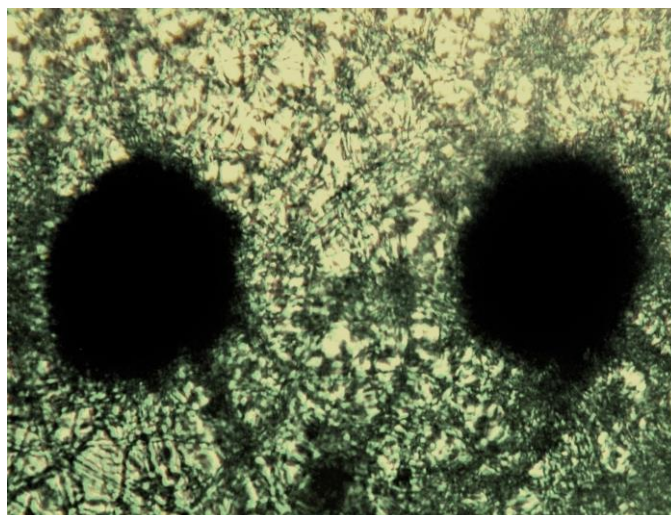


Plate 3: *Coniella* Pycnidia (40 x)

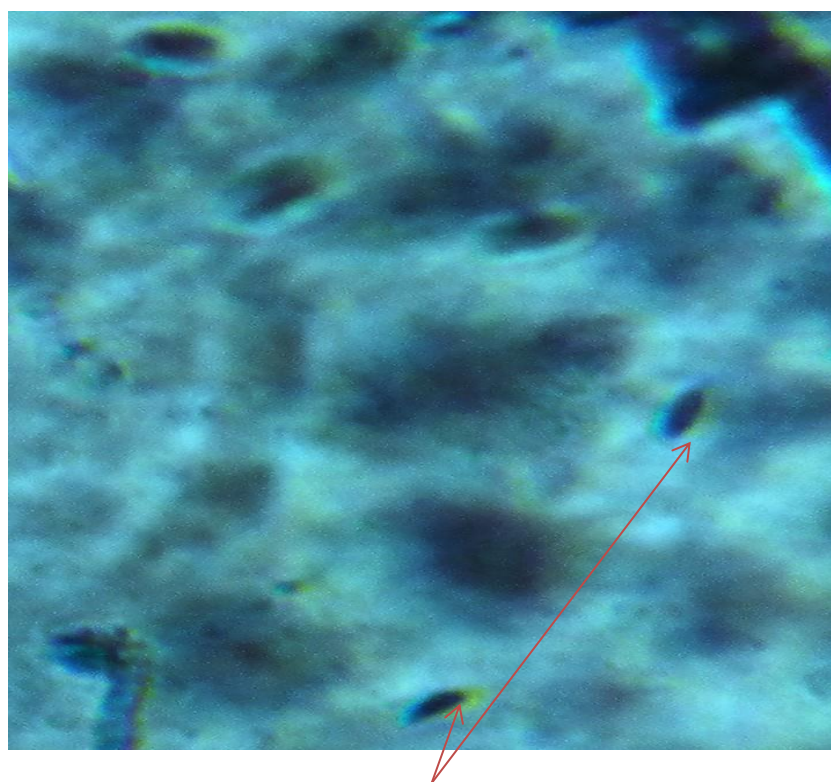


Plate 4. *Coniella* Spores (40 x)

The fungus had uniform radial growth pattern on PDAS with average colony diameter measuring 1.9 mm in a day and reaching 13.5 mm in 7 days.

The fungal colonies causing the observed leaf spot disease of roselle in Benue State was believed to survive in the soil, seeds as well as in debris from infested fields. *C. musaiensis* var. *hibisci* appeared to be ubiquitous as was observed infecting Roselle and causing severe disease in the field. Persad and Fortune (1989) had earlier reported *C. musaiensis* var. *hibisci* as the causal agent of leaf spot and stem canker observed on Roselle in Trinidad and Tobago. Adeoti and Emechebe (1996) reported the same pathogen as being causal agent of leaf spot disease observed in Kenaf (*Hibiscus cannabinus* L.) where it was even tagged the most important disease of the plant in Nigeria.

### Pathogenicity Test

Disease severity was rated after 48 hours and 1 week of inoculation and presented in Table 2. The result from this study showed significant difference among the treatments but none was shown between the accessions at both 48 hours and after one week. Disease severity in leaves (Plate 5) injured and treated with the pathogen was significantly ( $p=0.05$ ) higher than in the rest of the other treatments as shown in Table 2, again for both 48 hours and after one week of treatment. Symptoms manifested within 24 hours of inoculation. Spots were also observed in both the injured and intact leaves treated with water after one week of treatment; however the organism was not re-isolated from the spots. It was also noticed that disease did not spread to newly emerged leaves after the dropping of the infected ones. This points to the fact that the pathogen on its own can't penetrate the plant epidermal wall and relies on external factor(s) to inflict an opening for it to have access to the internal tissue.



Plate 5. Inoculated Plants showing Symptoms on Leaves

Table 2. Disease Severity Rating of three Inoculated Roselle Accessions in the Screen House.

	Inoculation period	
	48 hours	1 week
Treatment		
WIN	1.00	1.22
WIJ	1.00	1.56
IIN	1.00	1.89
IJJ	1.67	3.00
Accession		
1	1.08	1.67
3	1.17	2.00
4	1.25	2.08
LSD (P=0.05) Treatment	0.23*	0.49*
LSD (P=0.05) Accession	0.20 <sup>ns</sup>	0.42 <sup>ns</sup>



Where:-

WIN=Intact leaves with water  
WIJ=Injured leaves with water  
IIN=Intact leaves with Pathogen  
IIJ=Injured leaves with pathogen  
LSD = least significant difference  
ns = indicates not significant at 5%  
\* =Significant at 5%

### Conclusion

Successful identification of disease and causal agent coupled with sources of inoculum are basic efforts towards control of such disease. This study identified the causal agent of leaf spot disease of roselle as being *Coniella musaiensis* var. *hibisci* and it was also found that the pathogen lives in the soil, seeds as well as in debris from infected fields. It also points out that the pathogen is a wound pathogen as it was unable to attack intact leaves.

### References

- Adeoti, A.A & Emechebe,A.M., (1996). Effect of Sowing Date and Type of Fertilizer on Kenaf Yield and its Reaction to *Coniella* Leaf Spot. *Samaru Journal of Agricultural Research*, 13: 13-18.
- Agrios, G.N., (2005). *Plant Pathology* (5th Edition).Elsevier- Academic press San Diego, C.A. 922pp.
- Alegbejo, M.D., (2000). The potential of roselle as an industrial crop in Nigeria. *NOMA, IAR Samaru, Zaria*, 14: 1-3.
- Collins, C.H. & Lyne, P.M., (2004). *Microbiological Methods*. Arnold, London 465pp.
- Mohanan, R.C., Kaveriappa, K.M & Nambiar, K.K.N., (1989).Epidemiological studies of *Collitotricum gloeosporioides* disease of cocoa. *Annals of Applied Biology*, 114(1):15-22.
- Morton, J., (1987). Roselle p281-286. In *fruits of warm climate*. Julia F. Morton, Miami,FL. <http://www.hort.purdue.edu/newcrop/mortonne/roselle.html> Access 11 August 2017
- Onyenekwe, P.C., (1998). Antihypertensive effect of roselle *Hibiscus sabdariffa* calyx infusion in spontaneous hypertensive rat and comparison of its toxicity with that in water rats. In: *Journal of Biochemistry and cell Function*, 11:120-126.
- Persad, C. & Fortune, M., (1989). A new disease of Sorrel (*Hibiscus sabdariffa* var. *sabdariffa*) caused by *Coniella musaiensis* var *hibisci* from Trinidad and Tobago. *Plant Pathology*, 38:615-617.
- Qi, Y., Chin, K.L., Malekian, F., Berhane, M. & Gager, J., (2005). Biological characteristics, nutritional and medicinal value of roselle *Hibiscus sabdariffa* L. *Circular-Urban Forestry Natural Resources and Environment* No.604.
- Schippers, R.R., (2000). *African indigenous vegetables: An overview of the cultivated species* NRI Greenwich 214pp.
- Sharoff, A., (1996). The pharmacological characteristics of *H. Sabdariffa*. *Planta Medical* (Stuttgart), 10: 48-52.
- Tindall, H. D., (1983). *Vegetables in the tropics*. Macmillan press ltd. London 734pp.

## OVERVIEW OF LEAF MINER FAUNA IN SERBIA

Jovan DOBROSAVLJEVIC<sup>1\*</sup>, Cedomir MARKOVIC<sup>1</sup>, Stefan BOJIC<sup>2</sup>

<sup>1</sup>University of Belgrade, Faculty of Forestry, KnezaVisislava 1, 11030 Belgrade, Serbia

<sup>2</sup>University of East Sarajevo, Faculty of Agriculture, Department of Forestry, VukaKaradzica 30, 71123 East Sarajevo, Bosnia and Herzegovina

\*Corresponding author: jovan.dobrosavljevic@sfb.bg.ac.rs

### Abstract

Due to their specific lifestyle, frequency of occurrence, and the damage that they cause on plants, leaf miners have been investigated by many scientists in Serbia. Unfortunately, the overview of research on their fauna in Serbia has not been done yet. Therefore, based on the data from the literature sources and the results of our research, the first overview of leaf miner fauna research in Serbia was made. It was found that 363 species of leaf miners were ascertained in Serbia so far. They are classified as follows: 270 species from 26 families of the order Lepidoptera, 61 species from 5 families of the order Diptera, 21 species from 3 families of the order Coleoptera, and 11 species from 1 family of the order Hymenoptera. The majority of species of the order Lepidoptera belongs to the families Gracillariidae (71), Nepticulidae (61) and Coleophoridae (37), of the order Diptera to the family Agromyzidae (53), and from the order Coleoptera to the families Curculionidae (12) and Chrysomelidae (7). All species of the order Hymenoptera (11) belong to the family Tenthredinidae. Monophagous and Oligophagous species are dominant among the identified species of leaf miners in Serbia. The majority of the species (57%) develop on woody plants. Most of them (30) on the species of the genus *Quercus*, *Prunus* (20), *Malus* (19), and *Populus* (19). The list of 363 species of leaf miners that were identified in Serbia is not definitive. How European leaf mining insect fauna includes about 2500 species, it is certain that new species will be found in the future.

**Keywords:** *phyllophagous insect, Serbian species list.*

### Introduction

Leaf miners are small insects from orders Coleoptera, Diptera, Hymenoptera and Lepidoptera, whose larvae, while feeding on the inside of the leaf, create cavities – mines – of different shape, size, and position on the leaf. These cavities are usually transparent so that when put against a light source, the excrements that the larvae left behind can be seen. They are frequently characteristic of the species that made them so they can be used for their determination. There are about 5500 species of leaf miners in the world (Hering 1957), and approximately 2500 in Europe (Ellis 2007). They are mostly monophagous species from the orders Lepidoptera and Diptera. The species from the order Diptera mostly inhabit herbaceous plants, while those from the order Lepidoptera more often inhabit woody plants. Leaf miners have been studied by many authors in Serbia. Unfortunately, none of them prepared a comprehensive list of Serbian species, so far. Considering that such a list would significantly improve the research on leaf-miners insect guild in Serbia, we compiled and presented in this paper the available data either gathered from the literature or from our researches.

## Materials and methods

The work on compiling the list of leaf miners that have been identified in Serbia so far included:

1. Overview of the literature dealing with leaf miners in Serbia,
2. Cataloging of the material that we collected while researching the leaf miner fauna of Serbia.

All the data obtained were entered into a database, from which a list of all the species detected in Serbia was derived.

## Results and discussion

Based on the data obtained by reviewing the 98 literature sources, and the data obtained from the inventory that we made while researching the fauna of leaf miners in Serbia, a list of 363 species of leaf miners that have so far been found in Serbia was compiled. They are classified as follows: 270 species from 26 families of the order Lepidoptera, 61 species from 5 families of the order Diptera, 21 species from 3 families of the order Coleoptera, and 11 species from 1 family of the order Hymenoptera. The majority of species of the order Lepidoptera belongs to the families Gracillariidae (71), Nepticulidae (61) and Coleophoridae (37), of the order Diptera to the family Agromyzidae (53), and from the order Coleoptera to the families Curculionidae (12) and Chrysomelidae (7). All species of the order Hymenoptera (11) belong to the family Tenthredinidae. Three hundred and sixty-three species of leaf miners that are listed in this paper were identified on the plants belonging to 205 genera. Monophagous (48%) and Oligophagous (42%) species are dominant among the identified insects. The majority of them (57%) develop on woody plants, most of them on the species of the genus *Quercus* (30), *Prunus* (20), *Malus* (19), and *Populus* (19). Some of them can cause significant damage to agriculture and forestry, and that is why they have been researched by many authors in Serbia. The list of the 363 species of leaf miners presented in this paper is the first faunistic list of leaf miners in Serbia. It surely contains some oversights. However, despite them, it is very useful to us. First of all, because of thanks to the list, we now know which species of leaf miners have been identified in Serbia so far, and how much each species group has been researched. This list will also be useful for researchers from abroad because now they will also know which species of leaf miners are present on the territory of Serbia. Considering that European leaf mining insect fauna includes about 2500 species and that Serbian flora is vibrant with vascular plants, it is certain that new species of leaf miners will be found in the future. Leaf miners identified in Serbia, based on the data from the literature sources and the data from our research, are listed in table 1. For convenience, they are all arranged alphabetically within the family to which they belong. Their names are compatible with the names that can be found on the Fauna Europaea website (Van Nieuwerkerken & Karsholt 2016).

**Table 1. List of species identified in Serbia**

<b>Order: Coleoptera</b>
<b>Buprestidae:</b> <i>Trachys minutus</i> (L.), <i>T. troglodytiformis</i> Obenb.
<b>Chrysomelidae:</b> <i>Dibolia depressiuscula</i> Letz., <i>D. foersteri</i> Bach, <i>D. occultans</i> (Koch), <i>Longitarsus luridus</i> (Scop.), <i>Psylliodes chrysocephala</i> (L.), <i>Zeugophora flavicollis</i> (Marsh.), <i>Z. scutellaris</i> Suffr.
<b>Curculionidae:</b> <i>Ceutorhynchus napi</i> Gyll., <i>C. pallidactylus</i> (Marsh.), <i>C. rapae</i> Gyll., <i>Isochnus foliorum</i> (Mull.), <i>I. sequensi</i> (Stierl.), <i>Oprohinus suturalis</i> (F.), <i>Orchestes fagi</i> (L.), <i>O. quercus</i> (L.), <i>O. subfasciatus</i> Gyll., <i>O. testaceus</i> (Mull.), <i>Rhamphus oxyacanthae</i> (Marsh.), <i>Tachyerges decoratus</i> (Germ.)
<b>Order: Diptera</b>
<b>Agromyzidae:</b> <i>Agromyza ambigua</i> Fall., <i>A. anthracina</i> Meig., <i>A. apfelbecki</i> Strobl, <i>A. conjuncta</i> Spen., <i>A. flavipennis</i> Hend., <i>A. frontella</i> (Rond.), <i>A. intermittens</i> (Beck.), <i>A. nana</i> Meig., <i>A. nigrella</i> (Rond.), <i>A.</i>

*nigrescens* Hend., *A. polygoni* Her., *A. pulla* Meig., *A. reptans* Fall., *A. sulfuriceps* Strobl, *A. Amauromyza chenopodivora* Spen., *A. flavifrons* (Meig.), *A. labiatarum* (Hend.), *A. lamii* (Kalt.), *A. morionella* (Zett.), *Aulagromyza fulvicornis* (Hend.), *A. populi* (Kalt.), *A. populicola* (Walk.), *A. tridentata* (Loew), *Calycomyza artemisiae* (Kalt.), *Chromatomyia fuscata* (Zett.), *Ch. horticola* (Gour.), *Ch. nigra* (Meig.), *Galiomyza violiphaga* (Hend.), *Liriomyza amoena* (Meig.), *L. artemisicola* Meij., *L. brassicae* (Riley), *L. bryoniae* (Kalt.), *L. congesta* (Beck.), *L. demeijerei* (Her.), *L. huidobrensis* (Blanch.), *L. pascuum* (Meig.), *L. sonchi* Hend., *L. strigata* (Meig.), *L. taraxaci* Her., *L. trifolii* (Burg. & Comst.), *Ophiomyia cunctata* (Hend.), *Phytomyza agromyzina* Meig., *Ph. glechomae* Kalt., *Ph. gymnostoma* Loew, *Ph. hellebori* Kalt., *Ph. kaltenbachi* Hend., *Ph. marginella* Falle, *Ph. petoei* Her., *Ph. plantaginis* Rob.-Des., *Ph. ranunculi* (Schra.), *Ph. rectae* Hend., *Ph. vitalbae* Kalt., *Pseudonapomyza balkanensis* Spen.

**Anthomyiidae:** *Delia echinata* (Seguy), *Pegomya betae* (Curtis), *P. hyoscyami* (Panz.), *P. solennis* (Meig.)

**Cecidomyiidae:** *Monarthropalpus flavus* (Schra.)

**Ephydriidae:** *Hydrellia griseola* (Fall.)

**Tephritidae:** *Euleia heraclei* (L.), *Trypeta immaculata* (Macqu.)

**Order: Hymenoptera**

**Tenthredinidae:** *Fenella nigrita* Westw., *Fenusa ulmi* Sund., *Heterarthrus aceris* (Kalt.), *H. microcephalus* (Klug), *H. ochropoda* (Klug), *H. wuestneii* (Konow), *Hinatara recta* (Thoms.), *Metallus pumilus* Klug, *Parna tenella* (Klug), *Profenusa pygmaea* (Klug), *Scolioneura betuleti* (Klug)

**Order: Lepidoptera**

**Acrolepiidae:** *Acrolepiopsis assectella* (Zell.)

**Bedelliidae:** *Bedellia somnulentella* (Zell.)

**Bucculatricidae:** *Bucculatrix albedinella* (Zell.), *B. albella* Stain., *B. artemisiella* Herr.-Schaeff., *B. bechsteinella* (Bech. & Scharf.), *B. frangutella* (Goeze), *B. ulmella* Zell., *B. ulmifoliae* Her.

**Choreutidae:** *Millieria dolosalis* (Heyd.), *Prochoreutis myllerana* (F.), *Tebenna micalis* (Man)

**Coleophoridae:** *Coleophora albicostella* (Dup.), *C. albidella* (Den. & Schiff.), *C. anatipennella* (Hubn.), *C. betulella* Hein., *C. brevipalpella* Wck., *C. congeriella* Stgr., *C. conspicuella* Zell., *C. coronillae* Zell., *C. directella* Zell., *C. fretella* Zell., *C. gryphipennella* Hubn., *C. hemerobiella* Scop., *C. ibipennella* Zell., *C. kroneella* Fuchs, *C. kuehnella* Goeze, *C. laricella* (Hubn.), *C. limosipennella* (Dup.), *C. lithargyrinella* Zell., *C. lixella* Zell., *C. lutipennella* (Zell.), *C. milvipennis* Zell., *C. ochrea* (Haw.), *C. onopordiella* Zell., *C. ornatipennella* (Hubn.), *C. paripennella* Zell., *C. prunifoliae* Doets, *C. ramosella* Zell., *C. saponariella* Heeg., *C. serratella* (L.), *C. sternipennella* (Zett.), *C. succursella* Herr.-Schaeff., *C. vacciniella* Herr.-Schaeff., *C. vibicella* (Hubn.), *C. vibicigerella* Zell., *C. vicinella* Zell., *C. violacea* (Ström), *C. zelleriella* Hein.

**Cosmopterigidae:** *Cosmopterix zieglerella* (Hubn.)

**Crambidae:** *Cataclysta lemnata* (L.), *Cynaeda dentalis* (Den. & Schiff.), *Donacaula forficella* (Thunb.), *Elophila nymphaeata* (L.), *Nymphula nitidulata* (Hfn.), *Titanio normalis* (Hubn.)

**Depressariidae:** *Agonopterix arenella* (Den. & Schiff.), *A. carduella* (Hubn.), *A. nanatella* (Stt.), *A. propinquella* (Treit.), *A. purpurea* (Haw.)

**Elachistidae:** *Elachista anserinella* Zell., *E. argentella* (Cl.), *E. bedellella* (Sirc.), *E. bifasciella* Treit., *E. cingillella* (Herr.-Schaeff.), *E. dispilella* Zell., *E. freyerella* (Hubn.), *E. rudectella* Stt., *E. rufocinerea* (Haw.), *E. subalbidella* Schlag., *Stephensia brunnichella* (L.)

**Epermeniidae:** *Epermenia aequidentellus* (Hofm.), *E. insecurella* (Stt.), *Ochromolopis ictella* (Hubn.)

**Eriocraniidae:** *Dyseriocrania subpurpurella* (Haw.)

**Gelechiidae:** *Aproaerema anthyllidella* (Hubn.), *Caryocolum blandella* (Doug.), *Chrysoesthia drurella* (F.), *Ch. sexguttella* (Thunb.), *Neofriseria peliella* (Treit.), *Recurvaria leucatella* (Cl.), *R. nanella* (Den. & Schiff.), *Scrobipalpa artemisiella* (Treit.), *S. atriplicella* (F.R.), *S. ocellatella* (Boyd), *Syncopacma suecicella* (Wolff)

**Glyphipterigidae:** *Glyphipterix equitella* (Scop.), *Orthotelia sparganella* (Thunb.)

**Gracillariidae:** *Aspilapteryx limosella* (Dup.), *A. tringipennella* (Zell.), *Callisto coffeella* (Zett.), *C. denticulella* (Thunb.), *Caloptilia alchimiella* (Scop.), *C. cuculipennella* (Hubn.), *C. fidella* (Rtti.), *C. roscipennella* (Hubn.), *C. semifascia* (Haw.), *C. stigmatella* (F.), *Calybites phasianipennella* (Hubn.), *C. quadrisignella* (Zell.), *Cameraria ohridella* Desch. & Dim., *Euspilapteryx auroguttella* Steph., *Gracillaria syringella* (F.), *Micrurapteryx kollariella* (Zell.), *Parectopa ononidis* (Zell.), *P. robiniella* Clem., *Parornix anglicella* (Stt.), *P. anguliferella* (Zell.), *P. betulae* (Stt.), *P. carpinella* (Frey), *P. devoniella* (Stt.), *P. fagivora* (Frey), *P. finitimella* (Zell.), *P. torquillella* (Zell.), *Phyllocnistis saligna* (Zell.), *Ph. unipunctella* (Steph.), *Ph. xenia* Her., *Phyllonorycter acerifoliella* (Zell.), *Ph. agilella* (Zell.), *Ph. blancardella* (F.), *Ph. cerasicolella* (Herr.-Schaeff.), *Ph. comparella* (Dup.), *Ph. corylifoliella* (Hubn.), *Ph. cydoniella* (Den. & Schiff.), *Ph. delitella* (Dup.), *Ph. distentella* (Zell.), *Ph. esperella* (Goeze), *Ph. froelichiella* (Zell.), *Ph. geniculella* (Rag.), *Ph. harrisella* (L.), *Ph. hostis* Trib., *Ph. ilicifoliella* (Dup.), *Ph. insignitella* (Zell.), *Ph. issikii* (Kum.), *Ph. klemannella* (F.), *Ph. lautella* (Zell.), *Ph. leucographella* (Zell.), *Ph. maestingella* (Mull.), *Ph. medicaginella* (Geras.), *Ph. mespilella* (Hubn.), *Ph. messaniella* (Zell.), *Ph. nicellii* (Stt.), *Ph. oxyacanthae* (Frey), *Ph. pastorella* (Zell.), *Ph. platani* (Stgr.), *Ph. populifoliella* (Treit.), *Ph. quercifoliella* (Zell.), *Ph. rajella* (L.), *Ph.*

*robiniella* (Clem.), *Ph. roboris* (Zell.), *Ph. sagitella* (Bjerk.), *Ph. salicicolella* (Sirc.), *Ph. schreberella* (F.), *Ph. sorbi* (Frey), *Ph. spinicolella* (Zell.), *Ph. strigulatella* (Lien. & Zell.), *Ph. tenerella* (Joann.), *Ph. tristrigella* (Haw.), *Ph. ulmifoliella* (Hubn.)

**Heliozelidae:** *Antispila metallella* (Den. & Schiff.), *A. treitschkiella* (F.R.), *Heliozela sericiella* (Haw.)

**Lyonetiidae:** *Leucoptera malifoliella* (Costa), *L. sinuella* (Rtti.), *Lyonetia clerkella* (L.), *L. prunifoliella* (Hubn.)

**Momphidae:** *Mompha locupletella* (Den. & Schiff.)

**Nepticulidae:** *Bohemannia pulverosella* (Stt.), *Ectoedemia agrimoniae* (Frey), *E. caradjai* (Gros.), *E. gilvipennella* (Klim.), *E. hannoverella* (Glitz), *E. heringi* (Toll), *E. klimeschi* (Skala), *E. liechtensteini* (Zimm.), *E. quinquella* (Bed.), *E. rufifrontella* (Cara.), *E. septembrella* (Stt.), *E. spinosella* (Joann.), *E. subbimaculella* (Haw.), *E. turbidella* (Zell.), *Stigmella aceris* (Frey), *S. aeneofasciella* (Herr.-Schaeff.), *S. anomalella* (Goeze), *S. assimilella* (Zell.), *S. atricapitella* (Haw.), *S. aurella* (F.), *S. basiguttella* (Hein.), *S. carpinella* (Hein.), *S. catharticella* (Stt.), *S. centifoliella* (Zell.), *S. confusella* (Wood & Wals.), *S. desperatella* (Frey), *S. freyella* (Heyd.), *S. glutinosae* (Stt.), *S. hemargyrella* (Koll.), *S. hybnerella* (Hubn.), *S. incognitella* (Herr.-Schaeff.), *S. lemniscella* (Zell.), *S. malella* (Stt.), *S. mespilicola* (Frey), *S. microtheriella* (Stt.), *S. nylandriella* (Teng.), *S. obliquella* (Hein.), *S. oxyacanthella* (Stt.), *S. paradoxa* (Frey), *S. perpygmaeella* (Doub.), *S. plagicolella* (Stt.), *S. pretiosa* (Hein.), *S. prunetorum* (Stt.), *S. pyri* (Glitz), *S. regiella* (Herr.-Schaeff.), *S. rhannella* (Herr.-Schaeff.), *S. roborella* (Johan.), *S. ruficapitella* (Haw.), *S. salicis* (Stt.), *S. samiatella* (Zell.), *S. speciosa* (Frey), *S. splendidissimella* (Herr.-Schaeff.), *S. tiliae* (Frey), *S. tityrella* (Stt.), *S. torminalis* (Wood), *S. trimaculella* (Haw.), *S. ulmiphaga* (Preiss.), *S. ulmivora* (Fol.), *S. viscerella* (Stt.), *S. zangherii* (Klim.), *S. zelleriella* (Snell.)

**Plutellidae:** *Plutella xylostella* (L.)

**Pterophoridae:** *Platyptilia gonodactyla* (Den. & Schiff.), *Stenoptilia graphodactyla* (Treit.)

**Roeslerstammiidae:** *Roeslerstammia erxebella* (F.)

**Tischeriidae:** *Coptotriche angusticollella* (Dup.), *C. gaunacella* (Dup.), *C. heinemanni* (Wck.), *C. marginata* (Haw.), *Tischeria decidua* (Wck.), *T. dodonaea* (Stt.), *T. ekebladella* (Bjerk.)

**Tortricidae:** *Ancylys badiana* (Den. & Schiff.), *Archips oporana* (L.), *Cnephasia incertana* (Treit.), *Dichelia histrionana* (Frol.), *Epinotia nanana* (Treit.), *E. tedella* (Cl.), *Pseudohermenias abietana* (F.), *Spilonota ocellana* (Den. & Schiff.), *Zeiraphera ratzeburgiana* (Sax.)

**Yponomeutidae:** *Argyresthia abdominalis* (Zell.), *A. fundella* (F.R.), *A. laevigatella* Herr.-Schaeff., *Kessleria alpicella* (Stt.), *Ocnorostoma piniariella* Zell., *Prays fraxinella* (Bjerk.), *Scythropia crataegella* (L.), *Swammerdamia caesiella* (Hubn.), *Yponomeuta cagnagella* (Hubn.), *Y. evonymella* (L.), *Y. malinellus* Zell., *Y. rorrella* (Hubn.), *Y. sedella* Treit.

**Zygaenidae:** *Adscita geryon* (Hubn.), *A. statices* (L.), *J. budensis* (Ad. & Au. Speyer), *Jordanita chloros* (Hubn.), *J. globulariae* (Hubn.), *J. graeca* (Jordan), *J. notata* (Zell.), *J. subsolana* (Stgr.)

## Conclusions

Based on the data from the literature sources, and the data from our research, we have found that 363 species of leaf miners, from orders Coleoptera (21), Diptera (61), Hymenoptera (11) and Lepidoptera (270) have been found in Serbia. They were identified on plants from 205 genera, the majority of them on the plants of the genera: *Quercus* (30), *Prunus* (20), *Malus* (19), and *Populus* (19). The number of leaf miners that were identified in Serbia is not definitive. Considering that European leaf mining insect fauna includes about 2500 species, it is certain that new species will be found in Serbia in the future.

## References

- Abafi-Aigner, L. (1910). Contribution to the knowledge of Hungarian seaside, Croatian and Dalmatian butterfly fauna. *Rovartani lapok*, 17, 71-105. (In Hungarian)
- Arsenijevic, M. (1956). Red bud moth (*Spilonota ocellana* F.). *Zastita bilja*, 37, 81-86.
- Bogavac, M. (1959). Plane leaf miner - *Lithocolletis platani* Stgr. (Lepidoptera, Gracillaridae). *Zastita bilja*, 51, 51-62.
- Burijan, V. (1922). Apple ermine (*Hyponomeuta malinella*). *Tezak* 49 (18), 140-141. (In Serbian)
- Camprag, D. (1962). Pests of sugar beet in its main production area with a special emphasis on their suppression. *Hemizacija poljoprivrede*, 51, 36-50. (In Serbian)

- Camprag, D. (1963). Apple leaf mining moth – a new problem in the protection of apple plantations. *Biljni lekar*, 4, 3-6. (In Serbian)
- Camprag, D. *et al.* (1981). Prognosis of occurrence of some pests of agricultural crops in Vojvodina for 1981. *Glasnik zastite bilja*, 2, 34-39. (In Serbian)
- Camprag, D. *et al.* (1982). Prognosis of occurrence of some pests of agricultural crops in Vojvodina for 1981. *Glasnik zastite bilja*, 2, 33-38. (In Serbian)
- Cirkovic, M., Glavendekic, M. (2006). Application of insecticides in the suppression of wild chestnut *Cameraria ohridella* Deschka and Dimic (Lepidoptera, Gracillariidae). Proceedings, VIII Counseling on plant protection, Plant protection society of Serbia, Belgrade, 141-142. (In Serbian)
- Dimic, N. (1996). Miners of fruit leaves in the wide region of Belgrade. *Zastita bilja*, 47 (2), 157-166.
- Dimic, N., Dautbasic, M., Peric, P. (2005). Host Plants of *Cameraria ohridella* Deschka & Dimic, 1986 (Lepidoptera, Gracillariidae). *Entomofauna*, 26 (10), 193-204.
- Dimic, N., Mihajlovic, Lj., Krnjajic, S., Peric, P., Cvetkovic, M. (1998). Entomofauna of leaf miners on public greenery dendroflora in and around Belgrade. *Acta entomologica Serbica*, 3 (1-2), 61-76.
- Dimic, N., Mihajlovic, Lj., Vuksa, M., Peric, P., Krnjajic, S., Cvetkovic, M. (2000). Development of *Cameraria ohridella* Deschka & Dimic, 1986 (Lepidoptera, Gracillariidae). *Zeitschrift für Entomologie*, 21 (2), 5-12.
- Dimic, N., Peric, P. (2003). *Liriomyza bryoniae* Klth. (Diptera: Agromyzidae) - an Important Pest in Glasshouse Vegetables. *Pesticidi*, 18, 115-120. (In Serbian)
- Dimic, N., Peric, P., Cvetkovic, M. (2000a). Leaf miners on wild and cultivated medicinal plants in Serbia. Proceedings of the First Conference on Medicinal and Aromatic plants of Southeast European Countries - Arandjelovac, Association for Medicinal and Aromatic Plants of Southeast European Countries, Belgrade, 363-370.
- Dimic, N., Peric, P., Magud, B. (1999). *Phyllonorycter medicaginella* Gerasimov, 1930. (Lepidoptera, Gracillariidae), a new species in the entomofauna of Yugoslavia. *Zastita bilja*, 50 (4), 267-279.
- Dimic, N., Peric, P., Vuksa, M. (2000b). Leaf miners habitation on spice and aromatic plants in Serbia. Proceedings of the First Conference on Medicinal and Aromatic plants of Southeast European Countries - Arandjelovac, Association for Medicinal and Aromatic Plants of Southeast European Countries, Belgrade, 371-377.
- Đorovic, Đ. (1980). Characteristics and structure of the biocenotic complex of defoliators from the order Lepidoptera in oak forests of Kosovo. Doctoral dissertation, Faculty of Forestry, University of Belgrade, Belgrade. (In Serbian)
- Dulic, K., Injac, M. (1981a). Control of leaf miners *Leucoptera scitella* Zell., *Lithocolletis blancardella* F. and *Lithocolletis corylifoliella* Hw. under the production conditions of apple. *Zastita bilja*, 32 (4), 409-426.
- Dulic, K., Injac, M. (1981b). A contribution to the knowledge of apple leaf miners in the Subotica area. *Glasnik zastite bilja*, 1, 5-8. (In Serbian)
- Dulic, K., Injac, M. (1982). Regulation of the population numbers of the apple leaf miner (*Leucoptera scitella* Zell.) by the methods of integral control. *Zastita bilja*, 33 (3), 333-343.
- Ellis, W. N. (2007) Leafminers and plant galls of Europe. Retrieved from <http://www.bladmineerders.nl/> [Accessed on: 18.12.2016.]
- Gagic, R., Mihajlovic, Lj. (2009). Entomofauna of false indigo-bush (*Amorpha fruticosa* L.) in Serbia. Proceedings, VI Plant Protection Congress with a symposium on biological control of invasive organisms - Zlatibor, Plant protection society of Serbia, Belgrade, 102-103. (In Serbian)

- Glavendekic, M. (2014). New alien insects in forests and urban green spaces in Serbia, In: Kirichenko, N., Roques, A., Augustin, S., Lopez-Vaamonde, C., ed. Invasive insects in a changing world: Abstracts of the International Le Studium conference Invasive insects in a changing world, Le Studium Loire Valley Institute for Advanced studies, Orleans, 15.
- Glavendekic, M., Mihajlovic, Lj. (2006). Insect pests and mites of forest and ornamental nursery stock. *Sumarstvo*, 1-2, 131-148.
- Grbic, V. (1972). Some questions about selection and techniques of pesticide application in the protection of apple and pear. *Biljni lekar*, 6, 227-235. (In Serbian)
- Grujic-Sarcevic, D. (1999). Leaf miners from the subfamily Lithocolletinae (Lepidoptera, Gracilariidae) on broadleaf trees in Vrnjacka Banja. Master thesis, Faculty of Forestry, University of Belgrade, Belgrade. (In Serbian)
- Hering, E. M. (1957). Determination tables for leaf miners of Europe, including the Mediterranean and Canary Islands. Band I, II und III. Dr W. Junk, Hague. (In German)
- Ilic, B. (1954). *Ceuthorrhynchus suturalis* Fabr., a little known pest of onion in Serbia. *Zastita bilja*, 22, 30-37.
- Injac, M. (1981). Results of laboratory investigations of the ovicidal effect of dlflubenzuron on eggs of different age of leaf miners of apple *Leucoptera scitella* Zell. and *Lithocolletis blancardella* F.. *Zastita bilja*, 32 (3), 241-250.
- Injac, M., Grgurevic, V. (1982). The appearance of apple leaf miners in the Smederevo and Belgrade areas in 1981. *Glasnik zastite bilja*, 2, 46-51. (In Serbian)
- Jaksic, P. (2016). Tentative Check List of Serbian Microlepidoptera. *Ecologica montenigrina*, 7 (1-3), 33-258.
- Jaksic, P., Zlatkovic, B. (2015). Distribution of Burnets & Foresters species in plant association and habitats of Special Nature Reserve Jelasnicka Klisura Gorge (Serbia) (Lepidoptera: Zygaenidae). *Biologica Nyssana*, 6 (1), 33-39.
- Jodal, I. (1968). A study of the attack of the leaf miner *Phyllocnistis suffusella* Z. (Lepidoptera, Phyllocnistidae) on poplars in nurseries. *Topola*, 69-70, 23-30.
- Jodal, I., Drekić, M., Marković, M., Poljaković-Pajnik, L. (2001). Contribution to the knowledge of biology and potential control of poplar leaf miner *Proleucopera sinuella* Rtti. (Lepidoptera, Leucopteridae). *Topola*, 167-168, 41-50.
- Keresi, T., Almasi, R. (2009). Nocturnal Lepidoptera in the vicinity of Novi Sad (Northern Serbia). *Acta entomologica Serbica*, 14 (2), 147-162.
- Keresi, T., Sekulic, R., Stamenkovic, S. (2006). Occurrence of important field crop pests in Vojvodina in 2005 and forecast for 2006. *Biljni lekar*, 24 (1), 7-17.
- Keresi, T., Sekulic, R., Stamenkovic, S., Milovac, Z. (2007). Occurrence of important field crop pests in Vojvodina in 2005 and forecast for 2007. *Biljni lekar*, 25 (1), 7-17.
- Kokovic, S. (1970). The value of certain pesticides in complex apple protection. *Biljni lekar*, 4-5, 197-204.
- Krnjajic, S., Injac, M., Peric, P., Dulic, K., Stamenov, M., Graora, D. (1993). Monitoring flight of the apple insect pests with pheromones. *Zastita bilja*, 44 (1), 63-71.
- Kurz, M., Horvat, L. (2010). New and interesting Lepidoptera from the Balkans (Serbia, Croatia, Bosnia and Montenegro). *Mitt. Haus der Natur*, 18, 51-55.
- Ljevnaic-Masic, B., Knezevic, A., Dzigurski, D., Stojanovic, S. (2011). Weeds as vectors of disease and pests in organic production of leaf lettuce *Lactuca sativa* L. subsp. *secalina* Alef. (Asterales, Asteraceae). *Journal on Processing and Energy in Agriculture*, 15 (1), 35-38.
- Magud, B. (2002). Bionomy of apple leaf miner *Leucoptera malifoliella* (Costa 1836) (Lepidoptera, Lyonetidae). Master thesis, Faculty of Agriculture, University of Belgrade, Belgrade. (In Serbian)

- Markovic, C. (2006). *Phyllonorycter leucographella* (Zeller 1850) (Lepidoptera, Gracillariidae) miner on the leaf of *Pyracantha coccinea* Roem. Biljni lekar, 6, 447-450.
- Markovic, C., Stojanovic, A. (2005). *Cameraria ohridella* Deschka & Dimic (Lepidoptera, Gracillariidae), prouzrokovac mina na listu divljeg kestena. Biljni lekar, 33 (4), 408-411.
- Markovic, C., Stojanovic, A. (2012). Parasitoids od *Phyllonorycter platani* (Staudinger) (Lepidoptera, Gracillariidae) in Serbia. Journal of Plant Studies, 1 (1), 79-84.
- Mihajlovic, Lj. (2003). Insect pests in beech forests in Serbia. Sumarstvo, 1-2, 73-84.
- Mihajlovic, Lj. (2008). The most important insect pest species on pine, spruce and fir in Serbia. Sumarstvo, 3, 65-81.
- Mihajlovic, Lj., Karadzic, D., Milenkovic, M. (2007). Determination of health status of the protected natural good " Group of oak tree oak trees - Jozic hut "). Faculty of Forestry, University of Belgrade, Belgrade. (In Serbian)
- Mihajlovic, Lj., Spasic, R., Milosevic, G., Sestovic, M. (1994). Acacia leaf miner (*Parectopa robinella* Clemens) (Lepidoptera, Gracillariidae) a new pest of acacia trees on Deliblatska sands). Proceedings, Deliblatski pesak VI, S.E. "Srbijasume", Belgrade, Forest enterprise "Banat", Pancevo, 503-510. (In Serbian)
- Mihajlovic, Lj., Spasic, R., Petanovic, R., Mihajlovic, N. (1998). Entomofauna and acarofauna of *Clematis vitalba* L. in Yugoslavia. Acta entomologica Serbica, 3 (1), 139-147.
- Mijin, K. (1960). Prilog poznavanju biologije topolinog moljca minera. Zastita bilja, 62, 9-21.
- Nahirnic, A., Tarmann, G., Jaksic, P. (2012). Zygaenidae (Lepidoptera) in the Collection of the Natural History Museum in Belgrade (Serbia). Bulletin of the Natural History Museum, 5, 73-94.
- Nieukerken, E. J. (1985). A taxonomic revision of the Western Palaearctic species of the subgenera Zimmermannia Hering and Ectoedemia Busck (Lepidoptera, Nepticulidae), with notes on their phylogeny. Tijdschrift voor Entomologie, 128 (1), 1-98.
- Nikolic, K., Selamovska, A., Gudzic, S., Nikolic, Z. (2011). The number and harmfulness of the leaf miner *Leucoptera malifoliella* Costa in the apple plantations of Southern Serbia. Proceedings of the Third International Conference Research people and actual tasks on multidisciplinary sciences, 8-10.6.2011, Lozenec, Bulgaria, Bulgarian National Society of Agricultural Engineers "Engineering and Research for Agriculture", 1, 164-168.
- Nikolic, K., Stojanovic, M., Selamovska, A., Nikolic, Z. (2003). Integral protection of apples as a foundation of preservation of the environment). Proceedings, Ekoloska istina 2003, XXI Naucno-strucni skup o prirodnim vrednostima i zastiti zivotne sredine, Donji Milanovac, 221-224. (In Serbian)
- Pagliarini, N., Spasic, R. (1984). Some viewings about appearance and harmfulness of leaf miner *Phytomyza horticola* Goureau. Zastita bilja, 35 (1), 22-34.
- Pagliarini, N., Komnenovic, R. (1981). *Liriomyza trifolii* Burgess, a very dangerous pest of Gerbera in Yugoslavia and possibilities for its control). Zastita bilja, 32 (4), 435-442.
- Pap, P., Drekcic, M., Poljakovic-Pajnik, L., Markovic, M. Vasic, V. (2014). The most important insect pests in forest ecosystems of Vojvodina and their suppression during the period 2004-2013. Silva Balcanica, 15 (2), 68-80.
- Poljakovic-Pajnik, L., Drekcic, M., Kovacevic, B. (2005). Study of *Leucoptera sinuella* Rtti. (Lepidoptera, Leucopteridae) predilection for feeding on the leaves of different black poplar clones.). Topola, 175-176, 39-48.
- Poljakovic-Pajnik, L., Drekcic, M., Kovacevic, B., Vasic, V. (2012). Variability of characteristics of tolerance to *Leucoptera sinuella* rtti. (Lepidoptera: leucopteridae) in black poplars' clones. Topola, 189-190, 153-161.



- Rebel, H. (1914). Contributions to the Lepidoptera fauna of Hungary. Rovartani Lapok, XXI, 47-53. (In German)
- Rebel, H. (1917). Lepidoptera from Neumontenegro. Sitzungsberichte der Akademie der Wissenschaften mat. nat. Klasse, 126, 765-813. (In German)
- Rebel, H., Zerny, H. (1931). The Lepidoptera fauna od Albania. Denkschriften der Akademie der wissenshaften in Wien. Math.Nat. Klasse, 103, 38-159. (In German)
- Rotschild, C. (1911). Contributions to the Lepidoptera fauna of Hungary. Rovartani Lapok, XVIII, 36-43. (In Hungarian)
- Rotschild, C. (1912-1915) Contributions to the Lepidoptera fauna of Hungary. Rovartani Lapok XIX: 21-29, 167-180; XX: 66-91, 170-175; XXI: 27-47, 72-77. (In Hungarian)
- Sekulic, R., Keresi, T. (2003). Should the beet moth be controled?. Zbornik radova instituta za ratarstvo i povrtarstvo, Naucni institut za ratarstvo i povrtarstvo, Novi Sad, 38, 299-306.
- Sidor, C. (1982). The results of the examination of the health status of some harmful insects of sugar beet in Vojvodina in 1981. Glasnik zastite bilja, 2, 51-54. (In Serbian)
- Sidor, C. (1984). Health status of some sugar beet pests of in Vojvodina in 1983 with a special focus on the beet mite. Glasnik zastite bilja, 5, 180-184. (In Serbian)
- Simova-Tosic, D., Petanovic, R., Spasic, R., Petrovic, O., Graora, D., Jerinic, D. (1998). Phytophagous insects and mites on weeds in wheat fields and margins, Proc. of Intern. Symp. on Integrated Protection of Field Crops. Vrnjacka Banja, 21-26.09.1998., Društvo za zastitu bilja Srbije, Beograd, 93-102.
- Simova-Tosic, D., Spasic, R., Stojanovic, A. (1996). Contribution to the study of *Lepidium draba* L. entomofauna. Zastita bilja, 47 (4), 323-331.
- Simova-Tosic, D., Vukovic, M., Mihajlovic, Lj. (1985). *Monarthropalpus buxi* Lab. and its parasites (Diptera: Cecidomyiidae). Zastita bilja, 36 (3), 173.
- Simova-Tosic, D., Vukovic, M., Plazinic, V., Mihajlovic, Lj. (1988). Appearance and identification of the most important harmful insects on soybean in the S.R. of Serbia. Zastita bilja, 39 (1), 17-24.
- Spasic R., Graora D., Jerinic-Prodanovic D. (2005). Finding of the species *Liriomyza huidobrensis* (Blanchard) (Diptera: Agromyzidae) in flower shipments from import. Proceedings, VII Counseling on plant protection - Soko Banja, Plant protection society of Serbia, 191-192. (In Serbian)
- Spasic, R. (1991). The leaf miners (Agromyzidae, Diptera) of wheat in Serbia. Zastita bilja, 42 (4), 198.
- Spasic, R. (1993). Leaf miners (Agromyzidae, Diptera) on *Clematis* spp. in Yugoslavia. Proceedings, XXI Gathering of Yugoslavian Entomologists, Entomological Society of Serbia, Belgrade, 19. (In Serbian)
- Spasic, R. (2009). Pest species of Diptera in glasshouses. Biljni lekar, 37 (5), 545-553.
- Stamenkovic, S. (1987). Current problems of protecting wheat from pests. Glasnik zastite bilja, 5, 179-184. (In Serbian)
- Stankovic, A., Camprag, D. (1965). New gradation of *Phthorimaea ocellatella* Boyd., in Yugoslavia and efficacy of some modern insecticides. Hemizacija poljoprivrede, 9-12, 445-454. (In Serbian)
- Stojanovic, A., Markovic, C. (2004). Parasitoid complex of *Cameraria ohridella* (Lepidoptera: Gracillariidae) in Serbia. Phytoparasitica, 32(2), 132-140.
- Stojanovic, A., Markovic, C. (2005). Parasitoid complex of *Phyllonorycter robiniella* (Clemens, 1859) (Lepidoptera, Gracillariidae) in Serbia. Journal of pest science, 78 (2), 109-114.
- Stojanovic, D. (2012). Taxonomic-faunistical study of butterflies and moths (Insecta: Lepidoptera) of mt. Fruska Gora. Doctoral dissertation, Faculty of Biology, University of Belgrade, Belgrade. (In Serbian)

- Stojanovic, D., Curcic, S., Tomic, M. (2014). Fauna of Lepidoptera of National Park „Tara” – First part – Microlepidoptera. Institute of Lowland Forestry and Environment, University of Novi Sad, SE NP “Tara”, SE NP “Fruska Gora”. (In Serbian)
- Stojnic, B. (2005). Analysis of the presence of quarantine and economically harmful insects, mites and nematodes in flower shipments from import. Proceedings, VII Counseling on Plant Protection, Sokobanja, 15-18.11., Plant protection society of Serbia, Belgrade, 80-81. (In Serbian)
- Szent-Ivány, J., Uhrik-Mészáros, T. (1942). The distribution of Pyralidae (Lepidopt.) in the Carpatian Basin. *Annales Hist. Nat. Musei Nationalis Hungarici, pars zoological*, XXXV, 105-196. (In German)
- Tabakovic-Tosic, M., Markovic, M. (2004). Harmful biotic factors in beech coppice forests of east Serbia. Proceedings of an international scientific conference marking 75 years of the Forest Research Institute of the Bulgarian Academy of Sciences, Sofia, Bulgaria, 1-5.9.2003, Forest Research Institute, Sofia, 2, 239-246.
- Tabakovic-Tosic, M., Milanovic, S. (2000). *Coleophora laricella* Hb. (Lepidoptera, Coleophoridae) in the cultures of larch in the area of REIK Kolubara. Proceedings, XI Yugoslavian Symposium on Plant Protection and Counseling on Pesticide Application - Zlatibor, Plant protection society of Serbia, 83. (In Serbian)
- Tabakovic-Tosic, M., Tosic, D., Rajkovic, S., Golubovic-Curguz, V., Rakonjac, Lj. (2011). Invasion species *Coleophora laricella* - One of the main limiting factor of *Larix decidua* during the forest afforestation and recultivation. *African Journal of Agricultural Research*, 6 (4), 866-872.
- Tarmann, G. (2012). *Jordanita (Jordanita) graeca* (Jordan, 1907) (Lepidoptera, Zygaenidae, Procridinae) Erstnachweis für Österreich. *Verhandlungen der zoologisch-botanischen Gesellschaft in Wien*, 148, 265-273. (In German)
- Tomic, D., Mihajlovic, Lj. (1976). Harmful insect fauna of the red oak (*Quercus borealis* Michx) in Serbia. *Arhiv biologiskih nauka*, 28 (3-4), 189-197.
- Triberti, P. (2007). The Phyllonorycter species from Palaearctic Region feeding on Rosaceae (Lepidoptera, Gracillariidae). *Bollettino del Museo Civico di Storia Naturale di Verona*, 31, 147-227.
- Van Nieuwerkerken, E. J., & Karsholt, O. (2016) *Fauna Europaea* (Lepidoptera: Gracillariidae). *Fauna Europaea* version 2.6. Retrieved from [www.fauna-eu.org](http://www.fauna-eu.org). [Accessed on: 23.12.2016.]
- Zecevic, M. (2002). Butterfly fauna of Timocka Krajina (Eastern Serbia). *Copper Bor i National museum Zajecar, Zajecar*. (In Serbian)
- Zecevic, M., Vajgand, D. (2001). Data from prof. Dr Mihailo Gradojevic's files about butterfly (Lepidoptera) fauna of Serbia and Macedonia. *Sveske Matice srpske*, 37, 34-78. (In Serbian)
- Zivanovic, V. (1967). Contribution to the study of the morphology of *Leucoptera scitella* Zell. (Lepidoptera, Gracillariidae). *Zastita bilja*, 18, 93-95; 233-239,
- Zivanovic, V. (1968). Contribution to the study of the methods of controlling *Leucoptera scitella* Zell. (Lepid., Gracillariidae). *Biljni lekar*, 3-4, 82-88.
- Zivojinovic, D. (1963). Contribution to the knowledge of harmful forest entomofauna of Deliblat sands. *Zastita bilja*, 74, 437-462.
- Zivojinovic, S. (1950). Insect fauna of Majdanpek forest domain. SASA, Institute for ecology and biogeograph. Belgrade. (In Serbian)
- Zivojinovic, S., Vasic, K., Tomic, D. (1962). Second contribution to the knowledge of insect pests of softwood broadleaf trees in Yugoslavia. *Glasnik Sumarskog fakulteta*, 26, 25-64

## **TOTAL BETA ACTIVITY, POTASSIUM-40 ACTIVITY AND RESIDUAL BETA ACTIVITY IN DIFFERENT CORN-BASED FOOD SAMPLES**

Željko MIHALJEV\*, Sandra JAKŠIĆ, Brankica KARTALOVIĆ, Milica ŽIVKOV-BALOŠ

Scientific Veterinary Institute "Novi Sad", Novi Sad

\*Corresponding author: zeljko@niv.ns.ac.rs

### **Abstract**

The use of nuclear energy to peaceful purposes causes contamination of the environment with radionuclides. Therefore, the monitoring of radionuclide levels in the environment in certain region is of vital importance because it creates a basis for providing radiation safety of human population. In this article, basic radiation data such as total beta activity (TbA), potassium-40 activity ( $A^{40}\text{K}$ ) and residual beta activity (RbA) in corn-based food samples from different shops in Novi Sad have been measured. Corn-based food plays an important role in traditional Serbian diet and is also very attractive in modern dietary trends. The products, which are most commonly used for human consumption, were selected for the analysis. During spring 2016, the samples of different corn products available on the market in Novi Sad were collected by random selection. In this study, 26 samples in original packaging were collected from the supermarkets. All samples originated from Serbia. The following sample types have been collected: white and yellow corn flour, corn grits, polenta, corn flakes, corn for popcorn, popcorn and corn snacks. Total beta activity was determined from the mineral rest after burning dried samples by the anticoincidental device for measuring low-beta activity, type Omni-Guard (USA). The content of potassium in the samples was determined using atomic absorption spectrometry. Total beta activity ranged from  $35.8 \pm 1.9$  Bq/kg to  $224.7 \pm 5.4$  Bq/kg, and residual beta activity from 4.9–34.8 Bq/kg. Measuring of TbA and potassium-40 activity can serve as a first phase of radiation-hygienic control.

**Key words:** corn-based food, total beta activity, potassium-40 activity, residual beta activity

### **Introduction**

Peaceful uses of nuclear energy (nuclear weapons testing, nuclear reactor accidents, industrial and medical use of radioactive compounds) and application of phosphate mineral fertilizers in agricultural production lead to substantial environmental contamination (Skipperud et al., 2011). Land contaminated with radionuclides represents the first link in the food chain, and hence, the radioactive contamination of crop and livestock production (Bikit et al., 1990). The radioactivity released to the atmosphere only during the accident in Chernobyl nuclear plant on 26 April 1986 is estimated to some  $12 \times 10^{18}$  Bq. The most important and most hazardous radionuclides that were released into the environment include  $^{131}\text{I}$ ,  $^{134}\text{Cs}$ ,  $^{137}\text{Cs}$  and  $^{90}\text{Sr}$ . Furthermore, the accident in Fukushima dated 11 March 2011 is associated with further increase of radioactive contamination of the environment. Total activity of radioactive particles released from damaged reactors is estimated to  $10^{18}$  Bq. All radioactive particles were transported across the Pacific towards the North-American continent and substantial portion thereof arrived even to Europe (Pantelić, 2016). The plants are an important link in animal and human chain nutrition. Incorporation of radionuclides in plants occurs through leaves (foliated deposit) and root absorption as well. Involvement of particular radionuclides into biological cycle: soil-vegetation-animals-man is associated with

plants' ability to absorb radioactive elements from the soil via their root systems. The amount of radioactive material from the soil absorbed by plants is directly proportional to the pollution emission density at particular territory (Simić, 2001). The highest portion of natural radiation is attributed to natural radionuclide potassium-40 ( $^{40}\text{K}$ ), which is present in the mixture of natural potassium isotopes ( $^{39}\text{K}$ ,  $^{40}\text{K}$ ,  $^{41}\text{K}$ ) sharing a mass fraction of 0.0119%, whereas its part in the total beta-activity in bio-communities reaches over 90% (Dželalija, 2006). Radioactive radiation can cause cancer diseases and other health changes of humans and whole living world in general, it substantially influences the changes in the environment (Veriš et al., 2009). Radionuclide transfer through plants or corn-based food affects human population as the last link in nutrition chain posing serious health risks because radiation is a potential cause of somatic and genetic damages. Considering nutritional features, energy value and good digestibility of corn, we are witnessing an increase in production of new corn-based food and feed products (Radosavljević et al., 2002). Consequently, there is a demand for permanent and organized radiation-hygienic control of different food, among which corn-based food takes a significant place.

### Material and Methods

Total of 26 different samples of corn-based products were collected including white and yellow corn flour, polenta (3 samples), *Clipsy* popcorn, peanut flips, *Fan* flips, *Jumbo* flips, gold corn flakes, corn flour (5 samples), „*proja*“ (typical bread-like dish made of corn flour), „*Smoki*“ flips and „*Clipsy*“ flips. All analyzed samples were from domestic producers and collected by the method of random selection in several of the largest supermarkets in Novi Sad. The samples differed in view of the type and size of the package and originated from diverse producers and localities. All collected samples were first dried at  $t=105\text{ }^{\circ}\text{C}$  and then mineralized at  $450\pm 10\text{ }^{\circ}\text{C}$  in a furnace (MARLAP, 2004). Total beta activity was determined from the mineral rest after burning dried samples, by the anticoincidental device for measuring low-beta activity (IAEA, 1989), type Omni Guard, Tracerlab, company ICN (USA), and its background radiation was less than 1 imm/min. The efficiency of the measuring device is determined by the method of standard sources. As a standard source,  $^{40}\text{K}$  in KCl was used (Mitrović et al., 1996). The content of potassium in the samples was determined using emission spectrophotometry on the device Spectr AA-10, Varian, at a wavelength 766.5 nm using cesium as an ion-suppressor. The level of potassium-40 activity in corn-based food samples was determined on the basis of total potassium value of the mass activity of 31.561 Bq/g K (Eisenbud M., 1973). Residual beta activities were determined from the difference between total beta activity and the activity levels of potassium-40. The measured activities and potassium contents are given per kg air-dry matter. The obtained values were statistically processed using statistical software SPSS 17.0 for Windows. The difference between total beta activity and the activity of potassium-40 in samples was analyzed using *t* test.

### Results and discussion

Table 1 depicts the results obtained from measurement of total potassium level and total beta activity, the calculated activity of natural radioactive isotope K-40, residual beta activity, the contribution of potassium-40 to total beta activity, as well as the statistically significant differences between the measured total beta activity and the one calculated on the basis of measured potassium concentration. Based on the presented results, the samples can be distributed into three groups according to the statistical significance of the differences between TbA and  $A^{40}\text{K}$ . Statistically significant differences between TbA and  $A^{40}\text{K}$  were

detected in neither samples designated 2,3,5,16,18,22 and 24 at confidence interval ( $P > 0.05$ ) nor in samples designated with 1,4,6,8,9,11,13,14,17,20,21,25 and 26 at confidence level ( $P > 0.01$ ). Since there were no statistically significant differences between measured and calculated values for beta activity (testing of obtained values performed using t-test (Kostić, 2014)), the beta activity of examined samples can be attributed to beta decay of potassium 40. In all aforementioned samples, the contribution of potassium 40 to total beta activity was over 90% in the majority of samples, which corresponds with the data from the literature (Levant, 1996) and the results of our previously reported research (Mihaljev et al., 2011; Ćupić et al., 2005). In the group of samples designated with 7 (corn grits<sup>2</sup>), 10 (corn grits<sup>5</sup>), 12 (corn for popcorn<sup>2</sup>), 15 (flips – peanut), 19 (corn flour<sup>1</sup>) and 23 (*proja*), the t-test results revealed statistically significant differences between measured total beta activity and beta activity calculated based on the measured potassium concentration. This strongly suggests that besides the natural <sup>40</sup>K the samples contain some other beta-gamma emitters, which could be identified using more sensitive radio-chemical and spectrometric methods upon comprehensive analysis of radionuclide content.

Table 1. The content of potassium-40, total beta activity (TbA), and residual beta activities (RbA) in different types of corn-based food samples

No. of samples	Sample type	Content of K [g/kg]	Activity of <sup>40</sup> K [Bq/kg]	TbA [Bq/kg]	RbA [Bq/kg]	Contribution of <sup>40</sup> K [ % ]	Statistical significance of the difference
1.	White flour	3.98±0.04	125.6±1.3	133.2±8.9	7.6	94.29	P > 0.01
2.	Yellow flour	2.66±0.05	83.9±1.5	88.0±6.9	4.1	95.34	P > 0.05
3.	Polenta <sup>1</sup>	1.99±0.01	62.8±0.4	65.6±4.1	2.8	95.73	P > 0.05
4.	Polenta <sup>2</sup>	7.12±0.17	224.7±5.4	233.1±13.2	8.4	96.40	P > 0.01
5.	Polenta <sup>3</sup>	5.84±0.12	184.3±3.9	189.0±7.7	4.7	97.51	P > 0.05
6.	Corn grits <sup>1</sup>	1.72±0.01	54.3±0.3	60.2±5.5	5.9	90.20	P > 0.01
7.	Corn grits <sup>2</sup>	1.37±0.05	43.2±1.6	50.5±4.1	7.3	85.54	<b>P &lt; 0.01*</b>
8.	Corn grits <sup>3</sup>	1.14±0.06	35.8±1.9	42.6±4.9	6.8	84.04	P > 0.01
9.	Corn grits <sup>4</sup>	4.03±0.20	127.2±6.4	136.7±10.2	9.5	93.05	P > 0.01
10.	Corn grits <sup>5</sup>	1.50±0.03	47.3±0.9	55.2±5.3	7.9	85.69	<b>P &lt; 0.01*</b>
11.	Corn for popcorn <sup>1</sup>	1.84±0.02	58.1±0.6	63.6±6.4	5.5	91.35	P > 0.01
12.	Corn for popcorn <sup>2</sup>	2.74±0.09	86.5±2.8	96.0±8.5	9.5	90.10	<b>P &lt; 0.01*</b>
13.	Corn flakes	1.22±0.03	38.5±1.0	44.4±6.0	5.9	86.71	P > 0.01
14.	<i>Clipsy</i> popcorn	4.74±0.25	149.6±7.8	157.7±6.6	8.1	94.86	P > 0.01
15.	Flips - peanut	5.95±0.12	187.8±3.8	199.5±7.9	11.7	94.14	<b>P &lt; 0.01*</b>
16.	<i>Fan</i> flips	4.86±0.33	153.4±9.4	160.1±11.4	6.7	95.82	P > 0.05
17.	<i>Jumbo</i> flips	1.38±0.05	43.6±1.7	48.4±4.2	4.8	90.08	P > 0.01
18.	Gold corn flakes	6.33±0.23	199.8±7.4	202.9±11.0	3.1	98.47	P > 0.05
19.	Corn flour <sup>1</sup>	2.12±0.08	66.9±2.4	77.3±8.8	10.4	86.55	<b>P &lt; 0.01*</b>
20.	Corn flour <sup>2</sup>	2.23±0.01	70.4±0.1	75.6±5.9	5.2	93.12	P > 0.01
21.	Corn flour <sup>3</sup>	1.72±0.07	54.3±2.2	61.2±5.7	6.9	88.73	P > 0.01
22.	Corn flour <sup>4</sup>	2.33±0.05	73.5±1.7	76.8±6.6	3.3	95.70	P > 0.05
23.	<i>Proja</i>	4.67±0.07	147.4±2.4	160.0±10.5	12.6	92.12	<b>P &lt; 0.01*</b>
24.	Corn flour <sup>5</sup>	4.40±0.02	138.9±5.1	141.1±7.9	2.2	98.44	P > 0.05
25.	<i>Smoki</i>	1.59±0.03	50.2±1.0	57.2±7.1	7	87.76	P > 0.01
26.	<i>Clipsy</i> flips	1.18±0.05	37.2±1.6	42.7±5.0	5.5	87.12	P > 0.01

\*-highly statistically significant differences

Apparent variations of potassium levels in the examined samples strongly suggest that incorporation of radionuclides from the soil into the plants (corn) is highly influenced by pedological characteristics, pH and soil management practices (Bikit et al., 2010) as well as conducted agro-technical measures (Mitrović et al., 2011). Measurement of the total beta activity of unstable radionuclides in food and feed is applicable as a very efficient and fast screening method in cases when the activity of individual natural and man-made radionuclides in samples from the food chain is extremely low, that is, almost at the activity level of natural radionuclide K-40. In such cases, if necessary, identification and quantification of individual radionuclides is indispensable.

### Conclusion

Total beta-activity (TbA) in majority of investigated samples of different corn products is due to  $^{40}\text{K}$  as the most prevalent natural radionuclide. Knowing the potassium concentration and its behavior pattern in the food chain is indispensable in assessing the total radiation load in humans.

In six corn-based food samples, statistically significant difference was determined ( $P < 0.01$ ) between the total beta activity and potassium-40 activity, as following: samples No. 7 and 10 (corn grits<sup>1</sup> and corn grits<sup>5</sup>); sample No. 12 (corn for popcorn<sup>2</sup>); sample No. 15 (flips – peanut); sample No. 19 (corn flour<sup>1</sup>) and sample No. 24 (*proja*). Values of residual beta activity indicate the presence of other beta radionuclides, except potassium-40. The obtained results could serve as a basis for further research in the field of radiation-hygienic control of corn-based food.

It is to be emphasized that activity of radionuclides obtained in the examined corn-based food samples was significantly lower than the maximum permissible values set by relevant legal provisions (Official Gazette of RS, RS 86/2011).

We can conclude that measurement of total beta activity can be considered rapid screening method for selective diagnostics of utility of food and feed.

### Acknowledgement

This research was financed by the Ministry of Educations, Science and Technology, Republic of Serbia, project No TR 31084.

### References

- Bikit, I., Slivka, J., Vesković, M., Čonkić, Lj., Krmar, M., Mihaljev, Ž.(1990). “Contamination of Soil and Food with Radionuclides from Chernobyl” in Proc. of the Int. Symp. on Post-Chernobyl Environmental Radioactivity Studies in East European Countries, Kazimierz -1990, pp.34-37 edited by P.Stergnar et al., Maria Curie-Sklodowska University, Lublin, Poland
- Bikit, I., Todorović, N., Mrđa, D., Forkapić, S., Jovančević, N., Nikolov, J., Hansman, J. (2010). Merenje radioaktivnosti zemljišta na teritoriji AP Vojvodine (Measurement of soil radioactivity in the territory of AP Vojvodina), University of Novi Sad, Faculty of Natural Sciences and Mathematics, Department of Physics, Novi Sad
- Ćupić, Ž., Mihaljev, Ž., Kljajić, R., Živkov-Baloš, M., Ivančev, A. (2005). Total beta activity, potassium-40 and residual beta activity in alfalfa samples in Vojvodina region, XI international feed technology symposium-Quality Assurance, Vrnjačka Banja, 245-248
- Dželalija, M. (2006). Ionizing Radiation in Biosphere, University of Split, Faculty of Chemistry and Technology

- Eisenbud, M.(1973). Environmental Radioactivity. Academic Press, New York
- International Atomic Energy Agency-IAEA(1989). Measurement of Radionuclides in Food and the Environment, Vienna
- Kostić, G. (2014). Metrological manual, Symmetry, Leskovac
- Levant, I. (1996). Exposure to natural radiation on the Earth, especially the issue of the Agency for Special Waste APO, ISSN 1330-5743, Zagreb
- MARLAP (2004). Laboratory Sample Preparation, Volume II: Chapters 10-17 and Appendix F
- Mihaljev, Ž., Čupić, Ž., Živkov-Baloš, M., Jakšić, S. (2011). Total beta activity, Potassium-40 activity and residual beta activity in different Tea Samples, XV International Eco-Conference, Environmental Protection of Urban and Suburban settlements II, Proceedings, Novi Sad, 281-287,
- Mitrović, B., Vitorović, G., Stojanović, M., Vitorović, D.(2011). Radioaktivnost fosfatnih mineralnih proizvoda (Radioactivity of phosphate mineral products), Vet. Glasnik 65, (1-2), 123-140
- Mitrović, R., Kljajić, R., Petrović, B. (1996). Sistem radijacione kontrole u biotehnologiji (The system of radiation control in biotechnology), Scientific Institute of Veterinary Medicine “Novi Sad”, Novi Sad
- Pantelić, Gordana K., Janković, Marija M., Krneta Nikolić, Jelena D., Todorović, Dragana D., Rajačić, Milica M., Sarap, Nataša B. (2016). Akcidenti i monitoring radioaktivnosti, Monografija – Černobilj 30 godina posle (Accidents and monitoring of radioactivity, Monograph - Chernobyl 30 years later), Society for Radiation Protection of Serbia and Montenegro, Beograd, 19-42.
- Regulations on the limits of radionuclide content in drinking water, food, feed, medicine, objects of general use, building materials and other goods placed on the market (2013). Official Gazette of the Republic of Serbia, no 86/2011
- Radosavljević, M., Božović, I., Jovanović, R., Bekrić, V., Žilić, S., Terzić, D. (2002). High Value of Feed and Food and new Technological Maize-and Soybean-based Products, Review paper, Biblid: 1450-5029, PTEP 6, 1-2. P.54-60
- Skipperud, L., Popić J., Roos P., Salminen S., Nygren U., Sigmarsson O., Palsson S.E. (2011). Methods-MS, final report, Nordic nuclear safety research, nks-243, 30-32
- Veriš, A., Četojević, D., Mijatović, D., Tramošljika, Lj. (2009). Uticaj radioaktivnog zračenja na ljudski organizam (The influence of radioactive radiation on the human organism), 1<sup>st</sup> International Conference Ecological Safety in post-modern environment, Banja Luka.

## **DETERMINATION OF FOOD PURCHASING PREFERENCES OF CONSUMERS USING ROBUST FACTOR ANALYSIS**

Koksal KARADAS\*, Yakup Erdal ERTURK, Ayca Nur SAHIN

Igdir University, Agricultural Faculty, Department of Agricultural Economics, Igdir, Turkey

\*Corresponding Author: kkaradas2002@gmail.com

### **Abstract**

In this study, it was aimed at applying robust factor analysis for an ordinal five-point likert scale data obtained via a questionnaire applied to 385 consumers selected via simple sampling method in Igdir province located in Eastern Anatolia Region of Turkey. As a factor extraction method, Robust Unweighted Least Squares (RULS) was specified together with prominin rotation method. Within the scope of explanatory factor analysis, 'FACTOR' software was specified as a remarkable tool in the determination of ideal number of factors and unnecessary items in the EFA analysis. Since use of Pearson correlations are not an advisable option in the violation of the assumption regarding univariate normal distribution of the ordinal variables in the 'FACTOR' software, polychoric correlation was adopted for the likert scale data analysis under investigation. All 29 items prepared on food purchasing preferences of consumers in the present study were included in the EFA analysis within the scope of RULS method. Asymptotic covariance/variance matrix was estimated by bootstrap sampling. Advised number of factors was found to be five. These factors are good reputation of the shop and experience (Factor 1), ease of purchasing (Factor 2), price and properties of product (Factor 3), qualified products (Factor 4) and promotion elements (Factor 5), respectively. Result of Kaiser-Meyer-Olkin (KMO) test was estimated as 0.74. Bartlett statistic was found to be 2541 ( $P=0.00001$ ). Bias-corrected bootstrap 95% confidence interval for KMO test was found between 0.739 and 0.758. Root Mean Square of Residuals ( $RMSR=0.0471$ ) was found lower compared with an expected mean value of RMSR estimated based on Kelley's criterion (0.0510). It was concluded that use of 'FACTOR' software was much more informative and reliable for the ordinal data. Moreover, food sellers and entrepreneurs who aim to improve marketing strategies might be advised to consider the aforementioned five factors that affect food purchasing preferences of the consumers.

**Keywords:** Robust Unweighted Least Squares, Ordinal data, EFA, Bootstrapping, purchasing preferences.

### **Introduction**

Nutrition is an important part of the human life since human beings need energy to continue living and to perform their daily functions. The quality of the food items from which human beings take necessary required nutritional elements is important to sustain a healthy life. In this respect, the food human beings consume must have certain nutritional and food safety standards. Food safety is one of the essential determinants of food demand (Erturk 2009). Food safety refers to handling, storing and preparing of food to prevent infection and help to make sure that our food keeps enough nutrients for us to have a healthy diet (Anonymous, 2017). Certifications guaranteeing safety in processes of production and distribution of foods not only increase demand for such products but also strengthens customers' loyalty to the brand and the seller (Besch 2002; Erturk 2009). It is reported that emotions (such positive or negative inner tensions as excitement, satisfaction, consciousness, etc.), motivations (being



activity-oriented, wishing to be healthy, etc.) and attitudes (product image, positive or negative customer response to a product) are the basic forces that constitute the consumer's drive for buying (Mutlu 2007).

Due to changing lifestyles consumers are now looking for healthy and authentic food products that they can consume. Thus, food safety concerns may be effective in the consumers' demand for any food product. Moreover, it is also important to have an understanding of other factors such as nutritional elements, tastes, ease of consumption, trust and brand respectability (Besch 2002; Erturk 2009).

Erturk (2009) reported that health safety, quality assurance and the product's taste as the most important factors affecting buying decisions of consumers for food products. Personal experiences about the product, certification of quality and packaging might also be effective in consumers' decision to buy. Gender of the consumer may also be effective in buying food products as women who direct household food consumption tend to be more conscious about food safety (Baker 2003). Importance attached to food safety also increases as incomes of the consumers increase (Ozturk 2006).

This study was conducted to determine factors that affect food demand of consumers in Iğdir province located in Eastern Anatolia Region of Turkey. For this aim, a questionnaire was applied to 385 consumers selected by simple sampling method and robust factor analysis was applied for an ordinal five-point likert scale data obtained via questionnaire. The results are discussed in the concluding section.

### **Materials and Methods**

The questionnaire study was conducted to determine factors affecting food purchase preferences of 385 consumers from Iğdir, Turkey, chosen randomly through simple sampling method.

Formula of simple random probability sampling used in the determination of the required sample size can be written as follows as defined by Karadas et al. (2017).

$$n \frac{z^2}{e^2} p \cdot q = n \frac{1,96^2}{0,05^2} 0,05 \cdot 0,05 = 385$$

n= sample size

z= Standard table value for 95%.

p= proportion of those who prefer potato (0.5)

q=proportion of those who don't prefer potato (q=1-p)

e= proportion of error accepted in sampling method (5%)

All the items ranging from 1 to 5 on the basis of an ordinal 5 point scale data regarding purchasing behavior (29 items) were gathered from the consumers.

Robust Unweighted Least Squares (RULS) extraction method was specified based on Promin rotation method for gaining better solutions in the ordinal data set. Polychoric correlation matrix was used instead of Pearson correlation matrix in the violation of the basic assumption on normal distribution of the ordinal items since null hypothesis of multivariate asymmetric kurtosis was rejected (P=0.000). Four new factors were extracted from all the items on both fresh potato and its products through `Factor` software program, which gives more comprehensive and understandable outputs (Lorenzo-Seva and Ferrando, 2006; Baglin, 2014). Suitability of explanatory factor analysis with the RULS extraction method to the studied data sets was tested with Kelley's criterion, giving the expected value for Root of Mean Square of

Residuals (RMSR). Determinant, Kaiser-Meyer-Olkin (KMO) and Bartlett test values of the polychoric correlation matrix were estimated. Also, Bias-corrected bootstrap 5% confidence interval for the KMO test was found.

### **Results and Discussion**

There are very few studies in the literature on the use of robust factor analysis methods. In the violation of the assumptions on normal distribution of ordinal items, the routine use of explanatory factor analysis may cause biased estimates. With the intention of this problem, a new free software `FACTOR` was developed by Lorenzo-Seva and Ferrando (2006). Very high reliabilities of four rotated factors were determined. Table 1 presents results of Robust Unweighted Least Squares Method for purchasing behaviour.

Advised number of factors was found to be five. These factors are good reputation of the shop and experience (Factor 1), ease of purchasing (Factor 2), price and properties of product (Factor 3), qualified products (Factor 4) and promotion elements (Factor 5), respectively. Result of Kaiser-Meyer-Olkin (KMO) test was estimated as 0.74. Bartlett statistic was found to be 2541 ( $P=0.00001$ ). Bias-corrected bootstrap 95% confidence interval for KMO test was found between 0.739 and 0.758. Root Mean Square of Residuals ( $RMSR=0.0471$ ) was found lower compared with an expected mean value of RMSR estimated based on Kelley's criterion (0.0510), implying that the explanatory factor analysis exposed to 29 items regarding purchasing behavior in the present study gave reliable outcomes.

Abdullah and Asngari (2011) reports that branding, validation and prices, packaging and taste are determining factors of demand for a soft-drink. Majumdar (2015) reports that environmental consciousness, price sensitivity, innovativeness in buying products, product involvement and health consciousness are significant factors affecting consumer demand for green cosmetics and food products. Gifford and Bernard (2008) suggests that organic labeling and promotion of organic status of foods may increase demand for non-genetically-modified food. McCluskey (2015) contends that the future of food is about taste, variety, healthiness, natural, authenticity, and freshness. Pícha et al. (2013), found that there is a strong link between quality, locality and environmental friendliness of food and food demand.

Although personal experience is a significant factor, our study showed that food safety is an important factor since the consumers' respect for the outlet and knowing or having been shopped from the same outlet before is an important determinant of demand. This is because the Turkish consumers put a great value on personal relationships with outlets and in Turkish commercial culture regular customers are very welcomed by the sellers. As a result of changes in the use of money, as well as in the consumer preferences and macroeconomic conditions, consumers prefer to use more easy payment methods such as credit cards. In connection with purchasing from well-known outlets, use of layaways and credit cards are also preferred by lower-income or lower-middle income consumers who try to manage their budgets. There is a general tendency to consider the source and originality, thus safety of foods, as such properties as geographical origin, calories, whether the product is organic or not, nutritional elements and quality certification are found to be important for the consumers. Price and discounts are still important determinants for consumers, however, recommendations of close social environment and salespeople are significantly important for consumers than the advertisement campaigns.

Table 1. Results of robust unweighted least squares method for food purchasing preferences

Factor Names	Items	F1	F2	F3	F4	F5
F1 (Recognition of outlet and experience)	According to the demands by family members	0,52				
	According to personal experience	0,64				
	Whether the product is imported	-0,32				
	Whether the product is packaged	0,43				
	Buying from a known place	0,50				
	Buying from commonly-known outlets	0,54				
	The outlet from which the products are bought	0,46				
F2 (Ease of purchasing)	Buying products that are not widely-known.	-0,45				
	Possibility of layaway purchase		0,54			
F3 (Price and properties of product)	Possibility of using credit card		0,74			
	Low price			-0,58		
	Label information			0,45		
	Having a certificate of quality			0,58		
	Being a well-known product			0,41		
	Nutritional elements			0,64		
	Calories			0,67		
	Organic products			0,58		
	Recommended by experts			0,43		
	Discount products			-0,51		
	Product and producer information available on package			0,47		
F4 (Specific products)	Products with promotional gifts			-0,32		
	High price				0,41	
	Local product				0,51	
	New product				0,42	
F5 (Promotional elements)	Preference of fractional prices				0,47	
	Advertisement					0,35
	Recommended by family and friends					0,71
	Recommended by salespeople					0,68

The differences between the results of this study and other studies may have been caused by differences in consumer cultures (tastes and preferences), differences in income levels, whether the products in question are specific products and the statistical approach utilized. Nevertheless, this study presented some informative results for identifying consumers' preferences in food purchases and provided some details that can guide local food producers and sellers in Iğdir province, as well as providing clues for further research on the subject using Robust Factor Analysis.

### Conclusions

The current results revealed that an application of EFA factor analysis on the basis of ULS extraction method, promin rotation method and polychoric correlations as a dispersion matrix was more effective compared with the traditional EFA applications for the ordinal data. According to the results of our study good reputation of the shop and experience (Factor 1), ease of purchasing (Factor 2), price and properties of product (Factor 3), qualified products (Factor 4) and promotion elements (Factor 5) are found as important factors affecting food

purchase by the consumers in Iğdir province. Consumers tend to think that well-known outlets are important in food safety. Consumers also choose to seek those outlets which offer them ease of purchasing.

### **References**

- Abdullah, L., Asngari, H., 2011. Factor Analysis Evidence in Describing Consumer Preferences for a Soft Drink Product in Malaysia. *Journal of Applied Sciences*, 11(1):139-144.
- Anonymous 2017. FAOSTAT. Food and Agricultural Organization. Access 08.07.2017.
- Baker, G.A. 2003. Food Safety and Fear: Factors Affecting Consumer Response to Food Safety Risk. *International Food and Agribusiness Management Review*, Volume 6, Issue 1, Texas, USA.
- Besch, M., 2002. Consumer and Nutritional Behavior. *Agro Food and Regional Marketing*, [www.wzw.tum.de/ml/skripten.html](http://www.wzw.tum.de/ml/skripten.html) (Access 02.05.2008).
- Erturk, Y. E., 2009. The Effects of The Quality Assurance Systems Used By The Food Industry On The Purchasing Behaviors Of The Consumers: The Samples Of ISO 9000, ISO 22000 (HACCP). Ph.D. Thesis. Ankara University Graduate School of Natural and Applied Sciences, Department of Agricultural Economics Ankara, Turkey
- Gifford, K., Bernard, J. C., 2008. Factor and Cluster Analysis of Willingness to Pay for Organic and Non-GM Food. *Journal of Food Distribution Research* 39(2): 26-39.
- Karadas, K., Kumlay, A. M., Eydurhan, E., Gursoy, A. K., 2017. Identification of Potato Purchasing Behaviors and Preferences of Consumers by means of Robust Factor Analysis. Paper Presented at The International Conference “Agriculture for Life, Life for Agriculture”, University of Agronomic Sciences and Veterinary Medicine of Bucharest, Bucharest, Romania, 9 June 2017.
- Lorenzo-Seva, U., Ferrando, P. J. (2006). FACTOR: A computer program to fit the exploratory factor analysis model. *Behaviour Research Methods*, 38(1): 88–91.
- Majumdar, S., 2015. Analysis of Factors Influencing Consumer Preferences for Green Cosmetic and Food Products: A study in and around Kolkata (West Bengal, India). Unpublished Phd. Thesis. ICFAI University Jharkhand Ranchi, India.
- McCluskey, J. J., 2015. Changing Food Demand and Consumer Preferences. Paper prepared for Agricultural Symposium Federal Reserve Bank of Kansas City July 14-15, 2015
- Mutlu, S. 2007. Gıda Güvenirligi Açısından Tüketici Davranışları (Adana Kenttsel Kesimde Kırmızı Et Tüketim Örneği). Cukurova Üniversitesi, Fen Bilimleri Enstitüsü, Tarım Ekonomisi Anabilim Dalı, Basılmamış Doktora Tezi, Adana.
- Ozturk, E. 2006. Effects And Importance Of Certificate Of Quality On Customer Purchase Behavior. Master Thesis, Marmara University, Social Science Institute, Istanbul, Turkey.
- Pícha, K., Skořepa, L., Navrátil, J., 2013. Assessment of the Results of The Strategic Orientation on Regional and Local Products in Food Retail. *Acta Universitatis Agriculturae Et Silviculturae Mendelianae Brunensis*, 61(4): 1061-163.

## WHITE CHEESE PHYSICOCHEMICAL PROPERTIES MADE OF IR PASTEURIZED MILK RIPENED IN KCL SOLUTION

Simin HAGH NAZARI\*<sup>1</sup>, Mohammad Reza AZIMI<sup>2</sup>, Sajjad VALINEZHAD<sup>1</sup>

<sup>1</sup>Department of Food Science and Technology, Agriculture Faculty, University of Zanjan, Zanjan, Iran

<sup>2</sup>Cultivation Department, Agriculture Faculty, University of Zanjan, Zanjan, Iran

\*Corresponding author:haghnazari.simin@znu.ac.ir

### Abstract

Using infrared irradiation heat for milk pasteurization as a technology with the high thermal efficiency can be a good alternative to traditional methods of milk processing. In addition by replacing potassium chloride instead of sodium chloride in the formula of the salt water of white cheese, the adverse health effects resulting from the consumption of sodium chloride can be prevented. In this study, by using the infrared radiation heat, raw cow milk was pasteurized and white cheese produced. The white cheese was placed in four different formulations of brine containing 1) NaCl: KCl, 10:0 percent 2) NaCl: KCl, 7.5: 2.5 percent, 3) NaCl: KCl, 5:5 percent and 4) NaCl: KCl, 0:10 percent for 21 days at a temperature of 8° C. Then the physicochemical characteristics of the cheeses were evaluated. Cheeses produced using two pasteurization methods of classic and infrared irradiation had significant differences in moisture and dry matter content.

**Key Words:** *NaCl, KCl, White Cheese, Brine, Infrared pasteurizing*

### Introduction

Cheese contains less water than milk, and so has different organoleptic properties and shelf life than milk (Walstra et al., 2006). Cheese is a rich source of protein, fat, calcium, phosphorus, riboflavin and other vitamins. Also it can be more useful than milk in high protein diets, also its proteins are highly digestible (Renner, 1993).

Traditional production of white cheese in brine has been popular for centuries in small-scale cow keeping farms. Along with the recent developments in dairy product processing industry and with the integration of mechanization and automation, large-scale production of cheese became possible (Ozer, 2014).

Salting is an important stage in the process of cheese. History of salt used as an additive is related to 3,000 years before Christ (Woodin, 1981; Durack et al., 2008). Salt is considered as an additive commonly used in the food industry and plays a vital role in the food processing including food protection, helping to improve the flavor, the impact on proteolysis, water activity and strength in the tissue (Reddy and Marth, 1991; Guinee, 2004a; Guinee and Fox, 2004). Salt provides about 90 percent of the sodium in the human diet (He et al., 2012). In the structure of the salt, the sodium intake is very important to control the membrane potential of the cell and absorption of nutrients in the small intestine. In order to maintain the blood volume, osmotic pressure on the cell and also transportation of nervous signals, sodium is essential (Strazzullo et al., 2009; He and MacGregor, 2010). Although salt plays an important role during food processing, but has been known to be a major risk for diseases such as osteoporosis due to urinary excretion of calcium chloride, kidney stones and high blood pressure (Beumi et al., 2002; Kotchen, 2005 ; Massey, 2005; Heaney, 2006). World Health Organization has recommend food manufacturers to reduce the use of salt (WHO, 2007). Meat, dairy, bakery and other food products, each include a different percentages of sodium

uptake by the body in different classes in the world for example, the daily intake of sodium through cheese in England, France, America and Australia, have been reported 7.8, 9.2, 8.2 and 5% namely (Meneton et al., 2009; Anderson et al. , 2010). So many efforts have been made for producing of low-salt cheese using different techniques such as reducing the amount of salt or partial replacement of salt in cheese with other materials (Guinee and O'Kennedy, 2007). Reducing the salt content of the Cheddar cheese and the effects of these changes on the chemical composition, proteolysis, and sensory properties were done by Schroeder and colleagues (1988b). Replacing salt with other materials such as potassium chloride, calcium chloride and magnesium chloride may be considered as a successful strategy to reduce the amount of salt (Kilcast and den Ridder, 2007). Also partial replacement of sodium chloride with potassium chloride revealed that the quality of the cheese has not significantly changed (Guinee, 2004b). Potassium chloride salt is acknowledged as a potential alternative to sodium chloride in cheese making. Increasing potassium intake has been reported as a protection factor for people with hypertension (Fregly, 1981; Reddy and Marth, 1991). A mixture of potassium chloride and sodium chloride has been successfully used in cheese production and no adverse effects have been reported on the quality of the cheese (Fitzgerald and Buckley, 1985). Several studies have been also made on the effect of replacing sodium chloride with potassium chloride on the properties of Cheddar (Reddy and Marth, 1993a), feta cheese (Katsiari, et al., 1997; 2000a), Kefalograviera cheese (Katsiari et al., 2001a), and Fynbo cheese (Zorrilla and Rubiolo, 1994; Zorrilla et al., 1996), but there is not any investigation on white cheese made of IR pasteurized milk and aged in KCl substituted brine. Infrared heating is an alternative preservation method with higher thermal efficiency which transfers thermal energy in the form of electromagnetic waves. Recent applications of infrared heating indicate this technology is a viable alternate for the pasteurization of liquid foods, in addition it can decontaminate foodstuffs in both liquid and solid foods with retaining higher levels of health promoting compounds (Hagh Nazari. 2014). The aim of this research is to study the effects of replacement of NaCl with KCl salt on the physico-chemical properties of ripened white brined cheese made from pasteurized milk using infrared irradiation.

### **Materials and Methods**

Cheese making method: for the preparation of cheese, raw milk from the dairy farm of Zanjan University was prepared. Raw milk was pasteurized using flavor wave Turbo device that emits infrared waves at 72 ° C for 15 seconds has shown in figure 1. The temperature of the process was checked by a digital thermometer model TES made in China. For comparing and evaluating the effects of the pasteurization methods, the milk was also pasteurized using classic (conventional) methods. After pasteurization of milk, 200 ml of milk was poured in lidded plastic containers of the same shapes in 3 replicates equaled 24 samples.

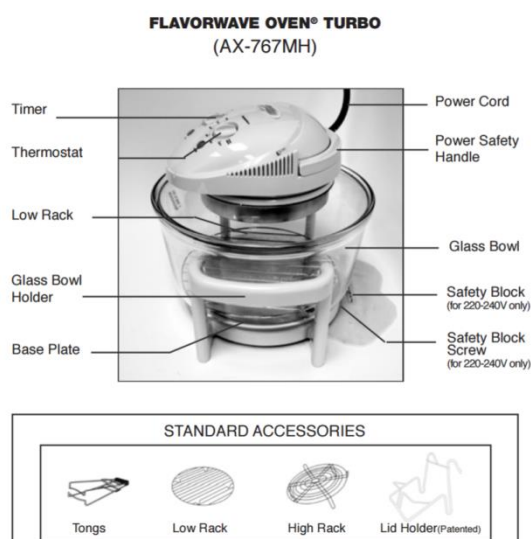


Figure 1: flavor wave Turbo device

After the milk temperature reached to 35 °C; the kefir starter solution to the volume of 2 ml along with calcium chloride to the amount of 0.02% of the milk were added to the pasteurized milk. The samples were transferred to an incubator made in Memmert Company in Germany at 35°C. And 20 minutes after adding the starter, the fungal rennet Valiren made in America was added the amount of 0.0025 gram to each container at 35°C.

After clot formation, clots were left without cutting for 12 hours in 18°C to continue fermentation, coagulating and dewatering. The resulting clots were transferred to salt solutions containing: 1) NaCl: KCl, 10:0 percent 2) NaCl: KCl, 7.5: 2.5 percent, 3) NaCl: KCl, 5:5 percent and 4) NaCl: KCl, 0:10 percent for 21 days at a temperature of 8° C. After ripening, physic-chemical tests were conducted on the cheese.

Chemical tests: measurement of chemical compounds was conducted by AOAC methods (AOAC, 2012). Moisture, fat and protein contents were measured using the oven at 102 degrees Celsius, Gerber method, and Kjeldahl method respectively. PH was measured by Professional portable milk pH Meter HI98162 provided by Hanna Company.

Statistical analysis: factorial experiments were conducted in a completely randomized design with three replications. The statistical comparison was done using the Mstat-C software via Duncan's method.

## Results and discussion

### Chemical analyses:

Chemical assessments on raw milk and pasteurized milk using classic method and infrared irradiation are reported in Table 1.

Table 1. Chemical assessments on raw milk and pasteurized milk using classical method and infrared irradiation.

Analysis	Raw Milk	Classic Pasteurized Milk	IR Pasteurized Milk
pH	0.005 ± 6.6866	0.005 ± 6.68	0.005 ± 6.6866
Density	0.0005 ± 1.02867	0.0005 ± 1.02866	0.0004 ± 1.02822
Acidity	0.001 ± 0.1463	0.0015 ± 0.1476	0.0005 ± 0.1476
Fat	0.0082 ± 3.66	0.0032 ± 3.649	0.0074 ± 3.6606
Protein	0.0066 ± 3.2166	0.007 ± 3.2096	0.0065 ± 3.214
Lactose	0.00821 ± 4.8611	4.8483 ± 0.006	0.01 ± 4.8542
Nonfat Dry Mass	0.00356 ± 8.4797	0.0023 ± 8.473	0.001 ± 8.4793
Calcium	0.0002 ± 0.122	0.0033 ± 0.120	0.0004 ± 0.122

The comparison of data means resulting from the analysis of the cheese characteristics show that the cheeses made from two types of pasteurized milk and different brine formulations only differ in the amount of moisture and dry matter content and there is no significant difference between them. The impact of the brine formulation on the pH of the cheeses: PH of cheeses began to decreasing during preparation and aging in brine formulations and finally reached to 4.02 from 5.3 in beginning stage o aging. Figure 2 shows the pH of ripened cheeses in various ratios of brine and different milk pasteurization methods.

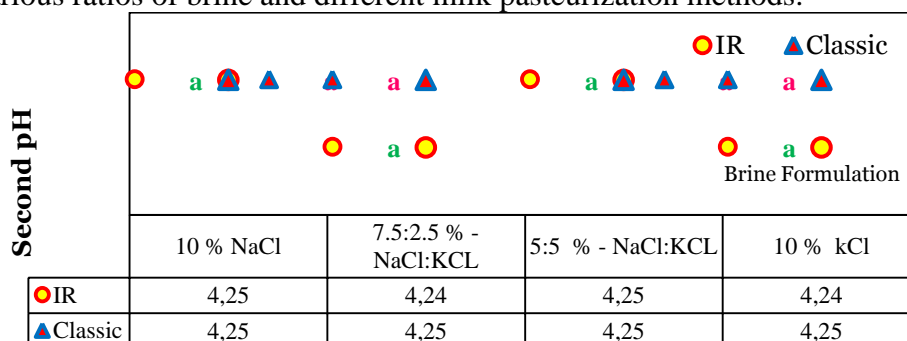


Figure 2: Comparison of the pH of ripened cheeses in various ratios of brine and different milk pasteurization methods

**Comparison of cheese samples appearance:**

The comparison of the clots formed from pasteurized milk using infrared radiation (1) and Classic method (2) at 72° C for 15 seconds is shown in Figure 3.

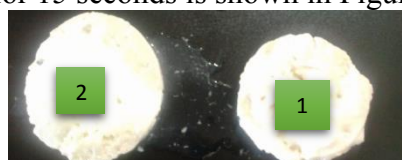


Figure 3: comparison of the clots formed from pasteurized milk using infrared radiation (1) and Classic method (2) at 72° C for 15 seconds.



The comparison of the clots formed from pasteurized milk using infrared radiation (1) and Classic method (2) shows that the volume of the Infrared irradiated samples are smaller with higher coherence and solidity.

#### **✚ The organoleptic analysis of cheeses**

The color, flavor and tastes of the cheeses (the organoleptic results) examined by taste panel showed that there is no significant difference between samples.

#### **✚ The use of potassium chloride in the formula of the cheese brine:**

The reason of the replacement of sodium chloride with potassium chloride, is achieving a product that reduces harmful effects to health caused by the consumption of sodium chloride. In addition to the fact that the product is supposed to be acceptable in terms of evaluated properties. The results of the analysis showed that the only difference between white cheeses produced in different brine formulas is in their firmness. Reduced sodium salt cheese is very soft, bitter, less salty, and has a strong off-flavor and shorter shelf life (Ying Lu, 2012). Potassium chloride (KCl) has a similar structure and salty flavor as sodium chloride (salt) and partial replacement of salt with potassium chloride can be used to lower salt content in foods. Moreover, potassium can lower the blood pressure and the risk of heart disease or stroke. Thus, potassium chloride is a potential substitution for salt in cheese.

#### **✚ Effects of brine formula on Cheese pH:**

At the beginning of ripening period of the cheese samples, the production of lactic acid from lactose reduces the pH and increases the acidity by Lactic Acid Bacteria. With improvement of the cheese ripening, the reduction of lactose continues and lactic acid inhibitory effect begins on the activity of some lactic strains. So, the production of lactic acid is reduced and consequently, the testable acidity remains constant.

Comparing the results of pH shows that differences in the pH in ripened cheese made from pasteurized milk with the two methods is not significant. PH difference between different formulations of salt water is not significant in ripened cheese.

The similar results obtained by Lindsay in 1982, Aly Katsiari in 1985 and in 1998, 2000 and 2001 for cheddar and feta cheeses. The researchers also attributed the reason of the lactic acid produced from lactose causing the initial reduction of pH, while the advancement of proteolysis and lipolysis results an increase in the amount of amino acids and fatty acids during the ripening period induces to final pH decrease.

The researchers also reported that the initial pH of the cheese is specified according to the pasteurization method, the type of milk used to make cheese, the microbial load of the raw milk and the starter culture type. While the pH of the ripened cheese is specified according to the ripening temperature, period length and the type of rennet used (Lindsay, 1982; Aly, 1985; Katsiari et al., 1998, 2000, 2001). Partial replacement of sodium chloride with potassium chloride with different levels of substitution (10:00 percent sodium chloride - potassium chloride, 7.5:2.5% sodium chloride - potassium chloride, 5:5 % sodium chloride - potassium chloride and 10:00 percent potassium chloride - NaCl) had no significant effect on pH values. These results are similar to findings of Katsiari in 1998, 2000 and 2001. This researcher replaced (3% sodium chloride, 1.5:1.5 percent sodium chloride - potassium chloride and 3% potassium chloride) on Kefalograviera cheese and observed no significant change in the pH of the cheese. (Katsiari et al., 1998, 2000, 2001).

#### **✚ Effects of brine formula on the chemical properties of cheese**

In examining the impact of different levels of sodium and potassium chloride on cheese chemical properties (including the amount of fat and protein) by infrared or classic method for pasteurization; it became clear that replacement of sodium chloride with potassium chloride in brine have both no significant effect on the fat and protein of the produced cheeses (based on dry weight). Results of the studies of Lindsay in 1982, Aly Katsiari in 1985, 1998, 2000 and 2001 also showed similar results. In addition in 1998 and 2000, Katsiari pointed out that the

changes in the amount of fat, protein and other compounds of cheese occurred by the lipolysis, proteolysis, lactic acid production and other reactions happened during the ripening period not due to brine formula. Although added calcium chloride can effect on cheese density and volume of cheese due to participating in paracaseinate calcium clots which induce the syneresis reaction improve (Fuca, 2012).

#### **✚ The effect of infrared radiation in cheese production**

Examining properties of the produced cheeses showed no significant difference between the cheeses produced from pasteurized milk using the infrared and classic methods but due to the high heat performance in the infrared radiation, the pasteurization process of milk is approximately 75% faster than the classic method. It is considered a more suitable method for pasteurization of milk compared to the classic method especially due to the heat shock effect on microbial cellular structure. All above studies confirms this project's results due to the higher efficiency and saving energy consumption via IR assisted systems in comparison of classic method of pasteurization.

### **Conclusion**

In general, from this study it can be concluded that changing the formulation of the used brine has no effects on cheese properties.

Effects of brine formula on Cheese pH shows that differences in the pH in ripened cheese made from pasteurized milk comparing with the two methods is not significant.

Effects of brine formula on the chemical properties of cheese shows replacement of sodium chloride with potassium chloride in brine have both no significant effect on the fat and protein of the produced cheeses (based on dry weight).

### **References**

- Aly M. E. (1995). An attempt for producing low-sodium Feta type cheese. *Food Chem.* 52: 295-299.
- Anderson, C. A., Appel, L. J., Okuda, N., Brown, I. J., Chan, Q., Zhao, L., Ueshima, H., Kesteloot, H., Miura, K., Curb, J. D., Yoshita, K., Elliott, P., Yamamoto, M. E., Stamler, J. (2010). Dietary sources of sodium in China, Japan, the United Kingdom, and the United States, women and men aged 40 to 59 years: the INTERMAP study. *J. Am. Diet. Assoc.* 110: 736–745.
- Ayyash, M.M, Sherkat, F., Francis, P. Williams R.P. W. Shah N.P. (2011). The effect of sodium chloride substitution with potassium chloride on texture profile and microstructure of Halloumi cheese. Volume 94, Issue 1, Pages 37–42.
- AOAC. (1995). *Official Methods of Analysis*. AOAC International, Arlington, VA.
- Buemi, M., Senatore, M., Corica, F., Aloisi, C., Romeo, A., Tramontana, D., et al. (2002). Diet and arterial hypertension: Is the sodium ion alone important. *Medicinal Research Reviews*, 22(4): 419–428.
- Binker, E. F., and Kolari, O. E. (1975). The history and use of nitrate and nitrite in the curing of the meat. *Food Cosmet. Toxicol*, 13: 655-661.
- Durack, E., Alonso-Gomez, M., and Wilkinson, M. G. (2008). Salt: A review of its role in food science and public health. *Current Nutrition and Food Science*, 4: 290 - 297.
- Fitzgerald, E. and Buckley, J. (1985). Effect of total and partial substitution of sodium chloride on the quality of Cheddar cheese. *Journal of Dairy Science*, 68:3127-3134.
- Fregly, M. J. (1981). Sodium and potassium. *Annual Review Nutrition*, 1: 69-93.
- Fuca N, McMahon DJ, Caccamo M, Tuminello L, La Terra S, Manenti M, Licitra G. *J Dairy Sci.* 2012 Jan;95(1):460-70. doi: 10.3168/jds.2011-4438. PMID: 22192226.

- Guinee, T. P., & O’Kennedy, B. T. (2007). Mechanisms of taste perception and physiological controls. In: T. P. Guinee, & B. T. O’Kennedy (Eds.), *Reducing salt in foods: Practical strategies* (pp. 246-287). Boca Raton LA, USA: CRC Press.
- Guinee, T. P. (2004a). Salting and the role of salt in cheese. *International Journal of Dairy Technology*, 57: 99-109.
- Guinee, T. P. (2004b). Scrap the salt: as concern about the high salt content of cheese rises. *Dairy Industries International*, 69: 36 - 38.
- McSweeney, L. H., Cogan, T. M., and Guinee, T. P., edr. Elsevier Academic Press, London, UK.
- Hagh Nazari, S. (2014). Impact of using infrared irradiation energy in food processing. *Energy Education Science and Technology Part A: Energy Science and Research. Volume (issues) 32(2): 1387-1396.*
- Heaney, R. P. (2006). Role of dietary sodium in osteoporosis. *J. Am. Coll. Nutr.* 25: 271–276.
- He, F. J., MacGregor, G. A. (2010). Reducing population salt intake worldwide: from evidence to implementation, *Prog. Cardiovasc. Dis.*, 52: 363 – 382.
- M. C., Voutsinas, L. P., Alichanidis, E., & Roussis, I. G. (1997). Reduction of sodium content in Feta cheese by partial substitution of NaCl by KCl. *International Dairy Journal*, 7(6-7): 465-472.
- Katsiari, M. C., Voutsinas L. P., Alichanidis E., Roussis G. (1998). Manufacture of Kefalograviera cheese with less sodium by replacement of NaCl with KCl. *Food Chem.*, 61: 63-70.
- Katsiari, M. C., Voutsinas, L. P., Alichanidis, E. and Roussis, I. G. (2000). Proteolysis in reduced sodium Feta cheese made by partial substitution of NaCl by KCl. *International Dairy Journal*, 10: 635-646.
- Katsiari, M. C., Voutsinas, L. P., Alichanidis, E. and Roussis, I. G. (2001). Lipolysis in reduced sodium Kefalograviera cheese made by partial substitution of NaCl with KCl. *Journal of Food Chemistry*, 72: 193-197.
- Kilcast, D. and den Ridder, C. (2007). Sensory issues in reducing salt in food products Pages 201-220 In *Reducing Salt in Foods: Practical Strategies*. Kilcast, D. and Angus, F., edr. CRC Press LLC, Washington DC, USA.
- Kotchen, T. A. (2005). Contributions of sodium and chloride to NaCl-induced hypertension. *Hypertension* 45: 849–850.
- Krishnamurthy, K., Khurana, H.K., Soojin, J., Irudayaraj, J. and Demirci, A. (2008). Infrared Heating in Food Processing: An Overview. *Comprehensive Reviews in Food Science and Food Safety*, 7, 2-13. <http://dx.doi.org/10.1111/j.1541-4337.2007.00024.x>.
- Massey, L. K. (2005). Effect of dietary salt intake on circadian calcium metabolism, bone turnover, and calcium oxalate kidney stone risk in postmenopausal women. *Nutr. Res.* 25: 891–903.
- Meneton, P., Lafay, L., Tard, A., Dufour, A., Ireland, J., Menard, J., Volatier, J. L. (2009). Dietary sources and correlates of sodium and potassium intakes in the French general population, *Eur. J. Clin. Nutr.* 63: 1169–1175.
- Ozer, B. (2014). Microflora of White-Brined Cheeses. In C. Batt, & M. Tortorello, *Encyclopedia of Food Microbiology* (p. 402). Academic Press is an imprint of Elsevier.
- Reddy, K. A., and Marth, E. H. (1993). Lipolysis in Cheddar cheese made with sodium chloride, potassium chloride or mixtures of sodium and potassium chloride. *Milchwissenschaft*. 48: 488-493.
- Reddy, K. A., and Marth, E. H. (1991). Reducing the sodium content of foods: A review. *Journal of Food Protection*. 54: 138-150.
- Renner, E. (1993). Nutritional aspects of cheese. In: P. F. Fox (Ed), *cheese: chemistry, physics and microbiology Vol 1*(pp, 557-559). London: Elsevier applied science.

- Schroeder, C. L., Bodyfelt, F. W., Wyatt, C. J., & McDaniel, M. R. (1988). Reduction of sodium chloride in cheddar cheese: effect on sensory, microbiological, and chemical properties. *Journal of Dairy Science*, 71(8): 988-993.
- Strazzullo, P., D'Elia, L., Kandala, N. B., Cappuccio, F. P. (2009). Salt intake, stroke, and cardiovascular disease: meta-analysis of prospective studies. *BMJ*, 339: 1 – 9.
- Walstra, P., Wouters, J., & Geurts, T. (2006). Principles of Cheese Making. In P. Walstra, J. Wouters, & T. Geurts, *Dairy Science and Technology* (pp. 577-582). NW: Taylor & Francis Group, LLC.
- World Health Organization. 2007. Reducing salt intake in populations: Report of a WHO forum and technical meeting. Accessed August 7, 2008. [http://www.who.int/dietphysicalactivity/reducingsaltintake\\_EN.pdf](http://www.who.int/dietphysicalactivity/reducingsaltintake_EN.pdf).
- Woodin, G. B. (1981). Salt maintains essential role as excess use is criticized. *Journal of Food Development*, 15: 38-41.
- Ying, Lu. Effects of Sodium Chloride Salting and Substitution with Potassium Chloride on Whey Expulsion of Cheese. Thesis for Master of Science. 2012. Utah State University.
- Zorrilla, S. E., Castelao, E. L., De Piante, D., & Rubiolo, A. C. (1996). Proteolysis during ripening of low-fat Fynbo cheese salted with a mixture of NaCl and KCl. *The Australian Journal of Dairy Technology*, 51: 6-7.
- Zorrilla, S. E., and Rubiolo, A. C. (1994). Modeling NaCl and KCl movement in Fynbo cheese during salting. *J. Food Sci.* 59:976–980.

## BIONOMY OF PEAR PSYLLA (*CACOPSYLLA PYRI* L.) IN EAST SARAJEVO AREA (BOSNIA AND HERZEGOVINA)

Dejana TEŠANOVIĆ<sup>1\*</sup>, Radoslava SPASIĆ<sup>2</sup>

<sup>1</sup>University of East Sarajevo, Faculty of Agriculture, Vuka Karadžića 30, East Sarajevo, Bosnia and Herzegovina

<sup>2</sup>University of Belgrade, Faculty of Agriculture, Nemanjina 6, Belgrade, Serbia

\*Corresponding author: dejanatesanovic@yahoo.com

### Abstract

The pear psylla, *Cacopsylla pyri* L. (Hemiptera, Psyllidae) is one of the most important pests on pear in all regions where this fruit species is grown. This species is causing direct and indirect damages, thus reducing the yield and quality of the fruit. In addition, the application of molecular methods confirmed vector function of this species in the transmission of phytoplasma „*Candidatus Phytoplasma pyri*“ which causes a dangerous disease, „Pear Decline“ (PD) and destruction of pears (Carraro et al., 1998). The survey was conducted in 2011 and 2012 in orchards, in locations Vojkovići, Kula, Tilava, Petrovići and Kasindo (City of East Sarajevo, Bosnia and Herzegovina). Pear orchards were differ in age and growing module as well as in the other environmental characteristics such as altitudes and climate. Pear psylla was collected at different stages of development and examined in the laboratory - Faculty of Agriculture, University of East Sarajevo. Collected species were fixed in 70% alcohol, and preparations of adults and larvae were made in order to determination species. Bionomy of *Cacopsylla pyri* was examined in pear orchards and in laboratory on a sampled infested plant material.

**Key Words:** *Pear Psylla*, *development*, *City of East Sarajevo*.

### Introduction

The pear psylla, *Cacopsylla pyri* L. (Hemiptera Psyllidae), is known in Europe for its extended infestations which may cause heavy economical losses to most pear growing regions. The damages that *C. pyri* may induce to pear trees are classified in two main types: 1) direct damages, weakening the plant by subtraction of nutrients; when the pest attack is intense, the plant wastes away with reduced production; 2) indirect damages, due to the production of a large amount of honeydew on which sooty molds develop (russetting fruits, Fig. 2), and also to the possible transmission of phytoplasmas (Horton, 1999). In the first case the most damaging stages are the nymphs of all instars because of the high amount of honeydew (produced especially in spring and summer) dripping on everything including fruits. Besides lowering the fruit market value, honeydew favours the growth of sooty molds caused by saprophytic fungi, in turn causing indirect injury to the plant (Pasqualini et. al., 2003; Civolani, 2012).

Thus, in the Czech Republic, *C. pyri* is the most important species in pears, especially since the early 1990's when enormous damages were registered (Kocourek and Stará, 2006). In Spain and Italy, *C. pyri* also have the first place for damage (Conci et al., 1993; Pasqualini et al., 2002; Sanchez and Ortin-Angulo, 2011; Civolani, 2012). The harmfulness of *C. pyri* in Greece and Turkey, as well as in other European countries, are confirmed by the data of many authors (Broumas et al., 1989, Stratopoulou and Kapatos, 1995, Souliotis and Broumas, 1998; Erler, 2004).

In the area of the former Yugoslavia, since the beginning of the 80's in the XX century, *C. pyri* has become an increasing problem (Krnjaić and Grujić, 1982). From this period, this species continues to cause damage in pear orchards, and thus represents the most important pest of pears that endangers the survival of pear, in all former parts of Yugoslavia, regarding present countries in the environment (Milenković et al., 1998; Maceljki, 2002; Petrović - Obradović et al., 2007). The number of generations of *C. pyri* during the year is different, depending on the geographic region and the climatic conditions. Thus, this species in southern France, it can develop up to eight generations (Burckhardt, 1994), in Serbia formed five (Jerinić-Prodanović, 2010), and in Slovenia four generations (Vrabl and Matis).

### Materials and Methods

The bionomy of *Cacopsylla pyri* was done in 2011. and 2012 in the field and in laboratory of the Agriculture Faculty of East Sarajevo. A field survey was conducted in intensive orchards, in the locations of Vojkovići and Kula, in the semi-intensive orchards in the locations of Tilava and Petrovići, and in extensive orchard in the location of Kasindo. Using entomological methods, such as visual examination of trees, taking a sample of infestation plant organs, collecting preimaginal stadium and adults insects, the bionomy was examined. In this sense, the way of wintering, spring activation, development during vegetation, number of generations, length of developmental stages of life and number of individuals were observed.

Visual examination of trees was done during the vegetation season at intervals of 10-15 days, and during the winter. Winter examination of plants was done by the two samples of two total length of 2 m of two- nor three-year branch were survey (from different places was taken of the 10 branches of length 20 cm) and examined in detail in the laboratory under the dissecting microscope. In all locations, were examined of 20 trees. By method of sampling of 100 diferent plants organs (leaf and flower buds, leaves, fruit) with a randomly selected tree, the presence of this species and development stage, was determined. All sampled infested plant material was observed in laboratory. All collected preimaginal stadium, were reared in the laboratory to adult stadium. The rearing of *C. pyri* was by the method Hodkinson&White, 1979 (cit. Jerinić-Prodanović, 2010). The collected and reared insects were fixed in 70% alcohol; some of them were prepared, and making microscopic preparations or the entomological collection.

The determination of species was based on morfological characteristic of adults and larvae, such as the appearance of genital and anal complex males and females, and the front nervature skirts, as well as the looks of thew fifth larval instar of development. Therefore, temporary and permanent microscopic slides of whole insect body parts important to the determination were made by the method of cold or hot maceration in 10% KOH. Permanent slides were made in Canada balsam by the method Hodkinson & White (1979) and Burckhardt (1989) (cit. Jerinić- Prodanović, 2010).

Considering that the bionomy and the growth cycle of insects in general, depends of the climatic conditions of the external environment, the most of the temperature, relative humidity and precipitation in the area, the meteorological data was followed and obtained from the Federal Hydrometeorological Institute in Sarajevo (Fig. 1, 2).

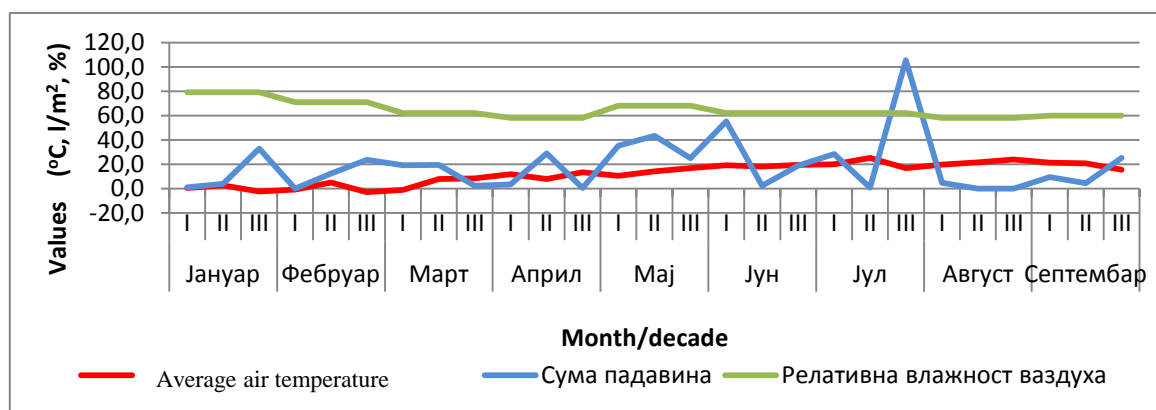


Fig. 1. Meteorological data in 2011

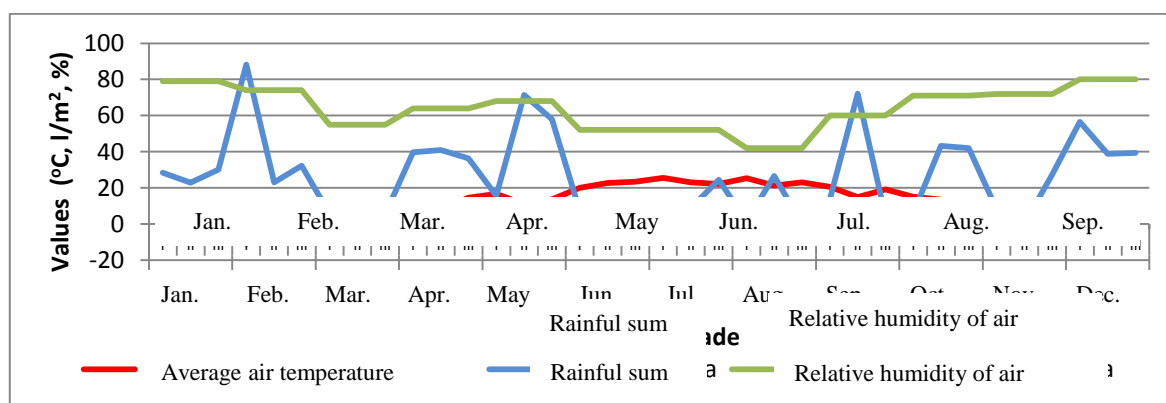


Fig. 2. Meteorological data in 2012

### Results and discussions

#### Average air temperature

In pear orchards of East Sarajevo, during the two examination years, the pear psylla (*C. pyri*) developed four generations during the both years (Table 1), and while according to the data of other authors, in neighboring countries, in Serbia have five generations, in Slovenia four (Vrabl and Matis, 1977, Jerinić-Prodanović, 2010).

Table 1. Development calendar of *C. pyri*

Month Year	I	II	III	IV	V	VI	VII	VIII	IX	X	XI	XII
2011.	++	+	++ +	++ +	•• -- ++	•• ++ +	•• -- +	•• -- +	•• -- ++	•• -- ++	++	++

2012.	++	+	++	++ + ●● -	●● -- +	++ ●● --	- ++	●● ●● -	-- ++	●● -	++ ●● -	- ++	++	++

+ overwintering adult; ● eggs; - larvae; + adult new generation; — period of harm

The time of activation of the *C. pyri* depends on climatic factors, especially to temperature. Considering that *C. pyri* overwinter as adult on pear trees, in our research, the first adults were registered at the end of the second decade of March (March 17 in 2011 and March 19 in 2012), with average air temperatures of 7,9 °C in 2011 and 6,8 °C in 2012 (Fig.3,4). According to the data the other authors, the first activity of adult was registered at the beginning of February (Jerinić-Prodanović, 2010), in the winter days when the air temperature is 4-5°C (Almaši et al., 2004).



Fig. 3. Male of *C. pyri* – winter form



Fig. 4. Female *C. pyri* – winter form

Also, in this period, but also a few days earlier, at the beginning of the second decade of March, on the branches eggs were found, respectively 13 to 41 per sample.

The period of oviposition was very long, about two months, until the beginning of the second decade of May. The highest number of eggs laid, was during the third decade of April, at an average air temperature of 13,3°C in 2011 and 14,6°C in 2012, on buds and young leaves, mostly close to the main foliar nerve (Fig. 5). The first larvae were found on April 20 in 2011 and April 21 in 2012. They were mainly concentrated on young leaves or buds, and later found on young shoots (Fig. 6). The larvae have five development stages (Fig. 7,8).





Fig. 5. Eggs *C. pyri* on leaf of pear



Fig. 6. Larva *C. pyri* – L<sub>1</sub>



Fig. 7. Larva *C. pyri* – L<sub>4</sub>



Fig. 8. Larva *C. pyri* – L<sub>5</sub>

The complete development of larvae was 29 days in 2011, and 31 days in 2012. So, the first image of the first generation was determined on May 19 in 2011, and May 22 in 2012. The development of this generation was 55 days. The female of this first generation have laid eggs during the second decade of May and June on leafs and young shoots. The first larvae were registered on June 15 in 2011, and June 16 in 2012. In this second generation, the development of larvae was some longer, 28 days in 2011 and 25 days in 2012.

Feeding on sup from the leaves, larvae *C. pyri* produce a large amounts of honeydew, especially at temperatures higher than 18°C. Our research also confirms the present of honeydew which covering the young shoots of pears, especially in the third decade of June, when air temperature was 19,5 °C in 2011 and 23,4 °C in 2012 (Jerinić-Prodanović, 2010; Almaši et al., 2004). The first adult of the second generation registered on July 13 in 2011, and July 05 in 2012. So, the development of this generation was 55 days in 2011 and 44 days in 2012. The larvae of this generation were registered on July 29 in 2011 and July 21 in 2012. Their development was 22 to 25 days, so the adult of third generation was registered on August 24 in 2011 and August 13 in 2012. The complete development of this generation was 41 days in 2011 and 40 days in 2012. According to the literature data (Jerinić-Prodanović, 2010), the development of the larvae *C. pyri* lasts 20 to 40 days, what is in agreement with our results because the larvae developed from 22 to 31 days, depending on the temperature conditions.

The larvae of third generation have developed in September 08 in 2011 and September 28 in 2012. Their development lasted 30 to 37 days, so adult of fourth generation registered at the beginning of the second decade of October (Oct. 09 in 2011 and Oct. 04 in 2012), what meaning that the complete development of this generation was 47 days in 2011 and 52 days in 2012. This adult *C. pyri* were registered in the orchards of pear by middle November.

According to literature data, generations of *C. pyri* are overlap, what is an agreement with our result of research (Maceljčki, 2002; Almaši et al., 2004).

### Conclusion

In pear orchards in the area of East Sarajevo, pear psylla (*C. psylli* L.) developed four generations in 2011. and 2012. year.

The first wintering adults were registered at the end of the second decade of March on pear trees to both years. The development of the larvae *C. pyri* was from 22 to 31 days, depending on the temperature conditions. The complete development one generation was from 40 to 55 days, depends from climatic conditions. Generations of *C. pyri* overlapped during both research years.

### References

- Almaši, R., Injac, M., Almaši, Š. (2004). Štetni i korisni organizmi jabučastih voćaka, Univerzitet u Novom sadu, Poljoprivredni fakultet.
- Broumas, T., Souliotis, C., Stavraki, H., Sdoukopolus, D (1989). Biological observations of *Cacopsylla pyri* L., on pear trees in the area of Larissa, pp.67-77. In: Proceedings of 2nd Panhellenic Confress of Entomology.-Athens, 1987.
- Burckhardt, D. (1994). Psylloid pest of temperate and subtropical crop and ornamental plants (Homoptera, Psylloidea). A review. Entomol. (Trends in Agril.Sci.). 2.173-186.
- Burckhardt, D. (1989). Blattflöhe (Homoptera, Psylloide): Systematik und Biologie. Mitt. Entom. Gessellschaft Basel 39 (1/2): 51-65.
- Carraro, S., Loi, N., Ermacora, P., Gregoris, A. & Osler, R. (1998). Transmission of pear decline by using naturally infested *Cacopsylla pyri*. Acta Horticulturae, 472, 665-668.
- Civolani, S., (2012). The Past and Present of Pear Protection Against the Pear Psylla, *Cacopsylla pyri* L., Insecticides - Pest Engineering, Dr. Farzana Perveen (Ed.), ISBN: 978-953-307-895-3.
- Conci, C., Rapisarda C., Tamanini, L. (1993). Annotated catalogue of the Italian Psylloidea. First part.- atti dell Accademia Roveretana degli agiati, ser. VII, vol II, B: 33-136.
- Erler, F. (2004). Natural Enemies of the Pear Psylla *Cacopsylla pyri* in Treated vs Untreated Pear Orchards in Antalya, Turkey. Phytoparasitica 32(3):295-304.
- Hodkinson, I. D. & White I. M. (1979). Homoptera, Psylloidea. Handbooks for the Ident. Brit. Insects. Vol. II, Part.5 (a): Roy. Ent. Soc. Of London. 101 pp.
- Horton, D.R. (1999). Monitoring of pear psylla for pest management decisions and research. Integr. Pest Manag. Rev. 4:1-20.
- Jerinić-Prodanović, R.D. (2010). Diverzitet lisnih buva (Homoptera: Psylloidea) i njihovih prirodnih neprijatelja u Srbiji sa posebnim osvrtom na vrste značajne u poljoprivredi, Doktorska disertacija, Univerzitet u Beogradu, Poljoprivredni fakultet Beograd-Zemun.
- Kocourek, F., Stará, J. (2006). MANAGEMENT AND CONTROL OF INSECTICIDERESISTANT PEAR PSYLLA (*Cacopsylla pyri*). Journal of Fruit and Ornamental Plant Research Vol. 14 (Suppl. 3), 167-174.
- Krnjajić, Đ., Grujić, D. (1982). Stanje biljnih bolesti i štetočina na teritoriji SFRJ u 1981. godini. Glasnik zaštite bilja, Savez društva za zaštitu bilja Jugoslavije. Godina V, 7/8-1982.
- Maceljčki, M. (2002). Poljoprivredna entomologija, II dopunjeno izdanje, Zrinski, Čakovec.
- Milenković, S., Nikolić, M., Stamenković, S. (1998). Integralni koncept suzbijanja kruškine buve *Psylla pyri* L. Jugoslovensko voćarstvo, 32 (1/2):103-109.

- Pasqualini, E., Civolani, S., Grappadelli, C.L. (2002). Particle Film Technology: approach for a biorational control of *Cacopsylla pyri* (Rhynchotha Psyllidae) in Northern Italy. *Bulletin of Insectology* (1-2): 39-42.
- Pasqualini, E.; Civolani, S. & Corelli Grappadelli, L. (2003). Particle film technology: approach for a biorational control of *Cacopsylla pyri* (Rhynchotha: Psyllidae) in Northern Italy. *Bulletin of Insectology*, 55: 39-42
- Petrović-Obradović, O., Graora, D., Jerinić-Prodanović, D. (2007). Istraženost i značaj biljnih vašiju i lisnih buva u Srbiji. XIII Simpozijum sa savetovanjem o zaštiti bilja sa međunarodnim učešćem. Zbornik rezimea, 26.-30.11.2007. godina, Zlatibor.
- Souliotis, C., Broumas, T. (1998). Study of the population dynamics of the *Cycopsylla pyri* L (Homoptera: Psyllidae) and its predators in Eastern Attiki – *Annales de l Institut Phytopathologique Benaki*, 18 (2):97-109.
- Stratopoulou, E.T., Kapatou, E.T. (1995). The dynamics of the adult population of pear psylla, *Cacopsylla pyri* L. in the region of Magnesia (Greece). *Journal of Applied Entomology*, 119:97-101.
- Sanchez, J.A., Ortin-Angulo, C. M. (2011). Sampling of *Cacopsylla pyri* (Hemiptera: Psyllidae) and *Pilophorus gallicus* (Hemiptera: Miridae) in Pear Orchards. *Journal of Economic Entomology* 104 (5).

## DISTRIBUTION MAPPING OF SELECTED INVASIVE WEED SPECIES IN NORTH WESTERN AREA OF REPUBLIC OF SRPSKA (BOSNIA AND HERZEGOVINA)

Gordana BABIĆ\*, Vojislav TRKULJA

Public institution „Agricultural institute of Republic of Srpska, Banja Luka“, Bosnia and Herzegovina

\*Corresponding author: brkljacg@hotmail.com

### Abstract

Invasive weed species are characterized by rapid spread and successful establishment, occupying different habitats and thus potentially pose a threat to the biodiversity around the world. In recent years, a wide distribution of invasive weed species in north western area of Republic of Srpska (RS) caused irreparable and obviously damage across different habitat type. Considering problems such as their wide spreading and negative ecological, economic and social impact, studies in north western area of RS is addressed to selected invasive weed species. Among many, the most invasive is *Ambrosia artemisiifolia* L., threatening agricultural production and human health. However, a significance importance is placed on other invasive weed species, such as: *Asclepias syriaca* L., *Helianthus tuberosus* L. and *Fallopia japonica* (Hout.) Ronse Decr. Distribution and abundance parameters for selected invasive weed species were done for 62 stands based on Blanque Braun (1964) method and GIS software. Assessment of their occurrence and distribution was taken along the roads in the urban areas, between the settlements in ruderal and less arable land, on the edges of farmland, on arable land, along the rivers and fish pond, in ditches and on the edges of forests. Mapping of above mentioned weed species revealed a wide-spread distribution and renewal potential of selected weed species, thus presenting a real threat to native flora and different habitat type.

**Keywords:** *distribution, mapping, invasive weed species, Republic of Srpska.*

### Introduction

Numerous invasive alien species have become successfully established over large areas in Europe, thus having an increasing invasive potential (Pysek *and* Hulme 2005; Hulme, 2007 *loc. cit.* Lambdon *et al.*, 2008; Dumitraşcu *et al.*, 2010). The invasive weed species are characterized by rapid spread and successful establishment, occupying different habitats and thus potentially pose a threat to the biodiversity around the world. Thus, biological invasions have been recognized as being one of the main components of global change (Shea *and* Chesson, 2002) that affects populations, communities and even whole ecosystems (Richardson *et al.*, 2000). In recent years, a wide distribution of invasive weed species in north western area of Republic of Srpska caused irreparable and obviously damage across different habitat type. Considering problems such as their wide spreading and negative ecological, economic and social impact, studies in north western area of Republic of Srpska is addressed to selected invasive weed species.

Among many, ragweeds (*Ambrosia artemisiifolia* L.) present one of the most invasive weed species in our area (Trkulja *et al.*, 2012). However, a significance importance is placed on other invasive weed species, such as: common milkweed (*Asclepias syriaca* L.), Jerusalem artichoke (*Helianthus tuberosus* L.) and japanese knotweed (*Fallopia japonica* (Hout.) Ronse Decr.). Common milkweed is in past few years also in expansion and it is considered that in

the future could present a significant problem in ruderal as well as agricultural land (Trkulja *et al.*, 2011). According to Babic and Trkulja (2014), Japanese knotweed stand occurs in wet grassy lowland areas but is also found on hillsides, sunny sites in coastal areas, wetlands and riparian areas, but predominantly it is found near human settlement, along river banks and in waste areas in the north western part of RS. Also regarding to *H. tuberosus*, the most severe areas are in the river banks of Vrbanja and Sava, as well as areas along the fish pond between Prnjavor and Derventa (Babic and Trkulja, 2015).

### Material and method

The current research mainly focuses on the north western part of RS in relation to species habitat requirements and main environmental features. Field survey was conducted during the vegetation period in 2016. Assessment of the occurrence and distribution of invasive weed species were taken along the roads in the urban areas, between the settlements in ruderal and less arable land, and on the edges of farmland, on arable land, along the river Sava and Vrbanja, as well as along the fish pond, in ditches and on the edges of forests. Quantitative distribution, study species density measure was assessed based on Blanque Braun (1964) method. During fieldwork invasive weed species stands were mapped and recorded with GPS, while polygons were digitized using FITO GIS software.

#### Species habitat requirements

*Helianthus tuberosus* prefers certain habitat types (Fehér and Končėková, 2001). It is best adapted to rich, moist soil that can be found along roadways, in wasteland areas and gardens (Wyse *et al.*, 1986). According to Hartmann *et al.* (1995) *H. tuberosus* is completely naturalized on moist, nutrient-rich, sandy or loamy soils, especially along rivers. The most substantial site of occurrence includes riparian nitrophilic vegetation along watercourses, but also a variety of anthropogenic sites. In the landscape, it spreads very aggressively and settles more and more areas. It is contributed not only by spreading through generative diaspores, but also by vegetative propagation of broken-off parts of corms washed away by water to new sites along the watercourse (Cvachova *et al.*, 2002).

*Fallopia japonica* can usually tolerate a wide variety of environmental conditions ranging from high shade, high temperatures (even drought) to high salinity. In its native range, Japanese knotweed is a pioneer species on volcanic slopes and as invasive it invades disturbed habitats, tolerating a variety of soil structures and textures and pH levels, ranging from 3 to 8 (Pysek, 2006). It frequently occurs in riparian habitats (e.g. along river banks), but because of its invasive nature it also tolerates disturbed habitats, such as railroad tracks and roadsides (Forman and Kesseli, 2003). Other studies undertaken on *F. japonica* also revealed its preference for: boundary walls in farmlands, urban non-industrial land, ruderal habitats, meadows, natural/semi-natural forests, roadways etc. (Tiebre *et al.*, 2008). The species usually installs in open places, its growth and abundance being seriously affected by shading. The rhizomes are very resistant to low temperatures, thus permitting its survival in harsh climatic conditions (up to absolute minimum temperature of -30.2 C) (Barney *et al.*, 2006).

*Asclepias syriaca* invades soils due to insufficient cultivation and herbicide use, fertilizers and irrigation measures (Cramer and Burnside, 1981).

*Ambrosia artemisiifolia* grows best in warm and moist conditions (Deen *et al.*, 1998). However according to Trkulja *et al.* (2010) ragweed is present also in dry lands, but can develop in different soil type independently regarding to a quality of soil, and thus often could be seen in very poor or in soil with very bad or damage structure (pH level – 3). Same author stated that ragweed distribution goes to north up to 50 parallels, which why are south parts of

continent and Mediterranean are the most favourable areas for spreading this invasive weed species in Europe.

### Results and discussion

Distribution and mapping of selected invasive weed species was observed in the number of municipality of Republic of Srpska, in Banja Luka, Gradiška, Srbac, Vrbanja, Čelinac, Kotor Varoš, Prnjavor and Derventa between the above mentioned municipalities along the roads in populated areas, between settlements in ruderal and less arable land, on the edges of farmland and arable land, near the water sources, along the river Sava and Vrbanja, as well as along the fish pond, in ditches or even in the urban aeries (photo 1-4).



Photo 1. *A. syriaca* in wheat crop



Photo 2. *A. artemisiifolia* and *F. japonica* in urban area along the roads



Photo 3. *H. tuberosus* on river bank of Vrbanja in Čelinac



Photo 4. *H. tuberosus* along fish pond

During the research it is noticed that *H. tuberosus* behaves as an invasive weed species in the studied region. Frequent expansion of the species into the surrounding sites inner town, near agricultural lands and the cultivated field is also noticed, beside the expansion on the river bank of Vrbanja and Sava. The abundance of Jerusalem artichoke points to a high density of individuals e.g. up to 60-70/m<sup>2</sup> along the fish pond between Prnjavor and Derventa, as well on river bank of Vrbanja and Sava (up to 30-40/m<sup>2</sup>).

The abundance, estimated based on the number of steams, points to a high density of individuals of *F. japonica* on sq.m, e.g. up to 40-50 steams m<sup>-2</sup> in the Sava river flood plain as well between Srbac and Derventa along the roads in populated areas, in ruderal and less arable land, on the edges of farmland, and on the edges of forests.

In Banja Luka, Gradiška, Srbac, Vrbanja, Čelinac, Kotor Varoš, Prnjavor and Derventa a high density of *A. artemisiifolia* is determineted. It is present in different habitants and in different

communities. In some areas density of individuals was over  $70 \text{ m}^{-2}$ . The highest density is recorded along roads, as well in all type of crops, farmland and less arable lands, stubble fields especially etc. It is noticed that species is highly adjustable to different type of soil, and thus the only place that is not present are forest communities.

The lowest abundance was determinate in case of *A. syriaca*. A highest recorded density of individuals was up to  $28 \text{ m}^{-2}$  and mostly in wheat crops, less arable lands and along the roads between the urban areas, near the river Sava. Even the species is present and have the invasive potential, outside the wheat crops, and less arable lands, the highest density was no more than  $12 \text{ individuals m}^{-2}$ .

With current research 62 invasive weed species stand was recorded in the north western part of RS in 8 municipalities. Most of the stands are characterised by presence of two or more weed species together and all of them are recorded in different crops, such as orchards, wheat, corn etc. (Photo 5<sub>1-14</sub>).



5<sub>1</sub>



5<sub>2</sub>



5<sub>3</sub>



5<sub>4</sub>



5<sub>5</sub>



5<sub>6</sub>

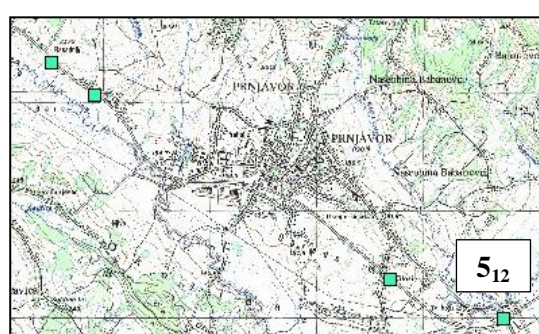
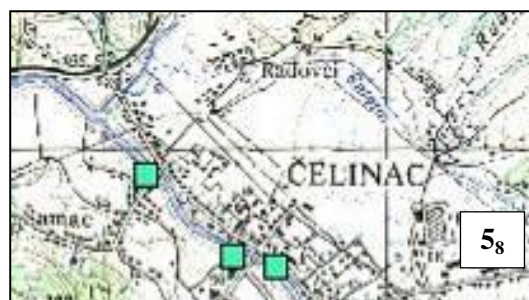
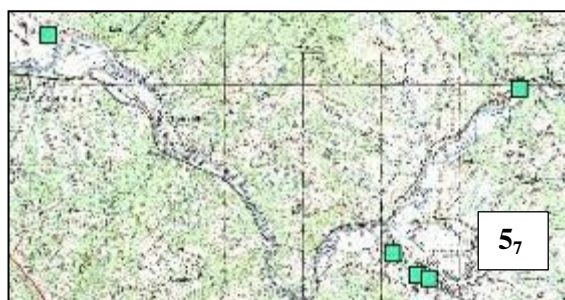


Photo 8<sub>1-14</sub>. Fito GIS distribution mapping of invasive weed species stand in the north western part of Republic of Srpska (along the roads in the urban areas, between the settlements in ruderal and less arable land, and on the edges of farmland, on arable land, along the river Sava and Vrbanja, as well as along the fish pond, in ditches and on the edges of forests).



## Conclusion

Mapping of invasive weed species revealed a wide-spread distribution of *A. artemisiifolia*, *H. tuberosus*, *F. japonica* and *A. syriaca*. As expected, the highest abundance is recorded in case of *A. artemisiifolia* ( $>70$  individuals  $m^{-2}$ ). However, very high abundance is recorded in case of *H. tuberosus* (60-70 individuals  $m^{-2}$ ), especially along the fish pond between Prnjavor and Derventa, as well on river bank of Vrbanja and Sava (up to 30-40  $m^{-2}$ ). Never the less a high density of individuals of *F. japonica* on sq.m was recorded e.g. up to 40-50 stems  $m^{-2}$  in the Sava river flood plain, as well between Srbac and Derventa. However in case of *A. syriaca* the recorded density of individuals was 12- 28  $m^{-2}$  and mostly in wheat crops, less arable lands and along the roads between the urban areas, near the river Sava.

Considering the above mentioned, as well the research in past, among many, the selected invasive weed species present a real threat to native flora and different habitat type in our area.

## References

- Cramer, G. L, Burnside, O. C, (1981). Control of common milkweed (*Asclepias syriaca*) with postemergence herbicides. *Weed. Sci.* 29, 636–640.
- Cvachová, A, Chromý, P, Gojdičová, E, Leskovjanská, A, Pietrová, E, Šimková, A, Zaliberová, M. (2002). *Průručka na určovanie vybraných invázných druhov rastlín*, ŠOP SR, Banská Bystrica, 62.
- Babic, G, Trkulja, V, (2014). Distribution mapping of *Fallopia japonica* (Hout.) Ronse Decr. in north western area of Republic of Srpska. Fifth International Scientific Agricultural Symposium Agrosym. Book of proceedings, 461–468.
- Babic, G, Trkulja, V. (2015). Occurrence and distribution mapping of invasive weed species *Helianthus tuberosus* L. in north western area of Republic of Srpska. Sixth International Scientific Agricultural Symposium Agrosym. Book of proceedings, 1248–1255.
- Barney, J. N, Tharayil, N, Di Tommaso, A, Bhowmik, P. C, (2006). La biologie des plantes exotiques envahissantes au Canada. 5. *Polygonum cuspidatum* Sieb. & Zucc. [= *Fallopia japonica* (Hout.) Ronse Decr.]. *Can. J. Plant Sci.* 86, 887–905.
- Deen, W, Hunt, L. A, Swanton, C. J, (1998). Photothermal time describes common ragweed (*Ambrosia artemisiifolia* L.) phenological development and growth. *Weed Science* 46, 561–568.
- Dumitrașcu, M, Grigorescu, I, Năstase, M, Dragotă, C. S, Kucsicsa, Gh, (2010). The main environmental driving forces of the invasive plant species in the Romanian protected areas. Proceedings of BALWOIS Conference on Water Observation and Information Systems for Decision Support, Ohrid, Macedonia (online).
- Braun, Blanque, J, (1964). *Pflanzensoziologie, Grundzüge der Vegetationskunde*, 3rd ed., Springer, Wien-New York, 865.
- Fehér, A, Končeková, L, (2001). Rozšírovanie invázneho druhu *Helianthus tuberosus* v pobrežných spoločenstvách rieky Nitry. *Bull. Czech Bot. Soc. (Praha)*, Mater. 18, 149–159.
- Forman, J, Kesseli, R, (2003). Sexual reproduction in the invasive species *Fallopia japonica* (Polygonaceae). *American Journal of Botany*, 90, 586–592.
- Hartmann, E, Schuldes, H, Kübler, R, Konold, W, (1995). *Neophyten. Biologie, Verbreitung und Kontrolle ausgewählter Arten*. ecomed, Landsberg.
- Lambdon, P. W, Pysek, P, Basnou, C, Arianoutsou, M, Essl, F, Hejda, M, Jarosik, V, Pergl, J, Winter, M, Anastasiu, P, (2008). Alien flora of Europe: species diversity, temporal trends, geographical patterns and research needs. *Preslia*, 80 (2), 101–149.

- Pysek, P, Hulme, P. E, (2005). Spatio-temporal dynamics of plant invasions: linking pattern to process. *Ecoscience*, 12, 302–315
- Pysek, P, (2006). *Fallopia japonica*. Delivering Alien Invasive Species Inventories for Europe (DAISIE), available from: [http://www.europe-aliens.org/pdf/Fallopia\\_japonica.pdf](http://www.europe-aliens.org/pdf/Fallopia_japonica.pdf)
- Richardson, D. M, Pyšek, P, Rejmánek, M, Barbour, M. G, Panetta F. D., West C. J, (2000). Naturalization and invasion of alien plants: concepts and definitions. *Divers. Distrib.*, 6, 93–107.
- Shea, K, Chesson, P, (2002). Community ecology theory as a framework for biological invasion. *Trends Ecol. Evol.*, 17, 170–176.
- Tiébré, M. S, Saa, L, Mahy, G, (2008). Landscape dynamics and habitat selection by the alien invasive *Fallopia* (Polygonaceae) in Belgium, *Biodiversity Conservation*, 17, 2357–2370.
- Trkulja, V, Babić, G, Rajčević, B, Mihić Salapura, J, Kovačić, D, Simić, J, Vuković, S, (2012). Seasonal Analysis of aeroallergenic ragweed pollen in the area Banja Lukaduring 2007-2011. The first International Congress of Ecologists. Proceedings: University of Business Studies, Banja Luka, *Ecological Spectrum*, 1, 1029–1038.
- Trkulja, V, Babić, G, Rajčević, B (2011). Najznačajnije invazivne korovske vrtse na području republike Srpske. VIII Simpozijum o zaštiti bilja u Bosni i Hercegovini, Teslić, 61–63.
- Trkulja, V, Ostojic, I, Skrbic, R, Herveg, N, Petrovic, D, Kovacevic, Z, (2010). *Ambrozija*. Društvo za zastitu bilja u Bosni i Hercegovini, Banja Luka, ISBN: 978-9958-9093-1-3.
- Wyse, D. L, Young, F. L, Jones, R. J, (1986). Influence of jerusalem artichoke (*Helianthus tuberosus*) density and duration of interference on soybean (*Glycine max*) growth and yield. *Weed Science*, 34 (2), 243–247.

## HERBICIDE EFFICIENCY TESTING IN SOYBEAN DURING 2014–2016

Gordana BABIĆ\*, Bojana ČURKOVIĆ, Vojislav TRKULJA, Miloš NOŽINIĆ,  
Vesna BOJIĆ, Drago SPREMO

Public Institution „Agricultural Institute of Republic of Srpska, Banja Luka“, Bosnia and Herzegovina

\*Corresponding author: brkljacg@hotmail.com

### Abstract

Weed species present a significant limiting factor in soybean production. Their competitiveness is more evident in drier years, often resulting in an unfavorable harvest, increased grain moisture and decreased quality and yield of soybean. Thus, a special emphasis is placed on effective weed management programs. Within a cooperative Danube-Soya Program, Public Institution „Agriculture Institute of Republic of Srpska, Banja Luka“ (PI AIRS, BL) from Bosnia and Herzegovina has taken an active role in the effective weed management programs in the production of non-genetically modified soybean. Total 19 herbicide combinations on weed populations in soybean in the Banja Luka region were tested during three-year period. Efficiency test of 5 herbicide combinations during 2014, 6 herbicide combinations during 2015 and 8 herbicide combinations during 2016 was carried out on the experimental fields of PI AIRS, Banja Luka. In 2014, heavy rainfall caused constant emergence of weed species throughout the vegetation period of soybean, resulting in satisfactory efficiency of applied pre. em. herbicide combinations with corrective treatments. High efficiency was only achieved by herbicides applied after sowing and before emergence of soybean with corrective treatment. In 2015, high efficiency was achieved by herbicide applied after sowing and before emergence of soybean with a corrective treatment, while satisfactory efficiency was achieved with post. em. herbicide combinations. In 2016, pre. em. herbicide combinations with corrective treatments achieved high efficiency.

**Keywords:** *herbicide efficiency, soybean, Danube-Soya Program.*

### Introduction

A wide range of broad leaves weed dominate in soybean, and thus present the limiting factor in production. Heavy weed competition is especially important in the early growth stages and considering that fact, pre-emergence herbicide application can be helpful in controlling weeds, but to some extent. Actually, crop-weed competition is minimized by pre-emergence herbicide spray, hence weeds in the early growth stages are more concurrent to a young plant of soybean considering the needs for water, nutrition and if they are robust for light (Hrustić *et al.*, 2004.). Their competitiveness is more evident in drier years, often resulting in an unfavorable harvest, increased grain moisture and decreased quality and yield of soybean. Not only that they decrease yield, make harvest more difficult, reduce the quality of grain and increase the humidity, but also transmit a variety of diseases and pests. According to Öerke *et al.* (1994) grain yield can be reduced in average 13% or 10% (Maceljki, 1995). Thus a special emphasis is placed on effective weed management programs.

In order to strengthen the competitiveness of the EU market in relation to GMO soy producers, but also to intensify production on domestic manufacturers Public Institution „Agriculture Institute of Republic of Srpska, Banja Luka“ (PI AIRS, BL) took an active role in cooperative Program Danube Soya from 2014. Therefore, to ensure high quality and yield

of non-GMO soybean the basic aim of this study was to investigate the efficacy of 19 different herbicides on weed populations in soybean in the Banja Luka area.

### Material and method

The herbicide trial was conducted in the experimental field of the PI AIRS, BL according to the European and Mediterranean Plant Protection Organization guidelines (OEPP/EPPO, 1998; OEPP/EPPO, 1999; OEPP/EPPO, 2012). In 2014 herbicide efficiency trial was set up on 14th April in randomized block design, with elementary plots of 60 m<sup>2</sup> in 3 repetition, locality Maglajani. Weed control included one treatment before sowing and immediately after planting (pre.em.), while four others combinations were applied pre. em. (Table 1).

Table 1. Technical data and variants of applied herbicides in soybean during 2014 in Maglajani

Herbicide variant	Active substances	Time of applications/date	Concentration/Unit
Zanat + Lord + Galolin mono	Pendimethalin +Metribuzin +Linuron	pre. sowing and pre. em	4 L ha <sup>-1</sup> +0,5 kg ha <sup>-1</sup> +1,5 L ha <sup>-1</sup>
Galolin mono +Lord	Linuron +Metribuzin	pre. em	2,5 L ha <sup>-1</sup> +0,5 kg ha <sup>-1</sup>
Galolin mono + Lord	Linuron +Metribuzin	pre. em	2 L ha <sup>-1</sup> +0,75 kg ha <sup>-1</sup>
Frontier 900 EC +Lord	Dimethenamid-P +Metribuzin	pre. em	1 L ha <sup>-1</sup> +0,75 kg ha <sup>-1</sup>
Lord + Dual gold 960 EC	Metribuzin +S-metolachlor	pre. em	0,75 kg ha <sup>-1</sup> +1,2 L ha <sup>-1</sup>
Untreated variant			n/a

The basic plots were divided into two equal areas and on each were performed corrective treatments (Table 2).

Table 2. Technical details and variants of corrective treatments in soybean during 2014 in Maglajani

Herbicide variant	Active substances	Time of applications/date	Concentration/Unit
Fusilade forte +Pulsar 40	Fluazifop-P-butyl +Imazamox	post. em.	2 L ha <sup>-1</sup> +1,2 L ha <sup>-1</sup>
Dynox +Harmony DF	Oxasulfuron +Thifensulfuron methyl	post. em.	80 g/ha +10 g/ha

The herbicide efficiency trial conducted in 2015 with six herbicide combinations (4 pre. em. and 2 post.em.) was placed on the experimental field of PI AIRS, Banja Luka (Kalino Imanje), with elementary plots of 115 m<sup>2</sup> in 3 repetition (table 3).

Table 3. Technical data and variants of applied herbicides in soybean during 2015 in Kalino imanje

Herbicide variant	Active substances	Time of applications/date	Concentration/Unit
Zanat + Lord + Dual gold 960 EC	Pendimethalin +Metribuzin +S-metolachlor	pre. em	4 L ha <sup>-1</sup> +1 kg ha <sup>-1</sup> +1,2 L ha <sup>-1</sup>
Galolin mono + Lord	Linuron +Metribuzin	pre. em	2 L ha <sup>-1</sup> +0,75 kg ha <sup>-1</sup>
Lord +Dual gold 960 EC	Metribuzin +S-metolachlor	pre. em	0,75 kg ha <sup>-1</sup> +1,2 L ha <sup>-1</sup>
Lord + Dual gold 960 EC	Metribuzin +S-metolachlor	pre. em	0,75 kg ha <sup>-1</sup> +1 L ha <sup>-1</sup>
Pulsar 40	Imazamox	pre. em	1,2 L ha <sup>-1</sup>
Dynox +Okvir	Oxasulfuron +Thifensulfuro methyl	post. em.	80 g/ha +10 g/ha
Untreated variant			n/a

The basic pre. em. plots were divided in to two equal areas and on each were performed corrective treatments (table 4).

Table 4. Technical details and variants of corrective treatmens in soy during 2015 in locality Kalino imanje

Herbicide variant	Active substances	Time of applications/date	Concentration/Unit
Pulsar 40	Imazamox	post. em.	1,2 L ha <sup>-1</sup>
Dynox +Okvir	Oxasulfuron +Thifensulfuron-methyl	post. em.	80 g/ha +10 g/ha

The herbicide efficiancy trail conducted in 2016 with eight herbicide combinations (5 pre. em. and 3 post.em.) was placed on the experimental field of PI AIRS, Banja Luka (Kalino Imanje), with elementary plots of 80 m<sup>2</sup> in 3 repetition (table 5).

Table 5. Technical data and variants of applied herbicides in soybean during 2016 in Kalino imanje

Herbicide variant	Active substances	Time of applications/date	Concentration/Unit
Sencor WG 70 + Dual gold 960 EC	+Metribuzin +S-metolachlor	pre. em	0,75 kg ha <sup>-1</sup> +1,2 L ha <sup>-1</sup>
Sencor WG 70 + Dual gold 960 EC	+Metribuzin +S-metolachlor	pre. em	1 kg ha <sup>-1</sup> +1,2 L ha <sup>-1</sup>
Sencor WG 70 + Frontier 900 EC	+Metribuzin + dimetenamid-P	pre. em	1 kg ha <sup>-1</sup> +1 L ha <sup>-1</sup>
Wing ® P	Pendimethalin	pre. em	4 L ha <sup>-1</sup>
Wing ® P + Sencor WG 70	Pendimethalin + Metribuzin	pre. em	3,5 L ha <sup>-1</sup> +300 g/ha
Dynox	Oxasulfuron	post. em.	80 g/ha

+Okvir	+Thifensulfuro methyl		+8 g/ha
Corum ®	Imazamox	post. em.	0,9 L ha <sup>-1</sup>
Corum ® + Basagran	Imazamox + Bentazon	post. em.	0,9 L ha <sup>-1</sup> + 0,5 L ha <sup>-1</sup>
Untreated variant			n/a

The basic pre. em. plots were divided in to tree equal areas and on each were performed corrective treatments (table 6).

Table 6. Technical details and variants of corrective treatments in soy during 2016 in locality Kalino imanje

Herbicide variant	Active substances	Time of applications/date	Concentration/Unit
Corum ®	Imazamox	post. em.	0,9 L ha <sup>-1</sup>
Corum ® + Basagran	Imazamox + Bentazon	post. em.	0,9 L ha <sup>-1</sup> + 0,5 L ha <sup>-1</sup>
Dynox +Okvir	Oxasulfuron +Thifensulfuron-methyl	post. em.	80 g/ha +8 g/ha

The weed population of each herbicide trail plot and untreated control was recorded in terms of numbers with absolute assessment. In terms of absolute assessment individual plants were counted for each weed species. These assessments were made on randomly selected marked quadrats in each plot. Based on the obtained data, the coefficient of efficiency  $C_e$  (%) of herbicides is calculated by the formula Dodel *loc. cit.* Janjić (1985) and represents a relative ratio between the number of destroyed weeds compared to the weeds number in the control.

### Results and discussion

In 2014 during the evaluations of the herbicide variants efficiency revealed the presence of 11 weed species. Target organisms were *Agropyron repens*, *Amaranthus retroflexus*, *Ambrosia artemisifolia* L., *Cirsium arvense* (L.) Scop., *Convolvulus arvensis* L., *Hibiscus trionum* L., *Matricaria chamomilla* L., *Polygonum aviculare* L., *Setaria* sp., *Sorghum halepense* (L.) Pers. and *Viola* sp. The total number of weed population in control plots (photo 1) ranged from 109.3-162.4 plants/m<sup>2</sup>, and among them the most dominant (63-75 plants/m<sup>2</sup>) was *A.artemisifolia*, which was to be expected given that it is the most invasive weed species in our area. The high efficiency of 92.82% was achieved in the variant applied after sowing and before emergence of soybean (Galolin mono + Lord) at a dose of 2.5 l/ha + 0,5 kg/ha with a corrective treatment (photo 2), while satisfactory efficiency (>80%) was achieved by applying of all other combinations (table 7).

Table 7. Efficiency of different weed control treatments in soybean in 2014

Herbicide variant	Ce %
Zanat + Lord+ Galolin mono + post.em. variant	84,17
Galolin mono + Lord + post.em. variant	92,82
Galolin mono + Lord+post.em. variant	88,59
Frontier 900 EC + Lord + post.em. variant	87,25
Lord +Dual gold 960 EC + post.em. variant	86,37

During 2015 the evaluations of the herbicide variants efficiency revealed the presence of 9 weed species. Target organisms were *Ambrosia artemisifolia* L., *Chenopodium album* L.,

*Cirsium arvense* (L.) Scop., *Convolvulus arvensis* L., *Hibiscus trionum* L., *Polygonum aviculare* L., *Setaria* sp., *Sorghum halepense* (L.) Pers. and *Xanthium strumarium* L.

The total number of weed population in control plots (photo 3) ranged from 125.3-173.4 plants m<sup>-2</sup> and among them, as in previous year, the dominant species (69-92 plants m<sup>-2</sup>) was *A. artemisiifolia*. High efficiency (>90%) was achieved in the variant applied after sowing and before emergence of soybeans with a corrective treatment, one of which is a variant Galolin mono + Lord achieved the highest efficiency (94.82%) (photo 4), while satisfactory efficiency (>80%) was achieved by applying both post. em. combinations (Table 8).

Table 8. Efficiency of different weed control treatments in soybean in 2015

Herbicide variant	Ce %
Zanat + Lord+ Galolin mono + post.em. variant	90,42
Galolin mono + Lord + post.em. variant	94,82
Lord+Dual gold 960 EC+ post.em. variant	91,36
Lord+Dual gold 960 EC+ post.em. variant	91,06
Pulsar 40	86,35
Dynox+Okvir	86,43

In 2016 during the evaluations of the herbicide variants efficiency revealed the presence of 10 weed species. Among target organisms 7 was annual: *Ambrosia artemisiifolia* L., *Chenopodium album* L., *Echinochloa crus-galli* (L.) Beauv, *Hibiscus trionum* L., *Polygonum aviculare* L., *Setaria* sp. and *Xanthium strumarium* L., and 3 was perial: *Cirsium arvense* (L.) Scop., *Sorghum halepense* (L.) Pers. and *Convolvulus arvensis* L.

The total number of weed population in control plots (photo 5) ranged from 126.7-187.1 plants m<sup>-2</sup> and among them, as in previous years, the dominant species (52-64 plants m<sup>-2</sup>) was *A. artemisiifolia*. High efficiency (>90%) was achieved in the variant applied after sowing and before emergence of soybeans with a corrective treatment. However, one of them achieved satisfactory efficiency (>80%). The highest efficiency was achieved with variant Sencor WG 70 + Dual gold 960 EC (92.89%) applied at rate 1 kg ha<sup>-1</sup>/ha+1,2 L ha<sup>-1</sup> (photo 6). In case of post. em. combinations, as in previous years, satisfactory efficiency (>80%) was achieved (Table 9).

Table 9. Efficiency of different weed control treatments in soybean in 2016

Herbicide variant	Ce %
Sencor WG 70 + Dual gold 960 EC + post.em. variant	91.13
Sencor WG 70 + Dual gold 960 EC + post.em. variant	92.89
Sencor WG 70+ Frontier 900 EC+ post.em. variant	90.98
Wing ® P + post.em. variant	89.50
Wing ® P + Sencor WG 70+ post.em. variant	91.06
Dynox+Okvir	86.43
Corum ®	89.50
Corum ® + Basagran	86.43



Photo 1. Control untreated plots in 2014



Photo 2. Variant Galolin mono + Lord in 2014



Photo 3. Control untreated plots in 2015



Photo 4. Variant Galolin mono + Lord in 2015



Photo 5. Control untreated plots in 2016



Photo 6. Variant Sencor WG 70 + Dual gold 960 EC

### Conclusion

During 2014, heavy rainfall caused the emergence of broad-leaves and grassy weed species in a longer period or from the deeper layers of the soil during the entire vegetation period of the soybeans. Thus pre.em. combination with corrective treatments achieved satisfactory efficiency. Compared with the previous year, in 2015, pre.em. combination with corrective treatments showed high efficiency, as in 2016.

Hence the study showed that post. em. combination achieved satisfactory efficiency (75-90%) in every year of testing, this point out the importance of appropriate and timely protection against weeds for agricultural producers as well as significant role in the selection of the most effective combination in the production of non-GMO soybeans in our area.



### **References**

- Hrustić, M, Vidić, M, Miladinović, J, (2004). Soja i stres / Soy and stress/. Naučni institut za ratarstvo i povrtlarstvo Novi Sad, Zbornik radova, 40, 217–225.
- Janjić, V, (1985). Herbicidi /Herbicides/, Naučna knjiga, Beograd.
- Maceljiski, M, (1995). Štete od štetočina u Hrvatskoj / Damage from pests in Croatia/. Glasnik zaštite bilja, 6, 261–265, Zagreb.
- OEPP/EPPO (1998). Guideline for the efficacy evaluation of herbicides. EPPO Standards for the efficacy evaluation of plant protection products. Herbicides and Plant Growth Regulators, 4, 29–32.
- OEPP/EPPO (1999). Guideline for the efficacy evaluation of plant protection products, phytotoxicity assessment, introduction, general and miscellaneous guidelines. New and Revised Gudeilines 135 (1), 31–36.
- OEPP/EPPO (2012). Guideline for the efficacy evaluation of plant protection products 152, Design and analysis of efficacy evaluation trials, 42 (3), 367–381.
- Öerke, E. C, Dehne, H. V, Schöbeck, F, Weber, A, (1994). Crop production and crop protection- estimated losses in major food and cas crops, ECPA, Hamburg.

## WHITE CHEESE PHYSICOCHEMICAL PROPERTIES MADE OF INFRA RED PASTEURIZED MILK AND AGED IN POTASSIUM CHLORIDE (KCL) SUBSTITUTED BRINE

Simin HAGH NAZARI\*<sup>1</sup>, Mohammad Reza AZIMI<sup>2</sup>, Sajjad VALINEZHAD<sup>1</sup>

<sup>1</sup>Department of Food Science and Technology, Agriculture Faculty, University of Zanjan, Zanjan, Iran

<sup>2</sup>Cultivation Department, Agriculture Faculty, University of Zanjan, Zanjan, Iran

\*Corresponding author:haghnazari.simin@znu.ac.ir

### Abstract

Using infrared irradiation heat for milk pasteurization as a technology with the high thermal efficiency can be a good alternative to traditional methods of milk processing. In addition by replacing potassium chloride instead of sodium chloride in the formula of the salt water of white cheese, the adverse health effects resulting from the consumption of sodium chloride can be prevented. In this study, by using the infrared radiation heat, raw cow milk prepared of Zanjan University animal husbandry was pasteurized and white cheese produced in 2016. The white cheese was placed in four different formulations of brine containing 1) NaCl: KCl, 10:0 percent 2) NaCl: KCl, 7.5: 2.5 percent, 3) NaCl: KCl, 5:5 percent and 4) NaCl: KCl, 0:10 percent for 21 days at a temperature of 8° C. Then the physicochemical characteristics of the cheeses were evaluated. Cheeses produced using two pasteurization methods of classic and infrared irradiation had significant differences in moisture and dry matter content. However, the coliform, yeast and mold counts had not significant difference.

**Key Words:** *NaCl, KCl, White Cheese, Brine, Infrared pasteurizing*

### Introduction

Cheese contains less water than milk, and so has different organoleptic properties and shelf life than milk (Walstra et al., 2006). Cheese is a rich source of protein, fat, calcium, phosphorus, riboflavin and other vitamins. Also it can be more useful than milk in high protein diets, also its proteins are highly digestible (Renner, 1993).

Traditional production of white cheese in brine has been popular for centuries in small-scale cow keeping farms. Along with the recent developments in dairy product processing industry and with the integration of mechanization and automation, large-scale production of cheese became possible (Ozer, 2014).

Salting is an important stage in the process of cheese. History of salt used as an additive is related to 3,000 years before Christ (Woodin, 1981; Durack et al., 2008). Salt is considered as an additive commonly used in the food industry and plays a vital role in the food processing including food protection, helping to improve the flavor, the impact on proteolysis, water activity and strength in the tissue (Reddy and Marth, 1991; Guinee, 2004a; Guinee and Fox, 2004). Salt provides about 90 percent of the sodium in the human diet (He et al., 2012). In the structure of the salt, the sodium intake is very important to control the membrane potential of the cell and absorption of nutrients in the small intestine. In order to maintain the blood volume, osmotic pressure on the cell and also transportation of nervous signals, sodium is essential (Strazzullo et al., 2009; He and MacGregor, 2010).

Although salt plays an important role during food processing, but has been known to be a major risk for diseases such as osteoporosis due to urinary excretion of calcium chloride, kidney stones and high blood pressure (Beumi et al., 2002; Kotchen, 2005 ; Massey, 2005;

Heaney, 2006). World Health Organization has recommend food manufacturers to reduce the use of salt (WHO, 2007). Meat, dairy, bakery and other food products, each include a different percentages of sodium uptake by the body in different classes in the world for example, the daily intake of sodium through cheese in England, France, America and Australia, have been reported 7.8, 9.2, 8.2 and 5% namely (Meneton et al., 2009; Anderson et al. , 2010). So many efforts have been made for producing of low-salt cheese using different techniques such as reducing the amount of salt or partial replacement of salt in cheese with other materials (Guinee and O'Kennedy, 2007). Reducing the salt content of the Cheddar cheese and the effects of these changes on the chemical composition, proteolysis, and sensory properties were done by Schroeder and colleagues (1988b). Replacing salt with other materials such as potassium chloride, calcium chloride and magnesium chloride may be considered as a successful strategy to reduce the amount of salt (Kilcast and den Ridder, 2007).

Also partial replacement of sodium chloride with potassium chloride revealed that the quality of the cheese has not significantly changed (Guinee, 2004b). Potassium chloride salt is acknowledged as a potential alternative to sodium chloride in cheese making. Increasing potassium intake has been reported as a protection factor for people with hypertension (Fregly, 1981; Reddy and Marth, 1991). A mixture of potassium chloride and sodium chloride has been successfully used in cheese production and no adverse effects have been reported on the quality of the cheese (Fitzgerald and Buckley, 1985). Several studies have been also made on the effect of replacing sodium chloride with potassium chloride on the properties of Cheddar (Reddy and Marth, 1993a), feta cheese (Katsiari, et al., 1997; 2000a), Kefalograviera cheese (Katsiari et al., 2001a), and Fynbo cheese (Zorrilla and Rubiolo, 1994; Zorrilla et al., 1996), but there is not any investigation on white cheese made of IR pasteurized milk and aged in KCl substituted brine.

Infrared heating is an alternative preservation method with higher thermal efficiency which transfers thermal energy in the form of electromagnetic waves. Recent applications of infrared heating indicate this technology is a viable alternate for the pasteurization of liquid foods, in addition it can decontaminate foodstuffs in both liquid and solid foods with retaining higher levels of health promoting compounds (Hagh Nazari. 2014).

The aim of this research is to study the effects of replacement of NaCl with KCl salt on the physico-chemical properties of ripened white brined cheese made from pasteurized milk using infrared irradiation.

### **Materials and Methods**

Cheese making method: for the preparation of cheese, raw milk from the dairy farm of Zanjan University was prepared. Raw milk was pasteurized using flavor wave Turbo device that emits infrared waves at 72 ° C for 15 seconds has shown in figure 1. The temperature of the process was checked by a digital thermometer model TES made in China. For comparing and evaluating the effects of the pasteurization methods, the milk was also pasteurized using classic (conventional) methods. After pasteurization of milk, 200 ml of milk was poured in lidded plastic containers of the same shapes in 3 replicates equaled 24 samples.

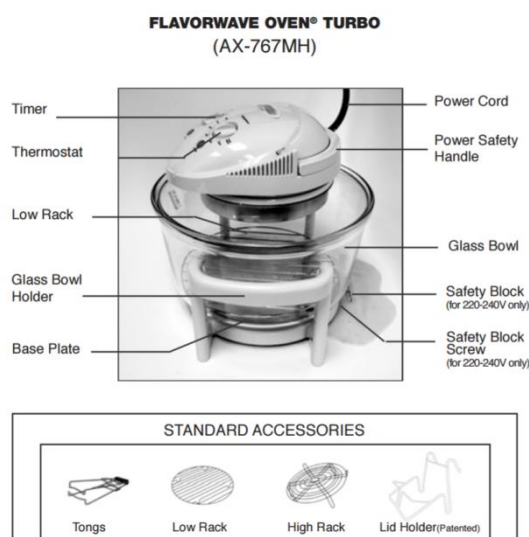


Figure 1: flavor wave Turbo device

After the milk temperature reached to 35 ° C; the kefir starter solution to the volume of 2 ml along with calcium chloride to the amount of 0.02% of the milk were added to the pasteurized milk. The samples were transferred to an incubator made in Memmert Company in Germany at 35°C. And 20 minutes after adding the starter, the fungal rennet Valiren made in America was added to the amount of 0.0025 gr to each container at 35°C.

After clot formation, clots were left without cutting for 12 hours in 18°C to continue fermentation, coagulating and dewatering. The resulting clots were transferred to salt solutions containing: 1) NaCl: KCl, 10:0 percent 2) NaCl: KCl, 7.5: 2.5 percent, 3) NaCl: KCl, 5:5 percent and 4) NaCl: KCl, 0:10 percent for 21 days at a temperature of 8° C. After ripening, physic-chemical tests was conducted on the cheese.

Chemical tests: measurement of chemical compounds was conducted by AOAC methods (AOAC, 2012). Moisture, fat and protein contents were measured using the oven at 102 degrees Celsius, Gerber method, and Kjeldahl method respectively. PH was measured by Professional portable milk pH Meter HI98162 provided by Hanna Company.

Statistical analysis: factorial experiments were conducted in a completely randomized design with three replications. The statistical comparison was done using the Mstat-C software via Duncan's method.

## Results and discussion

### Chemical analyses:

Chemical assessments on raw milk and pasteurized milk using classic method and infrared irradiation are reported in Table 1.

Table 1. Chemical assessments on raw milk and pasteurized milk using classical method and infrared irradiation.

Analysis	Raw Milk	Classic Pasteurized Milk	IR Pasteurized Milk
pH	0.005 ± 6.6866	0.005 ± 6.68	0.005 ± 6.6866
Density	0.0005 ± 1.02867	0.0005 ± 1.02866	0.0004 ± 1.02822
Acidity	0.001 ± 0.1463	0.0015 ± 0.1476	0.0005 ± 0.1476
Fat	0.0082 ± 3.66	0.0032 ± 3.649	0.0074 ± 3.6606
Protein	0.0066 ± 3.2166	0.007 ± 3.2096	0.0065 ± 3.214
Lactose	0.00821 ± 4.8611	4.8483 ± 0.006	0.01 ± 4.8542
Nonfat Dry Mass	0.00356 ± 8.4797	0.0023 ± 8.473	0.001 ± 8.4793
Calcium	0.0002 ± 0.122	0.0033 ± 0.120	0.0004 ± 0.122

The comparison of data means resulting from the analysis of the cheese characteristics show that the cheeses made from two types of pasteurized milk and different brine formulations only differ in the amount of moisture and dry matter content and there is no significant difference between them. The impact of the brine formulation on the pH of the cheeses: PH of cheeses began to decreasing during preparation and aging in brine formulations and finally reached to 4.02 from 5.3 in beginning stage o aging. Figure 2 shows the pH of ripened cheeses in various ratios of brine and different milk pasteurization methods.

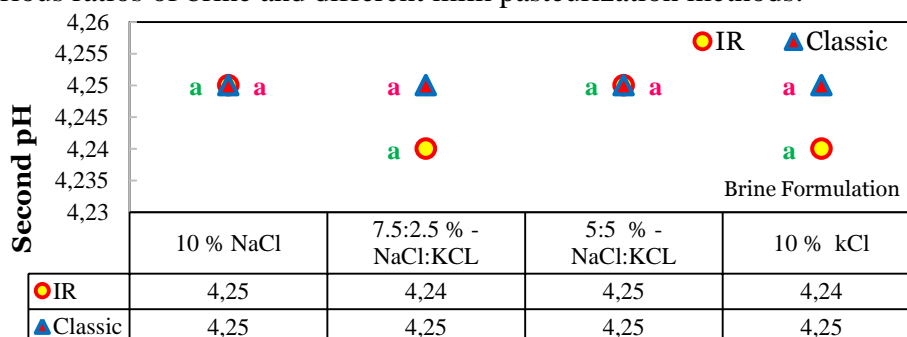


Figure 2: Comparison of the pH of ripened cheeses in various ratios of brine and different milk pasteurization methods

✚ Comparison of cheese samples appearance:

The comparison of the clots formed from pasteurized milk using infrared radiation (1) and Classic method (2) at 72° C for 15 seconds is shown in Figure 5.

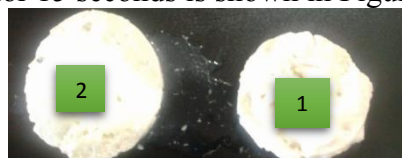


Figure 5: comparison of the clots formed from pasteurized milk using infrared radiation (1) and Classic method (2) at 72° C for 15 seconds.

The comparison of the clots formed from pasteurized milk using infrared radiation (1) and Classic method (2) shows that the volume of the Infrared irradiated samples are smaller with higher coherence and solidity.

#### **✚ The organoleptic analysis of cheeses**

The color, flavor and tastes of the cheeses (the organoleptic results) examined by taste panel showed that there is no significant difference between samples.

#### **✚ The use of potassium chloride in the formula of the cheese brine:**

The reason of the replacement of sodium chloride with potassium chloride, is achieving a product that reduces harmful effects to health caused by the consumption of sodium chloride. In addition to the fact that the product is supposed to be acceptable in terms of evaluated properties. The results of the analysis showed that the only difference between white cheeses produced in different brine formulas is in their firmness. Reduced sodium salt cheese is very soft, bitter, less salty, and has a strong off-flavor and shorter shelf life (Ying Lu, 2012). Potassium chloride (KCl) has a similar structure and salty flavor as sodium chloride (salt) and partial replacement of salt with potassium chloride can be used to lower salt content in foods. Moreover, potassium can lower the blood pressure and the risk of heart disease or stroke. Thus, potassium chloride is a potential substitution for salt in cheese.

#### **✚ Effects of brine formula on:**

**Cheese pH:** At the beginning of ripening period of the cheese samples, the production of lactic acid from lactose reduces the pH and increases the acidity by Lactic Acid Bacteria. With improvement of the cheese ripening, the reduction of lactose continues and lactic acid inhibitory effect begins on the activity of some lactic strains. So, the production of lactic acid is reduced and consequently, the testable acidity remains constant.

Comparing the results of pH shows that differences in the pH in ripened cheese made from pasteurized milk with the two methods is not significant. PH difference between different formulations of salt water is not significant in ripened cheese.

The similar results obtained by Lindsay in 1982, Aly Katsiari in 1985 and in 1998, 2000 and 2001 for cheddar and feta cheeses. The researchers also attributed the reason of the lactic acid produced from lactose causing the initial reduction of pH, while the advancement of proteolysis and lipolysis results an increase in the amount of amino acids and fatty acids during the ripening period induces to final pH decrease.

The researchers also reported that the initial pH of the cheese is specified according to the pasteurization method, the type of milk used to make cheese, the microbial load of the raw milk and the starter culture type. While the pH of the ripened cheese is specified according to the ripening temperature, period length and the type of rennet used (Lindsay, 1982; Aly, 1985; Katsiari et al., 1998, 2000, 2001). Partial replacement of sodium chloride with potassium chloride with different levels of substitution (10:00 percent sodium chloride - potassium chloride, 7.5:2.5% sodium chloride - potassium chloride, 5:5 % sodium chloride - potassium chloride and 10:00 percent potassium chloride - NaCl) had no significant effect on pH values. These results are similar to findings of Katsiari in 1998, 2000 and 2001. This researcher replaced (3% sodium chloride, 1.5:1.5 percent sodium chloride - potassium chloride and 3% potassium chloride) on Kefalograviera cheese and observed no significant change in the pH of the cheese. (Katsiari et al., 1998, 2000, 2001).

#### **✚ The chemical properties of cheese**

In examining the impact of different levels of sodium and potassium chloride on cheese chemical properties (including the amount of fat and protein) by infrared or classic method for pasteurization; it became clear that replacement of sodium chloride with potassium chloride in brine have both no significant effect on the fat and protein of the produced cheeses (based on dry weight). Results of the studies of Lindsay in 1982, Aly Katsiari in 1985, 1998, 2000 and 2001 also showed similar results. In addition in 1998 and 2000,

Katsiari pointed out that the changes in the amount of fat, protein and other compounds of cheese occurred by the lipolysis, proteolysis, lactic acid production and other reactions happened during the ripening period not due to brine formula. Although added calcium chloride can effect on cheese density and volume of cheese due to participating in paracaseinate calcium clots which induce the syneresis reaction improve (Fuca, 2012).

#### **✚ The effect of infrared radiation in cheese production**

Examining properties of the produced cheeses showed no significant difference between the cheeses produced from pasteurized milk using the infrared and classic methods but due to the high heat performance in the infrared radiation, the pasteurization process of milk is approximately 75% faster than the classic method. It is considered a more suitable method for pasteurization of milk compared to the classic method especially due to the heat shock effect on microbial cellular structure. All above studies confirms this project's results due to the higher efficiency and saving energy consumption via IR assisted systems in comparison of classic method of pasteurization.

### **Conclusion**

In general, from this study it can be concluded that changing the formulation of the used brine has no effects on cheese properties.

Effects of brine formula on Cheese pH shows that differences in the pH in ripened cheese made from pasteurized milk comparing with the two methods is not significant.

Effects of brine formula on the chemical properties of cheese shows replacement of sodium chloride with potassium chloride in brine have both no significant effect on the fat and protein of the produced cheeses (based on dry weight).

### **References**

- Aly M. E. (1995). An attempt for producing low-sodium Feta type cheese. *Food Chem.* 52: 295-299.
- Anderson, C. A., Appel, L. J., Okuda, N., Brown, I. J., Chan, Q., Zhao, L., Ueshima, H., Kesteloot, H., Miura, K., Curb, J. D., Yoshita, K., Elliott, P., Yamamoto, M. E., Stamler, J. (2010). Dietary sources of sodium in China, Japan, the United Kingdom, and the United States, women and men aged 40 to 59 years: the INTERMAP study, *J. Am. Diet. Assoc.* 110: 736–745.
- Ayyash, M.M, Sherkat, F., Francis, P. Williams R.P. W. Shah N.P. (2011). The effect of sodium chloride substitution with potassium chloride on texture profile and microstructure of Halloumi cheese. Volume 94, Issue 1, Pages 37–42.
- AOAC. (1995). *Official Methods of Analysis*. AOAC International, Arlington, VA.
- Buemi, M., Senatore, M., Corica, F., Aloisi, C., Romeo, A., Tramontana, D., et al. (2002). Diet and arterial hypertension: Is the sodium ion alone important. *Medicinal Research Reviews*, 22(4): 419–428.
- Binkerd, E. F., and Kolari, O. E. (1975). The history and use of nitrate and nitrite in the curing of the meat. *Food Cosmet. Toxicol*, 13: 655-661.
- Durack, E., Alonso-Gomez, M., and Wilkinson, M. G. (2008). Salt: A review of its role in food science and public health. *Current Nutrition and Food Science*, 4: 290 - 297.
- Fitzgerald, E. and Buckley, J. (1985). Effect of total and partial substitution of sodium chloride on the quality of Cheddar cheese. *Journal of Dairy Science*, 68:3127-3134.
- Fregly, M. J. (1981). Sodium and potassium. *Annual Review Nutrition*, 1: 69-93.

- Fucà N, McMahon DJ, Caccamo M, Tuminello L, La Terra S, Manenti M, Licitra G. *J Dairy Sci.* 2012 Jan;95(1):460-70. doi: 10.3168/jds.2011-4438. PMID: 22192226.
- Guinee, T. P., & O’Kennedy, B. T. (2007). Mechanisms of taste perception and physiological controls. In: T. P. Guinee, & B. T. O’Kennedy (Eds.), *Reducing salt in foods: Practical strategies* (pp. 246-287). Boca Raton LA, USA: CRC Press.
- Guinee, T. P. (2004a). Salting and the role of salt in cheese. *International Journal of Dairy Technology*, 57: 99-109.
- Guinee, T. P. (2004b). Scrap the salt: as concern about the high salt content of cheese rises. *Dairy Industries International*, 69: 36 - 38.
- McSweeney, L. H., Cogan, T. M., and Guinee, T. P., eds. Elsevier Academic Press, London, UK.
- Hagh Nazari, S. (2014). Impact of using infrared irradiation energy in food processing. *Energy Education Science and Technology Part A: Energy Science and Research. Volume (issues) 32(2): 1387-1396.*
- Heaney, R. P. (2006). Role of dietary sodium in osteoporosis. *J. Am. Coll. Nutr.* 25: 271–276.
- He, F. J., MacGregor, G. A. (2010). Reducing population salt intake worldwide: from evidence to implementation, *Prog. Cardiovasc. Dis.*, 52: 363 – 382.
- M. C., Voutsinas, L. P., Alichanidis, E., & Roussis, I. G. (1997). Reduction of sodium content in Feta cheese by partial substitution of NaCl by KCl. *International Dairy Journal*, 7(6-7): 465-472.
- Katsiari, M. C., Voutsinas L. P., Alichanidis E., Roussis G. (1998). Manufacture of Kefalograviera cheese with less sodium by replacement of NaCl with KCl. *Food Chem.*, 61: 63-70.
- Katsiari, M. C., Voutsinas, L. P., Alichanidis, E. and Roussis, I. G. (2000). Proteolysis in reduced sodium Feta cheese made by partial substitution of NaCl by KCl. *International Dairy Journal*, 10: 635-646.
- Katsiari, M. C., Voutsinas, L. P., Alichanidis, E. and Roussis, I. G. (2001). Lipolysis in reduced sodium Kefalograviera cheese made by partial substitution of NaCl with KCl. *Journal of Food Chemistry*, 72: 193-197.
- Kilcast, D. and den Ridder, C. (2007). Sensory issues in reducing salt in food products Pages 201-220 In *Reducing Salt in Foods: Practical Strategies*. Kilcast, D. and Angus, F., eds. CRC Press LLC, Washington DC, USA.
- Kotchen, T. A. (2005). Contributions of sodium and chloride to NaCl-induced hypertension. *Hypertension* 45: 849–850.
- Krishnamurthy, K., Khurana, H.K., Soojin, J., Irudayaraj, J. and Demirci, A. (2008). Infrared Heating in Food Processing: An Overview. *Comprehensive Reviews in Food Science and Food Safety*, 7, 2-13. <http://dx.doi.org/10.1111/j.1541-4337.2007.00024.x>.
- Massey, L. K. (2005). Effect of dietary salt intake on circadian calcium metabolism, bone turnover, and calcium oxalate kidney stone risk in postmenopausal women. *Nutr. Res.* 25: 891–903.
- Meneton, P., Lafay, L., Tard, A., Dufour, A., Ireland, J., Menard, J., Volatier, J. L. (2009). Dietary sources and correlates of sodium and potassium intakes in the French general population, *Eur. J. Clin. Nutr.* 63: 1169–1175.
- Ozer, B. (2014). Microflora of White-Brined Cheeses. In C. Batt, & M. Tortorello, *Encyclopedia of Food Microbiology* (p. 402). Academic Press is an imprint of Elsevier.
- Reddy, K. A., and Marth, E. H. (1993). Lipolysis in Cheddar cheese made with sodium chloride, potassium chloride or mixtures of sodium and potassium chloride. *Milchwissenschaft*. 48: 488-493.
- Reddy, K. A., and Marth, E. H. (1991). Reducing the sodium content of foods: A review. *Journal of Food Protection*. 54: 138-150.



- Renner, E. (1993). Nutritional aspects of cheese. In: P. F. Fox (Ed), cheese: chemistry, physics and microbiology Vol 1(pp, 557-559). London: Elsevier applied science.
- Schroeder, C. L., Bodyfelt, F. W., Wyatt, C. J., & McDaniel, M. R. (1988). Reduction of sodium chloride in cheddar cheese: effect on sensory, microbiological, and chemical properties. *Journal of Dairy Science*, 71(8): 988-993.
- Strazzullo, P., D'Elia, L., Kandala, N. B., Cappuccio, F. P. (2009). Salt intake, stroke, and cardiovascular disease: meta-analysis of prospective studies. *BMJ*, 339: 1 – 9.
- Walstra, P., Wouters, J., & Geurts, T. (2006). Principles of Cheese Making. In P. Walstra, J. Wouters, & T. Geurts, *Dairy Science and Technology* (pp. 577-582). NW: Taylor & Francis Group, LLC.
- World Health Organization. 2007. Reducing salt intake in populations: Report of a WHO forum and technical meeting. Accessed August 7, 2008. [http://www.who.int/dietphysicalactivity/reducingsaltintake\\_EN.pdf](http://www.who.int/dietphysicalactivity/reducingsaltintake_EN.pdf).
- Woodin, G. B. (1981). Salt maintains essential role as excess use is criticized. *Journal of Food Development*, 15: 38-41.
- Ying, Lu. Effects of Sodium Chloride Salting and Substitution with Potassium Chloride on Whey Expulsion of Cheese. Thesis for Master of Science. 2012. Utah State University.
- Zorrilla, S. E., Castelao, E. L., De Piante, D., & Rubiolo, A. C. (1996). Proteolysis during ripening of low-fat Fynbo cheese salted with a mixture of NaCl and KCl. *The Australian Journal of Dairy Technology*, 51: 6-7.
- Zorrilla, S. E., and Rubiolo, A. C. (1994). Modeling NaCl and KCl movement in Fynbo cheese during salting. *J. Food Sci.* 59:976–980.

## SEASONAL DYNAMICS OF AERO-ALERGENIC RAGWEED POLLEN IN BANJA LUKA (BOSNIA AND HERZEGOVINA) DURING 2012-2016

Gordana BABIĆ\*, Bojana ĆURKOVIĆ, Vojislav TRKULJA

Public Institution „Agricultural Institute of Republic of Srpska, Banja Luka“, Bosnia and Herzegovina

\*Corresponding author: brkljacg@hotmail.com

### Abstract

The problem of human sensitivity to ragweed pollen in our country lately is characterized by increasing trend. This is corroborated by the results of the population analysis (late adolescence patients) by skin prick test to pollen from Clinical Center Banja Luka (Entity of Republic of Srpska, Bosnia and Herzegovina). Research conducted in the ten-year period (2001-2010) showed that from the individual weed pollen in the total sample and by groups of respondents prick test is mainly positive to ragweed. Considering the above mentioned and the fact that *Ambrosia artemisiifolia* L. is widespread in the area of Banja Luka, the main aim of this study was to analyze the seasonal dynamics of ragweed pollen during a five-year monitoring (2012-2016). Sampling of ragweed pollen during the pollination period 2012-2016 was conducted in urban, industrial part of Banja Luka in Public Institution „Agricultural Institute of Republic of Srpska, Banja Luka“ with Hirst sampler using the method defined by the International Association for Aerobiology (IAA). During the five-year monitoring, the highest annual total concentration of *Ambrosia* pollen grains was recorder during 2012 (8.983 pm<sup>-3</sup>). Lower annual total concentration of *Ambrosia* pollen grains was recorder during 2013 (5.004 pm<sup>-3</sup>), 2014 (4.970 pm<sup>-3</sup>), 2015 (5.478 pm<sup>-3</sup>) and 2016 (5.256 pm<sup>-3</sup>). However, considering clinical thresholds that lead to the symptoms of allergy can be as low as 1-3 pm<sup>-3</sup> of air for hypersensitive patients and 10-50 pm<sup>-3</sup> for the majority of the patients, conducted monitoring pointed out on *Ambrosia* pollen as a growing health and social problem in our country.

**Keywords:** *seasonal dynamics, aero allergen, ragweed, Banja Luka.*

### Introduction

A number of authors like Makovcová *et al.* (1998), Dahl *et al.* (1999), Rybníček *et al.* (2000), Laaidi *et al.* (2003), Makra *et al.* (2004), Peternel *et al.* (2005) and Tamaracaz *et al.* (2005) stated Bosnia, among many countries, as one of the most contaminated place in Europe with *Ambrosia artemisiifolia* L., the highly allergenic plant. This species is considered a biological pollutant responsible for severe allergic diseases (Déchamp and Méon, 2003), that are clinically manifested as rhinitis, rhinoconjunctivitis and bronchial asthma (Gioulekas *et al.*, 2004; Trkulja *et al.*, 2010). In the area of Banja Luka, ambrosia is very widespread and it is in expansion (Pušić *et al.*, 2012). Thus the problem of human sensitivity to allergenic ragweed pollen in our country lately is characterized by increasing trend. This is corroborated by the results of the population analysis (late adolescence patients) by skin *prick* test to pollen from Clinical Center Banja Luka. Research conducted in the ten-year period (2001-2010) have shown that from the individual weed pollen in the total sample and by groups of respondents *prick* test is mainly positive to ragweed (Balaban and Balaban, 2012). Never the less, ragweed presents one of the most invasive weed species in our area (Trkulja *et al.*, 2012) and to polinosis as an additional problem indicate data that this aeroallergen with a favorable wind

can move at up to 300 km (Jones, 1953; Comtois, 1998; Deen et al., 1998, Genton et al., 2005) to large distance of 10 to 100 km. Considering the above mentioned, the main aim of this study was to analyze the seasonal dynamics of ragweed pollen during five year monitoring (2012-2016).

### Material and method

Monitoring the concentration of ragweed pollen during the pollination period (2012-2016) was conducted at the PI Agricultural Institute of Republic of Srpska, Banja Luka (N 44°47'41.0'', E 017°12'22.6''), by Hirst's type pollenometer (Hirst, 1952). Sampling of aeroallergenic ragweed pollen was conducted in urban, industrial part of Banja Luka, using the method defined by the International Association for Aerobiology (IAA). The trap brand Burkard (Burkard Manufacturing Co., Uxbridge, Middlesex, England) is calibrated for sampling 10 liters of air per min through a hole 14 x 2 mm diameter, which always faces the wind direction and it is protected from direct rainfall. As air passing through the orifice, pollen grains are fixed on glass slides coated with silicone gel, which moves at the rate of 2 mm h<sup>-1</sup>. Visual identification, or qualitative and quantitative assessment, of sampled ragweed pollen grains was carried out on a daily basis after 24 hours, based on the morphological characteristics under a light microscope Olympus BX51 at magnification x400, according to the International Association for Aerobiology and converting the obtained results in the concentration of pollen grains per m<sup>3</sup> of air. Immediately prior to screening, microscopic slide with 24-hour segment, is prepared by placing polyvinyl alcohol substrate (Gelvatol), phenol, and glycerol, which allows color fuchsin staining of pollen grains and easy separation of the same from dust particles and fungal spores. After preparation and drying microscopic slide determining the number of pollen grains is carried out by the method of longitudinal lines in two-hour intervals and reviewing the 3 horizontal lines. At the end of the analysis, the obtained values are converted to daily concentrations determined by multiplying the number of pollen grains by a factor F, depending on the characteristics of the device for sampling, surface of 24 hour segment, characteristics of the microscope and the surface of the inspected sub-sample. Concentration of the pollen grains per m<sup>3</sup> of air is important for symptoms occurrence of allergic reactions. Thus the monitoring results are presented to the public in the form of daily aeropallinological reports or so called "Pollen traffic light" on the official web site of City of Banja Luka (Table 1).

Table 1. Number of ragweed pollen grains in the air with the corresponding percentage of persons in whom is possible occurrence of symptoms of allergic reactions (Forsyth County Environmental Affairs Department Pollen Rating Scale, PRS)

Level of pollen	<i>Number of pollen grains</i> /m <sup>3</sup> air	<i>Occurrence of symptoms of allergic reactions</i>
	Weeds	
Not present	0	No symptoms
Low	1-10	Only in extremely sensitive individuals
Moderate	11-50	In 50% of sensitive individuals
High	51-500	Almost all allergic people
Very high	>500	In all allergic people

## Results and discussion

During the five-year sampling (2012-2016) of aeroallergen ragweed pollen in the city of Banja Luka dynamics, i.e. the beginning, duration and end of the pollination period with presenting daily low, moderate, high or very high concentrations ( $\text{p pm}^{-3}$ ) as well as a total weed pollen number on annual level ( $\text{p pm}^{-3}$ ) was monitored. Annual total concentrations of *Ambrosia* pollen grains was 8993  $\text{p pm}^{-3}$  in 2012, 5004  $\text{p pm}^{-3}$  in 2013, 4970  $\text{p pm}^{-3}$  in 2014, 5478  $\text{p pm}^{-3}$  in 2015 and 5256  $\text{p pm}^{-3}$  in 2016 (Figure 1). In addition, high to very high concentrations in all five years of monitoring were recorded from third decade of August to the second decade of September.

The first ragweed pollen grains in 2012 were registered in early July. Occurrence of low concentration or absence of ragweed pollen grains retained until the second decade of August. Since mentioned period moderate concentration trend was registered until the second decade of August. Increased tendency starts from second decade of August, and is characterized by high concentrations. Maximum concentration of 476  $\text{p pm}^{-3}$  was recorded on September 1<sup>st</sup>. High concentration retained until the second decade of September with a few occurrence of moderate concentration. Until October moderate concentrations were registered which remains for a shorter period of time, followed by low concentrations that remain until the end of the pollination season (Figure 2).

In 2013 the first ragweed pollen grains were registered in the third decade of June, with very low concentration or even absence of ragweed pollen grains in the atmosphere until third decade of July. Low concentrations were registered until the second decade of August, with moderate concentrations registered only during two days. From that period increased tendency ragweed pollen concentration, with moderate and high concentration start and last until the end of September. Maximum concentration of ragweed pollen grains, 199  $\text{p pm}^{-3}$  respectively, was registered on August 8<sup>th</sup>. Low concentrations were registered until the end of the pollination season (Figure 3).

Similarly to previous year, seasonal dynamic of ragweed pollen in 2014 was almost identical with the pervious one, starting from the end of June with low concentrations until the first decade of August. Moderate to high concentration remain until the end of September, while the maximum concentration, 197  $\text{p pm}^{-3}$  respectively, was registered on August 8<sup>th</sup>. Low concentration remains until the end of season (Figure 4).

In 2015 the first ragweed pollen grains were registered in the third decade of June. Low concentrations remain until the third decade of July. However moderate concentration last just a few days. Increasing trend starts from the first decade of August, and moderate to high concentrations remain until the end of September, however the maximum concentration (220  $\text{p pm}^{-3}$ ) as in 2012 was registered in first decade of September, on September 8<sup>th</sup> respectively. Trend of low concentration lasts until the end of the pollination season (Figure 5).

Starting from the end of July until the almost second decade of August 2016, low concentrations of ragweed pollen grain were recorded. Moderate concentrations remain until the end second decade of August, followed by high concentrations until second decade of September. Moderate concentration last a few days, followed by low concentration until the end of season, the end of October. In 2016 the maximum concentration, 389  $\text{p pm}^{-3}$ , was recorded on September 4<sup>th</sup> (Figure 6).

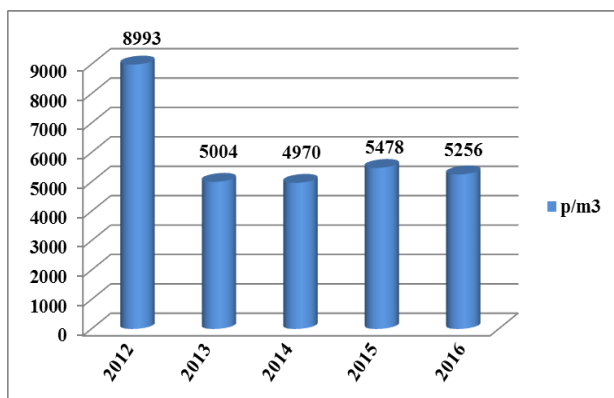


Figure 1. Annual total concentrations of Ambrosia pollen grains in Banja Luka, 2012-2016

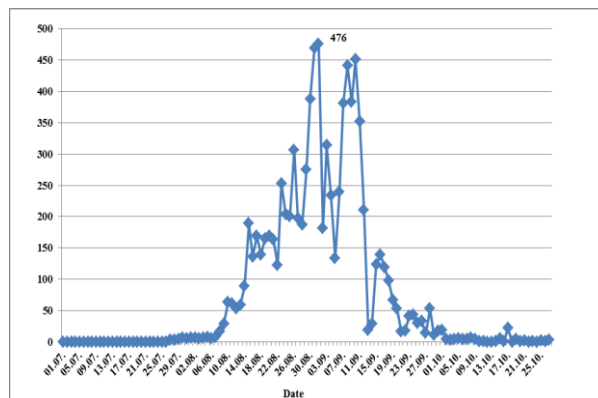


Figure 2. Seasonal dynamics of ragweed pollen in 2012.

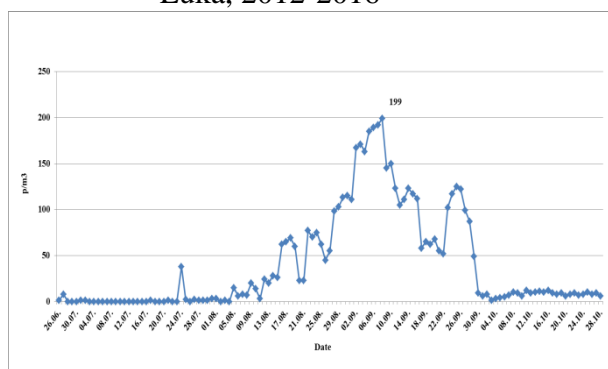


Figure 3. Seasonal dynamics of ragweed pollen in 2013

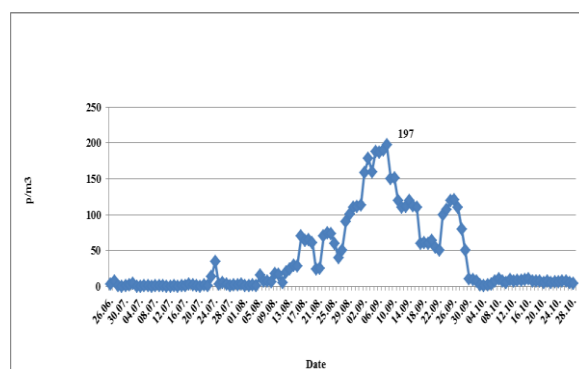


Figure 4. Seasonal dynamics of ragweed pollen in 2014

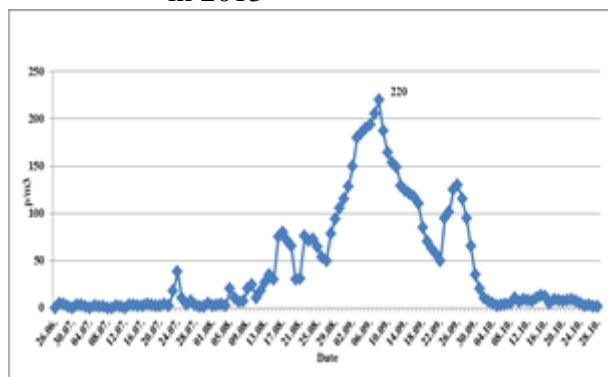


Figure 5. Seasonal dynamics of ragweed pollen in 2015

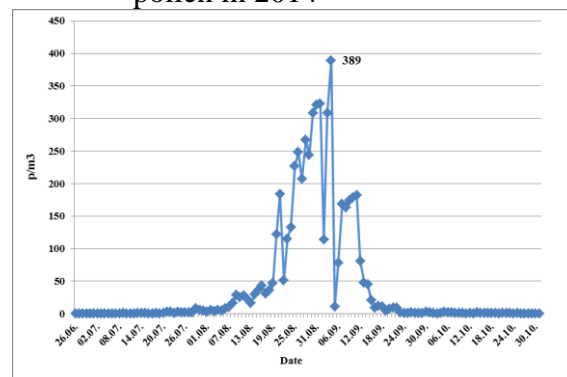


Figure 6. Seasonal dynamics of ragweed pollen in 2016

### Conclusion

Although in Banja Luka in last five years very high concentrations ( $>500 \text{ p } \mu\text{m}^{-3}$ ) were not registered, conducted monitoring pointed out on *Ambrosia* pollen as a growing health and social problem in our country. This is also corroborated by the past results of the population analysis from Clinical Center Banja Luka, as well by fact that patient sensitivities to the symptoms of allergy can be as low as  $1-3 \text{ p } \mu\text{m}^{-3}$  for hypersensitive patients and  $10-50$  grains for the majority of the patient.

## References

- Balaban, J, Balaban, M, (2012). The pollen profile and patients pollen allergy in a Clinical center of Banja Luka. The first International Congress of Ecologists. Proceedings: University of Business Studies, Banja Luka, Ecological Spectrum, 1, 101–111.
- Comtois, P, (1998). Ragweed (*Ambrosia* sp.): the Phoenix of allergophytes. 6th International Congress on Aerobiology. Satellite Symposium Proceedings: Ragweed in Europe, Perugia, Italy, ALK Abelló.
- Comtois, P, Gagnon, L, (1988). Concentration pollinique et fréquence des symptômes de pollinose: une méthode pour déterminer les seuils cliniques. *Revue Française d'Allergologie*, 28(4), 279.
- Dahl, A, Strandhede, S. O, Wihl, J. A, (1999). Ragweed-An allergy risk in Sweden? *Aerobiologia*, 15(4), 293–297.
- Deen, W, Hunt, A. L, Swanton, J. C, (1998). Photothermal time describes common ragweed (*Ambrosia artemisiifolia* L) phenological development and growth. *Weed science*, 46, 561-568.
- Déchamp, C, Méon, H, (2003). *Ambrosia, Ambrosie, polluants biologiques*. Lyon, Edition ARPPAM, 238 pp. et 135 illustrations.
- Genton, B. J, Shykoff, J. A, Girand, T, (2005). High genetic diversity in French invasive populations of common ragweed *Ambrosia artemisiifolia*, as a result of multiple sources of introduction. *Molecular ecology*, 14, 4275-4285.
- Gioulekas, D, Papakosta, D, Damialis, A, Spieksma, F T M, Giouleka, P, Patakas, D, (2004). Allergenic pollen records (15 years) and sensitization in patients with respiratory allergy in Thessaloniki, Greece. *Allergy*, 59, 174–184.
- Hirst, J. M, (1952). An automatic volumetric spore trap. *Ann Appl Biol*, 39, 257.
- Jones, H. L, (1953). Frenching of ragweed (*Ambrosia artemisiifolia* L.). *Plant physiology*, 28, 123-126.
- Laaidi, M, Thibaudon, M, Besancenot, J. P, (2003). Two statistical approaches to forecasting the start and duration of the pollen season of *Ambrosia* in the area of Lyon (France). *Int. J. Biometeorol.*, 48(2), 65–73.
- Makovcová, S, Zlinská, J, Mikolás, V, Salát, D, Krio, M, (1998). Ragweed in Slovak Republic. 6th International Congress on Aerobiology. Satellite Symposium Proceedings, Ragweed in Europe, Perugia, Italy, ALK Abelló.
- Makra, L, Juhász, M, Borsos, E, Béczi, R, (2004). Meteorological variables connected with airborne ragweed pollen in Southern Hungary. *Int J Biometeorol*, 29(1), 37–47.
- Peternel, R, Culig, J, Srnc, L, Mitić, B, Vukusić, I, Hrga, I, (2005). Variation in ragweed (*Ambrosia artemisiifolia* L.) pollen concentration in Central Croatia. *Ann Agric Environ Med*, 12(1), 11–16.
- Pušić, R, Vujčić, S, Mazalica, N, Đurić, M, (2012). *Ambrosia* in the area of Banja Luka. *Ecological Spectrum*, 2012, 1, 1111–1120.
- Rybníček, O, Novotná, B, Rybníčková, E, Rybníček, K, (2000). Ragweed in the Czech Republic. *Aerobiologia*, 16(2), 287–290.
- Tamaracaz, P, Lambelet, C, Clot, B, Keimer C, Hauser, C, (2005). Ragweed (*Ambrosia*) progression and its health risks: will Switzerland resist this invasion? *Swiss Med Weekly*, 135, 538–54.
- Trkulja, V, Herceg, N, Škrbić, R, Ostojić, I, Petrović, D, Kovačević, Z, (2010). *Ambrozija*. Društvo za zaštitu bilja u Bosni i Hercegovini, Banja Luka.
- Trkulja, V, Babić, G, Rajčević, B, Mihić Salapura, J, Kovačić, D, Simić, J, Vuković, S, (2012). Seasonal Analysis of aeroallergenic ragweed pollen in the area Banja Luka during 2007-2011. The first International Congress of Ecologists. Proceedings: University of Business Studies, Banja Luka, Ecological Spectrum, 1, 1029–1038.

## CONTRIBUTION TO KNOWLEDGE OF THE MORPHOLOGY AND BIOLOGY OF PEAR SHOOT SAWFLY (*Janus compressus* Fabricius)

Dragana KOVAČIĆ JOŠIĆ<sup>1\*</sup>, Radmila ALMAŠI<sup>2</sup>, Vojislav TRKULJA<sup>1</sup>

<sup>1</sup>Agricultural Institute of Republic of Srpska, Banja Luka, Bosnia and Herzegovina

<sup>2</sup>University of Novi Sad, Faculty of Agriculture, Serbia

\*Corresponding author: dragana\_kovacic@yahoo.com

### Abstract

The aim was to study life cycle, biological and morphological characteristics of the pest Pear Shoot Sawfly (*Janus compressus* Fabricius). Field trial was carried out in pear orchard area during 2011 and 2012 at locality Jablan (Laktaši Municipality, Bosnia and Herzegovina). The emergence of adults was monitored with yellow sticky traps produced by BioPlantella and by visual inspection. Biology and morphology of pear sawfly was studied by monitoring and observation of different stages. Life cycle of the pest was monitored by direct observation in natural environment. Morphological characteristics of different stages were observed and studied using a laboratory stereomicroscope. Pest is univoltine in climatic conditions of Banja Luka's region. Pear shoot sawfly emerges from the end of April until the end of May with the peak population around May 1<sup>st</sup>. Adults have elongated body and sexual dimorphism is present. Female lays eggs in very specific way by making punctures with ovipositor on young shoots spirally from the top to the bottom of the shoot. Egg is whitish or light yellow. Embryonic development lasts from 12 to 14 days. Fully grown larvae are about 10 mm long and have characteristic shape of letter "S". During September larvae finish their development and make hibernation chamber where they overwinter. Larvae spend its whole life in infested shoots. Pupa is found in spring, at the end of March and beginning of April. Pupa is exarate and pupal stage lasts 4-5 weeks.

**Key words:** Pears shoot sawfly, biology, morphology, Banja Luka's region

### Introduction

In the last decades fruit production in Republic of Srpska has been characterized by extremely dynamic and fast changing technology. However, pear production and yields are such that they put us in an inferior position in relation to the developed European countries and world. There are many reasons for this situation, and one of the most important is pests and diseases of pear. Pear shoot sawfly has been considered an important pest in recent years, although it is a periodic pest. Validžić *et al.* (2010) state that *J. compressus* gets on the significance in the area of Eastern Slavonia in recent years and that the most severe damage is on the pear, but the pest also attacks apple, quince and medlar, although rarely. On young fruit trees, even if it's low population density of the pest, the damage is very noticeable although there is only one generation per year. Adult, that is, female, adversely affects the proper formation of the tree crown by destroying young pear shoots, but also tree productivity (Maceljiski, 1999). It is especially dangerous in fruit tree nurseries because it destroys and stops the growth of young branches, and complicates the production of fruit trees (Balachowski *et Mesnil*, 1935). Literature data about this pest are insufficient in the territory of the former Yugoslavia as well as in Europe. The oldest data about pear shoot sawfly are published by Jablanowski in 1904 and Balachowski and Mesnil in 1935.

The aim of the research was to study the biology, that is, the life cycle of the pear shoot sawfly and to study the morphological characteristics of different development stages of the pest.

### **Material and method**

Field trial was conducted in pear orchard area during 2011 and 2012 at locality Jablan (Laktaši Municipality). In this orchard there is no intensive spraying against pear pests and diseases and pesticides are applied only periodically and if economic threshold is exceeded. A great number of pear orchards in Banja Luka and Gradiška in which pesticides are applied regularly were checked in order to choose the location for setting up a trial but pear shoot sawfly was not detected there. The adult emergence and flight activity was monitored in 2011 by yellow sticky traps produced by BioPlantella and by visual method. Traps are placed inside the tree crown so that both sides of the trap are exposed to insect flight as much as possible. Traps were changed weekly, and the traps were placed on the selected trees 7 days before the expected pest flight in 2011. Population level was determined every week after changing the traps. Data on adult emergence and flight are compared with climate factors (precipitation, minimum, maximum and mean daily temperature). At the same time, typically damaged shoots were isolated with “cages” made of thin transparent material (marquisette) in order to monitor adult emergence, but also in order to mark the shoots so that they could be easily found on the trees during the whole year. The biology and morphology of pear shoot sawfly were studied by monitoring and observing different developmental stages of the pest, that is, the morphological characteristics of eggs, larvae, pupa and adults as well as egg-laying, the shape and number of punctures made during laying eggs, embryonic development and time of occurrence of different stages. A total of 240 young shoots were checked. The pest life cycle was studied by direct observation in the natural environment. The morphological characteristics of different development stages of the pest were observed and studied using a laboratory binocular (stereomicroscope) Olympus SZX7, while photographs were taken using the digital camera Olympus DP12 and measurements were done by Olympus Camedia Micro Imaging software in Agricultural Institute of the Republic of Srpska, Banja Luka.

### **Results and discussion**

#### **Damage**

Female damages young shoots that soon afterwards wilt and curve. After that, damaged shoots decline and the leaves turn black (fig. 1).



Fig. 1. Young pear shoot damage by pear shoot sawfly. (Photo: original)



Fig. 2. Pear shoot sawfly adult. (Photo: original)



The damage can be particularly significant in nurseries. These symptoms can be confused with symptoms of fire blight caused by *Erwinia amylovora*. However, there is no spirally arranged series of punctures on shoots with fire blight symptoms. Sometimes the infested shoot regenerates and continues to grow. These shoots are easily recognized by their leaves that haven't turned black and there are no punctures. We can conclude that female has attacked these shoots but didn't lay an egg or larvae didn't develop from some reason. During the orchard check on 10<sup>th</sup> May a young pear fruit with characteristic spirally arranged series of punctures on stalk was found. The infested fruit decline and turned black. The female also laid an egg in the fruit stalk. Detected shoot damage corresponds to literature data (Jablanowski, 1904; Kovačević, 1961; Tanasijević i Simova-Tošić, 1987; Kišpatić i Maceljki, 1989, Pollini, 1992).

### Morphological and biological characteristics of pear shoot sawfly adult

#### *Morphological characteristics of adult*

Pear shoot sawfly adult has elongated body and antennae (fig. 2). All Hymenoptera are parthenogenetic and that results in sexual dimorphism (Gardner *et al.*, 2011; Ivezić, 2008; Kovačević, 1950; Jablanowsky, 1904; ). Females are 9-12 mm long, while males are smaller and 6-9 mm long. Basic color of both male and female is black. The head is black except the mandibles that are yellow. There is a pair of compound eyes on the front part of the head as well as three simple eyes. Antennae are filiform. Thorax is black and three-segmented. Abdomen in males is yellowish-orange to orange, while females have red to dark red abdomen. The last abdominal segment is black and ends with protuberance that serves to protect the ovipositor (Goulet, 1992). Ovipositor is short and denticulate. Legs of male are yellow, while those in female are darker (brown). Although the wings are transparent, folded wings have purple glow. Literature data on morphology of adults vary depending on the author.

#### *Pear shoot sawfly adult flight monitoring*

Pear shoot sawfly adult flight activity was monitored for eight weeks during 2011 (18<sup>th</sup> April – 12<sup>th</sup> June). Data on average number of adults per trap are shown on chart 1.

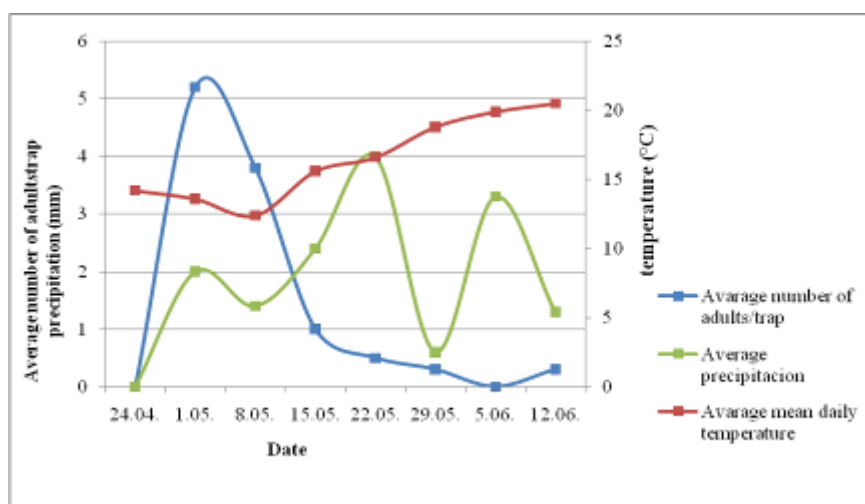


Chart 1. An average number of pear shoot sawfly adults per sticky traps and meteorological data for the monitoring period.

According to flight monitoring, adult flight activity was detected from 25<sup>th</sup> April till 29<sup>th</sup> May, and the largest number of adults was caught in the second and third week of monitoring, that is from 25<sup>th</sup> April till 8<sup>th</sup> May (Kovačić, 2015). In the fourth, fifth and sixth week of monitoring, four, two, and one adult were caught, respectively, while in the seventh

week no adult was caught. It is interesting that on June the 12<sup>th</sup>, that is, in the last week of monitoring, one adult was found on sticky trap indicating a very prolonged period of adult flight or the appearance of the adult was postponed due to climate factors. When compared with climate factors (precipitation, minimum, maximum and mean daily temperature) these data show that adults flight is the most intensive during warm spring days, when mean daily temperatures are above 12°C. Adults are frost-sensitive.

#### Egg-laying

Female lays eggs in a very specific way that is not seen in other insect families. Eggs are laid in 10-20 cm long young shoots and the female is making a spirally arranged series of punctures from the top to the bottom of the shoot. The smallest found number of punctures on 40 checked shoots is eight, while the largest number of punctures is 39 (Kovačić, 2015). The number of punctures on single shoot ranges between 10 and 30 (an average of 22). Reasons why female makes the punctures aren't studied enough and some authors (Kišpatić and Maceljiski, 1979; Maceljiski, 1999) state that in this way female creates favorable conditions for larval development. At the site of the punctures shortly after attack dark dots are created. Size of the puncture hole is an average of 0.35 x 0.12 mm.

#### Morphological and biological characteristics of the egg

The egg is whitish to light-yellow, oval or elongate and slightly curved along the longitudinal axis (fig. 3). Eggs are laid singly in young pear shoots. The egg was found in 37 out of 40 (92.5%) checked shoots. The average size of measured eggs is 1 x 0.32 mm. Embryonic development was observed in natural conditions by checking the damaged shoots 10-15 days after the most intensive attack. First larvae were found on 12<sup>th</sup> May, and considering that damaged pear shoots were noticed on 29<sup>th</sup> April and that till 01<sup>st</sup> May there was very large number of infested shoots it can be concluded that embryonic development lasts 12-14 days.



Fig. 3. Pear shot sawfly egg (Photo: Kovačić Jošić, D.)

#### Morphological and biological characteristics of larvae

Larva is white to light-yellow, about 10 mm long. Larva has characteristic letter "S" shape (fig. 4). Head is well developed as well as mouth parts that are dark. The body consists of segments that are narrowed laterally along the whole body and look like "stitches". Thoracic legs are reduced and hardly visible while abdominal legs are absent. On the last abdominal segment there is dark protuberance with dark hair. In the beginning of June 40 marked pear shoots were checked and in 27 out of 40 (67.5%) larvae were found. The reason for such high mortality of larvae might be climatic factors. On May 6<sup>th</sup> there was a frost with minimal daily temperature 0.5°C and after that adult flight activity was severely reduced as well as number of adults caught on sticky traps. This low temperature surely affected the eggs, too and embryonic

development lasted longer. Validžić (2013) states that there are also other reasons for this, that is regeneration of some shoots after the attack as well as parasitoids and entomopathogenic fungi. Larvae spend its whole life within the shoots and feed with the pith of the shoot. During the feeding larvae move from the top to the bottom of shoot and the shoot pith is completely destroyed and turned to frass-filled gallery (fig. 5). In the beginning of September larvae stop to feed and end their development and then make hibernation chamber at the end of the feeding gallery in which they overwinter in translucent cocoon. Before changing into the pupal stage larvae make an exit hole for adults, leaving just the thin layer of bark.



Fig. 4. Different larval stages photographed in the beginning of June and beginning of September; visible letter “S” shape (Photo: Kovačić Jošić, D.)



Fig. 5. Pear shot sawfly larvae frass-filled feeding gallery (Photo: Kovačić Jošić, D.).

#### Morphological and biological characteristics of pupa

Pupa is exarate, which is typical for suborder Symphyta, 7-9 mm long. Pupal stage occurs in spring from the last decade of March and in the beginning of April. Pupal stage lasts 4-5 weeks. Pupation is finished in the middle of April and adults emerge from the end of April. Pupa was found in 57.5% of checked shoots.

## Conclusions

Pear shoot sawfly has been considered an important pest in the last decades. Damage is very specific and can't be confused with any other pest. Adults in Banja Luka's region emerge earlier than the literature data state. There is sexual dimorphism present. Adult flight activity lasts very long and the peak population is around 1<sup>st</sup> May. Eggs are laid singly in young pear shoots. The egg is whitish to light-yellow, oval or elongate and slightly curved along the longitudinal axis. Embryonic development lasts 12-14 days in climatic conditions of this region. The female can also lay an egg in young fruits that desiccate and turn black. Larvae spend its whole life within the shoots and feed with the pith of the shoot. Larva is white to light-yellow and has characteristic letter "S" shape. Larval stage lasts from May till September. Larvae overwinter in the shoot. Pupa is exarate and pupal stage lasts 4-5 weeks.

## References

- Balachowski, A, Mesnil, L, (1935). Les insectes nuisibles aux plantes cultivees, Paris, vol. I, 238–241.
- Gardner, A, Alpedrinha, J, West, S. A, (2011). Haplodiploidy and the Evolution of Eusociality: Split sex ratios, *The American Naturalist*, vol. 179 (2), 240.
- Goulet, H, (1992). The insects and arachnids of Canada. Centre for Land and Biological Resources Research, Ottawa, 13–18.
- Ivezić, M, (2008). Entomologija /Entomology/. Poljoprivredni fakultet u Osijeku, 34–36.
- Jablanowski, J, (1904). A kortefanak egy kulonos ellensegerol. *Rovart. Lapok* 11, 67-72, 89-94.
- Kišpatić, J, Maceljiski, M, (1989). Zaštita voćaka od bolesti, štetnika i korova. Peto, dopunjeno izdanje, Nakladni zavod Znanje, Zagreb, 85–87.
- Kovačević, Ž, (1950). Primijenjena entomologija I /Applied entomology 1/. Poljoprivredni nakladni zavod, Zagreb, 61–63.
- Kovačević, Ž, (1961). Primijenjena entomologija /Applied entomology/. Poljoprivredni nakladni zavod, Zagreb, 148–149.
- Kovačić, D, (2015). Biologija i morfološke karakteristike kruškine ose srčikarice, *Janus compressus* Fabricius (Hymenoptera: Cephidae). Master rad. Poljoprivredni fakultet, Novi Sad, 45.
- Maceljiski, M, (1999). Poljoprivredna entomologija /Agricultural entomology/. Zrinski d.d., Čakovec, 136–137.
- Pollini, A, (1992). La difesa delle piante da frutto. *Edizioni Agricole*, 323–324.
- Tanasijević, N, Simova-Tošić, D, (1987). Posebna entomologija /Special entomology/. Naučna knjiga Beograd, 604.
- Validžić, T, Ivezić, M, Raspudić, E, Brmež, M, Majić, I, (2010). Suzbijanje ličinki kruškine ose srčikarice. *Glasilo biljne zaštite broj 1/2-dodatak, sažeci* 54. seminara biljne zaštite, Opatija, 42.
- Validžić, T, (2013). Kruškina osa srčikarica (*Janus compressus* Fabricius) – životni ciklus i biološko morfološke osobine. Doktorski rad. Sveučilište Josipa Jurja Strossmayera u Osijeku, Poljoprivredni fakultet u Osijeku.

## OCCURRENCE OF FUSARIUM HEAD BLIGHT IN CONDITIONS OF NATURAL INFECTION IN WINTER WHEAT AND EFFICIENCY OF APPLIED FUNGICIDE

Vojislav TRKULJA\*, Gordana BABIĆ, Bojana ĆURKOVIĆ, Dragan MANDIĆ, Goran ĐURAŠINOVIĆ

Public Institution „Agricultural Institute of Republic of Srpska, Banja Luka“, Bosnia and Herzegovina

\*Corresponding author: vtrkulja@blic.net

### Abstract

During April, May and June 2014 frequent and extremely heavy rainfall and floods in area Banja Luka caused high occurrence of *Fusarium* species in winter wheat. Fusarium head blight (FHB) presents a worldwide problem and it is the most important disease in wheat. In the last few years great attention is particularly focused on the risk of FHB of various types of small grains, not only because they cause yield reduction which reaches 10-70%, but primarily due to the production of mycotoxins. The main objective of this study was to determine the intensity occurrence of FHB and make the identification of *Fusarium* species in the area of Banja Luka, as well as to consider the possibility of effective chemical control. Efficiency of prothioconazole + tebuconazole was carried out on two winter wheat varieties (Orion and Nova Bosanka) in the experimental fields of PI AIRS, Banja Luka (Entity of Republic of Srpska, Bosnia and Herzegovina) according to EPPO broj standards. Visual assessment of FHB intensity was made according to Miedaner and Perkowski (1996) scale. The identification of sampled ears pointed out the presence of two *Fusarium* species, *F. culmorum* and *F. graminearum*, respectively. Considering the environmental conditions in 2014, high intensity of *Fusarium* species in both varieties of winter wheat was observed. However, applied fungicide showed high efficiency (>90%), with a small difference in coefficient of efficiency Ce (%) between treated varieties.

**Keywords:** FHB, natural infection, *F. culmorum*, *F. graminearum*, fungicide protection.

### Introduction

Fusarium head blight (FHB) in wheat is a widespread disease around the world including all European cereal-growing areas (Bottalico *et* Perrone 2002). Nineteen species of *Fusarium* are reported to cause wheat FHB disease (Stepień *et* Chelkowski, 2010). In general, the causal agents of FHB in Europe are primarily *F. graminearum* (teleomorph *Gibberella zae*), *F. culmorum* and *F. avenaceum* (teleomorph *Gibberella avenacea*). Less frequently represented species are *F. poae*, *F. cerealis*, *F. equiseti*, *F. sporotrichioides*, *F. tricinctum* and, to an even lesser extent also *F. acuminatum*, *F. subglutinans*, *F. solani*, *F. oxysporum*, *F. verticillioides*, *F. semitectum* and *F. proliferatum* (Bottalico *et* Perrone, 2002; Lemmens *et al.*, 2004; Stepień *et al.*, 2008). Disease is favored by extended periods of moderately high temperature (15–30°C), high moisture (relative humidity > 90%), and frequent rainfall (De Wolf *et al.*, 2003; Lemmens *et al.*, 2004; Xu *et al.*, 2008; Sadowski *et al.*, 2011; Lenc, 2015). Their distribution in almost all agro climatic areas is conditioned by high adjustment to different extreme environmental conditions. However, FHB occurs primarily in warm and humid climatic conditions during the flowering stage (Parry *et al.*, 1995; Walter *et al.*, 2010). Anderson (2007) research pointed out how much the appearance and development of this disease is closely related with the temperature. According to the above mentioned research incidence

increases as temperature increases from 20°C to 30°C, and little or no infection occurred under 15°C. But humidity is as important as temperature for the occurrence of wheat scab (Xu *et* Nicholson, 2009; Horberg, 2002).

In the last few years great attention is particularly focused on the risk of FHB of various types of small grains, not only because they cause yield reduction which reaches 10-70% (Matthies *et* Buchenauer, 2000), but primarily due to the production of mycotoxins. Frequent occurrence of extremely heavy rainfall and floods, as one of climate extremes recorded in area Banja Luka during April, May and June 2014, resulted in the occurrence of an severe infection of winter wheat with *Fusarium* species. The main objective of this study was to determine the intensity occurrence of FHB and make the identification of *Fusarium* species in the area of Banja Luka, as well as to consider the possibility of effective chemical control.

### Material and method

A field experiment was conducted in 2013/2014 according to European and Mediterranean Plant Protection Organization guidelines (EPPO/OEPP 1999; EPPO/OEPP 2012) in the experimental field of the PI AIRS, BL. The experiment was designed as a randomised block, with 12,5 m<sup>2</sup> (2,5 x 5 m) elementary plots in 4 repetition in locality Ekonomija. Winter wheat, cv. Orion i Nova Bosanka are sown and grown according to standard farm practice in our area. Fungicide Prosaro 250 EC (prothioconazole + tebuconazole) was applied according to a recommended dose of producer Bayer CropScience (1L ha<sup>-1</sup>) during the early flowering stage. Fungicide was applied with sprayer "Solo 425" and šta. The experiment was conducted under the conditions of conventional technology, with the application of a certain quantity of mineral fertilizers that in our conditions can provide a yield between 6 and 7 t ha<sup>-1</sup>, as follows: 300 kg NPK 15:15:15 in stage of cultivation, followed by first fertilization with 200 kg KAN - 27% at the stage of the start of tillering, and the second fertilization of 180 kg in the phase of tillering or intensive growth.

Visual assessment of FHB intensity was made following the manifestation of a clear difference in the intensity of the disease between the control (untreated) and treated varinats. For disease assessment wheat heads were rated at the hard dough stage. One hundred wheat heads from each replication were harvested by hand and subsequently analyzed in the laboratory for disease incidence (DI; percentage of diseased ears) and disease severity (DS) on a 1 to 9 scale in which 1 – no symptoms, 2 – < 5%; 3 – 5-15%; 4 – 16-25%; 5 – 26-45%; 6 – 46-65%; 7 – 66-85%; 8 – 86-95%; 9 – 96-100% (Miedaner *et* Perkowski, 1996).

For isolation of *Fusarium* species, kernels with visible symptoms were collected directly during the visual analysis from the wheat ears. Each sample was subjected to a stereomicroscope (Olympus SZX7) and a microscope (Olympus BX51) examination with photo documentation. Samples were 45 minutes washed under running water, surface-sterilised in 1 % NaOCl, 3 time washed in sterile water, air dried and transferred onto PDA (Potato Dextroze Agar, Difco pH 6,5) supplemented with antibiotics streptomycin sulphate. After 5-7 days incubation in an incubator (temperature 25°C and humidity 80%, illumination with dark UV light), a single spore technique was used to obtain pure cultures for identification (Photo 1a-1f). In further assessment Potato dextrose agar (PDA) (Difco) medium was used to assess colony characteristics such as pigmentation and growth rate. SNA medium, supplemented with a piece of filter paper to promote sporulation, was used to examine conidial morphology and to detect the presence of chlamydospores. Individual *Fusarium* species were identified (Booth 1971; Nelson *et al.* 1983; Lević, 2008).

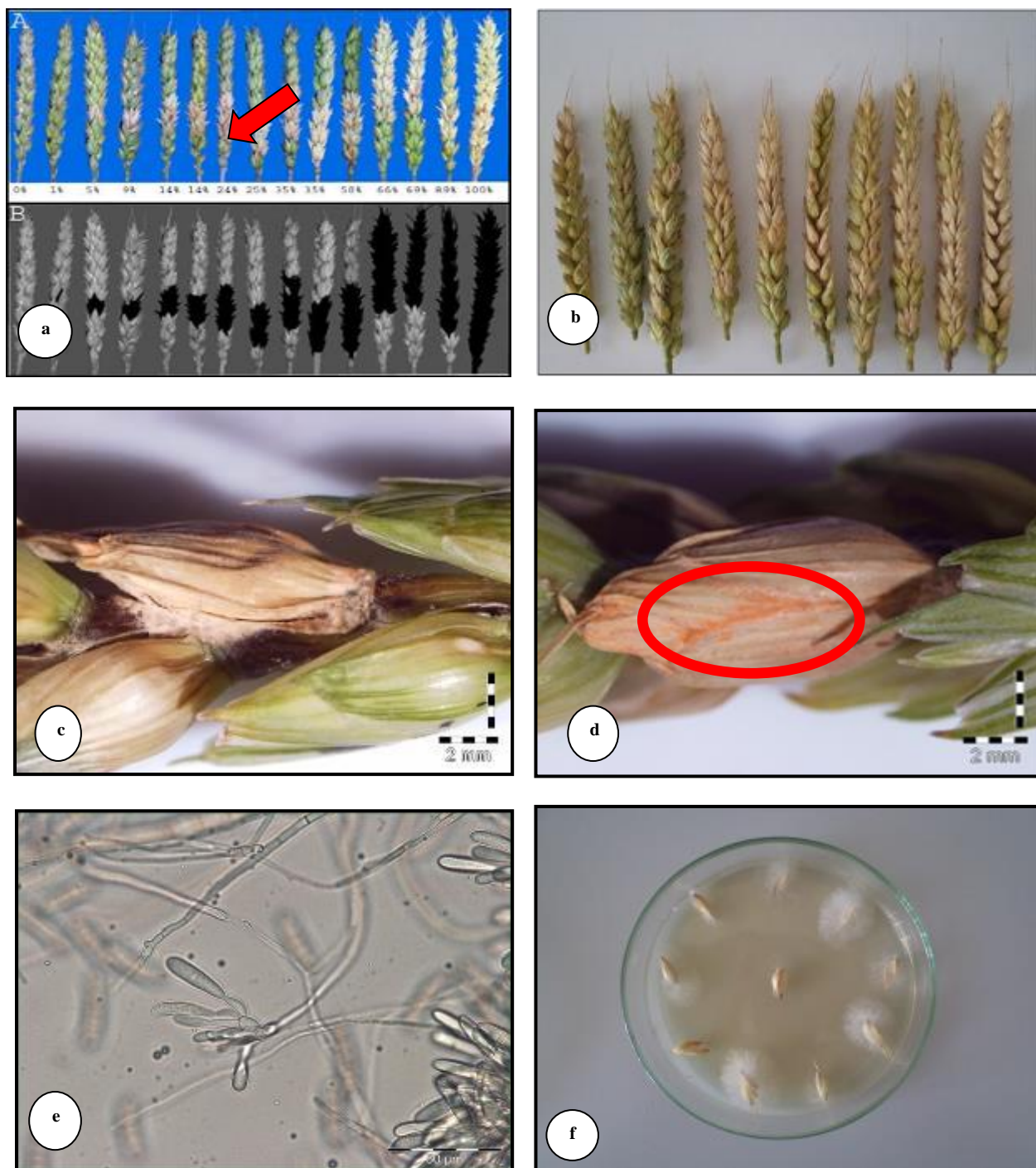


Photo 1. *FHB* of winter wheat: a) Scale for disease incidence; b) Typical symptoms of *FHB* (natural infection); c) Typical symptoms of *FHB* on wheat grain (natural infection); d) *Sporodochium* on infected wheat grain; e) *Conidiophore* from infected wheat grain; f) Colony development on PDA.

### Results and discussion

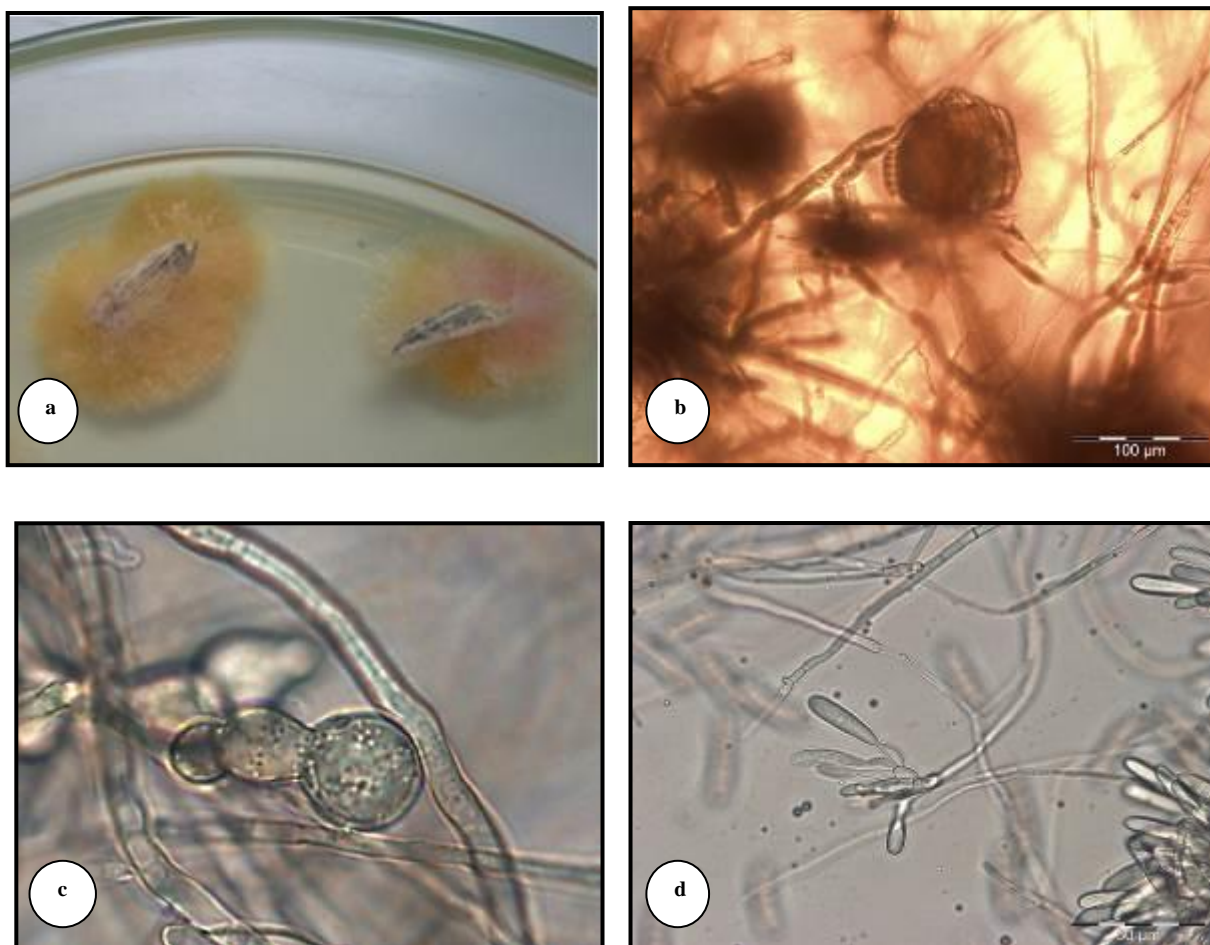
During 2014, in the experimental field of the PI AIRS, BL after two evaluations of the fungicide in untreated control plots a significant disease, *FHB* respectively, was observed in both varieties. However, applied fungicide achieved a high efficiency (table 1). Statistical analysis and standard test of low significant difference (LSD) was performed, wherein all statistical analyses were performed for the risk level 0.05 ( $P=0.05$ ). Data processing using

standard statistical methods has found that there are significant differences between treated and untreated variants.

Table 1. Efficiency of applied fungicide in varieties Orion and Nova Bosanka

Variant	Active substances	Concentration/Unit	Variety	Ce %
Prosaro 250 EC	prothioconazole + tebuconazole	1 Lha <sup>-1</sup>	Orion	90,30
			Nova Bosanka	91,04

Identification and determination of *Fusarium* sp., the development of phytopathogenic fungi under controlled conditions and the identification of all microscopic and macroscopic characteristic of the target species was carried out after isolation and obtaining of two pure culture groups. The first group is determined as *Fusarium culmorum* (W.G. Smith) Sacc. (syn. *Fusarium culmorum* (W.G. Smith) Sacc. var. *cerealis* (Cooke) Wollenw.) (photo 2a-e). Mycelium on PDA is aerial, abundant, cottony textured, light yellow formed after five days at 25°C. Sporodochium is light orange to golden yellow, 1.2-2.0 in diameter. Conidiophores are monophialide type (15.00-20.00 x 3.5-5.0 µm). Microconidia's and mesoconidias are not determined. Macroconidia's are bent on dorsal side, straight or light bent on ventral side, thick walls, short, large, mostly with five (23.0-74.0 x 4.0-9.0 µm), rare with 3-4 (18.0-44.0 x 3.7-8.5 µm) transversely partition. Apical cells are obtuse or rounded, sometimes with a poorly expressed nipple, basal, comma shape or unexpressed foot. Chlamidiospores are rounded or oval (8.0-16.0 µm), smooth walls, brown, individual, in a chain and groups in hyphae and conidia. Sclerotia are not determined.





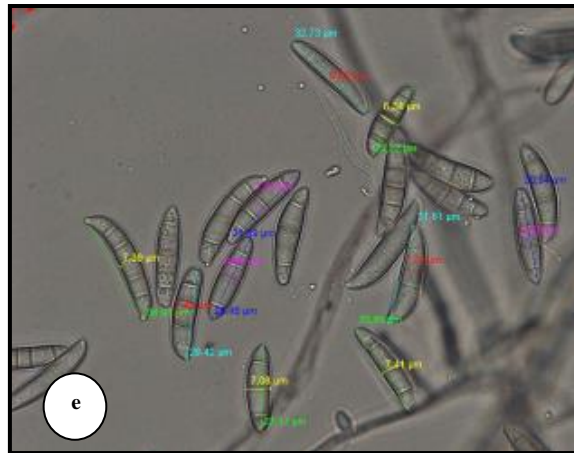
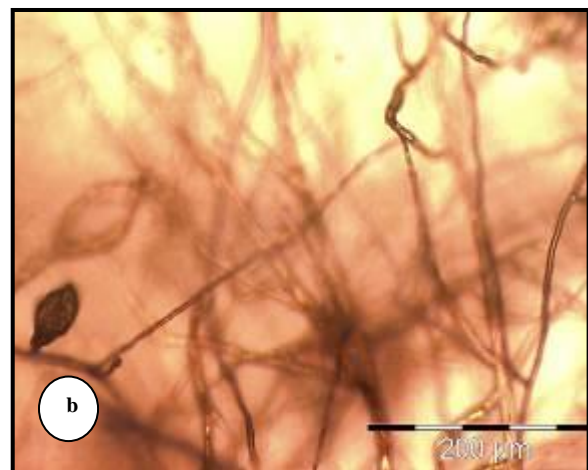


Photo 2. *Fusarium culmorum*: a) Colony development on PDA; b) pure culture in situ; c) Chlamidiospore in chain; d) Conidiophory – monophialide type; e) *Fusarium culmorum* macroconidia's.

The second group is determined as *Fusarium graminearum* Schwabe (syn. *Fusarium graminearum* Schwabe grupa 2 Burgess, Wearing & Toussoun; *Fusarium roseum* Link Snyder & Hansen var. *graminearum* (Schwabe) Snyder & Hansen) (photo 3a-e). Mycelium on PDA is aerial, dense, cottony textured, red to minium red, formed after five days at 25°C. Sporodochium are yellow, orange or red-brown. Conidiophores are monophialide type (15.00-25.00 x 2.5-3.5 µm). Microconidia's and mesoconidias are not determined. Macroconidia's are straight to moderately sickle, uniformly bent on dorsal side, thick walls, with 5-6 transversely partition (28.0-72.0 x 3.2-6.0 µm), rare with 3 (21.0-66.0 x 3.0-6.0 µm) or 4 partition (23.0-59.0 x 3.0-5.8 µm) mostly with 5 (41.0-60.0 x 4.0-5.0 µm). Apical cells are cone-shaped or constricted as a snout, while basal are characteristic foot shape. Chlamidiospores are rounded (8.0-12.0 µm), smooth walls, with no or light brown colour, in chain and exceptionally in group, more often in conidia than in hypha. Sclerotia are small, light brown to red.



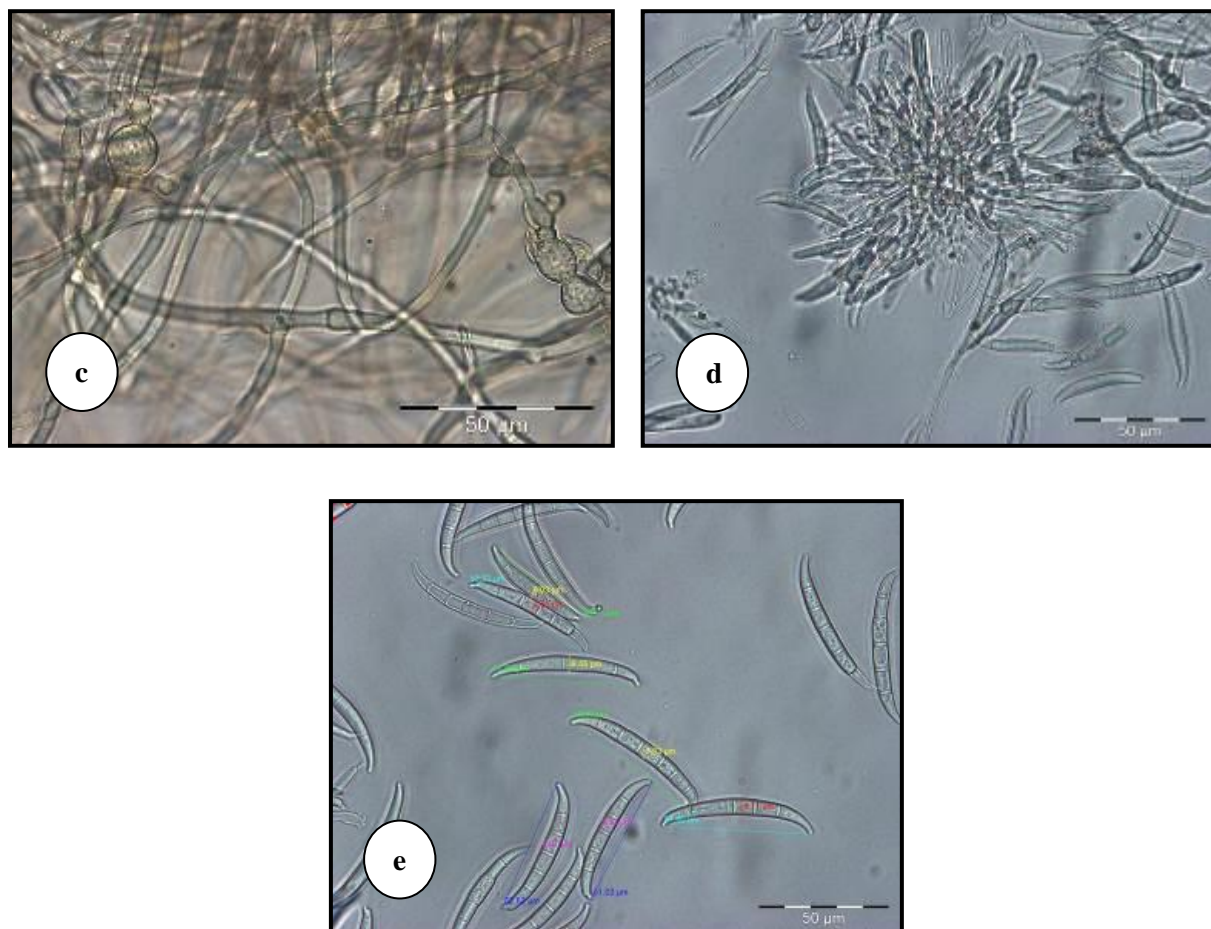


Photo 3. *Fusarium graminearum*: a) Colony development on PDA; b) pure culture in situ; c) Chlamidiospore in chain; d) Conidiophory – monophialide type; e) *Fusarium graminearum* macroconidia's.

### Conclusion

During 2014 high percentage of disease incidence (DI; percentage of diseased ears) and disease severity (DS) of FHB was recorded in the experimental field of the PI AIRS, BL on both varieties (Orion and Nova Bosanka). Mycological analyzes confirmed that the tested varieties in the conditions of natural infection was in high % infected by two *Fusarium* species, *Fusarium graminearum* and *F. culmorum*, respectively. A significant impact on the high-intensity infection of wheat with FHB had extreme rainfall in the spring and floods. However, timely treatment showed high efficiency (>90%), with a small difference in coefficient of efficiency Ce (%) between treated varieties, while higher efficiency was achieved in variety Nova Bosanka.

### References

- Anderson, J. A, (2007). Marker-assisted selection for *Fusarium* head blight resistance in wheat. *International Journal of Food Microbiology*, 119, 51–53.
- Bottalico, A, Perrone, G, (2002). Toxigenic *Fusarium* species and mycotoxins associated with head blight in small-grain cereals in Europe. *Eur. J. Plant Pathol.* 108, 611–624.
- Booth, C, (1971). *The Genus Fusarium*. Commonwealth Mycological Institute, Kew, Surrey, London.

- De Wolf, E. D, Madden, L. V, Lipps, P. E, (2003). Risk assessment models for wheat *Fusarium* head blight epidemics based on within-season weather data. *Phytopathology* 93 (4), 428–435.
- Horberg, H. (2002). Patterns of splash dispersed conidia of *Fusarium poae* and *Fusarium culmorum*. *European Journal of Plant Pathology*, 108, 73–80.
- Lemmens, M, Bürstmayr, H, Krska, R, Schumacher, R, Grausgruber, H, Ruckebauer, P, (2004). The effect of inoculation treatment and long-term application of moisture on *Fusarium* head blight symptoms and deoxynivalenol contamination in wheat grains. *Eur. J. Plant Pathol.* 110, 229–308.
- Lević, J, (2008). Vrste roda *Fusarium* u oblasti poljoprivrede, veterinarske i humane medicine. Institut za kukuruz Zemun polje, Društvo genetičara Srbije Beograd.
- Matthies, A, Buchenauer, H, (2000). Effect of tebuconazole (Folicur) and prochloraz (Sportac) treatments on *Fusarium* head scab development, yield and deoxynivalenol (DON) content in grains of wheat following artificial inoculation with *Fusarium culmorum*. *Zeitschrift für Pflanzenkrankheiten und Pflanzenschutz*, 107, 33–52.
- Miedaner, T, Perkowski, J, (1996). Correlation among *Fusarium culmorum* head blight resistance, fungal colonization and mycotoxin content in winter rye. *Plant Breeding* 115 (5), 347–351.
- Nelson, P. E, Toussoun, T. A, Marasas, W. F. O, (1983), *Fusarium Species - An illustrated manual for Fusarium research*. The Pennsylvania State University Press, University Park and London.
- OEPP/EPPO (1999). Guideline for the efficacy evaluation of plant protection products, phytotoxicity assessment, introduction, general and miscellaneous guidelines. New and Revised Gudeilines 135 (1), 31–36.
- OEPP/EPPO (2012). Guideline for the efficacy evaluation of plant protection products 152, Design and analysis of efficacy evaluation trials, 42 (3), 367–381.
- Parry, D. W, Jenkinson, P, Mcleod, L, (1995). *Fusarium* ear blight (scab) in small grain cereal - A review. *Plant Pathology*, 44, 207-238. doi:10.1111/j.1365-3059.1995.tb02773.x
- Sadowski, Cz, Lenc, L, Wyczling, D, (2011). Effect of the forecrop and fungicidal protection on the occurrence of *Fusarium* head blight (*Fusarium* spp.). *Journal of Plant Protection Research* 51 (1), 44–49.
- Lenc, L, (2015). *Fusarium* head blight (FHB) and *Fusarium* populations in grain of winter wheat grown in different cultivation systems. *Journal of Plant Protection Research* 55 (1), 94–109.
- Stepień, L, Chelkowski, J, (2010). *Fusarium* head blight of wheat: pathogenic species and their mycotoxins. *World Mycotoxin Journal*, 3, 107-119.
- Stepień, Ł, Popiel, D, Koczyk, G, Chelkowski, J, (2008). Wheat-infecting *Fusarium* species in Poland - their chemotypes and frequencies revealed by PCR assay. *J. Appl. Genet.* 49, 433–441.
- Walter, S, Nicholson, P, Doohan, F. M, (2010). Action and reaction of host and pathogen during *Fusarium* head blight disease. *New Phytologist*, 185, 54–66.
- Xu, X. M., Nicholson, P, Thomsett, M A, Simpson, D, Cooke, B. M, Doohan, F. M., Brennan, J, Monaghan, S, Moretti, A, Mule, G., Hornok, L, Beki, E, Tatnell, J, Ritieni, A, Edwards, S. G, (2008). Relationship between the fungal complex causing *Fusarium* head blight of wheat and environmental conditions. *Phytopathology* 98 (1), 69–78.
- Xu, X. M, Nicholson. P, (2009). Community ecology of fungal pathogens causing wheat head blight. *Annual Review of Phytopathology*, 47, 83–103.

## EFFICACY OF NEW HERBICIDES AND HERBICIDE COMBINATIONS ON MILK THISTLE (*SILYBUM MARIANUM* GAERTN.)

Grozi DELCHEV<sup>1\*</sup>, Teodora BARAKOVA<sup>2</sup>

<sup>1</sup>Trakia University, Faculty of Agriculture, 6000, Stara Zagora, Bulgaria

<sup>2</sup>Field Crops Institute, 6200, Chirpan, Bulgaria

\*Corresponding author: delchevgd@dir.bg

### Abstract

The research was conducted during 2013 - 2015 on pellic vertisol soil type. The subject-matter of this research was Bulgarian milk thistle cultivar Silmar (*Silybum marianum* Gaertn.). Factor A included no treated check, 6 soil-applied herbicides – Tender EC (S-metolachlor), Sharpen 33 EC (pendimethalin), Merlin flex 480 SC (isoxaflutole), Smerch 24 EC (oxyfluorfen), Raft 400 SC (oxidiargil), Eagle 75 DF (chlorsulfuron) and 5 foliarly-applied herbicides – Kalin flo (linuron), Eclipse 70 DWG (metribuzine), Sultan 500 SC (metazachlor), Granstar super 50 SG (tribenuron-methyl + tifensulfuron-methyl), Starane 250 EK (fluroxypyr). Factor B included no treated check and 1 antigraminaceous herbicide – Tiger platinum 5 EC (quizalofop-P-ethyl). Combinations of antigraminaceous herbicide Tiger platinum with soil-applied herbicides Tender, Sharpen, Merlin flex, Smerch, Raft and Eagle and foliar-applied herbicides Kalin flo, Eclipse, Sultan, Granstar super and Starane do not reduce herbicide efficacy. Volunteer durum wheat crops in milk thistle crops are successfully controlled with the foliarly-applied herbicide Tiger platinum. The tank mixtures of the antigraminaceous herbicide Tiger platinum with foliar herbicides Kalin flo, Eclipse, Sultan, Granstar super and Starane lead to high seed yield of the milk thistle. High seed yields are also obtained with the foliar treatment with Tiger platinum after soil-applied herbicides Raft, Sharpen and Eagle. The use of the soil-applied herbicides Smerch, Merlin flex and Tender does not increase the seed yield, due to higher phytotoxicity of Smerch and Merlin flex to milk thistle and lower herbicide efficacy of Tender. Sole use of soil-applied or foliarly-applied herbicides leads to lower yields due to the fact that they must be combined for full control of weeds in milk thistle crops.

**Key words:** *Milk thistle, Herbicides, Efficacy, Selectivity, Seed yield*

### Introduction

Although the growing technology is known from 70<sup>s</sup> and 80<sup>s</sup> years of XX century, it was never solved in complex including the plant protection. There is little plant protection products are registered for milk thistle (Khan at al., 2009). Milk thistle has good weed-removing qualities thanks to quick growth and high leaves cover, but decreased competitive ability during germination to extensive growth. Milk thistle itself is often an unpleasant weed for next crops, especially for winter cereals and winter oilseed canola (Delchev, 2015, Delchev and Georgiev, 2015a,b). The most frequent weeds in milk thistle fields are *Sonchus arvensis*, *Elytrigia repens*, *Cirsium arvense*, *Chenopodium album*, *Raphanus raphanistrum*, *Sinapis arvensis*, *Galium aparine*, *Mentha crispa*, *Convolvulus arvensis* и *Atriplex patula* (Czyż, 2008). Weed control is based on mechanical cultivation. Herbicides can be given as soil-applied after sowing before emergence or as foliar-applied during rosette stage of milk thistle (Drapalova and Pluhackova, 2014). The purpose of this investigation was to establish

the efficacy and selectivity of some herbicides, herbicide combinations and herbicide tank mixtures on the milk thistle by influence of different meteorological conditions.

### Materials and methods

During 2013 - 2015 on pellic vertisol soil type was conducted a field experiment. It was carried out a two factor experiment as a block method in 4 repetitions, on a 15 m<sup>2</sup> crop plot. Under investigation was Bulgarian milk thistle cultivar Silmar (*Silybum marianum* Gaertn.). Factor A included no treated check, 6 soil-applied herbicides – Tendar EC, Sharpen 33 EC, Merlin flex 480 SC, Smerch 24 EC, Raft 400 SC, Eagle 75 DF and 5 foliar-applied herbicides – Kalin flo, Eclipse 70 DWG, Sultan 500 SC, Granstar super 50 SG, Starane 250 EK. Factor B included no treated check and 1 antigraminaceous herbicide – Tiger platinum 5 EC. Active substances of herbicides and their doses are shown in Table 1.

Table 1. Investigated variants.

№	Variants	Active substance	Doses	Treatment period
Antibroadleaved herbicides				
1	Check	-	-	-
2	Tendar EC	S-metolachlor	1.5 l/ha	ASBE
3	Sharpen 33 EC	pendimethalin	5 l/ha	ASBE
4	Merlin flex 480 SC	isoxaflutole	420 g/ha	ASBE
5	Smerch 24 EC	oxyfluorfen	1 l/ha	ASBE
6	Raft 400 SC	oxidiargil	1 l/ha	ASBE
7	Eagle 75 DF	chlorsulfuron	20 g/ha	ASBE
8	Kalin flo	linuron	2 l/ha	rosette
9	Eclipse 70 DWG	metribuzine	500 g/ha	rosette
10	Sultan 500 SC	metazachlor	2 l/ha	rosette
11	Granstar super 50 SG	tribenuron-methyl + tifensulfuron-methyl	40 g/ha	rosette
12	Starane 250 EK	fluroxypyr	300 ml/ha	rosette
Antigraminaceous herbicides				
1	Check	-	-	-
2	Tiger platinum 5 EC	quizalofop-P-ethyl	2.5 l/ha	rosette
ASBE – after sowing, before emergence				

All of the herbicides, herbicide combinations and herbicide tank-mixtures were applied in a working solution of 200 l/ha. Mixing of the foliarly-applied herbicides was done in the tank on the sprayer. The soil-applied herbicides were used in the period between sowing and emergence. The foliarly-applied herbicides were used at the rosette stage of the milk thistle. Introduction of herbicide combinations during rosette stage is done as herbicide tank mixtures – the mixing is done in the spray tank. It was investigated efficacy and selectivity of herbicides and their tank mixtures. It was established their influence on seed yield. Efficacy of herbicides against weeds was appointed according to 100 % scale of EWRS (European Weed Research Society). Selectivity of herbicides to milk thistle plants was followed according to the 9-rate scale of EWRS (rating 1 - without damages, rating 9 - crop is completely destroyed). The mathematical processing is done with analysis of variance method.

### Results and discussion

Annual broadleaved weeds in the experiment are represented by *Anthemis arvensis* L., *Chamomilla recutita* Rauchert, *Galium aparine* L., *Sinapis arvensis* L., *Raphanus raphanistrum* L., *Capsella bursa-pastoris* L., *Falopia convolvulus* Leve, *Lithospermum arvense* L., *Papaver rhoes* L., *Consolida regalis* Gray, *Viola tricolor* L., *Myagrurn perfoliatum* L., *Lamium purpureum* L., *Veronica hederifolia* L., *Stellaria media* Cyr. Annual graminaceous weeds are *Avena fatua* L., *Avena ludoviciana* Durien., *Alopecurus myosuroides*

L., *Apera spica-venti* P.B., *Lolium temulentum* L., *Lolium multiflorum* L., *Bromus arvensis* L. Perennial broadleaved weeds are *Cirsium arvense* Scop., *Convolvulus arvensis* L., also single plants of *Cardaria draba* L. and *Sonchus arvensis* L. Perennial graminaceous weeds are represented by *Sorghum helepense* Pers., *Cynodon dactylon* Pers. and more rarely *Agropyrum repens* L. Volunteers are represented by durum wheat (*Triticum durum* Desf.), was grown as predecessor. Soil-applied herbicides Tendar, Sharpen, Merlin flex, Smerch and Raft applied in autumn, during the period after sowing before germination of coriander, are inefficacy against *Cirsium arvense* Scop., *Convolvulus arvensis* L., *Cardaria draba* L. and *Sonchus arvensis* L., because these perennial broadleaved weeds germinate in spring (Table 2). Herbicide Eagle has weak efficacy of 50 % against these weeds. Foliar-applied herbicides Kalin flo, Eclipse and Sultan applied in spring, during the rosette stage of milk thistle, are also inefficacy against perennial broadleaved weeds *Cirsium arvense* Scop., *Convolvulus arvensis* L. and *Sonchus arvensis* L. Foliar-applied herbicide Granstar super is inefficacy only against *Convolvulus arvensis* L., because this perennial broadleaved weed germinate later, after treatment with the herbicides. Herbicide Starane is efficacy only against *Convolvulus arvensis* L. but is inefficacy against other perennial broadleaved weeds.

Table 2. Efficacy of some herbicides against broadleaved weeds at milk thistle according to the 100 % visual scale of EWRS (mean 2013 - 2015).

Herbicides		Weeds	<i>Galium aparine</i>	<i>Chamomilla recutita</i>	<i>Papaver rhoes</i>	<i>Sinapis arvensis</i>	<i>Raphanus raphanistrum</i>	<i>Anthemis arvensis</i>	<i>Capsella bursa-pastoris</i>	<i>Cirsium arvense</i>	<i>Convolvulus arvensis</i>
Antibroadleaved	Antigraminaceous										
-	-	0	0	0	0	0	0	0	0	0	0
	Tiger platinumium – 2.5 l/ha	0	0	0	0	0	0	0	0	0	0
Tendar – 1.5 l/ha	-	85	100	90	90	90	95	100	0	0	0
	Tiger platinumium – 2.5 l/ha	85	100	90	90	90	95	100	0	0	0
Sharpen – 5 l/ha	-	100	100	100	100	100	100	100	0	0	0
	Tiger platinumium – 2.5 l/ha	100	100	100	100	100	100	100	0	0	0
Merlin flex – 420 g/ha	-	100	100	100	100	100	100	100	0	0	0
	Tiger platinumium – 2.5 l/ha	100	100	100	100	100	100	100	0	0	0
Smerch – 1 l/ha	-	100	100	100	100	100	100	100	0	0	0
	Tiger platinumium – 2.5 l/ha	100	100	100	100	100	100	100	0	0	0
Raft – 1 l/ha	-	100	100	100	100	100	100	100	0	0	0
	Tiger platinumium – 2.5 l/ha	100	100	100	100	100	100	100	0	0	0
Eagle – 20 g/ha	-	60	100	100	100	0	100	100	50	50	50
	Tiger platinumium – 2.5 l/ha	60	100	100	100	0	100	100	50	50	50
Kalin flo – 2 l/ha	-	40	100	100	100	100	100	100	0	0	0
	Tiger platinumium – 2.5 l/ha	40	100	100	100	100	100	100	0	0	0
Eclipse – 500 g/ha	-	15	100	100	100	100	100	100	0	0	0
	Tiger platinumium – 2.5 l/ha	15	100	100	100	100	100	100	0	0	0
Sultan – 2 l/ha	-	85	100	100	0	0	100	100	0	0	0
	Tiger platinumium – 2.5 l/ha	85	100	100	0	0	100	100	0	0	0
Granstar super – 40 g/ha	-	65	100	100	100	100	100	100	90	0	0
	Tiger platinumium – 2.5 l/ha	65	100	100	100	100	100	100	90	0	0
Starane – 300 ml/ha	-	100	0	100	100	10	0	100	0	100	100
	Tiger platinumium – 2.5 l/ha	100	0	100	100	10	0	100	0	100	100

Tendar has the weakest efficacy against annual broadleaved weeds. It controls of 100 % only *Chamomilla recutita* Rauchert and *Capsella bursa-pastoris* L. Tendar controls of 85 – 95 % weeds as *Galium aparine* L., *Papaver rhoes* L., *Sinapis arvensis* L., *Raphanus raphanistrum* L., *Anthemis arvensis* L. Soil-applied herbicide Eagle has weaker efficacy of 60 % against *Galium aparine* L. and is inefficacy against *Raphanus raphanistrum* L. Other four soil-applied herbicides - Sharpen, Merlin flex, Smerch and Raft have 100 % efficacy against all

annual broadleaved weeds, which are represented in the experiment. Foliar-applied herbicides Kalin flo, Eclipse and Granstar super are weaker efficacy against *Galium aparine* L. They control this weed from 15 % at Eclipse to 65 % at Granstar super. Herbicide Sultan is inefficacy against *Sinapis arvensis* L. and *Raphanus raphanistrum* L. and has weaker efficacy against *Galium aparine* L. and *Anthemis arvensis* L. Herbicide Starane is inefficacy only against *Chamomilla recutita* Rauchert, and *Anthemis arvensis* L. and has weak efficacy of 10 % against *Raphanus raphanistrum* L.

Table 3. Efficacy of some herbicides against graminaceous weeds and volunteers at milk thistle according to the 100 % visual scale of EWRS and selectivity according to the 9-rate scale of EWRS (mean 2013 - 2015).

Herbicides		Weeds	<i>Avena fatua</i>	<i>Avena ludoviciana</i>	<i>Alopecurus myosuroides</i>	<i>Apera spica-venti</i>	<i>Bromus arvensis</i>	<i>Triticum durum</i> *	<i>Sorghum helepense</i>	<i>Cynodon dactylon</i>	Selectivity
Antibroadleaved	Antigraminaceous										
-	-	0	0	0	0	0	0	0	0	0	1
-	Tiger platinumium – 2.5 l/ha	100	100	100	100	100	100	100	100	100	1
Tendar – 1.5 l/ha	-	0	0	100	100	0	40	(50)	0	0	1
-	Tiger platinumium – 2.5 l/ha	100	100	100	100	100	100	100	100	100	1
Sharpen – 5 l/ha	-	100	100	100	100	0	0	(50)	0	0	1
-	Tiger platinumium – 2.5 l/ha	100	100	100	100	100	100	100	100	100	1
Merlin flex – 420 g/ha	-	100	100	100	100	0	100	(50)	0	0	2
-	Tiger platinumium – 2.5 l/ha	100	100	100	100	100	100	100	100	100	2
Smerch – 1 l/ha	-	0	0	0	0	0	0	0	0	0	3
-	Tiger platinumium – 2.5 l/ha	100	100	100	100	100	100	100	100	100	3
Raft – 1 l/ha	-	100	100	100	100	0	100	(50)	0	0	1
-	Tiger platinumium – 2.5 l/ha	100	100	100	100	100	100	100	100	100	1
Eagle – 20 g/ha	-	0	0	100	100	0	0	0	0	0	1
-	Tiger platinumium – 2.5 l/ha	100	100	100	100	100	100	100	100	100	1
Kalin flo – 2 l/ha	-	0	0	0	0	0	0	0	0	0	1
-	Tiger platinumium – 2.5 l/ha	100	100	100	100	100	100	100	100	100	1
Eclipse – 500 g/ha	-	0	0	100	0	0	0	0	0	0	1
-	Tiger platinumium – 2.5 l/ha	100	100	100	100	100	100	100	100	100	1
Sultan – 2 l/ha	-	100	100	100	100	100	100	0	0	0	1
-	Tiger platinumium – 2.5 l/ha	100	100	100	100	100	100	100	100	100	1
Granstar super – 40 g/ha	-	0	0	0	0	0	0	0	0	0	1
-	Tiger platinumium – 2.5 l/ha	100	100	100	100	100	100	100	100	100	1
Starane – 300 ml/ha	-	0	0	0	0	0	0	0	0	0	1
-	Tiger platinumium – 2.5 l/ha	100	100	100	100	100	100	100	100	100	1

\*- volunteers of durum wheat (*Triticum durum* Desf.)  
 (50) – against *Sorghum helepense* Pers. from seeds only, without *Sorghum helepense* Pers. from rhizomes

Soil-applied herbicides Tendar and Eagle are inefficacy against annual graminaceous weeds *Bromus arvensis* L., *Avena fatua* L., *Avena ludoviciana* Durien. and against perennial graminaceous weeds *Sorghum helepense* Pers. and *Cynodon dactylon* Pers. (Table 3). Tendar has weak efficacy of 40 % against volunteers of durum wheat (*Triticum durum* Desf.) and Eagle is inefficacy against these volunteers. Herbicides Merlin flex and Raft are efficacy against all annual graminaceous weeds except *Bromus arvensis* L. Herbicides Sarpen are efficacy against all annual graminaceous weeds except *Bromus arvensis* L. and volunteers of *Triticum durum* Desf. Herbicides Smerch, Kalin flo, Granstar super and Starane are inefficacy against all annual and perennial graminaceous weeds and volunteers of durum wheat. Herbicides Tendar, Sharpen, Merlin flex and Raft are efficacy against *Sorghum helepense* Pers. by seeds, but are inefficacy against *Sorghum helepense* Pers. by rhizomes. Herbicide Sultan has sufficient efficacy against annual graminaceous weeds and volunteers of durum wheat but it is not efficacy against perennial graminaceous weeds. Herbicide Eclipse has

antigraminaceous effect only against *Alopecurus myosuroides* L. Annual graminaceous weeds are *Avena fatua* L., *Avena ludoviciana* Durien., *Alopecurus myosuroides* L., *Apera spica-venti* P.B., *Lolium temulentum* L., *Lolium multiflorum* L., *Bromus arvensis* L., Perennial graminaceous weeds *Sorghum helepense* Pers., *Cynodon dactylon* Pers. and *Agropyrum repens* L., as well as volunteers of *Triticum durum* Desf. are controlled successfully by foliar-applied antigraminaceous herbicide Tiger platinum. Combinations of Tiger platinum with soil-applied herbicides Tendar, Sharpen, Merlin flex, Smerch, Raft and Eagle and with foliar-applied herbicides Kalin flo, Eclipse, Sultan, Granstar super and Starane do not reduce herbicide efficacy. From those herbicides included in the experiment the use of soil-applied herbicide Smerch and herbicide combination Smerch + Tiger platinum leads to phytotoxicity on milk thistle - rating 3 by scale of EWRS (Table 3). The use of soil-applied herbicide Merlin flex and herbicide combination Merlin flex + Tiger platinum also leads to phytotoxicity on milk thistle - rating 2 by scale of EWRS. Signs of phytotoxicity overcome difficult from milk thistle plants and lead to decrease of seed yield. Soil-applied herbicides Tendar, Sharpen, Raft and Eagle and foliar-applied herbicides Kalin flo, Eclipse, Sultan, Granstar super, Starane and Tiger platinum have high selectivity - rating 1 by scale of EWRS. Experiment data show that the lowest seed yields are obtained by alone application of herbicide Smerch, followed by herbicide Merlin flex and by the untreated control (Table 4). The use of soil-applied herbicides Smerch and Merlin flex do not increase seed yields despite their very good herbicidal effect against both graminaceous and broadleaved weeds. The reason for this is their higher phytotoxicity against milk thistle.

Table 4. Influence of some herbicide combinations on seed yield of milk thistle (2013 - 2015).

Herbicides		2013		2014		2015		Mean	
Antibroadleaved	Antigraminaceous	kg/ha	%	kg/ha	%	kg/ha	%	kg/ha	%
-	-	1009	100	1110	100	956	100	1025	100
	Tiger platinum	1044	103.5	1157	104.2	993	103.9	1065	103.9
Tendar	-	984	97.5	1087	97.9	929	97.2	1000	97.6
	Tiger platinum	1034	102.5	1164	104.9	995	104.1	1064	103.8
Sharpen	-	1077	106.7	1175	105.9	1013	106.0	1088	106.1
	Tiger platinum	1121	111.1	1274	114.8	1086	113.6	1160	113.2
Merlin flex	-	866	85.8	982	88.5	883	92.4	912	89.0
	Tiger platinum	900	89.2	1025	92.3	941	98.4	955	93.2
Smerch	-	812	80.5	925	83.3	838	87.7	858	83.7
	Tiger platinum	850	84.2	968	87.2	902	94.3	907	88.5
Raft	-	1116	110.6	1232	111.0	1054	110.2	1134	110.6
	Tiger platinum	1192	118.1	1312	118.2	1121	117.3	1208	117.9
Eagle	-	1063	105.4	1171	105.2	1011	105.8	1082	105.6
	Tiger platinum	1121	111.1	1265	114.0	1088	113.8	1156	112.8
Kalin flo	-	1096	108.6	1214	109.4	1056	110.5	1122	109.5
	Tiger platinum	1183	117.2	1309	117.9	1131	118.3	1208	117.9
Eclipse	-	1100	109.0	1222	110.1	1052	110.0	1125	109.8
	Tiger platinum	1183	117.2	1318	118.7	1124	117.6	1208	117.9
Sultan	-	1080	107.0	1182	106.5	1021	106.8	1094	106.7
	Tiger platinum	1130	112.0	1279	115.2	1097	114.8	1169	114.0
Granstar super	-	1075	106.5	1171	105.5	1010	105.6	1085	105.9
	Tiger platinum	1130	112.0	1268	114.2	1090	114.0	1163	113.5
Starane	-	1067	105.7	1166	105.0	1010	105.6	1081	105.5
	Tiger platinum	1124	111.4	1265	114.0	1090	114.0	1160	113.2
LSD 5 %		58	5.7	54	4.9	55	5.8		
LSD 1 %		81	8.0	72	6.5	77	8.1		
LSD 0.1 %		110	10.9	99	8.9	105	11.0		



The alone application of soil-applied herbicides Tendar, Sharpen, Raft and Eagle and foliar-applied herbicides Kalin flo, Eclipse, Sultan, Granstar super and Starane increases seed yields because the big numbers of weeds are destroyed by these herbicides. The increases of the yield by alone application of antigraminaceous herbicide Tiger platinum is less than the increase by other herbicides, because prevailing weeds in the trail are broadleaved. Tank mixtures of Tiger platinum with herbicides Kalin flo, Eclipse, Sultan, Granstar super and Starane lead to bigger increase in seed yields compared to yield at alone application of respective herbicides. Foliar treatment with Tiger platinum after soil-applied herbicides Tendar, Sharpen and Raft also increases the seed yields during the three years of the investigation. Herbicide combinations Smerch + Tiger platinum and Merlin flex + Tiger platinum increase seed yields compared to alone application of Smerch and Merlin flex, but not proven increase yields compared to no treated control.

### **Conclusions**

Combinations of antigraminaceous herbicide Tiger platinum with soil-applied herbicides Tender, Sharpen, Merlin flex, Smerch, Raft and Eagle and foliar-applied herbicides Kalin flo, Eclipse, Sultan, Granstar super and Starane do not reduce herbicide efficacy. Volunteer durum wheat crops in milk thistle crops are successfully controlled with the foliarly-applied herbicide Tiger platinum. The tank mixtures of the antigraminaceous herbicide Tiger platinum with foliar herbicides Kalin flo, Eclipse, Sultan, Granstar super and Starane lead to high seed yield of the milk thistle. High seed yields are also obtained with the foliar treatment with Tiger platinum after soil-applied herbicides Raft, Sharpen and Eagle. The use of the soil-applied herbicides Smerch, Merlin flex and Tender does not increase the seed yield, due to higher phytotoxicity of Smerch and Merlin flex to milk thistle and lower herbicide efficacy of Tender. Sole use of soil-applied or foliarly-applied herbicides leads to lower yields due to the fact that they must be combined for full control of weeds in milk thistle crops.

### **References**

- Czyż P. (2008). *Ostropestřec mariánský (Silybum marianum Gaertn.) variabilita růstu a vývoje ve stejných pěstitelských podmínkách*. Bakalářská práce. Mendelu v Brně.
- Delchev, Gr. (2015). *Studies on the chemical control of weeds and volunteers at five field crops - durum wheat (Triticum durum Desf.), winter oilseed canola (Brassica napus L.), oil-bearing sunflower (Helianthus annuus L.), grain maize (Zea mays L.) and grain sorghum (Sorghum bicolor Moench.)*, Habilitation monograph, Stara Zagora, Bulgaria.
- Delchev, Gr., Georgiev, M. (2015). *Achievements and problems in the weed control in oilseed canola (Brassica napus L.)*. Scientific Papers. Series A. Agronomy, Vol. LVIII, 174-180.
- Delchev, Gr., Georgiev, M. (2015). *Achievements and problems in the weed control in common wheat (Triticum aestivum L.) and durum wheat (Triticum durum Desf.)*. Agricultural Science and Technology, 7 (3) 281-286.
- Drapalova, I., Pluhackova, H. (2014). *Effect of herbicide treatment on milk thistle (Silybum marianum Gaertn.) germination*. Conference MendelNet, 19-20 November 2014. Mendel University in Brno, Czech Republic, 33-38.
- Khan, M.A. Blackshaw, R.E. Marwat, K.B. (2009). *Biology of milk thistle (Silybum marianum) and the management options for growers in north-western Pakistan*. Weed Biology and Management, 9 (2) 99–105.

## THE SPECIES OF SUPERFAMILY ICHNEUMONOIDEA – PARASITES OF APHIDOPHAGOUS HOVERFLIES

Vesna KRSTESKA<sup>1\*</sup>, Stanislava LAZAREVSKA<sup>2</sup>

<sup>1</sup>St. Kliment Ohridski University, Scientific Tobacco Institute - Prilep, Department for Tobacco Protection from Diseases, Pests and Weeds, Republic of Macedonia

<sup>2</sup>Ss. Cyril and Methodius University, Faculty of Agricultural Sciences and Food, Skopje, Republic of Macedonia

\*Corresponding author: vkrsteska@yahoo.com

### Abstract

*Aphidophagous hoverflies* are one of the most important predators of *Myzus persicae*. The relationship between laid eggs of hoverflies, up to new emerged adults is very variable factor. Besides abiotic conditions, biotic interactions with other parasites can affect the survival of hoverflies. During tobacco vegetation, in the Prilep area, we applied the following methods: survey of 20 tobacco stalks and survey of 100 tobacco leaves, in 10 days interval. The prime material collected from the nature, further is cultivated and analysed in laboratory.

Were identified seven parasite species from superfamily Ichneumonoidea, emerged from pupae of hoverflies: *Diplazon laetatorius* Fabricius, 1781, *Diplazon* sp. 2, *Diplazon* sp. 3, *Homotropus* sp. 1, *Homotropus* sp. 2, *Sussaba* sp. 1, and *Promethes* sp. 1. The most numerous is the parasitic specie *D. laetatorius*. It was registered as a parasite on: *Sphaerophoria scripta*, *Sphaerophoria rueppelli*, *Episyrphus balteatus*, *Scaeva pyrastris* and *Eupeodes corollae*. *Diplazon* sp. 2, *Diplazon* sp. 3 and *Homotropus* sp. 2 are parasites only on *S. pyrastris*. *Homotropus* sp. 1 is a parasite on: *S. scripta*, *S. rueppelli*, *S. pyrastris* and *E. corollae*. *Sussaba* sp. 1 and *Promethes* sp. 1 are parasites on *S. scripta* and *S. rueppelli*.

From the pupa of Syrphidae is emerges one imago of parasite, that biting hole on rounded side of the pupa. The annual activity of these parasites is synchronized with the maximum availability of the larvae of their hosts. Parasitism occurs later in August, and during September. This data could be useful in implementation of Integral pest management.

**Keywords:** *aphids, Syrphidae, parasites, Ichneumonoidea*

### Introduction

Ichneumonoidea is one of the largest superfamilies and they are found almost in all continents and they are important parasitoids of other invertebrates.

The family Ichneumonidae is highly diverse and abundant, with more than 60000 species and it is cosmopolitan, richer in species in the northern hemispheres than in the tropics. Members in this family have long and thin body, with narrow waist like wasps. Some species are colourful. Adults are active in day time and feed on flowers. Their larvae are either parasitic or hyperparasitic (living parasitically upon a parasite). Many species are parasites (endoparasites and ectoparasites) of plant pests. Some species attack a variety of hosts, they are internal or external parasitoids of insects (lepidopterous, coleopterous and hymenopterous larvae), some species in this family attack spiders.

The species of subfamily Diplazontinae are spread all over the world, and most of it in the Holarctic region where there are 19 genera. Generally stated genera are: *Diplazon*, *Promethes*, *Sussaba*, *Homotropus*, *Syrphoctonus* and others. They are koinobiont endoparasites of Diptera, especially Syrphidae.

According to Gilbert (1986), approximately all the parasites of the hoverflies are wasps and the most of them belong to the subfamily Diplazontinae. The parasite placed egg in either the egg or the larva, and the adult parasitoid emerges from the puparium. Depending on whether the host is uni, oligo or polyvoltine, the parasites synchronize their development with the host's development cycle - the hoverfly.

The wasps can be kept alive for weeks by feeding on a sugar solution. Older animals devour eggs and young syrphid larvae, squeezing them out and sucking up the contents. This uptake of protein food, as in other parasitic hymenoptera, is probably necessary for continuous egg production (Schneider, 1950).

These parasites have great economic significance in the biological struggle from plant pests.

According to Jankowska (2004), the parasitization of hoverflies varied within the years of observation and oscillated from 14.4% to 46.4%. The parasitization by *D. laetatorius* reached 21.7%. Krsteska (2007), state that in the parasitic complex, the parasites of the genus *Diplazon*, during 2003-2005, were represented with 41.46% of *D. laetatorius*, 16.09% of *Diplazon* sp. 2 and 8.78% of *Diplazon* sp. 3.

Wnuk and Wojciechowicz (1993) noted that syrphid larvae which attack *Brevicoryne brassicae* L. were infested from 27% to 40% cit. Jankowska (2004).

Bombasch (1963), state that the parasites of hoverflies destroy from 5 %, to 48 % of their population. According to Adaskkevch (1975), in Moldavia on a cabbage, from May to July, the parasites attacked the hoverflies 30%, but from September to October the percentage increased to 72.78%. On lupine and bean the percentage of parasitization is lower (5.4%).

Pek (1981) noted that larvae of hoverflies are often parasitized, especially from Ichneumonidae 18-70%.

According Resende et al., (2006), the percentage of parasitization of the aphidophagous hoverflies is 27.5%, and according Cheek et al. (1974) it is 50%.

## Material and Methods

### Field research

a. Method of survey of 20 randomly selected tobacco stalks infested with aphids. Tobacco stalks were sampled from the whole area of the trial at 10-days interval, starting from June 1, up to the end of September. The tests were performed on targets tobacco (leaves, tobacco flower and flower seed capsules). 10 checks were made by this method in each of the three years of investigations, i.e. 200 stalks per year, or 600 stalks in total. During investigations, 5813 tobacco leaves were examined in 2003, 5851 in 2004 and 5944 in 2005 or 17608 tobacco leaves in total.

b. Method of Davies- survey of 100 randomly selected tobacco leaves infested with aphids. Tobacco leaves were sampled from the whole area of the trial at 10-days interval, during tobacco vegetation. 10 checks were made by this method in each of the three years of investigations, i.e. 1000 leaves per year, or 3000 leaves in total.

These two methods of analyses are simple and secure to be performed; the advantage of this method is that the data can be collected by one person only.

### Laboratory research

The prime material is collected in the nature, after which it is further nourished, cultivated and analysed under laboratory conditions. The eggs, larvae and pupae of Syrphidae, are placed in special containers and raised until adult ecdyses. Larvae were reared on tobacco leaves infested with *M. persicae* in Petri- dishes.

The pupae which were brought up and those collected were separately placed in test-tubes. Later we have monitored the internal modifications of the pupae, the length of its developing

stadium, the degree of eclosion of imago, the percentage of parasitism and the eclosion of different types of parasites.

Among eclosed parasites derived from the Syrphidae, we have determined their species and their morphological characteristics.

### Results and Discussion

*Aphidophagous hoverflies* are attacked by a wide range of hymenopterous parasites.

During investigations seven species of parasites were identified in the order of Hymenoptera, suborder Apocrita, superfamily Ichneumonoidea, family Ichneumonidae, subfamily Diplazontinae, eclosed from pupae of various hoverflies species:

-from genus *Diplazon* Nees (1818) we have detected: *Diplazon laetatorius* Fabricius (1781), *Diplazon* sp. 2 and *Diplazon* sp. 3.

-from genus *Homotropus* Förster (1868): *Homotropus* sp. 1 and *Homotropus* sp. 2.

-from genus *Sussaba* Cameron (1909): *Sussaba* sp. 1.

-from genus *Promethes* Förster (1868): *Promethes* sp. 1.

The largest group of reared parasitoids belonged to the genus *Diplozon*, of which the most frequent was *D. laetatorius*.

According to Adashkevich (1975), four species of syrphid parasites have been observed in the USSR from the genus *Diplozon*, including *D. laetatorius*, 3 from the genus *Homotropus* and 3 from the genus *Promethes*.

Harizanov, Babrikova (1990), identified seven species of hoverflies parasites in Bulgaria, including *D. laetatorius*.

Resende et al. (2006) and Sánchez (2000), identified three species of hoverflies parasites, including *D. laetatorius*.

Graco (1998), also listed *D. laetatorius* as parasites of aphidophagous hoverflies in Argentina.

Adashkevich (1975), investigate that in Moldova the most numerous parasites of hoverflies is *D. laetatorius*. Also in investigation of Jankowska (2004), the most frequent parasitic species, was *D. laetatorius*.

These parasites are effective enemies of predatory hoverflies. They use koinobiont parasitising strategies. The female insert egg into the host body. We should have in consideration that aphidophagous larva still feeds with aphids and perform its bioregulatory role in the destruction of aphids. Parasite species is activated after the larva of hoverflies is transformed into a pupet stage. Then it destroys the host-hoverfly and ichneumonid adult emerges from the syrphid pupae. In the beginning the pupa of the hoverfly has its specific larval color. Few days later its color becomes more whitish and dull.

If you carefully cut the hoverfly pupa, inside you will notice a one small white larvae of the parasitic specie. Then the pupa turns dark and it is a sign of a parasitism. When the adult of parasite flies (emerge), it chewed large, curved hole in the rounded side of the hoverfly pupa.

These parasites reduced the number of hoverflies larvae. During tobacco vegetation, the number of the parasitized hoverflies was small in July. As the number of larvae feeding in tobacco aphid colonies was increasing, the percentage of parasitized larvae increased. The majority of infested hoverflies larvae were found during September.

*D. laetatorius* is a widespread species of parasite, eclosed from the Syrphidae pupae. It is polyphagous specie and parasitized five species of hoverflies. During investigations, *D. laetatorius* was identified as a parasite on *S. scripta*, *S. rueppelli*, *S. pyrastris* and *E. balteatus* in 2003; *S. scripta*, *S. rueppelli*, *S. pyrastris*, *E. balteatus* and *E. corollae* in 2004; *S. scripta*, *S. rueppelli*, *S. pyrastris* and *E. balteatus* in 2005.

Jankowska (2004) reared *D. laetatorius* from 8 syrphid species.

Adashkevich (1972), reported that the parasite *D. laetatorius* emerged from the pupae of *S. scripta*, *Syrphus corollae* and *Syrphus balteatus*.

Feraru et al. (2004) stated that the parasite *D. laetatorius* emerged from the pupae of *S. scripta*.

After the hoverfly will reach the pupation stage, the parasite *D. laetatorius* emerges in average 10 days in *S. scripta* (5 to 15 days), average 12 days in *S. rueppelli* (7 to 21 days), average 11 days in *E. balteatus* (10 to 14 days), 11 days in *E. corollae*, and 10 days in *S. pyrastris*.

In tobacco fields, appearance of parasitised larvae was first determined on the 3th of August. They were most frequently recorded from 20th August to 15th September and then their number gradually decreased. During our investigations, the earliest registered pupae parasitised with *D. laetatorius* was the pupae of *S. scripta*, on 16.07.2004, and the last one was that of *S. scripta* on 17.09.2004.

During the examination, we found out that from the pupa of the hoverfly flies (emerge) out one parasite which is also found in examination of Resende et al. (2006).

We conclude that the length of the body of the imago is from 4 to 6 mm (Figure 1). Ma et al., (1986), states that the length of the body is 5-6 mm.

**Diplazon sp. 2** in three years investigations it was identified as a parasite of *S. pyrastris*. Development of the parasite from pupation until eclosion lasts 11 to 17 days, in average 14 days. The first occurrence of parasitised larvae was recorded in August 20 and parasitism could be observed until September 17. We conclude that the length of the body of the imago is from 5 to 6.5 mm (Figure 2).

**Diplazon sp. 3** in three years investigations it was identified as a parasite of *S. pyrastris*.

Development of the parasite from pupation until eclosion lasts 11 to 22 days, in average 13 days. The first occurrence of parasitised larvae was recorded in August 20 and parasitism could be observed until September 19. We conclude that the length of the body of the imago is 4 mm (Figure 3).

**Homotropus sp. 1** is polyphagous species and during our trials it was registered as a parasite of four hoverflies species. In tobacco biocenosis it was identified as a parasite on: *S. scripta*, *S. rueppelli*, *S. pyrastris* and *E. corollae* in 2003 and 2004; *S. pyrastris* and *E. corollae* in 2005.

After the hoverfly will reach the pupation stage, the parasite *Homotropus* sp. 1 emerges in 10 to 11 days in *S. scripta* and *S. rueppelli*, 13 days in *S. pyrastris*, and 14 days in *E. corollae*.

The first occurrence of parasitised larvae was recorded in August 18 and parasitism could be observed until September 9. We conclude that the length of the body of the imago is from 4 to 5 mm (Figure 4).

**Homotropus sp. 2** in our investigations it was identified as a parasite of *S. pyrastris* in 2003 and 2004. Development of the parasite from pupation until eclosion lasts 11 to 19 days, in average 14 days. The first occurrence of parasitised larvae was recorded in August 16 and parasitism could be observed until September 7. We conclude that the length of the body of the imago is from 5 to 5.5 mm (Figure 5).

**Sussaba sp. 1** was registered as a parasite of two hoverflies species. In tobacco biocenosis it was identified as a parasite on: *S. scripta* and *S. rueppelli* in 2003 and 2004.

After the hoverfly will reach the pupation stage, the parasite emerges in 12 days in *S. scripta* and *S. rueppelli*. The first occurrence of parasitised larvae was recorded in July 20 and parasitism could be observed until August 15. We conclude that the length of the body of the imago is from 3 to 4 mm (Figure 6).

**Promethes sp. 1** was registered as a parasite of 2 hoverflies species. In tobacco biocenosis it was identified as a parasite on: *S. scripta* and *S. rueppelli* in 2003 and 2004.

After the hoverfly will reach the pupation stage, the parasite emerges in 11 days in *S. scripta* and *S. rueppelli*. The first occurrence of parasitised larvae was recorded in August 20 and

parasitism could be observed until September 4. We conclude that the length of the body of the imago is from 3 to 4 mm (Figure 7).



Figure 1 *D. laetatorius*



Figure 2 *Diplazon* sp. 2

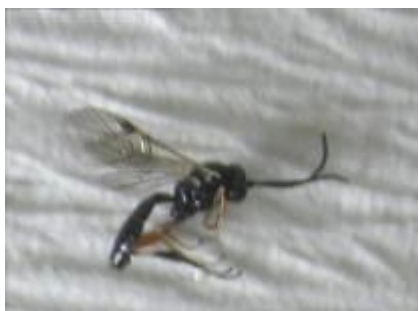


Figure 3 *Diplazon* sp. 3



Figure 4 *Homotropus* sp. 1



Figure 5 *Homotropus* sp. 2



Figure 6 *Sussaba* sp. 1



Figure 7 *Promethes* sp. 1

### Conclusions

Aphidophagous Syrphidae are attacked by a wide range parasitic *Hymenoptera*. During investigations seven parasitic Hymenoptera: *D. laetatorius*, *Diplazon* sp. 2, *Diplazon* sp. 3, *Homotropus* sp. 1, *Homotropus* sp. 2, *Sussaba* sp. 1 and *Promethes* sp. 1 were identified. The dominant species was *D. laetatorius*.

They lay their eggs in the host's body. They are activated after the hoverfly larvae is transformed into the pupa, then the ichneumonid larva eats its host alive. The imago of the parasite flies (emerge) from the puparium of the hoverflies.

The occurrence of parasite depends on the occurrence of host-hoverflies, while the occurrence and development of aphidophagous hoverflies depends on the appearance of green peach aphid on tobacco and climate conditions in the region of Prilep.

### References

- Adashkevich B.P. (1975). Entomophagous insects on vegetable crops Kolos, Moscow. Commonwealth Bureau of Plant Breeding, 190, pp. 88–121.
- Cheek L. R., Notched M. Z., Pine B. A. (1974). *Afidosis Sitobion avenae* (Fab.) and *Metopolophium dirhodum* (Walk), its influence in the yield, location in the natural plant and its enemies. Faculty of Agrarian Sciences of the Austral University of Chile and the Institute of Farming Investigations, Experimental Station Quilamapu. N° Project 74–14, ISSN 0304-8802 printed version South land v.2 n.2 Valdivia julJul. 1974, [mingaonline.uach.cl/scielo.php](http://mingaonline.uach.cl/scielo.php).
- Feraru E., Mustata G. (2004). [www.geocities.com/brisbane\\_wasps/ICHNEUMONIDAE.htm](http://www.geocities.com/brisbane_wasps/ICHNEUMONIDAE.htm).
- Харизанов А., Бабрикова, Т. (1990). Биологична борба срещу непријателите по растенијата. Издателство “Земја“, Софија,
- Gilbert F. S. (1986). Hoverflies, Naturalists' Handbook 5. Cambridge University Press, 1–66, Cambridge, UK.
- Greco C.E. (1997). Specificity and instar preference of *Diplazon laetatorius* (Hymenoptera: Ichneumonidae) parasitizing aphidophagous syrphids (Diptera Syrphidae). *Entomophaga* 42(3): 315–318.
- Jankowska B., 2004. Parasitoids of Aphidophagous Syrphidae occurring in cabbage aphid (*Brevicoryne brassicae* L.) colonies on cabbage vegetables. *Journal of plant protection research*, vol 44, No 4.
- Krsteska V. (2007). *Afidofagni osoliki muvi* (Diptera, Syrphidae) na tutunot vo Prilepsko. Doktorska disertacija, Fakultet za zemjodelski nauki i hrana-Skopje, R. Makedonija.
- Ma Z., Shan D., Qu Y., Gao X. (1986). Natural Enemies of Soybean Aphids. *Shandong Science and Technology*, Press pp. 49–50,74–79,118–119,124–125,129,162–177.
- Pek L.V. (1981). The syrphid fauna of mountain pastures of the steppe belt of the northern slopes of the Kirgizian Ala-Tau. *Ent Issled Kirgizii* 14: 44–52.
- Resende A.L.S., Silva E.E., Silva V.B., Ribeiro R.L.D. (2006). Primeiro Registro de *Lipaphis pseudobrassicae* Davis (Hemiptera:Aphididae) e sua Associaçro com Insetos Predadores, Parasityides e Formigas em Couve (Cruciferae) no Brasil. *Neotropical Entomology* 35(4):551–555.
- Sánchez A. E. (2000). Identificación de Syrphidae Asociados a Cultivo de Importacia Agrícolas y Biología de *Pseudodoros clavatus* (Fabricius). [bibagr.ucla.edu.ve/.../ALEXANDR/FORMAS/HTM](http://bibagr.ucla.edu.ve/.../ALEXANDR/FORMAS/HTM).
- Schneider F. (1950). The development of the syrphid parasitoid *Diplazon fissorius* Grav. in uni-, oligo-, and polyvoltine hosts, and its behaviour during activation of the diapause larvae using *D. pectoratorius* Grav. *Mitt. schweiz. ent. Ges.* 23: 155–194.

## ALLELOPATHIC EFFECTS OF ALIEN INVASIVE PLANTS

Snežana TANASKOVIĆ, Branka POPOVIĆ, Vesna DJUROVIC, Milos MARJANOVIC,  
Goran DRASKOVIC

University of Kragujevac, Faculty of Agronomy, Cara Dušana 34, Čačak, Serbia

\*Corresponding author: stanasko@kg.ac.rs

### Abstract

Plant exudates and secondary metabolites have a variety of biological actions. This is measurable through allelopathic, herbicidal, toxic (human and animal) and insecticidal activity. Allelochemicals are products of plants, algae, bacteria and fungi and affect the growth and development of agricultural crops. Positive and negative effects of plants depend on the allelochemicals' chemical composition, i.e. different compounds released from different plants part (leaves, roots, and stem) with different mechanisms. The aim of this study was to determine the potential allelopathic effects of three widespread invasive species in area of the Čačak city *Ailantus altissima*, *Portulaca oleracea* and *Ambrosia artemisiifolia* on the seed germination under laboratory conditions. The crude ethanolic extracts *A. altissima*, *P. oleracea* and *A. artemisiifolia* were prepared in aqueous solution concentration 0.1%, 1% and 5%. Allelopathic effects were measured by determining of seed germination % of barley and wheat in the exposition to plant extracts. After 96h allelopathic effect of *A. altissima* and *P. oleracea* extract was observed. Extracts of these herbs have demonstrated an inhibitory effect on germination of wheat grains and stimulating the germination of barley grains. Ethanol plant extract of 5% solution *P. oleracea* at the same time had the strongest inhibitory effect on germination of wheat grains and strongest stimulating effect on germination of barley grains. Extracts of *A. artemisiifolia* did not have allelopathic effect in any concentration.

**Keywords:** *Invasive plants*, allelopathy, barley, wheat.

### Introduction

Allelopathy is defined by the Austrian botanist Hans Molisch (1937) and describe the interaction of plants and microorganisms (Siddiqui *et al.*, 2009). This term is origin Greek words: allélon - mutually; pathos - pain. Chemical compounds (allelochemicals) are released from the plants by various mechanisms, from different plant parts as the roots, stem, leaf, and flower. Allelochemicals have their positive and negative effects at environment (Rice 1984). It has been found that the substances that cause allelopathic biochemical interactions between plants represent the products of secondary metabolism (Einhelling, 2004). Allelochemicals has low molecular weight, relatively simple structure and represents volatile substances. They belong to phenolic compounds free-phenols and terpenoids (monoterpenoids, sesquiterpenoid lactones, diterpenes quassinoids, etc.). It is often said that the free phenols have allelopathic effects (Einhelling, 2004). Muller (1966) believes that the sage bushes and diapers produce essential oils that inhibit vice herbaceous plants in the immediate environs. Benzoic and cinnamic acid are commonly referred to as compounds having a primary allelopathic effect in forest ecosystems (Muscolo, 2004), but in asparagus and coffee they have an autoallelopathic effect (Songh *et al.*, 1999; Miller *et al.*, 1991). In plants *Ceratiolia ericoides* Michx, *Centaurea trifolii* Lam., *Robinia pseudoacacia* L., have been found allelopathic flavonoids which inhibit germination (Williamson *et al.*, 1992; Sorbo *et al.*, 2004). Monoterpenes are



volatile compounds and as the main constituents of essential oils exhibit allelopathic effect particularly with aromatic plants in the arid and semi-arid zones (Angelini *et al.*, 2003; Williamson *et al.*, 1989). Several monoterpenes such as camphor, pinene and cineol in pure form or in the essential oil mixtures inhibit the germination or exhibit some other physiological functioning (Angelini *et al.*, 2003; Vokou *et al.*, 2003).

*Ailanthus altissima* (Mill.) Swingle 1916, one in five plant species belonging to the genus *Ailanthus* (Nooteboom, 1962). It is used traditionally in Chinese folk medicine as an astringent, antispasmodic, antihelmitik, narcotic, anti-diarrhea and dysentery, epilepsy, ophthalmic diseases, acne (Hu, 1979; Howard, 2004). *A. altissima* tree produces substances that show inhibitory effects on seed germination and seedling growth (Heisey, 1990). The strongest inhibitory effect shows the bark, especially the root, on the other hand the leaves show moderately (Heisey, 1990). From the root of *A. altissima* has been isolated aylantone, heparin, alantion B and other substances with allelopathic and the phytotoxic effects (Dayan *et al.*, 1999; Callaway, 2000; De Feo *et al.*, 2003). *P. oleracea* belongs to the family Portulacaceae which beside her has another 120 plant species (Azuka *et al.*, 2014). This annual plant is presence around Europe (Movahedian *et al.*, 2007). It is believed that the name of this species comes from the Latin word „porto” meaning wear and „lac” which means milk. *P. oleracea* can be grown in gardens (Loutfy and el Hadidi, 1984). The use of this plant as a vegetable, spice and for medicinal purposes has been known since the ancient Egyptians and was very popular during the middle Ages in England (Azuka *et al.*, 2014). It is characterized by a high nutritional value consisting of vitamins, minerals, fat, carbohydrates, proteins and water (Azuka *et al.*, 2014). It is also used as a vegetable, especially in the Mediterranean area. Its stem and leaves are edible, and have the taste similar to spinach (Liu *et al.*, 2000). *P. oleracea* has wide application in the pharmaceutical industry through the microbiological quality, an antioxidant, an immunological and neurological activity (Azuka *et al.*, 2014). *A. artemisiifolia* is an annual plant species originating in the prairie regions of North America (Brandes and Nitzsche, 2006). It is one of the leading allergens and causes very serious health problems in the human population and significant economic impact on the agricultural yield (Genton *et al.*, 2005). On the territory of Europe considered the weed plant species that causes severe yield losses of sunflower, corn, sugar beets, soybeans and grains (Kazinczi *et al.*, 2008).

The aim of this study was detect effect of plant ethanol extracts of *A. altissima*, *P. oleracea* and *A. artemisiifolia* in different concentration on the germination of wheat and barley in laboratory conditions.

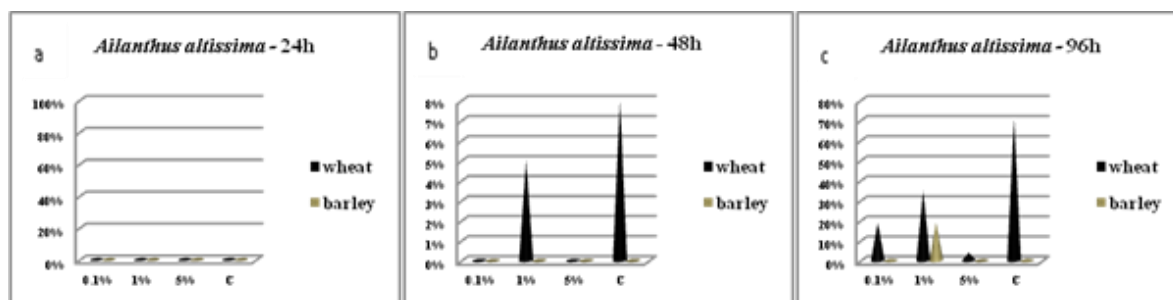
### Material and methods

For the experiment plant ethanol extracts prepared from *A. altissima*, *P. oleracea* and *A. artemisiifolia*. The extracts used were obtained by the process of maceration with ethanol as the solvent. For the preparation of the extract was used 10 g of air dry plant material overflow with 100 mL of ethanol. After 24 hours the solvent was decanted. From initial extract concentration were prepared 0.1%, 1%, and 5% dilution in distilled water and used in the experimental work. For the experiment used a total of 800 seeds per plant crop or 100 seeds per Petri dishes. On the bottom of each jar placed filter paper (Wattman no 1) and 5 mL of extracts or distilled water injected, and Petri dishes filled with seeds of wheat and barley. Inspection of seed germination was done after 24<sup>h</sup>, 48<sup>h</sup> and 96<sup>h</sup> from the experiment settings.

### Results and discussion

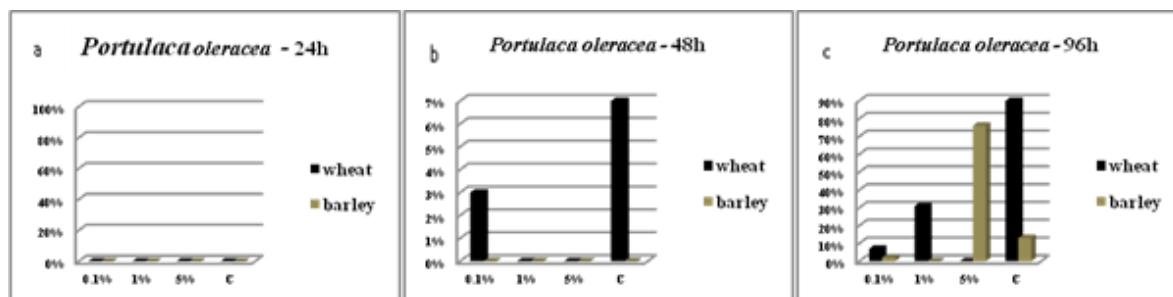
In investigation of seed germination of wheat and barley, during the first inspection after 24<sup>h</sup> (Graph 1a), plant extracts of *A. altissima* showed an inhibitory effect at all three concentration

(0.1%, 1%, 5%). During the second inspection, germination was recorded only on wheat seed. After 48<sup>h</sup> germination of 5% was recorded in the exposure of 1 % of plant extract *A. altissima*. The biggest germination (8%) was recorded in control (Graph 1b). In the last inspection after 96<sup>h</sup> germination was recorded at booth, and wheat and barley seed (Graph 1c). In the exposure 1% *A. altissima* extracts was recorded germination of 35% for wheat and 19% for barley seed. The wheat germination of 19% and 4% was recorded also in exposure 0.1% and 5%, respectively. The plant extracts 0.1% causes germination of 1% at barley seed. The seed germination of 71% and 1% of wheat and barley was recorded in control, respectively.



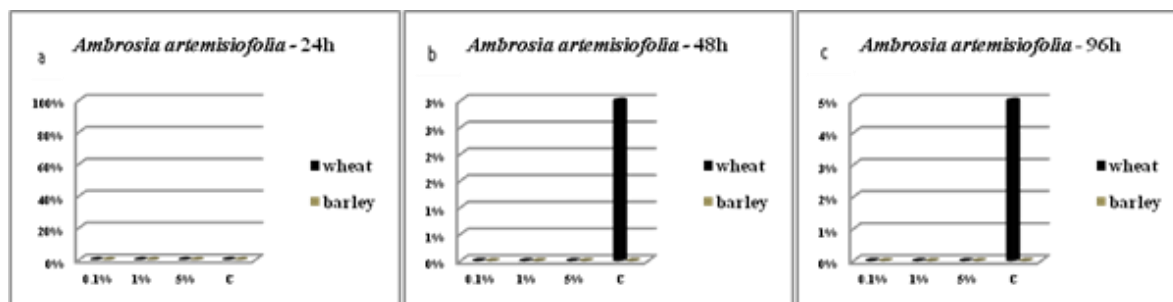
Graph 1. (a, b, c). The influence of plant extracts *A. altissima* (0.1%, 1%, 5% ) on the germination of wheat and barley seed

In investigation of seed germination of wheat and barley, during the first inspection after 24<sup>h</sup> (Graph 2a), plant extracts of *P. oleracea* showed an inhibitory effect at all three concentration (0.1%, 1%, 5%).



Graph 2. (a, b, c). The influence of plant extracts *P.oleracea* (0.1%, 1%, 5% ) on the germination of wheat and barley seed

During the second inspection (48<sup>h</sup>) seed germination of 3% was recorded only on wheat seed (Graph 2b), in exposure of 0.1% *P. oleracea* plant extracts. The biggest seed germination (7%) of wheat was recorded at the control. During the last inspection after 96<sup>h</sup> seed germination was recorded on both wheat and barley (Graph 2c). In exposure 0.1% and 1% was recorded seed germination on wheat seed of 7% and 31%, respectively. Barley seed germination of 2% and 76% was recorded in exposure 0.1% and 5% , respectively (Graph 2c). The seed germination of 83% and 13% on wheat and barley was recorded in control, respectively.



Graph 3. (a, b, c). The influence of plant extracts *A. artemisiifolia* (0.1%, 1%, 5%) on the germination of wheat and barley seed

In investigation of seed germination of wheat and barley (Graph 2a, b, c), during all three inspection after 24<sup>h</sup>, 48<sup>h</sup> and 96<sup>h</sup> plant extracts of *A. artemisiifolia* showed an inhibitory effect at all three concentration (0.1%, 1%, 5%). The barley seed germination of 3% and 5%, was recorded after 48<sup>h</sup> and 96<sup>h</sup> in control, respectively.

### Conclusion

After 96h allelopathic effect of *A. altissima*, *P. oleracea* and *A. artemisiifolia* extract was observed. Extracts of *A. altissima* and *P. oleracea* have demonstrated an inhibitory effect on germination of wheat grains and stimulating the germination of barley grains. Extracts of *A. artemisiifolia* did not have allelopathic effects in any concentration.

### Acknowledgement

This work was carried out in the course of the projects TR031092, funded by the Ministry of Education and Science, Republic of Serbia.

### References

- Angelini, L.G., Carpanese, G., Cioni, P.L., Morelli, I., Macchia, M., Flamini, G. (2003). Essential oils from Mediterranean Lamiaceae as weed germination inhibitors. *J. Agric. Food Chem.*, 51, 6158-6164.
- Azuka, O. I., Ayalokunrin, M. B. and Abu, O.L (2014). A review on *Portulaca oleracea* (Purslane) plant – Its nature and biomedical benefits. College of Health Sciences, Nnamdi Azikiwe University Nnewi Campus, Anambra State, Nigeria. DOI:10.7439/ijbr
- Brandes D. and Nitzsche J. (2006). Biology, introduction, dispersal, and distribution of common ragweed (*Ambrosia artemisiifolia* L.) with special regard to Germany”. ISSN 0027-7479 Institut für Pflanzenbiologie, Technische Universität BraunschweigS. 286-291
- Callaway, R.M., Aschehoug, E.T. (2000). Invasive plants versus their new and old neighbours: a mechanism for exotic invasion. *Science (Washington)*, 290, 521-523.
- Dayan, F.E., Watson, S.B., Galindo, J.C.G., Hernandez, A., Dou, J., McChesney, J.D. (1999). Phytotoxicity of quassinoids: physiological responses and structural requirements. *Pestic.Biochem.Physiol.*,65,15-24.
- De Feo, V., De Martino, L. Quaranta, E., Pizza, C. (2003). Isolation of phytotoxic compounds from tree-of-heaven (*Ailanthus altissima* Swingle). *J. Agric. Food Chem.*, 51, 1177-1180.
- Einhelling, F.A. (2004). Mode of allelochemical action of phenolic compounds. In: *Allelopathy : Chemistry and Mode of Action* (F.A.Macias, J.C.G. Galindo, H.G. Cutler, eds.), CRC Press, Boca Raton Fl., 217-238.

- Genton, B. J., Shykoff J. A. and Giraud, T. (2006). High genetic diversity in French invasive populations of common ragweed, *Ambrosia artemisiifolia*, as a result of multiple sources of introduction. doi: 10.1111/j.1365-294X.2005.02750.x. *Molecular Ecology* 15, 11–18.
- Heisey, R., M. (1990) Allelopathic and Herbicidal Effects of Extracts from Tree of Heaven (*Ailanthus altissima*). *American Journal of Botany* Vol. 77, No. 5, pp. 662-670
- Howard, J.L. (2004): *Ailanthus altissima*. In: Fire Effects Information System, [Online]. US Department of Agriculture, Forest Service, Rocky Mountain Research Station, Fire Sciences Laboratory (Producer). /<http://www.fs.fed.us/database/feis/S>.
- Hu, S.Y. (1979). *Ailanthus*. *Arnoldia* 39, 29–50
- International Allelopathy Society (IAS): Constitution and Bylaws 1996, (2005). [www.ias.usa.es/bylaws.htm](http://www.ias.usa.es/bylaws.htm)
- Liu, L., Howe, P., Zhou, Y.-F., Xu, Z.-Q., Hocart, C., and Zhang, R. (2000). Fatty acids and b-carotene in Australian purslane (*Portulaca oleracea*) varieties. *Journal of Chromatography A*, 893, 207–213.
- Loutfy, B. and Nabil H. M. (1984). The weed flora of Egypt. The American University in Cairo Press. ISBN No. 977-424-038-3.
- Miller, H.G., Ikawa, M., Peirce, L.C. (1991). Caffeic acid identified as an inhibitory compound in asparagus root filtrate. *Hort. Sci.*, 26, 1525-1527.
- Molisch, H. (1937). "Einfluss einer pflanze auf die andere, allelopathie." ISBN: 9783836436854.
- Movahedian, A., Alireza. G., and Mahboobeh, V. (2007). "Hypocholesterolemic effects of purslane extract on serum lipids in rabbits fed with high cholesterol levels." *Int J Pharmacol* 3.3 285-9.
- Muller, C.H. (1966). The role of chemical inhibition (allelopathy) in chemical vegetation composition. *Bulletin of the Torrey Botanical Club*, 93, 332-351.
- Nooteboom, H.P., 1962. Simaroubaceae. *Flora Malesiana*, Ser. 1.6, 193–226.
- Rice E. L. (1984). *Allelopathy*. Second Edition. Academic Press, Orlando. Page Count: 368 ISBN: 9780125870559.
- Siddiqui S., Bhardway S., Khan S. S., Meghvanshi M. K. (2009). Allelopathic Effect of Different Concentration of Water Extract of *Prosopis juliflora* Leaf on Seed Germination and Radicle Length of Wheat (*Triticum aestivum* Var-Lok-1): *American-Eurasian Journal of Scientific Research* 4 (2): 81-84.
- Song, H.K., Ahn, J.K., Ahmad, A., Hahn, S.J., Kim, S.H., Chung, I.M. (2004). Identification of allelochemicals in rice root exudates at various phenological phases and their influence on barnyardgrass. *Allelopathy J.*, 13, 173-188.
- Sorbo, S., Basile, A., Cobianchi, R.C. (2004). Antibacterial, antioxidant and allelopathic activities in bryophytes. *Recent Res. Dev. Phytochem.*, 8, 69-82.
- Swingle WT. (1916). The early European history and the botanical name of the tree-of-heaven, *Ailanthus altissima*. *Journal of the Washington Academy of Sciences* 6:409\_498.
- Vokou, D., Douvli, P., Blionis, G.J., Halley, J.M. (2003). Effects of monoterpenoids, acting alone or in pairs, on seed germination and subsequent seedling growth. *J. Chem. Ecol.*, 29, 2281-2301.
- Williamson, G.B., Fischer, N.H., Richardson, D.R., De la Pena, A. (1989). Chemical inhibition of fire-prone grasses by fire-sensitive shrub, *Cindarina canescens*. *J. Chem. Ecol.*, 15, 1567-1577.
- Williamson, G.B., Obee, E.M., Weidenhamer, J.D. (1992). Inhibition of *Schizachyrum scoparium* (Poaceae) by the allelochemical hydrocinnamic acid. *J. Chem. Ecol.*, 18, 2095-2105.

## A BIOCHEMICAL AND THERMO-RHEOLOGICAL ANALYSIS OF SPANISH ARTISAN CHEESE

Lorena PIÑEIRO<sup>1\*</sup>, Clara A. TOVAR<sup>2</sup>, Inmaculada FRANCO<sup>1</sup>

<sup>1</sup>Food Technology, Faculty of Science, Campus As Lagoas s/n, 32004 Ourense, University of Vigo, Spain

<sup>2</sup>Applied Physics Department, Faculty of Science, Campus As Lagoas s/n, 32004 Ourense, University of Vigo, Spain

\*Corresponding author: lopineiro@uvigo.es

### Abstract

Spain has a long cheese making tradition and a wide variety of traditional cow, goat and ewe cheeses. The dairy sector is strategic in the Spanish agri-food industry due to its economic relevance and its contribution to the development of the rural population. Afuega'l Pitu is a popular artisan cheese from Asturias (northern Spain) protected with PDO (Protected Designation of Origin) since 2004. It is made with pasteurized milk from Friesian and Asturian Valley breeds, and their crosses, fed by traditional diet. The aim of this study was to analyze biochemical and thermo-rheological characteristics of *Roxu* variety of Afuega'l Pitu ripened for 30 days. Eight batches (R1-R8) of PDO cheesemakers were studied. From stress sweeps at 1Hz and 20°C, the highest significant differences in stress ( $\sigma_{max}$ ) and strain ( $\gamma_{max}$ ) amplitude values were between R5 and R8 ( $\sigma_{max}=885\pm 89$  vs  $177\pm 18$  Pa;  $\gamma_{max}=0.283\pm 0.035$  vs  $0.347\pm 0.022\%$ ), respectively. This could be explained based on the moisture-protein ratio (MPR), being the lowest for R5, resulting in a more brittle network due to a greater casein packing, and the highest for R8, producing a weaker and more deformable casein gel. Thermal profiles, obtained using dynamic thermo-mechanical analysis, showed casein matrices with a solid-like character ( $G' > G''$ ) from 20 to 90°C. Specifically, from  $T > 60^\circ\text{C}$   $\tan\delta$  decreased with increasing temperature for all samples, showing a specific heat-induced gelation, compatible with the softening of cheeses at high temperature.

**Key words:** Compositional parameters, Thermo-rheological properties, Afuega'l Pitu cheese, Spain.

### Introduction

Afuega'l Pitu cheese is made in the north of Spain (Asturias) from pasteurized cow's milk by predominantly acid coagulation. It is protected with a Denomination of Origin (PDO) since 2004 (Commission Regulation (EC) No. 723/2008). There are four varieties according to its form, troncoconic (*atroncau*) or pear shape (*trapu*), and its colour, with (*roxu*) or without (*blancu*) paprika added. The elaboration is a slow process resulting in a soft paste which becomes gradually harder during ripening. The milk used is obtained from healthy cows of Friesian and Asturian Valley breeds and their crosses, belonging all of them to the region of the Principado de Asturias. Feeding of livestock is based on traditional practice, grazing of dairy herds throughout the year and supplementing with fresh grass, hay and silage from the farms themselves. The delimited territory is characterized by large areas of natural meadows due to abundant rainfall and soft temperatures throughout the year. Management is based mainly on a semi-stabling system, in which the animals remain in the pasture during most of the day and in the evening are collected for milking (MAPAMA, 2016).

This type of cheese is an acid milk gel made at pH near to the isoelectric point of caseins, resulting in a particulate gel (coarse-structured) formed by aggregation of casein micelles of heterogeneous size distribution (Fox *et al.*, 2000; Rao, 2007). The structure of the gel may be

affected by different cheesemaking conditions during manufacturing (rennet dose, coagulation temperature, consistency of the curd, kneading time, etc.) (Lucey *et al.*, 2005). The rheological properties of cheese are quality attributes that are important to the manufacturer and consumer (Fox *et al.*, 2000). Previous studies have analyzed microbiological and biochemical changes during ripening (Cuesta *et al.*, 1996). However, to date no research has been reported regarding rheological parameters of Afuega'l Pitu cheese (PDO). The aim of this work was to analyze the viscoelastic and biochemical parameters of *Atroncau roxu* variety of Afuega'l Pitu cheese (PDO) made by different manufactures at fixed ripening time.

## Material and Methods

### Sampling

Two batches of cheese were produced by eight different farms of Asturias following the PDO indications and ripened for 30 days. Each sample was split into two halves; one was ground and held in an air-tight container at -40 °C until biochemical analysis, while the other was directly subjected to the rheological test on the same day.

### Biochemical determinations

Moisture, ash, fat and protein content and pH were analyzed according to the standards described by Bargiela *et al.* (2012).

### Rheological determinations

The viscoelastic tests were performed with a Haake RS600 controlled stress rheometer (Thermo Electron, Corp. Germany) using parallel-plate geometry (20 mm diameter and 1 mm gap). The samples were tempered at 20 °C and allowed to rest for 15 minutes to achieve thermal and mechanical equilibrium prior to the start of the measurement. The temperature was controlled to within 0.1 °C using a Peltier element on the lower plate. Viscoelastic parameters in the linear viscoelastic (LVE) range were obtained from stress sweeps at 1Hz and 20 °C from the initial shear stress ( $\sigma_i= 75$  Pa) to final stress ( $\sigma_f= 4,700$  Pa). Temperature sweeps were performed at 0.1 Hz at fixed strain  $\gamma= 0.1\%$  within the LVE range at 1 °C/min from 25 to 90 °C.

### Statistical analysis

Biochemical data were subjected to an analysis of variance (ANOVA) using the General Linear Model procedure of the computer programme Statistica<sup>®</sup> 8.0 for Windows (Statsoft Inc., Tulsa, OK, USA). A Tukey HSD test (significance level of  $P<0.05$ ) was performed to compare the mean values by the different cheeses. Statistical correlations between the biochemical and viscoelastic parameters were determined by multiple regression with confidence intervals of 95% ( $P<0.05$ ), 99% ( $P<0.01$ ) and 99.9% ( $P<0.001$ ), by the use of the same statistical program. Stress sweeps were shown as mean values of five independent measurements and the expanded uncertainty limit (EUL) was calculated as the maximum and the minimum deviation from the mean value. Temperature sweep were presented as the mean values of at least three independent measurements.

## Results and Discussion

### Biochemical parameters

The values of the physicochemical parameters for the eight samples (R1–R8) (Table 1) were within the specification for the Afuega'l Pitu PDO, and similar to the obtained for Cuesta *et al.* (1996) for the same type of cheese. However, slight differences were found among samples as a consequence of the different cheesemaking conditions during manufacturing

(rennet dose, coagulation temperature, consistency of the curd, kneading time, etc.). These factors could influence in the curd moisture content and pH (Lucey *et al.*, 2005). All samples showed pHs near to the isoelectric point (pI~ 4.6) (Table 1), thus, a significant demineralization of the casein micelles was produced (Le Graët and Gaucheron, 1999; Phadungath, 2005). Differences among samples in the pH attained may be affected by the buffering capacity of the milk and curd (Fox *et al.*, 2000). As regards to moisture content, samples R4 and R5 showed a significant ( $P<0.05$ ) lower amount and R8 had the highest moisture content (Table 1). These changes could be caused by different conditions of drainage time between cheesemakers. Ash, fat and protein contents were similar than those reported by Cuesta *et al.* (1996) and for other cow's milk acid coagulated cheeses (Arenas *et al.*, 2014).

Table 1. Biochemical parameters of Afuega'l Pitu cheese.

Sample	pH	Moisture <sup>1</sup>	Ash <sup>2</sup>	Fat <sup>2</sup>	Protein <sup>2</sup>	MPR
<b>R1</b>	4.28±0.02 <sup>a</sup>	39.28±0.52 <sup>a</sup>	2.80±0.05 <sup>a</sup>	52.70±0.30 <sup>a</sup>	36.22±0.59 <sup>ab</sup>	1.09±0.03 <sup>a</sup>
<b>R2</b>	4.46±0.02 <sup>b</sup>	44.33±0.83 <sup>b</sup>	4.56±0.16 <sup>b</sup>	51.18±0.94 <sup>bc</sup>	36.29±0.41 <sup>ab</sup>	1.22±0.03 <sup>b</sup>
<b>R3</b>	4.84±0.04 <sup>c</sup>	39.59±0.50 <sup>a</sup>	3.15±0.02 <sup>c</sup>	52.71±0.44 <sup>a</sup>	36.76±0.39 <sup>b</sup>	1.08±0.01 <sup>a</sup>
<b>R4</b>	4.29±0.02 <sup>a</sup>	36.85±1.77 <sup>c</sup>	3.32±0.10 <sup>c</sup>	50.05±0.33 <sup>b</sup>	35.32±0.50 <sup>c</sup>	1.04±0.06 <sup>a</sup>
<b>R5</b>	4.22±0.01 <sup>d</sup>	36.52±0.14 <sup>c</sup>	3.53±0.06 <sup>de</sup>	49.97±1.25 <sup>b</sup>	37.84±0.17 <sup>d</sup>	0.97±0.00 <sup>c</sup>
<b>R6</b>	4.13±0.01 <sup>e</sup>	38.20±0.27 <sup>a</sup>	3.33±0.02 <sup>cd</sup>	51.40±0.58 <sup>cd</sup>	35.14±0.25 <sup>c</sup>	1.09±0.01 <sup>a</sup>
<b>R7</b>	4.39±0.03 <sup>f</sup>	45.71±1.54 <sup>b</sup>	4.39±0.27 <sup>b</sup>	52.77±0.53 <sup>d</sup>	33.58±0.52 <sup>e</sup>	1.36±0.06 <sup>d</sup>
<b>R8</b>	4.58±0.01 <sup>g</sup>	50.24±0.22 <sup>d</sup>	3.69±0.02 <sup>e</sup>	55.07±0.57 <sup>e</sup>	35.69±0.14 <sup>ac</sup>	1.41±0.01 <sup>d</sup>

<sup>1</sup> g/100 g cheese; <sup>2</sup> g/100 g TS; MPR: moisture:protein ratio; <sup>a-g</sup> Different letters in the same column indicate significant differences ( $P<0.05$ ).

#### Linear viscoelastic range

Stress sweeps were carried out to determine the LVE range in terms of stress ( $\sigma_{max}$ ) and strain ( $\gamma_{max}$ ) amplitudes. As consequence of slow acid-induced gels the colloidal calcium phosphate (CCP) was solubilized thus, the casein micelles were destabilized. Moreover, the production of lactic acid (pH decrease ~ pI) reduced the intermicellar repulsive forces promoting the micellar aggregation into a more compacted system (Fox *et al.*, 2000). In all samples, the loss of  $Ca^{2+}$  ions produced a less cohesive micellar network (Hui *et al.*, 2006) which explains the low values of  $\gamma_{max}< 0.35\%$  (Table 2) comparing with those obtained by rennet-induced coagulation ( $\gamma_{max}> 0.60\%$ ) at similar ripening time (Bargiela *et al.*, 2012). Thus, the resulting acid gels exhibited a lower conformational flexibility (low  $\gamma_{max}$ ). This fact is consistent with the high values of complex modulus ( $G^*$ ) for R1–R7 samples (Table 1), indicating a greater cross-linking density in the casein network.

Table 2. Viscoelastic parameters in the linear viscoelastic (LVE) range for different commercial producers (R1– R8) at 1Hz and 20 °C.

Sample	$\sigma_{max}$ (Pa)	$\gamma_{max}$ (%)	$G^*$ (kPa)	$\delta$ (°)
R1	571±57 <sup>e</sup>	0.180±0.018 <sup>e</sup>	314±27 <sup>e</sup>	16.00±0.21 <sup>ab</sup>
R2	323±32 <sup>b</sup>	0.204±0.035 <sup>ade</sup>	174±20 <sup>bc</sup>	15.85±0.19 <sup>ac</sup>
R3	424±42 <sup>cd</sup>	0.203±0.021 <sup>ade</sup>	210±21 <sup>cd</sup>	15.58±0.27 <sup>ac</sup>
R4	735±73 <sup>f</sup>	0.320±0.096 <sup>abc</sup>	245±68 <sup>cde</sup>	16.26±0.11 <sup>b</sup>
R5	885±89 <sup>f</sup>	0.283±0.035 <sup>b</sup>	326±43 <sup>e</sup>	16.37±0.32 <sup>b</sup>
R6	516±52 <sup>de</sup>	0.235±0.013 <sup>bd</sup>	221±12 <sup>d</sup>	15.56±0.20 <sup>c</sup>
R7	415±42 <sup>c</sup>	0.270±0.024 <sup>b</sup>	156±14 <sup>d</sup>	15.30±0.25 <sup>c</sup>
R8	177±18 <sup>a</sup>	0.347±0.022 <sup>c</sup>	51±3.1 <sup>a</sup>	15.87±0.13 <sup>a</sup>

<sup>a-f</sup> Different letters in the same column indicate significant differences  $P < 0.05$  among samples.

The only exception was the R8 sample, which exhibited the lowest rigidity in the micellar network (minor  $G^*$ ) in line with the lowest conformational stability (minimum  $\sigma_{max}$ ) (Table 2). This result could be related with the greatest moisture content and the subsequent highest MPR (Table 1). Thus, the R8 gel network showed a more hydrated structure preserving similar solid-like character ( $\sim$  phase angle,  $\delta$ ) than the other samples (Table 2). These trends were assessed by bivariate Pearson correlation coefficient, that showed high negative correlations between  $MPR-\sigma_{max}$  (-0.81\*\*\*) and  $MPR-G^*$  (-0.86\*\*\*). In addition, R8 sample showed the highest fat content (Table 1), which might act as a filler phase disrupting the characteristic continuity of the solid phase in the casein matrix, that could also explain the lowest  $G^*$  and  $\sigma_{max}$  values (Table 2).

#### Temperature sweeps

The thermal response of the viscoelastic modulus was obtained by dynamic-mechanical thermoanalysis (DMTA), to study the thermal profile. All samples exhibited the same thermal pattern showing a solid-like character (storage modulus,  $G' >$  viscous modulus,  $G''$ ) from 20 to 90°C (Figure 1).

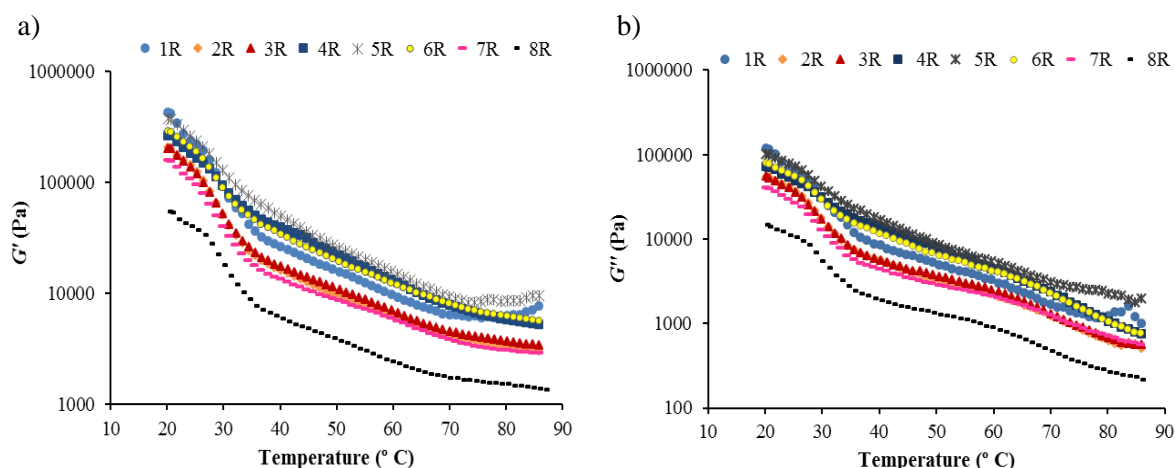


Figure 1. Thermal profile of Afuega'l Pitu samples (a) storage modulus ( $G'$ ), (b) loss modulus ( $G''$ ).

It was observed that  $G'$  decreased more remarkably up to 75 °C, and at  $T > 75$  °C it decreased more slightly (Figure 1a). However,  $G''$  decreased almost continuously up to 90 °C (Figure 1b). This result could be explained considering the breakage of polar interactions and



hydrogen bonds in the micellar network, and at the same time the melting of the fat (20-40 °C). At high temperature the reinforcement of hydrophobic interactions could explain the minor decrease of  $G'$ . The greater weakness of R8 casein matrix, analysed above, was reflected in the notably lower values of both  $G'$  and  $G''$  in all temperature ranges (Figure 1), without changes in the thermal profile pattern. This thermal response was also visible in the behavior of loss factor ( $\tan\delta$ ) by increasing the temperature (Figure 2), whose pattern was similar for all samples. According to the higher decrease of  $G'$  respect to  $G''$  from 20 to 35 °C,  $\tan\delta$  increased up to ~ 35 °C (Figure 2), indicating some weakening of the overall elasticity in the protein network because of the increase in the viscous component. From 40 to 60 °C there was found a plateau zone, consequence of the similar thermal decrease of both  $G'$  and  $G''$ , which reflects the increase in the internal mobilization of the casein fragments in the micellar network (Tunick, 2010).

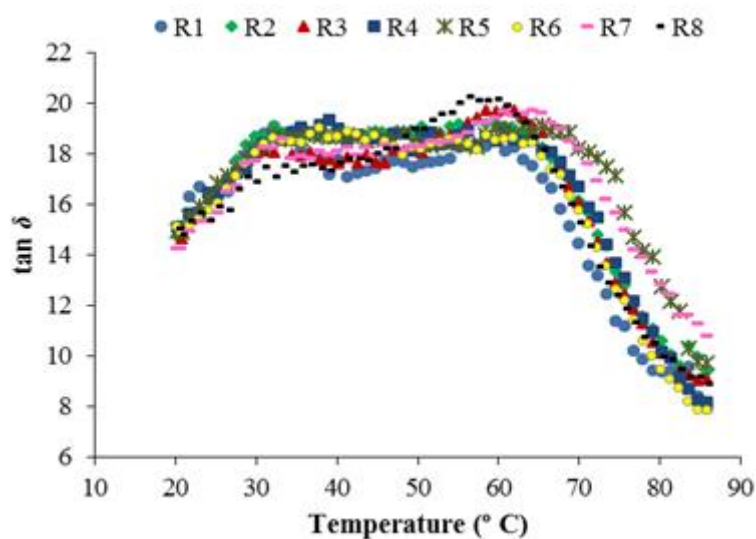


Figure 2. Thermal profile of Afuega'l Pitu cheese. Changes in  $\tan\delta$ .

Finally, from  $T > 60$  °C  $\tan\delta$  decreased with increasing temperature for all samples (Figure 2), indicating that the viscous component ( $G''$ ) decreased to a greater extent than the elastic component ( $G'$ ) (Figure 1). This fact indicates that an increase of the fluidity combined with the high hydrophobic resistance, produced a net reinforcement of the gel-like property at high temperature.

### Conclusions

In general, Afuega'l Pitu cheeses exhibited a firm and low deformable texture. The moisture and fat contents were determinant to distinguish the lower conformational stability and the higher softness in the R8 micellar network comparing with R1–R7. At high temperatures all samples exhibited a notable increase in the solid-like character up to ~90 °C, showing a peculiar heat-induced gelation, compatible with the thermal softening of the heated cheeses.

### Aknowledgement

This work was financially supported by the Xunta de Galicia (Consolidation and Structuring of Competitive Research Units-Strategic Groups Mode, 2009/060). The authors would like to thank to the cheese makers of Afuega'l Pitu for their contribution to the study.

## References

- Arenas, R., González, L., Sacristán, N., Tornadijo, M.E., Fresno, J.M. (2014). Compositional and biochemical changes in Genestoso cheese, a Spanish raw cow's milk variety, during ripening. *Journal of the Science of Food and Agriculture*, 95 (4): 851–859.
- Bargiela, V., Franco, I., Tovar, C.A. (2012). Queso San Simón da Costa (DOP). Editorial Académica Española, Germany.
- Cuesta, P., Fernández-García, E., González de Llano, D., Montilla, A., Rodríguez, A. (1996). Evolution of the microbiological and biochemical characteristics of Afuega'l Pitu cheese during ripening. *Journal of Dairy Science*, 79 (10): 1693–1698.
- Fox, P.F., Guinee, T.P., Cogan, T.M., McSweeney, P.L.H. (2000). *Fundamentals of cheese science*, Aspen Publishers Inc., Maryland.
- Hui, Y. H., Cross, N., Kristinsson, H. G., Lin, M. H., Nip, W. K., Siow, L. F., Stanfield, P.S. (2006). In *Food biochemistry & food processing* (Hui, Y.H., ed.), pp. 351–378, Blackwell Publishing, New Jersey.
- Le Graët, Y., Gaucheron, F. (1999). pH-induced solubilization of minerals from casein micelles: influence of casein concentration and ionic strength. *Journal of Dairy Research*, 66 (2): 215–224.
- Lucey, J.A., Mishra, R., Hassan, A., Johnson, M.E. (2005). Rheological and calcium equilibrium changes during the ripening of Cheddar cheese. *International Dairy Journal*, 15 (5): 645–653.
- Lucey, J.A., Singh, H. (2003). In *Advanced Dairy Chemistry*, 3rd Edition. Part B, (Fox, P.F., and McSweeney, P.L.H., eds.), Vol. 1 Proteins, pp. 1001–1025, Kluwer Academic/Plenum Publishers, New York.
- MAPAMA, 2016. Pliego de condiciones D.O.P. Afuega'l Pitu. Ministerio de Agricultura y Pesca, Alimentación y Medioambiente (MAPAMA). [Specification of Afuega'l Pitu P.D.O. Ministry of Agriculture and Fisheries, Food and Environment (MAPAMA)] [http://www.mapama.gob.es/es/alimentacion/temas/calidad-agroalimentaria/calidad-diferenciada/dop/queso\\_lacteo/DOP\\_Afuega.aspx](http://www.mapama.gob.es/es/alimentacion/temas/calidad-agroalimentaria/calidad-diferenciada/dop/queso_lacteo/DOP_Afuega.aspx).
- Phadungath, C. (2005). The mechanism and properties of acid-coagulated milk gels. *Songklanakarin Journal of Science and Technology*, 27 (2): 433–448.
- Rao, M.A. (2007). *Rheology of fluid and semisolid foods. Principles and applications*, 2nd edn., Springer, New York.
- Tunick, M.H. (2010). Activation energy measurements in rheological analysis of cheese. *International Dairy Journal*, 20 (10): 680–685.

## PROTEIN CONTENT AND TOTAL AMINO ACID PROFILE OF THE MUSCLE AND SKIN OF THE EUROPEAN EEL (*Anguilla anguilla*)

Lucía GÓMEZ-LIMIA\*, Noemi COBAS, Raúl BORRAJO, Sidonia MARTÍNEZ, Inmaculada FRANCO

Food Technology, Faculty of Science, Campus As Lagoas s/n, 32004 Ourense, University of Vigo, Spain

\*Corresponding author: lugomez@uvigo.es

### Abstract

The European eel (*Anguilla anguilla*) is of great commercial importance in Spain and Portugal, as part of their traditional gastronomy. However, it can also be found in different European areas, from Norway to the Mediterranean coast. The protein content of fish can change according to the species, sex, age, nutritional status, season, among others. Protein provides nitrogen and amino acids necessary for the synthesis of new proteins and other important compounds. In any case, fish is considered a good source of high-quality protein. This quality is measured as a function of the proportion of essential amino acids that form them. Several authors write about amino acid profiles of different species. However, there are not enough data about the nutritional value of eels. The aim of this work was to determine the amino acid composition in the muscle and skin of the European eel. All samples weighed between 10 to 100 g. The head and the thorn were removed. The skin and muscle were used to measure the protein content and amino acid profile. The protein content was assessed by the Kjeldahl procedure, and the total amino acids were determined according to Franco *et al.* (2010). Significant differences ( $P < 0.001$ ) were found in the protein content between the muscle and the skin ( $19.54 \pm 0.54$  % and  $23.42 \pm 1.50$  %, respectively). The major essential amino acid in both the muscle and skin was leucine. The major non-essential amino acids in the muscle and the skin were glutamic acid and glycine, respectively, and the minor amino acids were proline and methionine.

**Key words:** Food composition, European eel, Protein, Amino acid profile, Nutritional value.

### Introduction

European eel (*Anguilla anguilla*) belongs to the anguilliform order. It is present in European and African rivers and oceans. Eel is a very valued fish and very important economically and ecologically. In the last decades its production decreased, because of this sometimes it get an enormous price. The populations of eel have declined and it is now classified as ‘critically endangered’ according to the International Union for Conservation of Nature. The composition of the fish varies between individuals of the same species. It depends on the age, sex, environment and season of the year (Ordóñez and la Hoz, 1999). The nutritional value of the fish is given by the quantity and quality of protein. It is therefore important to know the amino acid composition of the European eel. The European eel can be consumed in different forms. Sometimes, with skin and sometimes only the muscle. It is therefore important to know the composition of amino acids in both, muscle and skin.

Fish proteins have got a good nutritive value because of their content in essential amino acids. These are useful in maintaining health and prevention of cardiovascular, immune and others diseases (Venugopal, 2008). Amino acids are synthesized in the liver except the essential amino acids. These have to be supplied by the diet (Gökoğlu and Yerlikaya, 2015). Amino

acids are important for the nutritional value but they are also important for sensory quality of seafood (Aristroy and Toldrá, 2009). The relationship between essential and non-essential amino acids determines the nutritional value of a food (Ibegbulem *et al.*, 2013). The amino acid content of fish has a higher nutritional value than amino acid content of beef or milk (Belitz *et al.*, 2009). European eel is a good source of glutamic acid and aspartic (Banca Dati di Composizione -BDA-, 2017; United States Department of Agriculture -USDA-, 2017). The aim of this work was to determine the amino acid composition in the muscle and skin of the European eels.

## Material and Methods

### Samples and analytical methods

Eels were captured in the Pontecesures region (Galicia, northwest of Spain). The eels used for this study were 10-100 g weighting. They were stored at -20 °C until their analysis. The head and the thorn were removed. The muscle and skin were analysed to measure the protein content separately. Protein content was evaluated by Kjeldahl method, according to AOAC method (Horwitz, 2000), using 6.25 as a factor to convert percent N to percent crude protein. The hydrolysis of the proteins was carried out by Franco *et al.* (2010) method. The identification and quantification of amino acids were carried out by HPLC, using the conditions described by Alonso *et al.* (1994) with some minor modifications. The conditions of the method are shown in Table 1. The liquid chromatography equipment consisted of TermoFinnigan chromatograph with UV/VISIBLE detector by photodiode matrix Spectrasystem UV6000LP. The column used was a reversed phase C18 Ultrasphere 5–ODS (diameter of 4.6 mm and 25 cm of length) from Beckman (Fullerton, EE.UU). The temperature of the column was controlled to 50 ± 1 °C with a column heater (Spectrasystem 3000). The wavelength of the detector was at 254 nm. Standards of the 22 different amino acids were supplied by Sigma Chemical Co. (St Louis, MO). All the samples and standards were injected at least in duplicate. Repeatability tests were performed by injecting a standard and a sample consecutively six times in a day. Reproducibility tests were also carried out by injecting the standard and the sample twice a day for three days under the same experimental conditions. Significant differences ( $P < 0.05$ ) were not found between the results obtained in these tests.

Table 1. Conditions of the chromatographic method.

Time (min)	Flow (mL/min)	% A	% B
0.00	0.90	100	0
5.00	0.80	100	0
20.00	0.75	78	22
40.00	0.80	54	46
42.00	1.00	0	100
43.00	1.00	0	100
44.00	1.00	100	0
46.00	1.50	100	0
47.00	0.90	100	0

### Statistical analysis

Mean and standard error of the mean values were determined for all the parameters and the results were expressed as mean and standard error of the mean. Analysis of variance (ANOVA) was carried out in order to compare the value of each parameter and the

significance is given as  $P < 0.05$ ,  $P < 0.01$  and  $P < 0.001$ . Means were compared by the least-square difference test (LSD), using the computer programme Statistica© 7 for Windows (Statsoft Inc., Tulsa, OK, USA). A factor analysis was made to obtain a reduced number of principal components to explain the variability of the selected variables. The relationship among the variables was represented by a principal component analysis (PCA). Using a new matrix of data integrated by the standardised reduced original variables, which were selected from the previous factor analysis, a discriminant analysis was developed to assess the fish according to muscle and the skin.

## Results and Discussion

The Figure 1 represents the different composition of protein obtained. The major percentage of protein was found in the skin of the eel. There are significant differences between protein content of muscle and skin. The results are inside the range of normal protein content of fish. The amount of protein of the fish can vary between 12 to 23% (Badui, 2006). The results are normal for fish, being higher than other fish species like cod (Thorarinsdottir *et al.*, 2002) or the sea trout (Etienne *et al.*, 2000).

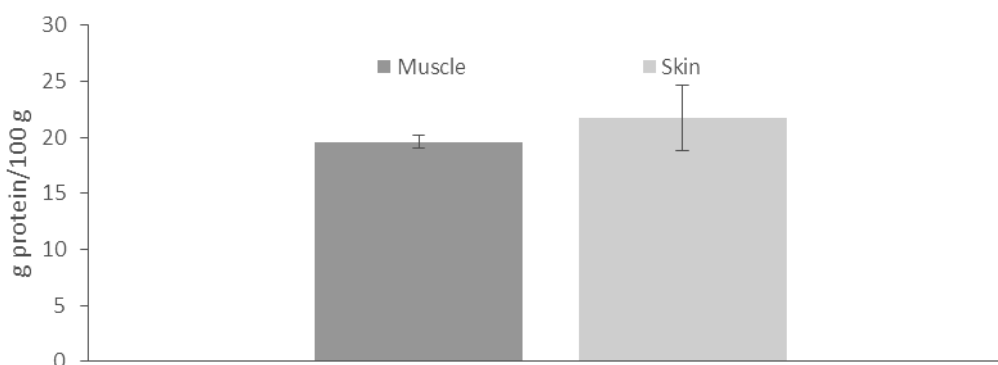


Figure 1. Protein content (expressed as g/100 g) in muscle and skin of eel.

The results, expressed as amino acid g for 100 g wet weight are shown in Table 2. Seventeen amino acids were studied in this work. The different amino acids were classified according essential or non-essential. The major essential amino acid obtained in muscle and skin eel was leucine (Leu) with 1.65 and 1.29 g/100 g, respectively. On the other hand, the major non-essentials amino acids found were glutamic acid (Glu) (2.00 g/100 g) in muscle and glycine (Gly) (2.98 g/100 g) in skin. The minor essential amino acid in muscle and skin was methionine (Met). In muscle, the minor amino acid was the hidroxypoline (Hyp). Proline (Pro) was the minor amino acid found in skin eel. There are more non-essential amino acids than essential in muscle and skin eel. The comparison between muscle and skin shows a higher content in essential amino acids in muscle than skin. Furthermore, significant differences were obtained in amino acid concentration between muscle and skin in most cases as can be seen in Table 2.

Significant differences between muscle and skin were not found for valine (Val), isoleucine (Ile), phenylalanine (Phe), aspartic acid (Asp) and proline. The hidroxypoline was the amino acid with highest content, as it could be saw on Figure 2.

The relationship between essential and non-essential amino acids studied in this work was 0.80 for muscle and 0.49 for skin. This relation determine the nutritional value of the eel. The muscle has a better relation essential/non-essential amino acid than skin. This relation in muscle is major than in other fish species, like grey mullet (*Mugil cephalus*) or Gilthead seabream (*Sparus aurata*) (Cobas *et al.*, 2016).

Table 2. Amino acid content in muscle and skin (g/100 g)

	aa	Muscle (g/100 g)	Skin (g/100 g)	SEM	P
ESSENTIALS (E)	His	0.56	0.54	0.013	*
	Thr	0.88	0.76	0.016	***
	Val	0.82	0.73	0.014	n.s
	Met	0.45	0.23	0.022	*
	Ile	0.82	0.61	0.021	n.s
	Leu	1.65	1.29	0.042	***
	Phe	0.80	0.75	0.018	n.s
	Lys	0.94	0.67	0.031	***
	<b>Essentials AA Total</b>	6.91	5.58	0.151	**
NON-ESSENTIALS (NE)	Hyp	0.17	1.04	0.074	***
	Asp	1.21	1.09	0.055	n.s
	Glu	2.00	1.61	0.080	***
	Ser	0.76	0.81	0.015	*
	Gly	1.12	2.98	0.179	***
	Arg	1.30	1.71	0.054	***
	Ala	1.17	1.67	0.057	***
	Pro	0.31	0.36	0.015	n.s
	Tyr	0.64	0.42	0.021	***
	<b>Non Essentials AA Total</b>	8.69	11.69	0.358	*
	<b>Total AA</b>	15.61	17.27	0.365	***
	<b>E/NE</b>	0.80	0.49	0.028	n.s

n.s: no significant differences. Significant differences \* (P < 0.05) \*\* (P < 0.01) \*\*\* (P < 0.001). SEM: Standard Error of Mean.

With the objective of discrimination between muscle and the skin of eel, multivariate statistical techniques were applied. All variables studied were used for the analysis and a factorial analysis was previously performed to obtain the variables which contributed the most to the classification. A Varimax rotation was carried out to minimise the number of variables that influence each factor, and so facilitate the interpretation of the results. The first principal component (PC1), which explained 48.97% of total variance, was positively correlated with the E/NE relation, total essential amino acids, Tyrosine (Tyr) and Val and inversely related to Hyp, Gly and total non essential amino acids. Principal component 2 (PC2), which explained 30.81% of the total variance, was positively related to E/NE relation. Finally, a canonical analysis was developed to assess the fish units. From the data set subjected to discriminant analysis, 4 variables were retained at the end of the stepwise discriminant analysis and were linearly combined to form canonical discriminant functions. When canonical discriminant analysis was performed for their selected variables, the percentage of classification was of the 100% for all fishes. The variable with the highest discriminating power were E/NE relation.

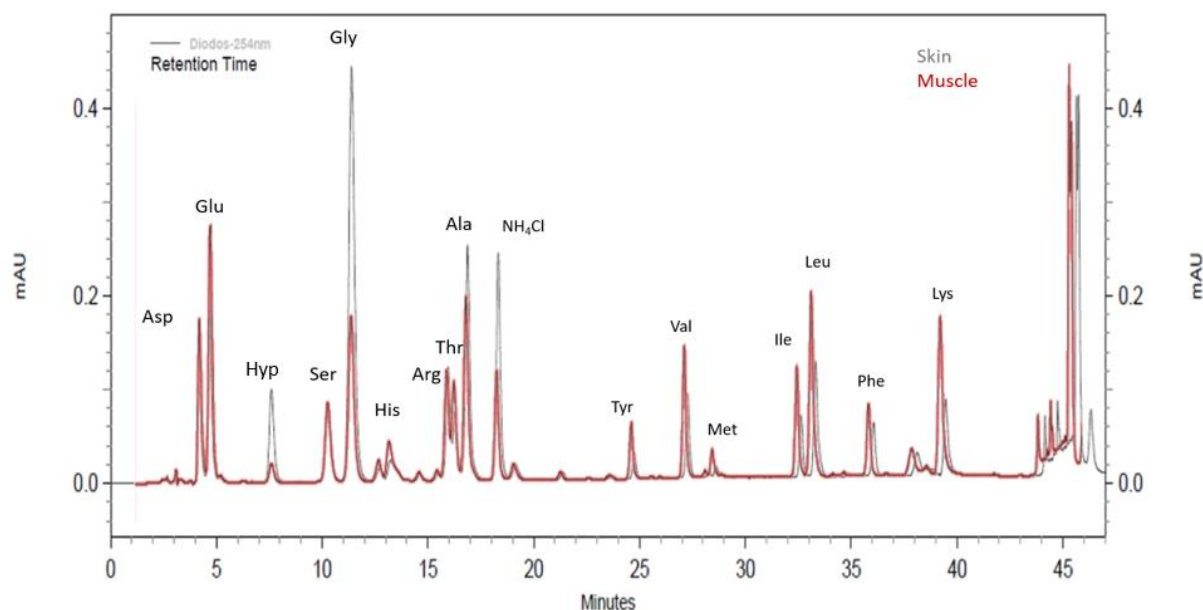


Figure 2. Chromatogram of muscle and skin eel amino acid contents.

The data obtained show that the European eel is a good source of amino acids. Even they supply the recommended daily allowance of some essential amino acids. The Table 3 describes the requirement of different amino acids and the percentage supply by eel.

Table 3. Amino acid requirements and the percentage supply by eel.

	His	Ile	Leu	Lys	Met	Phe	Thr	Val
<b>Williams (2002) (g of amino acid)</b>	0.56 - 0.84	0.70	0.98	0.84	0.91	0.98	0.49	0.70
<b>WHO (g of amino acid)</b>	0.70	1.40	2.73	2.10	0.70	1.75	1.05	1.82
<b>Eel (Muscle g/100 g)</b>	0.56	0.82	1.65	0.94	0.45	0.80	0.88	0.82
<b>*RDI Suply Williams (2002) (%)</b>	100.00	117.14	168.37	111.9	49.45	81.63	179.59	117.14
<b>*RDI Suply WHO (%)</b>	80.00	58.57	60.44	44.76	64.29	45.71	83.81	45.05

Source: Williams (2002) and World Health Organization (WHO) (2007). \* Data calculated based in results obtained for male adult weighing 70 Kg. RDI: Recommended Daily Intake.

### Conclusions

The results achieved in this study show that the European eel is a good source of protein. The consumption of 100 g of meat eel supplies the requirement of amino acids for histidine, isoleucine, leucine, lysine, threonine and valine. To conclude, present results indicate that European eel (*Anguilla anguilla*) is a good source of amino acid. Its composition has a great nutritional value and the relation between essential and non-essential amino acid was optimum. The muscle has more content in essential amino acid than skin. The consumption of muscle and skin provides a good ingest of essential amino acid.

### References

- Alonso, M.L., Álvarez, A.I., & Zapico, J. (1994). Rapid analysis of free amino acids in infant foods. *Journal of Liquid Chromatography*, vol. 17, no 18, pp. 4019-4030.
- Aristroy, C. & Toldrá, F. (2009). Essential amino acids. In: *Handbook of Seafood and Seafood Products Analysis*. United States: CRC Press. pp. 287-300.

- Badui, S. (2006). Proteins of some foods. In: Food Chemistry. México: Alhambra Mexicana. pp. 217-220.
- Banca Dati di Composizione (BDA), Italy [Online] [http://www.bda-ideo.it/wordpress/?page\\_id=14](http://www.bda-ideo.it/wordpress/?page_id=14) Accessed on 4th of July 2017.
- Belitz, H.-D., Grosch, W. & Schieberle, P. (2009). Amino acids, peptides, proteins. In: Food Chemistry. Germany: Springer. pp. 8-92.
- Cobas, N., Martínez, S., & Franco, F.M. (2016). Swordfish: Fishing, chemical composition and nutritional value. Spain: University of Vigo. pp. 67-69.
- Etienne, M., Jérôme, M., Fleurence, J., Rehbein, H., Kündiger, R., Mendes, R., & Mackie, I. (2000). Identification of fish species after cooking by SDS-PAGE and urea IEF: A collaborative study. Journal of Agricultural and Food Chemistry, vol. 48, no 7, pp. 2653-2658.
- Franco, D., González, L., Bispo, E., Rodríguez, P., Garabal, J.I. & Moreno, T. (2010). Study of hydrolyzed protein composition, free amino acid, and taurine content in different muscles of Galician blonde beef. Journal of Muscle Foods, vol. 21, no 4, p. 769-784.
- Gökoğlu, N., & Yerlikaya, P. (2015). Chemical composition of fish. In: Seafood Chilling, Refrigeration and Freezing: Science and Technology. United Kingdom: John Wiley & Sons, Ltd. pp. 5-37.
- Horwitz, W. (2000). Official methods of analysis of AOAC International (17th Edition). United States: AOAC International.
- Ibegbulem, C.O., Igwe, C.U., Okwu, G.N., Ujowundu, C.O., Onyeike, E.N., & Ayalogu. E.O. (2013). Total amino acid profiles of heat-processed fresh *Elaeis guineensis* and *Raphia hookeri* wines. Food Chemistry, vol. 138, no 2, pp. 1616-1620.
- Ordóñez, J.A., & de la Hoz, L. (1999). Meats, fish and eggs. In: Nutrition Treaty. Spain: Díaz de Santos.
- Thorarinsdottir, K.A., Arason, S., Geirsdottir, M., Bogason, S.G., & Kristbergsson, K. (2002). Changes in myofibrillar proteins during processing of salted cod (*Gadus morhua*) as determined by electrophoresis and differential scanning calorimetry. Food Chemistry, vol. 77, no 3, pp. 377-385.
- United States Department of Agriculture. (USDA) United States [Online] <https://ndb.nal.usda.gov/ndb/foods/show/4507?n1=%7BQv%3D1%7D&fgcd=&man=&lfacet=&count=&max=&sort=&qlookup=&offset=&format=Full&new=&measureby=&Qv=1&ds=&qt=&qp=&qa=&qn=&q=&ing=> Accessed on 4th of July 2017.
- Venugopal, V. (2008). Seafood proteins: Nutritional value, bioactive peptides, marine and cold-adapted enzymes. In: Marine Products for Healthcare: Functional and Bioactive Nutraceutical Compounds From the Ocean. United States: CRC press. pp. 103-142.
- Williams, M.H. (2002). Protein: The tissue builder. In: Nutrition for Health Fitness and Sport (Bicolor). Spain: Editorial Paidotribo. pp. 182-184.
- World Health Organization (WHO) (2007). Protein and amino acid requirements in human nutrition: Report of a joint FAO/WHO/UNU expert consultation. In: Protein and Amino Acid Requirements in Human Nutrition: Report of a Joint FAO/WHO/UNU Expert Consultation. Switzerland: WHO Technical Report Series. pp: 135-160.



## SAFFRON AS A FUNCTIONAL FOOD FOR TREATING DISEASE BY HOMEOPATHIC WAY

Simin Hagh NAZARI<sup>1\*</sup>, Mohammad HASSAN-SADEGHI<sup>2</sup>, Sarina Rezaei SHOJAEI<sup>2</sup>, Sara Rezaei SHOJAEI<sup>2</sup>

<sup>1</sup>Department of Food Science and Technology, Agriculture Faculty, University of Zanjan, Zanjan, Iran

<sup>2</sup>Faculty of Agriculture, University of Tabriz, Tabriz, Iran

\*Corresponding author: hagh nazari.simin@znu.ac.ir

### Abstract

Annually, around 300 tons of saffron is produced worldwide in a belt of lands ranging from the Mediterranean in the west to Kashmir in the east. Iran produces about 76% (230 tons) of the entire world production of saffron. Due to the long experience of Iran in cultivation, consumption and cultural influencing of this plant on their life; it has been used in many directions as a hair and clothes dyes, perfumes, flavoring foods, food ingredient for organoleptical properties and medical purpose for curing disease which with all specifications it nowadays called as a functional food. On the other hand, at present time one of the main areas of research in food Science and technology is the extraction and characterization of new natural food ingredients with biological activity can contribute to consumer's health as part of new functional foods. So the number of investigation that is designing on various aspects of food Science pertaining to functional foods has increased dramatically especially on saffron which is Iranian national plant. Also, in recent years there has been increased public interest in unconventional medicine such as homeopathy. At the same time, however, all countries have experienced the need to reduce public spending and cut back on expenses for a refundable treatment. As a result in this article the various researches and scientific reference will be surveyed.

**Key Words:** *gold plant, saffron, Homeopathy, functional food*

### Introduction

The world's most expensive spice by weight is Saffron which is derived from the flower of the saffron crocus (*Crocus sativus*). Its flower bears three stigmas that are dried and used in cooking as a seasoning and coloring agent. Saffron's taste and fragrance result from the chemicals picrocrocin and safranal. A rich golden-yellow hue is produced from a carotenoid dye, named crocin, which is imparted as a dishes and textiles colorant. It takes roughly 150,000 flowers and 400 hours' work to make 2 lb (1 kg) of dried saffron, making it the most costly spice in the world.

Due to the long experience of Iran in cultivation, consumption and cultural influencing of this plant on their life; it has been used in many directions as a hair and clothes dyes, perfumes, flavoring foods (Hagh Nazari and Keifi, 2007), food ingredient for organoleptical properties and medical purpose for curing disease which with all specifications it nowadays called as a functional food.

**History:** The history of saffron cultivation reaches back more than 3,000 years ago. Ancient Persians cultivated Persian saffron in Derbena, Isfahan, and Khorasan by the 10th century BC. At such sites, saffron threads were woven into textiles. Alexander the Great used Persian

saffron in his infusions, rice, and baths as a curative for battle wounds. Alexander's troops mimicked the practice and brought saffron-bathing back to Greece [2].

Most saffron is grown in a belt of land ranging from the Mediterranean in the west to Kashmir in the east. Annually, around 300 tones of saffron are produced worldwide [3]. Iran, Spain, India, Greece, Azerbaijan, Morocco, and Italy, in decreasing order of production, are the major producers of saffron. Iran with its cultivation of different varieties is the largest producer of saffron with 93.7% of the world's total production [4].

### **Medicinal applications of saffron:**

Saffron has a variety of uses in the world for healing a variety of diseases ranging from Arthritis to Impotence and Infertility. It is known to have aphrodisiac properties and is widely used in Asia and the Middle East as such. It has also been used in traditional Persian medicine to relieve stomachaches, ease the pain of kidney stones, and treat depression. Chinese and Tibetan Medicine also find many uses of this exotic herb. In traditional Chinese system, saffron was used as an agent to improve blood circulation and cure the bruise [5].

Saffron is used in Ayurveda medicine to treat conditions such as asthma, coughs, and alcoholism, acne and skin diseases. Also, in Greek medicine, it has been used in the treatment of liver, kidney and urinary infections. Saffron has been used to help cure menstrual disorders in women, to strengthen the heart and also as a coolant for the brain. Meadow saffron was used from the 2nd century BC for the treatment of joint disease and gout [6].

Ancient Romans hoped to benefit from its reputed ability to prevent hangovers by steeping the spice in their wine, or wearing it on their heads. It was also regarded to have sedative, antispasmodic, expectorant and aphrodisiac properties. Saffron was official in the pharmacopoeias of many countries in the seventeenth and eighteenth centuries, but by the beginning of the nineteenth century its therapeutic activity was beginning to be researched.

### New attention to saffron:

In the last decade, much attention has been focused on the biological and medical properties of saffron and its ingredients and the most striking evidence for the written records from many countries about the use of saffron in 90 illnesses over four millennia [7].

Saffron has further medicinal applications which are derived from its chemical composition about more than 150 volatile and several nonvolatile compounds of it based on these data, It can conclude that saffron contains three main pharmacologically active metabolites: 1.) Saffron-colored compounds are crocins, which are unusual water-soluble carotenoids (mono and diglycosyl esters of a polyene dicarboxylic acid, named crocetin). The digentiobiosyl ester of crocetin -  $\alpha$ -crocins is the major component of saffron. 2.) Picrocrocins is the main substance responsible of the bitter taste in saffron. 3.) Safranal is the volatile oil responsible of the characteristic saffron odor and aroma. Furthermore, saffron contains proteins, sugars, vitamins, flavonoids, amino acids, mineral matter, gums, and other chemical compounds [8 & 9].

The medicinal uses of saffron are diverse. Saffron extracts have shown various pharmacological properties in laboratory tests, including lowering blood pressure and heart rate, and stimulating respiration [10].

Recent scientific findings have been encouraging, uniformly showing that saffron and its components can affect carcinogenesis and currently have been studied extensively as the most promising cancer chemo preventive agents. The spectrum of tumors which saffron is against is wide including leukemia, ovarian carcinoma, colon adeno-carcinoma, rhabdo-myosarcoma, papilloma, squamous cell carcinoma, and soft tissue sarcoma [5].

Saffron extract has been shown capable of inhibiting and/or retarding tumor genesis in a variety of experimental models in vivo [11]. Topical application of saffron extract (100 mg/kg

body wt) inhibited two-stage initiation/promotion dimethylbenz anthracene (DMBA)-induced skin carcinogenesis and oral administration of saffron extract in the same dose restricted 20-methylchloanthrene (MCA)-induced soft tissue sarcomas in mice [12].

Saffron delayed ascites tumor growth and increased the life span of the treated mice compared to untreated controls by 45-120%. In addition, it delayed the onset of papilloma growth, decreased incidence of squamous cell carcinoma and soft tissue sarcoma in treated mice. A study indicated significant inhibition in the synthesis of nucleic acids but not protein synthesis. It appears now that saffron (dimethyl-crocetin) disrupts DNA-protein interactions e.g. topoisomerases II, important for cellular DNA synthesis [13].

The results of the study by Agha-Hosseini *et al* (2008), indicate the efficacy of *C. sativus L.* in the treatment of PMS. However, a tolerable adverse effects profile of saffron may well confirm the application of saffron as an alternative treatment for PMS. These results deserved further investigations. [14].

In recent years there has been increased public interest in unconventional medicine, especially homeopathy. At the same time, however, all countries have experienced the need to reduce public spending and cut back on expenses for refundable treatment [15]. Homeopathy is the branch of medicine which cures on the basis of similarity to the whole healthy condition of the patient, rather than addressing symptoms in isolation. It is a powerful and effective therapy, but it also demands a great deal of the patient. The patient must learn to observe areas of life which are ordinarily ignored by most people, and this observation must be done objectively and dispassionately [16].

Homeopathy is extremely effective curing. When the correct remedy is taken, results can be rapid, complete and permanent. It is completely safe. Even babies and pregnant women can use Homeopathy without the danger of side effects. Homeopathic remedies can also be taken alongside other medication without producing unwanted side effects. Homeopathy is natural treating normally based on natural ingredients. Homeopathy works in harmony with human immune system, unlike some conventional medicines which suppress the immune system. For example, cough medicines suppress the cough reflex, which is your body's attempt to clear the lungs. Homeopathic remedies are not addictive - once relief is felt, man should stop taking them. If no relief is felt, you are probably taking the wrong homeopathic remedy. Homeopathy is holistic. It treats all the symptoms as one, which in practical terms means that it addresses the cause, not the symptoms. This often means that symptoms tackled with Homeopathy do not recur.

The first law of Homeopathy is known as the Law of Similarities, or “like cures like.” This law states that “a substance that produces a certain set of symptoms in a healthy person has the power to cure a sick person manifesting those same symptoms.” The second law, or Law of Infinitesimals, states that diluting a remedy makes it more powerful [17].

Recent meta-analyses of randomized controlled trials in homeopathy have suggested that the homeopathic strategy appeared to be more medically effective and to be associated with a better quality of family life in the treatment of recurrent acute infantile rhino-pharyngitis than the antibiotic strategy incurring the Social Security significantly lower direct medical costs and producing fewer sick-leaves. Homeopathy could thus constitute a cost-effective alternative to antibiotics, providing an economical and ecological solution to public health problems caused by antibiotics (over-consumption and bacterial resistance respectively) [18].

### **Saffron as a useful remedy in Homeopathy**

In Homeopathy saffron is used as an effective remedy for patients with symptoms similar of saffron overdose. It is a remedy often useful in Hemorrhages that are black and stringy, Tingling in various parts, Chorea and hysterical affections, Frequent and extreme changes in sensations and mental conditions, Anger with violence followed by repentance, Laughing

mania, Drowsiness and Lassitude which get better by literary labor in open air, Get worsted by lying down, hot weather, warm room, in morning, fasting, before breakfast, looking fixedly at an object. Other symptoms which help to diagnose saffron needed for treating patient are:

- ✓ Vacillating; pleasant mania; sings and laughs
- ✓ Vivid recollection from music heard
- ✓ Sudden changes from hilarity to melancholy
- ✓ Happy and affectionate; then angry
- ✓ Throbs, pulsates, during climacteric; worse during menses.
- ✓ Threatened glaucoma; embolism of arteria centralis retinal.
- ✓ Sensation as if cold air was rushing through eye. Asthenopia with extreme photophobia
- ✓ Cleary neuralgia, pain from eyes to top of head
- ✓ Lids heavy
- ✓ Appearances as of electric sparks
- ✓ Must wipe eyes as if mucus or water were in them
- ✓ Feeling in eyes as after violent weeping
- ✓ Sensation as if she had been looking through too sharp spectacles
- ✓ Eyes feel as if in smoke
- ✓ Pupils enlarged and react slowly
- ✓ Vision; exertion of vision; foggy;
- ✓ Nose; nose bleed stringy blood; in hot weather,
- ✓ Strings of dark blood hanging down the nose, clotted
- ✓ Face skin discolors to pale during heat
- ✓ Abdomen as if something was in abdomen (movements, lumps, etc.) and feels movements in abdomen;
- ✓ Genitals; female; metrorrhagia (non-menstrual bleeding)
- ✓ Spasmodic contractions and twitching of single set of muscles
- ✓ Generalities; numbness; internally; in single parts

When these symptoms peculiar to the individual patient are known the homoeopathic remedy can be selected that will surely cure every curable disease, whether the disease be tumors, morbid growths, cancer or other skin diseases, or any form of chronic or acute disease peculiar to man, woman or child.

**Remedy Preparation:** The dried stigmas of the plant are macerated in alcohol. Remedies are made by the process of dilution and succession.

The mother tincture is usually diluted in a mixture of pure alcohol and distilled water according to one of several scales. The ratio of alcohol to water varies depending on the base substance of the mother tincture. To produce 1c potency, one drop of the mother tincture is added to 99 drops of an alcohol-and-water mixture and successives. To produce 2c potency, one drop of the 1c mixture is added to 99 drops of an alcohol-and-water mixture and successives. To manufacture the 6c potency illustrated in figure 1, this process is repeated a further four times. Once the mixture has reached the required strength and potency, a few drops of it are added to lactose tablets, granules, or powder, to impregnate them with the remedy. These are then stored in dark glass bottles.

### Figure Legend:

Figure 1: The mother tincture dilution in a mixture of pure alcohol and distilled water according to one of several scales.

### Figure:

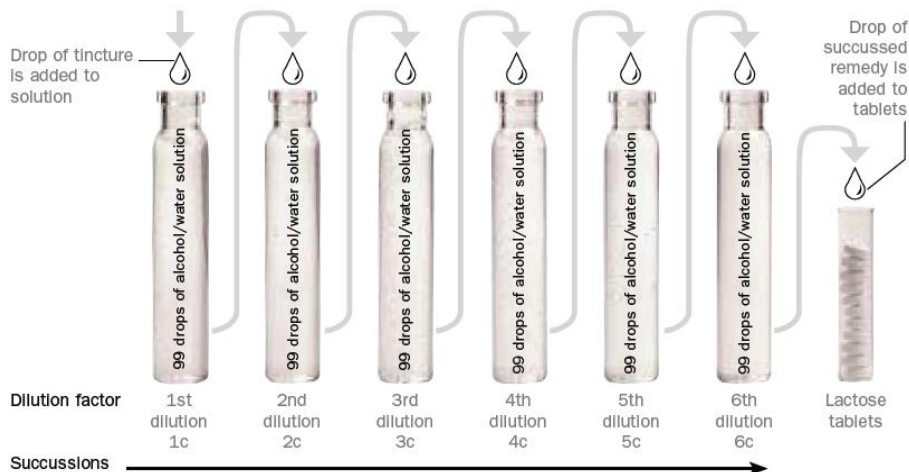


Figure 1: The mother tincture dilution in a mixture of pure alcohol and distilled water according to one of several scales

### Conclusion

Saffron has a long history of use in natural medicine for example in Homeopathy. Homeopathy appeared to be at least as effective as conventional medical care in the treatment of patients.

As a summary, the range of key symptoms for which *Crocus* is generally prescribed includes nervous excitement, alternating moods, sensation as if something is moving inside the abdomen, and hemorrhages with dark, clotted, stringy blood, usually in the form of nosebleeds or uterine bleeding.

*Crocus* is taken for rapidly alternating mental and physical states. The nervous system is overexcited, causing mood swings and hysterical, excited behavior. The feeling that something is moving inside the abdomen may be linked to a false pregnancy. Symptoms better for open air; for yawning and after breakfast. Symptoms worse for movement; during pregnancy; with puberty, fasting and in a warm room [19].

### Acknowledgements

Here by I respect and thanks from Tehran University manager for preparing free education Department for learning new scientific subjects fields such as Homeopathy for all learners.

### References

- Hagh Nazari, S. and Keifi, S., 2007. "Saffron and Various Fraud Manners in Its Production and Trades". Acta Horticulture", ISHS Pub.
- Willard, P. 2001. Secrets of Saffron: The Vagabond Life of the World's Most Seductive Spice, Beacon Press, ISBN 0-8070-5008-3, <http://books.google.com/books?ie=UTF-8&hl=en&id=WsUaFT7l3QsC>, retrieved 2009-11-23.

- Katzer, G. 2001, *Crocus sativus* L., Karl-Franzens-Universität Graz, [http://www.uni-graz.at/~katzer/engl/Croc\\_sat.html](http://www.uni-graz.at/~katzer/engl/Croc_sat.html), retrieved 2009-11-23.
- Ghorbani, M. 2008. The Efficiency of Saffron's Marketing Channel in Iran. *World Applied Sciences Journal* 4 (4): 523-527, ISSN 1818-4952.
- Deng. Y., Guo. ZG, Zeng. ZL, Wang. Z. 2002. Studies on the pharmacological effects of saffron (*Crocus sativus* L.). a review *Zhongguo Zhong Yao Za Zhi*. 2002 Aug;27(8):565-8.
- Rheumatol.Z. and Kaiser H. 2008. From the plant to chemistry. The early history of rheumatic medication *May*;67(3):252-62.
- McGee, H. 2004. *On Food and Cooking: The Science and Lore of the Kitchen*, Simon and Schuster, ISBN 0-684-80001-2, <http://books.google.com/books?ie=UTF-8&hl=en&id=iX05JaZXRz0C>, retrieved 2009-11-23.
- Dpiwe (2005), "Emerging and Other Fruit and Floriculture: Saffron", *Food & Agriculture*, <http://www.dpiwe.tas.gov.au/inter.nsf/WebPages/EGIL-5K63X8?open#Saffron>, retrieved January 10, 2006.
- Honan, W. 2004. Researchers Rewrite First Chapter for the History of Medicine. *The New York Times*. Published: March 2, 2004.
- Douglas, (1993), Redbank Research station. 2010. <http://web.archive.org/web/20030624222221/http://www.crop.cri.nz/psp/broadshe/saffron.htm#print>.
- Salomi. MJ, Nair. SC, Panikkar. PR. 1990. Inhibitory effects of *Nigella sativa* and saffron (*Crocus sativus*) on chemical carcinogenesis in mice and its non-mutagenic activity. *Proc Ker Sci Congr* 3:125–126.
- Fikrat, I. and Abdullaev . 2002. Cancer Chemopreventive and Tumoricidal Properties of Saffron (*Crocus sativus* L.). *Society for Experimental Biology and Medicine. Exp. Biol. Med.* 227:20-25.
- Nair SC et al, 1995. Saffron chemoprevention in biology and medicine: a review. *Cancer Biother. Winter*;10(4):257-64.].
- Agha Hosseini., Kashani., Aleyaseen., Ghoreishi., Rahmanpour., Zarrinara., Akhondzadeh. 2008. *Crocus sativus* L. (saffron) in the treatment of premenstrual syndrome: a double-blind, randomised and placebo-controlled trial. *BJOG: An International Journal of Obstetrics & Gynaecology*, Volume 115, Number 4, pp. 515-519(5).
- Rossi, E., Crudeli, L., Endrizzi. C., and Danila Garibaldi, D., 2009. Cost–benefit evaluation of homeopathic versus conventional therapy in respiratory diseases. *Homeopathy*. Volume 98, Issue 1, Pages 2-10.
- Vithoulkas. G., 2008. Cancer Chemopreventive and Tumoricidal Properties of Saffron (*Crocus sativus* L.). *Homeopathy-medicine for the new millennium*. 27 th edition, International Academy of Classical Homeopathy.
- Site Natural Alternative Treatments:  
<http://www.harthosp.org/HealthLibrary/NaturalAlternativeTreatments/default.aspx?chunkid=38314>. 2012.
- Trichard. T., Chaufferin. G., and Nicoloyannis. N., 2005. Pharmacoeconomic comparison between homeopathic and antibiotic treatment strategies in recurrent acute rhinopharyngitis in children. *Homeopathy* Vol: 94, Pp: 3–9.
- Lockie. A. *Encyclopedia of Homeopathy*. 2006. DK Publication. ISBN: 10- 0-7566-1871-1.

### **3. ORGANIC AGRICULTURE**

## **IMPACT OF THE DIFFERENT FERTILIZER-SYSTEMS OF FERTILIZERS ON THE AGGREGATE COMPOSITION IN THE ALLUVIAL-MEADOW FOREST AND MEADOW-BROWN SOILS FROM AZERBAIJAN DRY SUBTROPICS**

Goshgar Maharram MAMMADOV\*

Institute of Soil Science and Agrochemistry of the National Academy Science of Azerbaijan, Baku

\*Corresponding author: goshgarmm@mail.ru

### **Abstract**

Perfection of the soil fertility systems under agrocenosis cultures promotes an improvement of nutrient dynamics in the soil, preservation of preserves the agronomical valuable soil aggregates, influences on structural coefficients in arable and under arable layers of soils, improve sand improves aggregate composition, by increasing a measure of the agronomical valuable aggregates. The researches in connection with the investigation of the studies on the impact of different fertilisation systems impact of fertilizer on soil the mineral part of soil present a definitely raise interest, so allow to study particularly studies on anthropogenic factors influencing on soil fertility change, as soil irrigation, cultivation, sowing of the annual and perennial fodder crops. Supporting providing favourable physical conditions in soil permits allows us to create favourable situations for preservation of agronomical valuable water-stable fine-granular structure in it of soil. So many of its quality as factors, such as water, air, biological and nutritious regimes depend on soil structural character structure providing the life living conditions of higher plants and microflora. The soil conditions side by side with the soil density and supplies of the amount of the productive moisture determine such parameters as a coefficient of structure quantity in the agronomical valuable aggregates. A totality of microorganisms, soil particles in different forms and measures more than 0,25mm forms soil aggregate compositions which that can be examined as an object, not only reflecting results of soil-forming processes, but also the man's human activities on land activity. Change of in the aggregate composition and structural coefficient in the alluvial meadow-forest soils under vegetable (tomato) cultures depending on caused by different fertilizer systems showed that an application of the fertilizer organic (manure of-horned of horned cattle) systems improves improved the soil structural condition of the soil. The use of the organic-mineral (manure + nitrogen, phosphorus and potassium fertilizer) systems of fertilizers positively influence don the structural condition in of the alluvial meadow-forest soils under vegetable cultures, in comparison with the control versions variants. In the fertilizer organic-mineral fertilizer system under version of(N<sub>60</sub>P<sub>90</sub>K<sub>120</sub> + 20 t/h manure), also improved the aggregate composition of the soil, i.e. an the importance, of the agronomical valuable aggregates rose on the arable and under arable layers of soil (10-0,25 mm) in comparison with the control (without fertilizer) version is accordingly till 14,1 and 9,8%. The investigations study allow us to establish the best index of improvement and preservation of ergonomically agronomical valuable soil aggregates which are revealed under the version where an the organic system of fertilizers was applied (40 t/h of manure). More over, the significance of the structure coefficient on the arable and under arable layers in the soil are equal accordingly to 1,6 and 1,4.

**Key words:** *soil structure, physical chemical peculiarities, nutritious regime, fertilizer, fertilizer systems.*



## **Introduction**

A rich material of the world farming practice influences the important change of soil fertility under an impact of the organic and mineral fertilizers, irrigation and cultivation, seeding of the annual and perennial fodder plants, freshening and drainage of salinized and marshy lands and etc (Gorbileva, Lalomova, 2002; Mammadov, 2007). The soil change structure under an influence of mineral and organic fertilizers has been studied a little. An analysis of the aggregate composition the methods of the moist sift in on the sieve give very indefinite results which largely depend on growing cultures, cultivation, fertilizer application (Hummatov and Pachepsky, 1991). The numerous investigations maintain that the soil structure changes tempo and direction of the physic-chemical and biological processes in it, affects on growth character and plants development and crop quality (Mammadov, 1989), (Kachinsky, 1970; Mammadov, 1989, Guliyev, 2014). The structural soils are distinguished by the favorable physical peculiarities and good nutritional regime, the water and air easily penetrate into them (Gregory, 2006). As a result of the good water permeability the whole water falling on structural soil surface is absorbed, sucked and isn't lost (Barthes, 2002). These soils are able to provide a solid supply of water in the soil forming 80-85% of the yearly quantity of precipitations (Barber, 2000).

## **Material and Methods**

The researches have been performed on generally accepted methods under different agrocenosis: in the apple garden and under vegetable cultures (tomato) in the alluvial meadow-forest and meadow-brown soils under conditions of the soil irrigation from Guba-Khachmaz zone of Azerbaijan. The agrotechnical measures corresponded to the generally accepted agrorules for the region (Beluchenko, 2014; Mammadov, 2016). An aggregate composition of soils by N.I.Savinov, general porosity-calculation method, specific gravity-bottle by S.I. Dolgov granulometric composition - pipette method with the application of dispergator-pyrophosphate of Na, hygroscopic moist-dried at 10°C temperature. Calcareous (CaCO<sub>3</sub>) - calcimetric by Sheibler's method absorbed with calcium and magnesium-“trilon B” (depletion 3n NaCl by Ivanov's method: ammiac nitrogen-by help of Nesler's reactive, by Matchigin, nitrate nitrogen, P<sub>2</sub>O<sub>5</sub> and K<sub>2</sub>O kilometric in apparatus “Palintest”. The obtained materials were exposed to the mathematic processing by B.A. Dospekhov method Na+P<sub>c</sub>, K<sub>x</sub> were applied as mineral fertilizers (Arinushkina, 2009) The cow manure serves as organic fertilizer under 65% of moisture maintain on average 0,5% n 0,25%-P<sub>2</sub>O<sub>5</sub> and 0,45%-K<sub>2</sub>O.

## **Results and Discussion**

At present search of the ways and methods in soil ecological functions restoration, its physical condition improvement and structural-aggregate composition which lead to the soil favorable characteristics, formation as the in- habitation environment. Optimization of the soil physical condition and namely an improvement of its structural-aggregate composition, preservation of the grain structure in chernozem is the first-degree in soil fertility at high horizons. The soils in Azerbaijan arid subtropics in limits of the Guba-Khachmaz zone are mainly used under agricultural plants, weakly provided by the main nutrient, as in alluvial meadow-forest soils-at horizons 0-115cm, a content of the mobile forms in humus, nitrogen, phosphorus and potassium varies accordingly in limits of 0,41-3,95% (humus); 0,01-0,24% (N); 0,03-0,16% (P<sub>2</sub>O<sub>5</sub>) and 1,43-3,66% (K<sub>2</sub>O). At the same time these indices in the irrigative meadow-brown soils form: humus-0,64-3,12; gross (total) nitrogen 0,06-0,29; phosphorus 0,07-0,26 and potassium-1,65-3,07% on soil profile (0-115 cm) that is more in comparison with the alluvial meadow-forest soils (table 1, 2). Wholly, the investigations of the arid subtropical soils in the

Guba-Khachmaz zone are characterized as weakly provided on mobile forms content of nitrogen, phosphorus and potassium. The problems of the structure impact on soil characteristics, its fertility, and plant crop attracted the soil scientists, agrochemists and agronomists attention long since. The soil structure is formed as a result of the long active soil forming processes proceeding under some or other conditions. The soil structure develops and changes with the soil development. The research results of the agrochemical, agrophysical, chemical and water-physical parameters their productivity increase in these soils showed that it is necessary to perform the following measures; application and improvement of the mineral and organic fertilizer systems, large application in the correct crop rotation, observation of the land rational usage. The soil conditions besides soil density and productive moisture supply determine such indications as a coefficient of structure and quantity in agronomic valuable aggregates. Joint of macroorganisms, soil particles of the various forms and sizes more than 0,25 mm, form soil composition, it can be examined as an object, and the reflecting consequences aren't only soil forming processes but also the man's farming activities. Change of the aggregate composition and structure coefficient in the alluvial meadow-forest soils under vegetable (tomato) cultures and dependence on fertilizer systems (mean data for 2014-2016) is given on the table 1.

Table 1. Aggregate composition and structure coefficient in the alluvial meadow-forest soils under vegetable (tomato) cultures and dependence on fertilizer system (Guba-Khachmaz zone 2014-2016)

Fertilizer system	Fertilizer norm	Soil layer, cm	Size of the soil aggregates, mm maintain %			Structure coefficient (K)
			>10	10-0,25	<0,25	
Unfertilized (control)	-----	0-20	0,1	53,7	46,2	1,6
		20-40	0,3	59,1	40,6	1,4
		40-60	0,4	60,2	39,4	1,5
Organic	40 t/ha manure	0-20	--	71,3	28,7	2,4
		20-40	--	67,8	32,2	2,1
		40-60	0,1	61,2	38,8	1,6
Mineral organic (joint application)	N <sub>60</sub> P <sub>90</sub> K <sub>120</sub> +20t/ha manure	0-20	0,2	67,8	32,2	2,1
		20-40	0,4	68,9	30,6	2,2
		40-60	--	63,8	36,2	1,8
Mineral organic (joint application)	N <sub>90</sub> P <sub>100</sub> K <sub>140</sub> +20t/ha of manure	0-20	0,2	66,2	33,4	1,9
		20-40	0,1	62,5	37,4	1,6
		40-60	--	58,6	41,2	1,4
Mineral	N <sub>120</sub> P <sub>160</sub> K <sub>180</sub>	0-20	0,4	59,4	40,2	1,4
		20-40	0,2	61,1	38,7	1,5
		40-60	0,5	57,2	42,3	1,3
<b>SED<sub>0,95</sub></b> (the smallest essential difference)						<b>0,18</b>

An analysis of the obtained data shows that an application of the organic (cow manure) improves the soil structural condition. The utilization of the organic-mineral (manure+nitrogen, phosphorus and potassium fertilizer) systems of fertilizer positively affected the structural state in the alluvial meadow-forest soils under vegetable cultures in comparison with the control variants.

On average for 3 years under organic fertilizers application (cow manure 65% of moisture) decrease of the valuable range fraction sums (0,25-10,0 mm) at 0-60cm of soil layer where the structure coefficient (K<sub>st</sub>) rose 9,1% on average in comparison with the control, accordingly

increased and formed 0,46-on control (at 0-20 cm of soil layer) 1,6 under the version with the organic fertilizers application at 0-20 cm it is equal to 2,4%.

Preservation of the unique gluey-granular structure and well-distinguishing soil clods and aggregates after water impact is the soil important function. The consequences of the water-stability definition in structural aggregates showed that the given character in soil with the application of the organic, also organic-mineral (manure-mineral) fertilizers was more than the variant control. Maintain of the soil aggregates with a quantity of 0,25mm under the control variant at 0-60 cm of layer of soil formed 42% on average, then as under the version where a system of organic fertilizers (40 t/h of manure) and organic-mineral (20 t/h of manure+N<sub>60</sub>P<sub>90</sub>K<sub>120</sub>) fertilizers is applied these significances approximately formed 33%. For all that under these variants the maintain of the agronomic valuable aggregates (particle size 10-0,25 mm) gets increased. Change of aggregate composition and structure coefficient in irrigated meadow-brown soils under fruit (apple) cultures depending on fertilizer system is performed on Table 2.

Table 2. Aggregate composition and structure coefficient in the irrigative meadow-brown soils under fruit (apple) cultures depending on fertilizer systems (Guba-Khachmaz, 2014-2016)

Fertilizer system	Fertilizer norm	Soil layer, cm	Size of the soil aggregates, mm			Structure coefficient K(st)
			>10	10-0,25	<0,25	
Unfertilized (control)	-----	0-20	2,6	52,6	45,4	1,1
		20-40	2,1	57,0	40,9	1,3
		40-60	4,3	72,7	23,0	2,6
Organic	40 t/h manure	0-20	1,8	66,2	32,0	1,9
		20-40	1,4	70,5	28,1	2,3
		40-60	3,9	67,8	28,3	2,1
Mineral organic (joint application)	N <sub>60</sub> P <sub>90</sub> K <sub>120</sub> +20t/h of manure	0-20	2,0	63,5	34,5	1,7
		20-40	1,7	67,8	30,5	2,1
		40-60	2,2	69,1	28,7	2,2
Mineral organic (joint application)	N <sub>90</sub> P <sub>100</sub> K <sub>140</sub> +20t/h of manure	0-20	1,7	61,8	36,5	1,6
		20-40	1,5	63,7	34,8	1,8
		40-60	2,6	66,8	30,6	2,0
Mineral	N <sub>120</sub> P <sub>160</sub> K <sub>180</sub>	0-20	2,7	50,7	46,6	1,0
		20-40	2,3	54,8	42,9	1,2
		40-60	3,8	69,6	26,6	2,6
<b>SED<sub>0,95</sub></b> (the smallest essential difference)						<b>0,27</b>

An analysis of the obtained data shows that an application of the organic and organic-mineral systems in fertilizers in irrigated meadow-brown soils under agrocenosis positively affected the soil structural state in comparison with the control version. Maintain of soil aggregates with the size 0,25 mm under the control variant forms 46,2%, then as while the organic fertilizers (40 t/h of manure) is applied, these indices get the agronomic valuable particles rose till 71,3% at 10-0,25 mm. Under an application of the organic-mineral system in fertilizer (joint application) the maintain increase of the particle sizes is also established (10-0,25mm). Soil aggregates content (10-0,25 mm) on the arable layer is 63,5%, but it reaches 67,8%, a coefficient of these parameters structure is accordingly 1,7 and 2,1 under an application of

mineral fertilizers at a norm of  $N_{60}P_{90}K_{120}+20$  t/h manure (cattle) on the arable layer. An application of only mineral systems of fertilizer at a norm of  $N_{120}P_{160}K_{180}$  in maintain of soil aggregates at a size of 1-0,25 mm (agronomic valuable) in comparison with the control version the positive actions aren't established, but a content of the particles with a size of < 0,25mm increases a little, that leads to the aggravation of the water-physical indications in the soils. So, the best indications of the fertilizer organic systems (cow manure 40 t/h) on maintain of the agronomic valuable particles with a size of 10-0,25 mm. Under an application of the organic systems in fertilizers (cow manure 40 t/h) the high significant on structure coefficient is established. On the arable and subsurface layers of the soils these indices accordingly form 1,9 and 2,3. If the middle maintain of soil aggregated with a size of particles is 10-0,25 mm at 0-60 cm layer of soil forms 57,6%, then these parameters are accordingly equal to 20t/h of manure + $N_{60}P_{90}K_{120}$ , at 0-60 cm layer of soil this significant is equal to 66,8% on average. An analysis of these data shows that on average for 3 years while performing researches with an application of organic-mineral systems in fertilizers of the irrigated meadow-forest soils under tomato plant at the end of vegetation a quantity of the agronomic valuable aggregates (with a size of particles 10-0,25 mm) increases till 9,2%. These parameters were the best in the performed experiment. It is established that with the increase of the mineral doses and doses of organic fertilizers the maintain of soil aggregates with the particles size (10-0,25 mm) is gradually became diminished i.e. decrease fertilizer doses negatively affected the content in the agronomical valuable aggregates. The structure coefficient under the control variant (unfertilized) at 0-60 cm layer formed 1,5 on average, under an organic system of fertilizer (40 t/h of manure) the average significant (at 0-60 cm layer) was 2,03, but under the version where the organic-mineral system of fertilizer is applied, a quantity of the structure coefficient was analogical organic system of fertilizer on soil profile. Increase of the mineral fertilizer, doses and application of organic-mineral system in fertilizers under corresponding growth of the mineral fertilizer doses ( $N_{90}P_{100}K_{140}$ ) and reduction of the organic (10 t/h of manure) fertilizers negatively affected the soil structure in comparison with the fertilizer organic system that rendered an influence on structure coefficient significant ( $K_{st}$ ). On average this quantity at 0-60 cm of soil layer is 1,6. It is revealed that an application of the mineral system in fertilizer reduces the structure coefficient which reaches 1,4 on soil profile on average (at 0-60 cm of soil layer). For all that they maintain of soil aggregates with a size of particles <0,25mm rises, that aggravates the soil structure and negatively affects chemical soil environment. While studying the aggregate composition and structure coefficient in the irrigated meadow-brown soils under fruit plants the analogical consequences are obtained.

### **Conclusions**

The best parameter of the improvement and protection in the agronomical valuable soil aggregates in the alluvial meadow-forest soil is revealed under the version where the organic system of fertilizers (40 t/h of manure) is applied. For all that a significant of the structure coefficient in the tillage and under tillage arable layers is accordingly equal to 1,6 and 1,4.

White an application of organic-mineral system of fertilizer under vegetable cultures in the variant of  $N_{60}P_{90}K_{120}+20$  t/manure the aggregate composition is improved, i.e. a significant of the agronomic valuable aggregates rose in tillage and under tillage layers (10-0,25 mm) in comparison with the control (unfertilized) variant till 14,1 and 9,8%.

The structure coefficient grows under organic-mineral systems of fertilizers in comparison with the control 1,5 times approximately.

A positive influence of organic system in fertilizers on increase of soil aggregates at a size of 10-0,25 mm is established under the fruit cultures in the irrigated meadow-brown soils. The

agronomical valuable aggregates rose under an application of the organic systems of fertilizers (40 t/h) in comparison with the control one in the tillage and under tillage layers 13,55% on average.

### **References**

- Agrochemical methods of the soil researches. M.: Nauka, 1975, 656 p.
- Arinushkina E.V. -Guidance of the chemical analysis in soil. M.:Pub. MSU, 1970, p.487.
- Barthes B., Roose E. Aggregate stability as an indicator of soil susceptibility to runoff and erosion validation at several levels //Catena, 47:2002, p.133-149
- Belychenko I.S. Wastes of different production and their properties //Ciencia e Tehnica Vitvinicola, 2014, v.29, N9, p.37-50
- Belychenko I.S., Antonenko D.A. The impact of complex compost to aggregate composition and water-air properties of chernozemic soil //Soil Science, M. N7, p.858-864
- Dmitriev E.A. -Mathematical statistics in Soil Science. M. “Librikom” M., 2009, p.328.
- Gorbileva A.I., Lalomova T.V. -Impact of the fertilizer system and cultivation methods in soddy-podzolik light loamy soil on its structure and water stability.//National Acad. of Science. Belorussia, ser.agrarian.sci., 2002, №4, p.42-45.
- Gregory P. Plant roots-growth, activity and interactions with the soil, Blackwell 2006, 328 p.
- Guliyev A.G. -Ecomeliorative value of irrigated soils in Nakchivan Autonomic Republic. Pub. “Ajemi”, Nakchivan, 2014, p.168.
- Hummatov N.G., Pachepsky Y.A. -Modern presentation about soil structure and structural formation, mechanisms and models: Dynamics and factors. Pushino, 1991, p.58.
- Kachinsky N.A. -Soil physics. Water-physical characters and soil regimes. M.: High school, 1970, p.358.
- Mammadov G.M., Qurbaqnov E.A. The Agrochemical methods of increasing fertility of the irrigated soils of dry subtropics of Azerbaijan // Agricultural chemistry, №7, 2016 , p.19-23
- Mammadov G.Sh. Soil Science basis and soil geography. Baku: “Elm”, 2007, p.664.
- Mammadov R.H. -Agrophysical characters in soils of Azerb.SSR. Baku, “Elm”, 1989, p.244.
- Shein E.V. -Course of soil physics. M: Pub. MSU, 2005, p.432.
- Skuratov N.S. and other. -Guidance of control and regulation in the soil fertility of the irrigated lands under their use. Novocherkassk, 2000, forest soils under winter wheat.//News MSU, ser.17, Soil Science 1:20-25. p.85.

## IMPACT OF SPECIAL HERBAL PREPARATION ON YIELD OF CABBAGE AND LETTUCE ON SANDY SOILS

Srdjan LJUBOJEVIC\*

The Independent University of Banja Luka, Faculty for Ecology & Institute for Scientific Research

\*Corresponding author: ljuboje@blic.net

### Abstract

The paper describes testing the impact of a special herbal preparation (SHP), in the capacity of a plant growth regulator (PGR) and a mild organo-mineral fertilizer, on yield of cabbage and lettuce. Field experiment was carried in two greenhouses situated at the location Gadid in Gaza Strip, under specific site conditions - sandy soil, low organic matter content, increased concentration of salts in irrigation water. SHP was based on herbal extracts from comfrey, dandelion, horsetail, lavender, nettle, yarrow and wormwood, enriched with major macronutrients and essential micronutrients. The production trial was executed as per following conditions. There were four treatments ( $T_i$ ):  $T_1$  - SHP, standard rate,  $T_2$  - SHP double rate,  $T_3$  - SHP, standard rate + NPK (25 % of commercial rate),  $T_4$  - NPK (25 % of commercial rate) and control group - NPK, commercial rate. Planting density of cabbage was 6,500 plants/dunam (1000 m<sup>2</sup>) and that of lettuce – 7,800 plants/dunam. Experiment layout was the random block system with four replications (blocks). The achieved results had shown that it is possible to produce cabbage and lettuce on sandy soils using SHP enriched with low mineral inputs. Also, it is obvious that applied commercial production of cabbage and lettuce on sandy soils was based on the huge input of fertilizers.

**Key words:** *special herbal preparation, cabbage, lettuce, sandy soils, yield*

### Introduction

The production of special herbal preparation (SHP) intended for commercial use in agriculture is grounded on natural raw materials – wild growing medicinal herbs. The initial set of species was determined on the bases of previous knowledge and large scale experiments under controlled conditions. In order to extract the active matter without application of chemical means, an original production process has been developed. The foundation of this process is a unique combination of water extraction and biofermentation supported by continual oxygen enrichment (Ljubojević, 2015). Subsequently, extensive field experiments have been undertaken on various agricultural crops, including cucumber, pepper and tomato in greenhouses in the south of Urals (Ljubojević and Eliseev, 2016). Original SHP was designed to act as a plant growth regulator and as an uptake improver, behaving as a kind of catalyst and an accelerator of complex relations in the plant-soil system. As such, SHP cannot provide a sufficient amount of nutrients for crops. It is only an auxiliary mean which helps existing stocks of nutrients to be of better used and faster utilized by crops. However, since the experiment is realized on sandy soil, poor with organic matter and mineral nutrients, SHP was designed to act in the capacity of a PGR and as a mild organo-mineral fertilizer. In addition, field trials were performed in stressful conditions - increased salinity of soil and water for irrigation, drought and heat. From Physiology it is known that the consequences of salinity manifest as: water potential reduction, cell dehydration and ion cytotoxicity, while the high temperatures lead to membrane and protein destabilization (Taiz *et al.*, 2014). Thus,

apart from analyzing yields, this paper tries to answer the question - is it possible for a SHP to positively influence plant response to stress ?

## Material and method

### Special herbal preparation and its production

SHP was based on herbal extracts from comfrey (*Symphitum officinale*), dandelion (*Taraxacum officinale*), horsetail (*Equisetum arvense*), lavender (*Lavandula angustifolia*), nettle (*Urtica dioica*), yarrow (*Achillea millefolium*) and wormwood (*Artemisia absinthium*) enriched with major macronutrients (N,P,K) and essential micronutrients (Mg, Fe, Mn, Zn, Cu, B, Mo). The presence of herbal extracts were the following: comfrey and nettle by 30 % each, dandelion, horsetail and yarrow by 10 % each and lavender and wormwood by 5 % each. Participation of NPK 28-14-14 was 8,4 g/l of SHP (it was used “Solunure 5” soluble fertilizer) and of micronutrients 5,0 g/l of SHP (it was used “Nutriplex [Chelated Micronutrient Fertilizers](#)”). Chemical composition of micronutrients was the following: Mg (MgO<sub>9</sub>) – 5.43 %, Fe (EDTA) – 4 %, Mn (EDTA) – 4 %, Zn (EDTA) – 1.5 %, Cu (EDTA) – 1.5 %, B – 0.5 %, Mo – 0.1 %. SHP was produced at the Agyos Athanasios Industrial Estate, Limassol, Cyprus, according to the author’s prescription (Ljubojević and Eliseev, 2016).

From the standard set of species in SHP (comfrey, dandelion, horsetail, lemon balm, nettle, yarrow and valerian) were excluded lemon balm and valerian and included instead lavender and wormwood. Previous research has shown that extract of lemon balm has significant impact on the growth of above ground portions of leafy plant (Ljubojević, 2015), so the concern was that there might be a gap between growth and the resources available. On the other hand, to raise plant tolerance to abiotic stresses, lavender and wormwood were included (based on personal findings).

### Field trial

The experiment was designed by the author and was commissioned by Agronomy Services from Maccabim, Israel. Sample of SHP taken from the regular production was brought to the greenhouses in Gadid settlement in the Gaza Strip. Field trial lasted from July 7<sup>th</sup> to September 15<sup>th</sup> in year 1996 for cabbage (photo1) and from July 7<sup>th</sup> to September 15<sup>th</sup> in year 1996 for lettuce (photo 2), with single harvest for both crops. The results of the experiment were considered as a kind of trade secret and have not been published earlier.

Gadid is located in the southern part of the Gaza Strip, about 2 km away from the Mediterranean Sea. There is no surface water and the rainfall is below 200 mm (Dudeen, 2001). Soli type is Arenosolic (sandy) Rhogosol without a marked profile. The soil is poor with organic matter (o.m: 0.0 - 0.5 %) and has low nitrogen content (N as NO<sub>3</sub>: 15 - 30 mg/kg); pH 7.3 - 7.5. Here salinity has a huge impact on the structure of soils, affecting permeability and infiltration. Saline irrigation water, low soil permeability, inadequate drainage, low rainfall, high potential evapotranspiration, and poor irrigation management all have caused salts to accumulate in soils, which deleteriously affects crop growth and yields (cit., Sparks, 1995). According to the greenhouse owners in which the experiment was realized, "this land has the only function to hold the plant upright, and nothing else."

High input agriculture, practiced in the Gadid area at the time of the experiment, led to increased and cumulative effects of chemically based fertilizers, pesticides, and herbicides. However, high sand content of the soil pertains no toxic metals in the upper layer, but there is a risk of toxic elements leaching to the groundwater (Al-Khatib and Al-Najar, 2011).



Photo 1 : Experimental parcel with cabbage, variety `Tasty` (taken by S. Ljubojević)



Photo 2 : Experimental parcel with lettuce, variety `936` (taken by S. Ljubojević)

The subject of research were two types of leafy vegetables: cabbage (*Brassica oleracea* L.), variety `Tasty` and lettuce (*Lactuca sativa* L.), variety `936`. The planting density of cabbage was 6,500 plants per dunam (1 dunam = 1,000 m<sup>2</sup>) with spacing 45 cm x 34 cm and of lettuce 7,800 plants per dunam with spacing 40 cm x 32 cm. There were four treatments and a control group.

Treatments (T<sub>i</sub>) were as follows:

T1. SHP, standard rate

T2. SHP, double rate

T3. SHP, standard rate + NPK

T4. NPK, at a concentration of 25% of the commercial input

Control: NPK in the commercial concentration.

Compared to the classic experimental design, the control group was not with zero inputs, due to the specific conditions of the environment, in which plants would have poor opportunity for growth and development. Instead, an agrotechnic that is applied in regular (commercial) production was taken as a raper.

Treatments T1-T4 were applied by direct drench of the root system once a week, while in the control group NPK was injected through drip irrigation system during the entire week 3-4 times a day; fertilization inputs are given in table 1. Each treatment was repeated four times with random allocation on 20 m<sup>2</sup> rectangular sample blocks. From each sample block 40 heads for weighing were taken, in a systematic manner, given a total of 160 head for each species.



Table 1: Fertilization inputs

Treatments	Cabbage			Lettuce		
	SHP	NPK (7:3:7)	Number of applications	SHP	NPK (7:3:7)	Number of applications
	liters/dunam per season			liters/dunam per season		
<b>T1</b>	<b>8,5</b>	<b>-</b>	<b>7</b>	<b>8,5</b>	<b>-</b>	<b>4</b>
<b>T2</b>	<b>17.0</b>	<b>-</b>	<b>7</b>	<b>17.0</b>	<b>-</b>	<b>4</b>
<b>T3</b>	<b>8.5</b>	<b>950</b>	<b>7</b>	<b>8.5</b>	<b>430</b>	<b>4</b>
<b>T4</b>	<b>-</b>	<b>950</b>	<b>7</b>	<b>-</b>	<b>430</b>	<b>4</b>
<b>Control</b>	<b>-</b>	<b>3.800</b>	<b>many<sup>(*)</sup></b>	<b>-</b>	<b>1720</b>	<b>many<sup>(*)</sup></b>

(\*) During the whole week 3-4 times a day

At this point it should be emphasized that during the application, treatments with SHP were somewhat unequal in relation to the control group because its NPK was continuously applied through microfertigation and SHP only at certain moments. According to the contractor's explanation, this was done on the concern of clogging of the drains/sprinklers, despite the assurance that each drop of SHP was filtered to 80 microns.

### Results and discussion

The average weight of fresh cabbage head is convincingly the largest in the control group, benefiting from a huge input of fertilizer. At a given density of 6,500 plants per dunam, the expected yield is 71.5 t/ha, which is considered to be a very high yield in world relations (Sadowski and Kole, 2011). Double dose SHP (T2) achieved a solid yield of 29.9 t/ha and was significantly higher than treatment with NPK (T4). The standard dose SHP (T1) also achieved a solid yield of 26 t/ha. In both treatments with SHP, lower variability (lower C.V.) was observed in relation to the treatments with NPK (T3 and T4). The comparison of T1 and T3 treatments suggests that there was no increase in the average weight of fresh cabbage head in spite of the additional NPK imputations. Aforementioned can be explained by the discontinuous way of application, when plants, due to the poor retention capacity of sandy soil, are unable to use all that is provided through drench. Plants in the control group did not have such problems since they were continuously supplied with mineral substances dissolved in irrigated water. No signs of drying or damage to disease and pests have been registered during the experiment with cabbage.

Table 2: Cabbage performances

Parameters	Treatments				
	T1	T2	T3	T4	Control
Average weight of fresh head (g)	400	460	370	320	1100
Standard deviation (+/- g)	110	130	120	100	170
C.V. (%)	27.5	28.3	32.4	31.2	15.4
F-test	$F_o = 96.68 > F_1 = 3.06$ ↗ 95 % ↘ $n_1 = 4; n_2 = 15$				
LSD (0.05)	98.9 g				
Expected yield (t/ha)	26	29.9	24	20.8	71.5

The average weight of fresh lettuce head is also the largest in the control group, but the differences compared to the treatments are less pronounced than to cabbage. In a given density of 7,800 plants per dunam, the expected yield is 42.9 t/ha, which is considered to be a good yield in world relations (Simko *et al.*, 2014). Double dose SHP (T2) achieved a solid yield of 25 t/ha and was significantly higher than the NPK treatment (T4). The standard dose SHP (T1) also achieved a solid yield of 21.1 t/ha. In the double dose treatment of SHP, there was a lower variability (lower C.V.) in relation to treatments T1, T3 and T4. The comparison of T1 and T3 treatments suggests that there was no increase in the average weight of fresh lettuce head in spite of the additional NPK imputations. Full explanation of this has already been given to cabbage. No signs of drying or damage to disease and pests have been registered during the experiment with lettuce.

Table 3: Lettuce performances

Parameters	Treatments				
	T1	T2	T3	T4	Control
Average weight of fresh head (g)	270	320	270	210	550
Standard deviation (+/- g)	85	85	85	80	50
C.V. (%)	31.5	26.6	31.5	38.1	9.1
F-test	$F_o = 17.15 > F_1 = 3.06$ ↗ 95 % ↘ $n_1 = 4; n_2 = 15$				
LSD (0.05)	96.2 g				
Expected yield (t/ha)	21.1	25.0	21.1	16.4	42.9

### Conclusions

The results of the experiments show that the organo-mineral variant of SHP can be easily used in the production of leafy vegetables on sandy soil, under the low input agriculture. By applying only about 2.6 and 2.2 ml of the means per plant and season, without side assistance except watering, cabbage yields of about 30 t/ha and lettuce of about 25 t/ha can be achieved. No signs of drying or damage to disease and pests have been registered during the experiment with leafy vegetables, which means that abiotic stresses did not limit crop productivity and that selected SHP have been shown to mitigate unwanted phenomena. Experiences from other experiments indicate that even better results could be achieved with the foliar application of SHP or by microfertiligation. Also, it is apparent that applied commercial production of cabbage and lettuce on sandy soils (control group) was based on the huge input of fertilizers – 3,800 liter of NPK (7-3-7) per dunam of cabbage in a growing season of 65 days, and 1,720

liter of NPK (7-3-7) per dunam of lettuce in just 30 days of growing season. In other words, for one head of 1,100 g of cabbage, 585 ml of NPK is consumed, and for one head of 550 g of lettuce 220 ml of NPK. If we put aside the direct threat to a groundwater contamination, the question arises - who really needs such “fresh, crunchy green vegetable”.

### **References**

- Al-Khatib M., Al-Najar H. (2011): Hydro-geochemical characteristics of groundwater beneath the Gaza Strip. *Journal of Water Resource and Protection*, 3. 341-348
- Dudeen B. (2001): The soils of Palestine (The West Bank and Gaza Strip) current status and future perspectives. In: Zdruli P. (ed.), Steduto P. (ed.), Lacirignola C. (ed.), Montanarella L. (ed.). *Soil resources of Southern and Eastern Mediterranean countries*. CIHEAM, Bari. 203-225
- Ljubojević S. (2015): Impact of various herbal extracts on yield of lettuce. *Book of proceedings. VI International scientific agricultural symposium „Agrosym 2015“*, Jahorina, October 15-18, 2015. 1118-1126
- Ljubojević S., Eliseev I. V. (2016): Influence of special herbal preparation on growth and development of cucumber, pepper and tomato. *VII International scientific agricultural symposium „Agrosym 2016“*, Jahorina, October 06-09, 2016. 1745-1754
- Sadowski J., Kole C. (2011): *Genetics, genomics and breeding of vegetable Brassicas*. CRC Press. 1-450
- Simko I., Hayes J. R., Mou B., McCreight D. J. (2014): Lettuce and spinach. In book: *Yield gains in major U.S. field crops*. American Society of Agronomy, Inc., Crop Science Society of America, Inc., and Soil Science Society of America, Inc. 53-86
- Sparks D. L. (1995): *Environmental soil chemistry*. Academic Press, San Diego. 1-267
- Taiz L., Zeiger E., Møller I., Murphy A. (2014): *Plant physiology and development*. Sixth edition. Oxford University Press. 1-761

## **THE EFFECT OF APPLYING A TARGETED POLICY FOR DEVELOPMENT OF ORGANIC FARMING IN BULGARIA**

Monika SABEVA\*

University of National and World Economy (UNWE), Sofia, Bulgaria

\*Corresponding author: monikasabeva@abv.bg

### **Abstract**

Organic farming is an important priority for agriculture policy in Bulgaria and one of the key components of the Common Agricultural Policy (CAP) for the period 2014-2020. Encouraging farmers to switch to or to maintain organic farming contributes to both: (a) conservation environment – strengthening agro-ecosystems, protect biodiversity and enable future generations to benefit from the preserved nature; (b) production of healthy food – this form of agriculture meets the needs of the growing number of users because it uses safe and transparent methods of production; (c) social impact – creating rural employment and more jobs compared to conventional agriculture. In recent years, the awareness of consumers about the qualities of food products they consume and for the environmental protection is increasing. This leads to increased demand for organic products. The growing demand for organic agricultural production requires the introduction of specific policy measures to support and facilitate organic farming. The main objective of the paper is to analyze the overall impact of the implementation of policy measures targeted to stimulate organic production in Bulgaria in last ten years.

**Keywords:** *organic farming, Policy measures, CAP, Bulgaria*

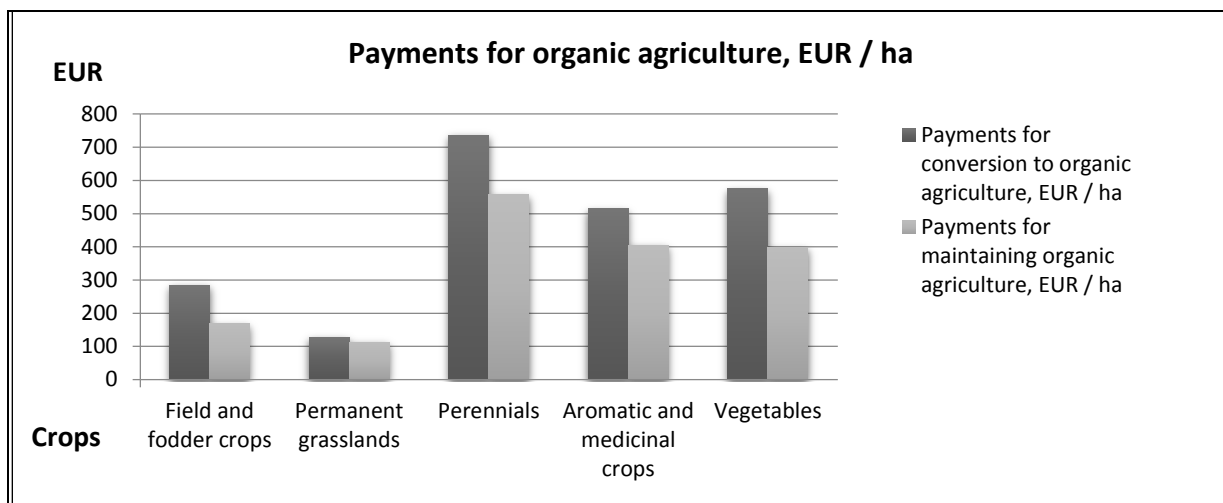
### **Introduction**

Practices of organic farming have low impact on the environment, as they avoid or drastically restrict the use of synthetic chemicals, which leads to reducing pollution of soil and water resources and the pressure on biodiversity. This improves the state of ecosystems, animal and human health, increases revenue generated, and the self-confidence of communities (Ordinance No. 1, 2013; Ordinance No. 22, 2001; Regulation (EC) No 834/2007). In Bulgaria the first steps for development of organic farming date back to the 60s years of 20th century, but only in the last 15 years the interest in this type of production has increased. The first systematic studies of the possibilities for substitution of chemical agents in agriculture date back to 1965, when in the Institute for Plant Protection the first section for exploration of biodiversity of agro-ecosystems was established (NPDOP, 2004). However, until the end of 2004 no financial support was provided to organic farmers in Bulgaria. The actual efforts to support organic farming start with the preparation of the National Plan for Development of Organic Production (NPDOP), which is in accordance with the European Plan for Organic Food and Agriculture of 2004 and was in place until 2013 (NPDOP, 2004). Organic farming is an important priority for agriculture policy in Bulgaria and one of the key components of the Common Agricultural Policy (CAP) for the period 2014-2020. Encouraging farmers to switch to or to maintain organic farming contributes to both: (a) conservation environment – strengthening agro-ecosystems, protect biodiversity and enable future generations to benefit from the preserved nature; (b) production of healthy food – this form of agriculture meets the needs of the growing number of users because it uses safe and transparent methods of production; (c) social impact – creating rural employment and more jobs compared to

conventional agriculture (RDP 2014-2020). In recent years, the awareness of consumers about the qualities of food products they consume and for the environmental protection is increasing. This leads to increased demand for organic products. The growing demand for organic agricultural production requires the introduction of specific policy measures to support and facilitate organic farming. The **main objective** of the paper is to evaluate the overall impact of the implementation of policy measures targeted to stimulate organic production in Bulgaria in last ten years.

### **Materials and methods**

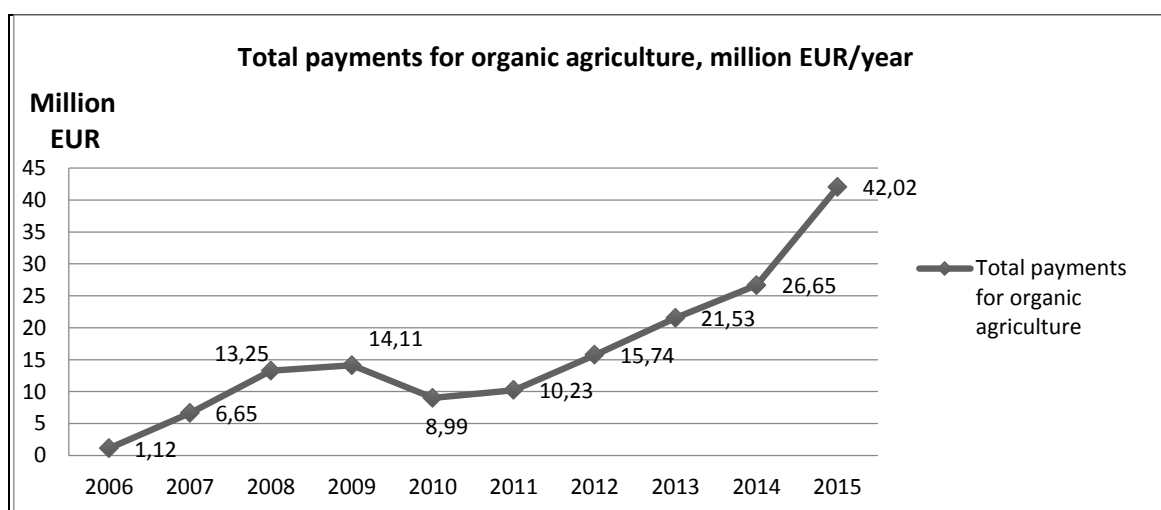
The paper is based on thorough review of reports, analysis and official documents as Agrarian reports, Rural Development Programs (RDPs), the National Plan for Development of Organic Production (NPDOP) , regulations and statistical data relating to organic farming and agricultural policy in Bulgaria. Organic production is a new branch of agricultural production and time series related to it are missing. There are data for the last 15-16 years but we can not rely on an exhausted statistical data panel. Thus the analysis is based on n available official documents and statistical information provided by the Ministry of agriculture and forestry. Data related to changes in size of areas with organic crops (as a % of UAA and as a total area), in number of operators and in total annual payments for organic farming were reviewed and, on that basis, the main effects for this sector are indicated. In the last years, organic farming is one of the sectors that is rapidly developing, as the areas and the number of operators involved in a control system are constantly increasing. This is what the targeted government policy for the sector contributes to. After the entry into force of The National Plan for Development of Organic Production (NPDOP), the targeted support of farmers applying the practices of organic farming begins. The NPDOP has 5 strategic objectives: (1) Development of the market of organic products; (2) 8 % utilized agricultural areas (UAA) to be managed organically by 2013; (3) Establishing an effective regulatory framework for the development of organic farming by 2007; (4) Practice-oriented research, educational, training and consulting activities in the field of organic farming and (5) Establishing an effective system of control and certification. For their implementation, annual financial support is provided, as for the period 2006-2013 a total of 164 544 000 BGN or 84 036 772 EUR are paid (NPDOP, 2004). The support for organic farming under the Rural Development Program 2007 – 2013 is a part of Measure 214 "Agroecological payments", aimed at supporting organic plant growing and organic beekeeping. The measure has a total budget of 435 340 701 BGN or 222 339 479 EUR (RDP 2007-2013). The reformed CAP, applicable after 2014, includes new or revised measures for support which would be applied to organic farmers. It is foreseen that 30% of the direct payments will be allocated to the so-called "green direct payments" (Regulation (EU) No 1307/2013, Article 9). During the current programming period 2014-2020, under the Rural Development Program the support for organic farming will be provided by a separate measure (Regulation (EU) No 1307/2013, Article 9) – Organic Farming comprising two sub-measures (1) Payments for conversion to organic farming per hectare UAA and (2) Payments for maintaining organic farming per hectare UAA. The support is provided under the form of annual payments per hectare of UAA (Agrarian Reports, MAF, 2013, 2014, 2015). For the current programming period payments for organic farming are provided for 5 groups of crops: (1) field and fodder crops; (2) permanent grasslands; (3) perennials (orchards and vineyards); (4) aromatic and medical crops and (5) vegetable crops from open areas (Graph 1) (RDP 2014-2020).



**Graph 1:** Payments for organic agriculture, (EUR/ha)  
Source: RDP 2014-2020

### Results and discussion

The total payments for conversion to or maintenance of organic farming are calculated in euro on the basis of data for the annual payments under the NPDOP and data for payments per hectare by crops under the RDP 2014-2020 and the Annual Agrarian Reports of MAF. On this basis, the following values were obtained (Graph 2):



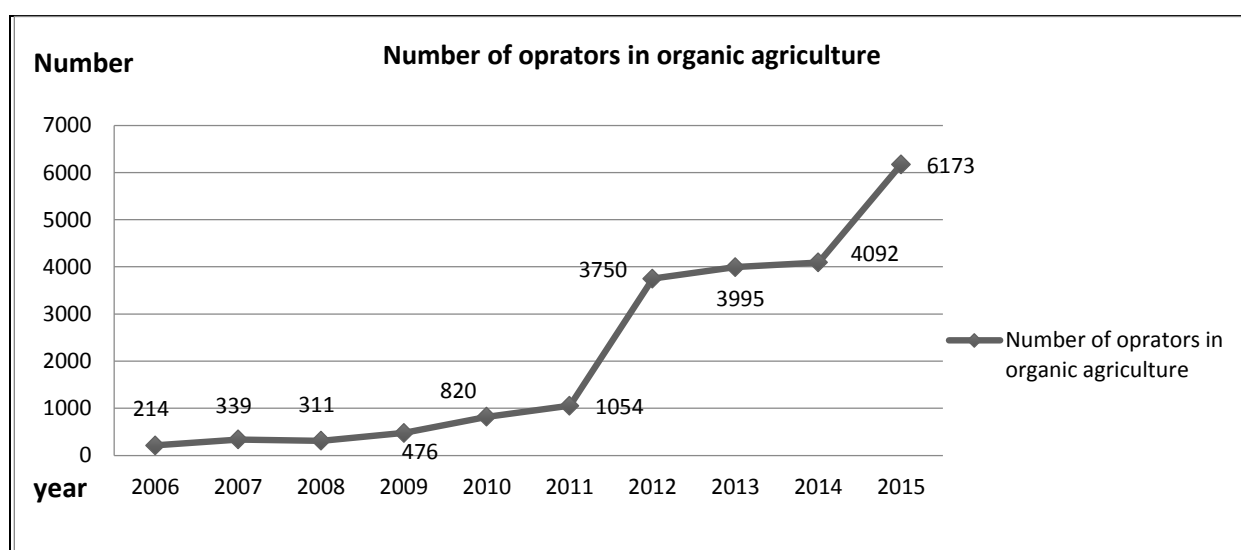
**Graph 2:** Total payments for organic farming, (Million EUR/year)  
Source: Adapted from data from the NPDOP, 2004 and Annual Agrarian Reports, MAF, 2006 – 2016

The data indicate that for the considered period, **one of the first effects** of implementing the targeted measures is that payments for organic production are constantly growing, with the exception of the period right after the beginning of the economic crisis, but after that the trend of growth remains. This is a result of the state's clear willingness to support the development of the sector, which in turn would contribute to the overall improvement of environment and improvement of the quality of life in the rural areas of the country.

The total annual payments for organic farming increased from 1,12 million EUR in 2006 to 42,02 million EUR in 2015, which is over 35 times increase for the period. As a result, by the end of 2015 the number of operators in organic farming, the size of areas in the control system and the species diversity of organically grown crops are constantly increasing.

**The second effect** of the targeted state policy to support organic farming is that the number of registered operators (producers, processors and traders) in the control system for 2006-2015 also marks a significant increase (Graph 3) – from 214 in 2006 to 6173 in 2015. This indicates that the number of registered operators in the control system has increased over 25 times over the period.

The number of operators almost stagnate between 2012 and 2014 as this is the transition period between two planning periods. This phenomenon is observed and could be traced in years before. During this time, no new calls were announced and open, consequently no possibilities for producers to diversify the funding portfolio and to enter in new areas like organic production.

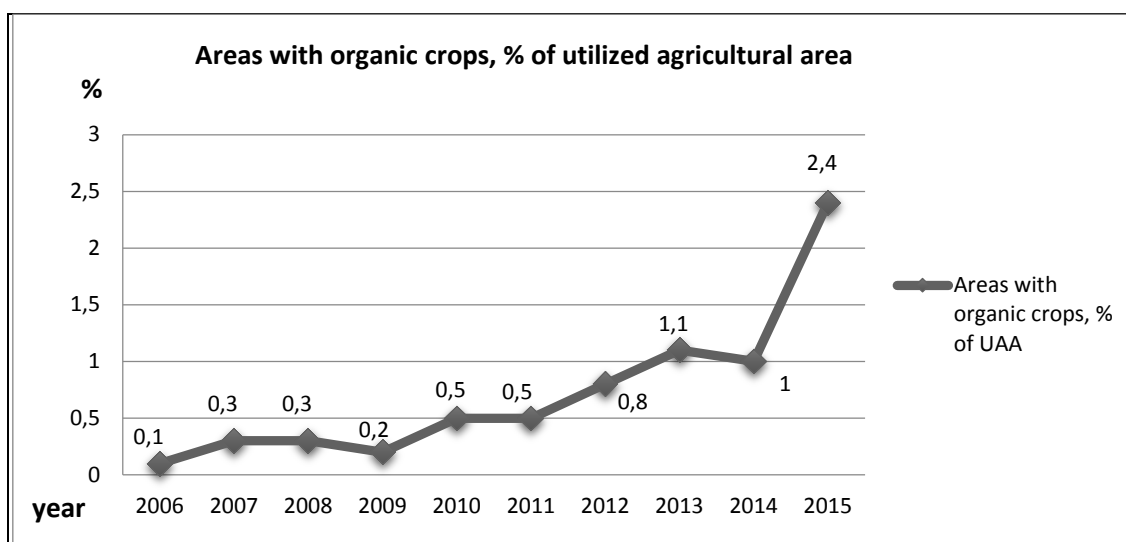


**Graph 3:** Number of registered operators in the control system of organic farming (producers, processors and traders, incl. subcontractors)

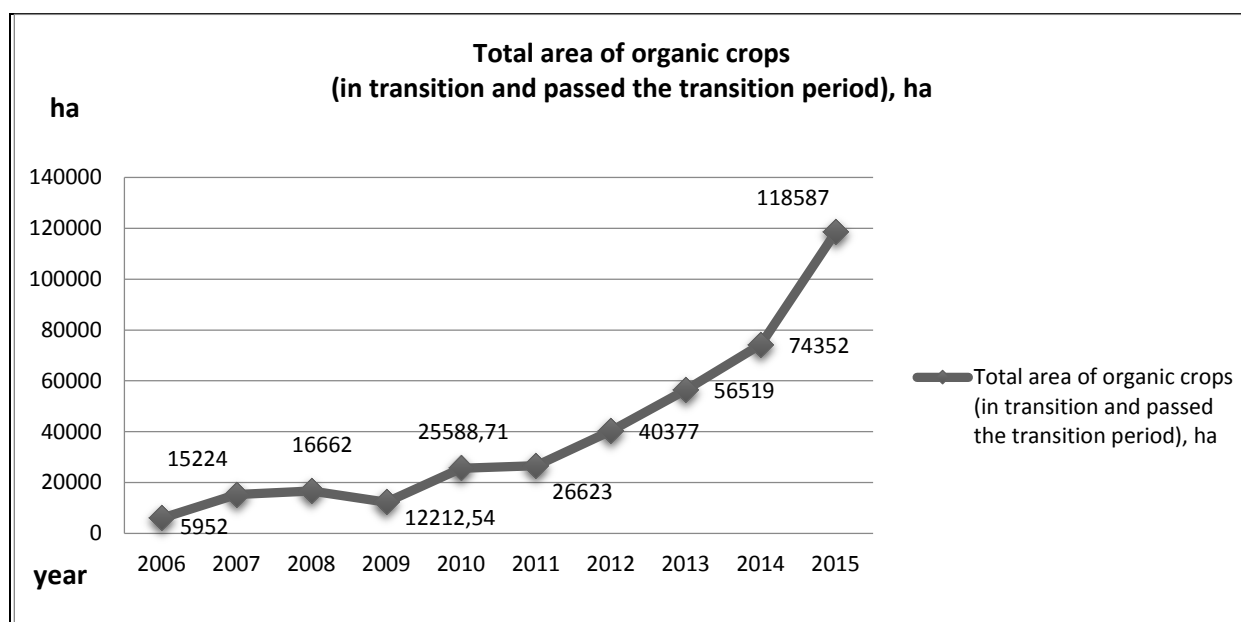
**Source:** MAF, based on data from the annual reports of the controlling authorities of organic production, 2006 – 2016

**The third effect** of the measures applied is the constant growth in the size of areas (in % of UAA and in absolute value) occupied by organically grown crops (Graphs 4, 5).

At the beginning of the period, the areas occupied with organically grown crops are 5952 ha, which is only 0,1% of the country's UAA. By the end of 2015 they have increased to 118 587 ha or 2,4% of UAA.



**Graph 4:** Areas with organic crops, % of UAA  
**Source:** Eurostat



**Graph 5:** Total area of organic crops, ha  
**Source:** MAF, based on data from the annual reports of the controlling authorities of organic production, 2006 – 2016

### Conclusion

Bulgaria has favorable opportunities for developing organic farming and taking a decent place in the still unsatisfied market niche of organic products in the EU and in the world. The targeted policy of the government over the last decade to support organic farming, in line with global efforts contributes to developing of the sector at a rapid pace. Annual payments for the period 2006-2015 increase more than 35 times. There is also a tendency of increasing in both the number of operators and in the areas and the number of animals involved in the control system. Organic production has grown significantly over the period 2006-2015. It is still oriented mainly to export of raw materials, due to poor development of both the market of



organic products and the processing facilities in the country. Increasing the share of organic farming will reduce the use of mineral fertilizers and pesticides and will reduce water pollution. This in turn contributes directly to reducing the pressure on the environment – stabilizing ecosystems, preserving and restoration of natural resources, development of rural areas and preventing land abandonment. Organic farming also leads to stabilizing farmers' incomes by entering new, emerging and developing markets for healthy food products. The main problems of organic production are associated with lower yields and high production costs, the lack of specialized equipment to maintain soil fertility and the low cost of products in transition.

### **References**

- Agrarian Report (various years from 2006 to 2016), MAF  
Eurostat, statistical data  
National Plan for the Development of Organic Production, 2004  
Ordinance No. 1 / 7.02.2013 on the Application of the Rules of Organic Production of Plants, Animals and Aquaculture, Plant, Animal Products, Aquaculture Products and Foods, Their Labeling and Control of Production and Labeling.  
Ordinance No. 22 / 04.07.2001 For organic production of plants, plant products and foods of plant origin and their Labeling (prom., SG 68 / 3.8.2001)  
RDP 2007-2013  
RDP 2014-2020  
Regulation (EC) No 834/2007 of The Council, 28 June 2007 regarding organic production and labeling of organic products and repealing Regulation (EEC) No 2092/91;  
Regulation (EU) No 1307/2013 (Article 9) of the European Parliament and The Council, 17 December 2013 establishing rules for direct payments to farmers under the CAP support schemes and repealing Regulation (EC) No 637/2008 of The Council and Regulation (EC) No 73/2009 of The Council and the relevant national legislation defining "active farmer"

## EVALUATION OF GENETIC POTENTIAL FOR ENVIRONMENTAL PLASTICITY OF MALTING BARLEY BREEDING LINES

Marina MARCHEVA\*, Silviya VASILEVA, Nevena GANUSHEVA

Agricultural University, Dept. Genetics and Plant breeding, 12 blvd., Mendeleev, 4000 Plovdiv, Bulgaria

\*Corresponding author: marina.marcheva@gmail.com

### Abstract

Climate changes impose different environmental stress, which limits plant's growth and development, the formation of yield and quality of production. Lack of sufficient moisture and lower temperature during the crops vegetation are more challenging and requires the establishment of stress-tolerant varieties with high quality and yield. Evaluation in field condition of the reaction to different abiotic stress factors is sometimes difficult due to the lack of such. Therefore, application of reliable laboratory methods for quick screening of a large amount of breeding materials on these indicators is necessary. The cold and drought resistance of 15 high yielding two-row barley breeding lines has been investigated in laboratory conditions. The laboratory trials have been conducted in Agricultural University of Plovdiv, Bulgaria by express methods of Bozhanova (1997) and Bates (1973). The evaluation of shoot and root response to osmotic stress and low temperatures as well as the accumulation of free proline in stressed young plants allows the identification of the most adaptive genotypes to unfavorable abiotic factors. The stress reaction of breeding lines 5, 13 and 45 defines them as the most cold resistant and drought tolerant, and therefore suitable germplasm in new breeding programs of winter barley.

**Keywords:** *Cold resistance, Drought tolerance, Malting barley, Osmotic stress, Plant breeding.*

### Introduction

Barley (*Hordeum vulgare* L.) is one of the main cereal crops worldwide next to the wheat, rice and maize. It is one of the multipurpose plants suitable for human food and animal feed, primary ingredient for beer and whiskey production. Barley has been cultivated for a long time in various soil and climate conditions and has been proven as the most tolerant to drought and salinity stresses among the cereals (Bornare et al., 2012). Despite this plant's growth and development, the yield stability and quality of production have been limited in the last decades by climate changes. Winter air temperatures below  $-16^{\circ}\text{C}$  to  $-18^{\circ}\text{C}$  and reciprocal raising back with amplitude more than  $20^{\circ}\text{C}$  can be very risky for winter survival of the crop. Even with normal hardening in the early winter, modern barley varieties hardly survive temperatures below  $14^{\circ}\text{C}$  at the tillering node for 24 hours without snow cover. Frost injury in barley fields is common problem for grain producers in Europe. Increasing the winter survival skills by improving the cold tolerance is still one of the main challenges for barley breeders (Marcheva and Koteva, 2014).

The lack of available water for the plant during the stages of its development remains a major limiting constraint to its productivity. Drought escape and drought avoidance are related to early maturity and maintenance of relatively high tissue water potential in poor soil humidity percentage. Survival of water deficit condition with low tissue water potential of the plant is referred as drought tolerance. It can be estimated by various physiological and biochemical

traits as proline content, soluble carbohydrates, transpiration efficiency; and morphological traits as leaf and root emergence and development, waxiness, stomatal density etc. However, the primary parameters for drought tolerance are grain yield and its stability in stress conditions. Selection on this criterion can be made under favorable or drought conditions using indices as stress tolerance index, yield stability index, and geometric mean productivity (Sio-Se Mardeh et al. 2006, Khalili et al., 2016). In the earlier stages of barley breeding evaluation of large collection of genotypes with small sets of seeds, requires reliable, quick, easy to perform and repeatable laboratory method which results represent the reaction of the adult plant in field stressed condition. Optimizing the early selection of breeding lines with good tolerance to abiotic stress factors is a precondition for improving the environmental plasticity of the next generation malting barley varieties (Blum, 2005).

The climate changes in Bulgaria imposed the necessity of breeding high yielding and adaptive to various environments genotypes. The weather conditions in the last vegetation seasons were relatively good for barley production and no risky low temperatures of droughts were presents, so breeding for abiotic tolerance was impossible in field trials. The aim of this study is quick screening by laboratory methods of the genetic potential for cold and drought resistance of malting breeding lines.

### Materials and methods

The investigation is part of a large-scale project of plant breeding of malting barley. Fifteen breeding lines (BL) of *Hordeum vulgare ssp. distichum L.* with genetically distant pedigree, created in the Department of Genetics and Plant breeding of Agricultural University Plovdiv in Bulgaria, have been evaluated in order to determine the genetic potential for yield and ecological plasticity. The genotypes are winter type, 2 rowed, awned, husked, with good productive tillering, medium height of the stem with good lodging and shattering resistance (unpublished data). Five of them have stable and higher yields of grain than the standard variety Obzor (unpublished data). The lack of limiting environmental factors as low temperatures and drought during the vegetation period of barley in the project duration imposed the necessity of laboratory testing under controlled conditions. It has been proven reliable correlation in barley plant response to stress at shoot stage and adult plant (Marcheva and Koteva, 2014). The laboratory trial has been conducted in 2015 at the laboratory of the Department of Genetics and Plant breeding of Agricultural University - Plovdiv. Each accession has been cultivated in four replicas, each with 30 seeds, under stress and with standard conditions. As a standard is used Obzor variety (one of the official standards for 2-row winter barley in Bulgaria) with cold resistance and winter hardiness group 3 by International scale. Seeds were with similar size and were collected above sieve 2.0 mm. They were soaked with distilled water and let to germinate at 24<sup>0</sup>C for a week. The cold resistance has been estimated as depression in the length of shoot and roots at the plantlets, transferred at 8<sup>0</sup>C for a week (Bozhanova and Petrova, 2000). The control has been maintained at 24<sup>0</sup>C. The osmotic stress tolerance evaluation is made on the bases of the shoot and root length depression after one-week cultivation on 1M solution of sucrose. The control is cultivated on distilled water. Coefficient of depression of shoot and root development has been calculated by the formula of Blum et al. (1980) as  $D \% = [(A-B)/A] \times 100$ , where A is average shoot/root length in control at 26<sup>0</sup>C, - B is average shoot/root length in stress at 4<sup>0</sup>C. The accumulation of free proline by Bates (1973) in barley plants, cultivated in osmotic stress conditions has been estimated. The coefficient of increase (I) is calculated as  $I = A * 100/B$ , where A is the proline content in control plant, B is the proline content in plants, cultivated under osmotic stress.

Results are analyzed by dispersion analyses.

## Results and discussion

The mild winter conditions and relatively favorable temperatures and soil humidity during the vegetation period of malting barley in three successive years of our project didn't cause any injuries of frost or drought stresses. In field trials winter survival of all breeding lines was excellent and any selection on this criterion couldn't be implemented. Drought tolerance also couldn't be evaluated in field plots in any of the years and laboratory testing of the reaction to both factors was necessary.

In our previous researches (2013 and 2014) and in many others scientific publications (Marcheva et. al., 2013; Moud and Maghsoudi, 2008) correlation of young plants reaction to low temperatures in laboratory conditions with their cold-resistance in bigger plots, cultivated in field conditions has been proven. Roots and shoots length depression of 2-row winter barley genotypes is stronger in more adaptive genotypes to the decreasing temperatures in the late autumn which stop their vegetation quickly in order to prepare for the coming winter weather. The analyze of results, obtained from the experiments conducted in the Laboratory of Genetics and Plant breeding Department, reveals serious differences regarding this indicator (Table 1). Generally, the roots reaction to low temperatures is slower than the shoot and the length decrease of the upper part of the plant is expressed more clearly in all of the observed barley breeding lines. The depression of the standard variety Obzor for root and shoot length is 11.6% and 38.3% respectively. Stronger depression of the length of the roots is observed in 4 breeding lines and for the shoots length – 7 lines. In most control plants from each genotype, cultivated in 24<sup>0</sup>C, the ratio between roots and shoots length is close to 1, with the exception of lines 17 (the length of the roots exceeds the shoots one), 29 and 77 (with more developed upper part of the plant). After cultivation for a week under temperature stress, the ratio of the roots to the shoots lengths is changed and its values are stable above one. The low-temperature protection mechanisms of the studied two-row winter barley breeding lines at this level are expressed in a strong delay in the development of the upper part of the plant and a slower decrease in root growth. By this indicator, breeding lines 5, 13 and 45 can be distinguished as the most responsive to low temperatures stress.

Table 1. Depression of the roots and shoots length of two-row winter barley breeding (BL) lines, cultivated under temperature stress at 8 °C in laboratory conditions with standard variety Obzor (St).

BL	Root length, mm			Shoot length, mm			Root / shoot length ratio	
	Control	Cold stress	Depression %	Control	Cold stress	Depression %	Control	Cold stress
<b>St</b>	157.1	138.8	11.6	165.4	102.1	38.3	0.95	1.36
<b>5</b>	157.7	125.4	<b>20.5</b> ***	148.9	87.6	<b>41.2</b> *	1.06	1.43
<b>11</b>	167.5	145.7	13.0 n.s.	152.3	87.4	42.6 *	1.10	<b>1.67</b>
<b>13</b>	150.1	121.2	<b>19.3</b> ***	154.7	90.7	<b>41.4</b> *	0.97	1.34
14	140.6	126.8	9.8 n.s.	149.5	110.8	25.9 ***	0.94	1.14
17	172.5	162.3	5.9 *	121.5	99.4	18.2 ***	<b>1.42</b>	<b>1.63</b>
18	141.3	136.2	3.6 ***	172.4	91.8	46.8 ***	0.82	1.48
23	142.2	138.7	2.5 ***	177.5	107.5	39.4 n.s.	0.80	1.29
24	156.6	140.1	10.5 n.s.	171.8	116.4	32.2 **	0.91	1.20
29	151.8	142.1	6.4 **	198.2	96.6	<b>51.3</b> ***	0.77	1.47
31	155.7	137.1	11.9 n.s.	178.4	120.1	32.7 **	0.87	1.14
33	162.1	147.4	9.1 n.s.	173.8	122.5	29.5 ***	0.93	1.20

44	154.4	142.1	8.0 n.s.	168.9	112.8	33.2 **	0.91	1.26
<b>45</b>	165.7	135.1	<b>18.5 **</b>	174.7	85.8	<b>50.9 ***</b>	0.95	<b>1.57</b>
47	164.1	131.2	20.0 ***	159.2	106.2	33.3 *	1.03	1.24
77	149.8	143.1	4.5 **	195.2	93.4	52.2 ***	<b>0.77</b>	<b>1.53</b>
Mean	155.6	138.3	10.9 n.s.	166.4	101.9	38.1 n.s.	<b>1.0</b>	<b>1.4</b>

Statistically significant differences: GD 5% - \*, GD 1% - \*\*, GD 0.1% - \*\*\*

Unlike the temperatures stress reaction in the osmotic one, it is evident that the individual part of the young barley plantlets reacts in a similar way and the ratio between the root lengths and the growth rate are kept close in the control and stress scenarios. In almost all accessions, except for breeding lines 5, 11 and 17, the upper part of the plants slightly exceeds the underground in both variants. Cultivation under osmotic stress slows the growth the standard variety Obzor by 20.2% and 18.5% of roots and shoots respectively. The significant difference is roots depression is marked for 8 genotypes, and for shoots – 9 genotypes. The smallest depression in the development of all plant shows genotypes which are tolerant to water deficit. Breeding lines 5, 13, 33 and 45 can be outlined as such (Table 2).

Another biochemical trait for estimation of drought tolerance is accumulation of free proline in plants cultivated under water stress. On drought, the increase in the amount of stress proteins in plant cells can reach up to 100 times. Due to their hydrophilic groups, the proline can bind to the hydrophilic residues of the proteins and form aggregates that are hydrophilic colloids. Thus, it acts as an osmotically active substance, favoring the retention of water in the cells, while protecting the proteins from denaturing. Additionally, it also appears as an organic nitrogen reserve to overcome the effects of drought.

Table 2. Depression of roots and shoots length of two-row winter barley breeding lines (BL), cultivated under osmotic stress of 1M sucrose solution in laboratory conditions compared with standard variety Obzor (St).

BL	Root length, mm			Shoot length, mm			Root / shoot length ratio	
	Control	1M sucrose solution	Depression %	Control	1M sucrose solution	Depression %	Control	1M sucrose solution
<b>St</b>	157.1	125.4	20.2	165.4	134.8	18.5	0.95	0.93
5	157.7	143.8	<b>8.8 ***</b>	148.9	141.9	<b>4.7 ***</b>	<b>1.06</b>	1.01
11	167.5	143.1	14.6 **	152.3	137.2	9.9 ***	<b>1.10</b>	1.04
13	150.1	135.3	<b>9.9 ***</b>	154.7	143.6	<b>7.2 ***</b>	0.97	0.94
14	140.6	113.1	19.6 n.s.	149.5	127.5	14.7 *	0.94	0.89
17	172.5	134.8	21.9 n.s.	121.5	105.7	13.0 **	<b>1.42</b>	1.28
18	141.3	108.5	23.2 *	172.4	113.7	34.0 ***	0.82	0.95
23	142.2	113.7	20.0 n.s.	177.5	127.5	28.2 ***	0.80	0.89
24	156.6	102.3	34.7 ***	171.8	134.5	21.7 *	0.91	0.76
29	151.8	128.1	15.6 *	198.2	154.2	22.2 *	0.77	0.83
31	155.7	140.1	10.0 ***	178.4	158.4	11.2 ***	0.87	0.88
33	162.1	145.8	10.1 ***	173.8	159.2	<b>8.4 ***</b>	0.93	0.92
44	154.4	132.7	14.1 **	168.9	144.7	14.3 *	0.91	0.92
45	165.7	150.3	<b>9.3 ***</b>	174.7	156.5	<b>10.4 ***</b>	0.95	0.96
47	164.1	114.8	30.0 ***	159.2	135.1	15.1 *	1.03	0.85
77	149.8	119.5	20.2 n.s.	195.2	135.3	30.7 ***	0.77	0.88
Mean	155.6	128.2	<b>17.6 *</b>	166.4	138.1	<b>16.5 *</b>	<b>0.95</b>	<b>0.93</b>

In a laboratory test carried out in December 2014 at the Department of Plant Physiology and Biochemistry in Agricultural University Plovdiv, the measurement of free proline content (Bates et al., 1973) was determined in young barley plants placed under osmotic stress conditions. In winter barley breeding lines, its content varies widely in both control and stress conditions (Table 3). The genotypes studied have a different response to applied stress, with levels of free proline changing in a different way. The control plants of line 18 have nearly three times more proline in their leaves compared to line 23 and twice then the standard variety Obzor. On osmotic stress BL18 increases the synthesis of this amino acid only 7 times. For comparison, in the stressed plants, the majority of the samples recorded values exceeding 13 to 37 times those of the control variant from the same genotype. Six of our breeding lines have bigger increase of free proline content in stressed plants than the standard Obzor. The response of lines 5, 13 and 45 on this indicator is particularly strong and determines them as drought-tolerant and suitable for inclusion in selection programs in this direction.

Table 3. Free proline content in two-row winter barley breeding lines (BL) cultivated under osmotic stress in laboratory conditions, compared with standard variety Obzor (St).

Proline content, µg/g FW				Proline content, µg/g FW			
BL	Control	Osmotic stress	I*	BL	Control	Osmotic stress	I*
<b>St</b>	67.3	1535	23	24	54.5	417	8
5	67.4	2947.1	<b>44</b>	29	49.7	872.1	18
11	61.3	1843.5	30	31	57.5	1573.6	27
13	58.1	1924.5	<b>33</b>	33	84.6	1668.3	20
14	76.2	1944.1	26	44	79.4	1532.1	19
17	65.3	1767.9	27	45	72.3	2683.6	<b>37</b>
18	<b>119.8</b>	850.8	7	47	87.6	670	8
23	46.1	603.8	13	77	82.5	1042.8	13

\* The coefficient of increase (I) is calculated as  $I = \text{Control} * 100 / \text{Osmotic stress}$ .

### Conclusion

Analyses of data from laboratory testing of cold resistance and drought tolerance in quick screening methods of Bozhanova (2000) and Bates (1973) of 15 breeding lines of 2-row winter barley *Hordeum vulgare ssp. distichum L.* emphasizes the good genetic potential for ecological plasticity of three genotypes – BL 5, BL 13 and BL 45. Also taking into account other results of the studies of the elements of the productivity, disease resistance of productive potential under different environmental conditions, we can distinguish these genotypes as suitable for further breeding studies.

### Acknowledgement

Financial support from the by Scientific research center of the Agrarian University - Plovdiv of the project "Plant breeding evaluation of the genetic potential of productivity and ecological plasticity of 2-row barley breeding lines in accordance with the global climate changes" is gratefully acknowledged.

### References

- Bates L. S., Waldren R. P., Teare I. D. (1973) Rapid determination of free proline for water-stress studies, *Plant and soil*, vol.39 (1), pp. 205-207.
- Blum A. (1989) Osmotic Adjustment and Growth of Barley Genotypes under Drought Stress, *Crop Sci*, vol. 29, pp. 230-233.
- Blum A. (2005). Drought resistance, water-use efficiency, and yield potential - are they compatible, dissonant, or mutually exclusive? *Australian Journal of Agricultural Research*, vol. 56, pp. 1159–1168.
- Bornare L.C., Prasad R., Lal J. P. (2012) Perspective of barley drought tolerance; methods and mechanisms comparable to other cereals, *Journal of Progressive Agriculture*, vol.3 (2), pp. 68 -70.
- Bozhanova V., Petrova T. (2000) Wheat genotypes evaluation in relation to their cold resistance, *Rasteniewydni nauki*, vol. 37, pp. 705 – 707.
- Khalili M., Pour-Aboughadareh A., Naghavi M. R. (2016) Assessment of drought tolerance in barley: integrated selection criterion and drought tolerance indices, *Environmental and Experimental Biology*, vol. 14, pp. 33–41.
- Marcheva M., Popova Z., Vasileva S. (2013). Evaluation of osmotic stress response of specimens from durum wheat (*Triticum durum* Desf.) local populations. *Agrarni nauki*, vol. IV (12), pp. 31-36.
- Marcheva M., Koteva V. (2014) Investigation of the Cold Resistance of Two-row Winter Barley Cultivars (*Hordeum vulgare* ssp. *distichum* L.), *Turkish Journal of Agricultural and Natural Sciences*, Special Issue: 2, pp. 1660-1664.
- Moud A., Maghsoudi K. (2008) Application of coleoptile growth response method to differentiate osmoregulation capability of wheat cultivars. *Research Journal of Agronomy*, vol. 2, pp. 36-43.
- Sio-Se Mardeh A., Ahmadi A., Poustini K., Mohammadi V. (2006) Evaluation of drought resistance indices under various environmental conditions, *Field Crops Res.* 98, pp. 222–229.

## **THE CAUSAL ANALYSIS OF FARMERS' ATTITUDES TOWARDS ADOPTION OF ORGANIC FARMING PRACTICES: EVIDENCE FROM TURKEY**

Nuray ÇAKIRLI\*, Ludwig THEUVSEN

Department of Agricultural Economics and Rural Development, Agribusiness Management,  
University of Goettingen, Germany

\*Corresponding author: nuray.cakirli@agr.uni-goettingen.de

### **Abstract**

Acceptance of technology innovations is complex issue. Moreover, there is little known on farmer's perceptions and attitudes towards acceptance of organic agricultural practices. This paper investigates the behavioral drivers of farmers with respect to the adoption of organic practices by comparing conventional and organic farmers. The attitudes of farmers in relation to adoption of organic farming practices are examined by comparing Turkish organic (N=131) and conventional (N=144) growers. The modified model from related models which are proposed in the context of the study has adapted and used to enhance a comprehensive analysis of the farmers' adoption decisions. The partial-least squares-structural equation modelling based multi-group analysis was performed in order to investigate group differences. The estimation results showed significant differences between the groups. The group comparison indicated that perceived output quality, perceived costs, and perceived usefulness have influences on the attitudes of farmers' decisions with respect to organic farming practices.

**Keywords:** *Adoption, organic farming, attitude, adoption, partial least square, structural equation modeling*

### **Introduction**

Individual's adoption behavior is considered as an important parameter to accept new technologies. In addition to the adoption theory by Rogers (1983), behavioral approaches have also been investigated for analyzing adoption processes. Whereas the studies based on Rogers' adoption theory dealt with the technical view, behavioral research approaches focus on unobservable determinants of adoption. From the latter perspective, the most popular theoretical approaches are known as Theory of Reasoned Action (TRA) (Ajzen, 1991) and an extended version of the Theory of Planned Behavior (TPB). The TPB, developed by Fishbein and Ajzen (1975), consider the impact of subjective norms, attitudes, and perceived behavioral control on the intentional and observable characteristics towards adoption of an innovation. There have been vast studies explain adoption process with TPB (Herath and Wijekoon, 2013; Hattam, 2006). However, several difficulties in applying TPB and explaining the behavioral drivers directed researchers to apply different models to understand farmers' perceptions and attitudes on the organic production and certification system, such as Technology Acceptance Model (TAM) (Davis, 1989), as it is a well-known modification of the TPB and TRA models (Jahn and Spiller, 2005; Schulze et al., 2007).

An extensive organic conversion literature also addresses the motivational aspects such as financial motives, farming related motives, as well as personal motives. For instance, some adoption literature led to a general outcome that financial motives such as price premiums, subsidy payments, cost saving are the main reasons for farmers to convert to organic agriculture (Vogtmann et al., 1993). However, studies advise caution against generalizations on the economic reasons in conversion decision, since much research identified non-profit



aims and the importance of other motivational factors (Fowler et al., 2000; Offermann and Nieberg, 2000).

Understanding factors influence adoption, in terms of acceptance of a new technology, has been a long-standing issue in agricultural economics and social development research. The wide range of studies on the farmers' decision making attitude shows that it is still challenging to understand concept of technology adoption. This may get more complex in developing countries, since many farmers have been scaled as small adopters (Herath and Wijekoon, 2013). Therefore, the concept of farmers' attitude and intentions is an important research area in agricultural literature. On the base of this literature background, we suggest that innovations can be adopted more easily if they correspond not only with the financial, economic and demographic factors, but also link to the main aspects of the farmers' perception and their attitudes. In this respect, it has an essential role to understand farmers' intentions towards organic farming.

The present study is designed to examine farmers' technology acceptance towards organic agriculture, by comparing Turkish organic and conventional growers. In order to identify what factors might lead to formation of attitudes towards behavioral intentions we use a modified model of the TPB and the TAM, which are proposed in the context of the study. A comprehensive analysis of the farmers' attitudes and intentions are employed using the partial-least squares (PLS) structural equation modelling. The multi-group analysis (MGA; Sarstedt et al., 2011) is performed in order to investigate group differences.

## Materials and Methods

### Research framework and hypotheses

The conceptual framework introduced in the study is based upon the TPB and the TAM theoretical frameworks. Behavioral intention (to continue to use, or to adopt), that is, the explanandum in the TPB and the TAM, is replaced by intention to adopt/intention to continue in our framework. Perceived ease of use, as a construct from the TAM is replaced by perceived costs which can be considered relevant for both economic and bureaucratic costs. Subjective norm is replaced by perceived internal pressure. We take into consideration not only social pressures but also other type of pressures that might take place in farmers' environment. Therefore, the external environment takes place as perceived external pressure in the model. Perceived usefulness, perceived output quality, and result demonstrability are adapted from TAM model. The model is illustrated in Figure 1 and explained below in detail. In our perception-based research framework the basic assumption is that organic adoption behavior is influenced by the attitudes of farmers. Attitudes may depend on subjective perceptions, cost and benefit evaluations of the farmers concerning the usefulness of organic production. Perceived social influence show to what degree normative beliefs can be significant on the performance of attitude. This construct corresponds to the perceived social belief of a person, who anticipates being approved or supported by a person or surrounded group of people with respect to specific attitude (Ajzen, 1991). The influence of others such as family members, neighbors, relatives can influence social pressure of the individuals about a given behavior (Park, 2000). Therefore, we assume that perceived internal pressure has a positive influence on attitude (*H1*). Apart from the internal subjective norms, the external interested group effect on the attitudes is measured subjectively from the viewpoint of perceiver. Different adopters might perceive the primary features of an adoption in different ways and this eventually might lead different attitudes and behaviors (Kossahl et al., 2012). Thus, it is important to measure potential pressure from these groups to consider the different subjective behaviors of the adopter. In this regard, we propose perceived external pressure has a positive influence on attitude (*H2*). Perceived usefulness (Venkatesh and Davis 2000)

explains the degree to which an individual believes that using the system will help to attain gains in job performances. The farmers perceive improvements in performance through implementing certified organic production. To see whether organic produce enhance farmers' success and competitive power, we hypothesize that 'the greater the perceived benefit (usefulness) of organic agriculture, the more pronounced in the attitudes towards the organic adoption (H3). The perceived costs construct is defined as the effort which a farmer perceives by fulfilling the requirements for organic certification. The definition of the cost primarily refers the costs necessary for formalization procedures in enterprises. For instance, certification process in organic production deals with several steps such as documentation, registration, process modifications, and organizational adaptation to the procedures, which might all brings bureaucratic burden (Jahn and Spiller 2005). Against this background, we assume the two following two hypotheses; Perceived costs has a negative influence on perceived usefulness (H4), Perceived costs has a negative influence on attitude (H5). The TAM model proposes that the perception of benefits of a technological innovation is positively influenced by the demonstrable results that encompasses the degree of the tangibility of the results by using the innovation (Moore and Bensabat, 1991). To this, we hypothesize that result demonstrability has a positive influence on perceived usefulness (H6). The perceived output quality (Venkatesh and Davis, 2000) explains how well a system realizes its technical capability, that is, the degree to which a farmer believes that the system performs related activities well. For the acceptance of a technology innovation, it is also important to know whether problems associated with the use of technology improvements are only internally visible, or also they are recognized by externals (Agarwal and Prasad, 1997). We assume that, the visible performance from the organic production resulting positive effect and impact on the perceived usefulness of practicing organic agriculture. Therefore, we propose that perceived output quality has a positive influence on perceived usefulness (H7). According to the TAM model explained by Venkatesh and Davis (2000), we presume adoption or continuity of organic farming is the result of the attitudes in this particular object. The TPB also states that, the more a person tends to perform behavior, the greater the likelihood that the behavior will actually performed (Ajzen, 1991). To this, we hypothesize attitude has positive influence on behavioral intention (H8).

Research framework is given as Figure 1.

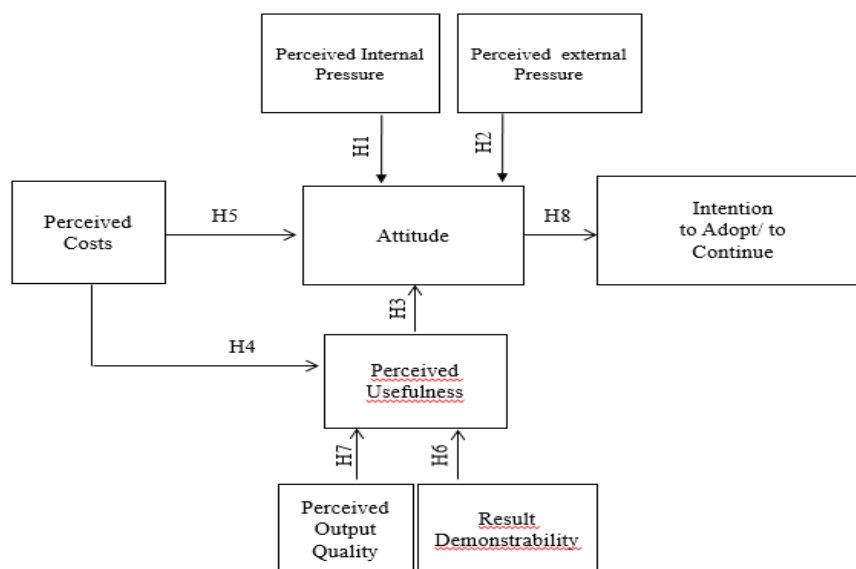


Figure 1: Research Model (Authors' illustration)

## Sample and Methodology

The cross-sectional data employed in the study was collected during a comprehensive survey of farmers via face-to face interviews in 2015. The number of questions (cf. Table 1) eliciting farmers' perceptions, attitudes, and intentions were included and measured with five-point Likert scales. The full sample after data cleaning consisted of observations from 144 conventional and 131 organic producers. The research model used in the study (cf. Figure 1) has structured as an extended from different model frameworks, the TPB and the TAM, which are developed and used to identify the factors influencing adoption of, not only technologies in information systems but also choices of alternatives in agriculture and food technologies. The data was analyzed by applying structural equation modeling methods in the SmartPLS 3 (Ringle et al., 2015) statistical software. The analysis of PLS models entail two-stage approach which are an assessment of the reliability and validity of the measurement model, and an assessment of the structural model (Hair et al., 2013). After the research model was built into SmartPLS, the PLS Algorithm, bootstrapping procedures and the MGA were employed in the software.

## Results and Discussion

### Assessment of the measurement model

The constructs indicated in our model are used and each construct is measured by assigned observable items. Before starting the analyses, a confirmatory factor analysis are employed to identify the relevant items for each latent variable (construct). Afterwards, we checked construct reliability and internal consistency with the help of Cronbach's alpha and composite reliability (CR) (Hair et al., 2013). The suggested values of Factor loadings ( $\geq 0.70$ ), Cronbach's Alpha (CRA) ( $\geq 0.70$ ), composite reliability (CR) ( $\geq 0.70$ ) are met. In order to measure the discriminant validity, the average variance extracted (AVE) with the Fornell-Larcker criterion was tested (Fornell and Larcker, 1981). The suggested value of AVE ( $\geq 0.50$ ) (Chin, 1998), and for AVE was reached for all constructs. The measurement model was proven by having satisfactory results with respect to all above mentioned parameters. CR and AVE results were given in Table 1 for both organic and conventional farmer groups. Data analysis also revealed that there was no evidence of any cross-loadings and multicollinearity.

**Table 1** Results of the evaluation of the Measurement Model

Construct (latent variable)	Indicator variable (OF=organic farming)	Organic		Conventional	
		CR	AVE	CR	AVE
		$\geq 0.7$	$\geq 0.5$	$\geq 0.7$	
-Perceived 0.794	Family members encourage farmers to practice OF.	0.954	0.838	0.939	
Internal Pressure (PIP)	Family members support farmers to fulfill the requirements of OF. Organic farmers convert because their neighbors also do OF. Local community prefers organically farmed food.				
-Perceived 0.719	The buyers control the farmers whether they keep close to guidelines.	0.932	0.775	0.911	
External Pressure (PEP)	NGOs motivate farmers to convert to OF. Consumers prefer organically farmed food. Government support accelerates adoption of OF.				
-Perceived Costs (PC)	Organic farms have higher input costs than conventional farms. The expenditures for land preparation in OF is high. The costs for the organic certificate are high.	0.941	0.800	0.918	0.737
-Perceived Usefulness (PU)	The certification control system is very bureaucratic. Organic farming increases business relationships. Organic farming increases income.	0.941	0.800	0.945	0.812

	Organic production means having respect to the society and next generations.				
	OF increases farmer health.				
-Perceived Output Quality (POQ)	The quality of organic products is better than conventional products.	0.857	0.670	0.934	0.826
-Result Demonstrability (RD)	Conventional agriculture is more profitable than OF. OF products are free from chemical residues.				
Attitude	The results of OF can always be proofed to interested stakeholders. With OF a farmer can achieve higher prices. A farmer can precisely define the costs from and the benefits of OF.	0.891	0.731	0.933	0.823
-Intention (to adopt)	I think that it is reasonable to use OF system. I assume that conversion to OF is essential to survive in farming.	0.958	0.919	0.916	0.846
-Intention (to continue)	I plan to register for certified organic production within a year. I have concrete plans to adopt OF with in next five years. I will continue to use my OF system.	0.953	0.910	0.847	0.736
	I have concrete plans to further develop my OF system within a year.				

Source: Authors' illustration.

### Hypotheses testing, results of the multigroup analysis

In order to evaluate group differences on the base of the proposed research model, we tested the hypothesized relationships for both subsamples. In the model each path is characterized by each hypothesis and path coefficients. The path coefficient values can be interpreted as follows: >0.35 strong influence, >0.15 moderate influence, >0.02 weak influence (Cohen, 1988). Correspondingly, the t-values as the other indicator values of a good structural model are calculated using bootstrapping method. The final results of the calculations for the path coefficients, t-values, and p-values are depicted in Table 2. With respect to the analysis of the group differences, the bootstrap results for PLS-MGA show significant differences in the path coefficients for perceived output quality and perceived cost on the perceived usefulness show significant differences between the groups (IdiffI=0.197\*\* and IdiffI=0.337\*\*\* respectively). Similarly, path coefficients for perceived cost and perceived usefulness on the attitude show significant differences between the groups (IdiffI=0.305\*\* and IdiffI=0.328\*\*\* respectively). These significant differences confirm the hypotheses H3, H4, H5, and H7. Similar correlations regarding organic agricultural adoption have been resulted in the studies of Schulze et al. (2007) and Bravo et al. (2012), but the finding is not supported by the studies of Herath and Wijekoon (2013) which investigates behavioral differences between organic and non-organic coconut growers.

**Table 2 Results of the evaluation of the Structural Model and multi-group analysis**

comparison	Conventional		Organic			Goup	
	Path coeff.	t-value	p-value	Path coeff.	t-value	p-value	IdiffI
RD->PU 0.203	0.284***	3.491	0.001	0.194**	2.497	0.013	0.090
POQ->PU 0.040	0.291***	3.639	0.000	0.095	0.910	0.363	0.197**

PC->PU	0.130 0.377***0.001	1.488	0.137	-0.247***	3.046	0.002		
PC->ATT	0.187*** 0.001	2.658	0.008	-0.118*	1.877	0.061	0.305**	
PEP->ATT	0.367*** 0.477	4.789	0.000	0.359***	3.746	0.000	0.007	
PIP->ATT	0.164** 0.960	2.221	0.019	0.382***	3.833	0.000	0.218	
PU->ATT	0.313*** 0.328***0.002	5.016	0.000	-0.015	0.166	0.868		
ATT->INT	0.866***	43.618	0.000	n/a <sup>1</sup>	n/a <sup>1</sup>	n/a <sup>1</sup>	n/a <sup>2</sup>	n/a <sup>2</sup>
(INT to Adopt)								
ATT->INT (INT to Continue)	n/a <sup>1</sup>	n/a <sup>1</sup>	n/a <sup>1</sup>	0.830 ***	26.100	0.000	n/a <sup>2</sup>	n/a <sup>2</sup>

**Source:** Authors' own calculation. n/a<sup>1</sup>=Not applicable. Since the items of *Intention* differ in definition of two groups as *intention to adopt* and *intention to continue*. n/a<sup>2</sup>=Not applicable. Related group differences could not be calculated by SmartPLS software. \*/\*\*/\*\*\*: p <0.1/0.5/0.001

### Conclusions

In the foregoing research, the examination of perceptions and attitudes of conventional and organic growers was carried out by use of an extended acceptance model of TPB and TAM. As a consistent result to our expectations, perceived cost and perceived usefulness are significant challenges impeding technology adoption. Surprisingly but very possible to the current market and certification process of the organic products (Demiryörek, 2008), cost is not perceived highly significant influence factor for conventional farmers comparing to organic farmers. Additionally, conventional farmers perceive greater usefulness of the organic systems than organic farmers. this is one of the important conclusion that, in the line with the growing economic pressure and the propagation of organic production (Aksakal, 2016), these results can be further considered by practitioners and policy makers. To this, implementing solutions to improve and expand organic agricultural adoption shall be addressed and maintained not only convince farmers to convert their land into organic farming system, also to keep organic farming as a continuous production.

### References

- Ajzen I. (1991). The Theory of Planned Behavior. *Organizational Behavior and Human Decision Processes*. 50, pp. 179-211.
- Aksakal, V., Haşimoğlu, S. Bayram B., Dellal G., Erdoğan Y. (2014). Sustainability organic agriculture and Livestock production with respect to EU in Eastern Anatolia and East Black Sea regions. *Turkish Journal of Agriculture-Food Science and Technology*. 4(11). Pp. 1024-1030.
- Bravo, C.P., Spiller, A. Villalobos P. (2012). Are organic growers satisfied with the certification system? A causal analysis of farmers' perceptions in Chile. *International Food and Agribusiness Management Review*, Vol. 15, (4), pp. 115-136.
- Chin W.W. (1998). The PLS approach to structural equation modelling. In: Marcoulides. G.A.(ed.). *Modern Methods for Business Research*. pp. 295-358.
- Cohen J. (1988). *Statistical Power analysis for the Behavioral Sciences*. Lawrence Erlbaum, Hillsdale.

- Davis, F.D. (1989). Perceived usefulness, perceived ease of use, and user acceptance of information technology. *MIS Quarterly* 13(3), 319-340.
- Demiryürek K. (2008). Organic agriculture: The case of Turkey. [https://www.researchgate.net/publication/233596391\\_Organic\\_agriculture\\_The\\_case\\_of\\_Turkey](https://www.researchgate.net/publication/233596391_Organic_agriculture_The_case_of_Turkey). Accessed on 06.03.2016.
- Fishbein, M., Ajzen, I. (1975). *Belief, attitude, intention, and behavior: An introduction to theory and research*. Reading, MA: Addison-Wesley.
- Forner, C., Larcker D.F. (1981). Evaluation structural equation models with unobservable variables and measurement error. *Journal of Marketing Research*. 18, pp. 39-50
- Fowler S.M., Lampkin, N.H., Midmore P. (2000). Organic farm incomes in England and Wales 1995/1996. Report for MAFF ref. OF0125. [http://orgprints.org/8278/1/Organic\\_Farm\\_Incomes\\_03-04.pdf](http://orgprints.org/8278/1/Organic_Farm_Incomes_03-04.pdf). Accessed on 01.06.2017.
- Hair J., Hult G.T., Ringle, C. M., Sarstedt M., (2013). *A primer on Partial Least Squares Structural Equation Modeling*. 2nd Edition. Sage Publications. UK.
- Hattam C. (2006). *Adopting organic agriculture: An investigation using the Theory of Planned Behavior*. <http://orgprints.org/10182/>. Accessed on 01.03.2016.
- Jahn G., Spiller A. (2005). Acceptance of processor-driven quality management system by dairy farmers: a structural equation model. Prepared to present 92nd EAAE Seminar. Göttingen.
- Kossahl J., Kranz Johann, Opitz, N. Kolbe, L.(2012). A perception-based model for smart grid adoption of distribution system operators. *Iss. For Information Systems*. [http://aisel.aisnet.org/amcis2012/proceedings/Posters/52?utm\\_source=aisel.aisnet.org%2Famcis2012%2Fproceedings%2FPosters%2F52&utm\\_medium=PDF&utm\\_campaign=PDFCoverPages](http://aisel.aisnet.org/amcis2012/proceedings/Posters/52?utm_source=aisel.aisnet.org%2Famcis2012%2Fproceedings%2FPosters%2F52&utm_medium=PDF&utm_campaign=PDFCoverPages). Accessed on 20.05.2017
- Moore G.C., Bensabat I., (1991). Development of an instrument to measure the perceptions of adopting an information technology innovation. *Information Systems Research*. (2)3. pp.192-222
- Offermann, F., Nieberg H. (2000). Economic performance of organic farms in Europe. *Organic farming in Europe: Economics and Policy* 5. University of Hohenheim. Hohenheim.
- Park, H.S. (2000). Relationships among attitudes and subjective norms: Testing the theory of reasoned action across cultures. *Communication Studies*, Vol.51 Iss. 2
- Ringle, C.M., Wende, S., Becker, J.-m(2015). *SmartPLS 3*. Boenningstedt:SI-martPLS GmbH, [www.smartpls.com](http://www.smartpls.com). Accessed on 27.06.2017(2007).
- Rogers E.M. (1983). *Diffusion of Innovations*. FP. The Free Press. Macmillan Publishing Co. New York.
- Sarstedt, M., Henseler, J., Ringle, C.M. (2011). Multigroup analysis in partial least squares path modeling. In: Sarsstedt, Schwaiger, M. Taylor C.R. (Eds.) *Measurement and Research Methods*. Gmerald Group Publishing Ltd. Pp. 195-218.
- Schulze H., Jahn G., Spiller A. 2007. Acceptance of the organic certification system by farmers in Germany. The 17th IAMA World Forum and Symposium, Parma 2007.
- Venkatesh V., Davis F.D. (2000). A theoretical extension of the technology acceptance model: four longitudinal field studies. *Management Science* 46 (2), 186-204.
- Vogtmann, H. (1993). Conversion to low external input farming; a survey of 63 mixed farms in West Germany. Paper presented at the Agroecology and Conservation Conference. Padua.

## **YIELD PRODUCTIVITY OF SAGE (*SALVIA OFFICINALIS* L.) ORGANIC CULTIVATION UNDER DIFFERENT WATER AND NITROGEN INPUTS AND PLANT POPULATIONS IN CENTRAL GREECE: FIRST YEAR RESULTS**

Faik KAMPERLLARI<sup>1</sup>, Elpiniki SKOUFOGIANNI<sup>1</sup>, Kyriakos D. GIANNOULIS<sup>1</sup>,  
Dimitrios BARTZIALIS<sup>1</sup>, Nicholaos G. DANALATOS<sup>1</sup>

University of Thessaly, Dept. of Agriculture, Crop Production & Rural Environment, Volos, Greece

\*Corresponding author: kamperll@uth.gr

### **Abstract**

Sage herb (*Salvia officinalis* L.) comprises an important medicinal and aromatic plant, well-known for its various uses in medicine, as well as in cosmetic and food industries. The present work focuses on the productivity of a biologic cultivation of sage, obtained in the first growth (establishment) year under different water and nitrogen inputs and plant populations on a SL soil in central Greece. A split-split plot field experiment was established in three replicate blocks in November 2016. Rainfed and irrigated condition applied comprised the main plots with the irrigated plots receiving 100% of ETo (100 mm) until the harvest of the crop in late May 2017. Plant population in two levels (D1: 20x50cm, D2:40x50cm) comprised the subplots and in the sub-sub plots nitrogen fertilization in three levels (N0:0, N4:40, N8:80 kg Nha<sup>-1</sup>). The results showed the positive effect of irrigation on yield traits such as plant height, chlorophyll content and dry matter produced, especially for the denser plant population. Actually, irrigation increase sage yields in half: from 900 kg dm ha<sup>-1</sup> (rainfed crop) to over 1500 kg ha<sup>-1</sup> for the plants receiving 100 mm of irrigation water. The positive effect of irrigation was significantly more pronounced to the denser population, whereas nitrogen fertilization did not show a significant effect on productivity, apparently due to the high fertility status of the studied soil. Such results are important and may assist future cost/benefit analyses concerning the introduction of sage as an important aromatic/medicinal plant in crop rotation schemes in near future in Greece and more generally in Mediterranean places.

**Keywords:** *Sage, irrigation, fertilization, plant density, aromatic plants, medicinal plants.*

### **Introduction**

The genus *Salvia* belongs to the family of Lamiaceae and it is a perennial woody shrub which it is native to the Mediterranean countries. The commercial value of the plant is its leaves that are used as a raw materials in perfume, in food industry and in medicine (Bruneton, 2001). Water is one of the most valuable sources of our planet and its consumption in many area of Mediterranean countries which are characterized by rainy winters and dry, warm summers is an important tissue. Species of sage are characterized as xerophytes and especially *Salvia officinalis* L. is a drought-susceptible species which means that its demands on water is low (Munne-Bosch *et al.*, 2001). Optimum planning density is the key for obtaining the maximum crop production especially, in case of deficiency in water as it happens in Mediterranean countries. Better understanding of relationship of irrigation and plant density is the key to schedule better irrigation system in order to have the optimum yield (Khazaie *et al.*, 2008). Biofertilizers considered as more eco-friendly comparison to chemical fertilizers and it is thought to enhance soil fertility and to enhance crop production. As far as it is concerned medicinal and aromatic plants, there is an interest to produce chemical-free plants for growers

in order to ensure good quality and safe plant products for both human and environment. This study aims to examine production of sage in relation to cultivation practices of irrigation, plant density and nitrogen fertilization at the first year.

### Materials and methods

The field experiment was carried out in the experimental field of University of Thessaly which is located in Velestino, Magnesia, Greece (Latitude 39°23' North, Longitude 22°45' East) and elevation 70 m above the sea level. The means of temperature during experiment was 10.4°C, Relative Humidity was 54.4% and the sum of rain was 195.7 mm. The experiment was a split-split-plot and was established as complete randomized in three replicate blocks with three factors and twelve treatments. The main factor was irrigation in two levels: 0%(I1) and 100% of Evapotranspiration (I2), the sub-factor was plant density 20cm x 50cm (D1), 40cm x 50cm D(2) and the sub-sub-factor was N fertilization in three levels: (N0)0 kg ha<sup>-1</sup>, (N4)40 kg ha<sup>-1</sup> and (N8)80 kg ha<sup>-1</sup>. Plant material was seed cuttings which were approximately 20cm and were transplanted in November 2016 in a depth of 10 cm. Plant density was 20cmx50cm (plant to plant x row from row) and 40cmx50cm, respectively. According to soil analysis our soil consisted of 47% loam, 14% clay and 39% sand and characterized as SL. Soil pH was 7.7 (Table 1).

Table 1. Physical and chemical composition of experimental soil in two depths.

Depth	Sandy %	Clay %	Loam %	pH	EC $\mu\text{S}/\text{c m}$	% CaCO <sub>3</sub>	% O.M.	P mg/k	K mg/kg	N (%)
0-30 cm	39	14	47	7.7	302	12.5	2.5	42	1118	0.08
30-60 cm	42	12	46	7.7	378	13.0	2.1	35	1077	0.11

As irrigation system was used the drip irrigation with water supply per dripper 4 l h<sup>-1</sup> and the total supply to field was 280,000 l ha<sup>-1</sup> or 280 m<sup>3</sup> ha<sup>-1</sup> or 28mm per hour. Irrigation was calculated to field using an atmometer close to experiment and irrigation until first cut was totally 100 mm. Fertilization was organic with 6% total Nitrogen, 0.5% P<sub>2</sub>O<sub>5</sub>, 0.3% K<sub>2</sub>O and 85 % organic matter. In order to cover the needs of 80 kg ha<sup>-1</sup> was imposed 540 gr per plot and for 40 kg ha<sup>-1</sup> was imposed 270 gr per plot. Fertilizer was applied in early March after the soil's analysis. Cutting is programmed to be in early May (40% of the anthesis stage). In the sampling, for each plot (2x2m<sup>2</sup>) we harvested 1m in the inner plot rows to avoid any border effect. In the field we measured plant height and chlorophyll content index with CCM-200. Plant height was determined as the average for all harvested plants per plot. The plant material was weighted fresh and divided into the various plant components: leaves, stems and flowers. Then the plant fractions were oven-dried at 45°C until equal weights (8 days) and weighed again to determinate the respective dry weights (Sellami et al., 2012). Also, before drying, leaf area (green leaf lamina) was measured using an automatic LI-COR model LI-3000A portable leaf area meter. Leaf area index (LAI m<sup>2</sup> green leaf m<sup>-2</sup> ground) was determined as the product of green leaf dry weight (kg m<sup>-2</sup> ground) times the specific leaf area (SLA in m<sup>2</sup> leaf kg<sup>-1</sup>). All measured and derived data were subjected to analysis of variance (ANOVA), using Excel program.



## Results and discussion

Fig. 1 illustrates how the plant height, in sage (*Salvia officinalis* L.) is affected by irrigation, N-fertilization inputs and plant densities and have found that irrigation and D2 plant density caused a slight increase to height. Bettaiebet *et al.* (2011), claim that water stress causes a decrease in plant's height and our results agree with this statement and as far as it is concerned plant density, Kumar *et al.*, (2013) resulted in the same conclusion since the maximum height, was in case of plant density of (45x45) cm in *Salvia sclarae* 30cm. Plant height ranged from 28,1cm to 32,6cm which is in accordance with previous studies before flowering in a conventional system production with plant spacing 30x40cm (Dzidaet *al.* 2015). No Significant differences ( $P < 0.05$ ) of plant height were observed for the different plant densities, N-fertilization rates and irrigation inputs for the establishment year. Also, our results show that half of the N fertilization treatments (N4) had greater height than N8 and N0 treatments.

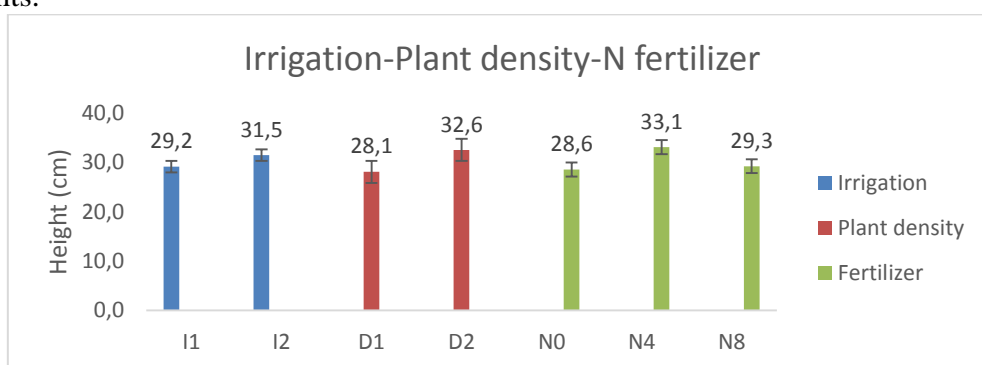


Figure 1. Average plant height measurements (cm) in relation to I- irrigation treatments (I2:Irrigated I1:Control, D- plant density D1: 20x50cm, D2: 40x50cm, N- fertilization N0: 0 kg $ha^{-1}$ , N4: 40 kg $ha^{-1}$ , N8:80 kg $ha^{-1}$  . Vertical bars indicate Standard Error at  $p < 0.05$ .

Chlorophyll content index (CCI) was in average more in rainfed conditions and in D2 treatments (Fig. 2). Our results are shown that average of CCI was higher in the case of rainfed condition (CCI=22.9) than in irrigation (CCI=19.4) treatments and in case of plant density we found that CCI was higher in case of D2 (26.7) rather than D1 (25.1). As far as it is concerned the nitrogen fertilization, average of CCI was higher in case of 0 kg $ha^{-1}$  (CCI=21.7) following the 80 kg $ha^{-1}$  (CCI=21.4) nitrogen and 40 kg $ha^{-1}$  (CCI=20.7). Amador *et al.* (2014), measuring chlorophyll in sage with SPAD-502 meter found that leaf SPAD of sage had a mean value of 20, values similar to ours.

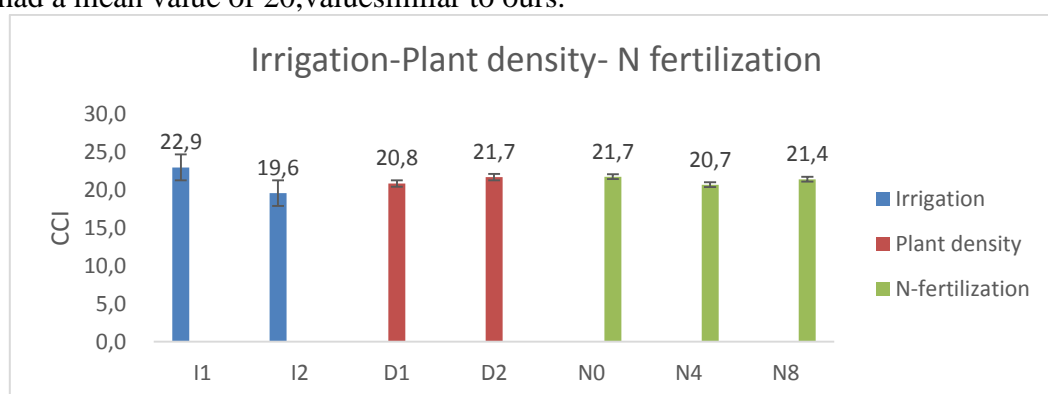


Figure 2. Average of Chlorophyll Content Index (CCI) in relation to all treatments (I2:Irrigated I1:Control, plant density D1: 20x50cm, D2: 40x50cm, N- fertilization N0: 0 kg $ha^{-1}$ , N4: 40 kg $ha^{-1}$ , N8:80 kg $ha^{-1}$ ). Vertical bars indicate SD at  $P < 0.05$ .

LAI comprises a very important index for assessing biomass accumulation, whereas accurate estimation of the dynamic pattern of LAI is central in crop modelling (Goudriaan and van Laar, 1994). Leaf Area Index (LAI) had the bigger value in treatments of irrigated (100 of ET<sub>0</sub>) and in D1 (Graphs 3). Obviously, average of LAI from irrigation and narrow plant density caused an increase on leaf surface. In case of fertilization it seems that N8 treatments had a slight increase instead of N0 and N4 indicated that fertilizer could increase LAI. No statistically differences were found between irrigation and N fertilization treatments while plant density treatments had significant difference (Fig. 4).

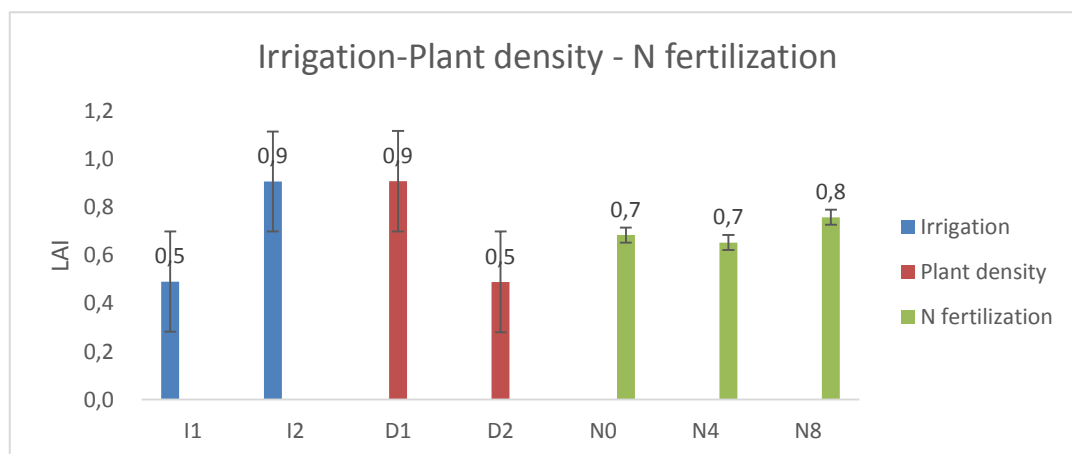


Figure 3. Average of Chlorophyll Content Index (CCI) in relation to all treatments (I2:Irrigated I1:Control, plant density D1: 20x50cm, D2: 40x50cm, N- fertilization N0: 0 kg $ha^{-1}$ , N4: 40 kg $ha^{-1}$ , N8:80 kg $ha^{-1}$ ). Vertical bars indicate SD at P < 0.05.

According to statistical analysis of ANOVA, there are significant differences between irrigation treatments and between plant density treatments. Means of Irrigated treatments is 1569 kg $ha^{-1}$  while rainfed treatments is 907 kg $ha^{-1}$  (Fig. 4) indicating that irrigation increase significant production by increasing leaves' weight comparison to non-irrigated plants. Govahiet *al.* (2015), found that yield of dry matter of sage is 2,702  $tha^{-1}$  in irrigated conditions and plant density 60x30cm.

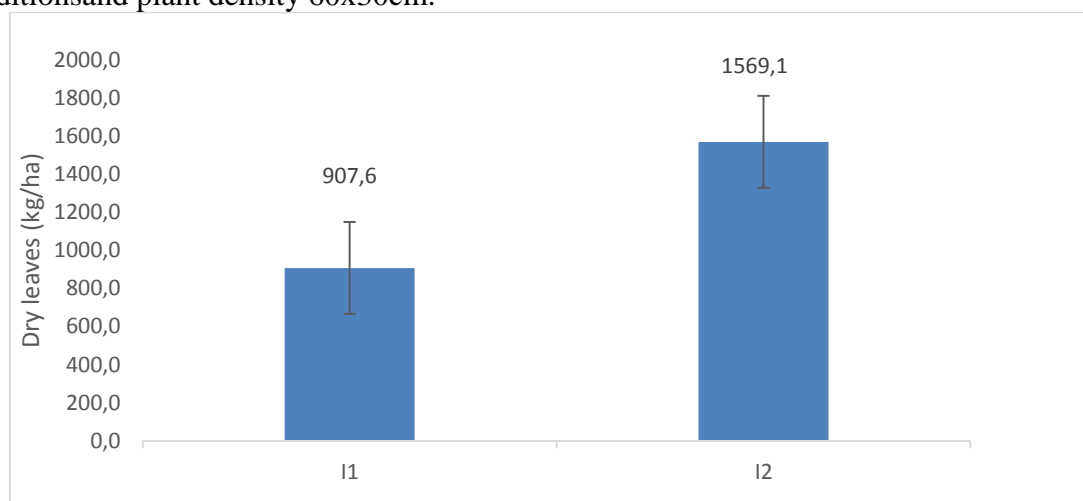


Fig. 4. Means of dry leaf weight (kg $ha^{-1}$ ) in relation to irrigation treatments (I2: Irrigated I1: Control). Vertical bars indicate LSD, 05.

In addition, plant density play a significant role in our production indicating that narrow plant density increase production per unit (1500 kg $ha^{-1}$ ) comparison to D2 (978 kg $ha^{-1}$ ) (Fig. 5).

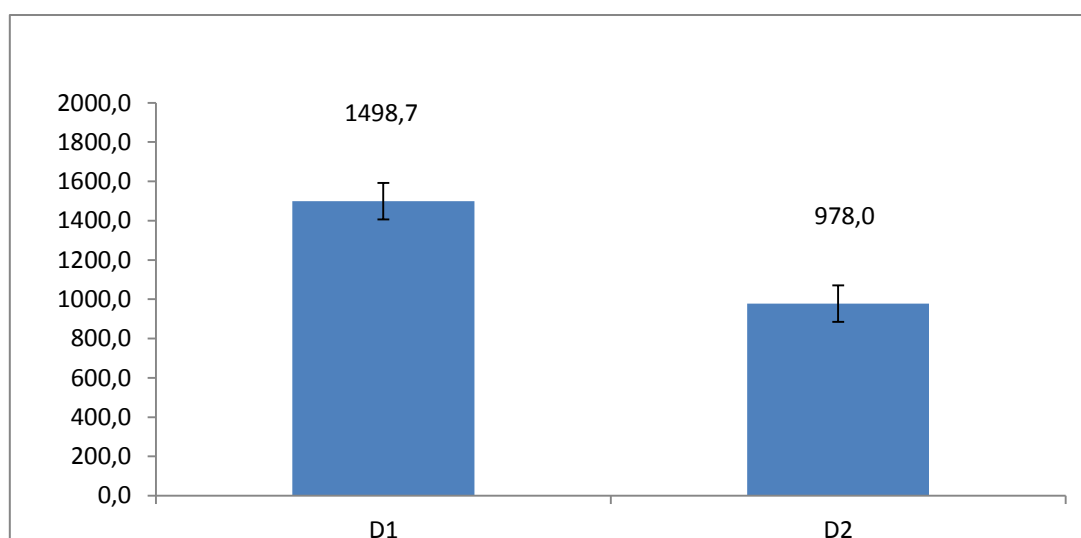


Fig. 5. Means of dry leaf weight (kg ha<sup>-1</sup>) in relation to plant density treatments (D1: 20x50cm, D2: 40x50cm). Vertical bars indicate LSD<sub>0,05</sub>.

As far as N fertilization is concerned, there is no significant difference between the treatments and it seems that fertilization has no influence on production. Our results agree with Nadjafet *et al.* (2014), who claim that biofertilizer has no effect on plant growth and yield in sage (*Salvia officinalis* L.). Corellet *et al.* (2012), found that the dry matter yield of *Salvia officinalis* L. is 1.27 t ha<sup>-1</sup> in rainfed conditions and 4.57 t ha<sup>-1</sup> by applying water 100% of ET<sub>0</sub>, in a two-year cultivation, with applying 80 kg ha<sup>-1</sup> N, plant density (35x75) cm and with three cuttings (first autumn, second autumn and third spring).

### Conclusion

Our results have shown that irrigation increases plant height, leaf production and leaf area index. Narrow plant density increases LAI and leaf production in both irrigation and rainfed systems. Unexpectedly, dry leaf biomass of sage was not influenced by N fertilization ( $P > 0.05$ ) in the range of 0–80 kg N ha<sup>-1</sup>. This is apparently due to the low nitrogen needs of the crop and the relatively high fertility status of the study soil. Thinking about productivity, the best combination in irrigated and in rainfed systems is the narrow plant density with 80 kg ha<sup>-1</sup> nitrogen fertilization. Finally, our first-year results are encouraging and show the important role of irrigation, in combination to plant density on sage productivity. Such results are important and may assist future cost/benefit analyses concerning the introduction of sage as an important aromatic/medicinal plant in crop rotation schemes in the near future in Greece and more generally in Mediterranean places.

### References

- Amador, B.M., Nieto - Garibay, A., Villegas -Espinoza, J.A., Troyo -Diéguez, E., Ramírez - Serrano, R., Córdoba -Matson, M.V. (2014). Evaluating the best model for measuring chlorophyll in sage leaves in the field using the SPAD -502 meter. *Mitteilungen Klosterneuburg* Vol. 64 (6).
- Bettaieb, I., Hamrouni-Sellami, I., Bourguou, S., Limam, F., & Marzouk, B. (2011). Drought effects on polyphenol composition and antioxidant activities in aerial parts of *Salvia officinalis* L. *Acta Physiologiae Plantarum*, 33(4).
- Bruneton, J. (2001). *Farmacognosia (Fitoquímica, Plantas medicinales)*. Zaragoza: Ed. Acribia, S.A.

- Corell, M., Garcia, M. C., Contreras, J. I., Segura, M. L., & Cermeño, P. (2012). Effect of water stress on *salvia officinalis* L. bioproductivity and its bioelement concentrations. *Communications in Soil Science and Plant Analysis*, 43(1-2), 419-425.
- Goudriaan, J., van Laar, H.H., 1994. *Modelling Potential Crop Growth Processes*. Kluwer Academic Publishers, Dordrecht, The Netherlands.
- Govahi M, Ghalavand A, Nadjafi F, Sorooshzadeh, A (2015). Comparing different soil fertility systems in Sage (*Salvia officinalis* L.) under water deficiency, *Industrial Crops and Products* 74:20-27.
- Khazaie, H. R., Nadjafi, F., & Bannayan, M. (2008). Effect of irrigation frequency and planting density on herbage biomass and oil production of thyme (*thymus vulgaris*) and hyssop (*hyssopus officinalis*). *Industrial Crops and Products*, 27(3), 315-321.
- Kumar, R., Sharma, S., & Pathania, V. (2013). Effect of shading and plant density on growth, yield and oil composition of clary sage (*salvia sclarea* L.) in north western himalaya. *Journal of Essential Oil Research*, 25(1), 23-32.
- Munné Bosch, S., Mueller, M., Schwarz, K. and Alegre, A. 2001. Diterpenes and antioxidative protection in drought-stressed *Salvia officinalis* plants. *Journal of Plant Physiology* 158:1431–1437.
- Nadjafi, F., Mahdavi Damghani, M., Tabrizi, L., & Nejad Ebrahimi, S. (2014). Effect of biofertilizers on growth, yield and essential oil content of thyme (*thymus vulgaris* L.) and sage (*Salvia officinalis* L.). *Journal of Essential Oil-Bearing Plants*, 17(2), 237-250.
- Sellami, I. H., Rebey, I. B., Sriti, J., Rahali, F. Z., Limam, F., & Marzouk, B. (2012). Drying sage (*Salvia officinalis* L.) plants and its effects on content, chemical composition, and radical scavenging activity of the essential oil. *Food and Bioprocess Technology*, 5(8), 2978-2989.

## FERTILITY PARAMETERS REFORMATION OF SOD-PODZOLIC SOILS IN THE URAL REGION AS INFLUENCED BY FERTILIZERS APPLICATION AND LANDSCAPER TYPES.

Antonina KOSOLAPOVA<sup>1</sup>, Denis FOMIN<sup>1</sup>, Konstantin KORLYAKOV<sup>1</sup>, Valery VOZZHAEV<sup>2</sup>

<sup>1</sup> Perm Agricultural Research Institute 614532, Lobanovo, Perm region, Russia.

<sup>2</sup> Perm State Agricultural Academy named after D.N. Pryanishnikov 614990, Petropavlovskaya St., 23, Perm, Russia

\*Corresponding author: pniish@rambler.ru

### Abstract

The effect of geochemical state of the moraine-erosion landscape, caused by the relief, and fertilization on agrophysical and agrochemical parameters of sod-podzolic heavy loam soil and spring wheat yield was studied in a stationary experiment in the Ural Region. Fertilizers application was studied on three landscape types: eluvial, transit and accumulative. In the control treatments ( no fertilizers: organic or mineral ) degradation processes in sod-podzolic soils and irrational use of arable land as a result, were evident. That was confirmed by deterioration of soil fertility parameters, hydrolytic acidity raising for 0.2-0.3 mmol/100 g of soil, total exchange bases ( S ) decline. Microbiological soil activity decreased by 8.2-8.8%, humus content in arable layer- by 0.14%, labile forms of phosphorus and potassium - by 19-26 mg /1000 g. Degradation processes were mostly developed in the transit landscape. Stabilization of soil fertility at the initial level was provided by farmyard manure application in rate 60 t ha<sup>-1</sup> combined with the use of mineral fertilizers N<sub>60</sub>P<sub>60</sub>K<sub>60</sub>. The close inverse correlation (r=-0,85) between humus content and soil density was determined. Accumulation of mobile phosphorus, exchange potassium and mineral nitrogen is observed down the slope towards accumulative landscapes and reaches the maximum values in the inter-hill depression (accumulative landscape). The influence of the geochemical state and landscape heterogeneity, caused by relief, was more important for agrophysical and agrochemical properties of the soil compared with fertilizers application. The accumulative landscape is characterized by favorable soil conditions, in transit landscape the worst fertility parameters were noted.

**Key-words:** *agromicrolandscape, sod-podzolic soil, mineral fertilizers, farmyard manure, humus, soil density, spring wheat, soil acidity, labile phosphorus, exchange potassium.*

### Introduction

The country's food security, stable development of society are possible only in harmony with natural forces. Mankind must successfully engage in biogeochemical cycles of the biosphere and rationally take into account landscape features (Gardner, 1990; Nazaryuk , 2002; Lykov, 2006).

Soil is the important component of any landscape. Sod-podzolic soils are most common in Ural region and have unfavorable agrochemical properties: high acidity, low content of phosphorus and potassium mobile forms. Technological load on the soil cover increases as a result of agriculture intensification and caused the degradation processes intensification. (Demidov, Shiryayeva, 2004; Dobrovolsky, 2004; Kesavan P.C., Swaminathan M.S., 2008 ). Soil degradation is intensified due to the peculiarities of landscape conditions, because

fertility parameters vary according to distribution of material and energy flows in agromicrolandscapes. Soil fertility indicators within landscapes vary, primarily, according to altitude and slope exposure. At present time erosion processes on the slopes of different exposures are studied sufficiently. The processes of natural, geochemical differentiation of nutrients in different elementary landscapes, their influence on the crops productivity are characterized to lesser extent. The purpose of given work – to study the influence of landscape conditions: geochemical state of the moraine-erosion landscape, caused by the relief, on agrophysical and agrochemical parameters of sod-podzolic heavy loam soil and spring wheat yield.

### **Materials and methods.**

The studies were carried out during 1996-2000 and 2013-2016 years in short-term experiment, located on the central experimental farm of Perm Agricultural Research Institute on sod-podzolic heavy loam soil with following agrochemical properties: humus content 2.21%,  $\text{pH}_{\text{KCl}} = 5.4$ ,  $\text{H}_\text{A}^-$  2,8; S- 14.2 mmol/100 g of soil, labile phosphorus ( $\text{P}_2\text{O}_5$ ), exchange potassium ( $\text{K}_2\text{O}$ ), respectively 100 and 134 mg/kg.

Scheme of the experiment: factor A – Landscapes: 1. Eluvial, 2. Transit. 3. Accumulative; Factor B: – Fertilizers: 1. Control (without fertilizers), 2. NPK - each of 60 kg  $\text{ha}^{-1}$ , 3. FYM - 60 t  $\text{ha}^{-1}$ , 4. NPK - 60 kg  $\text{ha}^{-1}$  + FYM 60 t  $\text{ha}^{-1}$ . Treatment placing is serial, each treatment has four replications, according standard methods (Dosepohov, 1979).

NPK were applied for spring wheat, FYM - in a fallow field, after-effect was accounted. The objects of research were eluvial, transit and accumulative agromicrolandscapes. The studied crop – spring wheat (*Triticum aestivum* L. var. *milturum*, cultivar Irgina), the preceding crop – winter rye after bare fallow.

Observations and studies were carried out according to accepted methods (Mineev, 2001). Soil and plant chemical analyses were fulfilled in analytical laboratory of Perm Agricultural Research Institute according national standards: humus content – GOST 26213-84 (Tyurin method);  $\text{pH}_{\text{KCl}}$  – GOST 26483-85 (potentiometrically); hydrolytic acidity - GOST 2 OST 26207-91 (Kappen method); total exchange bases – GOST 27821-88 (Kappen-Gilkovits method); content of mobile phosphorus and exchange potassium – GOST 26207-91 (Kirsanov method). Data processing included analysis of variance and correlation coefficients determination, using the program SPSS (v.18).

Meteorological conditions during the years of the experiment were typical for the Ural Region and favorable for growth and development of spring wheat.

### **Results and discussion**

Irrational use of arable land without mineral fertilizers application adversely affected on soil agrophysical and agrochemical properties. One of the important factors determining crops productivity is soil density.

The soil became very compact in the control treatment on all types of landscapes (Fig.1). The highest soil density 1.54  $\text{g}/\text{cm}^3$  was noted in the transit landscape, which was due to flushing of structural soil particles. The soil density decreased with fertilizers application, especially organic.

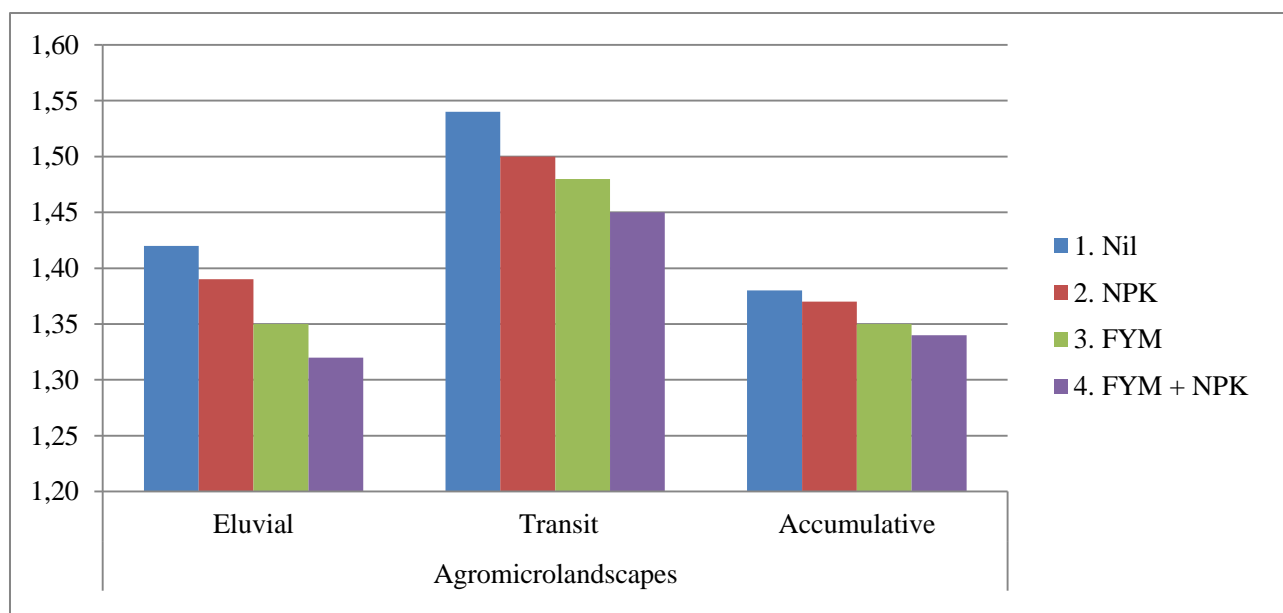


Fig.1 Soil density by the time of wax ripeness phase of spring wheat, g/cm<sup>3</sup> ( average for 2013-2016 ).

Soil erosion phenomena are sufficiently highlighted in modern literature ( Dobrovolskiy 1997; Kuznetsov and Glazunov, 1996; Lobosova and Goneev, 2015). The processes of natural geochemical differentiation of nutrients, agrophysical properties in various elementary landscapes and their influence on the productivity of agricultural crops are studied much worse.

Geochemical subjection of landscapes was demonstrated in parameters of soil absorbing complex and mobile nutrition elements. So, monitoring of agrochemical soil indicators showed the accumulation of exchange bases sum on the catena and their maximum values in the inter-hill depression (accumulative landscape), which is associated with the advantage of lateral runoff, as well as within the profile migration. Accumulation of labile phosphorus, exchange potassium and mineral nitrogen was gradually raised down the slope towards accumulative landscapes (Table 1).

Table 1– Influence of fertilizers and landscapes on agrochemical soil indicators ( average for 2013-2016 ).

Treatment	Humus, %	pH	H <sub>A</sub> *	S	NH <sub>4</sub>	NO <sub>3</sub>	N <sub>A-H</sub> **	P <sub>2</sub> O <sub>5</sub>	K <sub>2</sub> O
			mg-eq/100 g		mg/kg				
Eluvial landscape									
1. Nil	2.10	5.5	2.8	14.2	2.8	2.3	9.6	129	114
2. NPK	2.15	5.5	2.7	14.4	2.9	2.4	10.4	146	130
3. FYM	2.39	5.6	2.5	14.8	3.0	2.5	10.8	146	133
4. FYM + NPK	2.43	5.6	2.6	15.2	3.4	2.5	11.5	148	140
Transit landscape									
1. Nil	1.34	5.2	3.3	12.2	2.0	1.7	7.5	87	77
2. NPK	1.35	5.1	3.2	13.0	2.1	2.2	9.2	98	85
3. FYM	1.52	5.4	3.1	13.0	2.0	1.8	9.2	95	84
4. FYM + NPK	1.56	5.5	3.0	13.1	2.2	2.2	9.4	107	99
Accumulative landscape									

1. Nil	3.42	5.7	2.3	15.8	4.9	2.6	12.3	171	158
2. NPK	3.60	5.6	2.2	16.0	5.2	2.7	13.2	182	165
3. FYM	3.95	5.7	2.0	16.2	5.5	2.7	13.0	185	166
4. FYM + NPK	3.99	5.8	2.1	16.2	5.5	2.9	13.6	194	178
HCP <sub>05</sub>	0.12		0.5	1.4	0.3	0.2		12	14

Notes:

\*-H<sub>A</sub> – Hydrolytic acidity;

\*\* - N<sub>A-H</sub> – Alkali-hydrolysable nitrogen

The minimum content of these elements was noted in the transit landscape, as affected by their elution by melt- waters during the snowmelt period and rainfalls during the growing season.

N-NH<sub>4</sub> prevailed in all forms of the landscape because the nitrate form is flushed from plowing horizon to the underlying layers with a natural runoff and, on the contrary to ammonium ions, does not form any hardly soluble salts, and it is not absorbed by negatively charged soil colloids.

The content of alkali-hydrolysable nitrogen was closely correlated with humus content ( $r = 0.89$ ) and reached maximum in the accumulative landscape.

Total humus content was also closely correlated to relief elements, the correlation coefficient was 0.91. The highest humus content was noted in arable layer 3.65% (average meaning for factor ) in the accumulative landscape, which was 1.55% more than in the eluvial landscape and on 2.32% higher compared the transit landscape. Changes in humus content, depending on the landscape conditions, are associated with material and energy flows vectors.

The use of mineral and organic fertilizers promoted increasing of humus content, mobile forms of nitrogen, phosphorus and potassium.

Thus, the landscape heterogeneity and geochemical state of the moraine-erosion plain (plain landscape), caused by relief, was more important to the agrophysical and agrochemical properties of the soil compared with fertilizers application. The accumulative landscape (inter-hill depression) is characterized by favorable soil conditions, eluvial landscape (watershed) conceded the accumulative one in this relation.

Degradation processes are most intensively revealed in the transit landscape, due to the flushing of the most valuable structural soil particles and nutrients.

Fertilizers in sufficient rates restrain degradation processes in the soil. The joint application of organic and mineral fertilizers promotes the accumulation of humus, nutrients and improves agrophysical properties of the soil.

### Conclusion

The influence of the geochemical state and landscape heterogeneity of moraine-erosion plain, caused by relief, was more important for agrophysical and agrochemical properties of the soil compared with fertilizers application.

Fertility parameters differed significantly in various landscape types, relatively favorable soil conditions were noted for accumulative landscape (inter-hill depression), eluvial landscape (watershed) conceded the accumulative one in this relation. Degradation processes are most intensively revealed in the transit landscape, due to the flushing of the most valuable structural soil particles and nutrients.

Fertilization restrains degradation processes in the soil. The joint application of organic and mineral fertilizers promotes the accumulation of humus, nutrients and improves agrophysical properties of the soil.



## References

- Demidov V.V. Shirjaeva T.N., 2004. The losses of organic matter on eroded grey forest soils after snow melting.- *Agricultural Chemistry*. № 8. p. 32-35.
- Gardner B., 1990. *European Agriculture Environmental Problems*. Indianapolis.
- Dobrovolskiy G.V., 1997. Quiet crisis of the planet. *Herald of the Russian Academy of Sciences. (Vestnik RAN)* V. 67. № 4. p. 313-320.
- Dobrovolskiy G.V., 2004. Humic acids impact on heavy metal migration flows. *Eurasian Soil Science*. № 1. p. 39-49.
- Dosphehov B.A., 1979. *Field experiments methodology* – M.: Kolos.
- Kesavan P.C., Swaminathan M.S., 2008. Strategies and models for agricultural sustainability in developing Asian countries. *Philos Trans R Soc Lond B Biol Sci*. Feb 27; 363(1492): p. 877–891.
- Kuznetsov M.C., Glazunov G.P., 1996. *Erosion and soil protection*. Moscow, MGU.
- Lobosova E.V., Goneev I.A., 2015. Water erosion impact on agrophysical properties of slightly eroded chernozems. In: *Scientific student community of XXI century. Proceedings of XXXI international student conference*. Novosibirsk № 5 ( 30 ), p. 56-63.
- Lykov A.M., 2006. *Introduction to biogeocoenosis (adaptive-biosphere) husbandry Plodorodie*. №1. p. 27-32.
- Mineev V.G., 2001. *Workshop book on agrochemistry*. M.: MGU.
- Nazaryuk V.M., 2002. *Nitrogen balance and transformation in agroecological systems* – Novosibirsk: SORAN.

## SPELT AS ORGANIC RAW MATERIAL FOR PRODUCTION OF EXTRUDED PRODUCTS

Jelena FILIPOVIĆ<sup>1\*</sup>, Vladimir FILIPOVIĆ<sup>2</sup>, Milenko KOŠUTIĆ<sup>1</sup>

<sup>1</sup> University of Novi Sad, Institute for Food Technology, Bul. cara Lazara 1, 21000 Novi Sad, Serbia

<sup>2</sup> Faculty of Technology, University of Novi Sad, Bul. Cara Lazara 1, 21000 Novi Sad, Serbia

\*Corresponding author: jelena.filipovic@fins.uns.ac.rs

### Abstract

Spelt wheat (*Triticum aestivum* sub sp. *spelt*) is an old crop. That is a low input plant, suitable for growing without the use of pesticides in harsh ecological conditions and in marginal areas of cultivation. Spelt pasta is produced without additives, food colours and it doesn't contain genetically modified materials, thus meets the requirements of an organic product. Organic food can be rated from satisfactory to good, because it contains much higher levels of nutrients. Spelt wheat is suitable organic raw material for extruded products with modified nutritional characteristics. During the process of extrusion, spelt is exposed to high temperature and high pressure, during which raw material is also mechanically treated by shear forces. This paper investigates chemical and mineral characteristics of three spelt flours cultivars (Nirvana, Austria and Eco) and their influence on technological quality of spelt pasta. The significant differences between spelt flour was confirmed by application of Post-hoc Tukey's HSD test at 95% confidence limit. Calculation of standard scores (SS), based on assigning equal weight to applied parameters (chemical, mineral and technological) has been conducted and the obtained values compared. Data point at good indicators of spelt pasta technological quality with improved chemical and mineral characteristics. Pasta obtained from spelt flour may contribute to variety of organic safe products at the market.

**Keywords:** *Organic raw material, spelt, chemical characteristics, mineral characteristics, technological quality*

### Introduction

Wheat is one of the most widely grown crop in the world because of its unique protein characteristics. While most of the world wheat crop arises from production of common and durum cultivars, there is increasing interest in ancient wheat species, especially spelt (*Triticum aestivum* sub sp. *spelt*) ones, particularly with regard to use in special bakery and pasta products, health and organic foods (Gálová and Knoblochová, 2001, Abdel-Aal *et al.*, 2008). Spelt pasta is produced without additives, food colours and it doesn't contain genetically modified materials, thus meets the requirements of an organic product. Spelt is valued due to its high nutritional value, health-promoting qualities and agronomical advantages, such as high pest resistance and the fact that it can be cultivated on low fertility, poorly drained soils (Koenig, *et al.*, 2015, Biel, *et al.*, 2016). The nutritive value of spelt wheat is high and contains all the basic components which are necessary for human beings such as starch and nonstarch carbohydrates, proteins, lipids, vitamins and minerals (Bojanski and Frančakova, 2002). Some of spelt cultivars have very high protein content and even 30 to 60% higher concentration of mineral elements (Fe, Zn, Cu, Mg and P) compared to *Triticum aestivum* (Bonafaccia *et al.*, 2000, Filipović *et al.*, 2013,).

This paper investigates the basic chemical components (protein, starch, fat, cellulose, ash, and moisture) and mineral content of (Ca, Zn, Cu, Mn, Fe) of three spelt cultivars (Nirvana,

Austria and Eco) as a raw material for pasta. Beside chemical and mineral content the convenience of spelt flour for pasta is evaluated based on the data concerning pasta texture.

### Material and Methods

Three spelt cultivars: Nirvana, Austria and Eco 10, (particle size of whole meal flours ranged between 200 and 300 µm) representing the average quality from producing areas grown in Serbia are tested. Basic chemical analyses (protein, starch, fat, cellulose, ash) of spelt flour are tested according to the Regulations on the physical and chemical methods of analysis for quality control of grain, milling and bakery products, pasta and deep frozen dough (1988). The content of calcium, zinc, copper, magnesium and iron was determined by atomic absorption spectroscopy using standard procedure (No. 985.29) given by AOAC (1990). Pasta is made on the device "La Parmigiana D45" MAC 60, La Parmigiana Italy, procedure described by Filipović *et al.*, (2013). Method of cooked texture pasta was described by Filipović *et al.*, 2015. Descriptive statistical analyses for all the obtained data were expressed as the mean ± standard deviation (SD). The evaluation of one-way ANOVA analyses of the obtained results was performed using StatSoft Statistica 10.0® software. Collected data were subjected to one-way analysis of variance (ANOVA) for the comparison of means, and significant differences were calculated according to post-hoc Tukey's HSD (honestly significant differences) test at  $p < 0.05$  significant level, 95% confidence. Score analysis uses min-max normalisation of flour and pasta quality parameters transforming them from their original unit system in new dimensionless system where further mathematical calculations with different types of quality parameters were applicable (Jayalakshmi and Santhakumaran, 2011). Individual score for following attributes ( $K_i$ ): Crude protein content (CP), Cellulose content (C), Fat content (F), Ca, Zn, Cu, Mn, Fe, Hardness (HAR), Work of Shear (WOS) is calculated according following equation:

$$S_{ki} = \frac{(x_{ki} - x_{k\min})}{(x_{k\max} - x_{k\min})} \quad k=1-10 \quad (1)$$

For moisture content (M), ash content (A), starch content (S), Adhesiveness (ADH) individual score are calculated according following equation:

$$S_{ni} = 1 - \frac{(y_{ni} - y_{n\min})}{(y_{n\max} - y_{n\min})} \quad n = 1-4 \quad (2)$$

Segment score for chemical content, mineral content and texture attributes equations (3) (4) and (5) respectively are calculated as arithmetic means of individual scores:

$$\text{Chemical content Score}_i = \frac{S_{M_i} + S_{A_i} + S_{CP_i} + S_{C_i} + S_{S_i} + S_{F_i}}{6} \quad (3)$$

$$\text{Mineral content Score}_i = \frac{S_{Ca_i} + S_{Zn_i} + S_{Cu_i} + S_{Mn_i} + S_{Fe_i}}{5} \quad (4)$$

$$\text{Texture attributes Score}_i = \frac{S_{HAR_i} + S_{ADH_i} + S_{WOS_i}}{3} \quad (5)$$

Total score is arithmetic mean of three segment score:

$$S_i = \frac{\text{Chemical content Score}_i + \text{Mineral content Score}_i + \text{Texture attributes Score}_i}{3} \quad (6)$$

$$\max[S_i] \rightarrow \text{optimum} \quad (7)$$

## Results and Discussion

Quality of 1 spelt flour of three different varieties is presented in Table 1. There are statistically significant differences between Nirvana and Eco 10 concerning moisture and ash content. Investigated spelt cultivars are characterized by high protein content (Table 1), which qualifies this raw material as a suitable for pasta production. The highest value for crude protein ( $17.02 \pm 0.15$ ) is observed for Nirvana and statistically significantly different from cultivar Austria and Eco 10. The content of cellulose, starch and fat are relatively uniform in all cultivars, with some statistically significant differences between values. Data concerning content of individual mineral elements statistically significantly vary depending on the cultivar with the greatest difference in Ca (cultivar Eco 10) and Fe content (cultivar Austria). The high mineral content experienced in spelt cultivars point at the improved bioavailability of those elements, due to low phytic acid content reported by and Ruibal-Mendieta *et al.*, (2005).

Table 1. Parameters of quality of spelt flour cultivar

Characteristics	Spelt cultivar		
	Nirvana	Austria	Eco 10
Moisture content (%)	$13.26 \pm 0.04^{ab}$	$13.34 \pm 0.03^a$	$12.72 \pm 0.05^b$
Ash content (% d.m.)	$1.08 \pm 0.02^a$	$1.20 \pm 0.03^b$	$1.18 \pm 0.02^b$
Crude protein content (% d.m.)	$17.02 \pm 0.15^a$	$15.81 \pm 0.21^b$	$15.42 \pm 0.18^b$
Cellulose content (% d.m.)	$0.87 \pm 0.07^a$	$1.47 \pm 0.11^b$	$1.05 \pm 0.09^a$
Starch content (% d.m.)	$62.77 \pm 0.35^a$	$61.62 \pm 0.29^b$	$60.75 \pm 0.25^c$
Fat content (% d.m.)	$1.91 \pm 0.04^a$	$1.66 \pm 0.02^b$	$1.93 \pm 0.04^a$
Mineral content			
Ca content (mg/kg)	$170.04 \pm 2.81^a$	$147.94 \pm 1.35^b$	$212.33 \pm 2.21^c$
Zn content (mg/kg)	$14.10 \pm 0.48^a$	$18.27 \pm 0.56^b$	$18.15 \pm 0.52^b$
Cu content (mg/kg)	$2.30 \pm 0.05^a$	$2.18 \pm 0.05^b$	$1.34 \pm 0.04^c$
Mn content (mg/kg)	$17.26 \pm 0.31^a$	$13.91 \pm 0.25^b$	$20.58 \pm 0.28^c$
Fe content (mg/kg)	$21.83 \pm 0.54^a$	$60.15 \pm 0.88^b$	$22.60 \pm 0.67^a$

The results are presented as mean $\pm$ SD; different letter within the same row indicates significant differences ( $p < 0.05$ ), according to Tukey's test, number of repetitions:  $n=4$ .

The texture attributes of pasta are important quality characteristics of product and very important for consumers. Statistically significant differences in adhesiveness between pasta cultivar Nirvana and Austria were not observed, contrary to statistically significant reduce of the adhesiveness of pasta in cultivar Eco 10 (Table 2). The difference in work of shear was statistically significant for cultivar Austria and Eco 10. The maximum value of work of shear was observed in Eco 10 ( $148.42 \pm 8.19$ ) and the lowest value of work of shear was found in Austria ( $120.83 \pm 9.60$ ).

Table 2. Texture attributes of cooked pastas cultivar

	Spelt cultivar		
	Nirvana	Austria	Eco 10
Hardness (g)	$2496.47 \pm 85.10^a$	$2185.67 \pm 35.28^b$	$2678.64 \pm 75.18^c$
Adhesiveness (gsec)	$17.25 \pm 1.47^a$	$21.23 \pm 0.76^a$	$12.38 \pm 2.50^b$

Work of shear (gsec)	130.67±5.01 <sup>ab</sup>	120.83±9.60 <sup>a</sup>	148.42±8.19 <sup>b</sup>
----------------------	---------------------------	--------------------------	--------------------------

The results are presented as mean±SD; different letter within the same row indicates significant differences ( $p < 0.05$ ), according to Tukey's test, number of repetitions:  $n=4$ .

Table 3. Spelt flour and pasta score values

Spelt cultivar	Segment Scores			Total Score
	Chemical content Score	Mineral content Score	Pasta texture attributes Score	
Nirvana	0.51	0.37	0.48	0.45
Austria	0.30	0.58	0	0.29
Eco 10	0.58	0.60	1	0.73

By means of Score analysis, 14 different flour and pasta quality parameters were quantified further calculated in three Segment Score values, and one Total Score value, which were comparable between the different flour and pasta samples. In that way score values of flour and pasta samples allowed the possibility of comparing segment and total quality of the analyzed samples. Table 3 shows score values of spelt flour and pasta attributes. It can be seen that Eco 10 achieved the best Score values in all tested segments (chemical, mineral and texture attributes score; 0.58, 0.60 and 1, respectively). The highest total score value of 0.73 was also determined for spelt flour Eco 10, indicating on the best technological quality between tested spelt flour samples.

### Conclusions

Quality of three spelt cultivars differs in chemical, mineral content and texture quality. By using the standard score analysis cultivar Eco 10 has highest score (0.73) while cultivar Austria gained lowest score (0.29) characteristics. Chemical and mineral content vary upon the cultivar score analysis is a useful tool in characterizing spelt as a raw material for pasta. Pasta obtained from cultivar Eco 10 prove to be a new organic safe product on the market with good technological quality with improved chemical and mineral characteristics.

### Acknowledgements

These results are part of the project supported by the Ministry of Education and Science of the Republic of Serbia, III 46005.

### References

- Abdel-Aal, El-Sayed M., Rabalsk, I. (2008). Effect of baking on nutrition properties of starch in organic spelt whole grain products. *Food Chemistry*, vol. 111, pp. 150-156.
- AOAC (1990). *Official methods of analysis* (17th Ed.). VA: Association of Official Analytical Chemists, Arlington.
- Biel, W., Stankowski, S., Jaroszewska, A., Pużyński, S., Boško, P. (2016). The influence of selected agronomic factors on the chemical composition of spelt wheat (*Triticum aestivum* ssp. spelt L.) grain. *Journal of Integrative Agriculture*, vol. 15, pp. 1763–1769.
- Bojanska. T., Frančakova. H.(2002). The use of spelta wheat (*Triticum spelta* L.) for baking applications. *Rostlinna Vyroba*, vol. 48, pp. 141-147.
- Bonafaccia G., Galli V., Francisci R., Mair V., Skrabanja V., Kreft I. (2000). Characteristics of spelt wheat products and nutritional value of spelt wheat-based bread. *Food Chemistry*, vol. 68, pp. 437-441.

- Filipović J., Pezo L., Filipović V., Brkljača J., Krulj J. (2015). The effects of  $\omega$ -3 fatty acids and inulin addition to spelt pasta quality. *LWT – Food Science and Technology (Lebensmittel-Wissenschaft und Technologie)*, vol. 63, pp. 43-51.
- Filipović J., Pezo L., Filipović N., Filipović V., Bodroža-Solarov M., Plančak M. (2013). Mathematical approach to assessing spelt cultivars (*Triticum aestivum* subsp. spelt) for pasta making. *International journal of food science and technology*, vol. 48, pp. 195-203.
- Gálová, Z., Knoblochová H.(2001). Biochemical characteristics of five spelt wheat cultivars (*Triticum spelta* L.), *Acta fytotechnica et zootechnica. Special Number Proceedings of the International Scientific Conference on the Occasion of the 55th Anniversary of the Slovak Agricultural University in Nitra*, Vol. 4, pp. 264-291.
- Jayalakshmi T., Santhakumaran A. (2011). Statistical Normalization and Back Propagation for Classification. *International Journal of Computer Theory and Engineering*, vol. 3, pp. 89-93.
- Koenig, A., Konitzer, K., H., Wieser, Koehler, P. (2015). Classification of spelt cultivars based on differences in storage protein compositions from wheat. *Food Chemistry*, vol. 168, pp. 176–182.
- Regulations on the physical and chemical methods of analysis for quality control of grain, milling and bakery products, pasta and deep frozen dough, official gazette 78/1988.
- Ruibal-Mendieta N.L., Delacroix D.L., Mignolet E., Pycke J.-M., Marques C., Rozenberg R., Petitjean G., Habib-Jawan J.L., Meurens M., Quetin-Leclercq J.M., Deyenne N., Larondelle Y. (2005). Spelt (*Triticum aestivum* spp. spelt) as a source of Breadmaking Flours and Bran naturally Enriched in Oleic Acid and Minerals but not Phytic Acid. *Journal of Agricultural and Food Chemistry*, vol. 53, pp. 2751-2759.

## WINTER GREENHOUSE VEGETABLE PRODUCTION ENHANCED BY THE BROWN SEAWEED EXTRACTS

Milan UGRINOVIĆ<sup>1\*</sup>, Zdenka GIREK<sup>1</sup>, Suzana PAVLOVIĆ<sup>1</sup>, Đorđe MORAVČEVIĆ<sup>2</sup>,  
Gordana DOZET<sup>3</sup>, Marija SPASIĆ<sup>4</sup>, Bogoljub ZEČEVIĆ<sup>1</sup>

<sup>1</sup>Institute for Vegetable crops, Smederevska Palanka, Serbia

<sup>2</sup>Faculty of Agriculture, University of Belgrade, Belgrade, Serbia

<sup>3</sup>Faculty of Biofarming, John Nezbit University, Bačka Topola, Serbia

<sup>4</sup>Institute of Agricultural Economics, Belgrade, Serbia

\*Corresponding author: milan.ugrinovic@gmail.com

### Abstract

Owing to the content of hormones, vitamins and enzymes, brown algae extract, *Ascophyllum nodosum* L. (ANE) has plant growth promoting effect despite the small content of the major plant nutrients (N, P, K etc.). In addition, due to its natural content of physiologically active substances, ANE can alleviate the effects of stress in treated plants. This may have a particularly great importance for the winter production of vegetables in greenhouses in which the soil is usually highly saturated with nutrients. In order to determine the plant growth promoting effects of three different ANE, the experiment was conducted in the greenhouse of the Institute of vegetable crops in Smederevska Palanka, Serbia, on the vertisol soil type. The low-temperature tolerant species radish (*Raphanus sativus* var. *radicula* L.), spinach (*Spinacia olerace* L.) and garlic (*Allium sativum* L.) were sown in late autumn and treated with three different ANE. Plant height, plant mass, the number of leaves per plant and yield were measured. Comparing to untreated plants, examined traits on radish treated with ANE were not significantly different. However, ANE enhanced the plant mass and yields of spinach and onion. The application of ANE for vegetable cultivation in greenhouses during the winter can be recommended for conventional as well as for organic production systems.

**Keywords:** *Greenhouse cultivation, Sustainable production, Fertilizers*

### Introduction

During the last few decades, the awareness for environment and ecosystems preservation was increased. Due to application of heavy doses of mineral fertilizers, contamination with nitrogen, phosphorus and some accompanying heavy metals became serious problem in some agricultural soils and ground waters (Stojanović et al. 2006; Huang et al. 2007; Sebilo et al. 2013). Eutrophication of rivers, lakes, water-ways and water accumulations is another great problem caused by excessive application of mineral fertilizers (Carpenter 2005). Many trials highlighted the necessity of precise and reasonable fertilizer utilization management, as well as the use of some biostimulants and plant growth promotion matters in agricultural practice (Khan et al. 2009; Diacono et al., 2013).

Brown algae or rockweed, *Ascophyllum nodosum* L., is an important member of marine ecosystems which provides habitat, nitrogen and carbon storage services (Schmidt et al. 2011). It is used as a raw material in a foodstuff and pharmaceutical industry (Khan et al. 2009). Due to content of certain organic acids, polysaccharides, phenols, enzymes and hormones, brown algae have application in agricultural production (Audibert et al. 2010; Craigie 2011; Yuan and Macquarrie 2015).

Recent studies, showed the effects of *Ascophyllum nodosum* L. extract (ANE) as a plant growth promoter (Khan et al. 2009; Zodape et al., 2010; Alam et al., 2013). The application of ANE on some plant species is also connected with increment of phenolic antioxidant content (Fan et al., 2011). The findings of Vera et al (2011), as well as Abkhoo and Sabbagh (2016) suggested the possibility of application ANE as a stimulant and protection against plant pathogens. The most interesting issue of ANE is the improvement of stress tolerance of cultivated plants (Guinan et al 2012; Nair et al 2012). Particularly important is the increase in tolerance to low temperatures (Nair et al 2012).

In this experiment our main goal was to evaluate biological nutritional value (growth promoting effect) of three different ANE and to determine their usefulness for the winter vegetable production in the greenhouses without additional heating.

### Materials and Methods

The experiment was conducted in the experimental glasshouse of the Institute of vegetable crops, Smederevska Palanka (44° 22' N, 20° 57' E, altitude 101 m above sea level), in Serbia. The experiment was set up as a completely randomized block design with three replications. The soil type was vertisol with pH 6.6, 3.83% of organic matter, 0.19% of nitrogen, 1.29% of calcium carbonate, 838.8 ppm of available phosphorus and 392.6 ppm available potassium.

The previous crop was tomato (grown as monoculture; more than 8 years). Plant residues were removed following the tomato fruits harvest. Soil was watered by sprinklers and tilled by rototiller. During the first decade of December 2016, radish (*Raphanus sativus* var. *radicula* L. cv. *Saksa*) and spinach (*Spinacia olerace* L. cv. *Matador*) seeds were sown at the high rate density in rows separated 20 cm from one another and the garlic bulbs (*Allium sativum* L. cv. *Domaći jesenjak*) were planted in similar distance rows with 7.5 cm distance between bulbs inside the row. Each plot measured 4m<sup>2</sup>. After sowing and planting, the drip irrigation system was installed and the plots were covered by agro textile tiles in order to accumulate heat in rhizosphere and speed up emergence of crops.

When each crop emerged, excessive plants were removed and crop densities were decreased to terminal number of plants (80, 50 and 60 plants/m<sup>2</sup> of radish, spinach and onion respectively).

At the stage of two regular leaves, each crop was watered with three different ANE solutions, according to producers' instructions (Table 1.). The fourth treatment was water (control). Different ANE solutions were prepared as follows: four barrels (20l) were half filled with water. In three barrels, the ANE extracts were added (20, 40 and 40 ml of Biocomplex, ASCO Forte and SIB AF respectively) and the barrels were mixed by hands. Each ANE solution (10l) was sprinkled by hand-can with sieve as well as water used for control treatment. The experimental plots were previously watered by drip irrigation system. The can and sieve were carefully washed after each treatment. The same treatments were repeated after ten days.

During the experiment it was not noticed any pest or plant diseases appearance on experimental plants so the usual treatments with pesticides were not applied and all other measures of vegetable growing practice were in accordance with organic principles.



Table 1. Basic chemical properties of examined ANE and their concentration of application

Parameter	Biocomplex	Asco Forte	SIB AF 1/17
pH	4.1	6.4	8.4
Dry matter (%)	15.2	15.5	15.1
Organic matter (%)	9.2	11.2	11.6
N total (%)	0.27	0.22	0.24
C total (%)	4.5	5.5	5.7
Concentration of application (%)	0.2	0.4	0.4

When the crops reached commercial maturity, samples of 20 plants of radish, spinach and onion were taken and measured for examined parameters via analytical and technical scale (yields); radish (9.02.2017.): fresh plant mass, number of leaves per plant, hypocotyl mass and biomass yield per plot; spinach (14.03.2017.): fresh plant mass, number of leaves per plant, leaves mass and biomass yield per plot; onion (21.03.2017.): fresh plant mass, number of leaves per plant, plant height and biomass yield. Hypocotyl index (radish) was calculated and used for calculation of radish hypocotyl yield per area unit (Hypocotyl yield = Hypocotyl index \* biomass yield per ha; Hypocotyl index = average hypocotyl mass/fresh plant mass). Spinach commercial yield per unit area (ha) was calculated via average fresh plant mass, leaves mass and biomass yield per plot i.e. Spinach commercial yield (ha) = (average leaves mass / average fresh plant mass) \* biomass yield per plot \* 2.500.

One way ANOVA was performed for each examined parameter of both crops. The differences between average parameter values were compared by Duncan-test ( $p < 0.05$ ).

### Results and Discussion

The average temperature in December was 0.2°C and the sum of sunshine hours was 103, which slowed down the sprouting and initial growth of plants. In January, the average temperature was -4.3°C with 12 days with temperatures below 0°C throughout the whole day, and sum of 99 hours of sunshine, which additionally slowed down the growth, but also caused the freezing and decaying of plants that were not at appropriate stage of development. In February, average temperature was 5.1°C with sum of sunshine being 114 hours, which influenced the growth and development of crops very favorably. In March, average temperature was above average, 10.4°C and the sum of sunshine was 184 hours. All this influenced the growth and development of plants beneficially.

In case of radish plants treated with ANE, recorded were the average larger plant weight, higher number of leaves per plant, higher hypocotyl mass, higher hypocotil index and higher yield of hypocotyl per unit area compared to the control group of plants. However, only in the yield of the hypocotil per unit area in ASCOforte and SIB AF treatments, this difference was statistically significant (Table 2).

Table 2. Average plant mass, number of leaves, hypocotyl mass, hypocotyl index and radish hypocotyl yield, recorded in control treatment and in treatments of the tested ANE.

Treatment	Plant mass <sup>ns</sup> (g)	Number of leaves <sup>ns</sup>	Hypocotyl mass <sup>ns</sup> (g)	Hypocotyl index <sup>ns</sup>	Hypocotyl yield (t/ha)*
Control	24.47	7.87	10.82	0.44	4.81 <sup>a</sup>
Biocomplex	25.51	8.2	12.07	0.47	5.23 <sup>ab</sup>
ASCOforte	26.62	8.01	11.79	0.44	5.42 <sup>b</sup>
SIB AF 1/17	25.28	7.91	11.57	0.46	5.57 <sup>b</sup>

Values within the same column followed by the same letter do not differ significantly (p<0.05)

Compared to the control of ANE treated spinach plants, larger plant mass, higher number of leaves, higher root mass, higher mass per plant, and higher market yield was recorded. In the ASCOforte and SIB AF treatment, mass of the plant, root mass and market yield, and in regards to the control, the difference was statistically significant (p<0.05). Regarding the control treatment but also the other two ANE, there was no statistically significant difference in yield in the Biokomplex treatment (Table 3).

Table 3. Average plant mass, number of leaves, root mass, laves mass, yield imdex and market yield of spinach, recorded in control treatment and treatment of tested ANE.

Treatment	Plant mass (g)*	Number of leaves <sup>ns</sup>	Leaves mass (g) <sup>ns</sup>	Root mass (g)*	Commercial yield (t/ha)*
Control	12.54 <sup>a</sup>	7.93	6.85	1.62 <sup>A</sup>	2.58 <sup>a</sup>
Biocomplex	15.79 <sup>ab</sup>	7.97	7.96	2.06 <sup>AB</sup>	3.25 <sup>ab</sup>
ASCOforte	17.55 <sup>b</sup>	8.38	8.87	2.37 <sup>B</sup>	3.89 <sup>b</sup>
SIB AF 1/17	15.73 <sup>ab</sup>	8.22	8.38	2.2 <sup>B</sup>	3.91 <sup>b</sup>

Values within the same column followed by the same letter do not differ significantly (p<0.05)

In garlic plants treated with ANE, compared to the control, noted were the higher plant mass, greater number of leaves, larger plant height and higher yield. In all three ANE treatments, difference was statistically significantly higher (Table 4)

Table 4. Average plant mass, number of leaves, height of plants and garlic yield, recorded on the control treatment and the treatment of the tested ANE.

Treatment	Plant mass (g)*	Number of leaves <sup>ns</sup>	Plant height (g) <sup>ns</sup>	Yield (t/ha)*
Control	7.33 <sup>a</sup>	5.40	36.9	3.08 <sup>A</sup>
Biocomplex	9.77 <sup>b</sup>	5.95	40.74	4.4 <sup>B</sup>
ASCOforte	10.23 <sup>b</sup>	5.49	40.55	4.39 <sup>B</sup>
SIB AF 1/17	9.18 <sup>b</sup>	5.73	37.15	4.11 <sup>B</sup>

Values within the same column followed by the same letter do not differ significantly (p<0.05)

Many studies indicate that application of seaweed increases the yield of vegetable crops (Jayaraman et al 2011; Jannin et al 2013; Đurić et al 2014; Abkhoo and Sabbagh, 2016) but there is also a number of studies with opposite results (Lola-Luz et al 2013; Yusuf et al 2015).

Testing the effects of ANE foliar application on cabbage, Lola-Luz et al (2013) determined qualitative improvements i.e. increase in phenol and flavonoid compounds, however, no significant increase in yield relative to control was found. The absence of effects in the above case could be attributed to the method of ANE application, since it was noticed that watering had better effects than foliar application of ANE (Abkhoo and Sabbagh, 2016).

Increase in growth of plants treated with ANE is associated with better health conditions and greater resistance to plant diseases (Jayaraman et al 2011). In our study, no harmful insects or diseases were observed, both on plants treated with ANE and on control treatment.

Đurić et al (2014) and Yusuf et al (2015) have found that ANE can influence the increase in vegetative mass of the plant, in particular the increase in root mass, i.e. Hypocotyl. The effect on treated plants seems to depend on the type of ANE used. By examining different ANE on *Brassica napus*, no statistically significant increase in root biomass and overheads was observed in all ANE treatments (Jannin et al 2013).

Our results are in accordance with experiments of Janin et al. (2013), Đurić et al (2014), Yusuf et al (2015), especially when it comes to garlic and spinach where statistically significant increase in average root mass and average plant mass was determined.

On the other hand, the absence of a statistically significant effect of the ANE application in the observed properties in radish is most likely due to short vegetation period of the investigated species, and in particular due to the short period of time, since the moment of treatment with the investigated agents, until the moment of harvesting.

An increase in yield of radish could be attributed to a larger number of plants that survived negative temperatures, which is in accordance with results of Nair et al (2012), which confirmed the increase in tolerance to low temperatures on *Arabidopsis thaliana* plants.

### **Conclusion**

Based on the results of the experiment, use of the tested ANE can be recommended for winter vegetable production in greenhouses. All three investigated ANE showed positive effects on yield and observed properties. Given the relatively low content of the main nutrient macroelements in ANE and relatively small dose of application, it can be concluded that the cause of increased growth and yield of treated plants, is not the main macroelements, but some physiologically active substances found in ANE. The obtained results on radish, spinach and garlic lead to assumption about the effectiveness of ANE on other plant species during the winter production season in greenhouses. The special benefit of ANE is that their production is renewable and can be applied both in conventional production and in organic farming systems.

### **References**

- Abkhoo J., Sabbagh K.S. (2016): Control of *Phytophthora melonis* damping-off, induction of defense responses, and gene expression of cucumber treated with commercial extract from *Ascophyllum nodosum*. *Journal of Applied. Phycology* 28:1333–1342
- Alam M.Z., Braun G., Norrie J., Hodges D.M. (2013): Effect of *Ascophyllum* extract application on plant growth, fruit yield and soil microbial communities of strawberry. *Canadian Journal of Plant Science*, 93(1), 23-36.
- Audibert L., Fauchon M., Blanc N., Hauchard D., Ar Gall E. (2010): Phenolic compounds in the brown seaweed *Ascophyllum nodosum*: distribution and radical-scavenging activities. *Phytochemical analysis*, 21(5), 399-405.

- Carpenter S.R. (2005): Eutrophication of aquatic ecosystems: bistability and soil phosphorus. *Proceedings of the National Academy of Sciences of the United States of America*, 102(29), 10002-10005.
- Craigie J.S. (2011): Seaweed extract stimuli in plant science and agriculture. *Journal of Applied Phycology*, 23(3), 371-393.
- Diacono M., Rubino P., Montemurro F. (2013): Precision nitrogen management of wheat. A review. *Agronomy for Sustainable Development*, 33(1), 219-241.
- Đurić M., Mladenović J., Pavlović R., Zdravković J. (2014): Application of Bio-stimulator Biocomplex 900 in Producing Tomato (*Lycopersicon esculentum* Mill.) Seedling. *Acta Agriculturae Serbica*, Vol. XIX, 38: 97-1031
- Fan D., Hodges D.M., Zhang J., Kirby C.W., Ji X., Locke S.J., Prithviraj B. (2011): Commercial extract of the brown seaweed *Ascophyllum nodosum* enhances phenolic antioxidant content of spinach (*Spinacia oleracea* L.) which protects *Caenorhabditis elegans* against oxidative and thermal stress. *Food Chemistry*, 124(1), 195-202.
- Guinan K.J., Sujeeth N., Copeland R.B., Jones P.W., O'Brien N.M., Sharma H.S.S., O'Sullivan J.T. (2012, November): Discrete roles for extracts of *Ascophyllum nodosum* in enhancing plant growth and tolerance to abiotic and biotic stresses. In I World Congress on the Use of Biostimulants in Agriculture 1009 (pp. 127-135).
- Huang S.S., Liao Q.L., Hua M., Wu X.M., Bi K.S., Yan C.Y., Chen B., Zhang X.Y. (2007): Survey of heavy metal pollution and assessment of agricultural soil in Yangzhong district, Jiangsu Province, China. *Chemosphere*, 67(11), 2148-2155.
- Jannin L., Arkoun M., Etienne P., Laine P., Goux D., Garnica M., Fuentes M., San Francisco S., Baigorri R., Cruz F., Houdusse F., Garcia-Mina J.-M., Yvin J.-C., Ourry A. (2013): *Brassica napus* Growth is Promoted by *Ascophyllum nodosum* (L.) Le Jol. Seaweed Extract: Microarray Analysis and Physiological Characterization of N, C, and S Metabolisms. *Journal of Plant Growth Regulation* 32:31–52
- Jayaraman J., Norrie J., Punja Z.K. (2011): Commercial extract from the brown seaweed *Ascophyllum nodosum* reduces fungal diseases in greenhouse cucumber. *Journal of Applied Phycology* 23:353–361.
- Khan W., Rayirath U.P., Subramanian S., Jithesh M.N., Rayorath P., Hodges D.M., Alan T., Critchley J., Craigie S., Norrie J., Prithviraj B. (2009). Seaweed extracts as biostimulants of plant growth and development. *Journal of Plant Growth Regulation*, 28(4), 386-399.
- Lola-Luz T., Hennequart F., Gaffney M. (2013): Enhancement of phenolic compounds in cabbage (*Brassica oleracea*) following application of commercial seaweed extracts the brown seaweed (*Ascophyllum nodosum*). *Agricultural and food science* 22: 288-295
- Nair P., Kandasamy S., Zhang J., Ji X., Kirby C., Benkel B., Prithviraj B. (2012): Transcriptional and metabolomic analysis of *Ascophyllum nodosum* mediated freezing tolerance in *Arabidopsis thaliana*. *BMC genomics*, 13(1), 643.
- Schmidt A.L., Coll M., Romanuk T.N., Lotze H.K. (2011): Ecosystem structure and services in eelgrass *Zostera marina* and rockweed *Ascophyllum nodosum* habitats. *Marine Ecology Progress Series*, 437, 51-68.
- Sebilo M., Mayer B., Nicolardot B., Pinay G., Mariotti A. (2013): Long-term fate of nitrate fertilizer in agricultural soils. *Proceedings of the National Academy of Sciences*, 110(45), 18185-18189.
- Stojanovic M., Popic J.M., Stevanovic D., Martinovic L.J. (2006): Phosphorus fertilizers as a source of uranium in Serbian soils. *Agronomy for sustainable development*, 26(3), 179-183.

- Vera J., Castro J., Gonzalez A., Moenne A. (2011): Seaweed polysaccharides and derived oligosaccharides stimulate defense responses and protection against pathogens in plants. *Marine drugs*, 9(12), 2514-2525.
- Yuan Y., Macquarrie D. (2015): Microwave assisted extraction of sulfated polysaccharides (fucoidan) from *Ascophyllum nodosum* and its antioxidant activity. *Carbohydrate polymers*, 129, 101-107.
- Yusuf R., Kristiansen P., Warwick N. (2015): Effect of Two Seaweed Products on Radish (*Raphanus sativus*) Growth Under Greenhouse Conditions. *Agroland: The Agriculture Science Journal*, 2015 2(1): 1 – 7
- Zodape S.T., Mukhopadhyay S., Eswaran K., Reddy M.P., Chikara J. (2010): Enhanced yield and nutritional quality in green gram (*Phaseolus radiata* L) treated with seaweed (*Kappaphycus alvarezii*) extract.

## INFLUENCE OF ORGANIC FERTILIZATION ON THE BIOCHEMICAL COMPOSITION OF FRESH AND DRIED FRUITS OF JAPANESE QUINCE (CHAENOMELES SP.)

Teodora MIHOVA<sup>1\*</sup>, Diyan GEORGIEV<sup>1</sup>, Boryana BRASHLYANOVA<sup>2</sup>, Petya IVANOVA<sup>2</sup>

<sup>1</sup>Research Institute of Mountain Stockbreeding and Agriculture, 5600 Troyan, Bulgaria

<sup>2</sup> Food Research and Development Institute – Plovdiv, Bulgaria, 4000 Plovdiv, Vasil Aprilov Str. 154

\*Corresponding author: teodora.mihova@gmail.com

### Abstract

The experiment was conducted in 2014 in the experimental plantations of Japanese quince (*Chaenomeles sp.*) at RIMSA in Troyan, in cooperation between RIMSA-Troyan and FRDI-Plovdiv, Bulgaria. The influence of the organic fertilizer Tekamin Brix (in two concentrations 0.2% and 0.3%), NH<sub>4</sub>NO<sub>3</sub> and manure on the biochemical composition of fresh and dried fruits of Japanese quince were studied. The effect of drying process on the biochemical indicators was reported. Fertilization influenced on the values of tannins, total and inverted sugar in fresh fruits. After the drying process the amount of ascorbic acid was better preserved in fruits fertilized with Tekamin Brix 0.2 %. - 40.48 mg/% and the control - 42.24 mg/%. In dried fruits the total sugars have a higher content than the variant with Tekamin Brix 0.2%. The highest amounts of tanning substances and pectin in dried fruits are found in fruit fertilized with Tekamin Brix 0.3% and mineral fertilizer. The highest acidimetric coefficient for the fresh and dried fruits is found in the variant with the mineral fertilizer.

**Key words:** *Japanese quince (Chaenomeles sp.), Fresh fruit, Dry fruit, Bio chemical compounds, Organic fertilizers.*

### Introduction

Under the changing climate, *Chaenomeles* deserves great attention because of its increased cold and drought resistance. Chemical additives in food production have been continuously increasing worldwide in recent years. In response to the increased interest in pure agricultural products, Japanese quince is an appropriate culture for inclusion in organic production and sustainable agriculture in Bulgaria.

The fruits of *Chaenomeles japonica* are used in the food industry for processing because of their high content of biologically active compounds: organic acids, vitamin C, phenolic compounds, pectin and aroma components (Lesinska *et al.*, 2006). Vitamin C content in fruits differs from 41.2 to 105.8 mg 100 g<sup>-1</sup>, phenolic compounds range from 523.9 to 1271.7 mg 100 g (Krasnova *et al.*, 2007). Another property of great interest is its presumed high antioxidant capacity due to the content of vitamin C and phenolic compounds. The content of vitamin C is 45 to 109 mg 100 ml<sup>-1</sup> and phenolic compounds in juice of the *Chaenomeles japonica* was 210 – 592 mg 100 ml<sup>-1</sup> (Hellin *et al.*, 2003).

Drying is a method that has been applied as a way to preserve fruits. The process includes different variants of application in order to obtain the finished product. It is opened, as it is being improved all the time in the different stages and elements of technology. An important element in the different drying technologies is to follow the changes in biochemical compositions of fruits ( Mezhenkii, 2004; Mondeshka, 2005; Graeme *et al.*, 2007; Rupasova *et al.*, 2008; Figueiredo, 2009;; Zhu *et al.*, 2012; Zhang *et al.*, 2014). Dried fruits in the form of a powder

are a dietary supplement used as a health prevent atherosclerosis and have antioxidant effects (Tang *et al.*, 2000; Dharmananda; 2005; Malgorzata *et al.*, 2007; Tang *et al.*, 2010).

Dried fruits from *Chaenomeles sp.* are used from thousands of years in Chinese medicine. Japanese quince is a valuable remedy in China, and occupies a significant component of their prescriptions (Chace *et al.*, 1997; Dharmananda S., 2005; Sagar *et al.*, 2010; Figueiredo, 2009).

### Material and Methods

The experiment was carried out in 2014 in a demonstration plantation of the Research Institute of Mountain Stockbreeding and Agriculture – Troyan (Bulgaria). Five genotypes of *Chaenomeles* were included in each variant. Different fertilization types were used, such as the organic fertilizer Tekamin Brix, mineral fertilizer (ammonium nitrate -  $\text{NH}_4\text{NO}_3$ ) and manure. The results are presented as averaged values of each variant and compared with the control. The planting scheme is 2.50/1.50 m. Cultivation technology includes grassed inter row spacing. The intra row spacing is kept in black fallow under non-irrigating conditions. The crop is grown according to its agro-technical requirements.

The following fertilization variants have been applied in the experiment:

- Tekamin Brix - 0.2 % - foliar treatment, applied two times during the period of vegetation
- Tekamin Brix - 0.3 % - foliar treatment, applied two times during the period of vegetation
- Ammonium nitrate ( $\text{NH}_4\text{NO}_3$ ) - 0.200g/bush (before the period of vegetation)
- Manure - 5 kg/bush – (before the period of vegetation)
- Control.

Fruits reached their ripening stage in October. Drying process was fulfilled in FRDI-Plovdiv, and the biochemical composition was determined at a chemical laboratory at RIMSA-Troyan.

### Results and Discussion

Data from the biochemical composition results of fresh and dried fruits of *Chaenomeles* are presented in Table 1 and Figure 1.

The dry weight of fresh fruits of the variants ranges from 11.96% (control) to 14.15% (manure variant) (Table 1). The fertilization factor affects the values of the indicator. In terms of refractometric dry substances, the lowest values were found again in the control - 8.38% and the highest in fruit treated with the organic fertilizer Tekamin Brix - 12.17%. An increased content in the amount of sugars was reported in the variant with fertilization compared to the control (Figure 1).

There is no significant variation in the total sugar content, which is slightly above five percent in the variant with fertilization. It is 4.40% in the control. The highest amount of invert sugar is found in manure variant - 4.40% and the mineral fertilizer - 4.13%. For comparison, it is 3.50% for the control. This is not the trend in the sucrose content of fruit. The highest content is found in the variants with a higher concentration of the organic fertilizer - 1.50%, followed by those with a lower concentration - 1.13% of the same fertilizer. Organic acid values are in close range between variants, more than two percent. Fertilization did not significantly affect the amounts of ascorbic acid, which is 99.44 mg /% in fruit fertilized with 0.2% Tekamin Brix and its content is very close in the control 98.12 mg /%.

Table 1. Biochemical composition of fresh and dried *Chaenomeles* fruits in different variants of fertilization.

Fertilizer	Type of fruits	Dry weight	DM in %	Organic acids %	Ascorbic acid mg/%	Tannins %	Pectin %
Tekamin Brix 0.2%	Fresh fruits	13.02	8.43	2.33	99.44	0.503	0.437
	Dry fruits	90.02		10.08	40.48	0.865	0.987
Tekamin Brix 0.3%	Fresh fruits	13.29	12.17	2.17	95.63	0.558	0.777
	Dry fruits	90.66		9.40	29.33	1.305	3.095
NH <sub>4</sub> NO <sub>3</sub>	Fresh fruits	14.02	9.33	2.14	92.11	0.361	0.830
	Dry fruits	90.46		7.92	27.57	1.195	3.050
manure	Fresh fruits	14.15	9.50	2.44	87.41	0.440	0.770
	Dry fruits	90.03		9.48	30.51	0.904	1.233
Control	Fresh fruits	11.96	8.38	2.24	98.12	0.442	1.030
	Dry fruits	90.45		10.26	42.24	0.992	1.500
V%	Fresh fruits	6.52	12.86	8.25	10.75	20.16	34.22
	Dry fruits	0.80		10.77	22.88	16.99	79.43

As far as tanning substances are concerned, they are clearly higher in the variants with the organic fertilizer Tekamin Brix with values of 0.558% at the higher fertilizer concentration and 0.503% at its lower dose. The smallest amount is found for fruits fertilized with ammonium nitrate - 0.361%. The results of pectin amounts indicate that fertilization does not affect its content in fruits. It reaches up to 1.030% in the control variant, and the lowest amount is found in the fertilization variant with Tekamin Brix - 0.2% - 0.437%.

The analyzed organic acids of which *Chaenomeles* fruits are rich. There are not significant differences between the variants in the amount of analyzed organic acids, which *Chaenomeles* fruits are rich in. However, the fruits fertilized with ammonium nitrate have the smallest amount of organic acids - 7.92% and more in the control - 10.26%. The drying process had an effect on ascorbic acid values. In comparison with fresh fruits are reported two to three times lower amounts, while it is better maintained in the variants with Tekamin Brix - 0.2% - 40.48 mg/% and the control - 42.24 mg/%. A significant increase in tanning substances has been registered. The most significant increase is found in the mineral fertilization variant up to 1.195%. The amount of pectin is most significant in the variants with Tekamin Brix 0.3% - 3.095% and with the mineral fertilization - 3.050%. The lowest content is found in the variant with Tekamin Brix 0.2% - 0.987%.

The variation of values in dry weight, dry refractometric, organic acid and ascorbic acid for fresh fruit is low to medium high and high for tannins and pectin. The highest variation in ascorbic acid and pectin for dried fruits ratios is the highest.

LSD there is no statistical significance of fresh and dried fruits.



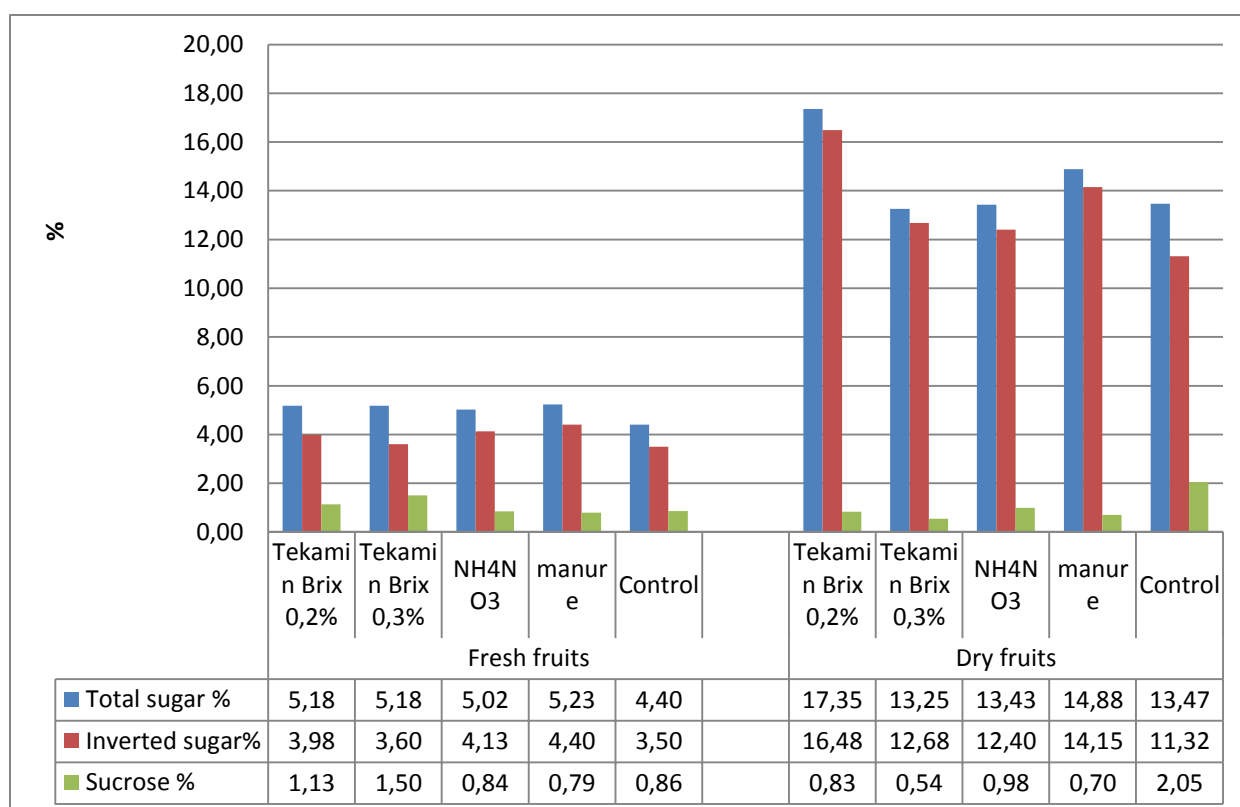


Figure 1. Total sugar, inverted sugar and sucrose in fresh and dried Chaenomeles fruits in different variants of fertilization, (%).

The drying process has had an effect on the total sugar content of fruits in some of the variants, in relation to its values in fresh fruit (Figure 1). The largest amounts were reported in the variants with the application of Tekamin Brix - 0.2% - 17.35% and significantly less are in the other variant with the application of organic fertilizer with a higher concentration - 13.25%. When invert sugar is analyzed, the trend remains as in the case of fresh fruit. The fertilized variants have higher values of the indicator, the most striking being the difference between the first variant - 16.48% in comparison to the rest.

The drying process also affects the amounts of sucrose. Unlike fresh fruit, the largest amount in dried fruit is found in the control variant - 2.05%. In the other variants, sucrose is present in amount below one percent.

For dry fruits, the dry weight is almost equal in the variants - about and above 90% (Table 1).

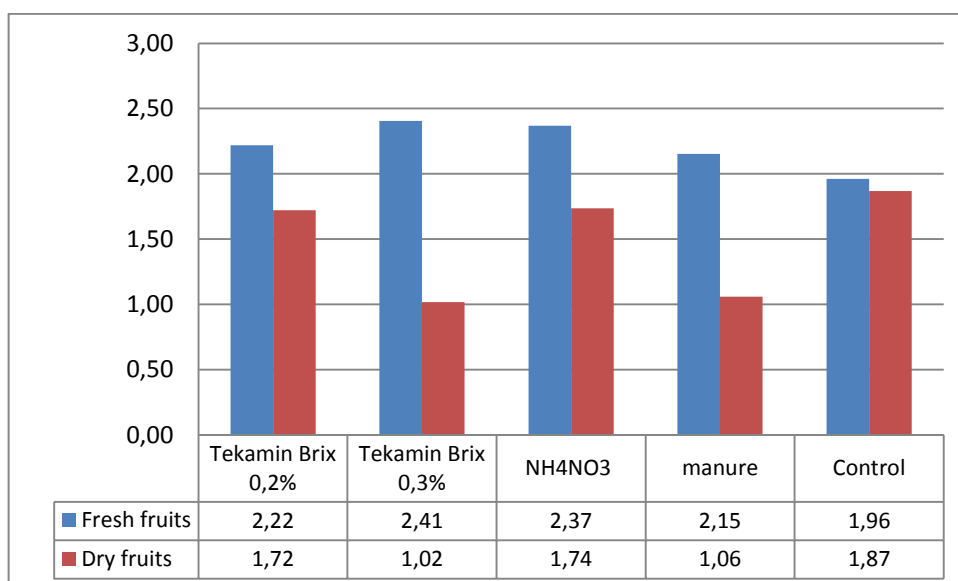


Figure 2. Acidimetric (sugar-acid) coefficient of fresh and dried *Chaenomeles* fruits in different drying variants.

The acidimetric coefficient determining the taste properties of fruits is presented in Figure 2. Generally, it is higher for fresh fruit. Its values are most significant for fruits in the variants with Tekamin Brix 0.3% and the mineral fertilization. The lowest value is found in the control. The highest acidimetric coefficient is reported for dried fruit in the control variant and the mineral fertilization. Its values are almost the same for the Variants with Tecamine Brix - 0.3% and for manure variant.

For fresh fruit, the variation in dry weight, dry refractometric, organic acid and ascorbic acid values is low to medium high and high for tannins and pectin. For dried fruits, the highest variation in ascorbic acid and pectin ratios is the highest. LSD there is no statistical significance of fresh and dried fruits.

### Conclusion

The influence of fertilization on the biochemical composition of fresh and dried fruits of *Chaenomeles* fruit has been reported.

The effect of drying process on the individual biochemical parameters is monitored.

Fertilization of fresh fruit has been influenced by the values of tanning substances, total and invert sugar.

After the drying process, the quantity of ascorbic acid is better maintained in fruit that were fertilized by Tecamin Brix with 0.2% - 40.48 mg /% and the control - 42.24 mg /%.

In dried fruits the total sugars have a higher content than the variant with Tecamin Brix 0.2%.

The highest amounts of tanning substances and pectin in dried fruits are found in fruit fertilized with Tekamin Brix 0.3% and mineral fertilizer.

The highest acidimetric coefficient for fresh fruit is found in the variants with Tekamin Brix 0.3% and mineral fertilizer, and for the dried fruits – with  $\text{NH}_4\text{NO}_3$  and the control.

### References

- Mondeshka P. (2005). Medicinal fruit species. Sofia. Bulgaria.  
 Mezhenskii V. (2004). Storage and use of a collection of non-traditional fruit crops. 1. *Chaenomeles* (*Chaenomeles* Lindl.) Genetic plant resources, №1

- Rupasova Zh., Garanovich, I., Vasilevskaya T, Varavina N., Rudakovskaya R. (2008). Comparative assessment of new varieties introduced forms of *Chaenomeles maulei* (Mast.) C. K. Schneid. According to accumulation of organic acids and carbohydrates in fruits in the conditions of Belarus. National Academy of Sciences of Belarus. Series of Agrarian Sciences № 1
- Chace C., Zhang T. (1997). *A Qin Bowei Anthology*. Paradigm Publications, Brookline, MA.
- Dharmananda S. (2005). *Chaenomeles A Relaxing and Strengthening Fruit*.
- Figueiredo, G. (2009). Estabelecimento in vitro de marmeleiro japonas (*Chaenomeles sinensis* Koehne) CV Andramig. Universidade Federal de Pelotas. x
- Graeme E. (2007). *The Health Benefits of Traditional Chinese Plant Medicines: Weighing the scientific evidence*. p. 38-39.
- Hellin P., Vila, R., Jordan, M., Laencina, J., Rumpunen, K., Ros, J. (2003). Characteristics and composition of *Chaenomeles* fruit juice. I/In: *Japanese quince - Potential fruit crop for Northern Europe*. Sid./p. 127-139. Department of Crop Science, Swedish University of Agricultural Sciences ISBN 91-631-3765-8
- Krasnova I., Ruisa S., Seglina D. (2007). Investigations of the Biochemical Composition of *Chaenomeles japonica* fruits. *Chemine Technologija, Kaunas*, 4 (46), pp. 16-20.
- Lesinska E., Przybylski R., Eskin N. (1988). Some volatile and non volatile flavor components of the dwarf quince (*Chaenomeles japonica*). *Journal of Food Science*. Vol. 53. 854–856.
- Malgorzata S., Gorlach S., Podsedek A., Sosnowska D., Koziolkiewicz M., Hrabec Z., Hrabec E. (2007). Procyanidin Oligomers from Japanese Quince (*Chaenomeles japonica*) Fruit Inhibit Activity of MMP-2 and MMP-9 Metalloproteinases. *J. Agric. Food Chem.*, 55 (16), pp 6447–6452
- Sagar V., Suresh Kumar P. (2010). Recent advances in drying and dehydration of fruits and vegetables: a review. *J Food Sci Technol*. 47(1): 15–26.
- Tang Y., Yu X., Mi M., Zhao J., Wang J., Zhang T. (2010). Antioxidative property and antiatherosclerotic effects of the powder processed from *Chaenomeles speciosa* in apoe mice. *Journal of Food Biochemistry*. vol. 34. no. 3. pp. 535–548.
- Tang C., Ye Z., Xiang Z., Shi Y., Ren Sh.. (2000). Nutrients of chinese flowering quince and its functions. *Natural Product Research and Development* vol.4.
- Zhu Q., Liao C., Liu Y.(2012). Ethanolic extract and water-soluble polysaccharide from *Chaenomeles speciosa* fruit modulate lipopolysaccharide-induced nitric oxide production in RAW264.7 macrophage cells. *Journal of Ethnopharmacology*, vol. 144, no. 2, pp. 441–447
- Zhang S., Han L., Zhang H., Xin H. (2014). *Chaenomeles speciosa*: a review of chemistry and pharmacology. *Bioscience Reports*, vol. 2, no. 1, pp. 12–18

## DETERMINATION OF VERMICOMPOST AND AMMONIUM NITRATE APPLICATIONS EFFECTIVENESS ON BROCCOLI WITH SOIL AND LEAF ANALYSES

Ali ZAHMACIOĞLU<sup>1</sup>, Yeşim AHI<sup>2\*</sup>, Korkmaz BELLİTÜRK<sup>1</sup>

<sup>1</sup>Department of Soil Science, Faculty of Agriculture, Namık Kemal University, 59030 Tekirdağ, Turkey

<sup>2</sup>Water Management Institute, Ankara University, 06135 Ankara, Turkey

\*Corresponding author: ysmahi@ankara.edu.tr

### Abstract

The aim of this study was to evaluate irrigation and fertilizer requirements of broccoli (*Brassica oleracea* L. var. *italica*) in Tekirdağ region. For this purpose, using fertigation techniques, growing possibilities of broccoli and the effects of soil and plant to fertilizer concentrations have been established and compared with applied fertilizer rates and irrigation water volumes. Field trials were conducted in a greenhouse during the year 2016 spring and autumn periods. Experiment was applied at two different irrigation levels and four different fertilizer with the randomized complete block experimental design and three replicates. Irrigation water ratio was, depending on the greenhouse soil moisture monitoring; the irrigation application was started when available soil moistures drops to 60% and deficit soil water was completed at 50 (I<sub>2</sub>) and 100% (I<sub>1</sub>) percent. Fertilizer applications was performed as vermicompost, two different doses of liquid worm-fertilizer and ammonium nitrate. Generally, the effects of irrigation and fertilizer amounts on yield and macro and micro nutrient content of plant and soil were statistically significant. The greatest broccoli yield was obtained in the spring period from I<sub>1</sub>G<sub>4</sub> treatment as 1665 kg da<sup>-1</sup> and in the autumn period yield did not obtained. It was observed that fertilizer activity increased with irrigation practices, chemical fertilizer applications contributed to yield; also, vermicompost applications have been shown to contribute to soil in respect of soil and leaf nutrients.

**Key Words:** Broccoli, vermicompost, fertigation, organic fertilizer, chemical fertilizer

### Introduction

In order to meet the rapidly increasing food needs of humans, it is necessary to increase the yield and quality obtained from the unit area. Cropping systems involves studies about determining when and how much irrigation and also which fertilizers to apply to a plant during its growing period. Within this scope; it is first needed to choose proper irrigation and fertilizer scheduling, which allows efficient use of available water and fertilizer will not cause yield decrease. Decreasing water resources and water demands have enabled the development of irrigation technologies. Today, with controlled irrigation water, removing the problem of drainage and salinity in the soil, the use of organic fertilization and irrigation systems that will increase yield-quality gains more and more importance (Çetin *et al.*, 2006). Organic fertilizers, which are becoming more and more popular, are at the forefront of organic worms called vermicompost. In previous studies relating to vermicompost, they reported that the earthworm for agroecosystems have a very significant impact on the quality of soil (Edwards and Bohlen, 1996; Çitak *et al.*, 2011; Bellitürk and Görres, 2012; Jahan *et al.*, 2014; Adiloğlu *et al.*, 2015). The aim of this study was to evaluate irrigation and fertilizer requirements of broccoli (*Brassica oleracea* L. var. *italica*) in Tekirdağ region (Turkey). For this purpose, using fertigation techniques, growing possibilities of broccoli and the effects of soil and plant

to fertilizer concentrations have been established and compared with applied fertilizer rates and irrigation water volumes.

### **Materials and Methods**

Field trials were conducted in a greenhouse during the year 2016 spring and autumn periods in the city of Tekirdağ (Turkey). Each plot covered an area of 9.00 m<sup>2</sup> and contained 42 plants with 0.50 m x 0.40 m spacing. The soil type is deep, heavy textured, well-drained and the available water holding capacity within 0.60 m of the soil profile is approximately 80 mm. The electrical conductivity (EC) of irrigation water was classified as C<sub>2</sub>S<sub>1</sub> according to U.S. Salinity Lab. (US Salinity Laboratory Staff, 1954). Experiment was applied at two different irrigation levels and four different fertilizer with the randomized complete block experimental design and three replicates. Irrigation water ratio was, depending on the greenhouse soil moisture monitoring; the irrigation application was started when available soil moisture drops to 60% and deficit soil water was completed at 50(I<sub>2</sub>) and 100% (I<sub>1</sub>) percent. Fertilizer applications was performed as vermicompost, two different doses of liquid worm-fertilizer and ammonium nitrate. In the research, soil moisture levels was monitored gravimetrically. Irrigation system was composed of water source, fertilizer tank, screen filter, pipelines and drippers, respectively. In the research greenhouse, climatic elements were monitored throughout the cultivating period from the meteorology station that was placed into the greenhouse. Irrigation water was applied to plots with drip irrigation. Effective root depth was 30-60 cm and evapotranspiration rates were calculated with respect to 60 cm soil depth, according to water budget approach (Walker and Skogerboe, 1987). Rumba F1 seedlings were planted by hand into the parcels of which the field preparation was completed on April 15<sup>th</sup>, 2016 (DOY 106) in spring and on October 01<sup>st</sup>, 2016 (DOY 274) in autumn. Yield harvest was completed on June 27<sup>th</sup>, 2016 in spring season. Plants have not reached the harvest maturity due to the negative weather conditions in autumn. Produce leaf and soil samples taken from each parcel were taken to the laboratory, physical measurements and also chemical analyzes were completed according to methods of Sağlam (2012), Kacar (2009), Lindsay and Norvell (1978). Irrigation water use (WUE) and water use efficiency (IWUE) rates were calculated based on the irrigation water applied to trial subjects, measured evapotranspiration and harvest efficiency values (Zhang *et al.*, 1999). The variance analysis of the data obtained from the research, the significance control of the variations between the averages, the correlations between the characters studied were determined according to the principals stated in Yurtsever (1984) using SPSS 8.0.

### **Results and Discussions**

The maximum interior temperature value was measured as 30°C in the month June while the minimum interior temperature value was measured as 17°C in the month April in spring according to the meteorology station. These values changed between 22 and 2.4 °C in autumn. The growth periods and growing season lengths for the year 2016 is shown in Figure 1. Seasonal total evapotranspiration, the amounts of applied irrigation water, yield and yield parameters for all treatments during the spring periods, are summarized in Table 1. Treatments were irrigated using fertigation method nine times in the spring and autumn growing periods at varying day intervals. The macro and micro element quantities obtained from broccoli leaf samples and soils taken in the all plots, also ANOVA results of each element are studied for the spring and autumn periods, but only the spring period results are presented in Table 2,3.

Generally, the effects of irrigation and fertilizer amounts on yield and macro and micro nutrient content of plant and soil were statistically significant. The greatest broccoli yield was

obtained in the spring period from I<sub>1</sub>G<sub>4</sub> treatment as 16.65 t ha<sup>-1</sup> and in the autumn period yield did not obtained. Some of parameters measured on the leaf have remained within the desired limits, parallel to the work carried out previously (Jones *et al.*, 1991; Alpaslan *et al.*, 1998; Bergmann, 1992; İbrikçi *et al.*, 2004). The fact that the Ca, P, Mg, N contents of soil samples are below the limit values is "insufficient" and that the Fe, Cu, Ca, K elements are more than the limit values is "sufficient" (Lindsay and Norvell, 1978; Tovep, 1991; Güneş *et al.*, 2010; Kacar, 2009). In particular, vermicompost applications cause enrichment of the soil in terms of Fe, Zn, K elements (Preetha *et al.*, 2005; Chamani *et al.*, 2008; Sinha *et al.*, 2010).

The highest IWUE values for the adequate water applied treatment were obtained from subject G<sub>4</sub> and G<sub>1</sub> as 4.23 kg m<sup>-3</sup> and 3.44 kg m<sup>-3</sup>, respectively.

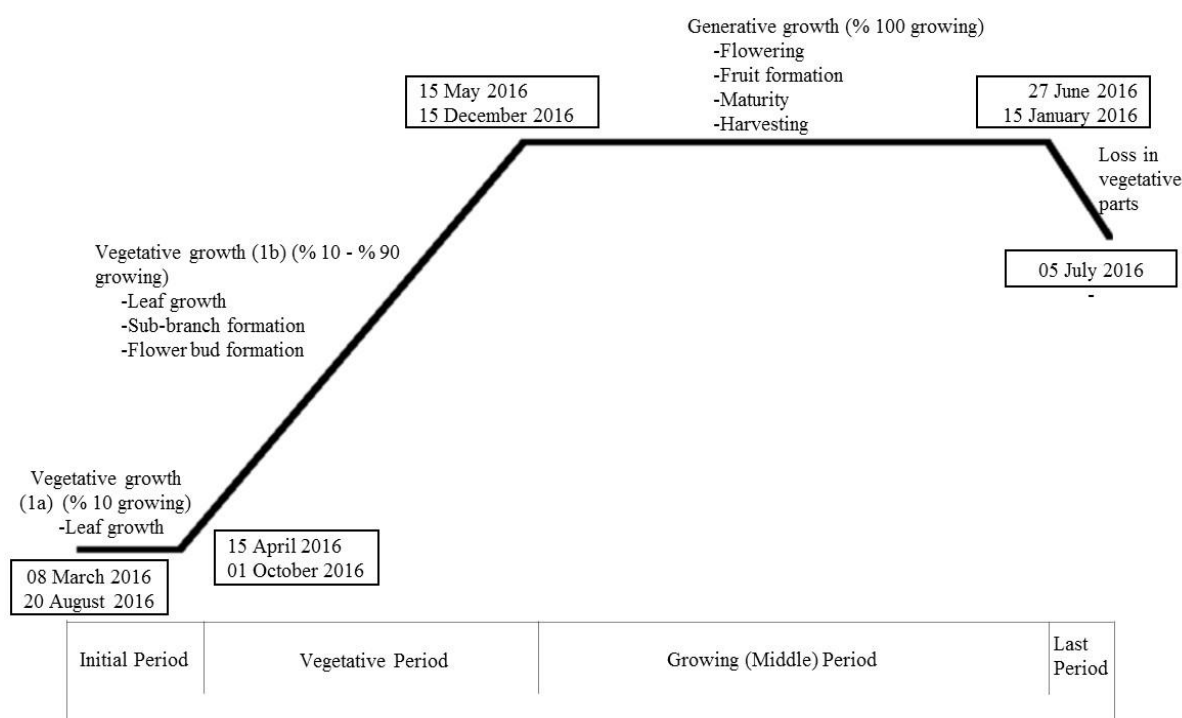


Figure 1. Growth periods of broccoli

Table1. Yield and water parameters for all treatments

Irrigation treatment	Fertilizer treatment	Average yield (t ha <sup>-1</sup> )	Irrigation water applied (mm)	Seasonal ET (mm)	IWUE (kg m <sup>-3</sup> )	WUE (kg m <sup>-3</sup> )
I <sub>1</sub>	G <sub>1</sub>	14.85b	432	441	3.44	3.37
	G <sub>2</sub>	10.43b	403	412	1.63	1.59
	G <sub>3</sub>	12.23b	442	451	2.77	4.07
	G <sub>4</sub>	16.65a	394	394	4.23	4.23
I <sub>2</sub>	G <sub>1</sub>	5.06b	216	273	2.37	1.85
	G <sub>2</sub>	6.16b	202	259	2.34	2.39
	G <sub>3</sub>	3.18b	221	269	1.34	1.19
	G <sub>4</sub>	13.37a	197	253	6.78	5.28

Table 2. Macro and micro elements of leaf in spring season

Variations	Irrigation treatment	Fertilizer treatment	Macro Elements					Micro Elements				
			N (%)	P%	K (%)	Ca (%)	Mg (%)	B (ppm)	Cu (ppm)	Fe (ppm)	Mn(ppm)	Zn (ppm)
Irrigation level	I <sub>1</sub>		0.07	1.23	2.73	0.19	4.92	49.26	38.97 a	20.40	16.43	0.08
	I <sub>2</sub>		0.08	1.23	2.73	0.17	6.06	42.10	37.96 b	17.67	14.61	0.07
			ns	ns	ns	ns	ns	ns	*	ns	ns	ns
Fertilizer type		G <sub>1</sub>	0.06 b	0.15 b	1.34	2.66	0.06	17.55 b	3.98	41.81 b	35.60 b	16.13
		G <sub>2</sub>	0.07 b	0.16 b	1.31	2.64	0.06	17.92 b	6.21	48.87 ab	36.13 b	15.15
		G <sub>3</sub>	0.05 b	0.19 ab	1.32	2.35	0.05	16.62 b	3.49	38.84 b	33.58 b	14.58
		G <sub>4</sub>	0.11 a	0.23 a	1.06	3.23	0.08	26.66 a	5.06	60.08 a	47.21 a	19.55
			*	*	ns	ns	ns	*	ns	*	*	*
Irrigation level	I <sub>1</sub>	G <sub>1</sub>	0.08	0.18	1.31	2.79	0.07	20.53	4.35	43.30	36.52	18.47
		G <sub>2</sub>	0.05	0.15	1.30	2.58	0.06	15.46	9.57	39.60	36.13	14.04
		G <sub>3</sub>	0.05	0.18	1.31	2.61	0.05	16.46	4.83	32.73	35.38	13.91
		G <sub>4</sub>	0.11	0.22	0.95	3.28	0.08	24.17	6.21	55.75	45.64	16.70
Fertilizer type	I <sub>2</sub>	G <sub>1</sub>	0.05	0.13	1.39	2.54	0.06	14.58	3.62	40.32	34.68	13.80
		G <sub>2</sub>	0.09	0.18	1.33	2.71	0.07	20.39	2.86	58.14	36.12	16.25
		G <sub>3</sub>	0.05	0.20	1.33	2.08	0.04	16.79	2.15	44.95	31.78	15.25
		G <sub>4</sub>	0.11	0.25	1.17	3.18	0.08	29.16	3.91	64.42	48.78	22.41
			ns	ns	ns	ns	ns	ns	ns	ns	ns	

Table 3. Macro and micro elements of soil after spring season

Variations	Irrigation treatment	Fertilizer treatment	Macro Elements					Micro Elements				
			N(%)	P(ppm)	K(ppm)	Ca(ppm)	Mg(ppm)	B(ppm)	Cu(ppm)	Fe(ppm)	Mn(ppm)	Zn(ppm)
Irrigation level	I <sub>1</sub>		0.13	5.05	56.68a	434.76	75.26	0.30a	0.20a	3.06a	5.87	0.68a
	I <sub>2</sub>		0.12	4.95	51.69b	416.06	75.17	0.29b	0.17b	2.89b	5.80	0.64b
			ns	ns	*	ns	ns	*	*	*	ns	*
Fertilizer type		G <sub>1</sub>	0.11b	5.14	55.35b	408.80bc	75.01	0.31	0.20	2.97b	5.82	0.66b
		G <sub>2</sub>	0.16a	5.18	58.26a	368.69c	75.33	0.30	0.21	3.03b	5.94	0.70b
		G <sub>3</sub>	0.12b	5.01	55.54b	422.28b	75.25	0.30	0.21	3.04a	5.98	0.68a
		G <sub>4</sub>	0.13b	4.66	47.59c	501.86a	75.27	0.27	0.20	2.89b	5.61	0.61ab
			*	ns	*	*	ns	ns	ns	ns	ns	*
Irrigation level	I <sub>1</sub>	G <sub>1</sub>	0.13	5.08	45.15	433.69	74.73	0.29	0.18	2.69	5.17	0.59
		G <sub>2</sub>	0.14	5.38	58.23	388.77	75.33	0.30	0.22	2.96	6.05	0.67
		G <sub>3</sub>	0.12	4.86	53.78	406.46	75.32	0.29	0.21	2.99	6.02	0.69
		G <sub>4</sub>	0.14	4.86	49.59	435.31	75.31	0.28	0.21	2.93	5.95	0.63
Fertilizer type	I <sub>2</sub>	G <sub>1</sub>	0.10	5.20	65.54	383.92	75.29	0.33	0.23	3.25	6.46	0.74
		G <sub>2</sub>	0.18	4.98	58.29	348.61	75.33	0.30	0.20	3.09	5.83	0.71
		G <sub>3</sub>	0.12	5.17	57.31	438.10	75.19	0.30	0.20	3.08	5.93	0.69
		G <sub>4</sub>	0.12	4.46	45.59	568.41	75.22	0.26	0.18	2.85	5.26	0.59
			ns	ns	ns	ns	ns	ns	ns	ns	ns	

### Conclusion

The fact that yield values obtained from the fully irrigated subject I<sub>1</sub> were considerably greater than those obtained from subject I<sub>2</sub>, which was subjected to maximum limitation, clearly exhibits the importance of irrigation for broccoli cultivation.

It was observed that fertilizer activity increased with irrigation practices, chemical fertilizer applications contributed to yield; also, vermicompost applications have been seen to contribute to soil in respect of soil and leaf nutrients. According to Bellitürk (2016),

vermicompost expression is a word which is used for the final product (humus-like material) of composting procedure of organic waste materials by soil worms.

Vermicompost increases flowering and soil organic matter compared to chemical fertilizer, although the growing of the plants in the chemical fertilizer applied plots is better; it was determined that plants in vermicompost applied were matured early and their heads were tighter. In the light of the results obtained from this study, it is thought that this fertilization, especially 200 kg da<sup>-1</sup> dose, may be "sufficient" to grow plants rich in quality, fertile and mineral nutrients.

To avoid low yield values in agricultural production and to contribute to the improvement of intensive farming soil, coexistence of chemicals and vermicomposts in fertilization programs will lead to more beneficial results.

### References

- Adilođlu A., Eryılmaz Açıkgöz F., Adilođlu S., Solmaz Y. (2015). Akuakültür Atığı Ve Solucan Gübresi Uygulamalarının Salata (*Lactuca Sativa* L. Var. *Crispa*) Bitkisinin Verim, Bazı Bitki Besin Elementi İçeriđi İle Bazı Agronomik Özellikleri Üzerine Etkisi /Effect of Aquaculture Worm and Worm Grapevine Application on Salmon (*Lactuca Sativa* L. var. *Crispa*) - Yield and Some Agronomic Characteristics of Some Plant Nutrient Elements/. Namık Kemal Üniversitesi Bilimsel Araştırma Projesi, Proje No: NKUBAP.00.24.Ar.15.11.
- Alpaslan, M., Güneş, A. and İnal, A. İnal, A. (1998). Deneme Tekniđi /Trial Technique/. Ankara Üniversitesi Ziraat Fakültesi, Yayın No:1501, Ders Kitabı No:455, Ankara.
- Bellitürk K., Görres J.H. (2012). Balancing Vermicomposting Benefits with Conservation of Soil and Ecosystems at Risk of Earthworm Invasions. VIII. International Soil Science Congress on Land Degradation and Challenges in Sustainable Soil Management, 302-306, Çeşme-İzmir.
- Bellitürk K. (2016). Sürdürülebilir Tarımsal Üretimde Katı Atık Yönetimi İçin Vermikompost Teknolojisi /Vermicompost Technology for Solid Waste Management in Sustainable Agricultural Production/. Çukurova Tarım Gıda Bil. Der. 31 (3): 1-5 (Özel Sayı), Adana.
- Bergmann, W. (1992). Nutritional Disorders of Plants, Development, Visual and Analytical Diagnosis. Gustav Fischer Verlag, Jena, pp: 86-333.
- Chamani E., Joyce D.C., Reihanytabar A. (2008). Vermicompost effects on the growth and flowering of *Petunia hybrida* 'Dream Neon Rose'. Am-Eurasia. Journal of Agriculture and Environment Science 3: 506-512
- Çetin Ö., Urgan D., Boyacı H. (2006). Damla Sulama Yönteminde Farklı Lateral Aralıkları ve İslatma Alanı Yüzdelerinin Domateste Verim ve Su Kullanımı Randımanına Etkisi / Different Lateral Ranges in Drip Irrigation Method and Effect of Soaking Area Percentage on Domestate Yield and Water Usage Efficiency/. Proje no: KHGM-03220E01. Eskişehir.
- Çıtak S., Sönmez S., Koçak F., Yaşın S. (2011). Vermikompost Ve Ahır Gübresi Uygulamalarının İspanak (*Spinacia Oleracea* Var. L) Bitkisinin Gelişimi Ve Toprak Verimliliđi Üzerine Etkileri /Effects of Vermicompost and Stable Guinea Application on the Development of Spinach (*Spinacia Oleracea* Var. L) Plant and Soil Productivity/. Batı Akdeniz Tarımsal Araştırma Enstitüsü Derim Dergisi, 28(1):56-69.
- Edwards C.A., Bohlen P.J. (1996). Biology and Ecology of Earthworms (3rd Ed.). Chapman & Hall, New York.



- Güneş, A., Alpaslan, M. ve İnal, A. (2010). Bitki Besleme ve Gübreleme (V. Baskı) / Plant Nutrition and Fertilization (V. Edition)/. Ank. Üniv. Ziraat Fakültesi Yayın No: 1581, Ders Kitabı No: 533, Ankara.
- İbrikci H., Gulut K.Y., Guzel N. and Buyuk G., (2004). Plant analysis techniques in fertilization. 3. National Fertilization Congress, 11-13 October 2004, p. 1187-1214
- Jahan F., Shahjalal A.T.M., Paul A., Mehraj H, Uddin Afmj (2014). Efficacy of Vermicompost Conventional Compost on Growth and Yield of Cauliflower. Bangladesh Research Publications Journal, 10 (1): 33-38.
- Jones J.B., Wolf JrB., Mills H.A. (1991). Plant analysis handbook. Micro-Macro Publishing, Inc. Georgia 30607, USA.
- Kacar B. (2009). Toprak Analizleri Kitabı (GeniŞletilmiŞ İkinci Baskı) /Soil Analysis Book (Extended Second Edition)/. Nobel Yayın No:1387, Fen Bilimleri No: 90, Nobel Bilim ve Araştırma Merkezi Yayın No: 44, Nobel Yayın Dağıtım, 467 s., Ankara.
- Lindsay W.L., Norwell W.A. (1978). Development of DTPA Soil Test Zinc, Iron, Manganese and Copper. Soil Sci. Soc. Am. J. 42: 421-428.
- Preetha D., Sushama P.K., Marykutty K.C. (2005). Vermicompost + inorganic fertilizers promote yield and nutrient uptake of amaranth (*Amaranthus tricolor* L.). Journal of Tropical Agriculture 43: 87-89.
- Sağlam, M.T., (2012). Toprak ve Suyun Kimyasal Analiz Yöntemleri /Soil and Water Chemical Analysis Methods/. NKÜ Ziraat Fakültesi Yayınları No: 2, Ders Kitabı No:2, s: 1-154, Tekirdağ.
- Sinha J., Biswas C.K., Ghosh A., Saha A. (2010). Efficacy of vermicompost against fertilizers on Cicer and Pisum and on population diversity of N<sub>2</sub> fixing bacteria. Journal of Environmental Biology 31: 287-292.
- Tovep (1991). Türkiye toprakları verimlilik envanteri /Turkey's productivity inventory/. T.C. Tarım Orman Ve Köy İşleri Bakanlığı Köy Hizmetleri Genel Müdürlüğü.
- Walker W.R., Skogerboe G.V. (1987). Surface Irrigation. Theory and Practice. Prentice- Hall, Englewood Cliffs, 375pp, New Jersey.
- Yurtsever N. (1984). Deneysel İstatistik Metotları /Experimental Statistical Methods/. Köy Hizmetleri Genel Müd. Yayınları No:56, Ankara.
- Zhang Y., Kendy E., Qiang Y., Changming L., Yanjun S., Hongyong S. (1999). Effect of soil water deficit on evapotranspiration, crop yield, and water use efficiency in the north China plain. Agric. Water Manage. 64: 107-122.

## **4. ENVIRONMENT PROTECTION AND NATURAL RESOURCES MANAGEMENT**

## GEOMORPHOLOGY AND WATER QUALITY OF THE COASTAL LAGOONS OF ALBANIA

Elvin ÇOMO\*, Albana HASIMI, Jakup HOXHAI, Bashkim LUSHAJ

Institute of Geosciences, Energy, Water and Environment, Polytechnic University of Tirana,

\*Corresponding author: elvincomol@gmail.com

### Abstract

Coastal lagoon ecosystems are typical habitats of the Mediterranean Region. The Albania coastline has a total length of about 380km, two third of which border the Adriatic Sea and one thirds the Ionian- Sea. This coastline is characterized by an extremely active sedimentary regime. The sediments discharged by the rivers Shkumbini, Semani and Vjosa have built up the coastal plain, where at present the two largest lagoons of Albania, Karavasta and Narta, are found. Karavasta lagoon (Ramsar site) is included on the most various mosaics of coastal habitats in Albania that extend between Shkumbini and Semani river, in the central part of the Albanian Adriatic coast. Karavasta Lagoon is included in Karavasta complex area with Godulla lagoon, and irrigation collectors of Myzeqe and Terbufi, Kulari area and Semani and Shkumbini River at both sides of the lagoon. The coastal zone of the Vlora Bay, including that of the Treport, is one of the most active one from the geomorphologic point of view, as well as related to the environmental issues. The coastal lagoons have attracted man's interests for their biological resources richness. Over the centuries, fishing and hunting, more recently nature conservation, have concentrated man's interests on these environments. Such activities have determined the interventions for maintenance of hydraulic circulation within the lagoon, the stabilization of the inlets (channel connecting sea- lagoon), the attempt to control and regulate freshwater input in quantity and quality.

**Keywords:** *lagoon, wetland, shelf, littoral, spaces, erosion*

### Introduction

Coastal lagoon ecosystems are typical habitats of the Mediterranean Region. The Albania coastline has a total length of about 380km, two third of which border the Adriatic Sea and one thirds the Ionian- Sea. (Lushaj, 1996 & 2006). Wetlands provide important services to human societies, such as water supply, sanitation, flood control and food resources. All over the world, management of water the key component of wetlands will be an issue of crucial importance in the 21<sup>st</sup> century, affecting the daily lives of millions of people. Furthermore, wetlands are cradles of biodiversity, providing the water and primary productivity upon which countless species of plants and animals depend for survival. Coastal lagoons located between land and seas are influenced by both the marine and terrestrial environments. Coastal lagoons are naturally enriched areas with very unstable environmental conditions due to their position from the open sea and to their shallowness. In this sense they are considered as naturally stressed environments. Furthermore, being close to land, they are vulnerable to human disturbance. Adriatic and Ionian coastal lagoons, constitute 16 complex area with 40 smaller wetlands as part of their stretch starting in the north, as Velipoja, Viluni, Kune-Merxhani, Vaini-Ceka, Patok, Rushkulli, Karavasta-Divjakë, Narta, Orikum and Butrinti. Space representing shelf deposits, the littoral, alluvial and other older places; mollas, terrigenous, flysch and carbonates. (Hoxhaj et al., 2010).

## Material and Methods

In the framework of the implementation of the project “Monitoring of the quality of surface waters”, the monitoring program of the waters quality of the lagoons system have been developed. According to this program, the sampling has been conducted in 4 fixed stations inside the lagoons during time interval 2010-2014 with a frequency of 4 times per year. Water samples are taken in surface respecting the sampling procedure for the shallow waters. Basic parameters analyzed are pH, transparency, temperature, Salinity, BOD, COD, NO<sub>3</sub>-N, NO<sub>2</sub>-N, NH<sub>4</sub>-N, P-PO<sub>4</sub> and P total. The basic parameters level has been analyzed using standard methods prescribed in ISO and EU standards and from the APHA methods for analyzing water and wastewater (APHA 20-th edition).

### The geographic extent of the Karavasta Lagoon

The Karavasta lagoon located along the Adriatic coast, between the Shkumbini river, in north, and the Semani river, in the south. Lagoon is largest of our country and the entire southern coast of the Adriatic with an area 4330 ha, length 10.6 km, width 4.3 km and a depth of up to 1.5 m. Separated from the sea through a broad belt of sand, covered by dense forest. Connected with the sea by three channels, one of which is open to fishing needs. The area is bordering the Adriatic Sea and the western hillside of Divjaka hills, and is composed mainly of Quaternary sandy and clay deposits. South of Shkumbini mouth parallel with sandy and sub sandy area Quaternary deposits occur, and round Karavasta lagoon, with find seamy deposits with clay, and sub clay, sub sand and peat of Quaternary age. Between the Divjaka hills, the Shkumbini river in the north and Semani river in the south, there are deposits of alluvial clay and sand. The area is poor in underground water. The Karavasta lagoon is connected to the sea via three channels: Northern - 700m long, 17m wide and 0.75m deep: Central - 1200m long, 26m wide and 1.55m deep: Southern - 500m long, 23m wide and 0.61m deep. Only the northern channel is connected directly with the sea, but to maintain this connection, regular dredging is necessary. The others communicate with the Godulla lagoon, west of Karavasta lagoon, with an area of 650 ha, 5 km length, 3,8 km width and a maximum depth of 1.7 m, connected to the sea by two other channels (fig. 1).

### The geographic extent of the Narta Lagoon

Narta Lagoon is one of the largest and the most important coastal wetlands of Albania. It is situated about 14 km in the northern part of Vlora town. The lagoon has a surface of 42 km<sup>2</sup>, where 13.8 km<sup>2</sup> of the northern part are used as saline (Skrofotina Salt Pan). This is formed from a coast bay, which is divided from the sea as result of soil accumulation from Vjosa River is transported in this bay (Lami.S 2004). The average depth is 1.26 m. It is connected with the Adriatic Sea by two artificial channels; the southern channel is 200 m long and 6.48 m wide; the northern channel is 800 m long and 11.60 m wide (Pano, 2009). At its north extend the bottom part of Vlora Myzeqeja, while in south and in its south western Narta lagoon border with picturesque hills of Zvërneci. There are two small picturesque islands in this side. There is the monastery of Zvërneci in the big island. The east coastline of Narta Lagoon represent from the western face of Vlora hills area, which are dressed with olive trees and vineyards. The hydro-morphologic processes in the lagoon are related with the adjacent



Figure 1. Geographical situation of the main lagoons of Albania

hydrographical network, with a contribution of solid alluvium materials from different small rivers, mainly during winter period, and the detritions from the Adriatic Sea wave refraction. Despite relatively big surface the lagoon is characterized by a short time of water circulation, firstly because of huge water inflow and outflow through water exchange between lagoon and sea, and secondly, because of its small depth (Selenica. A 2008). At the same time, water movements in lake can be affected by many factors, such as wind, air temperature, and pressure and bottom friction.

### **Lagoons morphology**

Geology, its dynamics, structure of hydric system and climate have conditioned the morphology of Narta Lagoon Vlorë bay and Vjosa river mouth. Narta Lagoon was formed in the sea bay, which is closed by solid sediments transported by Vjosa River to the sea. The neotectonic phenomena also characterize the lagoon area. At southwestern direction, the Tortonian molasses Zvërneci hills chain from the isle separated Narta Lagoon from Adriatic Sea. Geological section is extended from the beach to the northern direction and by erosion abrupt slope has been formed rising over the seaside. These characteristics make Zvërneci a rare geo-monument, with great international scientific and touristic interest. Around the Narta Lagoon the Quaternary deposits ( $Q_4^1$ ) are extended. These deposits are represented by sky-blue-gray color silt, with siltstone interbeds of gray color. Thickness of these deposits varies from 0.5-1 m up to 20-30m. Lagoon deposits have covered marine Quaternary deposits ( $Q_4^m$ ). Marine deposits are represented by arkoses sand, with green silty clay and gray siltstone interbeds. Quaternary deposits thickness is more than 100m. The dominant geomorphologic processes acting in the Karavasta lagoon area, consist in a notable discharge of solid alluviums from the Semani and Shkumbini rivers and wave transformation processes around the delta cusps and the bayed beach enclosed between them (Ciavola et al., 1999; Phare, 2002). This area is composed mainly of sandy and clay deposits of Quaternary age. South of the Shkumbini mouth, parallel with the shore sandy Quaternary deposits occur as beach ridges, while around the Karavasta lagoon, swampy deposits are found consisting of clay, silts, fine sand and peat (turf) of Quaternary age. Between Divjaka hills, Shkumbini River in the north and Semani River in the south there are deposits of alluvial Quaternary clay, silts and sand. The western sides of the Divjaka hills are formed by mudstones, sands and conglomerates of Pliocene age. The central part of Karavasta lagoon is characterized by a slimy layer that in the peripheral zone is bordered by peat, sand, sub-sand and sub-clay (Ciavola et al., 1995). Landscape changes in this lagoon take place as accumulation and deposition of sand mostly with dramatic coastal changes, creation of lagoons, moderates to strong erosion affecting low-lying shores and sand spits. To note that the magnitude of coastal changes is unusual for Mediterranean environments, normally altered by man because of development pressures. Due to the sedimentation of the alluvium of the Semani and Shkumbini rivers, the mouth of the deltas is constantly shifting on the coastal plain in an endless search for an equilibrium position. The sediments discharged by the rivers Shkumbini, Semani and Vjosa have built up the coastal plain where at present the two largest lagoons of Albania, Karavasta and Narta, are found (Ciavola et al., 2000). Data from (Pano. N 1992) for the period 1948-1990, indicate that the mean total sediment discharge of Albanian rivers was in the order of 65.7 million tons per year. It is quite likely that in recent years the sediment load decreased because of sand and gravel extraction and dam construction (Simeoni et al., 1997). Values of water and solid discharges of Shkumbini, Semani and Vjosa rivers are summarized in Table 1.

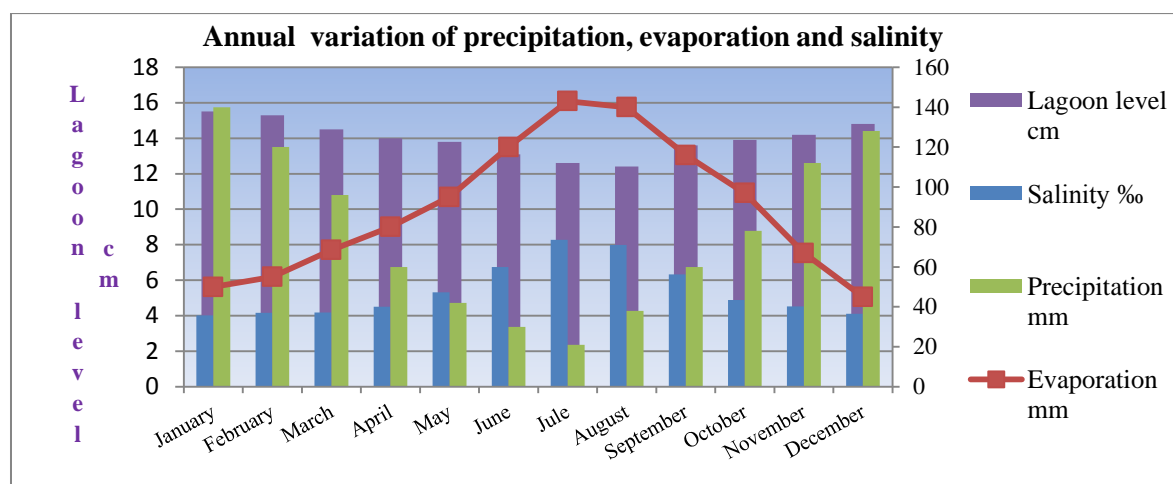
**Table 1:** Mean annual water discharges and sediment load of Shkumbini, Semani and Vjosa rivers.

River	Catchment (km <sup>2</sup> )	discharge (m <sup>3</sup> /s)	sediment discharge (tons/year)
Shkumbini	2444	61.5	7.20 x 10 <sup>6</sup>
Semani	5649	95.7	16.5 x 10 <sup>6</sup>
Vjose	6706	195	8.30 x 10 <sup>6</sup>

The coastal morphology of Karavasta lagoon has been highly dynamic for the last 135 years because of the changes which occurred to the two river deltas. The major events occurred when the Semani river changed its course moving northwards in the 1950s, then again southward in the late 1970s. Then the erosion of its abandoned delta progressively created a spit growing northward of the most recent mouth, which eventually closed in a few years to form the Godulla lagoon. At the moment, it seems that this Godulla barrier-island system is being eroded and will tend to disappear within years (Technical, 1995; MedWetCoast2005).

### Climate

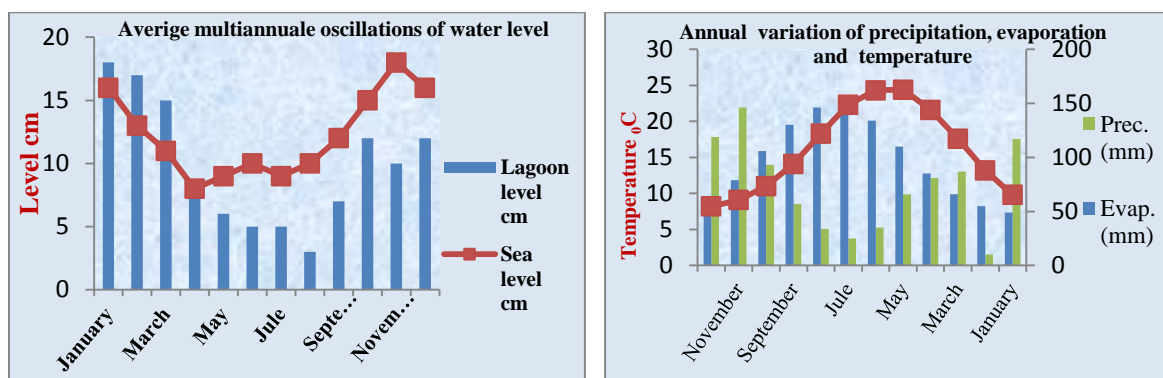
The area is situated in the coastal plateau, which according climate regionalization of Albania, belongs to the Central Mediterranean field climate. It is characterized by mild winters with abundant precipitation and hot-dry summers. Precipitations are mainly in the rain form, while the snow layer is of very short duration. Solar radiation, as one of the principal factor of climate, is very uniform over the area under the study. The annual solar radiation for the area is about 1540 kwh/m<sup>2</sup>. The highest value is observed in July and the smallest one in December



**Figure 3.** Relation between precipitation, evaporation and salinity of Narta Lagoon.

The annual average of air temperature varieties from 15.4 °C up to 16.3 °C. The maximal air temperature is reached in July/August with 30.0 °C and the minimal in January with 4.8 °C. The climate in coastal area of Karavasta Lagoon is typically Mediterranean, with average precipitations of 893 mm in Divjaka, 70 to 75 % of the rain occurring from October to March. Evaporation estimated from climatologically data of Vlora station (Hydro meteorological Institute, 2001) reach an annual value of about 1,200mm, evaporation calculated from data temperature in the Karavasta area (Technical, 1995, 2003) is of the same order. Although there is a hydro- climatic deficit, it is not as important as in other western Mediterranean areas. Nevertheless, during the summer month, with monthly evaporation values reaching 150 mm, and low precipitations the water deficit is severe for the Karavasta lagoon (fig.4). This implies that even with its original drainage basin, the lagoon has always faced strong

seasonality in its water and salinity regime, as it is generally the case for Mediterranean coastal lagoons. Another important climatic variable for lagoon hydrology is the wind, which allows mixing of waters and enhances or counteracts the tidal effect on water exchanges with the sea. (Lowry, J. 2006).



**Figure 4.** Monthly average temperature, rainfall and evaporation in the Karavasta.

Air humidity is regularly linked with air temperature. Monthly mean of the relative humidity in this zone variate from 62 to 69 %, while the annual mean is 66 %. Wind is mainly represented by sea breeze. The sea breeze phenomenon here is very evident especially during the summer. Winter is dominated by eastern winds with an average speed of 3.5 m/s. The mean velocity is respectively 4.4 m/s and 5.2 m/s. Due to its limited water depth, the thermal regime of lagoon waters is similar to the air temperature regime. The seawater that penetrates in lagoons has a great influence on its thermal regime, particularly near the communication channels. The lowest water temperatures in the lagoon are in December-January period and highest in July-August period. The average annual temperature is 14.9 °C.

## Results and Discussion

### Narta lagoon

The lagoon is hyper saline especially during summer with salinity up to 78.0‰. The eastern part of the lagoon which is less influenced by sea water, shows high oscillations of salinity (fig.3). The high value of the salinity of Narta Lagoon water can be explained by the highest evaporation of water in this lagoon. Lagoon waters are slightly alkaline (pH 8.4-8.8). The content of dissolved oxygen oscillates between 7-10 mg/l. The level of orthophosphate varies from 0.005 to 0.025 mg/l P (Çomo *et al.*, 2014). Nitrogen concentration as ammonium, nitrate or nitrite is linked closely with nitrogen cycle. The time distribution of this indicator in the lagoon water follows that of water circulation from the water exchange between sea and lagoon, accompanied with organic development during the summer period (Kane S *et al.*, 2015). The levels of nitrates in the water samples ranged from 0.1 mg/l to 0.66 mg/l. The analysis reveals that BOD<sub>5</sub> values variation with a range from 1 to 6 mg/l O<sub>2</sub>. Narta Lagoon water is saturated with oxygen; even there inflow domestic and some industrial wastewaters. This indicator varies from 7.17 to 10.07 mg/l. These indicates that the lagoon water have a rapid mix with fresh water coming from inland channels or from sea water exchange in communication channels.

### Karavasta Lagoon

Salinity analyzes, showing its values extending within range 49.59-56.46 ‰ (gr/kg). The highest value is observed 55.67‰ and the minimum value is observed, 55.03‰. The level of salinity in the lagoon depends heavily on the tidal flow regime. The total phosphorous

oscillation values lay within the range 0.05-0.074 mg/l. The highest value is 0.074 mg/l, due to discharges from the hydropower channel and the lowest value is 0.051 mg/l, due to the impact of the canals connecting the lagoon to the sea. The content of  $\text{N-NH}_4^+$  in the lagoon is different and lies in the range of 0.014-0.027 mg/l. The amount of nitrite fluctuates in 0.001-0.0025 mg/l. While nitrates fluctuate in the values: 0.12-0.18 mg/l. Oxygen content is relatively low. Its values range from 5.02-6.1 mg/l. The COD values fluctuate in the range 7.3-8.2  $\text{mgO}_2/\text{l}$ , while the values of  $\text{BOD}_5$  are in the range of 3.54-3.81  $\text{mgO}_2/\text{l}$ . Likewise; the displayed values of these parameters indicate the relatively high presence of organic matter and biological load due to industrial, agricultural and urban pressures.

### **Conclusions**

The communication between Narta Lagoon and the Sea, during the period under the study, has been weak which influences in increasing of the time interval of water lagoon full change. Hydrologic common feature for the lagoon is sea water supply during the period tides and discharge water during low tide. Narta Lagoon stands for a highly unstable limnological regime characterized by large variations in physical and chemical characteristics in time and space. This had a negative impact on utilization of the lagoon for fishing purposes. Communication of waters between the processes is weak due to the small size of the communication channels. This allows the amount of water that enters the lagoon long as the tide small compared to the water mass itself lagoon. High water channel that discharge into Narta Lagoon contain big amount of organic substance. Phosphor is a restriction factor of water eutrophication of Narta lagoon. Based on the trophic state index (TSI) (Carlson & Simpson, 1996), and phosphorus contents total transparency (Secchi disk), it was observed that the waters belong mesotrophic state for the Karavasta Lagoon and oligotrophic state for Narta Lagoon. In the Karavasta Lagoon as a water facility closed with insufficient communication with the sea, feels more human intervention. Karavasta Lagoon is under constant pressure from industrial, urban and agricultural pollution.

### **References**

- APHA (1998). "Standard methods for examination of water and wastewater" 20-th edition.
- Chauvelon P., 2004: Report of expertise on the hydrological functioning and hydraulic management of the Narta and Orikumi wetland systems, Albania Station Biologique de la Tour du Valat, Medwet Coast Project - Albania; Report 16p.
- Chauvelon P., 2004a: Hydrological functioning and hydraulic management of the Karavasta lagoon system, Albania. FAO, World Bank, Ministry of Environment of Albania, Report 27p.
- Ciavola, P., Mantovani, F., Simeoni, U. and Tessari, U., 1999. Relation between river dynamics and coastal changes in Albania: an assessment integrating satellite imagery with historical data. *Int. J. Remote Sensing*, 20, 3, 561-584.
- Çomo E., Adhami E., Sanxhaku M. 2014 "Physico-chemical features of coastal aquatic ecosystem of Narta lagoon, Albania". *The Journal of Natural and Technical Sciences(JNTS)*. ISSN 2074-0867.
- Hydrometeorological Institute, 2001. A study on the wetlands of the Vlora bay. Medwetcoast Albanian National Management project Office. Report, 36p.
- Hoxhaj J, Cara F, Kuliçi H, Abazi Sh, Multiple Indications in the Coastal Lagoon System of Albanide. International Conference on "Water resources and wetlands", 14-16 September, 2012, Romania.



- Hoxhaj J, Cara F, Kuliçi H. Depozitimet Kuaternare përgjatë Strukturës Gjeologjike të Albanideve. 2009 UPT, Albania
- Lami S., 2004. Defining of the strategies for a sustainable management concerning the trophic state in the Lagoon of Narta and Lagoon of Orikumi. Report, 12p.
- Lowry, J. 2006. Low-cost GIS software and data for wetland inventory, assessment and monitoring. Ramsar Technical Report No. 2. Ramsar Convention Secretariat, Gland, Switzerland. ISBN 2-940073-30-9.
- Lushaj, B. 1996: “Albanian lagoons in Albania”, presented during the training on: “Techniques for restoration of devastated forest (environment)”, at Technical International Cooperation (TIC), Tokyo; “Techniques for restoration of devastated environment” at Hiroshima Prefecture and Sapporo University, led and supported by Japan International Cooperation Agency (JICA), Japan. pp. 3-31.
- Lushaj, B. 2006: “Wetland Conservation and its future in Albania”, presented during the advanced training on: “Wetland Conservation for Southeast European Countries”, supported by Japan International Cooperation Agency (JICA), Tokyo and Hokkaido, Japan. pp. 5-31.
- MedWetCoast. GEF/UNDP-Conservation of Wetland and Coastal Ecosystem in Mediterranean Region. Management Plan, Vjosë-Narta Landscape Protected Area. 2005.
- Pano N., 2009. Pasuritë ujore të Shqipërisë.
- Pano N., 1992. Dinamica del litorale Albanese—sintese delle conoscenze. Atti del diciannovesimo convegno AIGI. pp 3- 18.
- Pano N., Shehu B., Kazazi M., Jegeni T., Selenica A., (1984). Vjosa River, Monograph of Hydrology of Albania, (In Albanian), Institute of Hydrometeorology, Academy of Sciences, Tirana.
- PHARE, 2002. PHARE Programme Albania. Strategy for Albanian Lagoon Management. Government of Albania, European Commission, Final Report, 155p.
- Selenica A. (2008): Water resources of Albania (2008): In: Department of Technologies of Energy, Department of Climate and Environment & Department of Water Economy, Institute of Geosciences, Energy, Water and Environment, pp. 1-11.
- Simeoni, U., Pano, N., Ciavola. P. 1997. The coastline of Albania: morphology, evolution and coastal management. Bulletin de l’Institut océanographique, Monaco, n° special 18 (1997).
- Kane S., et al Assessment of environmental situation of Narta and Orikumi Lagoon, Albania. Research Gate 2015.

## SOIL CHARACTERISTICS AND VEGETATION DIVERSITY IN RESPONSE TO HEAVY GRAZING ON MEDITERRANEAN PASTURES ALONG THE SHORES OF LAKE OUBEÏRA (ALGERIA)

Ali SLIMANI<sup>1\*</sup>, Kahina HOUD<sup>2</sup>, Amar MEBARKIA<sup>3</sup>

<sup>1</sup> Laboratory Animal Health, Plant Production, Environment and Food Security, Institute of Agronomic Sciences, Chadli Bendjeddid University El Tarf, Algeria Tel. +213 540290944

<sup>2</sup> Laboratory Agriculture And Ecosystem Functioning, Institute of Agricultural Sciences, Chadli Bendjeddid University El Tarf, Algeria Tel. +213 776669641 <sup>3</sup> Department of Agronomy University Ferhat Abbas Sétif Algeria Tel. +213 792284354

\*Corresponding author ali\_slimani\_dz@yahoo.fr

### Abstract

This work is to examine whether the soil moisture gradient creates in soil physicochemical characteristics and how variation in soil physicochemical characteristics influences species composition, and the response to herbaceous vegetation species composition, and vegetation to heavy grazing pressure on native rangeland in Northeast Algeria, is reducing the diversity of herbs and shrubs in the areas. Adverse effects of overgrazing may include the trampling and removal of plant structural material critical for persistence of the plant within the environment. Some species have disappeared; with others have survived or other adaptation. Differences in grazing pressure may modify the relation between richness and fertility. In whole of pasture, the soil moisture was the major factor effecting plant species and, it seems to be influenced by competition. Soil physicochemical characteristics have not varied considerably and this situation is partly due to lack of management and applications of nutrients. Our study, livestock population have negative effects on soil fertility in degraded land in the shoreline lake, because the habitat has deteriorate seriously due to heavy trampling and soil erosion, Compared with some results, our study showed similar changes in composition. Under high grazing pressure, the tender palatable genera such as *Trifolium subterraneum* and *Medicago arabica* L. diminished rapidly because of their sensitivity to herbivory, and later they were replaced by the unpalatable genera

**Keywords:** *shorelake, grassland, overgrazing, species composition, soil physicochemical*

### Introduction

The Wetlands of the Mediterranean basin are known for their multiple values for man and nature (Skinner and Zalewski, 1995), one of these values is food for grazing animals. In fact, most fresh water wetlands in Algeria have involved with the presence of grazing farm animals. Mediterranean rangelands have been shaped by high degree of natural disturbance (Archibold, 1995; Allen, 2001), and the early impact of humans which continue to the present, (Allen, 2003). These activities have created a mosaic of ecosystems such as woodlands, marquis, tree-shrub communities, low shrub-lands and grassland ( Naveh and Whittaker, 1979). Over a long period of time intensive grazing, fire and periodical ploughing in conjunction with variable precipitation and heterogeneity which is dominant feature of the Mediterranean vegetation (Naveh, 1982, Trabaud, 1982).

Heavy grazing pressure on native rangeland in Northeast Algeria is reducing the diversity of herbs and shrubs in the areas. Due to overgrazing, the vegetation species composition, richness and productivity has changed over past few decades (Gehu et al, 1993). Some

species have disappeared; where others have survived using of morphological or other adaptation forms (Hustings and Dukroon, 1994).

Moreover, low-lying areas around lake regions, in the National Park of El-kala (Northern east Algeria), are frequently convoked by man and animal. These areas with ground water table is high enough to enable the growth of herbaceous plants and crops during the growing season. Plant species composition and primary productivity of wet meadow are determined both by management practices such as plowing, fertilizers application, grazing by farm animals and abiotic factors like soil type and water system. Furthermore, trampling by farm animals create disturbed patches where species with high dispersal ability are able to be formed (Somers, et al, 2000).

For instance, plants growing in infertile environments adapt to low levels resources by lowering their growth rate and regulating their plasticity degree to resources disposal (Grime, 1979). In fact, a case study in Africa showed that plant community response to heavy grazing near stock pests was reduction of palatable grass species sensitive to heavy grazing and replacement with ones of lower palatability, thus lowering grazing pressure (Hendricks et al., 2005). In addition, some native populations of perennial grass in central semi-arid Argentina subjected to heavy grazing were typically shorter and more prostrate than ungrazed or lightly defoliated population of the same species (Tomas et al., 2000). In Mongolian steppe, *Artemisia frigida* responds to heavy grazing by increasing branch number and reducing foliage biomass (Li et al., 2005).

The research has not yet revealed how resistance to heavy grazing pressure progresses in vegetation. Grazing is understood as a biotic form of disturbance. Differences in grazing pressure may modify the relation between richness and fertility. Some spatial changes of grassland vegetation (herbaceous communities) around the lake area provided an opportunity for us to study the response of vegetation to grazing turbulence. Our study was conducted in a pasture next to the shore of Oubeira lake which is a part of El-Kala's National Park. Consequently, objectives of our studies were: (1) first, to investigate whether the soil moisture gradient creates in soil physicochemical characteristics and how variation in soil physicochemical characteristics influences species composition, then and (2) to observe the response of herbaceous vegetation and species composition to heavy grazing.

## Materials and methods

### Study area

The studied area is a pasture, situated 5km Southeast of El-Kala and 54 km East of Annaba (Algeria) at 25 km altitude. It is a part of the National Park of El Kala (PNEK), located at the extreme East of Algeria (36°, 49' 01" N; and 8° 24'47"E). The Oubeira Lake is endorheic mésoeutrophe with water and 25 meters above sea level.. This lake undergoes the most intense human pressure throughout the year. Primary productivity and species composition are both influenced by abiotic factors, such as extent and duration of flooding, substrate type. The site is characterized by a moderate salinity ( $\approx 1\%$ ), the soil is alluvial and originates from the surrounding hills where the parental rock is mainly with limestone and sand, its maximum water (sweet) level at 157 m asl, which is reached in late winter. Draining waters also contribute to the creation of gradients in various soil physicochemical characteristics by depositing fine soil particles closer to the lake (Thornton and Dise 1998). The climate is continental Mediterranean with an average of 750 mm (over 30 years) annual rainfall and heavy internal fluctuations (standard deviation 80, 41) 81% of falls between November and March period.

The area shores is mainly covered by, *Agrostis stolonifera*, *Cynodon dactylon*, competing with the *Juncus articulatus* L., and *Juncus maritimus lam.* The floating mats are made by hydrophytes, *Chestnut Trapa natans water*, *Myriophylle* and *Potamots potamgeton sp*, these formation occupy the large open water area essential nesting waterbirds in this Lake.

Considering the relationship between grazing pressure and the distance from the shoreline. The field investigation was carried out in two summer seasons 2011 and 2015 at the end of May, June, July and August, which corresponding to no grazing periods.

This Shore Lake have been experienced a long history of human use and impact, including traditional gazing by cheep, sheep and plowing activities. The grazing activities occur primarily from March to June, and from September to November (stocking density: 50 sheeps ha<sup>-1</sup> and 60 sheeps ha<sup>-1</sup>). Although the number of plant species, or density in the whole pasture is relatively low. Due to policy change in the mid-2008s, lands that were once owned by the state were contracted out to the riparian for 30 years. The change in land-use policy dramatically increased animal productivity, but caused severe degradation of rangeland areas. For instance, from 2011 to 2015 the amount of livestock increased from 13 546 to 35 241 sheeps (local specie a 40 kg weight standard sheep unit) (table I). All data comes from the Directory of Agriculture Service. + (surplus) means the total numbers of livestock are below the grazing capacity, and – (deficiency) implies the contrary.

At the same time, grazing capacity for livestock on the rangelands had changed from self-sufficiency to serious deficiency. As the livestock increases, the rangeland is serious decline under the huge stresses of overgrazing.

Table 1. Changes of livestock population in the winter spring and autumn pasture of the shore Oubeira Lake

Year	Item	Livestock population	Grazing days	Grazing pressure	sheep unit
2011	Total numbers	13253	134	Moderate grazing	
	Movement of livestock	+ 1841 (+13, 9%)			
	Balance (+ surplus - deficiency)	16094			
2013	Total numbers	29357		Overgrazing	
2015	Total numbers	35241	110	Serious overgrazing	
	Balance (reference)	- 29147 (-181, 4%)			

### Methods

In April 2015, 31 (1x1m) quadrates were laid out in the shore lake; the stations were installed at distances of about 50, 100, 150 and 200 m from the shoreline of the lake. Because of unequal surfaces sizes of this zones shore lake. Distances of quadrates were measured from the shoreline lake ( Fig.1). From the center of each quadrate, soil cores were taken to a depth of 10 cm at each of the 31 stations soil, then was analyzed for pH, organic matter total, total N, P, K, Mn and total CaCO<sub>3</sub>, coarse and fine sand fractions, silt and clay. The soil pH aqueous (NF ISO 10693) measured in 0,01 M CaCl<sub>2</sub> (1:1 w/v). Organic matter was evaluated from dry soil weight difference before and after oven drying at 450°C for 4h and using

limestone correction. The total “N” was determined by Kjeldahl method, 2300 Kjeltac Analyzer, Foss Testator Höganäs, and Sweden. The total “P” was determined by Jeret-Hébert method, exchangeable K and Mn extracted with 0.5 M ammonium acetate and total Calcium determined by NF ISO 10693 in Arras soil laboratory (INRA France).

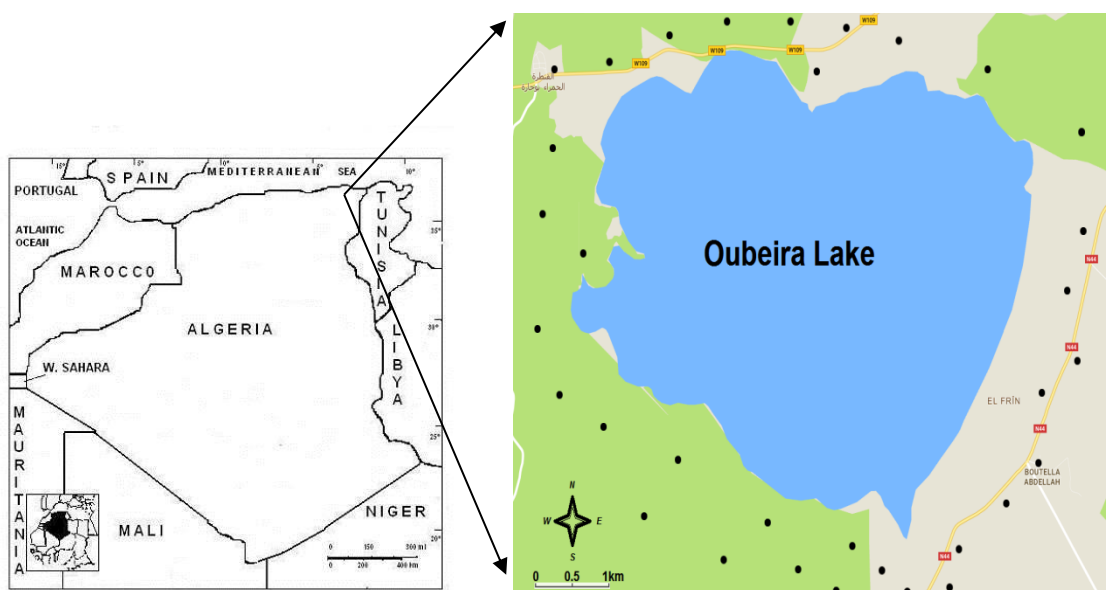


Fig. 1. Above: location of study area showing one of the three lakes in the National Park of El-Kala in the northeast part of Algeria. Below: location of study area with sketch of the layout showing the distribution of 31 stations in the shore Oubeira Lake (black dot).

Species richness and aboveground plant biomass, harvested at end of June, was measured in each quadrat. All stems and leaves above the root collar and measuring their fresh weight, respectively, than taking a part of them to the laboratory and dried at 75°C for 24 h. Dry matter biomass (DM/m<sup>2</sup>) was calculated after oven-drying. The measures of species composition estimated depends on the used presence scale (Dupré and Diekmann, 2001). Presence/absence of each species.

Also multivariate analyses were performed; every vegetation component (aboveground biomass, number of species / 1m<sup>2</sup>) or relative abundance of species of every functional group of species (annual and perennial grasses and legumes, forbs and sedges) was used as the dependent variable and independent variables were the distance of quadrates from the shoreline and all the measured soil physicochemical parameters.

## Results and discussion

Soil texture % of sand, silt and clay was similar in zones (I –II) (table II). Zones III and IV are quite different consisting almost exclusively of sand. The groundwater level became progressively deeper, in shore Lake as expected during the growing season, from zone 1 to zone 4. Table II, shows that soil texture (% of sand, silt and clay) was similar in East and South sides. Side Ouest is quite different consisting more Clay. As expected level of water became progressively higher through the growing period and from South side to North side (Fig II). It is obvious that the characteristics of the soil vary along to the gradient of moisture.

Soils characteristics varied along the moisture gradient the distance from the shoreline affected the measured soil characteristics. The pH values was not related to distance (Fig.II),

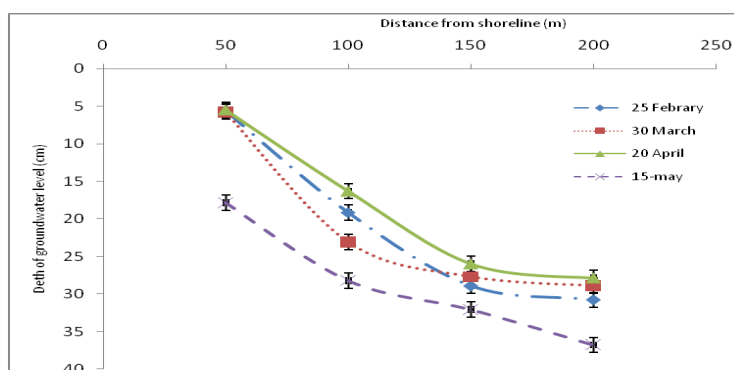


Fig.II. Depths to groundwater in relation to distance from the shore lake during the growing season (February, March, April, May (means  $\pm$  S.E,  $n=3$ ))

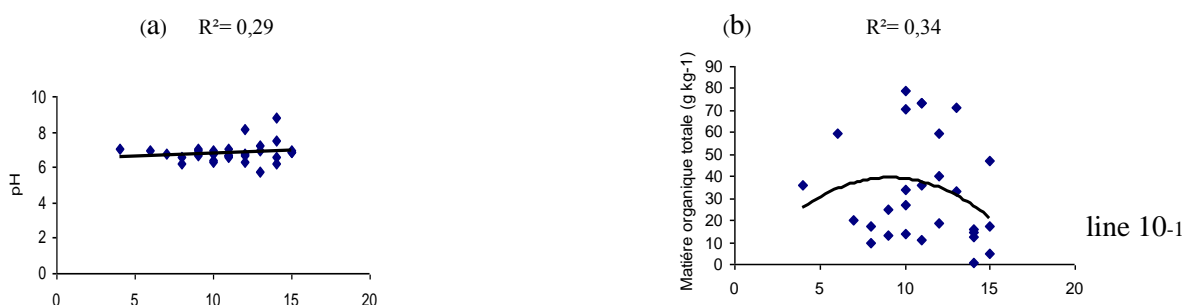
The distance from the shoreline affected the other measured such as, total organic matter, total N, extractable P and extractable K (Fig.III.(a) (b) (c) (d) and (e)). Since Organic matter K and P extractable had the lowest values in the first wettest zone. The best curve in relation to distance from the shoreline were the curvilinear, the total N was related to distance the amount of N tended to increased from the wettest zone to the dried zone it was positively related to distance ( $P < 0.05$ ). Hence, the upper slope zone was richer in sand and phosphorus that the zone. The latter, however had more clay, organic matter, nitrogen total and water retention capacity than the zones 3 and 4.

Table II. Soil texture ( means  $\pm$  1S.E) in the four pasture sides

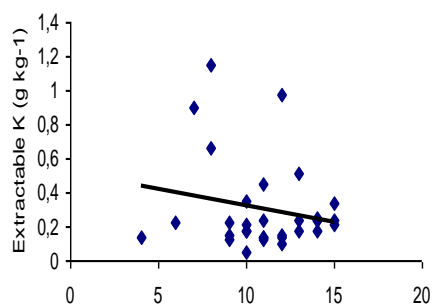
Sides	zone	samples	sand (%)	Silt (%)	Clay(%)
East (1)	zone 1	6	61, 7 $\pm$ 5,6	20,1 $\pm$ 4.8	8,2 $\pm$ 3.1
Ouest (2)	zone 2	5	61, 3 $\pm$ 5,4	22,4 $\pm$ 5.7	16,3 $\pm$ 2.4
South (3 )	zone 3	10	93, 9 $\pm$ 8.5	4.7 $\pm$ 1,5	3.4 $\pm$ 0.6
North (4)	zone 4	10	89, 1 $\pm$ 7,3	5,7 $\pm$ 1.1	6,2 $\pm$ 1.5

Table III, shows that the palatable species diminished while unpalatable species increased from (I) East to North (IV) *Festuca arundinacea*, *Paspalum sp.* and *Medicago arabica L.* disappeared in (III) and (IV), and *Trifolium subterraneum* disappeared in (IV). The unpalatable species *Conipodium glaucum* started accuring in (II), and indelible species *Asphodelus cerasiferus* in (IV).palatable species *Agrostis stolonifera*, *Cynodon dactylon*, and unpalatable species *Juncus articulatus L* remained unchanged through four sites.

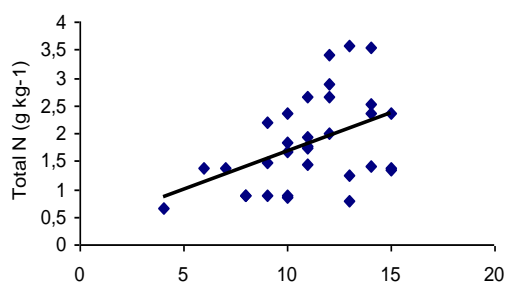
The statistical analysis indicated that the number of species/1m<sup>2</sup> as well as almost every functional group of species seems to be ordered along the distance from the shoreline. The first group of the abundance species that has formed was present in the four zones and all distances from shoreline: *Agrostis stolonifera*, *Cynodon dactylon*, *Juncus articulatus L*, the second group of three species is recorded in the first two wetter zones, and the abundance species of *Juncaceae* and *Sedges* were highest at intermediate distances from the shoreline, while *Asphodelus* decline with distance, and abundant at 200 m and more.



(c)  $R^2 = 0.43$



(d)  $R^2 = 0.55$



(e)  $R^2 = 0,51$

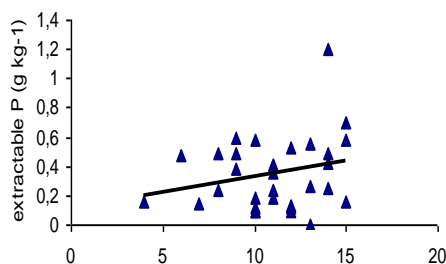


Fig 4. Relationships of five physicochemical soil characteristics ((a) pH, (b) organic matter, (c) extractable P, (d) extractable K, and (e) total N ) with the distance from the Lake 'shoreline. Lines or curves are the best fitted to data \* $P < 0.05$  ;\*\* $P < 0.01$ .

Table III. shows that the palatable species diminished while three unpalatable species increased from zone 1 to IV. *Trifolium subterraneum* and *Medicago Arabica* disappeared in II, III and IV, and *Festuca arundinuin* and *Paspalum sp.* Disappeared in IV. The unpalatable species *Juncus articulatus L.*, and *Juncus maritimus lam.*, started to appear in II, while *Conipodium glaucum* begins to occurring from III, and indelible species *Asphodelus cerasiferus* in IV. The palatable *Agrostis stolonifera* and unpalatable *Juncus articulatus L.* Species remained unchanged from I to IV sites.

The cover of palatable species mainly *Agrostis stolonifera* declined as the distance increased from the shoreline lake *Agrostis stolonifera* accounted for 78,6% of the total biomass in I. the proportion of others palatable species decrease from I to IV .

Total aboveground biomass ranged from  $180 \text{ g m}^{-2}$  and  $48 \text{ g m}^{-2}$  (Fig.IV.) and it related to the distance from the shore line, but not related to any variable physicochemical parameters measured.

The main differences in the soil parameters are linked to a topographic gradient in which the low slope zone 1 and 2 have higher proportion of clay , organic matter total nitrogen and water available Although the main factor explaining changes in the floristic composition of the studied communities was the greater water and nutrient availability in the Mediterranean environments. Grazing pressure is difficult to evaluate. Still, indirect methods have been developed from which scales are valid for comparisons (Helle and Aspi 1983). The main factor explaining changes in floristic composition was the presence of grazing farm animals (Papanastasis, 1992).

Table III. Species composition and biomass in fourth zones

Forage selection	species	East zone (I)	West zone(II)	South zone(III)	North zone(IV)	
		50m	100m	150m	200m	
Palatable	<i>Agrostis stolonifera</i>	1	1	0		
	<i>Cynodon dactylon</i>	1	1	1	0	
	<i>Trifolium subterraneum</i>	1	0	0	0	
	<i>Festuca arundinacea</i>	1		1	0	
	<i>Paspalum sp.</i>	1		1	0	0
	<i>Medicago arabica L.</i>	1		0	0	0
Unpalatable	<i>Juncus articulatus L.</i>	1		1	1	
	<i>Juncus maritimus lam.</i>		0	1	1	1
	<i>Conipodium glaucum</i>		0	0	1	1
Indelible	<i>Asphodelus cerasiferus</i>	0		0	0	1
Total species number		7	6	5	5	

A total of species were classified in relation to grazing in the fourth zones (table III). Only one species appeared simultaneously in zone I to IV. *Agrostis stolonifera*, which always appeared in the palatable group with higher level, and *Cynodon dactylon*, *Trifolium subterraneum*, *Festuca arundinacea*, *Paspalum sp.*, and *Medicago arabica L.* are present at the shoreline zone 1 and decrease in II, III and IV is thus a grazing decreaser in II to IV but indifferent in shoreline zone We found significant differences in soil parameters for grazing and zone (table IV. ). Grazing produces an increase in the percentage of sand in all zones and an increase in the percentage of silt and clay in II and III zones only. There was no significant effect in total nitrogen levels, but not in the organic matter/ finally grazing had a significant effect in the fourth zones. Even in available water. The topography of the shoreline allows the circulation of waters without obstacles of the slopes. The floristic composition tends to change with the water level and it will be greater in moister zones, (P<0.001), which does corroborate the hypothesis of Milchunas et al., (1988).

Table IV. Two way-ANOVA for soil parameters

Parameters		Zone		Grazing		Zone x Grazing	
		F	P	F	P	F	P
Clay	46.12	***	7.54	***	18.54	**	
Sand	98.11	***	21.42	***	24.71	**	
Total nitrogen	21.56	**	8.41	n.s	2.12	n.s	
Organic matter	54.11	***	5.32	n.s	1.17	n.s	
Available water	89.50	***	49.23	***	21.12	**	

n.s: non significant \*\* P<0.01 \*\*\* P<0.001

In whole of pasture, soil physicochemical characteristics have not varied considerably and this situation is partly due to lack of management and applications of nutrients Organic matter and



total Nitrogen  $P < 0.001$ . Unlike results in Spain (Peco et al., 2006), our study, livestock population have negative effects on soil fertility in degraded land in the shoreline lake, because the habitat has deteriorate seriously due to heavy trampling and soil erosion, and it is difficult for plants to resettle on the bare soil, the few tender palatable species have disappeared and unpalatable species have successfully invaded, which is in agreement with the results of Al Mufti et al., (1977). However, water availability has an important contribution to this variation. The significant relationship between the ground depth of water and the distance from the shore indicated that approaching the lake the water availability increases  $P < 0.001$ . This situation does not coincide with increased accumulation of total of nitrogen as well as of phosphorus. Again, during the wet period (winter and spring) zones I and II are exposed to waves on lakeshore which are loaded that has high amount of sand and low percentage of organic matter, nitrogen and phosphorus (Spence 1982). Vegetation did not cover all the ground, bare soil covers 35%. In this study, the four zones (I, II, III and IV) can be generally regarded as typical representative of four degrees of grazing pressure increasing from I to IV. Similar work in others countries has been conducted and attributed to the change in over grazing. Although productivity of the pasture was the lowest at the different distances from the lake. There is relation to any of the various physicochemical characteristics and not correlated with soil moisture gradient as was found by Grace and Wezel (1981); keddy (1989); and Gaudet and Keddy (1989), and Gaudet and Keddy (1995), Tziialla et al., (2006), and Zhao et al., (2007). The values of biomass  $180 \text{ g m}^{-2}$  and  $48 \text{ g m}^{-2}$  are very low (Fig 4) compared to those reported by Puerto et al., (1990) and ; Peco et al., (2006) in Spain and Greece having a similar climate. Heterogeneously distributed grazing pressure was an important factor in generating differences in patch structure (Augustine, 2003). In our study, continuous overgrazing in restricted not only reduced species composition and productivity ( $R^2 = 0,88$ ) but also change the structure of species by shortening tender stem sections and diminishing of the leaves (leaf and flower).

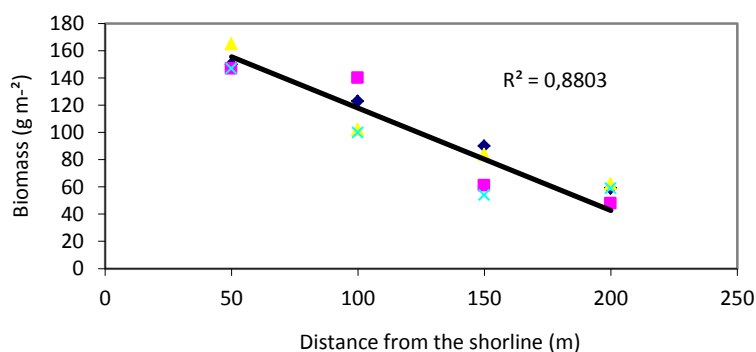


Fig. 4. Relationship of aboveground biomass ( $\text{gm}^{-2}$ ) per  $1\text{m}^2$  and relative with distances from the lake's shoreline. Line are the best fitted to data. \*\*\* $P < 0,001$ .

A previous study of 4 years' grazing trial in *Agrostis* and *Cynodon* communality revealed a declining trend of palatable species with increasing grazing pressures. *Trifolium subterraneum* and *Medicago arabica* L. and declined first and *Festuca arundinacea* later, while *Paspalum* sp. ( Li and Jiang, 1997; Peco et al., 2006 ), the dominant species did not changes. Compared with some results, our study showed similar changes in composition. From this it can be deduced that under high grazing pressure, the tender palatable genera such as *Trifolium subterraneum* and *Medicago arabica* L. diminished rapidly because of their sensitivity to herbivory, and later they were replaced by the inpalatable genera such as *Juncus articulatus* L and *Juncus maritimus* lam. This case demonstrated a fluctuation of palatable species clearly responding to the grazing pressure in the shoreline. There is difference in biomass between

the zone I and zone II and III, the productivity of the pasture was highest at zone I and lowest at the zone VI, this relatively productivity for Mediterranean pastures seems to be result of adequate soil moisture during the growing period, and probably to high fertility of alluvial soil. Characteristics of the plant community were not influenced by soil heterogeneity. The soil moisture was the major factor effecting plant species. Although the vegetation zonation seems to be influenced by competition. Here, grazing by large herbivores seems to also effect the vegetation of the shoreline.

### **Conclusion**

A previous study of 4 years in the whole of the overgrazing pasture, have showed que the physicochemical characteristics of the soil did not vary considerably; and the soil texture is of the sandy-loam-clay type, with low fertility except the nitrogen. However, The statistical analysis indicated has showed the functional group of species seems to be ordered along the distance from the shoreline. The group of the palatable species diminished while unpalatable species is increasing indifferently of the richness of the soil. The species productivity is well below average compared to other Mediterranean area

### **References**

- Al Mufti, M.M., Sydes, C.L., Furness, S.B., Grime, J.P., Band, S.R., 1977. Quantitative analysis of shoot phenology and dominance in herbaceous vegetation. *Journal of Ecology* 65,759-791.
- Allen, J.A., Ewel, K.C., Jack, J., 2001. Patterns of natural and anthropogenic disturbance of the mangroves on the Pacific Island of Kosrae Wetlands *Ecology and Management*. 9: 2916-301.
- Allen, J.A., Krauss K.W., Hauff R.D., 2003. Factors limiting the intertidal distribution of the mangrove species *Xylocarpus granatum*. *Oecologia*. Mar; 135(1):110-121.
- Archibold, O.W., 1995. Mediterranean ecosystems. *Ecology of word vegetation* 131-164.
- Augustine, D.J., 2003. Spatial heterogeneity in the herbaceous layer of a semi-arid savanna ecosystem. *Plant Ecology* 167,319-332.
- Dupré, C., Diekmann, M., 2001. Differences in species richness and life-history traits between grazed and abandoned grasslands in southern Sweden. *Ecography* 24, 275-286.
- Gaudet C.L., Keddy, P.A., 1989. Predicting competition ability from plant traits. *Nature* 334:242-243.
- Gaudet, C.L., Keddy, P.A., 1995. Comparative performance and species distribution in sholine plant communities: a comparative approach. *Ecology* 76, 280-291.
- Grace, J.B., Wezel, R., 1981. Habitat partitioning and comparative displacement in cattails (*Typha*): experimental field studies. *American Naturalist* 113,463-360.
- Grime, J.P., 1979. *Plant strategies and vegetation process*. Wiley, Chichester.
- Gehu, J.M., Kaabache, M., Gharzouli, R., 1993. Phytosociology and typology of lakeshores in the El-kala region (Algeria). *Colloques phytosociologiques XXII Syntaxonomie typologique des habitats Bailleul (France)* 298-309 p.
- Helle, T., Aspi, J. 1983. Effects of winter grazing by reindeer on vegetation. *Oikos* 40; 337-343.
- Hendricks, H.H., Bond, W.J., Midgley, J.J., Novellie, N.P., 2005. Plant species richness and compositiona long livestock grazing intensity gradients in a Namaqualand (South Africa) protected area. *Plant Ecology* 176,19-33.
- Hustings, M.J., Dukroon, H., 1994. Foraging in plants: role of morphological plasticity in resource acquisition. *Advances Ecology Research* 25, 117-127.
- Keddy, P.A., 1989. Effects of competition from shrubs on herbaceous wetland plants: a 4-year field experiment. *Canadian Journal of Botany* 67,708-716.

- Li, J H., Li, Z.Q., Ren, J.Z., 2005. Effect of grazing intensity on clonal morphological plasticity and biomass allocation patterns of *Artemisia frigid* and *potentilla acaulis* in the [1] Inner Mongolia steppe. *New Zealand Journal of Agricultural Research* 48, 57-61.
- Milchunas, Sala D.G., Lauenroth, W.K., 1988. A generalized model of the effects of grazing on vegetation and soils by large herbivores on grassland community structure, *Am. Nat.* 132, 87-106.
- Naveh, Z., Whittaker, R.H., 1979. Structural and floristic diversity of shrublands and woodlands in northern Israel and other Mediterranean areas. *Vegetatio* 41,171-190.
- Naveh , Z., 1982. Mediterranean landscape evolution and degradation as multivariate bio-functions: theoretical and practical implications. *Landscape Plann.*, 9: 125–146.
- Peco, B., Sanchez, A, M., Azcárate ;F., M., 2006. Abandonment in grazing systems : Consequences for vegetation and soil. *Agriculture, Ecosystems and Environments.* 113. 248-294.
- Puerto, A. Rico, M., Matias, MD, Garcia, J.A., 1990. Variation in structure and diversity in Mediterranean grassland related to trophic status and grazing intensity, *Journal of Vegetation Sciences* 1, 445-452.
- Somers, A. B., Bridle, K. A., Herman, D.W., Nelson, A B., 2000. The restoration and Management of small Wetlands OF THE Mountains and Piedmonts in the Southeast, A Manual Emphasizing Endangered and Threatened Species Habitat with a Focus on Bog Tuurtles. USDA Natural Resources Conservation Service. Watershed Science and Wetland Science Institutes.
- Spence, D.H.N., 1982. The zonation of plants in freshwater lakes. *Advances in Ecological research* 12, 37-125.
- Skinner, J., Zalewski, S., 1995. Functions and values of Mediterranean wetland, *Station Biologique de la Tour de Valat. Arles. A Med-Wet Publication, France*
- Tomas, M.A., Carrera, A.D., Proverene, M., 2000. Is there any genetic differentiation among populations of *Piptochaetium napostaense* (Speg.) Hack (Poaceae) with different grazing histories? *Plant Ecology* 147, 227-235.
- Tzialla, C.E., Veresoglou, D.S., Papakosta, D., Mamolos, A.P., 2006. Changes in soil characteristics and plant species composition along moisture in a Mediterranean pasture. *Journal of Environmental Management* 80, 90-98.
- Zhao, W. T., Li, J.L, Qi, J.G., 2007. Changes in vegetation diversity and structure in response to heavy grazing pressure in the northern Tianshan Mountains, China. *Journal of Arid environments* 68, 465-467.
- Papanastasis, V.P., 1992. Wetlads and livestock. In: Gerakis ; P.A., (Ed), *Conservation and Management of Greek Wetland: Proceeding of a Greek Wetland Workshop held in Thessaloniki, Greece.* IUCN, Gland, Switzerland, pp.1420-1424.
- Thornton, G.J.P., Dise, N.B., 1998. The influence of catchment characteristics, agricultural activities and atmospheric deposition on the chemistry of small streams in the English Lake District. *Science of the total environment* 216, 63-75.
- Trabaud. L., Conrad, C. E., Oechel, W.C., 1982. Effects of past and present fire on the vegetation of the French Mediterranean region. *Symposium on Dynamics and Management of Mediterranean-type Ecosystems, June 22-26, 1982, San Diego, California* 450-457.

## **CHARACTERIZATION OF THE PHYSICO-CHEMICAL AND BACTERIOLOGICAL QUALITY OF DAIRY CATTLE WATERING IN EL TARF, ALGERIA**

Samira KADRI<sup>1\*</sup>, Kahina HOUD<sup>2</sup>, Ali SLIMANI<sup>3</sup>, Abdesatar LAADJAL<sup>4</sup>, Hicheme NASRI<sup>1</sup>

<sup>1</sup>Research Laboratory: Biodiversity and Pollution of Ecosystems, The University of El Tarf, Algeria.

<sup>2</sup>Agriculture and Ecosystems Functioning Laboratory, The University of El Tarf, Algeria.

<sup>3</sup>Animal Health Laboratory, Plant Production, Environment and Food Safety, The University of El Tarf, Algeria

<sup>4</sup>Epidemiological Surveillance Laboratory, Health, Productions and Reproduction, Domestic and Wild Animals Experimentation and Cell Therapy. University of El Tarf. Algeria.

\*Corresponding author :samira\_kadri@yahoofr

### **Abstract**

The objective of this study is to evaluate the physico-chemical and bacteriological quality of water from some watering sources of dairy cattle in the wetlands of El Tarf. Our study was carried out on water samples from different dairy cattle farms. Water samples were analyzed during the period from January to June of 2016. The study implies physico-chemical and bacteriological analyzes of various parameters related to the control of water quality in dairy farms. The results obtained have shown that the water has a satisfactory quality in terms of pH, temperature, salinity and can be considered as eligible and does not pose any threat for ruminant's consumption. However, nitrite concentrations exceed the drinking water standards recommended for dairy cattle. The bacteriological quality of the waters is poor and reveals groundwater table contamination by nearby pollutions (agricultural land, cattle breeding, existence of septic tanks), which presents a real threat to dairy cattle.

**Key words:** *Water, quality, physico-chemical, bacteriological, dairy cattle*

### **Introduction**

Water quality has been a topic for many years, covering many aspects, such as the environment, human health and breeding. Water is one of the essentials of biological life, not only it is a vital nutrient, but also it participates in many basic physiological functions such as digestion, absorption, thermoregulation, waste disposal and Others (Olkowski, 2009). Its availability and quality are key parameters in the health and livestock production (Houd and Slimani, 2014). Multiple qualitative parameters, such as pH, salinity, odor, etc, can have an impact on the taste of the water. A decline in livestock food consumption due to poor water quality can have a negative impact on the performance (Weeth, 2001). All surface or ground raw water, holds microorganisms. The main health risk of drinking water is probably the microbiological contamination, but the total count, which represents an estimate of the total number of bacteria contained in water, is not sufficient to assess the threat, all depends on The nature of germs (Chevet, 2000). The objective of our contribution is to define the quality via the physico-chemical and bacteriological composition of the main sources used for dairy cattle watering in the town of Boutheldja and El Tarf in order to assess opportunities and risks associated with the use of such sources.

## Materials and methods

The study was conducted in a dairy pool in the area of El Tarf, which is located to the north-east of Algeria (8 ° 11 'longitude and 36 ° 47' latitude). Climatically speaking, the region is located in the bioclimatic stage in sub-humid to warm-dampclimatic zone, with mild winters and dry summers. Climatic surveys over the last 10 years indicate an average annual rainfall of 800 to 1200 mm, characterized by a great intra-annual irregularity. Monthly precipitation varies between a maximum in December and January (134.34mm and 136.42 mm respectively) and a minimum in July and August (3.97mm and 13.34mm). The average annual temperature is 19.24 ° C with a maximum in August (27.35 °C) and a minimum in January (12.96 °C) (Mibirouk-Boudechiche *et al.*, 2011).

Fig.n°01: Cadre géographique du bassin versant de la Mafragh

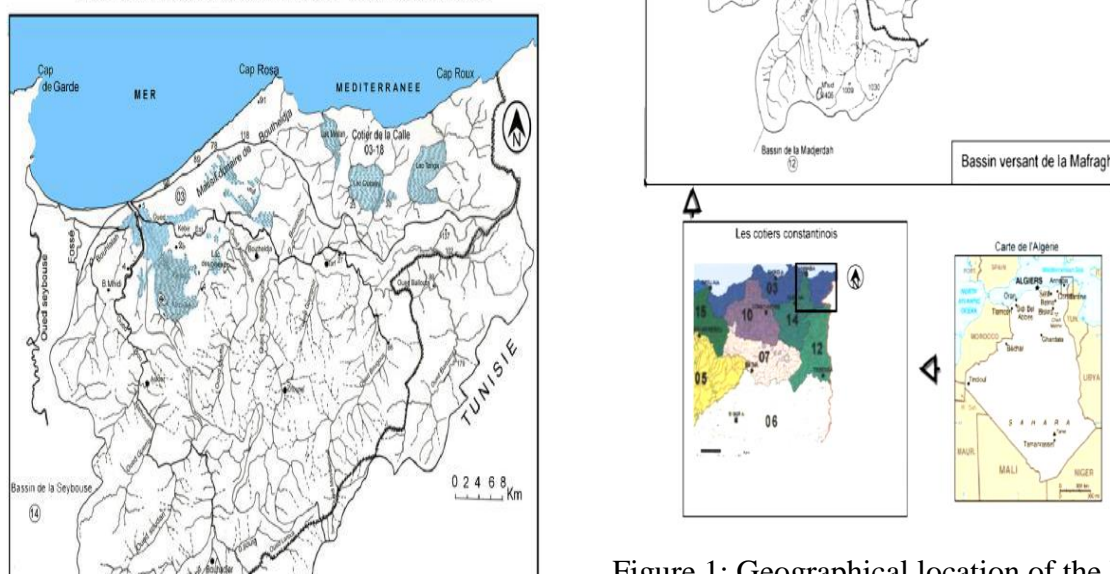


Figure 1: Geographical location of the El

Tarf city and the study area (Boutheldja and El Tarf)

Among the most responsive breeders who have agreed to cooperate with us in the town of El Tarf and Boutheldja, we have selected different watering sources such as: well, source, wadi, public drinking water supplies and borehole water. Three selected breeders were visited for dairy cattle watering withdrawal from January until June 2016. This period coincides with the most important phase of milk yield in lactating cows (peak lactation). The samples taken from the seven selected different watering sources: two wells, one natural source, one public drinking water supply, one wadi and two boreholes, were filled in 500 mL glass vials. Temperature, pH and salinity were measured in situ at each sampling using a multi parameter water quality analyzer. The pollution parameters were analyzed at the laboratory according to the analytical methods recommended by (AFNOR, 1997) and (Rodier, 2009). The microbiological parameters analyzed in this contribution are: total coliforms; Thermotolerant coliforms; *Escherichia coli* and faecal streptococci, the latter were analyzed in the laboratory following the analytical protocol of Rodier *et al.* (2009). The results are presented on average  $\pm$  standard deviation (SD), all the obtained results of the water quality were subjected to one-way analysis of variance (ANOVA) with the SAS system for generalized linear model (15) at the  $p < 0.05$  level of statistical significance. The Student-Newman-Keuls test (SAS) (15) made it possible to seek homogeneous groups of averages.

## Results and discussion

The turbidity of the water sources analyzed is not high; the waters are generally colorless or slightly colored except for the two wells and El Kebir wadi where the waters are turbid. Vegetation cover is one of the factors capable of increasing the turbidity (Harrat and Achour, 2010). This turbidity would then be partly organic and may lead to a significant increase in chlorine doses during water treatment (Harrat and Achour, 2010). The pH depends on the origin of the water, the geological nature of the substrate and the watershed crossed. This parameter can have more significant impacts on animals. In ruminants, consumption of water with a pH less than 5.5 is associated with metabolic acidosis, whereas alkaline water with a pH above 8.5 may be the source of an increased risk of metabolic alkalosis. Nevertheless, observed values indicate that the pH of all analyzed sources is neutral and therefore remains within drinking water standards for dairy cattle, except for the second well where the trend is alkaline. These values could be explained by the shallow depths of the wells and the geological characteristics of the terrain. Conductivity is proportional to the amount of dissolved ionizable salts and is a good indication of mineralization of the water. The measured range from  $130.4 \pm 4.8 \mu\text{S}/\text{cm}$  to  $2515 \pm 35 \mu\text{S}/\text{cm}$ . This reveals a significant variation between watering sources with strong mineralization associated with high salinity for certain points (borehole 2 and Well 2). Nevertheless, our results can be considered acceptable from conductivity and salinity points of view. Moreover, the analyzed waters are too hard, for all the points analyzed. Analysis of the variance shows highly significant differences ( $p < 0.001$ ) in terms of pH, turbidity, conductivity, salinity and hardness in the different analyzed sources, however, a significant difference ( $p=0.023$ ) is found in the sampling points in terms of temperature.

Table 1. Results of physicochemical watering parameters

Parameter	Turbidity	pH	Conductivity	Salinity	Temperature	Hardness
Source	$14,09^b \pm 6,5$	$7,08^c \pm 0,02$	$271,66^d \pm 43,4$	$0,1^c$	$16,8^a \pm 3,1$	$83,3^d \pm 20,8$
Well 1	$51,26^a \pm 14,4$	$7,09^c \pm 0,05$	$574,66^c \pm 39,6$	$0,3^c$	$19,7^a \pm 2,1$	$143,3^c \pm 5,7$
Well 2	$79,6^a \pm 8,6$	$8,1^a \pm 0,1$	$1430,6^b \pm 60,4$	$1,17^b \pm 0,2$	$15,43^a \pm 0,3$	$854,8^a \pm 47,2$
Public Drinking Supplie	$15,33^b \pm 5,8$	$7,72^b \pm 0,15$	$390,66^e \pm 20$	$0,1^c$	$18,03^a \pm 0,6$	$116,7^{cd} \pm 5,4$
Wadi	$57,23^a \pm 36,2$	$7,07^c \pm 0,07$	$511^d \pm 27,22$	$0,23^c \pm 0,05$	$19,06^a \pm 3,05$	$193,3^b \pm 11,5$
Borehole 1	$2,47^b \pm 2,07$	$7,01^c \pm 0,04$	$130,43^e \pm 4,8$	$0,1^c$	$17,6^a \pm 1,34$	$31,6^e \pm 2,8$
Borehole 2	$5,33^b \pm 2,08$	$7,99^a \pm 0,17$	$2515^a \pm 35$	$1,6^a \pm 0,05$	$15,43^a \pm 0,3$	$847,3^a \pm 21,4$
P	0,001***	0,001***	0,001***	0,001***	0,023*	0,001***

ns: non significant \*significant ( $P < 0,05$ ) \*\*very significant ( $P < 0,01$ ) \*\*\*highly significant ( $P < 0,001$ )

Table 2. Results of parameters of organic pollution of drinking water:

Parameter	Nitrates	Nitrites	Phosphorus	Sulphates	Chloride
Source 1	$5,16^c \pm 2,5$	$0,01^d \pm 0,006$	$0,17^a \pm 0,03$	$97,59^b \pm 25,9$	$56,8^c \pm 7,1$
Well 1	$1,5^d \pm 0,2$	$0,89^c \pm 0,1$	$0,10^a \pm 0,13$	$82,92^b \pm 31,5$	$125^c \pm 4,8$
Well 2	$15,23^a \pm 2,3$	$3,83^a \pm 0,8$	$0,22^a \pm 0,05$	$102,88^b \pm 27,6$	$749,3^b \pm 51$
Public Drinking Supplie 1	$2,88^{cd} \pm 1,3$	$0,07^d \pm 0,03$	$0,13^a \pm 0,05$	$119,9^b \pm 16,73$	$58,9^c \pm 4,6$
Wadi	$10,10^b \pm 0,9$	$2,03^b \pm 0,05$	$0,37^a \pm 0,4$	$99,78^b \pm 3,52$	$82,8^c \pm 8, 2$
Borehole 1	$1,67^d \pm 0,2$	$1,63^{bc} \pm 0,4$	$0,27^a \pm 0,12$	$98,07^b \pm 11,26$	$45^c \pm 14,8$
Borehole 2	$13,4^a \pm 1,1$	$1,40^{bc} \pm 0,2$	$0,23^a \pm 0,03$	$188,3^a \pm 40,2$	$1131^a \pm 100,5$
P	0,001***	0,001***	0,637ns	0,003**	0,001***

ns: non significant \*significant ( $P < 0,05$ ) \*\*very significant ( $P < 0,01$ ) \*\*\*highly significant ( $P < 0,001$ )

The results of the nitrate analyzes show that their contents range from  $1.5 \pm 0.2$  mg / l to  $15.23 \pm 2.3$  mg / l during this study period with highly significant differences ( $p < 0.001$ ). All stored values do not exceed the recommended standards of 50mg / l. The quantities of nitrates in well water can vary abruptly, and depend on many climatic, environmental and agricultural factors; these results are consistent with those found by (Merzoug *et al.*, 2010). On the basis of the results achieved, nitrite concentrations show highly significant differences with values ranging from  $0.01 \pm 0.006$  mg / l to  $3.83 \pm 0.8$  mg / l for the second well water. However, the concentration of this element remains high compared to the standard of 0.1 mg / l and this for a significant number of our sampling points, which foretells an anthropogenic pollution.

A high nitrite content in ground and surface water is often associated with excessive use of nitrogen fertilizers, excessive manure application, runoff from livestock collecting areas. It often happens that water sources close livestock farms contain high levels of nitrite. Generally, high concentrations of nitrite are found only when the source is polluted with organic waste and very low oxygen levels (AAVL, 2000). For phosphorus, all recorded values do not exceed standards ( $p = 0.637$ ), these results are consistent with those found by (Merzoug *et al.*, 2011). Excess sulphates and chlorides cause corrosion but also give an unpleasant taste to water with a risk of under-consumption and can cause diarrhea (Gadin-Goyon, 2002). According to the results of the samples analyzed, the concentrations of sulfate ions range from  $82.92 \pm 31.5$  mg / l to  $188.3 \pm 40.2$  mg / l. These values remain below the OMS value (VG = 500mg/l) of the water quality standards for livestock watering and don't constitute any danger. A similar result was observed for chlorides except for the second well and the second borehole where concentrations exceed international recommendations by 400mg / l. The analysis of variance shows very significant differences ( $p = 0.003$ ) for sulphates and highly significant for chloride between sampling points.

Table 3. Results of bacteriological parameters of drinking water

Parameter	CT	CF	SF	<i>E.coli</i>
Source 1	$12^c \pm 8,2$	$16^c \pm 4$	$0^c$	$0^c$
well 1	$220^b \pm 208,1$	$150^b \pm 30$	$2^b \pm 1$	$0^c$
well 2	$840^a \pm 160$	$476,67^a \pm 68,07$	$100^a \pm 10$	$10,33^a \pm 2,5$
PublicDrinking Supplie1	$20^c \pm 17,3$	$2^d \pm 2$	$0^c$	$0^c$
Oued	$216,7^b \pm 76,4$	$100^b \pm 30$	$103,3^a \pm 6,66$	$4,33^a \pm 2,5$
Borehole 1	$17,3^c \pm 15,1$	$21^c \pm 5,29$	$0^c$	$0^c$
Borehole 2	$7^d \pm 6,1$	$26^c \pm 7,21$	$1,33^b \pm 0,58$	$0^c$
P	0,001***	0,001***	0,001***	0,001***

ns: non significant \*significant ( $P < 0,05$ ) \*\*very significant ( $P < 0,01$ ) \*\*\*highly significant ( $P < 0,001$ )

The evaluation of the bacteriological quality of ruminant wateringis based on the concept of germs known as indicators of fecal contamination (Dermaux, 1999). The more there is fecal bacteria in the water, the greater the risk of the presence of pathogens organisms is real (Chevet, 2000). Table 3 shows that the second wells as the most contaminated source of water with a total of  $840 \pm 160$ UFC/100ml, however, the least contaminated watering point with a total of  $7 \pm 6,1$ UFC/100ml in the second drilling. Nevertheless, the second well is characterized by the most important bacteriological loads, and this for all the bacteria. However, the results of *E. coli* reveal an absence of this bacterium in all the points except the waters of wadiofkebir and the second well.

Analysis of the variance shows highly significant differences ( $p = 0.000$ ) in the bacterial load of the studied sources. The high bacteriological contamination of the waters analyzed could be due to: poor protection of wells (open pits). Moreover, the waters of the study area have a

high fecal contamination, which is in line with those found by (Boutin and Dias, 1987) for the Marrakech aquifer. The surface waters laden with microorganisms seep through the soil into groundwater table without having had an efficient filtration, and causes many different point sources of pollution. (Boutin, 1987) also mentioned that water from underground reservoir is all the more vulnerable as the top of the underground water table is close to the surface of the ground, that the land above aquifers is permeable and surface sources of pollution are important. In addition, shallow aquifers, with access via wells, appear to be highly contaminated with organic materials of human and animal origin.

### **Conclusions**

This study reveals that the waters of the sources analyzed are highly mineralized, characterized by high salinity and high hardness; With detected nitric pollution. In addition, bacteriological analysis shows that the majority of our sources are highly contaminated with at least two bacteria, hence, the majority of the sources studied are unfit for dairy cattle consumption.

### **References**

- AAVL. (2000). The systems of watering to the grazing, Technical guide, of Association for the Development of the Valley of the Lot. Rance rivers and Cele, 2000 edition, 31p.
- Boutin C. (1987). The water of superficial groundwater, a natural richness vital but vulnerable. The example of the rural areas of Morocco. *Water Sciences*, vol. 6, p. 357-365.
- Boutin, C., Dias L. (1987). Impact of the spreading of wastewater from the city of Marrakech on the water table. *Bull. Faa. Sa. Marrakech*, vol. 3 pp. 5-2
- Chevet B. (2000). Water quality: an indispensable link in dairy farming; Technical Office for Dairy Promotion. ELNOR. pp 1-5.
- Dermaux V. (1999). Regulatory and sanitary study of the quality of drinking water in domestic animals. Doctoral thesis. Lyon, 111pp.
- Harrat N., Achour S. (2010). Physico-chemical pollution of the dam waters of the El Tarf region. Impact on chlorination. *Journal of the Underground and Surface Hydraulic Research Laboratory* vol. 8 pp. 47-54
- Houd K., Slimani A. (2014). Characterization of the physico-chemical quality of ruminant water in the semi-arid zone of Oum El Bouaghi, Northeast Algeria. *Livestock Research for Rural Development*. vol 26, N 2, PubN 25
- Merzoug D., Khiari A., AïtBoughrou A and Boutin C. (2011). Aquatic fauna and water quality of wells and springs in the Oum El Bouaghi region (Northeast Algeria), *Applied Hydroecology*, vol. 17 pp. 77-97.
- Mebirouk-Boudechiche L., Boudechiche L., Maatallah S., Chemmam M., Menasri G. (2011). Feeding behavior of local breed cows on northeastern Algerian meadows ", *Fourrages*, vol. 205 pp. 53-59.
- Olkowski AA. (2009). *Livestock Water Quality: A Field Guide for Cattle, Horses, Poultry and Swine*, 185pp.
- Rodier JB, Legube N., Merlet. (2009). *Water analysis. Natural waters, sewage, seawater.* Dunod, 9th ed., P: 1600
- Weeth H J. (2001). Tolerance of growing cattle for sulfate-water. *Journal of Animal Science*. Vol. 34, pp, 256-260



## MONITORING AND ASSESSMENT OF PHYSICO-CHEMICAL PARAMETERS OF SOILS AND COALS USED IN BRICK KILNS AND THEIR IMPACT ON HEALTH AND ENVIRONMENT

Md. Azharul ISLAM<sup>1,\*</sup>, Mst. Rokaiya HASINA<sup>1</sup>, Premangshu MAJUMDER<sup>1,2</sup>, Md. Tanvir HOSSAIN<sup>3</sup>, Rehana KHATUN<sup>1</sup>

<sup>1</sup>Department of Environmental Science, Faculty of Agriculture, Bangladesh Agricultural University, Mymensingh-2202, Bangladesh

<sup>2</sup>Department of Environmental Science, Faculty of Agriculture, Bangladesh Agricultural University, Mymensingh-2202, Bangladesh

<sup>3</sup>Scientific Officer, Soil Resource Development Institute, Farmgate, Dhaka, Bangladesh

<sup>4</sup>Scientific Officer, Soil Resource Development Institute, District office, Tangail, Bangladesh

\*Corresponding author: maislam@bau.edu.bd

### Abstract

To assess the heavy metals in soil and coal used in Brick kilns and to monitor the air pollution awareness at Madhupur union in Rangpur district in Bangladesh a study was conducted from January 2015 to June, 2017. Soil and coal samples were randomly collected from six brick kiln areas followed by analysis using Atomic Absorption Spectrophotometer. The farmers' awareness on metal impact on health nearby the investigated brickfield areas was surveyed using questionnaire and personal interview. The results revealed that the deposition of fly ash or residues after combustion of coal burning produced notice worthy effects on the soil quality. The mean concentrations of Cr and Pb in the soil of the brick kiln area were 59.54 and 25.84 mg/kg, respectively and the mean concentrations of the Cr and Pb in the coal were 27.15 and 45.87 mg/kg, respectively. The concentrations of Cr and Pb in soil were found in uncontaminated in nature but Pb of coal were high in UBC-3 brick kiln area and higher than permissible limit. This would negatively impact on human health and crop production. The survey findings revealed that majority of the farmers had medium level of awareness on health impact and air pollution nearby the brickfield areas. Farmer characteristics like academic qualification, extent of media contact, knowledge and vulnerability on air pollution had significant positive relationship with their awareness on air pollution. So, awareness should be built up against traditional brick making industries through adopting energy efficient clean technology in brick kilns.

**Keywords:** *Heavy metals, soil and coal, brick kiln, air pollution, deposition of fly ash, Bangladesh.*

### Introduction

Bangladesh has about 6,000 authorized brickfields and numerous illegal ones (Bayron, 2009). In Bangladesh there are three major sources of air pollution; brick kiln is one of them. The prominent cause of this pollution is using coal as fuel in maximum brick kilns. In manufacturing seasons of brick, pollution goes to the peak in and around the brick kilns situated area depending on the monsoonal rains. One investigation says that Bangladesh uses about 23 tons of coal to produce 100,000 bricks, where China which uses 7.8 to 8 tons of coal to produce the same amount (Maksuda and Abdullah, 2012). Using low quality coal seams to have much Cd, Hg, Pb, Cr, As compared to typical basalt. Heavy metals accumulation observed and reported in Brick Kiln surroundings in Pakistan (Ishaq et al., 2010). So Bangladesh has a probability to show more toxicity comparing with other countries of the world.

Various particulate and gaseous matters also released from brick industry which badly affect our environment (Banglapedia, 2007). It is necessary to know their awareness on health impact and air pollution due to brickfields. There is a few research has been conducted on analysis of soil, water, fish and plant accumulation in Bangladesh but limited reports observed on metal contents in soil and coal used in brick kiln (Rahman et al., 2016, Uddin et al., 2016, Khan et al., 2007, Khan et al., 2004). There were about 8 brick kilns in the *Madhupur Union* of target area in Bangladesh and most of the brick field owners use low quality coal for saving extra cost (Talukder et al., 2015) and so, the probability of toxic pollutants entering into ecosystem is pretty high. As there are still some limitations due to their not considering heavy metal analysis, such kind of effective works including of heavy metal analysis have been undertaken by this present study. Also soil contamination and coal burning is a major problem undergone only a little effective research for what the present study was undertaken to compare heavy metals (Cr and Pb) status of soil and coal used near the brick field areas and to investigate the farmers awareness on health impact as well as air pollution nearby the brickfield areas.

### Material and Methods

**Study area & sample collection:** Soil and Coal samples were collected from *Madhupur Union* of *Badargonj Upazilla* which is situated in the northern part of the *Rangpur* district in Bangladesh. Geographically it is laying from 25.667°N Latitude to 89.050°E Longitude. Soil samples (0–20 cm depth) and coal samples were collected from 3 brick kilns: (a) RBL-2 (b) UBC-3 and (c) PBM separately. From each location, three soil samples were collected as replications. Samples were kept separately on a brown paper and then collected samples were air-dried and external substances were removed. Samples were sieved using sieving apparatus consisting of different sieve sizes. Sieved samples (>2mm) were preserved for laboratory analysis. Samples were placed in sealed plastic bags and labeled appropriately. The collected coals were thoroughly mixed, air dried over night and crushed. After sieving samples were placed in sealed plastic bags and labeled appropriately. After that the samples were carried to the Laboratory of Soil Science Division, BINA, Mymensingh for measurement and analysis.

**Digestion of soil & coal samples:** The samples weighing 1.0 g was taken into a dry clean digestion vessel. 5 ml nitric acid (HNO<sub>3</sub>) was added to the vessel and allowed to stay it overnight with covering the vessel to vapor recovery device. On the following day, the digestion vessel was placed on a heating block and was heated at a temperature slowly raised to 120° C for two hours. After cooling 2 ml Hydrogen per oxide (H<sub>2</sub>O<sub>2</sub>), it was added and waited to minimize the reaction with organic matter for 30 minutes. Heating was normally stopped when the dense white fume emitted, after which the volume was reduced to 3-4 ml. The digestion was cooled, diluted to 50 ml with deionized water and filtered through Whatman No. 42 filter paper into plastic bottle. The soil/coal sample was digested at laboratory of the soil science division, BINA, Mymensingh.

**Determination of total Pb and Cr:** Total Pb and Cr were determined at the Laboratory of Soil Science Division, BINA (Bangladesh Institute of Nuclear Agriculture) by using the SHIMADJU AA 7000 Atomic Absorption Spectrophotometer (AAS) (PG 990, England) by following the methods of Haq and Alam (2005).

**Statistical analysis of analytical data:** Statistical analysis of the data generated out of analysis of soil and coal samples was done. Microsoft Office Excel 2007 software was used for data analysis and presentation. Various descriptive statistical measurements such as Range, mean and standard deviation of the contents of heavy metals of soil and coal were calculated for categorization and describing the variables.

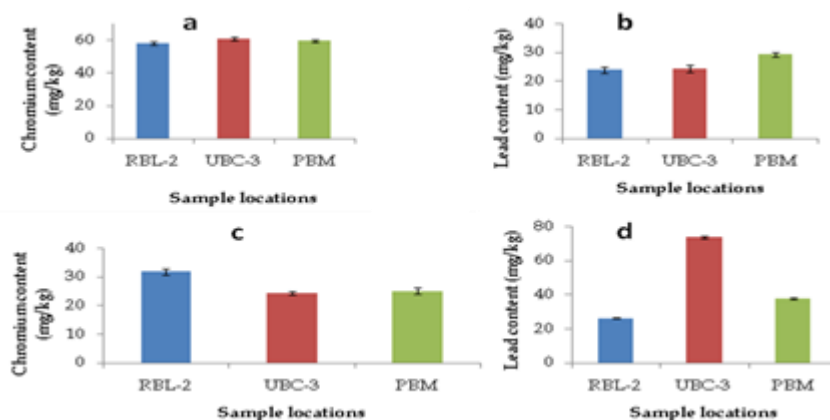
Data collection for focusing health impact and metal pollution: Data were collected through focus group discussion (FGD) and personal interview schedule from the farmers of the selected sites. Measurement of vulnerability of air pollution faced by the farmers nearby the brickfield areas and measurement of dependent variables (awareness), data processing and statistical tests were done accordingly. Pearson's Product Moment Coefficient of Correlation (r) was used. The analysis of the data was performed using software.

## Results and Discussion

### *Heavy metal status in soil samples of brick kiln area*

**Chromium:** The total Cr content in the study area ranged from 57.23 to 61.83 in soils with a mean value 59.54 mg/kg (Fig. 1a), when these concentrations were compared with U.S. EPA standards. The permissible range of chromium in soil is 1 – 1000 mg/kg. The maximum concentration of Cr in soils was recorded 60.83 in UBC-3 brick kiln area where coal was burned to making the bricks. So, the unburned coal and its combusted residual waste was highly polluted in soil and this location, Cr concentration were increasing while at RBL-2 brick kiln area from chimney it was 120 feet high, that is 58.25 mg/kg. The difference in the concentration of metals with distance might be attributed to the fallout of pollutants a few meters away from the source depending upon the direction and velocity of wind. Results of this study indicated that Cr concentration of that locality was highly related to brick kilns. Piwnik (2008) reported that the chromium concentration in the soil samples ranged from 1.67 to 10.005 mg/kg in the brick kiln area of Kathmandu-Bhaktapur road section of Araniko highway. Shorove (2013) estimated that the Cr concentration in the soil samples ranged from 122.56 mg/kg to 60.76 mg/kg with an averaging value 79.67 mg/kg, respectively nearby the brick kiln areas in Burera union, Mymensingh.

**Lead:** The Pb content of soil in the brick kilns ranged from 22.95 mg/kg to 29.95 mg/kg (Fig. 1b), when these concentrations were compared with U.S. EPA standards, it was found within the permissible limit of lead in soil (2–200 mg/kg). Presence of lead in this environment may have been due to the coal combustion. Across all locations of brick kilns, Pb concentration was the highest in PBM brick kiln area that is, 29.28 mg/kg, which may be due to the burning of coal during the baking of bricks and mainly its combusted residue polluted in soil and increase in Pb concentration while in RBL-2 brick kiln was 23.92 mg/kg. Sikander et al. (2014) revealed that Pb concentration ranged from 5.45 to 11.82 mg/kg in brick kiln area of western India. According to Kabata and Pendias (2001), the Pb status of the soils was lower than the maximum acceptable limit of 150mg/kg for crop production.



**Fig. 1:** Metal contents in soil (a,b) and coal (c,d) used in different brick kilns

Heavy metal status in coal samples of brick kiln area

**Chromium:** Cr content of coal samples used in different brick kilns in the study area ranged from 23.95 mg/kg to 33.03 mg/kg with a mean value of 27.15 mg/kg. The maximum concentration of Cr in coal was recorded 31.83 mg/kg in RBL-2 brick kiln area and the lowest concentration of Cr in coal was recorded 24.51 mg/kg in UBC-3 brick kiln area (Fig. 1c). The permissible value of Cr in coal was 33.1 mg/kg (Bieniek, 2005). According to Kudesia (2009) using low quality coal seams to have high Cr concentration may also be the cause of plant growth reduction, soil fertility loss and also some hazardous diseases of human being. Ram *et al.* (2015) estimated that concentration of Cr 7.976 mg/kg in brick kiln area of central India. An extremely high dose of chromium compounds by humans has resulted in severe respiratory, cardiovascular, renal and neurological effects as part of the sequelae leading to death or in patients who survived because of medical treatment (Hanna *et al.* 2000).

**Lead:** The Pb content of coal samples used in different brick kilns in the study area ranged from 26.03 mg/kg to 74.40 mg/kg with a mean value of 45.87 mg/kg (Fig. 1d). The maximum concentration of Pb in coal was recorded 73.65 mg/kg in UBC-3 brick kiln area where air pollution were increasing due to the burning of coal. So, the result it is negatively impact on human health and crop production. The lowest concentration of Pb in coal was recorded 26.27 mg/kg in RBL-2 brick kiln area. The Health Risk Level of Pb content of coal was 4 (Ezemokwe, 2015). The permissible value of Pb content of coal was 56.83 mg/kg (Bieniek, 2005). Ram *et al.* (2015) reported that Pb concentration in coal was observed as 4.117 mg/kg in brick kiln area of central India. Lead is a highly toxic metal whose widespread use has caused extensive environmental contamination and health problems.

**Table 1:** Salient features of the selected characteristics of the respondents and their awareness on air pollution

Characteristics	Unit of measurement	Range		Categories	Farmers (n= 50)	
		Possible	Observed		Number	(%)
Age	Year	Unknown	25-65	Young aged (25-36)	25	50
				Middle aged (37-50)	17	34
				Old (above 50)	8	16
Academic qualification	Year of schooling	Unknown	0-12	No education (0)	6	12
				Can sign only (0.5)	12	24
				Primary education (1 to 5)	17	34
				Secondary education (6 to 10)	13	26
				Above secondary (11 or above)	2	4
Family size	Number	Unknown	2-9	Small (2-4)	17	34
				Medium (5-7)	29	58
				Large (above 7)	4	8
Farm size	Hectare	Unknown	0.028-2.02	Marginal (up to 0.04)	10	20
				Small (0.041-1.0)	28	56
				Medium (1.01-2.00)	9	18
				Large (above 2.00)	3	6
Annual income	'1000' Tk	Unknown	40-130	Low income (below 80)	18	36
				Medium income (81-100)	21	42
				High income (above 100)	11	22
Extension media contact	Score	0-8	0-7	Low contact (0-2)	19	38
				Medium contact (3-5)	25	50
				High contact (above 5)	6	12
Knowledge on air pollution	Score	0-50	16-43	Low knowledge (below 20)	11	22
				Medium knowledge (20-40)	33	66
				High knowledge (above 40)	6	12
Awareness	Score	0-14	3-9	Low awareness (0-4)	12	24

				Medium awareness (5-7)	32	64
				High awareness (above 7)	6	12
<b>Vulnerability</b>	Score	0-21	8-17	Low vulnerability (below 10)	11	22
				Medium vulnerability (10-14)	29	58
				High vulnerability (above 14)	10	20

Assessment of health impacts and air pollution around the brick kiln areas: The different characteristics of the respondents and their awareness on air pollution in brick kiln surrounding areas were enlisted in Table 1. The highest proportion (66%) of the respondents had moderate air pollution knowledge compared to 22% had low air pollution knowledge and 6% had high air pollution knowledge (Table 1). Hossain & Ijaz (2008) reported that the highest proportion (49.20%) of the respondents had moderate air pollution knowledge compared to 7.7% low air pollution knowledge and 43.1% having high air pollution knowledge nearby the brick kiln areas at *Bogra* district.

*Awareness of respondents on air pollution nearby the brickfield areas:* The highest portion (64%) of the farmers had (5-7) medium awareness on air pollution due to establishment of brickfield compared to 24% low (0-4) and 12% high (above 7) awareness on air pollution due to establishment of brickfield (Table 1). The value of the mean indicate that the farmers of the study area have medium awareness on air pollution. Parveen (2006) reported in a study on awareness of farmers on air pollution due to brick field areas found that 60% farmers had poor awareness, while 34% had medium and 6% had high awareness on air pollution.

*Vulnerability of air pollution faced by the farmers nearby the brickfield areas:* The majority of the respondents 58% put their opinion towards medium vulnerability, 22% had low vulnerability and 20% had high vulnerability of air pollution nearby the brickfield areas (Table 1). Badrul (2012) reported that the majority (57%) of the respondents expressed their opinion towards medium vulnerability, 15% low vulnerability and 28% high vulnerability of environmental pollution nearby the brickfield areas at *Trishal Upazila* in Mymensingh district.

Relationship between respondent characteristics and farmer's awareness on air pollution: The age of the farmers had no relationships with their awareness on air pollution nearby the brickfield areas (Table 2). Hossain & Ijaz (2008) reported that age of the farmers had no significant relationship with their awareness on air pollution nearby the brick field areas in *Bogra* district. The findings indicate that the academic qualification had a significant and positive relationship with their awareness on air pollution nearby the brickfield areas. The findings also indicate that more education of the farmers leads to a tendency towards more awareness on air pollution because more educated farmers know the various adverse effects of brickfield (Table 2). Hossain & Ijaz (2008) found that academic qualification of the farmers had significant relationship with their awareness on air pollution nearby the brick field areas in *Bogra* district. It was found that family size of the farmers had no relationships with their awareness on air pollution due to establishment of brickfield (Table 2). Kashem (2001) found that family size of the farmers had no significant correlation with their awareness, in the study on farmer's awareness on air pollution nearby brick kiln areas in *Kalihati, Tangail*.

Table 2: Relationship between the selected characteristics of the farmers and their awareness on air pollution nearby the brickfield areas (N=50)

Depended variable: Farmers awareness								LSD*	
Independent variables									
Age	Academic qualification	Family size	Farm size	Annual income	Extension media contact	Know-ledge	Vulne-rability		
Computed 'r' values								0.05	0.01
0.261ns	0.907**	0.237ns	0.349*	0.837**	0.899**	0.723**	0.966**	0.277	0.358
* Table value of 'r' at 48 df; Correlation is significant at 0.01 levels of probability (Table value 0.358) Correlation is significant at 0.05 levels (Table value 0.277), ns = non significant									

The result also showed that the farm size of the farmers had a significant positive relationship with their awareness on air pollution nearby the brickfield areas (Table 2). Kashem (2001) found that farm size of the farmers had positive and significant correlation with their awareness, in the study on farmer's awareness on air pollution nearby brick kiln areas in *Kalihati, Tangail* districts. The findings indicate that the annual income of the farmers had a significant and positive relationship with their awareness on air pollution. The farmers who had high annual income also had more awareness on air pollution because he was able to invest more money to eco-friendly activities (Table 2). Hanif (2000) reported that there was a significant relationship between annual income of the respondents and their awareness on air pollution nearby the brick kiln area in *Dhaka Aricha* road. The extension media contact of the respondents had a significant positive relationship with their awareness on air pollution (Table 2). A respondent with more extension media contact has more awareness on air pollution. Kashem (2001) found that extension media contact of the respondents had a significant and positive relationship with their awareness on air pollution nearby brick kiln areas in *Kalihati, Tangail* which is similar to the present study.

The air pollution knowledge of the respondents had a significant positive relationship with their awareness on air pollution (Table 2). Kashem (2001) found that agricultural knowledge of the respondents had a significant and positive relationship with their awareness on air pollution nearby brick kiln areas in *Kalihati, Tangail* which is similar to the present study. The air pollution vulnerability of the respondents had a significant positive relationship with their awareness on air pollution (Table 2). In the study area, most of the respondents expressed their views that the smokes released from brickfield hampered the production of crops, vegetables and fruits and increase disease on human health, soil fertility decreases etc which was ranked at the top considering the air pollution vulnerability. Dixon *et al.* (2002) reported that vulnerability of air pollution had significantly related with farmers awareness nearby the brick kiln areas in Gujarat, India.

### Conclusions

To evaluate the quality of soil and coal used in brick kilns and farmers awareness on air pollution caused by brick kilns the present study was conducted. Results indicated that the soils were slightly contaminated due to fly ash or combusted residues after coal burning in brick kilns which contain toxicants including heavy metals. Heavy metal of coal was higher in brick kiln area which is harmful for human and environment. Heavy metals from brick kilns and their contamination is not a familiar term in Bangladesh, even people actually aren't aware of any of these kinds of contaminations or pollutions that can reduce their crop production as well as their health. So, at first awareness should be built up about this contamination so that they themselves can protest their hazards. Strict law should be enforced

to adopt energy efficient clean technology in brick kilns against traditional brick system in all over the Bangladesh. However, findings of this study indicated that no element exceeded the maximum acceptable concentration (MAC) for crop production. Survey report illustrated that air pollution vulnerability of the respondents had positive and significant relationships with their awareness on air pollution. On the other hand, age and family size had no significant relation with their awareness on air pollution nearby the brick field areas. So, it can be concluded that the findings of the work are not alarming yet but still care should be taken properly so that it cannot exceed the critical level.

### **References**

- Badrul, H. (2012). Farmers awareness on environmental pollution nearby the brickfield areas at Trishal Upazila in Mymensingh District. M.S. Thesis, Dept. Environmental Science, Bangladesh Agricultural University, Mymensingh. pp. 60-65.
- Banglapedia. (2007). National Encyclopedia of Bangladesh. Asiatic Society of Bangladesh, 2: 285.
- Bayron, R.K. (2009). Brick kilns going green. The Daily Star (December 13, 2009).
- Bieniek, O. (2005). The effect of the municipal waste landfill on the heavy metals content in soil, 4: 95-105.
- Dixon, A. (2002). Farmers awareness on air pollution nearby the brick kiln area at Gujarat, India. M. S. Thesis, pp. 60-62.
- Ezemokwe, I.V. (2015). Coal as substance, hand book in of practical coal Geology. John Wiley and sons limited, England, p. 4.
- Hanif, M.A. (2000). Competitive analysis between farmers awareness on air pollution nearby the brick kiln area in Dhaka Aricha road. M. S. Thesis, Dept. Agril. Ext. Ed., Bangladesh Agricultural University, Mymensingh. pp. 68-74.
- Hanna, M.S. & Farag, A. (2000). Heavy metals in drinking water and their environmental impact on human health. pp. 542-556.
- Haq, S.M.I. & Alam, M.D. (2005). A handbook on analysis of soil, plant and water. BACER-DU, University of Dhaka. Bangladesh. pp. 32-36.
- Hossain, I. & Ijaz, H. (2008). Impact of brick kiln pollution on Dhaka City. 11 Feb. 2008.
- Ishaq, M., Khan, M.A., Jan, F.A. & Ahmed, I. (2010). Heavy metals in brick kilns located area using atomic absorption spectrophotometer: a case study from the city of Peshawar, Pakistan. Environ Monit Assess, 166: 409-420.
- Kabata, A. & Pendias, H. (2001). Trace elements in soils and plants. 2nd ed, CRC press, London. Pp. 10-115.
- Kashem, A. (2001). Farmers Awareness on air pollution nearby the brick kiln areas: A Study in Kalihati Upazila under Tangail District. M.S. Thesis, Department of Agricultural Extension Education, Bangladesh Agricultural University, Mymensingh. P. 79.
- Khan ,H. R., Rahman, M.K., Rouf, A.M.A., Sattar, G.S. & Aktar, M.S. (2007). Effects Of brick burning on microbial biomass and kiln ratio in selected soil profiles in the eastern region Of Bangladesh Journal Of The Faculty Of Environmental Science And Technology, Okayama University, 2(1): 83-89.
- Khan, H.R., Rahman, M.K., Rouf, A.J.M.A. & Satter, G.S. (2004). Land evaluation and effects of brick burning on soil degradation at all upazilas in Rajshahi division. Dhaka University, Journal of Biological Science, 13 (1): 49-60.
- Kudesia, V.P. (2009). Air Pollution. Pragoti Prokashan. Meerut, India. p. 370.
- Maksuda, H. & Abdullah, A.M. (2012). Securing the environment: Potentiality of green brick in Bangladesh. BUP Journal, 1(1): 79-89.

- Parveen, S. (2006). Awareness of farm women on air pollution due to brick field areas in Tangail District. M.S. Thesis, Department of Agricultural Extension Education. Bangladesh Agricultural University, Mymensingh. P. 94.
- Piwnik, M. (2008). Physical analysis of change of amounts of heavy metals in soil under anthropogenic factors. *Aparatura Badawcza in Dydaktyczna*, 8(2): 58-67.
- Rahman, M. M., Islam, M. A. & Khan, M. B. (2016). Status of heavy metal pollution of water and fishes in Balu and Brahmaputra rivers. *Progressive Agriculture*, 27(4): 444-452.
- Ram, L.C., Masto, R. & Pal, S.K. (2015). Potentially toxic elements in lignite and its combustion residues from a power plant. *Environmental Monitoring Assessment*, 3: 187.
- Shorove, R. (2013). Effects of brick kilns on farm soil: A case study at Barera union in Mymensingh, Bangladesh. M.S. Thesis. Department of Environmental Science, Bangladesh Agricultural University, Mymensingh. p. 65.
- Skinder, M.A., Sheikh, Q., Pandit, K. (2014). Brick kiln emissions and its environmental impact: a review. *Journal of Ecology and the Natural Environment*, 6(1): 1–11.
- Talukder, M.I.A., Islam, M.E. & Khan, M.B.U. (2015). The impact of brickfields on environment and agriculture: An Empirical Study of Rangpur District in Bangladesh. *Journal of Media and Social Development (JMSD)*, 3(2): 39-51.
- Uddin, N., Islam, M. A. & Baten, M. A. (2016). Heavy metal determination of brinjal cultivated in soil with wastes. *Progressive Agriculture*, 27(4): 453-465.



## SOURCES OF HEAVY METALS AND THEIR INFLUENCE ON THE SOIL

Neda TEŠAN TOMIĆ<sup>1\*</sup>, Slavko SMILJANIĆ<sup>2</sup>, Vesna TUNGUZ<sup>3</sup>

<sup>1</sup> Ministry of Defense of Bosnia and Herzegovina, Sarajevo, Bosnia and Herzegovina,

<sup>2</sup> University of East Sarajevo/ Faculty of Technology, Zvornik, Bosnia and Herzegovina

<sup>3</sup> University of East Sarajevo/Faculty of Agriculture, East Sarajevo, Bosnia and Herzegovina

\*Corresponding author: tesanneda@yahoo.com

### Abstract

Soil represents a very complex and sensitive component of the environment that could easily be compromised by irrational exploitation, industrialization, mining operations, erosion and various other activities. Soil pollution is a globally growing problem, while among numerous resistant pollutants, heavy metals are the most dangerous. This group of pollutants is considered the most significant cause of degradation the soil quality, surface and underground waters as well as an immediate cause of the harmful impact on the living world.

Although heavy metals are naturally present in the soil in low concentrations, and some of them are even essential for the living world, anthropogenic activities may lead to increase of their concentration above allowed limits, which produces numerous unwanted impacts. When it comes to negative characteristics of heavy metals, it is significant to emphasize durability, toxicity, carcinogenicity, and inclusion in the food chain. The most important anthropogenic sources of heavy metals in the soil are wastewater from some industrial processes (production of metals and alloys, electroplating, production of batteries), mining activities, burning of fossil fuels, municipal waste waters, incineration and disposal of waste, sludge stemming from waste water treatment, fertilizer and pesticides usage in agriculture, military activities. The most significant heavy metals present in the soil as a consequence of these activities, are: Cu, Zn, Pb, Ni, Cd, Hg, As. In order to determine the impact of these pollutants on the environment and human health, it is necessary to determine their concentrations and form in the soil. Generally speaking, only mobile fractions are dangerous. From the health and ecological aspects, knowing the mobility of heavy metals is of great importance. This study addresses the impact of anthropogenic activities on soil contamination with heavy metals, the form in which they are present, and the negative effects caused by their presence.

**Keywords:** *Pollution of soil, Heavy metals, Mobility, Speciation, Effects.*

### Introduction

Soil and water are the most important natural resources for the existence of living species. Since the soil is practically non-renewable natural resource, conservation of this resource is becoming increasingly important. The basis of the soil is the rooting and growing of plants. It is therefore a habitat for a wide spectrum of the living world, micro and macro organisms that spend all their lives in it. If the effect of human activities disturbs the natural dynamic equilibrium established in the soil, it comes to its degradation and pollution. Contaminated soil becomes a long-term source of pollution of water systems and crops that exist in it, which has an unfavorable impact on the entire ecosystem in the surrounding area. Heavy metals represent polluting substances which exhibit extremely harmful effects on the environment and living world, if their concentration in an ecosystem exceeds the allowed quantities. The processes of soil and water contamination with heavy metals present a growing problem today in many countries. This group of pollutants is considered the most significant cause of

degradation the soil quality, surface and underground waters as well as an immediate cause of the harmful impact on the living world. In order to determine the impact of these pollutants on the environment and human health, it is necessary to determine their concentrations and form in the soil. Generally, only mobile fractions are dangerous. From the health and ecological aspects, knowing the mobility of heavy metals is of great importance.

### **Soil pollution with heavy metals**

Soil has production value with limited scale and represents a very complex and sensitive component of the environment that could easily be compromised by irrational exploitation, industrialization, mining operations, erosion and various other activities (Maksimović et al., 2009). Soil pollution occurs when the superficial layers are loaded with large quantities of waste materials which could not be decomposed under normal conditions of self-purification (Kastori, 1995). Soil pollution is a globally growing problem, while among numerous resistant pollutants, heavy metals are the most dangerous. This group of pollutants is considered the most significant cause of degradation the soil quality, surface and underground waters as well as an immediate cause of the harmful impact on the living world. Some of these heavy metals i.e. Mn, Zn, Cu, Fe, Mo, Ni, B are, in low concentrations, necessary for plants growth and they are called microelements (trace elements). In larger quantities, Mn, Zn, Cu, Fe, Mo, Ni are a burden for the environment. Other elements (Cr, Cd, Hg, Pb), that could be find in traces of soil, but are not necessary for plants growth, are mainly typical toxic pollutants and they are significant from the point of view of soil contamination (Manojlović et al., 2014).

In addition to toxicity, heavy metals are characterized by their great mobility, which causes entering the food chain so they could reach to the human body causing many negative effects on life and health (Tyteca, 1999; Gevorgyan et al., 2015). All heavy metals have a tendency of unlimited accumulation in the organism or plant tissue, which is particularly dangerous on contaminated habitats and in cultivation of plants that have high affinity for these elements (example of vegetables) (Jug, 2016). Deposition of heavy metals in the human body causes intoxication and numerous negative consequences. Long-term exposure to contaminants causes poisoning, diseases of the central nervous system, hepatitis, leukemia, diseases of cardiovascular system, kidneys and other serious disorders (Tyteca, 1999). By entering the heavy metals into the soil, a whole series of reactions are triggered, that cause changes in the quality of soil, water and atmosphere, what necessarily reflects on changes in the structure of living organisms that inhabit the contaminated area.

### **Source and content of heavy metals in the soil**

Metal in the environment arises from both natural sources and human activities. In natural systems, potentially toxic heavy metals can originate from rocks, ore minerals, volcanoes and weathering releases of metals during soil formation transported to the surface and /or aquifer waters (Szyzewski et al, 2009 ), forest fires, radioactive dust, etc. (Thierry et al., 1995). In most cases, the natural content of heavy metals in the soil is low and there is no significant impact on the pollution of agroecosystems. Exceptions are soils near the mine or metal deposits, in which heavy metals concentrations could be very high (Manojlović et al., 2012). Long-term input of pollutants into the soil can lead to a reduction in its buffer capacity, and that may result in permanent contamination of soil and groundwater (Thierry et al., 1995). The development of agricultural, industrial and urban activities has led to an increase in many ecological problems due to presence of heavy metals in the soil. The most important anthropogenic sources of heavy metals in the soil are wastewater from some industrial processes (production of metals and alloys, electroplating, production of batteries), mining

activities, burning of fossil fuels, municipal waste waters, incineration and disposal of waste, sludge stemming from waste water treatment, fertilizer and pesticides usage in agriculture, and military activities. The most significant heavy metal presences in the soil as a consequence of these activities are: Cu, Zn, Pb, Ni, Cd, Hg, As. Heavy metals exist in different chemical forms in the soil, differently linked to the soil particles. In ecological research, determination of these forms gives more information about the mobility of trace metals, as well as their availability and toxicity, compared to the total content of heavy metals (Pueyo et al., 2004). The presence of these toxicants has negative impact on biodiversity, productivity of the soil and overall functioning of the agroecosystem. The net balance of the average content of heavy metals in agroecosystem is obtained by direct laboratory measurement or using calculation of their entry (industry, fertilization, etc.) and exit in the form of agricultural products (crops, content in the animal tissues). Due to the complexity of interactions in the agroecosystem, the ecological impact of these pollutants is far more complex than in industrial processes (Pettersson, 1993). Determination of concentration of input and output of heavy metals in soil, knowing the possibilities of their immobilization, binding, precipitation or inactivation, is an essential prerequisite for sustainable management of these toxicants in agro-systems. The total content of heavy metals in the soil is a result of input of metals from multiple sources: the parent material, the atmospheric deposition, the fertilizer sources, the agrochemicals, the organic and inorganic pollutants reduced by removal of metal with crops as well as leaching and volatilization. This can be expressed as follows (Raymond and Felix, 2011; Kastori, 1997):

$$M_{total} = (M_p + M_a + M_f + M_{ag} + M_{ow} + M_{ip}) - (M_{cr} + M_l) \quad (1)$$

where “M” is the heavy metal, “p” is the parent material, “a” is the atmospheric deposition, “f” is the fertilizer sources, “ag” are the agrochemicals sources, “ow” are the organic waste sources, “ip” are other inorganic pollutants, “cr” is crop removal and “l” is the losses by leaching and volatilization.

The level of soil contamination with heavy metals and potentially polluting elements (*Lsk* (%)) can be evaluated using the expressions:

$$Lsk(\%) = \frac{\text{Total content of heavy metal}}{\text{Threshold Limit Values}} \times 100 \quad (2)$$

The following criteria are used for the interpretation of pollution (Jug, 2016): clean, unpolluted soil to 25%, soil with increased pollution 25-50 %, soil of great pollution 50-100%, polluted soil 100-200% and polluted soil more than 200% of the limit values.

Heavy metals have a normal biogeochemical cycle and their entrance into the soil can be retained shorter or longer time, depending on their physical and chemical properties. They are disappearing slowly by leaching and removal with crops. Therefore, they can accumulate in the soil in large quantities and then can disrupt natural physical-chemical properties, fertility and filtration ability. Because of this, it is of great importance to know the factors that have the influence on behavior of heavy metals in the soil and their accessibility to living organisms (Goletić, 2005).

### **Mobility and ways of binding heavy metals in soil**

Numerous studies in the last decades have shown that data on the total content of metals in the environment do not give a clear picture of their geochemical properties, such as mobility and reactivity or biological properties (accessibility, toxicity) (Kabata-Pendias, 2004; Menzies et al., 2007). Mobility and accessibility of metals in the soil are influenced by various factors that can be geochemical, climatic and biological source (Kabata-Pendias, 2004).

Heavy metals that came into the soil as a result of anthropogenic activity are most commonly found in mobile fractions and plants can absorb them in increased concentrations. In the case of unpolluted or low-polluted soils, the metal content is uniform in the depth of the profile or slightly elevated in the plowing layer due to the biological circulation of the elements. Soil that is heavily exposed to anthropogenic pollution by heavy metals, and since metals from anthropogenic sources are retained in surface layers of soil, they usually have a higher concentration of mobile forms of heavy metals in the zone of rooted plants (Antić – Mladenović, 2004). Heavy metals in soil can exist in several forms that primarily depend on the pH of the soil, its chemical and mineral composition, and properties of the heavy metals. The mobility of heavy metals from anthropogenic pollution depends on the acid reaction, the mineral composition, the content of organic matter and humus, the granulation, the temperature and the humidity of the soil. Metals in soil can be found in one or more of several fractions (Hlavay et al., 2004; Pertsemli and Voutsas, 2007): 1) dissolved in a soil solution, 2) occupy interchangeable places on inorganic soil constituents, 3) specifically adsorbed on inorganic soil constituents, 4) related to the insoluble organic matter of the soil, 5) precipitated as pure or mixed matter, 6) present in the structure of secondary minerals and / or 7) present in the structure of primary minerals. In situations where the metals get into the environment due to human activities, the metals are associated with the first five basins. Natural metals can be connected to any of the basins depending on the geological history of the area. Depending on the phase to which they are bound, metals exhibit a different degree of mobility. The method of sequential extraction is used to determine these fractions. There are several modifications of this method, but the most common method is that the metals are classified into 5 factions: exchangeable, carbonate, oxide (Fe-Mn oxide), organic (organic / sulphide) and residual. Sequential extraction techniques are based on the successive application of various chemical extracts on the same sample. Each subsequent extraction step involves a different type of chemical reaction (Tessier et al, 1979; Tessier and Campbell, 1987; Jain, 2004). It is shown that the heavy metals in contaminated sediments significantly accumulate in a removable, carbonate and oxide fraction. In uncontaminated sediment, heavy metals are usually found in the residual fraction (Jain, 2004). According to Zeien, mobile fractions of heavy metals (which are accessible to plants) include: metals soluble in water (in the form of ion in the soil solution), exchangeable fraction and easily soluble metal - organic complexes. There are potentially affordable metal fractions that form part of organic compounds with low-stability and metals related to carbonates. Residual fraction and fractions in which metals are bound to Fe and Mn oxides and organic matter are not accessible to plants because they are practically immobilized in them (Zeien, 1995). A. Kabata-Pendias and A. B. Mukherjee state that the heavy metals in the soil originate from several sources and therefore are determined their accessibility (Table 1). Given the uncertainties that exist in the scientific literature regarding the mentioned term of accessibility, the current division is due to its systematic approach very useful and easily applicable (Kabata-Pendias and Mukherjee, 2007).

In a natural environment, where typically exists a complex mixture of compounds that are able to bind metal ions in complexes, they precipitate into insoluble compounds or strongly adsorbed on the surface of the particles (Nieboer, 1999). Heavy metals can be deposited in soil by processes such as precipitation, complexing and sorption on various minerals. Natural deactivation of heavy metals in the soil is limited and mainly takes place their sorption by soil minerals, or conversion into insoluble compounds. Oxides of iron and manganese, to lesser extent minerals of clay, are the most important sorbents of heavy metals in the soil (Bowman et al, 1981), and besides them, it is also important to mention organic matter (Kerndorff and Schnitzer, 1980).

Table 1. Fractions and accessibility of heavy metals depending on their source in soil (Tessier et al., 1979; Kabata-Pendias and Mukherjee, 2007)

Source	Bound to	Phase of soil	Fraction	Accessibility
From the lithosphere - originating from the parent substrate	mineral	solid	residual	very weak
From the pedosphere - originating from the parent substrate but during the process of genesis of soil changes the original shape of these elements, whereby climate conditions have dominant influence	clay particles, organic matter of soil and oxides and hydroxides ----- individual and complex ions	solid	bound to organic matter of soil and oxides and hydroxides	weak
		liquid	free ions and atoms	weak
Anthropogenic - elements are deposited on soil and / or into soil as a result of different human activities	mineral, organic matter of soil and the particle surface of soil	solid	mostly interchangeable and chelated	medium and weak
From the pedosphere + anthropogenic	individual and complex ions	liquid	free ions and atoms	weak

### Conclusion

The important issue today is the preservation and protection of the soil from damage and permanent destruction. In most cases, uncontrolled use of soil leads to its permanent destruction. Such processes reduce the areas for agricultural production, but also for other uses, thus reducing the possibility of food production.

Total content of an element is a very poor indicator of its bioavailability. Toxicity of an element is dependent on the mobility, transformation and potential bioavailability to plants and so into food chain. The separation of various chemical forms of heavy metals in soils is very important. The chemical and physical properties of the soil are essential parameters that have effects on metal forms in soil and its mobility. Toxic metals are widespread in the environment and their early detection is the basis for the prevention or control damage to people or the ecosystem. High concentrations of heavy metals have a harmful effect on the living world so this is of great importance to monitor these toxicants.

### References

- Antić – Mladenović S., (2004). Chemistry of nickel and chromium in the soil with their natural high contents. Doctoral Dissertation, Faculty of Agriculture, Belgrade.
- Bowman R.S., Essington M.E., O'Connor G.A., (1981). Soil sorption of nickel: Influence of solution composition, *Soil Sci. Soc. Am. J.*, 45, pp. 860-865.
- Gevorgyan G.A., Movsesyan H.S., Grigoryan K.V., Ghazaryan K.A., (2015). Environmental risks of heavy metal pollution of the soils around Kajaran town, Armenia, *Yerevan State University, Chemistry and Biology*, N0 2, p.p. 50 – 55.
- Goletić Š., (2005). Monitoring the content of heavy metals in the soil in the environment of Zeljezara in Zenica, 4. Scientific conference with international participation „Quality 2005“ pp 545 – 552.

- Hlavay J., Prohaska T., Weisz M., Wenzel W.W., Stinngeder G.J., (2004). Determination of trace elements bond to soils and sediment fractions. *Pure and Applied Chemistry* 76 (2), 415–442.
- Jain C.K., (2004). Metal fractionation study on bed sediments of River Yamuna, India, *Water Research* 38, 569–578.
- Jug I. (2016). Harmful substances in the soil, Module: basics of agroecology. [http://ishranabilja.com.hr/literatura/osnove\\_agroekologije/Stetne%20tvari%20u%20tlu.pdf](http://ishranabilja.com.hr/literatura/osnove_agroekologije/Stetne%20tvari%20u%20tlu.pdf) Accessed: 23.12.2016.
- Kabata-Pendias A., (2004.) Soil-plant transfer of trace elements - an environmental issue. *Geoderma* 122, 143-149.
- Kabata-Pendias A., Mukherjee A.B., (2007). *Trace Elements from Soil to Human*. Springer, New York.
- Kastori R. (1995). *Protection of agroecosystems*, Novi Sad, 199-284.
- Kastori R., (1997.). *Heavy metals in the environment*, Novi Sad.
- Kerndorff H., Schnitzer M., (1980) Sorption of metals on humic acid, *Geochim. Cosmochim. Acta*, 44 1701-1708.
- Maksimović S., Antonović G., Pivić R., Brebanović B., Nikoloski M., Perović V., (2009). Soil of Central Serbia, in: Mrvić V., Antonović G., Martinović L. (Eds.), *Fertility and Contents of Hazardous and Harmful Substances in the Land of Central Serbia*. Belgrade, pp. 3–37.
- Manojlović M., Bogdanović D., Lazić S., Nešić Lj., (2014). Fertility and burden of soil in the border region, University of Novi Sad, Faculty of Agriculture, Novi Sad.
- Manojlović M., Singh BR, (2012). Trace elements in soils and food chains of the Balkan region, *Acta Agriculturae Scandinavica, Sectio B - Plant Soil Science*, 673-695.
- Menzies N.W., Donn M.J., Kopittke P.M., (2007). Evaluation of extractants for estimation of the phytoavailable trace metals in soils. *Environmental Pollution* 145, 121-130.
- Nieboer E., Fletcher G.G., Thomassen Y., (1999). Relevance of reactivity determinants to exposure assessment and biological monitoring of the elements, *J. Environ. Monitor.* 1 (1) 1-14.
- Pertsemli E., Voutsas D., (2007). Distribution of heavy metals in Lakes Doirani and Kerkini, Northern Greece. *Journal of Hazardous Materials* 148 (3) 529-537
- Pettersson O., December 8–9 (1993). *Agriculture, ecology and society*. International Conference of the Fertilizer Society, Cambridge, UK.
- Pueyo M., Lopez – Sanchez J.F., Rauret G., (2004). Assessment of CaCl<sub>2</sub>, NaNO<sub>3</sub>, and NH<sub>4</sub>NO<sub>3</sub> extraction procedures for study of Cd, Cu, Pb and Zn extractibility in contaminated soils, pp. 217-226.
- Raymond A. Wuana and Felix E. Okieimen, (2011). *Heavy metals in Contaminated Soils: A Review of Sources, Chemistry, Risks and Best Available Strategies for Remediation*, International Scholarly Research Network, Article ID 402647.
- Szyczewski P., Siepak J., Niedzielski P, Sobczynski T. (2009) Research on heavy metals in Poland. *Pol J Environ Stud* 5:755-768.
- Tessier A., Campbell P.G.C., Bisson M., (1979). Sequential extraction procedure for the speciation of articulate trace metals. *Anal. Chem.* 51, 844–860.
- Tessier A., Campbell P.G.C., (1987). Partitioning of trace metals in sediments: relationship with bioavailability. *Hydrobiologia* 149, 43–52.
- Thierry M., Salomon M., Nunen J.V. and Wassenhove L. V. N. (1995). Strategic issues in product recovery management. *California Management Review*, 37, 114–35.
- Tyteca D., (1999). Sustainability indicators at the firm level. Pollution and resource efficiency as a necessary condition toward sustainability. *Journal of Industrial Ecology* 2(4) 61.

Zeien H., (1995). Chemische Extraktionen zur Bestimmung der Bindungsformen von Schwermetallen in Böden (Chemical extractions to identify heavy metal binding forms in soils). Bonner Bodenkundliche Abhandlungen 17, 284 pp.

## **ENVIRONMENTAL ASPECTS IN CULTIVATION OF PAULOWNIA IN BULGARIA**

Avgusta STEPCHICH

Institute of Soil Science, Agrotechnology and Plant Protection "N. Poushkarov", Sofia, 7 ShosseBankya Str., Bulgaria

\*Corresponding author: [astepchich@yahoo.com](mailto:astepchich@yahoo.com)

### **Abstract**

Paulownia is a relatively new plant species grown in Bulgaria. It is primarily associated with the extraction of timber. The tree is characterized by rapid growth in height, but also with high value of the manufactured wood. The species is of great ecological importance. There are large, bright and fragrant flowers and the big leaves facilitating the absorption of carbon. It is suitable as a honey culture and the most suitable type is Paulownia tomentosa. The plant is propagated in different ways – by seeds, by cuttings and in-vitro method. The most popular method is by cuttings. The seeds are light and easily propagated by wind, but difficult to intercept alone. Because of the large amount of seeds in the seed pod, species is considered invasive for the territory of Bulgaria. The studies aimed at establishing risk of invasiveness and the possible usage of the species in Bulgaria. The studies, based on field measurements, showed that the soil and climatic conditions of the country do not premise invasiveness of the species. The species Paulownia is suitable for cultivation on reclaimed land, as well as for soil erosion control. Based on information collected from different experimental sites it is concluded that Paulownia has a great ecological importance and can be used in different areas.

**Keywords:** *Paulownia, environmental impact, cultivation, Bulgaria*

### **Introduction**

The ecological significance of individual plant species varies on soil and climatic conditions. The plant species Paulownia spp. has gained popularity in recent years. Cultivation is related to the possibility of using the species for different purposes. It is known for its rapid growth and decorative qualities. Paulownia best develops on light, well-aerated soils with a pH of 5.5 to 8.9. In clay or swampy soils the development of the root system is difficult and the growth is insignificantly. Intensive Paulownia cultivation is optimal to an altitude of 700-800 m and temperatures at which maximum growth is observed in the range of 24-33 °C. Regarded to wind, it is recommended that plantations be established in locations with a wind speed of not more than 28 km/h. The plant is propagated in different ways - by seeds, cuttings and in-vitro method. The most popular method is cuttings. Due to the presence of a large quantity of seeds in the seed pod, the species was considered invasive for the territory of Bulgaria. The seeds are light and easily transported by wind, but are difficult to strike root on their own. The flowers are large, bright and aromatic, hanging on long 15-30 cm thick twigs. The planting pattern is determined depending on what the resulting timber will be used for. Lawrence (2011) gives an example with plantations from Western Australia, Queensland, where the scheme used ranges from 6x5 m to 6x7 m, rarely 7x7 m. Kalmukov (2009) indicates the use of two distances between adjacent rows- 1.5 m and 2.0 m three densities between each two plants within the row - 0.5 m, 1.0 m and 1.5 m. Paulownia wood is suitable for both biomass and wood production. The price of wood is high, as the World Paulownia LLC proposed for



m<sup>3</sup> wood is US \$ 275. Diseases of Paulownia are most often caused by fungi, viruses, sunburn or over-wetting, which mainly affect the root, the trunk and the leaves. There are also a number of pests.

### Materials and methods

The article is based on a review of primary and secondary data. Field experiments have been set up under different soil conditions. The trials were carried out on the territory of village of Pravda (Dulovo municipality) and village of Lyulin (Pernik municipality). To determine the morphological structure, composition and soil properties, soil profiles were made and soil samples were taken from the two sites. The climate is tracked according to the National Institute of Meteorology and Hydrology.

For the village of Pravda, plantations have been observed since 2012. The planting pattern is 3x3 m in chess scheme. This scheme is widely used for growing timber. Plantation in Lyulin is made 2013. The planting pattern is 3x3 m in straight rows. Measurements of the height of individual plants for each site were carried out.

Three maps have been created using soil, climate and irrigation data to produce maps showing the appropriate areas for paulownia, meeting the requirements of culture. The first map shows territories that cover all the required factors (soil, climate and irrigation). The second map limits places with an average temperature of up to +13.5 °C, and the third indicates places with irrigated mode. Observations have also been carried out on invasiveness of the species.

### Results and discussion

The reason why the plant has gained great popularity in recent years is the extremely fast growth. Various sources describe the growth of the tree, which in 8 years reaches over 20 m. The height of a 3 year old poplar is from 9 to 12 m, while in paulownia it is from 10 to 15 m. Plant development is traced under different soil and climatic conditions on the territory of two plantations in different parts of Bulgaria. The first site is in the village of Pravda (Dulovo municipality). From the soil profiles made on site, it was found that the soil is Luvic Chernozems, heavy sandy-clay (Clayic). By mechanical composition the soil is characterized as heavy sandy clayey (54.3% physical clay in the surface horizon). The humus content in the surface horizon is 2.20%, which characterizes it as low humus soil. The nitrogen content of the soil is very low - 17.9 mg / kg. The phosphorus content is 12.8 mg/kg, and with potassium content of 20.2 mg/kg the soil is considered as well stocked. The reaction of the soil is very strongly acidic (pH in water 4.9), and carbonates are not found at the depth of the profile. In climatic terms the territory of Pravda is characterized by temperatures of 12.7 to 13.1 °C. High annual precipitation values are reported - from 789 mm to 813 mm. No frost for the studied period was recorded at the plantations in Pravda.

Plants show a significant growth since the first year of planting. The average growth in height of the plants is shown in Table 1.

Table 1. Average height (m) of plants in village of Pravda

Year	2012	2013
Average height	2.4 m	4.7 m

The data from the measurements made indicate the possibility of the species to develop rapidly in the soil-climatic conditions of the village of Pravda. For 2012, the average height increase is 2.4 m. For 2013 - is 4.7 m, which is double compared to the previous year. No tree pruning was performed for the observed period. This allows tracking their growth from the planting period.

The second site is village of Lyulin. From the soil profile made on site, it was found that the soil is anthropogenic, light loam. By mechanical composition soil is slightly clayey (65.44% physical clay in the surface horizon).

The humus content in the surface horizon characterized it as humus soil - 6.12%. In nitrogen content – 37.7 mg/kg and in phosphorus content – 4.5 mg/kg the soil is poorly stocked. But in potassium content - 23,6 mg / kg, it is well stocked. The soil reaction is slightly alkaline (pH in water 8.1) and carbonates are established over the entire depth of the soil profile. In climatic terms the territory of Lyulin is characterized by temperatures of 10.0 to 10.4 °C. The annual rainfall in 2013 is 433 m and in 2014 it is twice the amount (808 m). As a result of the reported frost in 2013 the leaves froze, which led to their subsequent fall.

Plants in the village of Lyulin are also characterized by rapid growth during the years. The pruning has been performed for the measurement period. The average height increase for 2013 is 0.72 m and for 2014 - 0.24 m. After the pruning at the end of 2013, the plants begin their development from the root. This is also the reason for the lower results during second year of their planting (Table 2). Pruning has been done to ensure faster growth. This is a commonly used method for growing the species for the needs of the forestry industry.

Table 2. Average height (m) of plants in village of Lyulin

Year	2013	2014
Average height	0,72 m	0,24 m

To compare the results, Gyuleva (2010) gives data about the first year of planting the species in different regions of the country. For the territory of Svilengrad there is an average height of one year old plants of 0.57 m. For Karlovo is 0.67 m and for Lukovit is 1.19 m. From the data shown above it is obvious that the increase of the plants in Lyulin is very good. The impression is made by the much larger increase in the village of Pravda, due to the soil and climatic conditions.

Trees planted in 2009 are used for the calculation of the volume of the wood planted in the territory of Dulovo municipality. The main reason for this is that by the third year the trees have a hollow core, making them extremely susceptible to strong winds. The plants from the village of Lyulin have not been calculated because of the pruning at the end of the first year. The average volume of wood was calculated per cubic meter per year per hectare ( $m^3/y/ha$ ). Plants are measured over a three year period (2012-2014). For 2012 the values are 29.0929  $m^3/ha$ . For 2013, the volume is calculated at 27.8820  $m^3/ha$  and for 2014 it is 84.1009  $m^3/ha$ . Some sources point out that under perfect conditions Paulownia starts to give 1 cubic meter of tree wood growth after the seventh-eighth year.

With the help of the observations and the information gathered, three maps were prepared for the territories in Bulgaria suitable for Paulownia breeding. (Figures 1, 2 and 3).



Figure 1. Map of soil-climatic areas with optimal, natural conditions for the development of Paulownia

With all the factors for the development of the plants, the lands along the Struma River and parts of the Sakar Mountain, part of the Arda River and the southern parts of the Black Sea coast.

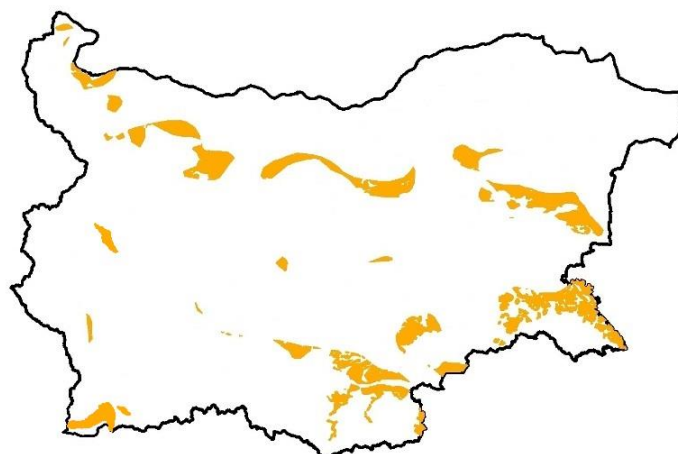


Figure 2. Map of the territories with optimal annual temperature +13,5 °C

When temperature is reduced, there is a greater fragmentation of the Paulownia growing areas. There are parts of southern Bulgaria overlapping with the territories from the first map. Besides them, parts of the Balkan Range and the eastern parts of Stara Planina are also suitable.

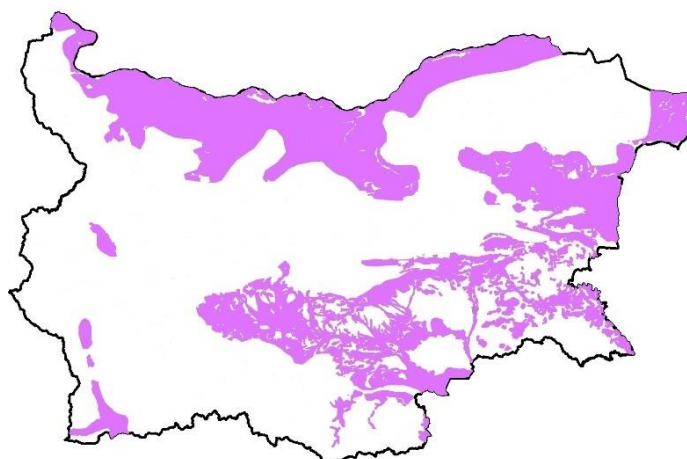


Figure 3. Map of the territories with irrigated conditions

Unlike the first two maps, on the third map there are more territories suitable for Paulownia breeding. Impressive is the territory along the Danube River, as well as the valley of the Osam River. The lands located in the Maritsa and Tundja rivers, as well as almost everywhere along the Black Sea coast, are suitable.

Determining a crop as a honey is dependent on climatic conditions. Higher temperatures allow for a longer flowering period and vice versa - shorter blooms. Nectar in a paulownia color is significantly higher than that in one acacia white color, which is from 1,662 to 8,130 mg (Vachev, Kalmukov, 2005) and from lime-tree is from 1,414 to 10,53 mg (Tsocheva, Vachev, Karmukov, 2007). Plants begin to bloom in the third year. From an economic point of view, it is better to plant the plantations to be used as honeycombs in areas with higher air temperatures (Kalmukov, Vachev, Kanchev, 2016).

From an erosion point of view, it is noted that at the beginning of its development, the culture has poor erosion protection, due to the slow increase in area coverage. When cultivating the species for the harvesting of wood is not allowed the shaping of a powerful crown. The trees are allowed to grow only at a height, thus the only area coverage is from the single leaves located on the stem. Upon growth, these leaves drop and reduce the anti-erosion effect of the culture. Unlike other species paulownia, it can also be grown as a bush species. This allows the formation of more branches and consequently increases the area coverage. An important condition for growing the species for anti-erosion purposes is that the terrain should be appropriate with the requirements of the culture. The lack of key factors for its development could lead to the extinction of planted plants.

In some areas, Paulownia is considered an invasive species. In Europe, it is predominantly limited in man-made habitats (Essl 2007). For the territory of Bulgaria, the species is not defined as invasive. A small pod of Paulownia contains hundreds of small seeds, and since their vitality is always high, only a few pods are required to produce a large number of seedlings. However, climate conditions in Bulgaria do not allow these seeds to spread and set off independently, which is why it is not to be described as invasive.

### **Conclusion**

From the measurements and observations made, it can be noticed that the fast-growing species of Paulovnia can be cultivated for different purposes on the territory of Bulgaria. With its honey-like properties it is suitable for planting near hives. The formation of a large crown and exceptionally beautiful colors are a prerequisite for its cultivation as park vegetation. Its rapid growth, under appropriate conditions, allows it to be cultivated for the forestry industry, and thus could replace slower growing species. The increase in the volume of wood is increased every year, with the average volume of six years of planting being 84.1009 m<sup>3</sup>/ha. From the maps, a repeat of the territories suitable for paulownia cultivation in Bulgaria is observed. Under optimal conditions the lands along the Danube River and the rivers Maritsa and Struma are distinguished. It is precisely this restriction of the appropriate territories that it does not allow it to be included in the list of invasive species for the country. Depending on the way of cultivation, paulownia has the potential to protect the soil from erosion. Its growing in the form of a bush increases the area coverage, thus increasing its protective effect. The species is relatively new and unexplored for the territory of Bulgaria and this necessitates the need for further in-depth research.

## References

- Vachev, P., K.Kalmukov. 2005. Nectar productivity and honey productivity of some species of white share (*Robinia pseudoacacia* L.) *Acta entomologica Bulgarica*. Vol. 11, № 3-4, 79- 85.
- Gyuleva V., Maria Glushkova, Katya Velinova, Proletka Dimitrova, Ecological-biological Peculiarities of Some Paulownia Species Growing in Bulgaria and Prevention of Potential Negative Consequence for Environment, Forest Research Institute, BAS, 132 Kliment Ohridski Str. 1756 Sofia, Bulgaria.
- Essl F. (2007) From ornamental to detrimental? The incipient invasion of Central Europe by *Paulownia tomentosa*. *Preslia* 79(4): 377-389.
- Kalmukov, K., Effect of Initial Density on Condition and Growth of *Paulownia tomentosa* L., Experimental Station for Rapid Forest-like Species, 5250 Svishtov, Bulgaria, 2009.
- Kalmukov, K., P. Vachev, G. Kanchev. Nectar productivity, sucrose productivity, and honey productivity of *paulownia tomentosa* l. *Science & Technologies: Volume VI*, 2016.
- Lawrence, James S., *Paulownia technical bulletin #1, #2*, 23 September 2011
- Mueller, J.P., J.M. Luginbuhl, and B.A. Bergmann. 2001. Establishment and early growth characteristics of six *Paulownia* genotypes for goat browse in Raleigh, NC, USA. *Agroforestry Systems* 52:63-72.
- Tsocheva, K., P.Vachev, K.Kalmukov, 2007, Evaluation of the effects of *Tilia platyphillos* and *Tilia cordata* on the variation of color nectro-productiveness, nectar sugar concentration and number of flowers in one inflorescence. *Acta entomologica Bulgarica*, vol ,13,№ 1,2 ,83-90.

## **ECO-BIOLOGICAL CHARACTERISTICS OF MEDICINAL PLANTS IN PROTECTION ZONE "YAZOVIR KONUSH" VILLAGE KONUSH (BULGARIA)**

Stoyan GEORGIEV<sup>1\*</sup>, Koycho KOEV<sup>2</sup>, Alexander TASHEV<sup>3</sup>

<sup>1</sup>Field Crops Institute - Chirpan, 2 Georgi Dimitrov Blvd, 6200 Chirpan, Bulgaria

<sup>2</sup>University of Plovdiv, Faculty of Biology, 24 Tsar Assen Str., 4000 Plovdiv, Bulgaria

<sup>3</sup>Forestry University, Faculty of Forestry, 10 Kliment Ohridski Blvd, 1756 Sofia, Bulgaria

\*Corresponding author: stogeorgiev@abv.bg

### **Abstract**

The present study examines the medical plants in the protected zone “Yazovir Konush”, Konush village in the region of Plovdiv in Bulgaria. Eco-biological characteristic of the medical plants is made, and the species are categorized by biological groups, by life forms, by floral elements, and by time of flowering. The plants are classified by ecological groups according their regard towards the water, the light and the heat as a factor. Conclusions for the presence by percentage of medicinal flora in the protected zone are made. The research held in the period 2012-2014 of the medicinal plants in protected zone “Yazovir Konush” shows that there are 100 species plants from 82 genera and 40 families. Among these plants the majority are the perennial herbaceous species, the hemicryptophytes, the species with European and Mediterranean origin, the thermophytes, the mezophytes and the heliophytes.

**Keywords:** *Protected zone “Yazovir Konush”, NATURE 2000, medical flora.*

### **Introduction**

The subject of the research is the medical plants in the PZ “Yazovir Konush”, village of Konush, municipality of Asenovgrad (0.376 ha), located in the Upper Thracian Plane in Bulgaria. The protected area is stated with Order № RD-367/ 16.06.2008 from Ministry of Environment and Water (MOEW) aiming to protect and support the habitats of the bird species, included in the Law for the biological diversity and restoring the habitats of these species. The protected zone is located in the field of Plovdiv of the Upper Thracian Plain. According to phytogeographical subdivision (Bondev 1991) the territory of the commented object is at the borders of the floristic region Thracian Plain. According to the physiographic division of Bulgaria (Galabov 1982) the examined territory falls in the Kraishtensko – Tundjanska (transitional) zone, region of the upper Thracian Plain, in the Western sub-region which is in the field of Plovdiv. Based on the climatic zoning of the country (Galabov 1982) the territory of the PZ “Yazovir Konush”, is in the Eastern Thracian sub-region of the climatic region of Eastern Central Bulgaria, Transitional – continental climatic sub-region of the European –continental climatic region. It is characterized with relatively mild winter and hot summer, with well-defined drought especially in the months August-September, which are the driest months of the year. The average annual rainfall is 551 l/km<sup>2</sup>, which defines the area as a place with little annual rainfall (Galabov 1982). The average annual temperature is around 12.1 °C, which matches the indicated temperature for the country between 11 and 12 °C (Galabov 1982). The average air humidity is 72% and matches the average for the country (Galabov 1982). The soils are mainly alluvial meadows, where at some places are mixed with clay and black resinous.

The purpose of the current research is to create a list and to make floristic analysis and ecological and biological characteristic of the medical plants (MP) within the borders of the protected zone (PZ) “Yazovir Konush”, village of Konush in the region of Plovdiv.

### Material and Methods

The diversity of medicinal flora in PZ “Yazovir Konush” is studied by systematic observations and collecting of material during the vegetative seasons of 2012-2014. The periodicity of the visits is conformed to the climatic conditions in the region and the determined by their phyto-rhythmic. The earliest aggregates are form the beginning of February 2012, and the latest – from the end of September 2014. This allows the most complete taxonomic diversity of the medicinal flora in the reserve and its seasonal dynamics. The determination of the species is made by means of Flora of Bulgaria (Yordanov, edit. 1963-1979; Velchev, edit. 1982-1989), Flora of Bulgaria (Kozhuharov 1995), and Flora of Bulgaria (Stoyanov et al. 1966-1967, Identifier of Trees and Shrubs in Bulgaria (Gramatikov 1992), Identifier of Plants in Bulgaria (Delipavlov, Cheshmedzhiev edit. 2011). The processing of herbarium materials and characteristics of medicinal flora were carried out by standard methods (Gusev et al., 2004). Characteristic of medicinal plants was done according to biological types and life forms of Raunkiaer (1934). Floral elements were characterized by the classification of B. Stefanov (1943) and the adapted to the flora of Bulgaria classification of Walter (Asyov, Petrova 2012). The identified taxa are divided into ecological groups in terms of the most important ecological factors – water, temperature and light. An account and analysis of the flowering period for all identified species were done. The names of the plants are by The Euro + Med PlantBase – the information resource for Euro-Mediterranean plant diversity (2011), Identifier of Plants in Bulgaria (Delipavlov, Cheshmedzhiev 2011).

### Results and Discussion

The results from the resent analysis summarize the data from the terrain researches according to the project “ Suggestion for preparing a plan for control of the protected zone “Yazovir Konush” (Contract № 5113123-C-001 for grant by Operative Program “Nature 2007 – 2013”, Co-financed by the European fund for regional development and by the Cohesion fund of the European Union). Based on the literature analysis of publications for medical plants of Bulgarian flora (Annex 1 to the Law for medical plants, 200, 2006; Nikolov, 2007; Tashev, Tsavkov 2008, Landjev, 2010; Delipavlov, Cheshmedjiev edit. 2011), was established that in PZ “Yazovir Konush” there are 100 species of medical plants from 82 genera and 40 families, which is 2.8% from the species, 9.8% from the genera and 33.3% from the families in the Bulgarian flora (Asiova, Petrova 2012). Systematic list of the medical plants in PZ “Yazovir Konush”

#### Liliopsida

Alliaceae: *Allium rotundum* L.; Butomaceae: *Butomus umbellatus* L.; Iridaceae: *Iris pseudacorus* L.; Poaceae: *Cynodon dactylon* (L.)Pers.; Typhaceae: *Typha angustifolia* L., *Typha latifolia* L.

#### Magnoliopsida

Aceraceae: *Acer tataricum* L.; Apiaceae: *Eryngium campestre* L.; Asteraceae: *Achillea millefolium* L., *Arctium minus* (Hill) Bernh., *Artemisia vulgaris* L., *Carduus acantoides* L., *Carlina vulgaris* L., *Centaurea calcitrapa* L., *Centaurea solstitialis* L., *Chamomilla recutita* (L.) Rauschert, *Cichorium intybus* L., *Inula germanica* L., *Lactuca serriola* L., *Matricaria trichophylla* (Boiss.) Boiss., *Taraxacum officinale* Weber, *Tragopogon pratensis* L., *Tussilago farfara* L.; Aristolochiaceae: *Aristolochia clematitis* L.; Boraginaceae: *Anchusa*

*officinalis* L., *Echium italicum* L.; Brassicaceae: *Brassica nigra* (L.) Koch, *Capsella bursa-pastoris* (L.) Medic., *Rorippa sylvestris* (L.) Besser, *Thlaspi arvense* L.; Cannabaceae: *Cannabis sativa* L., *Humulus lupulus* L.; Caprifoliaceae: *Sambucus ebulus* L., *Sambucus nigra* L.; Caryophyllaceae: *Stellaria media* (L.) Vill.; Chenopodiaceae: *Chenopodium album* L.; Convolvulaceae: *Convolvulus arvensis* L.; Cornaceae: *Cornus sanguinea* L.; Fabaceae: *Lotus corniculatus* L., *Melilotus alba* Medic., *Melilotus officinalis* (L.) Pallas, *Trifolium pratense* L., *Trifolium repens* L., *Vicia cracca* L., *Vicia grandiflora* Scop.; Fagaceae: *Quercus robur* L.; Fumariaceae: *Fumaria officinalis* L.; Geraniaceae: *Erodium cicutarium* (L.) L'Her; Hypericaceae: *Hypericum perforatum* L.; Lamiaceae: *Acinos suaveolens* (Sibth. & Sm.) G. Don f., *Ajuga chia* Schreber, *Ajuga reptans* L., *Ballota nigra* L., *Betonica officinalis* L., *Clinopodium vulgare* L., *Glechoma hederacea* L., *Lamium purpureum* L., *Mentha aquatica* L., *Mentha pulegium* L., *Salvia aethiopsis* L., *Salvia nemorosa* L., *Teucrium chamaedrys* L., *Teucrium polium* L., *Thymus pannonicus* All.; Lythraceae: *Lythrum salicaria* L., *Lythrum vibratum* L.; Malvaceae: *Malva sylvestris* L.; Papaveraceae: *Papaver rhoeas* L.; Plantaginaceae: *Plantago lanceolata* L., *Plantago major* L.; Polygonaceae: *Persicaria hydropiper* (L.) Opiz, *Polygonum aviculare* L., *Rumex crispus* L.; Primulaceae: *Lysimachia nummularia* L.; Ranunculaceae: *Clematis vitalba* L., *Consolida hispanica* (Costa) Greuter & Burder, *Consolida regalis* S.F.Gray, *Ranunculus repens* L., *Ranunculus sceleratus* L.; Resedaceae: *Reseda inodora* Reichenb.; Rosaceae: *Agrimonia eupatoria* L., *Crataegus monogyna* Jacq., *Geum urbanum* L., *Potentilla argentea* L., *Potentilla reptans* L., *Rosa canina* L., *Rubus caesius* L.; Rubiaceae: *Galium aparine* L., *Galium verum* L.; Salicaceae: *Salix alba* L., *Salix fragilis* L.; Scrophulariaceae: *Veronica anagallis-aquatica* L.; Solanaceae: *Datura stramonium* L., *Hyoscyamus niger* L., *Solanum dulcamara* L., *Solanum nigrum* L.; Ulmaceae: *Ulmus minor* Miller; Urticaceae: *Urtica dioica* L.; Verbenaceae: *Verbena officinalis* L.; Zygophyllaceae: *Tribulus terrestris* L.

These plants resemble 13.4% from all species included in Annex 1 to the Law for the medical plants (200, 2006). All species belong to Magnoliophyta division. From the seed plants in the area 6 species belong to Class Liliopsida, distributed into 5 genera and 5 families, and the rest 96 species belong to Class Magnoliopsida, distributed into 77 genera and 35 families. Richest in medical species families in the PZ are: Asteraceae and Lamiaceae with 15 species, Fabaceae with 8 species and Rosaceae with 7 species. The distribution of the taxon according to biological types shows that with the most significant presence are the perennial herbaceous species – 51 or 51. 0% of all the medical plants, followed by the annual- 18 species (18. 0%), trees and shrubs with 4 species (4.0 %) each. The rest of the species belong to the transitional biological types (Table 1).

Table 1. Distribution of the medical plants from PZ “Yazovir Konush” according to biological types

Biological type	Number of taxa	% from MP in PZ “Yazovir Konush”
tree	4	4
tree-shrub	1	1
shrub-tree	2	2
shrub	4	4
perennial	51	51
biennial-perennial	5	5
biennial	5	5
annual-perennial	2	2
annual-biennial	9	9
annual	18	18
<b>Total</b>	<b>100</b>	<b>100</b>



According to the biological spectrum of the studied species, most are hemicryptophytes (H) – 46 species or 46.0 % of the total number of plants in the protected area, followed by therophytes (Th) – 18 species (18.0 %) , phanerophytes (Ph)– 10 species (10.0 %), cryptophytes (Cr) – 5 species (5.0 %) and chamephytes (Ch) which are only 1 species (1.0 %). The remaining species are of transitional life forms – among them the most – 12 species (12.0 %) are these which can be hemicryptophytes or therophytes (H-Th), depending on the habitat conditions. The distribution of medical plants in phytogeographic centers according to the classification of B. Stefanov (1943) shows that the greatest part – 45.0 % are thermophytes from the Southern Continental Center, followed by the thermophytes from the Northern Continental Center – 28.0%, the mesotherms of Silvo boreal Center - with 13.0%, thermophytes and mesotherms from the Mountainous Center – 11.0 %, plants from other phytogeographic centers – 2.0 %, and least are the thermophytes from Mediterranean Centre – 1.0 %. According to their mobility the analyzed plants are distributed as follows: the stationary species 12 (12.0 %), the moving ones with secondary expanded areas – 33 species (33.0 %) and the species that have appeared by secondary displacement – 55 plants (55.0 %) (Stefanov, 1943). These data is evidence of significant anthropogenic interference within the territory of the reserve in the past. Analyzing medical plants by floral elements, distributed according to the classification of Walter, shows that geo-elements with European component – 51 species or 51.0 % are the greatest part, as among them most are Euro-Asian (*Eur-As*) –22 species (22.0 %), Euro Mediterranean (*Eur-Med*) – 16 species (16.0 %), Euro-Siberian (*Eur-Sib*) with 6 species (6.0 %), European (*Eur*) – 5 species (5.0 %) and Euro-Tuman – 2 species (2.0 %). Second is the group of species with Mediterranean component - 34 species or 34.0 %, among them most are Euro Mediterranean (*Eur-Med*) with 16 species (16.0 %), followed by sub-Mediterranean (*subMed*) with 11 species (11.0 %), Pontic-Mediterranean (*Pont-Med*) – 4 species (4 %), and Mediterranean (*Med*) – 3 species (3.0 %). There is a large amount of Cosmopolitan (*Kos*) plants – 15 species (15.0 %) (Table 2).

Table 2. Distribution of the medical plants from PZ “Yazovir Konush” by floral elements according to the adapted classification of Walter (Asyov and Petrova 2012).

Floral elements by Walter (2012)	Number of taxa	% from MP in PZ “Yazovir Konush”
<i>Adv</i>	2	2
<i>Boreal</i>	5	5
<i>Eur</i>	5	5
<i>Eur-As</i>	22	22
<i>Eur-Med</i>	16	16
<i>Eur-OT</i>	2	2
<i>Eur-Sib</i>	6	6
<i>Kos</i>	15	15
<i>Med</i>	3	3
<i>Pont</i>	1	1
<i>Pont-Med</i>	4	4
<i>subBoreal</i>	8	8
<i>subMed</i>	11	11
Total	100	100

The distribution of the studied plants according to their period of flowering shows that the most active period is from May to July. During this period 95 taxa blossom, 95.0 % of all the plants. Among them, most species blossom in June-August – 17 species, May-August and June-September – 13 species each, May-June and May-September – 7 species each etc.

The fact that the greater part of PZ “Yazovir Konush” is watercourse determines the presence of waterfowl species. So among the medical plants in the explored area dominating are the mezophytes with 54 species (54.0 %), followed by the hygrophytes and xerophytes with 12 species (12.0 %) each, xeromezophytes – 7 species (7.0%), hygromezophytes and mezohygrophytes with 6 species each (6.0%). 3 species (3.0 %) can be related to the hydrophytes.

The analysis of the medical plants distribution in terms of the light factor shows prevalence of heliophytes that are most of the species (96 %), and the rest are hemi-schyphytes (6.0%) as there are no schyphytes.

According to their relation to heat the species are divided into only 2 groups. Thermophytes go to the bigger group with 84 species (84.0 %), and the rest 16 species (16.0 %) refer to the group of mesotherms. The dominance of thermophilic species is directly related to the influence of the Mediterranean climate, penetrating along the Maritsa River (Galabov, 1982).

### **Conclusion**

The research held in the period 2012-2014 of the medicinal plants in PZ “Yazovir Konush” shows that there are 100 species plants from 82 genera and 40 families. Among these plants the majority are the perennial herbaceous species, the hemicryptophytes, the species with European and Mediterranean origin, the thermophytes, the mezophytes and the heliophytes which mainly blossom in the period May-July. The comparatively big participation of secondary and cosmopolite plants within the borders of the examined area is evidence for the considerable anthropogenic interference in the processes occurring in the plant cover of the protected area. There are plenty different plant groups according to the water as a factor, which is evidence for the existence of different types of habitats within the borders of the examined territory. This fact increases the ecological importance of the PZ “Yazovir Konush”.

### **References**

- Asyov, B., Petrova, A. (edit.). 2012. Synopsis of the Higher Flora of Bulgaria. Chorological and Floristic Elements. BFB. Sofia.
- Bondev, I. 1991. The Vegetation of Bulgaria, map scale 1: 600 000 with explanatory text. BAS, Sofia.
- Velchev, V. (edit.) 1982-1989. Flora of NR Bulgaria. Vol. 8, 9. BAS. Sofia.
- Delipavlov, D., I. Cheshmedziev, M. Popova, D. Terziiska, I. Kovachev. 2011. Identifier of Plants in Bulgaria. Academic Press, Agriculture University. Plovdiv.
- Gramaticov, D., 1992. Identifier of Trees and Shrubs in Bulgaria. Intelsys, Plovdiv.
- Gusev, Ch., Bancheva, S., Dimitrov, D., Denchev, D., Pavlova, Ts., Koeva, Y., Patronov, D. 2004. Floristics Characteristics of the Biosphere Reserve Uzunbudzhak of Strandja. Nature Park Strandja. Sofia – Malko Tarnovo.
- Galabov, Zh., (edit.). 1982 Geography of Bulgaria. Physical Geography. BAS. Sofia.
- Law on Medicinal Plants in Bulgaria. 2000, 2006. State gazette 29/07.04.2000 ., 9-21 ch. State gazette 65/2006
- Yordanov, D., (edit.) 1963-1979 Flora of R Bulgaria. Vol. 1-7. BAS. Sofia
- Kozuharov, S., (edit.) 1995 Flora of Bulgaria. Vol. 10. BAS. Sofia.
- Landjev, I. 2010. Encyclopedia of the medical plants in Bulgaria. Edit. Trud, Sofia.
- Nikolov, S. (edit.). 2007. Specialized Encyclopedia of Medicinal Plants in Bulgaria. Trud. Sofia.
- Stefanov, B. 1943. Phytogeographic Elements in Bulgaria. Knipegraf. Sofia. 509 p

- Stoyanov, N., Stefanov, B., Kitanov, B. 1966-1967. Flora of Bulgaria. Vol. 1-2. Art and Sciences. Sofia.
- Raunkiaer, C. 1934. The Life Forms of Plant and Statistical Plant Geography. Oxford: Clarendon.
- Tashev A., Tsavkov E. 2008. Medicinal plants of the Bulgarian dendroflora. – *Phytologia Balcanica*, 14(2): 269-278.
- The Euro + Med PlantBase – the information resource for Euro-Mediterranean plant diversity. 2011. Available online at: <http://ww2.bgbm.org/EuroPlusMed/query.asp>

## COMPARISON OF MULTIVARIATE CALIBRATION METHODS FOR PREDICTING SOIL ORGANIC CARBON WITH VIS-NIR SPECTROSCOPY

Boško MILOŠ<sup>1</sup>, Aleksandra BENSA<sup>2\*</sup>

<sup>1</sup>Institute for Adriatic Crops and Karst Reclamation, Put Duilova 11, 21 000 Split, Croatia

<sup>2</sup>University of Zagreb, Faculty of Agriculture, Svetošimunska 25, 10 000 Zagreb, Croatia

\*Corresponding author: abensa@agr.hr

### Abstract

This study aimed to compare four different regression methods, including partial least squares regression (PLSR), principal component regression (PCR), boosted regression trees (BRT) and support vector machines regression (SVMR) for predicting organic carbon content in soil samples with visible-infrared (Vis-NIR) diffuse reflectance spectroscopy (DRS). The reflectance spectra of a total of 238 topsoils (0-25 cm) heterogeneous samples were measured in a laboratory using a portable Terra Spec 4 Hi-Res Mineral Spectrometer with a wavelength range of 350-2500 nm. The analysed soils belong to various soil types used in agricultural production with SOC content ranging from 0.29 to 37.50 g C kg<sup>-1</sup>. The estimation accuracy was determined with the coefficient of determination (R<sup>2</sup>), the ratio of performance to deviation (RPD) and the root mean square error of prediction (RMSEP). The results of this study showed that the SVMR and the PLSR models obtained good predictions for soil organic carbon with R<sup>2</sup> values of 0.87 and 0.86, RMSEP 2.48 and 2.58 g C kg<sup>-1</sup> and RPD values of 2.5 and 2.4, respectively. The PCR and BRT showed a noticeable decrease in prediction accuracy with R<sup>2</sup> values of 0.77 and 0.72, RMSEP 3.49 and 3.71 g C kg<sup>-1</sup> and RPD values of 1.6 and 1.5, respectively indicating fair predictions. Our study confirmed the potential of Vis-NIR spectroscopy for estimation of SOC content and showed that the estimation accuracy of the analysed calibration methods decreased in the following order: SVMR>PLSR>PCR>BRT.

**Key words:** *BRT, Chemometrics, PCR, PLSR, SVMR*

### Introduction

Soil organic carbon (SOC) has a leading part in maintaining soil quality since it affects the chemical, physical and biological processes in soil. Thus, there is growing need for a large amount of precise data on its content, in order to improve soil/land management. Classical analytical methods are expensive, time-consuming and resulting in the disposal of toxic chemicals harmful to the environment. Diffuse reflectance spectroscopy (DRS) is a rapid, non-destructive and eco-friendly method, which offers a cheaper solution in the estimation of SOC content. The most commonly analysed part of reflectance spectrum is visible and near-infrared (Vis-NIR, 350-2500 nm). Diffuse reflectance measurements of soil have spectral activity throughout the entire spectral region and it characterises complex absorption patterns. The soil spectra hold large numbers of the predictor variables that are highly collinear and therefore analyses of diffuse reflectance spectra require the use of multivariate calibrations (Martens and Naes, 1989). The correlation between SOC content and reflectance measurements have been investigated using various multivariate chemometrics techniques and pre-processing transformations.

The selection of a calibration method is one of the main factors influencing measurement accuracy with Vis-NIR spectroscopy (Gao et al. 2014). The most common calibration method for analyses of soil spectra is partial least square regression (PLSR), developed by Wold

(1985). However, other widespread regression methods have been used, i.e. principal component regression (PCR) by Chang et al. (2001) and Viscarra Rossel and Behrens (2010), support vector machines regression (SVMR) by Stevens et al. (2010 and 2013), Viscarra Rossel and Behrens (2010) and Gao et al. (2014), boosted regression trees by Brown et al. (2006), Viscarra Rossel and Behrens (2010) and artificial neural networks (ANN) by Brown et al. (2006) as well as many others.

The aim of this study was to compare four different regression methods, including partial least squares regression (PLSR), principal component regression (PCR), boosted regression trees (BRT) and support vector machines regression (SVMR) to find the most accurate method for SOC prediction in sample set collected in the various agricultural soils from Mediterranean part of Croatia.

### **Material and methods**

In this paper, we used the SOC content determined with the Kotzman method (JDPZ, 1966) and Vis-NIR reflectance measurements for a total of 238 topsoil samples selected from a Soil Spectral library from Dalmatia (Miloš, 2013). Soil samples were collected in the agricultural areas of Split-Dalmatia County centred at 43° 30'N and 16° 26'E. According to the World Reference Base for soil resources (IUSS, WRB 2014), selected soils are classified as Calcic, Chromic and Rhodic Cambisols, Rendzic Leptosols and Regosols (not Lithic). The climate of this area is characterised by dry, hot summers and mild, moderately rainy winters. Agricultural areas are typical Mediterranean including olive groves, vineyards, fruit orchards and abandoned agricultural land. The reflectance spectra of soil samples were measured in a laboratory using a portable Terra Spec 4 Hi-Res Mineral Spectrometer (Analytical Spectral Devices, Boulder, CO, USA) with a wavelength range of 350-2500 nm. The original soil spectrum recorded at 1 nm interval wavelengths was resampled at every 5 nm over the „full“ spectral range. Pre-processing transformations of the original spectra were performed using Savitzky-Golay first derivative and smoothing (Savitzky and Golay, 1964) with a second order polynomial fit.

We compared four methods to derive SOC calibration and validation predicting models including partial least squares regression (PLSR), principal component regression (PCR), boosted regression trees (BRT) and support vector machines regression (SVMR). The PLSR and PCR are a multivariate regression analysis technique used to construct predictive models when there are large numbers of predictor variables that are highly collinear. These methods are based on a linear transition of a large number of original descriptors to a small number of new predictors (components or orthogonal factors). In contrast to PCR, the PLSR creates components taking into account the response variable resulting in models that are able to fit on the response variable with fewer components. So, the PLSR, introduced by Wold (1985), has become a standard tool in chemometrics and the most commonly-used calibration method for estimation soil properties using diffuse reflectance spectroscopy. We used the PLSR and PCR with leave-one-out cross-validation method (Efron and Tibshirani, 1994) for calibrating the reflectance spectra and construction of SOC prediction model. For more details on the PLSR see eg. Martens and Naes (1989), Wold (1985), Wold et al. (2001) and for the PCR Jackson (1991).

The boosting regression tree (BRT) is a machine learning technique developed by Friedman (1999a and 1999b). The general idea of this regression method is to compute many very simple models (trees) and derives weights for combining simple models into a single highly accurate prediction model. The support vector machines regression (SVMR) is regression method based on statistical learning algorithms (Vapnik, 1995). Detailed discussions of these techniques are given in Hastie et al. (2001).

The accuracy of the SOC models was evaluated by calculating the root mean square error (RMSE), the ratio of performance to deviation (RPD) and the coefficient of determination ( $R^2$ ). The RMSE is defined as the square root of the average of squared differences between predicted and measured Y values and evaluated with equation:

$$RMSE = \sqrt{\sum_{i=1}^N \frac{(\hat{y}_i - y_i)^2}{N}}$$

where  $y_i$  and  $\hat{y}_i$  are the measured and predicted values of sample  $i$ , respectively, and  $N$  is the number of samples. The RPD was initially used by Williams (1987). It represents the division between the standard deviation (SD) of the validation dataset and the standard error of the prediction (SEP) and deduced with relation:

$$RPD = SD / SEP$$

To interpret RPD values we adopted the interpretations given by Chang et al. (2001) as follows: models with  $RPD \geq 2$  are considered as ‘good’, models with  $1.4 \leq RPD < 2$  predict ‘fairly’, while models with  $RPD < 1.4$  predict ‘poorly’. To interpret  $R^2$  values we adopted threshold values given by Saeys et al. (2005) as follows: a value for  $R^2$  between 0.66 and 0.81 indicates approximate quantitative prediction,  $R^2$  between 0.82 and 0.90 reveals good prediction and  $R^2 > 0.91$  is considered to be an excellent prediction.

## Results and discussion

The descriptive statistics for the reference dataset (SOC content analysed using conventional laboratory method), calibration and validation datasets for different regression methods is given in Table 1. The SOC content for the reference dataset varies from 0.29 to 37.50 g C kg<sup>-1</sup> with an average value of 17.74 g C kg<sup>-1</sup> (Table 1). The negatively skewed distributions for the reference, BRT and SVMR calibration, and BRT validation datasets indicate approximately symmetrical distributions. The PLSR and PCR regression models indicate a slightly asymmetrical distribution with a long tail to the left.

Table 1 Statistical description of the soil organic carbon content (g kg<sup>-1</sup>) for the reference, calibration and validation datasets for different regression methods

Statistics	Reference	Calibration				Validation			
		PLSR	PCR	SVMR	BRT	PLSR	PCR	SVMR	BRT
Mean	17.74	17.74	17.75	17.92	16.65	17.76	17.78	17.65	17.39
Minimum	0.29	0.50	0.22	1.95	3.65	0.51	0.61	0.35	4.22
Maximum	37.50	37.29	32.00	35.64	35.29	36.61	30.68	37.72	29.25
Range	37.21	36.79	31.78	33.69	31.64	36.10	30.07	37.37	25.03
Std.Dev.	6.80	6.39	5.76	5.95	6.43	6.15	5.63	6.28	5.70
Skewness	-0.27	-0.72	-0.68	-0.49	-0.31	-0.79	-0.68	-0.12	-0.24

PLSR - partial least squares regression, PCR - principal component regression, BRT - boosted regression trees, SVMR - support vector machines regression

Figure 1 shows the mean reflectance spectra and the mean first-derivative spectra of 238 soil samples that were used to develop SOC models. The mean reflectance spectra (Figure 1a) in the visible spectrum shows a continual increase in reflectance with increasing wavelength, while in the NIR spectrum has several characteristic absorptions around 1400, 1900 and 2200 nm due to water molecule vibrations and OH<sup>-</sup> groups (1400 nm), water (1900 nm) and mineral influences (2200 nm). The mean first-derivative of the SOC reflectance spectra (Figure 1b) is characterised with a broad spectral range from 540 to 580 nm, with the maximum peak at 565 nm in the visible range due to chromophorous constituents, mainly iron oxide (Ben-Dor et al.

1999). Furthermore, this spectrum shows several important absorptions around 1400 nm, 1900 nm, a broad adsorption region between 2165 nm and 2200 nm and the absorption peak located around 2340 nm corresponding to CO<sub>3</sub> overtone vibrations (Viscarra Rossel and Behrens 2010).

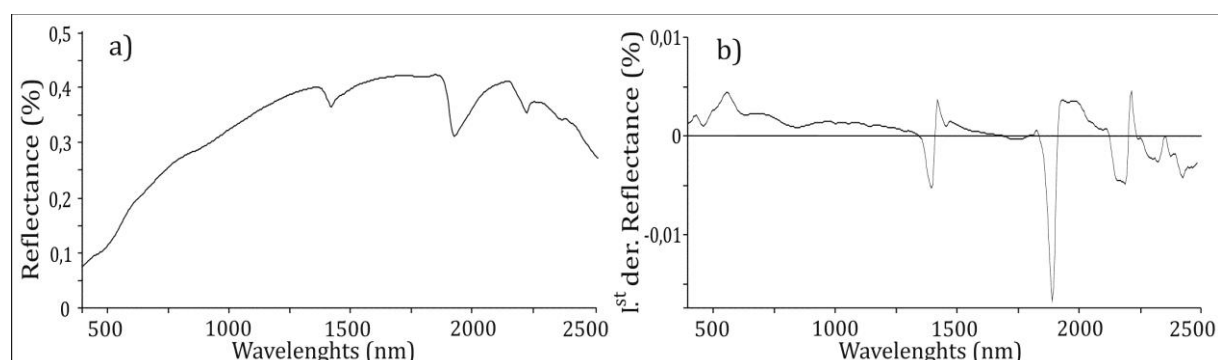


Figure 1. Original (a) and first derivative (b) Vis-NIR spectra of the 238 soil samples

Calibration and validation results of the SOC models diagnostics for the different regression methods are given in Table 2. The best prediction of the SOC was obtained using the SVMR method which revealed the highest R<sup>2</sup> and RPD values of 0.87 and 2.5 respectively, as well as the lowest RMSEP of 2.48 g C kg<sup>-1</sup>. The PLSR model showed similar performances with slightly higher RMSEP and lower values of R<sup>2</sup> and RPD (Table 2).

Table 2 Calibration and validation results of the SOC models diagnostics for the different regression methods

Regression method	Calibration		Validation		
	R <sup>2</sup>	RMSEC	R <sup>2</sup>	RMSEP	RPD
PLSR	0.90	2.32	0.86	2.58	2.4
PCR	0.81	3.27	0.77	3.49	1.6
SVMR	0.92	1.97	0.87	2.48	2.5
BRT	0.87	2.51	0.72	3.71	1.5

Two other methods (PCR and BRT) showed a noticeable decrease in prediction accuracy compared to the best accurate method (SVMR), with the PCR performing somewhat better than the BRT. The performance of the SVMR SOC prediction model was much better than the BRT, as R<sup>2</sup> was increased for 20.8% and RPD for 60.0%, while RMSEP was decreased for 1.23 g C kg<sup>-1</sup>, Table 2. According to the threshold values for the coefficient of determination (R<sup>2</sup>) given by Saeys et al. (2005), the SOC models developed using the SVMR and PLSR reveal good prediction, while the PCR and BRT models indicated an approximate quantitative prediction of the SOC. According to Chang et al. (2001), the RPD values >2.0 for the SVMR and PLSR methods (Table 2) indicate good prediction, while RPD values between 1.4 and 2.0 for the PCR and BRT indicate “fairly” prediction.

Our results are consistent with the study of Viscarra Rossel and Behrens (2010) that found the decline of prediction accuracy for the SOC content in the following order: SVMR>PLSR>BRT with R<sup>2</sup> values of 0.84, 0.82 and 0.62 respectively. Gao et al. (2014) showed that the SVMR model with an average RMSE of 2.45 g C kg<sup>-1</sup> provided a more robust performance than the PLSR which had a larger average RMSE of 2.95 g C kg<sup>-1</sup>. Peng et al. (2014) also found that SVMR model was superior to PLSR model. The both their models (SVMR and PLSR) have achieved lower accuracy compared to our results (R<sup>2</sup> 0.73 and 0.62; RPD 1.89 and 1.63 respectively). Luca et al. (2017) showed that SVMR model outperformed PCR and PLSR models with higher R<sup>2</sup> and lower RMSEP. Contrary, Nawar et al. (2016)

found better prediction accuracy for SOC content with PLSR method ( $R^2$  0.72 and RPD 1.70) compared to SVMR ( $R^2$  0.64 and RPD 1.67). Vohland et al. (2011) established rather small differences between SVMR and PLSR models which both provided reliable estimates with  $R^2$  above 0.85 and RPD above 2.5. Stevens et al. (2010) compared the PLSR and SVMR methods for the SOC predictions on the global and regional scale and showed that SVMR performed better for the global dataset, while the PLSR achieved better accuracy for the regional datasets. Vasquez et al. (2008) established that PLSR method outperformed PCR based on mean  $R^2$  (0.82 and 0.76 respectively) and RPD values for 30 different pre-processing techniques (2.37 and 2.08 respectively).

### **Conclusion**

The SVMR and PLSR models obtained good SOC predictions with similar  $R^2$  values of 0.87 and 0.86 and RPD values of 2.5 and 2.4 respectively. The PCR and BRT models with  $1.4 \leq RPD < 2$  indicated „fairly“ SOC content prediction. Our study (i) confirmed the potential of the Vis-NIR spectroscopy for estimation of SOC content in the various agricultural soils from Mediterranean part of Croatia and (ii) showed that the estimation accuracy of used calibration methods for the prediction decreased in the following order: SVMR>PLSR>PCR>BRT.

### **Reference**

- Ben-Dor E., Irons J., Epema G. (1999). Soil Reflectance. Remote Sensing for the Earth Sciences In Manual of Remote Sensing. Rencz, A.N. (ed), Vol. 3: pp. 111–188.
- Brown, D.J., Shepherd, K.D., Walsh, M.G., Dewayne Mays, M., Reinsch, T.G., (2006). Global soil characterization with VNIR diffuse reflectance spectroscopy. *Geoderma* 132, 273–290
- Chang C.W., Laird D.A., Mausbach, M.J., Hurburgh Jr., C.R. (2001). Near-infrared reflectance spectroscopy–principal components regression analysis of soil properties. *Soil Science Society of America Journal* 65, 480–490
- Efron B., Tibshirani R.J. (1994). An introduction to the Bootstrap. Monographs on Statistics and Applied Probability, Vol. 57. CRC. Press, p. 436.
- Friedman, J. H. (1999a). Greedy function approximation: A gradient boosting machine. IMS 1999 Reitz Lecture.
- Friedman, J. H. (1999b). Stochastic gradient boosting. Stanford.
- Gao Y., Cui L., Lei B., Zhai Y., Shi T., Wang J., Chen Y., He H., Wu G. (2014). Estimating Soil Organic Carbon Content with Visible-Near-Infrared (Vis-NIR) Spectroscopy. *Applied Spectroscopy* Vol. 68, No. 7, 712-722
- Hastie, T., Tibshirani, R., Friedman, J. H. (2001). The elements of statistical learning: Data mining, inference, and prediction. New York: Springer-Verlag.
- IUSS Working Group WRB (2014). World Reference Base for Soil Resources 2014. World Soil Resources Reports No. 106, FAO, Rome.
- Jackson J.E. (1991). A Users Guide to Principal Components, Wiley & Sons Inc., New York.
- JDPZ (1966). Chemical methods for soil analysis, Beograd (in Croatian).
- Luca F., Conforti M., Castrignano A., Buttafuoco G. (2017). Effect of calibration set size on prediction at local scale of soil carbon by Vis-NIR spectroscopy, *Geoderma* 288; 175-183
- Martens H., Næs T. (1989). Multivariate Calibration”, John Wiley & Sons, Inc, New York 504 p.
- Miloš B. (2013). Spectral library of soils from Dalmatia. Institute for Adriatic Crops and Karst Reclamation. Split, Croatia.



- Nawar S., Buddenbaum H., Hill J., Kozak J., Mouazen A.M. (2016). Estimating the soil clay content and organic matter by means of different calibration methods of Vis-NIR diffuse reflectance spectroscopy, *Soil & Tillage Research* 155, 510-522
- Peng X., Shi T., Song A., Chen Y., Gao W. (2016). Estimating Soil Organic Carbon Using VIS/NIR Spectroscopy with SVMR and SPA Methods, *Remote Sensing* 2014, 6, 2699-2717
- Saeyns W, Mouazen A.M., Ramon H. (2005). Potential for onsite and online analysis of pig manure using visible and near infrared reflectance spectroscopy, *Biosystems Engineering* 91, 393–402.
- Savitzky A., Golay M.J.E. (1964). Smoothing and differentiation of data by simplified least squares procedures, *Analytical Chemistry* 36, 1627–1638
- Stevens A., Udelhoven T., Denis A., Tychon B., Liroy R., Hoffman L., van Wesemael B. (2010). Measuring soil organic carbon in croplands at regional scale using airborne imaging spectroscopy, *Geoderma* 158, 32-45
- Stevens A., Nocita M., To' the G., Montanarella L., Van Wesemael B. (2013). Prediction of Soil Organic Carbon at the European Scale by Visible and Near Infrared Reflectance Spectroscopy". *PLoS One*. 8(6): 1-13.
- Vapnik V.N. (1995). *The Nature of Statistical Learning Theory*, Springer-Verlag.
- Vasquez G.M., Grunwald S., Sickman J.O. (2008). Comparison of multivariate methods for inferential modelling of soil carbon using visible/near-infrared spectra, *Geoderma* 146, 14-25
- Viscarra Rossel R.A., Behrens T. (2010). Using data mining to model and interpret soil diffuse reflectance spectra, *Geoderma* 158, 46–54.
- Viscarra Rossel R.A., Walvoort D.J.J., McBratney A.B., Janik L.J., Skjemstad J.O. (2006). Visible, near infrared, mid infrared or combined diffuse reflectance spectroscopy for simultaneous assessment of various soil properties, *Geoderma* 131, 59–75.
- Vohland M., Besold J., Hill J., Freund H.C. (2011). Comparing different multivariation calibration methods for the determination of soil organic carbon pools with visible to near-infrared spectroscopy, *Geoderma* 166 (1), 198-205
- Williams P.C. (1987). Variables affecting near-infrared reflectance spectroscopic analysis. In: Williams P., Norris K. (eds), *Near-Infrared Technology in the Agricultural and Food Industries*, American Association of Cereal Chemists Inc., Saint Paul, MN. pp. 143 – 167.
- Wold S., Sjöström, M., Eriksson L. (2001). *Chemometrics and Intelligent Laboratory Systems*. 58 (2): 109–130
- Wold S. (1985). Partial least squares. In Kotz, Samuel; Johnson, Norman L. *Encyclopedia of statistical sciences*. 6. New York: Wiley. pp. 581–591.

## **STATUS OF UNDERGROUND DRAINAGE IN EASTERN CROATIA AND DRAINED SOIL IMPROVEMENT BY AGROAMELIORATION**

Dragutin PETOSIC<sup>1\*</sup>, Vlado KOVACEVIC<sup>2</sup>, Jasna SOSTARIC<sup>2</sup>, Ivan MUSTAC<sup>1</sup>

<sup>1</sup>University of Zagreb, Faculty of Agriculture, Department of Soil Reclamation and Amelioration, Svetosimunska street 25, 10000 Zagreb, Croatia

<sup>2</sup>University J. J. Strossmayer in Osijek, Faculty of Agriculture, V. Preloga Street 1, 31000 Osijek, Croatia

\*Corresponding author: vkovacevic@pfos.hr

### **Abstract**

Croatia has about 2.3 million hectares of agricultural land, of which one third is state owned. About 167 thousand hectares of agricultural land in Croatia are covered by pipe drainage. Revitalization of pipe drainage and construction of new drainage systems are important potentials for improvement of agricultural production in Croatia. Intensification of drainage was carried out mainly from 1976 to 1990, mostly on agricultural land belonging to state owned farms. Eastern Croatia accounts for 30% of agricultural land at state level and pipe drainage is installed on 122,390.5 ha or 73% of total drained area in Croatia and 17% of agricultural land of the region. More than 20% of agricultural land is drained in three counties of the region (Vukovar and Srijem, Brod and Posavina, Virovitica and Podravina Counties). In general, maize and wheat yields in Eastern Croatia are by about 30% higher compared to the state average. In this regard, we presume that pipe drainage has given a considerable positive contribution, particularly under wet year conditions. Current status of pipe drainage functionality is mainly inadequate and reconstruction and regular servicing are needed. In spite of soil reclamation and pipe drainage management, yields of main field crops mainly in the southern lowland part of the region were accompanied with inadequate supplies of phosphorus and potassium. These problems were eliminated by adequate agroamelioration, for example, ameliorative fertilization. Nutritional problems could be also alleviated by selection of more tolerant field crop genotypes.

**Keywords:** *underground drainage system, pipe drainage, current status, reconstruction*

### **Introduction**

Underground pipe drainage has been applied on 167,174 ha of agricultural land in Croatia since 1976. The largest part of this system - above 95% - was developed by open ameliorative canals of third and fourth orders during the period 1976-1990 (Marusic, 2003; Petosic et al., 2015; Sostaric et al., 2016). Current status of pipe drainage functionality is unsatisfactory because as much as about 63% at country level and about 53% in Eastern Croatia have the status of a low degree of functionality. Main reasons for the low drainage system status in Croatia are improvisation in construction, inadequate servicing and its devastation during the reconstruction of third and fourth order canals (Petosic, 2003; Petosic et al., 2015). Improvement of plant production on drained agricultural land will be achieved by revitalizing pipe drainage (Petosic et al., 2015), while some drained soils require correction of their chemical properties (Kovacevic and Basic, 1997; Kovacevic et al., 1988, 2005; Petosic et al., 2003) due to very acid soil reaction and low levels of available nutrients, particularly potassium (K) and phosphorus (P).

The aim of this study was to survey the current status of the pipe drainage system in Eastern Croatia and present the possibilities of improving plant production on drained soils.

## Material and methods

Until the end of 1992, Eastern Croatia was territorially divided into 14 municipalities of a total area of 11,090 km<sup>2</sup> or 19.6% of the state territory (Vukovar, Beli Manastir, Osijek, Zupanja, Vinkovci, Djakovo, Slavonski Brod, Valpovo, Nasice, Slavonska Požega, Nova Gradiska, Donji Miholjac, Orahovica and Podravska Slatina). Since 1992, according to the new territorial division, Eastern Croatia includes five counties of a total area of 12,452 km<sup>2</sup> (22.0% of the state territory) as follows (Fig 1): Vukovar and Srijem County (15), Osijek and Baranja County (12), Slavonski Brod and Posavina County (14), Pozega and Slavonia County (10) and Virovitica and Podravina County (11). Control drainage units (Fig 1) were selected in each county of the region with the aim to test the status of the drainage system: Stara Sela (15), Trnava III (12), Veliki Crnac (14), Siljkovac (10) and Beljevina (11).

Publications of the State Bureau of Statistics (Statistical Yearbook of Croatia) were used as sources of maize and wheat growing area and yield data (Table 1).

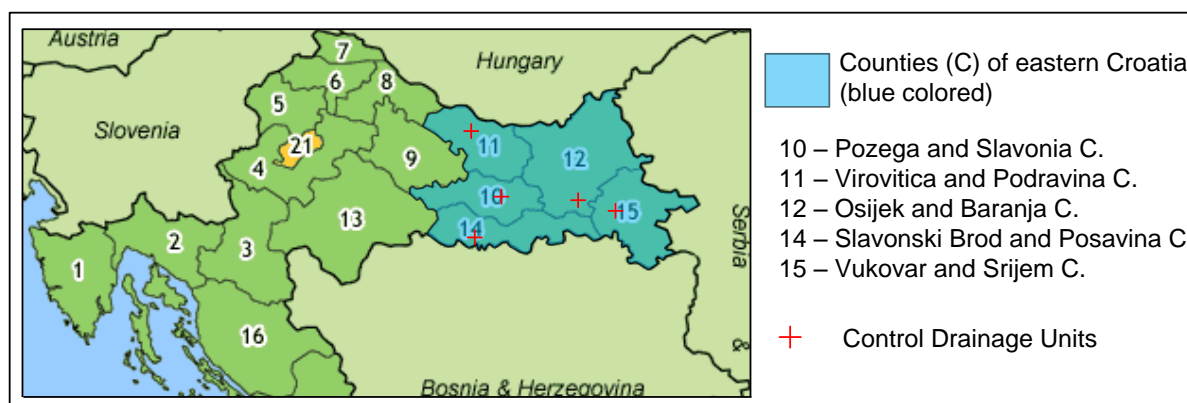


Fig 1. Location of the five counties of Eastern Croatia and control drainage units.

## Results and discussion

Croatia has about 2.3 million hectares of agricultural land, of which one third is state owned. About 7% of agricultural land of the country is covered by the drainage system. Eastern Croatia accounts for 30% of agricultural land at state level and pipe drainage is installed on 122,390.5 ha or 73% of total drained area in Croatia and 17% of agricultural land of the region. More than 20% of agricultural land is drained in three counties of the region (15, 14 and 11) (Table 1). In general, maize and wheat yields in Eastern Croatia are by about 30% higher compared to the state average. In this regard, we presume that pipe drainage has given a considerable positive contribution, particularly under wet year conditions. However, alkalization of the soil surface layer is a negative soil property closely associated with drainage.

Higher yields in Eastern Croatia (maize 5.94 and 4.68 t ha<sup>-1</sup>, 6.06 and 5.17 t ha<sup>-1</sup>; wheat 5.02 and 3.87 t ha<sup>-1</sup>, 4.51 and 3.92 t ha<sup>-1</sup>; for 1980-1989 and 2000-2005, respectively) compared to the state averages can be partially attributed to systematic hydroamelioration (Table 1).

Basic elements of pipe drainage in Eastern Croatia were in the following ranges: depth from 0.9 to 1.1 m, pipe spacing from 15 to 40 m, diameter of drainage pipes from 50 to 65 mm and length of drainage pipes from 60 to 290 m (Table 2).

Basic parameters of open canals of third and fourth orders were from 2.0 to 2.7 m and from 1.5 to 2.2 m (depth), from 800 to 1000 m and from 175 to 320 m (spacing), from 9.2 to 11.4

m<sup>2</sup> and from 7.42 to 9.92 m<sup>2</sup> (cross-section), from 800 to 2000 m and from 350 to 850 m (length of canals), respectively (Table 2).

**Table 1.** Agricultural land of Eastern Croatia (SAGRA 2014; CRORED, 2015) and yields of maize and wheat (Statistical yearbooks of Croatia)

	*Eastern Croatia Counties					Total	
	VuSc (15)	OsBc (12)	BPc (14)	PSc (10)	ViPc (11)	Region	Croatia
Agricultural land area (ALA) in ha: total, state owned (SO) and drained area (DA)							
ALA	152 103	280 935	106 255	66 612	110 403	716 308	2 326 221
SO	34 557	86 321	40 286	32 972	46 770	240 906	833 233
DA	33 762 (22.2)*	41 096 (14.6)*	22 224 (20.9)*	1 497 (2.2)*	23 813 (21.6)*	122 392 (17.1)*	167 174 (7.2)*
Maize	1996-2000 (Kovacevic, 2005)					168 288	375 979
t ha <sup>-1</sup>	6.57	6.18	5.58	5.75	5.73	6.06 t ha <sup>-1</sup>	5.17 t ha <sup>-1</sup>
Wheat	1996-2000 (Kovacevic and Josipovic, 2005)					117 421ha	211 253 ha
t ha <sup>-1</sup>	4.59	4.66	4.12	4.57	4.20	4.51	3.92
Maize	1980-1989 (Kovacevic at al., 1994)					5.94 t ha <sup>-1</sup> 207 576 ha	4.68 t ha <sup>-1</sup> 506 575 ha
Wheat	1980-1989 (Kovacevic at al., 1995)					5.02 t ha <sup>-1</sup> 139 700 ha	3.87 t ha <sup>-1</sup> 311 300 ha
* Vukovar-Srijem (15), Osijek-Barannya (12), Brod-Posavina (14), Pozega-Slavonia (10) and Virovitica-Podravina (11); in brackets = share of DA in percent of ALA.							

**Table 2.** Basic elements of pipe drainage and ameliorative canals

	Eastern Croatia Counties and names of control drainage units				
County	VuSc (15)	OsBc (12)	BPc (14)	PSc (10)	ViPc (11)
Name	Stara Sela	Trnava III	V. Crnac	Siljkovac	Bjeljevine
Basic elements of pipe drainage					
Area (ha)	235	150	600	199	480
Depth (m)	1.1	0.9 - 1.1	0.9 - 1.1	0.9 - 1.1	1.0 - 1.1
Spacing (m)	30 - 36	40	15 -20	30 - 35	30 - 35
Diameter (mm)	50	50	65	65	65
Length (m)	90 - 210	160 - 240	100 - 160	60 - 290	75 - 230
Basic elements of ameliorative canals of the third order					
Depth (m)	2.5	2.5	2.0 – 2.5	2.7	2.6
Spacing (m)	800	800-1000	800 - 1000	800	800
Cross-section (m <sup>2</sup> )	11.00	11.00	9.2 – 11.0	11.77	11.36
Length (m)	1220	800	1266	800- 2000	1900
Basic elements of ameliorative canals of the fourth order					
Depth (m)	1.80	1.70	1.5 -1.8	2.2	1.8
Spacing (m)	220 - 290	180 -220	300	180 -320	175 -300
Cross-section (m <sup>2</sup> )	8.48	8.12	7.4 – 9.2	9.92	8.50
Length (m)	580 -750	500 -600	800	400 - 640	350 -850

In Eastern Croatia, 3165 km or close to 48% of the existing ameliorative canals of third and fourth orders were fully reconstructed. Good pipe drainage functionality was found on 39,059

ha or close to 32%, on average on 14,390 ha or close to 12%, and poor on the remaining 68,940 ha or about 56% of the existing canals (Table 3).

**Table 3.** Status of waterway and ameliorative canals of third and fourth orders

	Eastern Croatia Counties					Total	
	VuSc (15)	OsBc (12)	BPc (14)	PSc (10)	ViPc (11)	Region	Croatia
Status of waterway and ameliorative canals (third and fourth orders) in km and % (R = reconstructed, NR =non-reconstructed)							
R (km)	816.7	1 562.1	341.5	78.1	366.9	3 165.3	5 157.1
R (%)	42.6	65.5	27.9	84.3	27.3	47.94	56.35
NR (km)	1 053.8	823.6	880.3	5.1	675.4	3 438.2	3 995.0
NR (%)	57.4	34.5	72.1	15.7	72.7	52.06	43.65
∑ (km)	1 870.5	2 385.7	1 211.8	83.2	1 042.3	6 603.2	9 152.1
Degree of drainage system functionality (ha)							
Good	13 305.3	10 909.7	7 025.5	302.6	7 516.2	39 059.3	43 229.7
Average	2 793.4	3 438.1	2 263.0	57.8	5 838.5	14 390.8	18 941.7
Inferior	17 662.9	26 747.7	12 935.4	1 136.2	10 458.1	68 940.3	105 002.8
∑ (km)	33 761.7	41 095.5	22 223.9	1 496.6	23 812.8	122 390.5	167 174.5

Despite soil reclamation and pipe drainage management, yields of main field crops, mainly on hydromorphic soils in the southern lowland part of the region, sporadically remained low due to inadequate P and K supplies (Petosic et al., 2003; Kovacevic, 2002; Kovacevic et al., 2005). Nutritional unbalance and maize and soybean yields were considerably improved by adequate ameliorative K fertilization (Table 4). Survey of K nutritional problems and responses of main field crops to K fertilization were elaborated by Kovacevic and Basic (1997). Both inadequate P and K status were found in some drained gleysols of the Sava Valley area and ameliorative fertilization resulted in considerable maize yield increases of 87% (K effect) and 41% (P effect) as well as in alleviation of nutritional unbalance due to lower P and particularly K uptake by plants (Table 5).

**Table 4.** Response of maize and soybean to ameliorative K fertilization on drained gleysol of the Vinkovci State Farm (Kovacevic and Vukadinovic 1992)

Fertili- zation (kg K ha <sup>-1</sup> )	Maize					Soybean			
	Leaf (% in dry matter)			Yield t ha <sup>-1</sup>	Lodging (%)	Leaf (% in dry matter)			Yield t ha <sup>-1</sup>
	K	Mg	Ca			K	Mg	Ca	
First year of testing (growing season 1987)									
125	0.64	2.03	1.43	1.75	42	0.57	1.60	1.44	1.28
835	1.43	1.39	1.38	7.76	5	1.90	0.95	1.64	2.70
2220	1.86	1.14	1.33	8.88	2	2.28	0.78	1.49	2.55
LSD1%	0.14	0.21	0.17	0.87		0.27	0.27	0.31	0.36
Third year of testing (growing season 1989)									
125	0.54	1.73	2.18	0.87	55	0.60	2.16	2.12	0.78
125	0.76	1.29	2.28	2.69	12	0.75	1.79	2.11	1.47
125	1.20	0.99	2.38	6.52	4	1.17	1.41	2.22	2.53
LSD1%	0.08	0.17	0.18	0.39		0.09	0.27	0.27	0.32

**Table 5.** Response of maize to P and K fertilization in the Crnac polje area on the former Nova Gradiska State Farm (Kovacevic et al., 1997)

Fertilization in spring 1990 (kg ha <sup>-1</sup> )			Maize yield (t ha <sup>-1</sup> )	Maize ear-leaf at silking (% in dry matter)			
N	P <sub>2</sub> O <sub>5</sub>	K <sub>2</sub> O		P	K	Ca	Mg
200	150	150	3.81	0.28	0.70	1.51	1.46
200	150	2550	7.13	0.25	1.74	1.29	0.73
200	2550	150	5.36	0.48	1.15	1.33	1.06
LSD		0.05	0.57	0.02	0.13	0.13	0.22

**Table 6.** Response of maize hybrids on drained K-fixing soil (Kovacevic and Vujevic, 1994)

Pedigree (♀ x ♂)	Yield (t/ha <sup>-1</sup> )	Stalk* (%)				Pedigree (♀ x ♂)	Yield (t/ha <sup>-1</sup> )	Stalk* (%)			
		SL	K	Mg	P			SL	K	Mg	P
Maize hybrids of Os1-48 inbred line (A group)						Maize hybrids of Os87-24 inbred line (B group)					
Os87-44 x A	5.23	8.8	0.30	0.48	0.11	Os87-61 x B	2.83	79.0	0.18	0.64	0.18
Os84-15 x A	6.30	4.8	0.30	0.55	0.07	Os88-15 x B	4.71	83.3	0.21	0.88	0.29
Os84-25 x A	5.56	4.1	0.18	0.52	0.14	Os86-92 x B	2.90	23.7	0.17	0.74	0.22
Os84-24 x A	5.89	4.6	0.17	0.48	0.08	Os87-56 x B	3.52	52.1	0.21	0.74	0.21
Os86-39 x A	4.45	7.5	0.18	0.71	0.16	Os84-24 x B	5.45	95.6	0.18	0.68	0.24
Os89-24 x A	7.20	4.1	0.30	0.45	0.07	Os 1-48 x B	5.40	5.3	0.18	0.69	0.19
Os87-24 x A	4.83	0.7	0.21	0.52	0.27	Os87-57 x B	4.28	74.1	0.19	0.68	0.22
Mean A	5.64	4.9	0.24	0.53	0.13	Mean B	4.16	59.1	0.19	0.72	0.22
LSD 5%	0.53		0.04	0.09	0.03	LSD 5%	0.53		0.04	0.09	0.03
LSD 1%	0.72		0.05	0.12	0.04	LSD 1%	0.72		0.05	0.12	0.04

\* K, Mg and P in three developed lowest stalk nodes at maturity (% in dry matter); SL=stalk lodging

Nutritional problems can be alleviated also by selection of more tolerant genotypes (Kovacevic and Vujevic, 1994; Simic et al., 2003; Kovacevic et al., 2011). Fourteen maize hybrids were grown under the K deficiency and Mg oversupply conditions. Seven hybrids of the Os1-48 male parent (group A) were more tolerant to this type of soil stress conditions compared to the hybrids of the Os87-24 male parent (group B), particularly regarding stalk lodging resistance at maturity. The higher K and lower Mg and particularly P concentrations in the stalk base were associated with lower stalk lodging (Table 6).

### Conclusion

Soil reclamation by pipe drainage and construction of appropriate ameliorative canals had a considerable effect on the yields of main field crops in Eastern Croatia, particularly under hydromorphic soil conditions. However, improvisation during construction and inadequate servicing of drainage systems during exploitation resulted in their mainly low functionality. For this reason, their urgent revitalization is required. Some soils of the region have less favorable chemical properties and appropriate agroamelioration is required to improve their productivity, for example, ameliorative potassium and phosphorus fertilization.

### References

- Kovacevic V. (2002): Overcoming potassium and magnesium unbalances by fertilization and genotype. *Agroznanje III* (1):14-25 in Croatian).
- Kovacevic V., Basic F. (1997): The soil potassium resources and the efficiency of potassium fertilizers in Croatia (Country Report 10). International Potash Institute, Coordinator Central/Eastern Europe, CH-4001 Basel/Switzerland.

- Kovacevic V. (2005): Wheat yield variations among the years in the Eastern Croatia. In: Proceedings of the XL Croatian Symposium on Agriculture with International Participation (Kovacevic V. and Jovanovac Sonja Eds.), 15-18 February 2005, Opatija, Croatia, p. 453-454.
- Kovacevic V., Josipovic M. (1995): Winter wheat (*Triticum aestivum* L.) yield variations in Croatia from 1960 to 1994. *Fragmenta Agronomica* (XIII) Nr2 (46): 28-29.
- Kovacevic V., Josipovic M. (2005): Maize yield variations among the years in the Eastern Croatia. In: Proceedings of the XL Croatian Symposium on Agriculture with International Participation (Kovacevic V. and Jovanovac Sonja Eds.), 15-18 February 2005, Opatija, Croatia, p. 455-456.
- Kovacevic V., Josipovic M., Grgic D. (1994): Survey of results of maize production in Slavonia and Baranya province from 1960 to 1989. *Poljoprivredne Aktualnosti* 3-4:495-503.
- Kovacevic V., Petosic D., Josipovic M. (2005): Potassium availability in hydromorphic soils of Eastern Croatia. *Cereal Research Communications* 33 (1):247-250.
- Kovacevic V., Simic D., Rastija M., Rastija D. (2011): Potassium fertilization and genotype effects on field crops in rotation. International Scientific Symposium of Agriculture "Agrosym Jahorina 2011" Jahorina 10 – 12 November 2011, RS, B&H, p. 17-25.
- Kovacevic V., Vujevic S. (1994): Magnesium uptake and lodging tolerance in maize (*Zea mays* L.) hybrids. In: "Magnesium 1993", John Libbey Ltd London p. 89-97.
- Kovacevic V., Vukadinovic V. (1992): The potassium requirements of maize and soybeans on a high K-fixing soil. *South African Journal of Plant and Soil* 9 (1): 10-13.
- Kovacevic V., Vukadinovic V., Bertic B. (1997): Response of maize to soil stress and fertilization on strong K-fixing soil. In: Developments in Plant and Soil Sciences. Vol. 78: Plant Nutrition for Sustainable Food Production and Environment (Ed. by Ando T., Fujita K., Mae T., Matsumoto H., Mori S. and Sekiya J.). Proc. of the XIII Intern. Plant Nutrition Colloquium. 13-19 Sept. 1997. Tokyo. Kluwer Acad. Publ. Printed in Japan. p.315-316.
- Kovacevic V., Zucec I., Bertic B., Katusic V. (1988): Nutritional disorders as limiting factor of plant production on soils of Eastern Croatia. *Zemljište i biljka* 37 (3): 183-190 (in Croatian).
- Marusic, J. (2003): State and characteristics of hydroamelioration facilities and systems for agricultural production in Croatia. Manual for hydrotechnical ameliorations, part 1, book 3, p. 49-95, University of Rijeka, Faculty of Civil Engineering, Rijeka – (in Croatian).
- Petosic, D. (2003): Functionality of detailed drainage system. *Hrvatske Vode* 45: 515-523.
- Petosic D., Kovacevic V., Josipovic M. (2003): Phosphorus availability in hydromorphic soils of Eastern Croatia. *Plant, Soil and Environment*, 49 (9): 394-401.
- Petosic D., Husnjak S., Mustac I., Bakic H., Filipovic V., (2015): Inventarization of underground drainage on agricultural land in Croatia, evaluation of status and recommendation for maintenance, CRORED "Croatia Drainage Register" – in Croatian.
- Petosic D., Sostaric J., Mustac I., Dacic M. (xxxx): Underground drainage system on agricultural land in Croatia, evaluation of status and recommendation for revitalizing and maintenance. Proceedings, HDON, p. 69-81, Rijeka.
- Simic B., Kovacevic V., Jurkovic Z. (2003): Response of maize genotypes to fertilization on hydromorphic soil of Sava valley. *Poljoprivreda / Agriculture* 8 (1): 20-24.
- Sostaric, J., Romc, D., Marusic, J., Josipovic, M., Petosic, D., (2016): Status of ameliorative systems of drainage in Croatia. Proceedings, 51st Croatian and 11th International Symposium on Agronomy, Opatija, p. 10-17 (in Croatian).

## IMPACT OF AGRICULTURAL PRACTICES AND URBANIZATION ON GROUND INVERTEBRATE FAUNA IN SUEZ CANAL REGION, EGYPT

Esraa S. HAMDY

Environmental researcher, Nature Conservation Sector, Egyptian Environmental Affairs Agency, Ministry of Environment, Egypt

\*Corresponding author: esraa.eaaa@gmail.com

### Abstract

Ground invertebrate fauna is the most diverse and important group to maintain the soil health. Suez Canal is the Egyptian water corridor connecting Red Sea in the south and Mediterranean in the north. The Suez Canal region has a unique status in Egypt. Since the opening of Suez Canal for international navigation in 1869, population in the Canal region increased and green areas expanded. The expanded cities have initiated new habitats and attracted some taxa from Nile valley to the west bank of Suez Canal. The distribution pattern of ground-macro invertebrates has been investigated in correlation with the selected land-use forms along the west bank of Suez Canal in a considerable region. The faunal samples were collected using pitfall traps in nine sites belonging to three stations in the study area; Abusultan, Fanara and Geneifa, with different land use practices (natural desert, agricultural areas and urbanized coast). A total number of 3502 individuals of insects, malacostracans, gastropods and arachnids belong to 129 species were found. The highest species richness was shown by Coleopterans, while the most abundant group was Hymenoptera. The agricultural and the urbanized coastal sites have shown significantly lower abundance of ground macro-invertebrates in comparison with the natural desert habitats. It was concluded that urbanization and agricultural practices have altered soil properties, thus they adversely affected the abundance of ground invertebrate assemblage.

**Key words:** *Ground invertebrate fauna, Suez Canal region, Distribution pattern, Urbanization, Agricultural practices.*

### Introduction

Suez Canal region is a special habitat in Egypt and has a unique status. Suez Canal was opened for international navigation in 1869, with a freshwater canal (Ismailia canal) originating at the River Nile (established in 1862) and running parallel to the Suez Canal to supply drinking water (Arnous et al, 2011). At that time, the Suez Canal area was almost uninhabited. After several years, the Suez Canal population has greatly increased. According to census of 2010, population of Suez Canal region is roughly 2.5 million people (Ibrahim, 2013).

This region was a stage of military actions for decades starting with First World War and ending in the war of October 1973. Since the end of war October, 1973, the Suez Canal cities have greatly expanded and doubled in size, in addition to many lands which are irrigated and cultivated recently (Ibrahim, 2013). Surveys and ecological studies to the biodiversity of the Suez Canal region were neglected during the wars periods. After the end of wars, ecological studies had a great attention. According to the studies, the left bank of Suez Canal was found to be an important eco-zone for some faunal groups such as butterflies, amphibians, reptiles and mammals (Baha El Din, 2006; Basuony et al., 2010; Gilbert et al., 2007).



A considerable number of fauna species were newly discovered in the region (6 spider species (Medany, 2013). Thirty-three species of reptiles and amphibians were recorded from the west bank of Suez Canal zone between 1999 and 2012 (Ibrahim, 2013) out of the ninety-nine terrestrial reptiles and eight amphibians found in Egypt (IUCN, 2000), i.e about one third of reptiles and amphibians found in Suez Canal area. About 55 species of bees have been collected and identified around the Suez Canal Region, in addition to 17 species of Hymenopteran wasps. This number is equal to the species number collected from all over Egypt by the former projects during the 1970s (Shebl et al, 2013).

Human impacts are continuing to drive natural systems to the direction of increasing patchiness and variability. These patchy habitats can affect ecological patterns and processes (MacArthur & Wilson's, 1967). The urbanization was found to be a matter of debate in the field of soil ecology. General ecologists consider it as a global problem with negative impact on natural ecosystem and whole biodiversity. Some of them believe that urbanization has recently been the master land use that make changes in species richness, diversity and distribution of species in many ecosystems, leading to the threats on biodiversity (El Surtasi, 2012). Several studies proved this belief especially those used pollinators as an indicator for the effect of urbanization on biodiversity.

Soils in urban areas are generally considered as highly disturbed and heterogeneous, with little systematic pattern in their characteristics (Pouyat et al, 2010). The urban soils have been viewed as drastically disturbed and of low fertility (Craul, 1992). There is always hypothesis that urbanization, as a change in land use, will alter the physical and chemical properties of the soil. This will lead to a habitat disturbance for micro-, meso- and macro-fauna of the soil. Changed soil conditions can affect the functionality of individual soil biota, as well as determine their presence or absence in a community (De Ruiter et al., 2002).

Agricultural activities have either positive or negative influence on diversity, abundance and activity of soil fauna according to the chemical properties of soil and the alteration of natural habitat to agricultural land. Agricultural practices can be both beneficial and detrimental to soil invertebrates. The various management practices that influence populations and activity of soil biota include: tillage, stubble retention, and crop rotation, application of fertilizer, pesticides, irrigation and soil compaction, indicated that population size and community structure of soil fauna are strongly influenced by agriculture practices (Rizk and Mikhail, 1999). The different fertilization regimes can impact significantly on the soil's physical and chemical properties (Zhu X. and Zhu B., 2014). Long-term fertilization can led to the reduction of some arthropod species and the increase in some soil biota groups (e.g., Collembola and Acarina) (Guðleifsson, 2002). Sludge application had a significant influence on some soil microarthropods and the intensity of the effect was highly correlated to sludge doses (Al-Assiuty et al., 2000).

The aim of this work is to illustrate the impact of agricultural and urbanization practices on the soil fauna through analyzing the effect of soil parameters on the abundance of the collected ground fauna invertebrate species in that study from the study area located on the west bank of Suez Canal.

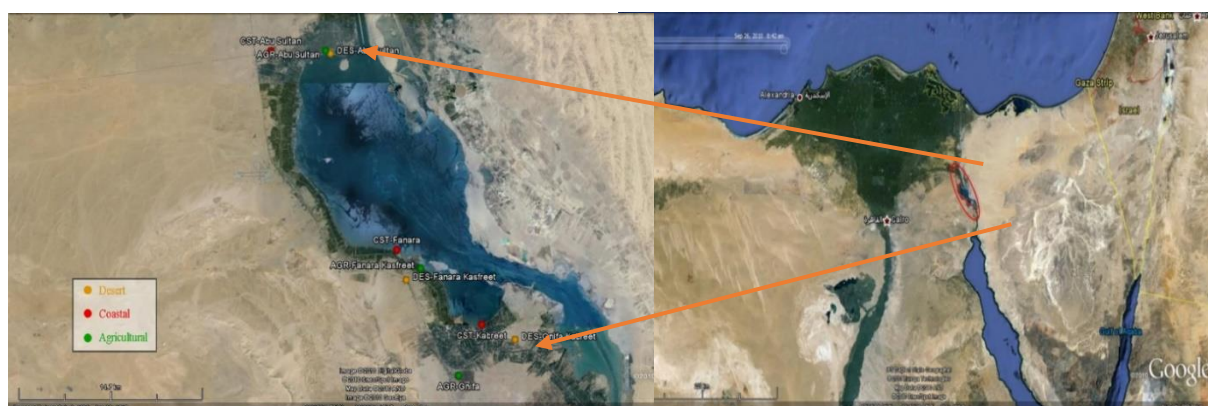
## **Material and methods**

### ***The study area***

The study was conducted in Suez Canal region along the west bank of Suez Canal and includes the northern part of Suez Governorate and the southern part of Ismailia Governorate (at N30.41046, E32.32851 - N30.23229, E32.45744) (Figure 1). This region is characterized by an arid climate with a maximum temperature of 36.1°C in July and a minimum temperature 7.8°C in January. The average annual temperature is about 21.5°C. The average annual precipitation is 33.3 mm (Golani, 1993).

The study was conducted in 9 sites varied in their land use intensity and classified into 3 main habitats: desert (natural), agriculture and coastal (urbanized) habitats. Each one of the three habitats is represented by three sites which are sharing the main characteristics of desert, agriculture or the coastal habitats, but differ slightly in the human activity pressure affecting them. In the selected study area, 3 stations were chosen to trap ground-dwelling fauna: Abu Sultan, Fanara and Geneifa (Figure 1). Each one of them contains the 3 required types of habitats. Three sites were chosen in each station to put the traps which are representatives to natural desert, agricultural, and urbanized coastal habitats. Two of the agricultural lands were typical cultivated lands while the third one was reclaimed land. The coastal sites were affected by the urbanization activities and military camps.

The 9 sites within the different 3 stations were chosen according to: Accessibility, Out of reach, Sustainability and representativeness (costal, agricultural and desert sites). The pressures were mainly identified in the presence of high pressure poles, large heaps of rubbish, as well as some grazing activities and the interruption by train railway which appeared on desert lands.



**Fig. 1:** Study area (the area marked with red)

### **Methods**

The collection of these sample fauna was done by pitfall trapping method. A number of 54 jars were used as pitfall traps, 6 for each site compromising 18 for each station. Traps were put in dug holes in the ground deep enough to take the whole jar. They were kept open for 3 days in the soil then they were collected. After collecting the traps, the collected specimens were separated, counted, preserved and then identified.

Ground macro-fauna were collected seasonally, from autumn 2010 to summer 2011. The field trips have been conducted every three months, in October, January, April and July.

Soil samples in the study extend down to about 20 cm depth, as samples from soil surface layer only are needed. Samples were put in clean plastic bags with labels describing each subsample. Subsamples were mixed thoroughly to make a composite soil sample. Before air-drying samples, a little portion of each was separated to measure moisture and pH in soil. Afterwards, soil samples were spread over clean paper sheets for 2 days to dry then they were put in cooler until being analyzed. The collected soil samples were air-dried, crushed and sieved to pass through a 2 mm sieve and kept in plastic containers for analyzing physical and chemical properties. Soil moisture was determined by drying the soil samples at 105 °C, and calculated on oven dry weight basis.

Physical and chemical analyses of the soil were carried out according to standard methods (Page *et al.*, 1982). Twenty five physical and chemical properties of soil samples were measured during the study. These properties were as follows:

**Chemical:** [ pH, Electric conductivity (E.C  $\text{dsm}^{-1}$ ), Sodium Adsorption Ratio (SAR), Soluble Cations {Calcium ( $\text{Ca}^{2+}$ ), Magnesium ( $\text{Mg}^{2+}$ ), Potassium ( $\text{K}^+$ ), Sodium ( $\text{Na}^+$ )} in meq/L ( soil paste), Soluble Anions {Chloride ( $\text{Cl}^-$ ), Carbonates ( $\text{CO}_3^{2-}$ ), Bicarbonate ( $\text{HCO}_3^-$ ), Sulfate ( $\text{SO}_4^{2-}$ )} in meq/L ( soil

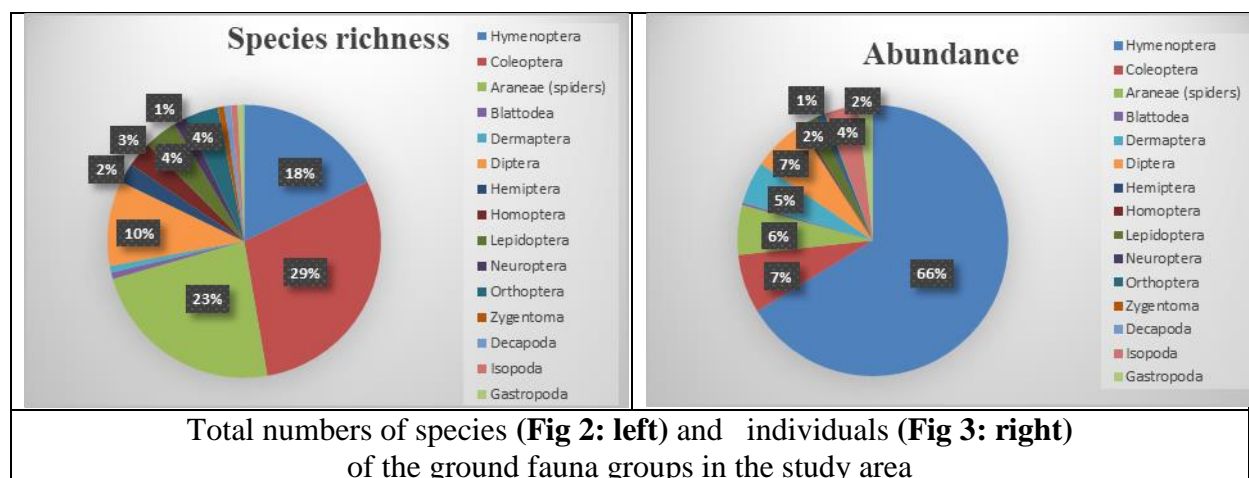
paste), Calcium Carbonate ( $\text{CaCO}_3\%$ ), total soil Nitrogen (N), total Phosphorus (P), total Potassium (K), total Soil Organic Matter (SOM), total Organic Matter, Carbon/Nitrogen ratio (C/N) and Carbon/Phosphorus ratio (C/P) ].

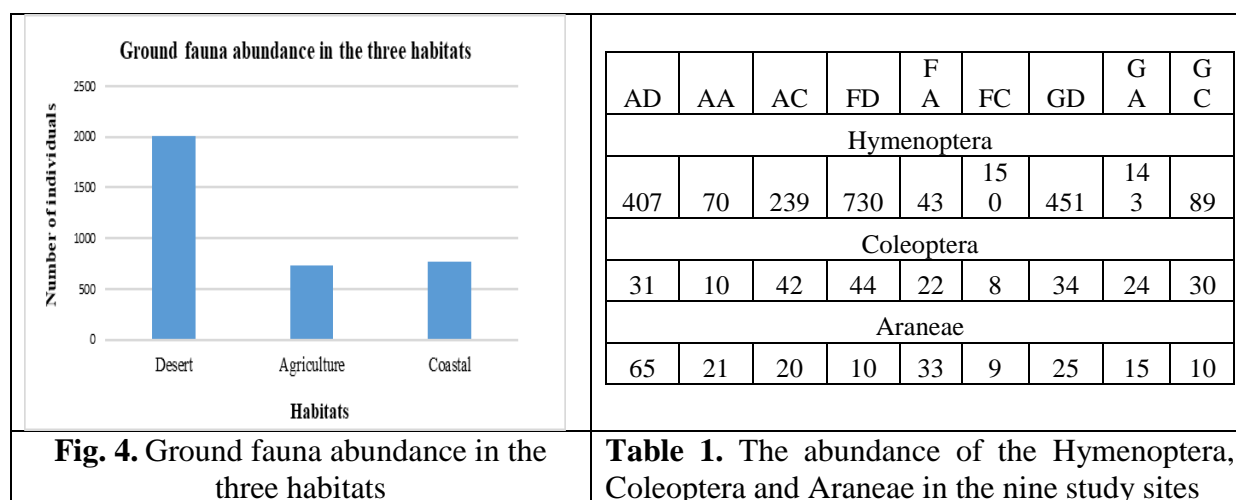
**Physical:** [ Sand %, Silt%, Clay%, soil type and soil moisture]

**Data analysis:** The resulted data, corresponding the faunal species and soil samples which were collected during the practical work of the study, were manipulated and analyzed using Microsoft Excel 2010, SPSS “14” and PC-ORD “5” programs. Charts using Microsoft Excel were conducted to show the difference in values of species abundance and ANOVA test was applied to show the significance of the difference among spatial abundance. Multivariate analyses using Two Way Indicator SPecies ANalysis (TWINSPAN), Detrended Correspondence Analysis (DCA) and Canonical Correspondence Analysis (CCA) were carried out for the 9 sites of this study in the view of ground faunal species and soil chemical and physical properties. PC-ORD 5 program was used to complete all the multivariate analyses. (Hill et al., 2013; McCune and Mefford , 1999).

### Results and discussion

This study focuses on the ecology and distribution pattern of ground-dwelling macro invertebrates in one of the natural habitats which exposed to habitat alteration in the previous few decades, the Suez Canal region. It was illustrated that the most important groups are Order Hymenoptera (especially family Formicidae), Order Coleoptera and Order Araneae (spiders). They are represented by large numbers of both species and individuals. Among 129 species found during this study, 38 species were belonging to Coleoptera, 30 species of Spiders and 23 species of Hymenopterans (from which 14 species are formicids). The total number of individuals collected was 3502 from which 2322 Hymenopterans, 245 Coleopterans and 208 spiders. The total abundance of the collected soil arthropods was relatively low (3502 individuals), but the species richness is relatively high (129 species). Generally, the high diversity within the insect communities of a habitat is an important factor reflecting the richness of the overall quality of that ecosystem and can be a useful tool in ecosystem conservation (Semida et al., 2001). Although gardens in arid environments may be a home for ground arthropods with having an enhanced abundance of them (Norfolk et al., 2012), agricultural sites in this study showed significantly low ground fauna abundance ( $p < 0.01$ ) in comparison with natural desert habitats followed by urbanized sites (Fig. 4). The reason for these results could be explained by the unfavorable changed soil conditions according to urbanization and agricultural practices.





**Fig. 4.** Ground fauna abundance in the three habitats

AD	AA	AC	FD	F A	FC	GD	G A	G C
Hymenoptera								
407	70	239	730	43	150	451	143	89
Coleoptera								
31	10	42	44	22	8	34	24	30
Araneae								
65	21	20	10	33	9	25	15	10

**Table 1.** The abundance of the Hymenoptera, Coleoptera and Araneae in the nine study sites

The soil physical and chemical parameters against the 9 sites were cleared in Table 2

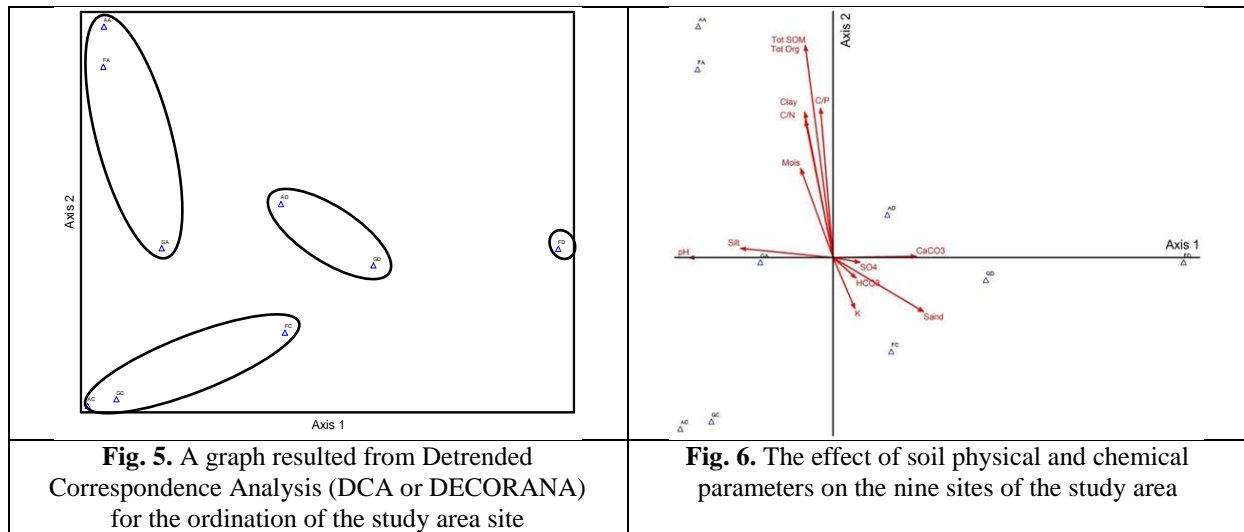
**Table 2.** Soil parameters against the nine sites of the study area

	Site: AD: Abu Sultan Desert; AA: Abu Sultan Agricultural, AC: Abu Sultan Coastal, FD: Fanara Desert, FA: Fanara Agricultural, FC: Fanara Coastal, GD: Geneifa Desert, GA: Geneifa Agricultural, GC: Geneifa Coastal								
	AD	AA	AC	FD	FA	FC	GD	GA	GC
pH	7.9	8.6	8.7	7.9	8.5	8.3	7.8	8	8.4
Moisture %	2.6	14.7	3.1	1.5	6.5	4.9	9.6	7.1	4.7
EC (dsm <sup>-1</sup> )	1.3	0.31	5.66	1.22	0.85	4.41	16.61	14.31	4.06
Ca meq/L	6.1	1.5	29.2	8	5.3	15.7	41.2	38.3	6.5
Mg meq/L	2.9	0.7	6.5	1.8	3.2	6.6	19.1	19.5	6.6
K meq/L	1	0.7	1.7	1	0.4	1.4	1.7	2	1.2
Na meq/L	4	0.5	27.6	2.8	1.4	27	151.8	116.5	31.2
Cl meq/L	7.5	1.8	36.6	3.1	4.2	30.8	142.8	128.3	38.6
HCO <sub>3</sub> meq/L	0.2	0.2	0.2	0.4	0.3	0.2	0.5	0.5	0.5
CO <sub>3</sub> meq/L	0	0	0	0	0	0	0	0	0
SO <sub>4</sub> meq/L	6.4	1.2	28.2	8.9	4.7	19.7	70.4	47.6	6.1
CaCO <sub>3</sub> %	4.85	3.775	3.175	14.95	11.95	12.425	7.775	10.55	5.875
Total N %	0.117	0.105	0.075	0.071	0.031	0.081	0.044	0.072	0.035
Total P %	0.048	0.036	0.056	0.032	0.093	0.07	0.099	0.037	0.044
Total K %	0.137	0.173	0.091	0.108	0.187	0.076	0.202	0.131	0.226
Total org matter %	0.8	1.81	0.31	0.34	1.25	0.31	0.39	0.33	0.08
Tot Org C	0.462	1.048	0.183	0.195	0.723	0.178	0.226	0.193	0.045
C/N	4	10.5	2.5	2.7	25.7	3	5.2	2.8	1.3
C/P	9.4	30.4	3.5	6.8	7.5	2.5	2.4	5.4	1.1
SAR	1.5	0.4	6.5	1.4	0.6	8.3	25.3	21.6	12.1
Sand %	88	81	95	98	91	95	96	98	95
Silt %	11	11	3	2	5	3	3	3	3
Clay %	1	8	2	2	4	2	1	0	2
Texture	Sandy	Loamy	Sandy						
Soil type	Normal soil		Saline	Normal soil		Saline	Saline sodic		Saline

**The Multivariate Analysis**

The application of the Detrended Correspondence Analysis (Figure 5) to the study sites showed the tendency of the agricultural sites then the coastal sites to the coordination axis 2. When the Canonical Correspondence Analysis (Figure 6) is applied to the soil parameters against the ordination sites, it showed that the most effective soil parameters were total Soil Organic Matter (Tot SOM) and total organic matter (Tot Org) which characterize the

agricultural sites. Other effective factors are clay, moisture, the ratio of Carbon/Nitrogen (C/N) and the ratio of Carbon/Phosphorus (C/P). Coastal and desert sites are characterized by sandy soils, however, the coastal sites are characterized by the effect of potassium. The desert sites are affected by high levels of calcium carbonate (CaCO<sub>3</sub>).



The variation in ecoregions in Egypt and in land use practices has been proven to affect ground fauna density and, in consequence, species diversity and biological functional groups. Changing the use of land will have either negative or positive impact on the soil structure, which is the shelter of many groups of arthropods. The impact of land use changes can lead to favorable conditions for certain ecosystem services or to the degradation and even loss of soil (Defra, 2009). TWINSpan analysis and Detrended Correspondence Analysis (DCA) have differentiated among the sites of the same habitat with each other. The classification process proceeded in 3 levels. The first level separated the site (4) community from the other 9 sites. This site is Fanara desert, which is characterized by a significant higher abundance of ground invertebrate fauna. It was also the lowest site in human pressure, land use, and habitat alteration. The second level of division has separated the coastal sites in one group from the other group, which included agricultural and desert sites. The result of this separation illustrates that natural ecosystems represented by the desert habitats are similar to each other and more similar to the agricultural sites than the urbanized coastal ones. Earlier studies supported this conclusion (e.g., Ghabbour and Mikhail 1993a, 1993b and Hanna et al, 2012). The third level of division resulted in separating the remaining desert sites from the agricultural sites. According to Detrended Correspondence Analysis, Abu Sultan and Fanara agriculture (sites 2, 5) are more similar to each other in the view of ground fauna community. However, Geneifa agriculture (site 8) is less similar to them and far from them. It is not a strange result because Abu Sultan and Fanara agriculture are typical cultivated lands, while Geneifa agriculture is a newly reclaimed land. On the other hand, the communities of Abu Sultan and Geneifa coastal sites (sites 3, 9) are more similar and closer to each other than Fanara coastal site (site 6), which is less affected by urbanization. This is also normal because Abu Sultan and Geneifa coastal sites are urbanized sites, but Fanara coastal site is a military place with less urbanization impact. Canonical Correspondence Analysis (CCA) showed that the most effective soil properties that affect the differentiation of the sites are those associated with agricultural practices, especially the soil organic matter (SOM) and the total organic matter. They were greatly increased in the agricultural land, in particular in Abu Sultan and Fanara. As a consequence, the factors of SOM total organic matter are accompanied by related factors such as clay percentage, moisture, the ratio of Carbon/Nitrogen and the ratio of

Carbon/Phosphorus. Soil organic matter (SOM) has a great effect on soils. It increases the capacity of soils to bind chemicals, improves soil structure and water infiltration and retention, buffers the releases of pollutants, regulates the supply of nutrients and makes the soil more resistant to drought and erosion (Defra, 2009). Soil structure was one of the most important factors. Geniefa agricultural site is the sandiest agricultural one, desert sites are affected by the sandy texture, as well as coastal sites. Coastal sites are characterized by the effect of decreased levels of potassium, however the desert sites are affected by the higher levels of calcium carbonate (CaCO<sub>3</sub>). pH increases in two of the agricultural sites (Abu Sultan and Fanara), and also the coastal sites (especially those in Abu Sultan and Geneifa), exceeding the edge of 8. Plant growth and most soil processes, including nutrient availability and biotic activities, are favored by a soil pH ranging from 5.5 to 8 (Bolland et al, 2004). Over or below these range, soil begins to be unhealthy. These results indicate that each type of habitat has its own soil composition with different factors affecting them. This difference has been resulted in the variation of ground fauna abundance with the greatest values in natural desert habitats and diminished values in the other impacted sites, especially agricultural habitats.

### **Conclusion**

According to the present study, Suez Canal region is rich in ground invertebrate fauna that may include undiscovered species. Data available about ground invertebrates in Suez Canal region is still poor. This area is also under the pressure of the continuous development and increased human activities. Urbanization and agricultural practices showed an adverse effects on ground fauna abundance in the study area. Therefore, more ecological studies concerning ground invertebrate fauna and their response to habitat alteration in Suez Canal region are required.

### **References**

- Al-Assiuty A. I. M., Khalil M. A. and Abdel-Lateif H. M. (2000). Effects of dry sludge application on soil microarthropod communities in a reclaimed desert ecosystem. *Pedobiologia* 44: 567–578.
- Arnous M. O., Aboulela H. A. and Green D. R. (2011). Geo-environmental hazards assessment of the north western Gulf of Suez, Egypt. *Journal of Coastal Conservation* 15 (1): 37-50.
- Baha El Din S. (2006). *A Guide to the Reptiles and Amphibians of Egypt*. American University in Cairo Press: 382 pp.
- Basuony M. I., Gilbert F., Zalat S. (2010). *Mammals of Egypt: Atlas, Red Data Listing & Conservation*. Ministry of State for Environmental Affairs: 273 pp.
- Bolland M., Gazey C., Miller A., Gartner D. and Roche J. (2004). *Subsurface Acidity*. Department of Agriculture and Food, Western Australia, Perth. Bulletin 4602.
- Craul P. J. (1992). *Urban soil in landscape design*. John Wiley and Sons, New York.
- Defra (2009). *SOIL STRATEGY FOR ENGLAND: Supporting Evidence Paper*. Department for Environment, Food and Rural Affairs.
- De Ruiter, P.C., Griffiths, B., Moore, J.C. (2002). Biodiversity and stability in ecosystems: patterns, processes and the effect of disturbance. In: Loreau, M., Naeem, S., Inchausti, P. (Eds.), *Biodiversity and Ecosystem Functioning: Synthesis and Perspectives*. Oxford University Press, Oxford: 102–113.
- El Surtasi E. I., Semida F. M., Abdel-Dayem M. S. and El Bokl M. M. (2012). The Threat of Urbanization on Beetle Diversity in New Damietta City, Egypt. *Nature and Science* 10 (1): 15-23.

- Ghabbour S. I. and Mikhail W. Z. A. (1993a). Habitat classification using soil fauna populations. Publications of the National Biodiversity Unit No. 1, Egypt: 203-236.
- Ghabbour S. I. and Mikhail W. Z. A. (1993b). Diversity of soil fauna in Egypt. *Mesogee* 53: 21-53.
- Gilbert F. and Zalat S. (2007). Butterflies of Egypt: Atlas, Red Data Listing & Conservation. Ministry of State for Environmental Affairs: 273 pp.
- Golani D. (1993). The sandy shore of the red sea-Launching pad for lessepsian (Suez Canal) migrant fish colonizers of the eastern Mediterranean. *Journal of Biogeography* 20 (6): 579-585.
- Guðleifsson B.E. (2002). Impact of long term use of fertilizer on surface invertebrates in experimental plots in a permanent hayfield in Northern-Iceland. *Agric. Soc. Iceland* 15, 37-49.
- Hanna S. H. S., Ghabbour S. I., Mikhail W. Z. A., Sobhy H. M. and Sultan G. (2012). Diversity of functional groups of soil fauna in Egyptian habitats. *International Journal of Environmental Science and Engineering (IJESE)* 3: 49-70
- Hill M. O., Harrower C. A. and Preston C. D. (2013). Spherical k-means clustering is good for interpreting multivariate species occurrence data. *Methods in ecology and evolution* 4 (6): 542-551.
- Ibrahim A. A. (2013). The Herpetology of the Suez Canal Zone, Egypt. *Vertebrate Zoology* 63 (1): 87-110.
- MacArthur R. and Wilson E. O. (1967). *The theory of island biogeography*. Princeton University Press, Princeton, NJ.
- McCune B. and Mefford M. J. (1999). PC-ORD. Multivariate analysis of Ecological Data, Version 4.0 for Windows. MjM Software, Gleneden Beach, Oregon, USA.
- Medany D. M. A. (2013). Spiders as bioindicator for environmental risk assessment of woody forest plantation in Serabium region, Ismailia Governorate. M. Sc. Thesis, Dept. of Zoology, Faculty of Science, Suez Canal University: 207 pp.
- Norfolk O., Abdel-Dayem M. and Gilbert F. (2012). Rainwater harvesting and arthropod biodiversity within an arid agro-ecosystem. *Agriculture, Ecosystems and Environment* 162: 8-14.
- Page A. L., Miller R. H. and Kenney D. R. (ed.) (1982). *Methods of soil analysis, part 2* (2nd ed): Chemical and microbial properties, ASA Inc., SSSA Inc. Publisher, Madison, Wisconsin, USA.
- Pouyat R. V., Szlavecz K., Yesilonis I. D., Groffman P. M. and Schwarz K. (2010). Chemical, physical, and biological characteristics of urban soils. Book and Multimedia Publishing Committee: 152 pp.
- Rizk M. A. and Mikail W. Z. A. (1999). Impact of no-tillage agriculture on soil fauna diversity. *Zoology in the Middle East* 18 (1).
- Semida F. M., Abdel-Dayem M. S., Zalat S. M. and Gilbert F. S. (2001). Habitat heterogeneity, altitudinal gradients in relation to beetle diversity in South Sinai, Egypt. *Egyptian Journal of Biology* 3: 137-146.
- Shebl M., Kamel S. and Mahfouz H. (2013). Bee fauna (Apoidea: Hymenoptera) of the Suez Canal region, Egypt. *Journal of Apicultural Science* 57 (1): 33-44.
- Zhu X. and Zhu B. (2014). Diversity and abundance of soil fauna as influenced by long-term fertilization in cropland of purple soil, China. *Soil & Tillage Research*, article in press: 8 pp.
- The IUCN Red List of Threatened Species: October 2010 update. Available from: [http://cmsdata.iucn.org/downloads/cycad\\_factsheet\\_final.pdf](http://cmsdata.iucn.org/downloads/cycad_factsheet_final.pdf). [Accessed 6 December, 2015]

## **EFFECT OF HIVE BUILDING MATERIAL ON BEE COLONIES**

Mohamed Ali Ibrahim AL-RAJHI

Agriculture Engineering Research Institute, AEnRI, ARC. El-Dokki - Egypt.

Corresponding author: moh.elrajhi@yahoo.com

### **Abstract**

This study was carried out in a private apiary at Meet Salseel, Eldaqahliyah Governorate, Egypt for four months to compare foam, clay, cement and white brick with common material (wood), in the construction of *Langstroth* beehive model in a completely randomized design. The evaluation also included three thicknesses of hive sides and three sizes of hives. There were primary measurements on the building materials such as: density, thermal conductivity, water absorption, and rate of water loss. The secondary measurements including: inside hive temperature, bee colony strength (number of occupied frames), productivity (net colony weight, kg.), and the production cost. Results indicated that the mean density of foam, clay, cement and white brick samples were about 49, 2650, 952, and 811 kg/m<sup>3</sup>, respectively, while it were 528 kg/m<sup>3</sup> for wooden hives. The mean values of thermal conductivity were 0.93, 0.33, 0.28 and 0.01 Wm<sup>-1</sup>°C for clay, cement, white brick, and foam samples, respectively, while it were 0.18 Wm<sup>-1</sup>°C for wooden hives. The cement, white brick and wood samples absorbed 24, 18, and 14 % of water, while the foam simple didn't absorb any water. Cement and white brick samples absorbed more water and lost water faster than wooden one. The maximum inside hive temperature was recorded in foam hive, while the minimum was recorded in white brick hive. The mean number of occupied frames were increased 20.45 and 13.64 % than it in wooden hives for foam and clay hives, respectively, but it were decreased 11.36 and 15.91 % when using cement and white brick hives, respectively. The mean colony net weight, kg were increased about 24.85 and 10.82 % than it in wooden hives for foam and clay hives, respectively, but it were decreased about 11.7 and 7.41 % when using cement and white brick hives, respectively. There was an increasing in mean internal hive temperatures, number of workers/ 5 min, number of occupied frames and colony net weight by decreasing hive size and increasing side thickness. Foam, clay, cement and white brick cost requirements were 80, 73.3, 40 and 63.3 % cheaper than the wooden beehive (150 L. E. without the price of the nest). In general, the foam, clay, cement and white brick hives can be easily constructed with a low cost and with similar characteristics as traditional wooden hives.

**Keywords:** *Hive building materials, Thermal conductivity, Temperature, Colonies strength and productivity.*

### **Introduction**

Normally honeybees build their nest in different places like mountains, hollow trees, ground holes and others, trying to protect themselves from wind, rain and enemies. Honeybees are known to control their hive environment to survive drastic changes in the field environment (Jones and Oldroyd, 2007). Bees consume honey to rise inside hive temperature and worker bees contribute to the regulation of brood nest temperature by producing heat while sitting motionless on the caps of brood cells (Marco Kleinhenz, et al., 2003). Several investigators as (Jevtic, et al. 2009), has proved positive correlation between stored pollen, brood production and honey yield.



The wooden Langstroth beehives offers acceptable conditions, allowing their dispersion worldwide (Wiese, 1974; Dadant and Sons, 1975). But, the Langstroth wooden hive cost is high at the beginning of the honeybee project and didn't encourage the production, especially for small beekeepers at the developed countries. Also the expected life of wooden hives is short and it can be burned. (Hobson, 1983) suggested the ferrocement hive that is more resistant and cheaper than the wooden hive. (Soares and Banwart, 1989), used the Fibercol hive that made of fiberglass despite of its high cost. (Neves, 2002), verified that the brood nest temperature were similar in a cement vermiculite mortar and wooden hives. (Padilha, et al. 2001), obtained that the thermal conductivity of 0.16 to 0.44 Wm<sup>-1</sup>°C in cement-vermiculite mortar (CVM) boards. According to (Stangenhuis, and Paredes 1992), the thermal conductivity of concrete is 1.5 Wm<sup>-1</sup>°C and the mortar cement is 1.15 Wm<sup>-1</sup>°C. Also, it found out that clay hives are easily available and very cheap compared to wooden hives and also more environmentally friendly (F.A.O., 1990). There aren't any researches about the effect of hive building materials on bee colonies under Egypt conditions. So, this research was carried out for testing the hypothesis that the new hive build materials such as: clay, with white brick and foam shows similar results to the wooden hive.

### Material and Methods

*Langstroth* beehives is the most widely used hive in the world (Ojeleye, 1999). To conduct the experimental work, a new *Langstroth* bee hives were constructed from a local and a valuable cheap materials such as: foam, clay, cement and white brick as illustrate in Fig. (1) and compared with common material (wood). Honeybees (hybrid Carniolan, *Apis mellifera carnica carniolan*) are a single honeybee species adopted by the farmers in Egypt. The honeybees that had been established 8 months prior to the beginning of the experiment were placed on a sunny site in the bee yard, with their entrances far from the common wind direction and rain. Bees were about equal in the strength, food stores (Honey and pollen), queen's age (about 8 months old) and number of combs covered with bees from both sides (5 combs). Colonies were fed with sugar: water solution at 2: 1 percentage during the duration of the study. *Nosema apis* and *Varroa* destructor were monitored every 12 days throughout the study period, and treated whenever necessary. A total of 45 *Langstroth* enclosure bee hives were constructed as following: foam was cut to boards with a suitable dimensions. The foam boards were joined together using adhesive material. Clay beehives were made by using clay grains (from 4 to 5 mm) and water. To prepare the mixture, some water was added little by little, until the fingers marked the mixture. The mortar was shaped around a wooden mold. The upper edge of the two longitudinal sides were formed to suit the dimensions of *Langstroth* frames. The clay hives were left to dry in a shaded place for two days. The wooden beehives were obtained from a local workshop. Cement beehives were built by preparing molds. These molds were easily made, but should followed the dimensions of *Langstroth* model in its width. Before receiving the cement, the molds were previously moistened and coated with oil to facilitate the removal of boards. The cement was gradually filling and compacted in the molds and left to dry for two days without sprinkling water and in the next three days it was sprinkled water twice a day. On the ninth day, it were carefully removed. White brick beehives were made by cutting a valuable and cheap kind of white brick. The boards were joined together by cement, as shown in fig. (1). The slides have to be polished for a better finishing. The *Hoffman* Bee frames were made of wood. There was a removable top on all of them. There was a piece of sackcloth located under the cover to prevent any foreign insect to inter the hive and absorb vapor from the evaporation process. These hives were painted blue as the wooden ones. Beehives standing about 0.5 m above the ground on individual stands. The hives were opened every 12 days to verify possible damages

due to the environment and to manage them. The distances between each beehive was 2 meters.



Fig. (1): Different types of beehives

Measurements including: five types of hive building materials (clay, white brick, foam, cement and wood), three thicknesses of beehive sides (1, 2, and 3 cm) and three hive sizes (0.057, 0.086 and 0.114 m<sup>3</sup>) were studied. The present study carried out from 1 December until 30 March. To determine thermal conductivity: three parts of each of foam, clay, wood, cement and white brick were cut and taken as samples. The samples were weighted with electronic balance, with an accuracy of 0.01 grams and the mean mass was obtained. The volumes of white brick, foam, cement and wood were estimated by putting the weighted sample in a measuring flask (250 ml) filled to its a half with water and estimate the variance of water volume. The mean volume of clay samples was estimated by the same method, but after coating with fused beeswax. According to (Rodrigues, 1998) the following equation used to determine thermal conductivity

$$k = 0.0003545 \rho - 0.007146, \text{ Wm}^{-1}\text{°C} \rightarrow \quad (1)$$

Where: k is thermal conductivity and  $\rho$  is the density of samples, which was determined by the following equation,

$$\rho = \frac{m}{v}, \text{ kg/m}^3 \rightarrow (2)$$

Where: m is the mass of broad material in kg and v is the volume of it in m<sup>3</sup>.

The mass of samples were determined before and after soaking them in water for 30 minutes, the variation between mass indicated water absorption by each material. The simples were

dried in an oven at 30°C. The test began at 9:30 a.m. and the mass measurements were taken at 10:00 a.m., 11.00 a.m., 01:00 p.m., 05:00 p.m. and 08:00 a.m. The mean masses for each tested material were obtained and the results were applied by the following equation (Lorenzon, *et al* 2004),

$$W.L.R. = \frac{S.M_{sat}}{S.M_{dry}} \times 100 \rightarrow (3)$$

Where: W. L. R.: water loss, %.

S. M<sub>sat</sub> : saturated sample mass in gram.

S. M<sub>dry</sub>: dry sample mass at a given time in minutes.

A digital thermometer with an accuracy of 0.1 °C was used to determine internal hive temperatures and in the bee yard. Air temperature outside the hives was taken by a thermometer placed in a shaded place in the apiary. The number of combs covered with bees from both sides was investigated every 12 days throughout the winter season for adding empty new combs. Bees or adult population was estimated at the rate of 2000 adult bees which can cover a comb from both sides (Hauser and Lensky, 1994). This investigation was carried out every 12 days throughout the winter season of 12 December, 24 December, 5 January, 17 January, 29 January, 10 February, 22 February, 6 March, 18 March and 30 March. After assembling all types of boxes the empty weight was determined by an electronic balance. The balance had a maximum capacity of 100 kg with an accuracy of ± 30 gram as described by (Meikle *et al.*, 2006). The nearest colonies net weights were determined by the following equation every 12 days.

$$\text{Colony net weight} = \text{whole hive weight} - \text{empty box weight, kg.} \rightarrow (4)$$

The cost for the model *Langstroth* clay, white brick, foam and cement beehive was estimated and compared with the wooden one.

### Results and Discussion

The densities of foam, clay, cement and white brick samples were about 49, 2650, 952 and 811 kg/m<sup>3</sup>, respectively, while it were 528 kg/m<sup>3</sup> for wooden hives. The lowest density was obtained with foam material and the highest with clay material. The thermal conductivity of samples were about 0.01, 0.93, 0.33 and 0.28 Wm<sup>-1</sup>°C for foam, clay, cement and white brick samples, respectively, while it were 0.18 Wm<sup>-1</sup>°C for wooden hives. The lowest thermal conductivity was obtained with foam material and the highest with clay material. In general, the thermal conductivity was decreased by decreasing the density of materials.

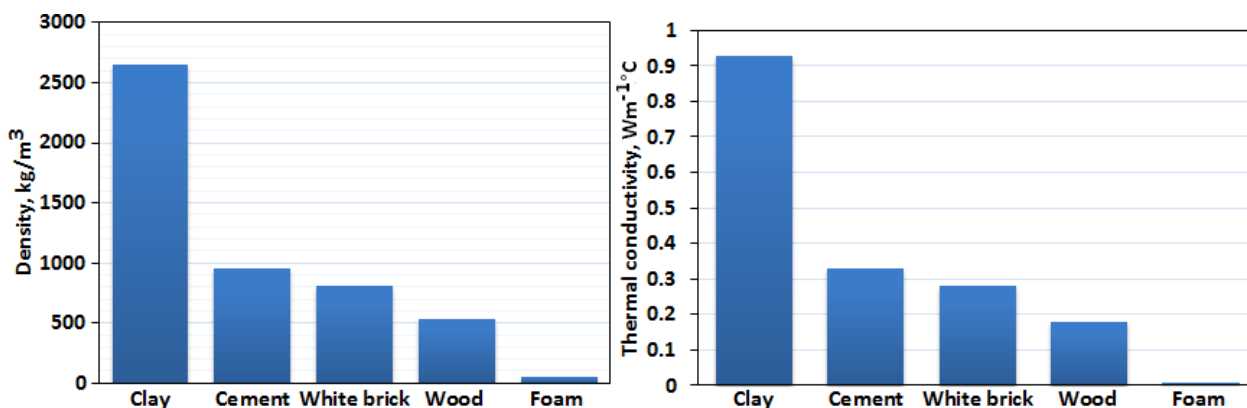


Fig. (2):The density of the used materials Fig. (3):The thermal conductivity of the used materials

The wood, cement and white brick, samples absorbed 14, 24, and 18 % of water, while the foam simple didn't absorb any water. The cement and white brick samples showed greater loss than wooden sample during the most of the drying time. At the end of the drying process the wooden samples lost much water because the cement and white brick samples were already dried. Generally, cement and white brick samples absorbed more water and lost it faster than wooden one.

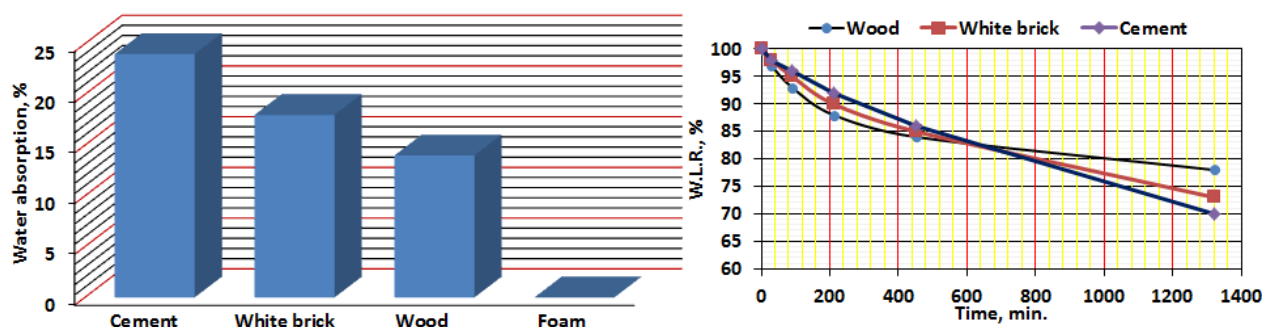


Fig. (4): The water absorption, % of the used materials Fig. (5): Water loss from white brick and wooden samples Factors affecting inside hive temperature, °C: The main inside hive temperature was increased 52.45% than the outside air temperature, because honeybee colonies rise the inside hive temperature to regulate the brood nest temperature.

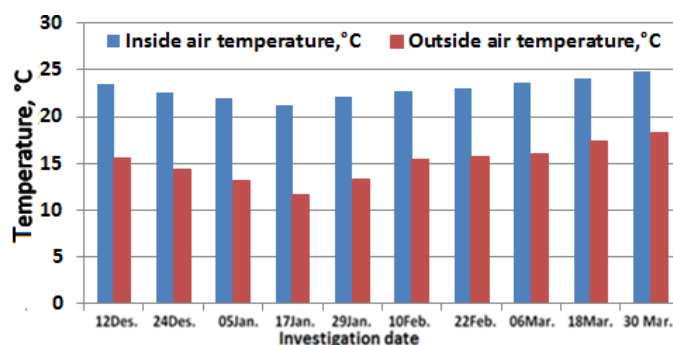


Fig. (6): The inside and outside air temperature, °C during the experiment period

The mean inside hive temperatures were increased 8.24 and 2.91 % than it in wooden hives for foam and clay hives, respectively, but it were decreased 4.34 and 8.29 % when using cement and white brick hives, respectively. There was a little difference in inside hive temperature, °C with reference to the type of material, because honeybee colonies regulated the brood nest temperature all of foam, clay, wood, cement and white brick hives. This result agrees with (Myerscough, 1993). The mean inside hive temperatures were increased from 21.79 to 24.04 °C when increasing side thickness from 1 to 3 cm, because the rate of heat flux through the hive sides decrease by increasing the sides thicknesses. The mean inside hive temperatures were increased from 21.23 to 24.78 °C when decreasing hive size from 0.114 to 0.057 m<sup>3</sup>. This due to the small internal environment needed to regulate by the bee worker.

Factors affecting number of occupied frames: The maximum mean number of occupied frames was 8 for foam and clay beehive at the end of March. The minimum number of occupied frames was 2 frames in the middle of January for wood, cement and white brick beehives. The main number of occupied frames for foam and clay were increased 20.45 and 13.64 % than it in wooden hive and decreased 11.36 and 15.91% for cement and white brick, respectively. This is due the higher internal temperature, which improve the colony performance and decrease mortality of worker bees. The mean number of occupied frames

were increased from 4 to 5 frames. when increasing side thickness from 1 to 3 cm, due to the improve of the inside hive temperature by increasing the sides thicknesses. The mean number of occupied frames were increased from 4 to 5 frames when decreasing hive size from 0.114 to 0.057 m<sup>3</sup>. This due to the improve of inside hive temperature and consequently, of the colony performance by decreasing the hive size. Factors affecting colony weight, kg: The mean net colony weight were increased 24.85 and 10.82 % than it in wooden hives for foam and clay hives, respectively, but it were decreased 10.48 and 17.89 when using cement and white brick hives, respectively. This is due the improvement of colony performance and productivity. The mean net colony were increased from 5.40 to 6.90 kg when increasing side thickness from 1 to 3 cm, due to the improve of the inside hive temperature by increasing the sides thicknesses. The mean net colony weight, kg were increased from 5.43 to 6.75 kg when decreasing hive size from 0.114 to 0.057 m<sup>3</sup>. This due to the small internal environment needed to regulate by the bee worker.

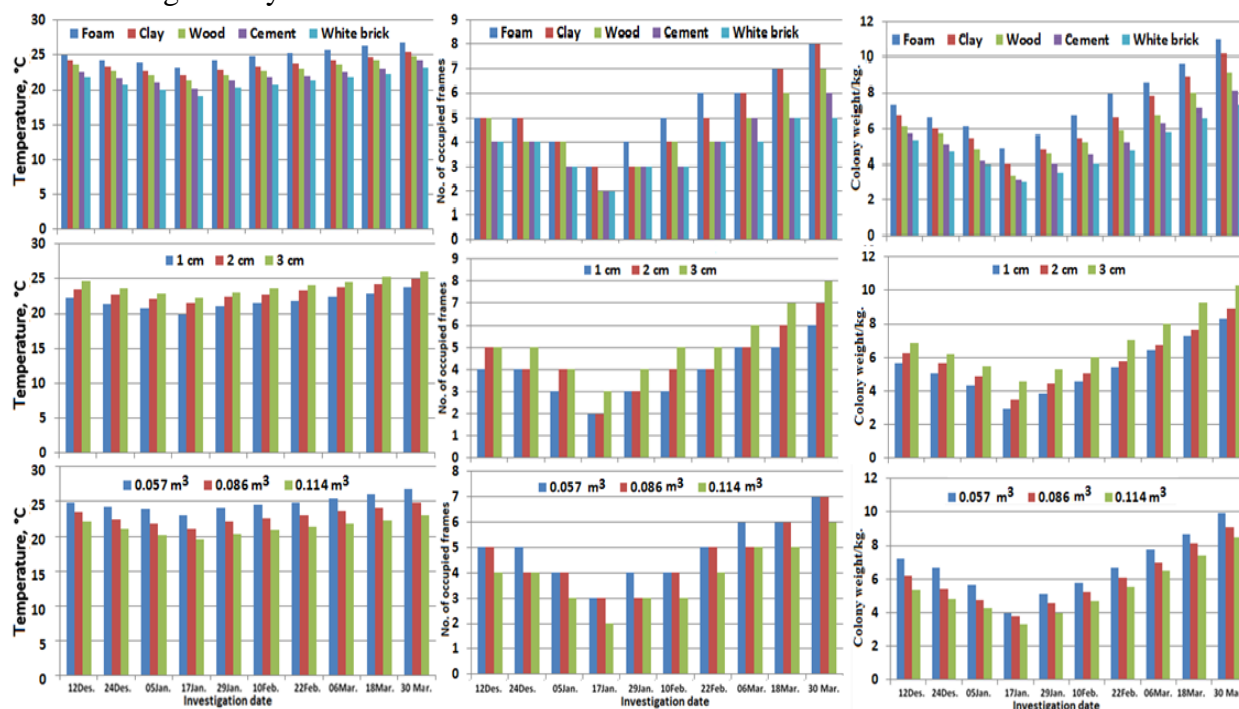


Fig. (6): Factors affecting hive temperature, number of occupied frames and colony weight  
 It was noticed that the main inside hive temperature, number of occupied frames, and net colony weight, kg increased; with hive building materials, hive sides thicknesses and hive sizes, according to the following descending order (foam > clay > wood > cement > white brick); (3 cm > 2 cm > 1 cm) and (0.057 m<sup>3</sup> > 0.086 m<sup>3</sup> > 0.114 m<sup>3</sup>), respectively. In general, the main inside hive temperature, number of occupied frames, and net colony weight, kg were decreased for each type of material all levels of hive thicknesses and sizes from, the first day of the experiment (12 December, 2014) up to the nearly middle of January (17 January, 2014) and started to increase from the end of January (29 January, 2015) up to the end of the experiment (30 March, 2015). This is due the effect of changes in ambient temperature during the study. Factors of external ambient conditions are very important to the productivity of honeybees (Cetin, 2004). The main theory to explain why brood production reduces during cold periods is that workers spend more energy in heating the colony than with tasks related to brood production (Engels et al., 1995). Also, ambient temperature has a great effect on foraging activity (Al-Qarni 2006 and Blazyte-Cereskiene *et al.* 2010). In regards to inside hive temperature, number of occupied frames, and net colony weight, kg, there was no significant difference between hive material types, hive side thicknesses and hive sizes (P> 0.05). During management clay model was the most breakable especially after rainy days.

The wooden and foam model could be burned during sterilization by scorching them with a blow lamp compared with clay, cement and white brick model. Wooden and clay hives are more attractive to wax moth (*Galleria mellonella* and *Achroia grisella*). Foam hives are more attractive to rodents and more susceptible to environmental conditions. Cost estimation: The following table represents a comparison between a complete *Langstroth* beehive made of wood and foam, clay, cement and white brick hives with a thickness of 2 cm and a size of 0.57 m<sup>3</sup>.

Table (1): Production cost of foam, clay, wood, cement and white brick hives for one super.

Specification	Price				
	Foam	Clay	Wood	Cement	White brick
- Super	15	20	85	65	45
- Nest from 5 frames	350	350	350	350	350
- Cover and bottom board	15	20	65	25	10
- Total hive cost	380 L.E.	390 L.E.	500 L.E.	440 L.E.	405 L.E.
- Total hive cost without the price of the nest	30 L.E.	40 L.E.	150 L.E.	90 L.E.	55 L.E.

The construction of the new hives (foam, clay cement and white brick) after subtracting the price of the nest were 80, 73.3, 40 and 63.3 % reduction in cost relative to the price of wooden hive, that is due to the higher costs of wood Comparing with foam, clay, cement and white brick, respectively.

### Conclusions

Foam is a light-weight, cheap and a valuable material. Cement and white brick materials could be resistant to burnings. The white brick hives needed a certain care while cutting of boards and assembly of it. The disadvantages of clay consist in the more occurrence of fractures in some parts or carelessness during assembly. Some parts like cover and bottom could be cracked by rains or broken during handling, that require more care. Also clay and foam hives have presented gaps, damaging and they were more susceptible to environmental conditions. The expected life of foam hives was about one season, due to the effect of environmental conditions and rodents especially rats. The clay, cement and white brick hives are almost twice as heavy as the mass of wooded one, but it is lighter than the hive constructed by (Lengler *et al.*, 2003) with a mass of 43.55 kg. Even if the white brick presents higher water loss, the internal moisture stability in the colony should be a critical point. wooden hives were more suitable for rearing of honeybee than other hive types, but the absorption of water increase during the periods of rain, so we should protect the outsides of it with a moisture resistant product like foam (figure 1) and the upper cover with a sheet of galvanized steel or put the hives under a shelter during winter season. It was observed that during the studied months, the maximum values of inside hive temperature, flight activity, number of occupied frames and net colony weight were achieved by using foam and clay materials, but they have a less expected life and foam can't be sterilized from almost all microorganisms like fungi, bacteria, viruses, and spores by flume without burning hazard. Foam, clay, cement and white brick *Langstroth* beehive models were cheaper than the wooden beehive cost. In general, foam, clay, cement and white brick hives can be used by small or poor beekeeping in the cities that imports wood by forging currency like Egypt. On the other hand clay, cement and white brick could provide evaporative cooling by honeybees in the dry period, thus favoring honey maturation and temperature control. Thus, new hives could be performed better in dry climates than humid.

## References

- Al-Qarni A. S. (2006). Tolerance of summer temperature in imported and indigenous honeybee *Apis mellifera* L. races in central Saudi Arabia. *Saudi J. Biol. Sci.* 13: 123–127.
- Blazyte Cereskiene L., G. Vaitkeviciene, S. Venskutonyte, V. Buda (2010). Honeybee foraging in spring oilseed rape crops under high ambient temperature conditions. *Zemdirbyste-Agriculture* 97: 61–70.
- Cetin U. (2004). The effects of temperature changes on bee lost. *Uludag Bee J.*, 4 (4): 171-174.
- Engels W., P. Rosenkranz, and E. Engels (1995). Thermoregulation in the nest of the Neotropical stingless bee *Scaptotrigona postica* and a hypothesis on the evolution of temperature homeostasis in highly social bees. *Studies in Neotropical Fauna and Environment* 30 (4): 193–205.
- F.A.O. (1990). *Beekeeping in Africa*, Agriculture service bulletin no 68(6), Organization of the United Nations, Rome.
- Hauser H., Y. Lensky (1994). The effect of the honeybee (*Apis mellifera* L.) queen age on worker population, swarming and honey yields in a subtropical climate. *Apidologie* 25, 566-578.
- Hobson, J. R., J. V. (1983). Ferrocement as a material for hives. *Queensl. Agric. Journal* 109 (3), 157-160.
- Jevtic G., M. Mladenovic, B. Andelkovic, N. Nedic, D. Sokolovic and R. Strbanovic (2009). The correlation between colony strength, food supply and honey yield in honeybee colonies. *Biotechnol. Animal Husbandry*, 25: 1141-1147.
- Jones, J. C., and B. P. Oldroyd (2007). Nest thermoregulation in social insects. *Advances in Insect Physiology*, 33, 153-191.
- Lengler S.; Castagrino G. L.; Kieffer C.(2003). Evaluation of the internal temperature of beehive and wood beehives. *Informative Zum Zum*, v.34, p.14-15, 2000.
- Lorenzon, M. C. A.; R. G. Cidreira; E. H. V. Rodrigues; M. S. Dornelles; G. Pereira Jr (2004). Langstroth hive construction with cement-vermiculite. *Sci. Agric. (Piracicaba, Braz.)*, v.61, n.6, p.573-578, Nov./Dec. 2004.
- Marco Kleinhenz, B. B., F. Stefan and T. Jurgen (2003). Hot bees in empty brood nest cells: heating from within. *The Journal of Experimental Biology* 206: 4217-4231.
- Meikle, W. G.; Holst, N.; Mercadier, G.; Derouane, F. and James, R. R. (2006). Using balances linked to dataloggers to monitor honey bee colonies. *J. Apic. Res.*, 45: 39-41.
- Myerscough M. R. (1993). A simple model for temperature regulation in honeybee swarms. *Journal Theor. Biology*, 162 (3), 381-393.
- Neves J. O. (2002). Hives effect built in mortar cement vermiculite on the performance of Africanized bees (*Apis mellifera* Linnaeus, 1758), in the stretching step. Rio de Janeiro: UFRRJ 2002. 45p. (Dissertation - Master).
- Ojeleye B. (1999). *Foundation of Beekeeping in the tropics*. CEBRAD press Ibadan, Nigeria: 1-225.
- Padilha J. A. S.; Filho R. D. T.; Lima P. I. L.; Joseph, K.; Leal, A. F. (2001). Lightweight reinforced mortar with sisal pulp: low thermal conductivity composite for use in rural buildings. *COMBEA*, v. 2, p. 1-11, 2001.
- Rodrigues E. H. V. (1998). Development and evaluation of an evaporative system, by intermittent spraying, on aviary cover using distorted scale models. São Paulo: UNICAMP / FEAGRI, 1998. 178p. (Thesis - Doctorate).
- Soares A. E. E. & Bannwart L.T. (1989). Fibercol a new type of hive for *Apis mellifera*. IN: *Latin-Iberian-American Congress of Beekeeping, III, Annals*. p. 300-306.
- Stangenhaus C. and R. Paredes (1992). Hygrometric comfort, buildings, weights and proposal for humid tropical climate in summer situations. Rio de Janeiro: UFRRJ, 1992. 199p. (Thesis - Master's degree).
- Wiese, H. (1974). *New Beekeeping*. Porto Alegre: Livraria e Editora Agropecuária Ltda., 493 p.

## **RECOLONIZATION OF CULTURAL LANDSCAPES BY LARGE PREDATORS: CHALLENGES AND RECOMMENDATIONS USING GREY WOLF (*CANIS LUPUS*) AS AN EXAMPLE**

Sven HERZOG

Dresden University of Technology, Chair of Wildlife Ecology and Management, PienerStrasse 8 D-01737  
Tharandt, Germany, herzog@forst.tu-dresden.de

### **Abstract**

The present paper deals with the question as to how the re-colonization of Central Europe by large predators, i.e. Brown bear (*Ursus arctos*), Lynx (*Lynx lynx*) and especially Grey wolf (*Canis lupus*) has to be supported by active management efforts. It defines some important future needs of active management based on an analysis of the last decade of re-migration in Germany. Whereas Brown bear and Lynx are spontaneously re-migrating only sporadically, and for Lynx we find some more or less successful re-introduction projects, the actual situation of Grey wolf in Central Europe is characterized by a high rate of re-colonization, establishing local packs and reproducing successfully. In Germany, an exponential population increase (clearly at the actually still low level) is to be observed actually. As a consequence, conflicts between different stakeholders with respect to the wolf management are also increasing. Over the last 15 years the core business area of large predator management was to avoid or to reduce those conflicts. However, conflicts between different stakeholders are increasing, and management has failed to a large extent. It is shown that existing management plans e.g. by several German states are not sufficient to guarantee an adequate management of the species, minimizing the existing conflicts between different stakeholders. The existing management plans and protective legislation are to be exempted from bureaucratic restrictions and improved on a scientific basis. It is further shown that participatory processes involving all relevant stakeholders are required in development of management plan as well as in conservation legislation. In addition, there is a lack of fundamental knowledge concerning the development of wolf-man interactions in densely settled and urban environments. So, the actual situation requires also intensive research on questions as predator-prey-relationships, dynamics of re-colonization by the wolf, disease management, hybridization, development of repellent techniques and, last but not the least, research on the question as to how we can maintain timidity against man.

**Key words:** *large predators, Canis lupus, re-colonization, conflicts, management*

### **Introduction**

Large Predators are actually re-colonizing huge parts of Central Europe. In addition, they are subject of several reintroduction programs.

The story of extinction of large predators, especially wolf and brown bear is by far a story of socio-cultural and socio-economic structures in this region. If we recall that until the 19<sup>th</sup> century Central Europe was characterized to be an agricultural region, dominated by small family farms of few hectares. The property of a cow or some sheep or goats symbolized significant economic wealth. Thus, the loss of a sheep or even a cow by large predators did mean the loss of the livelihood of the farmer and his family. The extinction of large predators, in that context, was consequent from the former point of view.



However, in several parts of Europe, the extinction was not complete, so wolf, lynx or even brown bear survived in some regions (e.g. Italy, France, Spain or the Balkans) as small, isolated populations. In other parts of Europe such as Germany, the “Benelux” region or Switzerland, the extirpation was performed more consequently.

Beside this situation, in major parts of the Palaearctic Grey wolf is regularly to be killed not only based on sustainable hunting, but also by so called „population control“ or “predator control“ measures, often being an euphemism for efforts to exterminate the species locally. North America, Eastern Europe or Central Asia provide examples. In the European Union, the management of large predators ranges from a sustainable utilization by regular, controlled hunting (as e.g. for the wolf in Estonia) to a more or less uncritical total protection (as e.g. in Germany or Austria, see also Guber and Herzog 2017).

## **Results and discussion**

### **Goals**

From a wildlife management point of view, the goal should be to establish viable, adaptable populations in suitable habitats, which is accepted by the local land users and by the local human population (Herzog, 2016).

Whereas Brown bear and Lynx have particular habitat requirements, Grey wolf is a generalist, able to live nearly everywhere: absence of persecution and presence of food are the only preconditions. This means that Grey wolf will be the most important target species of large predator management in Central Europe.

Thus, in the present paper, the challenges and recommendations for a large predator management in Central Europe will be compiled using the Grey wolf as an example.

### **Population dynamics**

There was an intensive discussion in the past, if anthropogenic mortality in large mammal species is tending to be either additive or compensatory (see e.g. Ellenberg 1978, Lebreton 2005). Today we recognize that this question has to be differentiated concerning species as well as concerning the actual status of a (sub)population. Compensatory mechanisms might be especially a higher reproduction rate, and/or a reduction of other anthropogenic and/or natural factors influencing mortality.

Many studies on Grey wolf (see e.g. Jędrzejewska *et al.*, 1996; Mörner *et al.* 2005, Lovari *et al.* 2007, Brainerd *et al.* 2008, Creel and Rotella 2010, Liberg *et al.* 2011, Sparkman *et al.* 2011) are dealing with anthropogenic mortality. However, the problem is that they look at “anthropogenic mortality” *in toto*. For management purposes, it should be clear that the factor “anthropogenic mortality” has to be analyzed in more detail. So, for example, it should be assumed that the consequences of a controlled, sustainable utilization are different from those of “predator control” measures or even poaching. In addition, there is no doubt that the effects of those measures are different for a very small, just founded (sub)population of only one or few wolf packs, compared to a well-established, constantly growing subpopulation.

Thus, as a first result, we have to state that anthropogenic mortality has to be considered more differentiated as previous papers do. Generally, we can subdivide the topic into different categories (see Table 1).

For Germany, Grey wolf population dynamics during re-colonization has been studied by Herzog (2014). Although a precise data base is lacking, road kills are assumed to be the most important mortality factor.

However, the German subpopulation, regarded as the westernmost part of the huge Baltic-Eastern European wolf population, actually shows an unbowed exponential growth. This would mean that even road kills either are of compensatory character or at the most resulted in a slight shift of the growth function.

Table 1. Categories of anthropogenic mortality in large predators (following Herzog, 2014)

Category	Examples
Predator control	Intentional, more or less controlled reduction of population size. Actually not practiced in Central Europe
Sustainable hunting	Controlled, planned wolf hunting for utilization e.g. in Baltic states
Illegal hunting, not sustainable hunting, poaching	Killings from different reasons without (legal) control
Accidents (unintentional)	Collisions along roads or railroad tracks, strangulation in fences

As a consequence, it should be clear that differentiation only between anthropogenic and natural mortality is not sufficient. Anthropogenic mortality should be differentiated into

- compensatory mortality (balanced by other natural or anthropogenic mortality factors)
- additive mortality (with care and attention of sustainability criteria)
- additive mortality (without care and attention of sustainability criteria)

Thus, it should be easily possible to differentiate intended from unintended effects of management measures or other influences. This is an indispensable basis for serious management recommendations.

Regardless of the presumably low impact of wolf road-kills on population dynamics, management in the special situation of a densely inhabited landscape with huge urban region and a close-meshed network of roads and railroad tracks calls for particular solutions (see also Polster et al. 2014, Polster and Herzog 2014).

### **Actual major problems**

As the actual discussion about re-colonization of Grey wolf shows, there are a lot of unsolved or even unknown conflicts existing between different stakeholders. The fact that these conflicts persist since more than 15 years points to some serious failings of wolf management. The present chapter gives an overview on some actual problems and highlights some potential ways to solve these problems.

### ***Predation of wildlife***

In Central Europe, wolf prefers Roe deer (*Capreolus capreolus*) and Red deer (*Cervus elaphus*) as prey species, whereas Wild boar (*Sus scrofa*) is subordinated (Wagner *et al.* 2012). We have actually no reliable scientific data, but it seems that local subpopulations of these species are slightly influenced by lowering their abundance. However, a serious threat

could not be observed. Reports of significant reductions of population size concern fallow deer (*Cervus dama*), and, especially, mouflon (*Ovis ammon musimon*). The latter species will be supposedly extirpated by large predators such as wolf or even lynx. This is a very particular conflict of different species conservation goals. This wild sheep subspecies is highly endangered and close to extinction in its natural habitats in Corsica and Sardinia. The Central European populations represent the majority of the gene pool of the subspecies and might be regarded as a very effective *ex-situ* gene conservation measure (see e.g. Piegert and Uloth 2000, Herzog and Schröpfer 2016).

As long as we have no well established, active wolf management in many European countries, we have to bridge this period with conservation measures designed especially for the mouflon.

Another problem, especially in Germany, is that the question of an area-wide occurrence of prey species in adequate densities is completely disregarded. Due to forest economic and agricultural concerns, especially red deer is not tolerated in huge parts of the potential wolf areas. This shows once more the weak performance of actual wolf management.

### ***Predation of livestock***

Predation of livestock is actually the most critical area of conflicts.

Actually, the focal point is the predation of small livestock such as sheep, goats, alpacas or farmed fallow deer. The economic impact of this phenomenon is from a viewpoint of nature conservation authorities, being responsible for the wolf management, quite low. Thus, the idea of compensation payments as well as some financial support of protective and repellent measures, is favored by administration and politics. However, an increasing period of total protection of wolves will certainly lead to a significant loss of timidity. This will result in a decreasing efficiency of protective measures and, as a consequence, an increased rate of livestock predation.

Additionally, more reports of predation of larger livestock such as cattle or horses show up. Apart from economical or non-material value of these animals, the risk of traffic collisions with animals brought into panic by wolf attacks will increase. This bears the risk of immense economic impact and body-injuries indirectly resulting from wolf attacks on livestock in the future.

Also from a nature conservation viewpoint, we will get roped into serious conflicts. Grazing with livestock is an important and relatively cost efficient method of keeping landscapes open and prohibit special protected plant societies from succession. If livestock farming is becoming uneconomical by presence of the wolf, these conservation concepts in open landscape protection will fail at a long-term scale.

### ***Hybridization***

The question of hybridization between wolf and domestic as well as between wolf and jackal (*Canis aureus*) in Central Europe is still open. Dependent on the role of hybridization in the past, especially in the abruzzo-alpine wolf population, being over centuries in more or less narrow contact to domestic dogs, we have actually no clear evidence if molecular markers are discriminative or not (see e.g. Tsuda *et al.* 1997, Randi *et al.* 2014). As recent studies show, admixtures of canid taxa, previously regarded as different species, are regularly occurring (vonHoldt *et al.* 2016).

The central problem of hybrids between domestic dog and wolf is the problem of maintainance of timidity (Herzog 2016). Decades of dog breeding contributed to a reduced timidity against man. Hybridization is assumed to increase the risk of wolf attacks against man and thus it bears an immense risk of increasing conflicts.

In this context, we have also to ask, if the renouncement of re-introduction of single wolf individuals will be helpful to avoid hybridization. Maybe, active release of a male or female might help to reduce the risk of hybridization, if a single wolf is to be observed in a region over a longer period (see Herzog 2016).

### ***Diseases***

Out of the number of diseases wolf can suffer from, only a few are relevant for active wolf management.

Maybe not most important, but for avoidance of conflicts most relevant is rabies. We know that wolf was a major factor for transmission of this zoonosis to man in the past. The extinction of wolf in the 18th and 19th century made red fox (*Vulpes vulpes*) increasingly important in that context.

Actually, responsible authorities have no concept of prevention, especially no vaccination concept, neither for the wolf, nor (especially in Saxony with the highest wolf abundances in Western Europe) for the fox.

In addition, distemper, aujeszky's disease and (with increasing abundances of wolf) scabies will maybe also play a major role in the future. However, these diseases will be not so controversial, but maybe they will be able to reduce abundance significantly.

### ***Public relations***

The actual public relations campaigns on wolf are focused on an urban population, and can be summarized (with a little simplification) that the big bad wolf is a nice and cosy animal that never has predated neither Little Red Riding Hood nor the grandmother.

The problem is: no one is still believing these stories, and the urban population yet has by trend a very positive image of wolf.

The real resentments against wolf come from highly professional groups of stakeholders, such as small livestock farmers, with real problems, that are not to be sugarcoated by some high-gloss flyers. These people need feasible solutions and a legislation incorporating their needs.

### **Conclusions**

Actually, most Central European countries are tending to a total protection concept with no active influence on the population. What is called "wolf management" in Germany and Austria, is a kind of passive observation of the ongoing situation. This might be a proper approach in an early state of a re-colonization process. To avoid major risks for the future, this concept has to be replaced by a more sophisticated approach, defining clear goals and taking different measures of management into consideration.

Good examples of e.g. Slovakia or Baltic countries should be taken into consideration. A local differentiation and a combination of different management measures, as e.g. total protection, sustainable utilization, prevention of diseases, herd protection measures and a management concept, developed from a participatory process should be a solution.

The present paper might have been shown in short that an active wolf management is needed especially in Central Europe with the particular civilisatory situation. A passive "wait and see" strategy is bound to fail, and failure of wolf management would mean huge problems for the wolf as well as for man in the future. Thus, we should focus on a foresight strategy,

including a sophisticated concept of management measures, covering the whole spectrum of management methods in the near future to prevent conflicts are getting out of hand.

### References

- Brainerd, S. M., Bangs, Edward E., Bradley, E. H., Fontaine, J. A., Hall, W., Iliopoulos, Y., Jimenez, M. D., Jozwiak, E. A., Liberg, O., Mack, C. M., Meier, T. J., Niemeyer, C. C., Pedersen, H. C., Sand, H., Schultz, R. N., Smith, D. W., Wabakken, P., Wydeven, A. P. (2008): The Effects of Breeder Loss on Wolves. *Journal of Wildlife Management* 72:89–98.
- Creel, S., Rotellea, J. J. (2010): Meta-analysis of relationships between human offtake, total mortality and population dynamics of gray wolves (*Canis lupus*). - *PloS ONE* 5, 1-7.
- Ellenberg, H. (1978): Zur Populationsökologie des Rehes (*Capreolus capreolus* L., Cervidae) in Mitteleuropa. *Spixiana, Zoologische Staatssammlung, Suppl. 2*: 211 S.
- Guber, S., Herzog, S. (2017). Die naturschutzrechtliche raum- und wirkungsbezogene Klassifikationssystematik von Arten sowie daraus folgende staatliche Handlungspflichten - erläutert an den Arten Mufflon (*Ovis ammon musimon*) und Wolf (*Canis lupus*). *Natur und Recht* 39, 73-88. p-ISSN 0172-1631, e-ISSN 1439-0515, DOI 10.1007/s10357-017-3133-0
- Herzog, S. Mortalität durch Verkehrswege beim Wolf (*Canis lupus*) – ein Artenschutzproblem? *Säugetierkundliche Informationen*, 9, 48, 235-242, 2014.
- Herzog, S. Von Wölfen und Menschen: Für einen undogmatischen Umgang mit einem Heimkehrer. *Beiträge zur Jagd- und Wildforschung* 41, 227-237, 2016.
- Herzog, S., Schröpfer, R. (2016). Das Mufflon *Ovis ammon musimon* (Pallas, 1811) in Europa: Faunenverfälschung oder Maßnahme der ex-situ-Generhaltung? *Säugetierkundliche Informationen*, 10, 52, 259-264. ISSN 0323-8563, ISBN 978-3-00-046295-5.
- Jędrzejewska, B., Jędrzejewski, W., Bunevich, A. N., Minkowski, L., Okarma, H. (1996): Population dynamics of Wolves *Canis lupus* in Biłowieża Primeval Forest (Poland and Belarus) in relation to hunting by humans, 1847-1993. *Mammal Review*, 26:103-126. DOI: 10.1111/j.1365-2907.1996.tb00149.x
- Lebreton, J.-D. (2005): Dynamical and statistical models for exploited populations. *Centre d'Ecologie Fonctionnelle et Evolutive. Aust. N. Z. J. Stat.* 47(1), 49–63.
- Liberg, O., Chapron, G., Wabakken, P., Pedersen, H. C., Hobbs, N. T., Sand, H. (2011): Shoot, shovel and shut up: cryptic poaching slows restoration of a large carnivore in Europe. *Proceedings of the Royal Society B*, e-publishing, doi: 10.1098/rspb.2011.1275.
- Lovari, S., Sforzi, A., Scala, C., Fico, R. (2007): Mortality parameters of the wolf in Italy: does the wolf keep himself from the door? University of Siena, Italy. *Journal of Zoology* 272, 117–124, doi:10.1111/j.1469-7998.2006.00260.x.
- Mörner, T., Eriksson, H., Bröjer, C., Nilsson, K., Uhlhorn, H., Ågren, E., Hårdaf Segerstad, C., Jansson, D.S., Gavier-Widén, D. (2005): Diseases and Mortality in free-ranging Brown Bear (*Ursus arctos*), Gray Wolf (*Canis lupus*), and Wolverine (*Gulo gulo*) in Sweden. *Journal of Wildlife Diseases*, 41(2), 298–303.
- Piegert, H., Uloth, W. (2000). *Der Europäische Mufflon*. DSV-Verlag, Hamburg.
- Polster, J.-U., Pfarre, C., Herzog, S. (2014). Möglichkeiten der olfaktorischen und akustischen Vergrämung des Wolfes (*Canis lupus*) an Verlehrswegen: Erste Ergebnisse einer Gehegestudie. *Säugetierkundliche Informationen*, 9, 48, 281-288.

- Polster, J.-U., Herzog, S. (2014). Studies on deterrent agents for predator and prey species to avoid wildlife collisions along transport routes on the example of Grey wolf (*Canis lupus*) and Red deer (*Cervus elaphus*). *Mammalian Biology* 79S, 16.
- Randi, E., Hulva, P., Fabbri, E., Galaverni, M., Galov, A., Kusak, J., Bigi, D., Bolfiková, B.Č., Smetanová, M., Caniglia, R. Multilocus Detection of Wolf x Dog hybridization in Italy, and Guidelines for Marker Selection. *PLoS ONE* 9(1): e86409.
- Sparkman, A.M., Waits, L.P. & Murray, D.L. (2011): Social and Demographic Effects of Anthropogenic Mortality: A Test of the Compensatory Mortality: Hypothesis in the Red Wolf. *PLoS ONE* 6(6): e20868. doi:10.1371/journal.pone.0020868.
- Tsuda, K., Kikkawa, Y., Yonekawa, H., Tanabe, Y. (1997). Extensive interbreeding occurred among multiple matriarchal ancestors during the domestication of dogs: Evidence from inter- and intraspecies polymorphisms in the D-loop region of mitochondrial DNA between dogs and wolves. *Genes genet. Syst.* 72, 229-238.
- Von Holdt, B.M., Cahill, J.A., Fan, Z., Gronau, I., Robinson, J., Pollinger, J.P., Shapiro, B., Wall, J., Wayne, R.K. (2016). Whole-genome sequence analysis shows that two endemic species of North American wolf are admixtures of the coyote and gray wolf. *Sci. Adv.* 2:e1501714.
- Wagner, C., Holzapfel, M., Kluth, G., Reinhardt, I., Ansoerge, H. (2012). Wolf (*Canis lupus*) feeding habits during the first eight years of its occurrence in Germany. *Mammalian Biology* 77, 196-203.

## EVALUATION OF AN INDICATOR FOR THE RISK OF DIFFUSE PHOSPHORUS LOSSES IN NORTHEAST GERMANY

Uwe BUCZKO

Landscape Ecology and Site Evaluation, University of Rostock, Rostock, Germany

\*Corresponding author: uwe.buczko@uni-rostock.de

### Abstract

For the assessment and mitigation of diffuse Phosphorus (P) losses from agricultural fields into surface waters, knowledge of P contents in soils and P application rates are not sufficient, because diffuse P losses depend also on transport factors such as erosion, runoff and subsurface drainage. The “Phosphorus Index” (PI) is a risk assessment tool for diffuse P losses from agricultural fields which is based on a simple algebraic combination of source (soil test P, fertilizer, and manure additions) and transport factors (e.g., erosion, runoff, subsurface drainage, riparian buffer strips). The objectives of this study were to develop and evaluate a PI for NE Germany. This PI is based on the Pennsylvania and Danish P Indices but accounts in addition for wind erosion, soil leaching potential, and groundwater influence. A sensitivity analysis showed that soil test P, manure application and the riparian buffer factor have the largest impact on PI values. An application in two mesoscale catchments revealed different area-averaged PI values, which largely correspond to measured P losses by riverine flow at the catchment outflow. The results show that the proposed P index is a good indicator for P loss at the catchment scale. More detailed studies to evaluate the P Index at the field scale are currently underway.

**Keywords:** *agricultural nutrient management, non-point source pollution, phosphorus export, phosphorus index, water quality*

### Introduction

Although P is an essential nutrient for plant growth, excessive amounts in surface waters are a major factor causing eutrophication. Whereas until recently, point sources of P (like sewage treatment and/or water purification plants) were the major source of P loading into surface waters, P loadings from diffuse sources, mainly agriculture, are a major focus of concern since the 1990's (Behrendt *et al.*, 2003; Sharpley *et al.*, 2003; Delgado and Scalenghe, 2008; Nausch *et al.*, 2011). For effective control of P losses into surface waters, an assessment of the susceptibility for P loss at the field scale is necessary. Many studies (see Buczko and Kuchenbuch, 2007) have shown that P losses from fields into surface waters depend not only on soil P contents and fertilizer applications, but also to a large degree on transport factors such as erosion, surface runoff, and subsurface drainage. This knowledge is incorporated into simplified risk indicators for P export from agricultural fields which have been developed since the 1990's (Lemunyon and Gilbert, 1993; Sharpley *et al.*, 2003; Buczko and Kuchenbuch, 2007). Such "Phosphorus Index" (PI) approaches account for different source and transport factors and the resulting PI values are a measure for the risk of P export from a single field. The PI approach is routinely applied in the USA (Sharpley *et al.*, 2003) and it has been adopted in several European countries, especially in Scandinavia (e.g., Heckrath *et al.*, 2008).

The PI is a simplistic and pragmatic approach, which largely neglects or simplifies several processes and factors at the small scale, which are possibly relevant for P losses. However, it has been shown that this approach is suitable for delineating fields with a high risk for P export within watersheds and of defining best management practices to mitigate P losses from those fields (Sharpley *et al.*, 2003). Thus, it seems useful to test or to adopt a similar approach also in countries in which risk of P loss is evaluated until now based on soil test P values mainly, as for instance in Germany.

In the Mecklenburg-Vorpommern (MV) state, diffuse (non-point-source) P losses are comparatively low for most regions. However, there are few hot spots with elevated P concentrations and large input of manure P, mostly near cattle feeding operations and dairy farms. Thus, our objective was to review the factors contributing to P loading from agricultural land into surface waters in NE Germany and to present an index for the assessment of the risk of diffuse P losses for this region. This PI will allow the more accurate adjustment of manure and fertilizer additions in “hot spot” regions at the field scale based on a relatively simple modelling approach which incorporates all important source and transport factors.

### Material and Methods

Diffuse phosphorus losses from agricultural fields in NE Germany are characterized by a high proportion of wind erosion, widespread occurrence of tile drainage, many peat soils and large areas with shallow groundwater tables. Based on these factors and a review of existing P indices (Buczko and Kuchenbuch, 2007), a PI is proposed for the MV state in which source and transport factors are grouped into two major separate terms, which are multiplied to calculate the final PI value, “PI(MV)” (Fig. 1).

Source factors encompass soil test phosphorus (STP), mineral fertilizer and manure:

Plant-available soil P contents are assessed in Germany using the CAL or the double-lactate (DL) extraction method. The resulting STP values are divided into five nutrient content classes, A - E. For calculating the PI(MV), these STP classes are assigned the numerical values A = 10, B = 20, C = 30, D = 40, E = 50.

Phosphorus additions in form of organic or mineral fertilizer form a distinctly separate P pool besides soil P. The proportion of soluble P components in manure or fertilizer is usually higher compared to those in the soil (Kleinman *et al.*, 2005). A further distinction is made between organic and mineral fertilizer additions, because they exhibit differences in solubility, P content, availability to runoff and physical properties (Withers *et al.*, 2001; Kleinman *et al.*, 2002).

Manure availability accounts for the availability of P to be lost directly from the manure to runoff. This availability is not identical with crop availability of manure P. Values range from 1.0 for swine slurry to 0.2 for heat-dried or advanced-alkaline stabilized biosolids.

Transport factors: In general, water erosion is the main transport process for phosphorus loss from arable fields (Sharpley *et al.*, 2003). Since maps of potential risk of water erosion are available for the whole of MV, those risk ratings rather than estimated soil losses are used in the PI(MV). The risk ratings are categorized into 5 classes and based on the type and texture of the soil and morphological properties (slope steepness and length). In terms of the universal soil loss equation (USLE), the potential risk of soil erosion encompasses the soil erodibility factor ("K"), the slope length factor ("L") and the slope steepness factor ("S"). Calculation of erosion rates based on these risk ratings with the USLE or RUSLE is straightforward provided data on vegetation cover, management practices and rainfall erosivity are available. Similar as water erosion, wind erosion is assessed in the PI(MV) using erosion risk classes with ratings between 0 (“none”) and 5 (“very high”). It has been shown in many field studies that riparian buffer strips can cause a marked reduction (up to 90 %) of phosphorus loads into receiving



waters (e.g., Dorioz *et al.*, 2006). This reduction depends on buffer width (Hook, 2003; Kronvang *et al.*, 2005), vegetation type and density (Schoonover *et al.*, 2006), magnitude of erosion or flow rate (inversely related, Kronvang *et al.*, 2005), time scale (Dorioz *et al.*, 2006), and slope gradient (Hook, 2003).

In most studies, it was found that buffer widths had a greater effect on the reduction of P loads, compared with the other factors (Hook, 2003; Kronvang *et al.*, 2005). Because of this, and since buffer widths are relatively easy to quantify, it is assumed in the PI(MV) that the effectiveness of riparian buffer strips is solely a function of their width, with the following classes for the buffer factor: < 2 m: 1.1; 2 – 6 m: 1; 6 – 20 m: 0.7; > 20 m: 0.5.

Besides riparian buffers, the connectivity between fields and receiving waters depends on the distance between field and stream (Buczko and Kuchenbuch, 2007). The "contributing distance" factor used in many recent P indices is thus a measure for the probability that a field within a specified distance to the stream contributes to P loss. In the PI(MV), a threshold value of 50 m was adopted from the Denmark and Norway P indices.

Transport through artificial tile drains can be an important factor of P loss from agricultural fields (Sims *et al.*, 1998), small watersheds (Gelbrecht *et al.*, 2005), and even at the scale of large catchments (Behrendt *et al.*, 2003; Deumlich and Völker, 2004). The soil type has a pronounced influence on the propensity for subsurface P leaching. The especially high disposition for subsurface P leaching of organic soils with low contents of sesquioxides (Fe and Al oxides) has been known for a long time (Larsen *et al.*, 1958; Cogger and Duxbury, 1984). More recently, high P leaching has been documented for sandy soils (Sims *et al.*, 1998), but even more in well-structured, fine-textured soils with macropores (Djordjic *et al.*, 2004). Based on several comparative studies of differently textured mineral and organic soils (Larsen *et al.*, 1958; Djordjic *et al.*, 2004) the following general order for the susceptibility of soils for vertical P leaching is incorporated in the PI(MV): organic soils > macroporous clay soils > sandy soils > loam soils.

Transport of P via groundwater can be important (e.g., Behrendt *et al.*, 2003; Gelbrecht *et al.*, 2005). P loss from surface soils into groundwater and concomitant lateral saturated flow is often inversely proportional to the depth of the groundwater table, i.e., shallow groundwater bodies favour P loss by groundwater flow (Stämpfli and Madramootoo, 2004). Further, shallow groundwater tables create reducing conditions in shallow soil depths which favour the P mobility in the soil (Rupp *et al.*, 2004). When no data on groundwater (GW) depths are available, the GW-factor can be estimated from soil surveys.

The sensitivity of the PI model was evaluated using both absolute and relative sensitivity coefficients (Jesiek and Wolfe, 2005).

The PI(MV) was tested in two catchments: the Beke near Rostock, and the Zarow in the eastern part of MV. The Beke catchment is dominated by arable land use. A large proportion of the area exhibits high erosion risk (both by water and wind). In the Zarow catchment, the proportion of forest land use is considerably higher. Erosion risk is lower than in the Beke catchment, whereas the proportion of organic soils and soils with shallow groundwater tables is markedly higher.

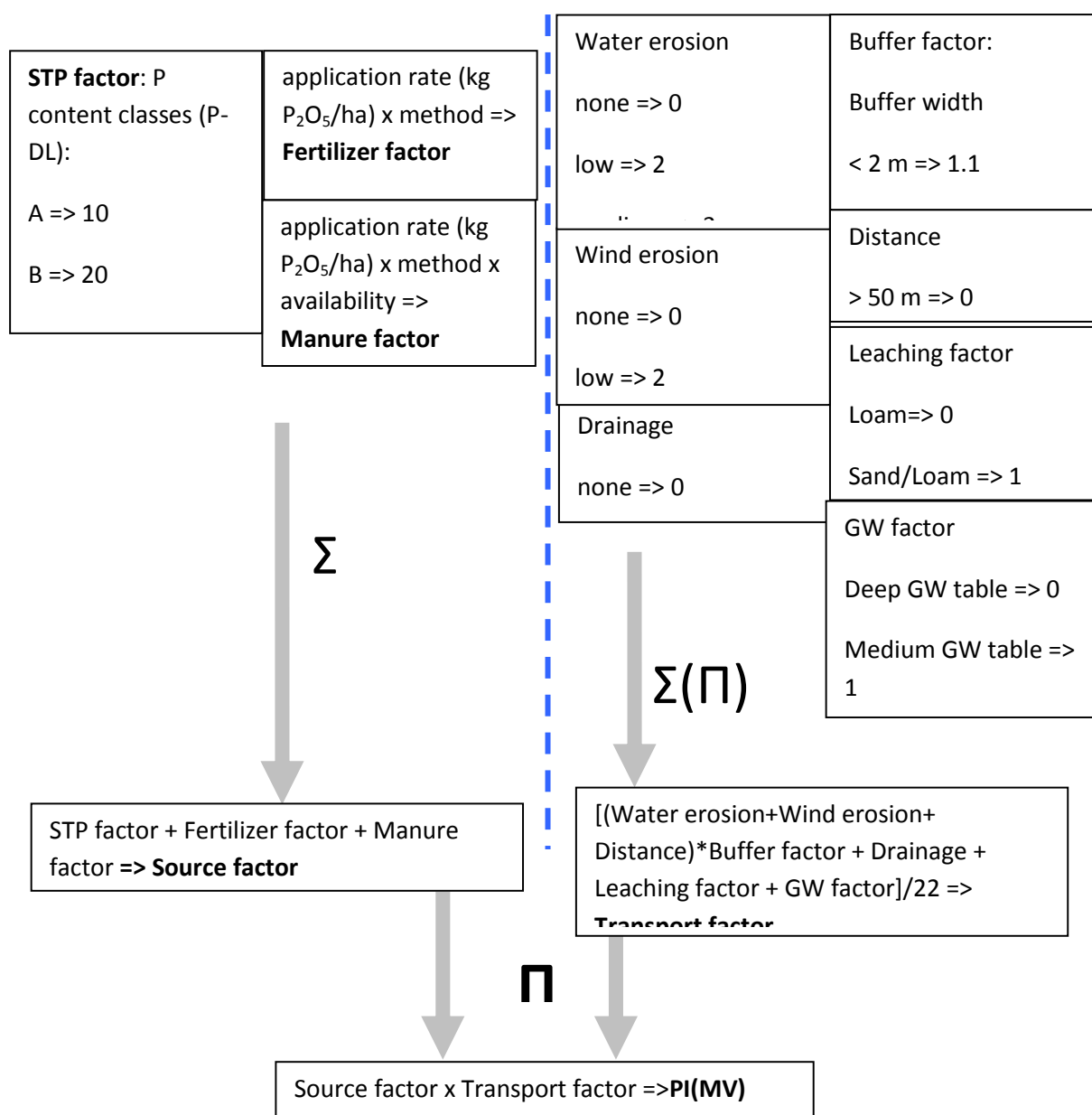


Figure 1. Structure and components of the Phosphorus Index (PI(MV)).

### Results and Discussion

The sensitivity analysis revealed the following:

1. The STP has a large sensitivity in the proposed PI(MV). This is in line with experimental results which revealed a strong dependency of P loss from the P content of the soil (e.g., McDowell and Sharpley, 2001).
2. Also, manure application rate and method have a great impact on calculated PI values, which agrees well with experimental studies of P loss with high manure applications (e.g., Kleinman *et al.*, 2002).
3. Among the transport factors, the buffer factor exhibits the highest relative sensitivity, similarly as reported by Brandt and Elliott (2005). This is supported by many field studies, which reported a huge influence of riparian buffer strips on P loadings from fields to surface waters.

4. The sensitivity of water (T1) and wind (T2) erosion seems relatively low, in view of the purported great impact of erosion on P loss in NE Germany (Behrendt *et al.*, 2003; Deumlich and Völker, 2004), but it has to be taken into account that two separate erosion factors are considered here. The area-averaged PI values are 26.6 for the Beke and 11.2 for the Zarow catchment. The distribution of PI values calculated for single fields into separate classes (not shown here in detail) reveals for the Zarow catchment a bimodal distribution with most fields exhibiting PI values < 20, but also a large proportion of fields with PI values between 40 and 100. On the other hand, PI values for the Beke catchment show a unimodal distribution with the highest proportion in the range 20 – 40. The relatively low calculated PI values are overall in line with measured P concentrations in streamwater and total P loss at the catchment outflow for the period. In both catchments, overall P loss is relatively low, but slightly higher for the Beke than for the Zarow catchment. For comparison, Gelbrecht *et al.* (2005) reported for two 37.8 and 48.9 km<sup>2</sup> catchments in Brandenburg total P losses of 4 – 25 kg km<sup>-1</sup> yr<sup>-1</sup>. Higher TP losses than measured in the Beke and Zarow catchments were also reported by Kronvang *et al.* (2003) for several European catchments with areas < 100 km<sup>2</sup>. Overall, the mean PI values for the whole catchments largely reflect the P losses from both catchments, but more detailed studies and comparisons at smaller scales (sub-catchment or field-scale) are necessary to confirm this assertion. Moreover, the spatial distribution of fertilizer and manure input has to be refined based on data for separate fields.

### Conclusions

The P index as a risk assessment tool for diffuse P loss from agricultural areas into surface waters presented here for NE Germany, especially for the federal state of Mecklenburg-Vorpommern, could possibly also be applied in a similar form in other regions of Germany. The novelty of this PI is the incorporation of wind erosion and a factor for the groundwater influence. A sensitivity analysis revealed that STP, manure input and riparian buffers have the greatest impact on PI values. A comparison of area-averaged PI values and measured P export for two 321 and 720 km<sup>2</sup> catchments revealed correlation, but evaluation on a smaller scale (sub-watershed and field-scale) is necessary. Such investigations are currently underway.

### References

- Behrendt H., Bach M., Opitz D., Pagenkopf W.-G., Scholz G., Wendland F. (2003). Nutrient Emissions into River Basins of Germany on the Basis of a Harmonized Procedure. UBA-Texte 82.
- Brandt R.C., Elliott H.A. (2005). Sensitivity analysis of the Pennsylvania phosphorus index for agricultural recycling of municipal biosolids. *J. Soil Water Cons.*, 60: 209-219.
- Buczko U., Kuchenbuch R. O. (2007). Phosphorus indices as risk assessment tools in the U.S.A. and Europe—A review. *J. Plant Nutr. Soil Sci.*, 170: 445–460.
- Cogger C., Duxbury J.M. (1984). Factors affecting phosphorus losses from cultivated organic soils. *J. Environ. Qual.*, 13: 111–114.
- Delgado A., Scalenghe R. (2008). Aspects of phosphorus transfer from soils in Europe. *J. Plant Nutr. Soil Sci.*, 171: 552-575.
- Deumlich D., Völker L. (2004). Sediment and nutrient loadings due to soil erosion in rivers : example; the Odra catchment. In: Agricultural impacts on soil erosion and soil biodiversity: developing indicators for policy analysis. Proceedings from an OECD Expert Meeting, Rome, Italy, March 2003: 187-200; Paris (OECD).
- Djordjic F., Börling K., Bergström L. (2004). Phosphorus Leaching in Relation to Soil Type and Soil Phosphorus Content. *J. Environ. Qual.*, 33: 678-684.

- Dorioz J.M., Wang D., Poulenard J., Trévisan D. (2006). The effect of grass buffer strips on phosphorus dynamics-A critical review and synthesis as a basis for application in agricultural landscapes in France. *Agric. Ecosys. Environ.*, 117: 4-21.
- Gelbrecht J., Lengsfeld H., Pöthig R., Opitz D. (2005). Temporal and spatial variation of phosphorus input, retention and loss in a small catchment of NE Germany. *J. Hydrol.*, 304: 151-165.
- Heckrath G., Bechmann M., Ekholm P., Ulen B., Djodjic F., Andersen H. E. (2008). Review of indexing tools for identifying high-risk areas of phosphorus loss in Nordic catchments. *J. Hydrol.*, 349: 68–87.
- Hook P.B. (2003). Sediment retention in rangeland riparian buffers. *J. Environ. Qual.*, 32: 1130-1137.
- Jesiek J.B., Wolfe M.L. (2005). Sensitivity analysis of the Virginia phosphorus index management tool. *Trans. Am. Soc. Agric. Eng.*, 48: 1773-1781.
- Kleinman P.J.A., Sharpley A.N., Moyer B.G., Elwinger G.F. (2002). Effect of mineral and manure phosphorus sources on runoff phosphorus. *J. Environ. Qual.*, 31: 2026–2033.
- Kleinman P.J.A., Wolf A.M., Sharpley A.N., Beegle D.B., Saporito L.S. (2005). Survey of water-extractable phosphorus in livestock manures. *Soil Sci. Soc. Am. J.*, 69: 701-708.
- Kronvang B., Bechmann M., Pedersen M.L., Flynn N. (2003). Phosphorus dynamics and export in streams draining micro-catchments. Development of empirical models. *J. Plant Nutr. Soil Sci.*, 166: 469–474.
- Kronvang B., Laubel A., Larsen S.E., Andersen H.E., Djurhuus J. (2005). Buffer zones as a sink for sediment and phosphorus between the field and stream: Danish field experiences. *Water Sci. Technol.*, 51(3–4): 55–62.
- Larsen J.E., Ruble Langston, Warren G.F. (1958). Studies on the leaching of applied labelled phosphorus in organic soils. *Soil Sci. Soc. Am. Proc.*, 22: 558-560.
- Lemunyon J.L., Gilbert R.G. (1993). The concept and need for a phosphorus assessment tool. *J. Prod. Agric.*, 6: 483–486.
- McDowell R.W., Sharpley A.N. (2001). Approximating phosphorus release from soils to surface runoff and subsurface drainage. *J. Environ. Qual.*, 30: 508-520.
- Nausch G., Bachor A., Petenati T., Voß J., Weber M. v. (2011). Nährstoffe in den deutschen Küstengewässern der Ostsee und angrenzenden Gebieten. *Meeresumwelt Aktuell Nord- und Ostsee 2011/1*.
- Rupp H., Meissner R., Leinweber P. (2004). Effects of extensive land use and re-wetting on diffuse phosphorus pollution in fen areas - Results from a case study in the Drömling catchment, Germany. *J. Plant Nutr. Soil Sci.*, 167: 408-416.
- Schoonover J.E., Williard K.W.J., Zaczek J.J., Mangun J.C., Carver A.D. (2006). Agricultural sediment reduction by giant cane and forest riparian buffers. *Water Air Soil Pollut.*, 169(1-4): 303-315.
- Sharpley A.N., Weld J.L., Beegle D.B., Kleinman P.J.A., Gburek W.J., Moore Jr. P.A., Mullins G. (2003). Development of phosphorus indices for nutrient management planning strategies in the United States. *J. Soil Water Cons.*, 58: 137-152.
- Sims J.T., Simard R.R., Joern B.C. (1998). Phosphorus loss in agricultural drainage: Historical perspective and current research. *J. Environ. Qual.*, 27: 277–293.
- Stämpfli N., Madramootoo C.A. (2004). The effect of water table management on the migration of phosphorus and on grain corn in southwestern quebec. *Proceedings of the 8th International Drainage Symposium - Drainage VIII*, pp. 429-442.
- Withers P.J.A., Clay S.D., Breeze V.G. (2001). Phosphorus transfer in runoff following application of fertilizer, manure, and sewage sludge. *J. Environ. Qual.*, 30: 180-188.

## EFFECTS OF TILLAGE METHODS AND NITROGEN FERTILIZATION ON THE PRODUCTION OF SIX ENERGY CROPS

Maria KOKKORA<sup>1\*</sup>, Dimitrios KALFOUNTZOS<sup>1</sup>, Theofanis GEMTOS<sup>2</sup>

<sup>1</sup>Department of Biosystems Engineering, School of Agricultural Technology and Food Technology and Nutrition, TEI of Thessaly, 41110, Larissa, Greece

<sup>2</sup>Department of Agriculture, Crop Production and Rural Environment, School of Agricultural Sciences, University of Thessaly, 38446, N. Ionia, Volos, Greece

\*Corresponding author: mkokkora@gmail.com

### Abstract

Increasing the yield of energy crops is of key importance for Greece and other European countries in order to achieve the European Community's targets for substitution of imported fossil fuel with locally produced renewable energy. However, in order the cultivation of energy crops to be viable, high yields should be achieved at the lowest possible inputs. Reduced tillage and reduced levels of fertilization reduces crop production inputs. The present study investigates the effects of three soil tillage methods (conventional tillage, reduced tillage and no-tillage) along with three levels of fertilization on yields of six energy crops (pea and triticale intercropping, sunflower, rapeseed, sorghum, oat and vetch intercropping and soybean), cultivated in a rotation system in central Greece. Increasing levels of nitrogen fertilization led to increased rapeseed and sunflower seed yields. The yields of sorghum and soybeans were not affected by the applied fertilization rates. The yields of sorghum, and pea and triticale intercropping, were not affected by the soil tillage methods. The no-tillage method, although it resulted in the highest yield in the case of vetch and oat intercropping under high soil moisture conditions, it gave lower yields in the case of rapeseed, sunflower seed and soya seed. The reduced tillage resulted in yields similar to the yields obtained with the conventional treatment in the case of rapeseed and vetch-oat intercropping. However, it gave a higher yield in the case of sunflower seed, and only in the case of soybean seed, the yield was lower, compared to the conventional tillage. The results of this study indicate that reduced tillage (with a heavy cultivator) can lead to increased production of energy crops, whilst contributing to energy savings, compared to the conventional method (plowing).

**Keywords:** *Energy crops rotation, Central Greece, Conservation tillage, Yield*

### Introduction

The European Community encourages the production of energy from renewable sources, aiming to achieve reductions in greenhouse gas emissions and to reduce its dependence on imported oil in the transport sector. The target for energy share from renewable sources in Greece in 2020 amounted to 18% of gross final energy consumption (Directive 2009/28/EC). It has also been adopted as a mandatory minimum target, which must be achieved by all Member States, 10% share of biofuels in petrol and diesel consumption for transport by 2020. Up until now, there have been significant efforts in Greece for substitution of imported fossil fuels with locally produced renewable energy. The only feasible solution today for the production of liquid fuel seems to be the production of biomass (Gemtos *et al.*, 2009). The crops that produce biomass for the production of biofuel are called energy crops. The cultivation of energy crops is therefore of strategic importance for the Greek agriculture as it can contribute both to energy production and liquid fuels, ensuring or even improving farm

income, and also to environmental protection. Among the energy crops that give high yields of biomass are sweet sorghum and sunflower (Vakakis, 2007; Gemtos *et al.*, 2009). However, in order the cultivation of energy crops to be viable, high yields must be achieved at the lowest possible inputs. The reduction of soil tillage is a method of reducing production inputs (Hernanz *et al.*, 2014), while at the same time contributes to improving soil quality by increasing the organic matter content (Holland, 2004; Gemtos *et al.*, 2013; Küstermann *et al.*, 2013). Soil moisture is a key factor for plant growth. Soil moisture is affected by soil tillage methods and research has shown that in cases of reduced or zero tillage is generally higher due to increased soil water holding capacity and reduced evaporation (Bescansa *et al.*, 2006). The objective of the present study is to evaluate the effects of soil tillage methods and nitrogen fertilization levels on yield of six energy crops cultivated in Thessaly, central Greece.

### Materials and methods

A field experiment was undertaken at TEI of Thessaly university farm in Larissa, central Greece (39° 37.12' B, 22° 23.05' A). The total area of the experimental plot was 1 ha. The soil in the field was sandyclayloam and was classified according to the Soil Taxonomy system (Soil Survey Staff, 1999) as Inceptisol (suborder: Ochrept, Typic Xerochrept subgroup). The climate of the area is semiarid.

Six energy crops were cultivated in rotation, starting from December 2012 till November 2015, as it is presented in Table 1.

Table 1. Energy crops installed in rotation in the field experiment in TEI of Thessaly, Greece.

Crop	Sowing	Harvest
Pea ( <i>Pisum sativum</i> L.) & Triticale ( <i>x Triticosecale</i> )	Dec-12	May-13
Sunflower ( <i>Helianthus annuus</i> )	Jun-13	Oct-13
Rapeseed ( <i>Brassica napus</i> L.)	Nov-13	Jun-14
Sorghum ( <i>Sorghum bicolor</i> L.)	Jun-14	Nov-14
Vetch ( <i>Vicia sativa</i> L.) & Oat ( <i>Avena sativa</i> L.)	Dec-14	May-15
Soybean ( <i>Glycine max</i> )	Jul-15	Nov-15

The soil tillage methods used include: (1) Conventional tillage: plowing at a depth of 25-30 cm and seedbed preparation with a seedbed cultivator, (2) Reduced tillage using a heavy cultivator: primary tillage with a heavy cultivator at a depth of 15-20 cm and seedbed preparation with a seedbed cultivator, and (3) No-tillage: direct sowing on the undisturbed soil surface using special seeders, for summer or winter crops, respectively. The three tillage methods were replicated four times. Also, three levels of nitrogen fertilization were applied to each crop (F1, F2 and F3). The total amount of fertilizer applied to each crop is summarized in Table 2. Each fertilization treatment was replicated three times. For the summer crops irrigation was required, which was determined on the basis of crop evapotranspiration (ET<sub>c</sub>). All treatments received the same amount of irrigation water. The ET<sub>c</sub> was estimated using the revised FAO-56 Penman-Monteith method (Allen *et al.*, 1998), based on the meteorological data collected from the weather station at TEI of Thessaly farm. At the completion of plant development, biomass was collected in a hanging basket at the back of a 1.5m-wide harvesting combine (HEGE 125c), and biomass fresh weight was determined. Subsequently, a representative sample was taken. Sample's moisture content was determined and based on this result biomass dry matter (DM) yield was calculated. In the case of sunflower, rapeseed and soybean, the DM yield of the seed and stem were determined separately, using the same procedure described above. Crops DM yields were analyzed by two factors ANOVA, with

fertilization as main factor and soil tillage as secondary, based on the SPSS10 statistical program (SPSS Inc., Chicago, USA).

Table 2. Application rates of N - P<sub>2</sub>O<sub>5</sub> - K<sub>2</sub>O (in kg/ha) to the energy crops for each one of the three fertilization levels used: F1, F2 and F3.

Crop	Fertilization		
	F1	F2	F3
Pea & Triticale*	33 - 45 - 45	33 - 45 - 45	33 - 45 - 45
Sunflower	100 - 50 - 0	120 - 50 - 0	140 - 50 - 0
Rapeseed	80 - 0 - 0	100 - 0 - 0	120 - 0 - 0
Sorghum	100 - 0 - 0	200 - 0 - 0	300 - 0 - 0
Vetch & Oat*	64 - 80 - 0	64 - 80 - 0	64 - 80 - 0
Soybean	64 - 80 - 0	83.2 - 80 - 0	102.4 - 80 - 0

\*In the case of legume crops, there was no differentiation in the nitrogen fertilization levels applied.

### Results and discussion

The biomass DM yield of the pea and triticale intercropping ranged between 3600 and 3880 kg per ha within the different treatments. The effect of the three tillage methods on the biomass DM yield was not statistically significant. It should be noted that nitrogen fertilization levels were not differentiated in the case of the pea and triticale intercropping, as in all cases of legume crops. The nitrogen fertilization rates used significantly increased sunflower DM yields. As a matter of fact, there was a linear increase in sunflower DM yield with increasing rates of fertilization (Fig. 1). The lower fertilization application rate (F1) resulted in significantly lower DM yield compared to the medium rate (F2), and F2 resulted in significantly lower DM yield compared to the higher rate (F3), for both seed and stem.

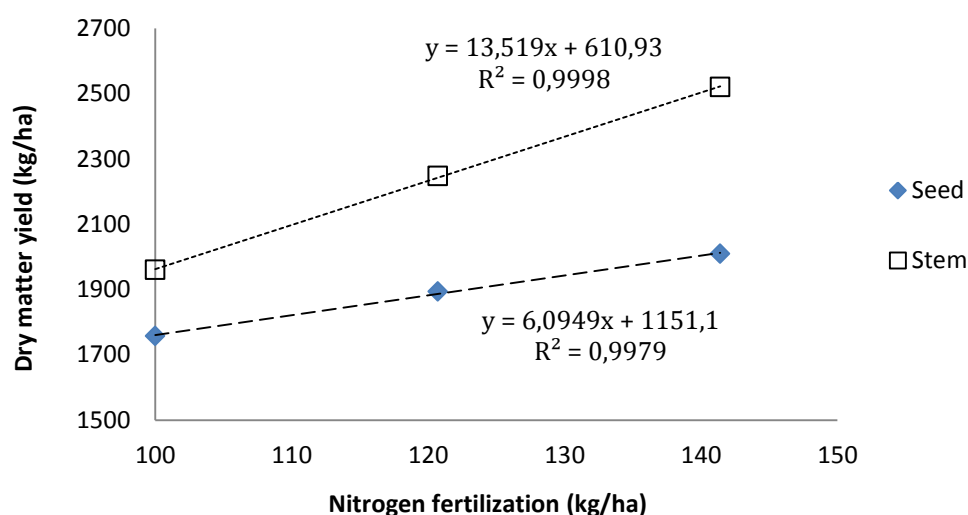


Figure 1. The effect of nitrogen fertilization rates on the DM yield of sunflower seed and stem.

The different soil tillage methods significantly influenced sunflower seed DM yield, but not the sunflower stem DM yield. On average, sunflower stem DM yield was 2236 kg/ha for the conventional tillage, 2218 kg/ha for the reduced tillage and 2274 for the no-tillage. On the

other hand, reduced tillage resulted in the highest sunflower seed DM yield, followed by conventional tillage, whereas no-tillage resulted in the lowest yield (Fig. 2).

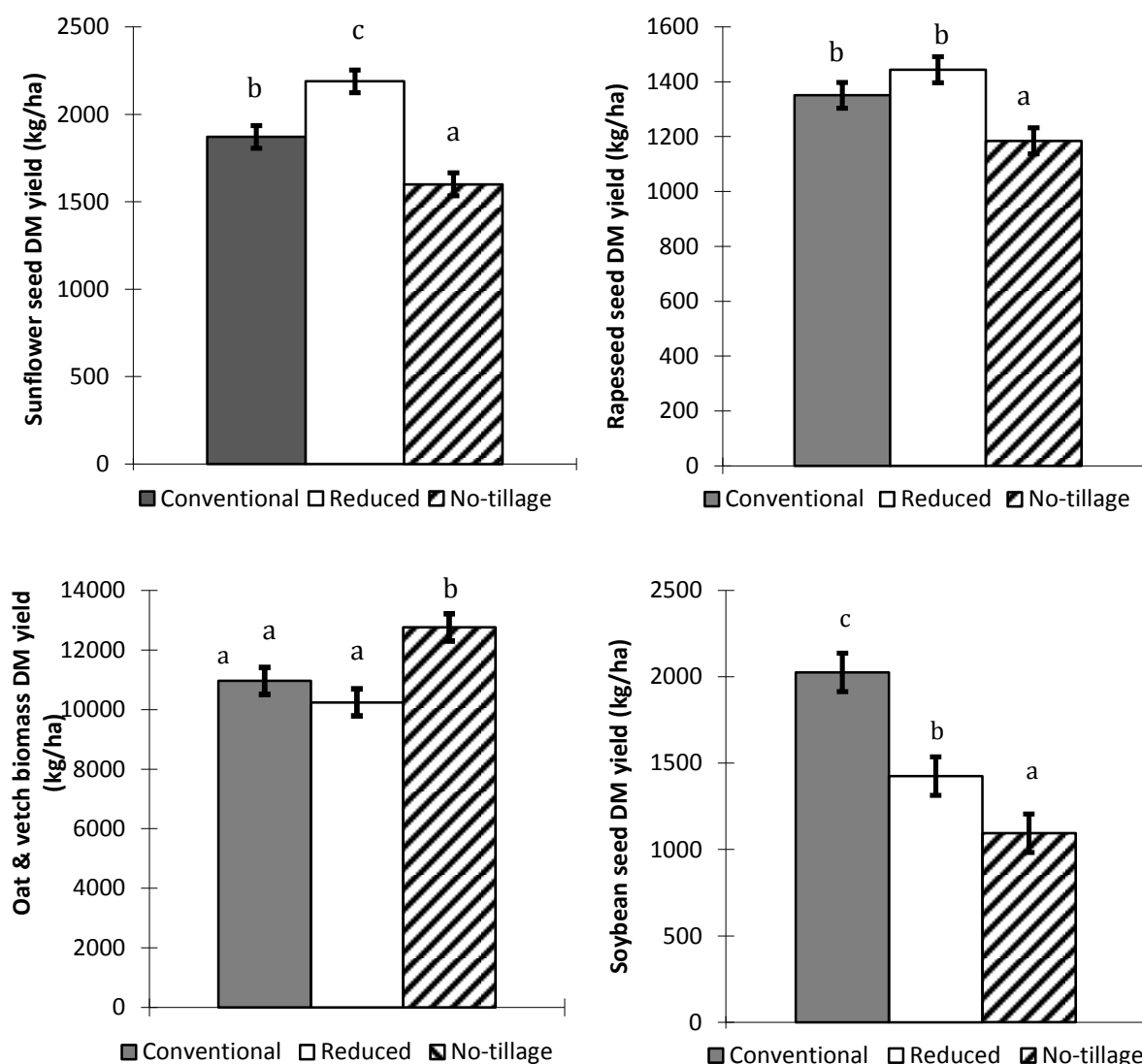


Figure 2. The effect of the three soil tillage methods used: conventional (plowing), reduced (with a heavy cultivator) and no-tillage, on the DM yield of sunflower seed, rapeseed seed, oat & vetch biomass and soybean seed. Columns labeled with the same letter are not significantly different ( $P>0.05$ ).

Rapeseed seed DM yield was also affected by the different soil tillage methods. Reduced tillage resulted in an average of 1444 kg/ha rapeseed seed DM yield. Conventional tillage ranged in similar levels, whereas no-tillage resulted in the lowest yield (Fig. 2). The application of nitrogen fertilization at the highest rate (F3) significantly increased rapeseed seed yield, in comparison to the other two rates used, which resulted in similar DM yields. The increase in rapeseed seed DM yield with increasing rates of nitrogen fertilization followed a linear trend (Fig. 3). Sorghum DM yield was not significantly affected either by the nitrogen fertilization rates applied, or the soil tillage methods used, under the conditions of our study. On average, sorghum DM yield was 18290 kg/ha for the conventional tillage, 16322 kg/ha for the conservation tillage and 15574 for the no-tillage. The increase in nitrogen fertilization application rate did not increase sorghum DM yield. In detail, the lower application rate (F1) resulted on average in 17248 kg/ha, the medium rate (F2) in 17009



kg/ha, whereas the higher rate (F3) in 15929 kg/ha. These results indicate that there was no advantage in increasing the nitrogen fertilization rate under the conditions of our study.

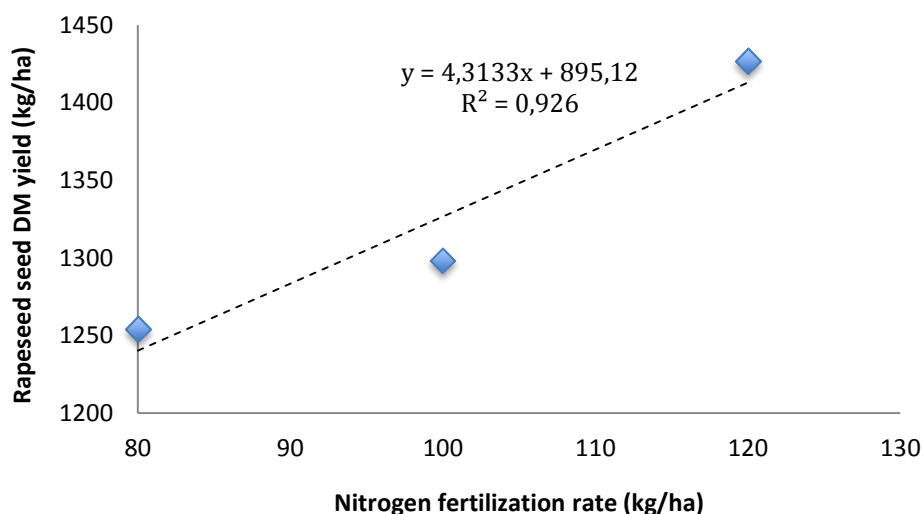


Figure 3. The effect of nitrogen fertilization rates on rapeseed seed DM yield.

In the case of the oat and vetch intercropping, nitrogen fertilization levels were not differentiated, as in all cases of legume crops. The effect of the soil tillage method on biomass DM yield is presented in Figure 2. As it can be seen in Figure 2, the no-tillage method significantly increased biomass DM yield, in comparison to the other two methods, which resulted in similar DM yields. It should be noted that during the experimental period of soil tillage and seeding of oat and vetch intercropping, soil moisture content was quite high, due to the on-going rainfall. This fact most probably led to soil compaction, especially in the treatments of conventional and reduced tillage, and therefore biomass yield in these treatments was reduced in comparison to the no-tillage method. Finally, as far as the soybean seed DM yield is concerned, it was not significantly influenced by the nitrogen fertilization rates applied. On the contrary, soil tillage methods significantly affected soybean seed DM yield, as it can be seen in Figure 2. Conventional tillage resulted in significantly higher yield, followed by conservation tillage, whereas the no-tillage resulted in the lower yield. The effect of fertilization and soil tillage methods on soybean biomass DM yield was not significant, due to the high variation observed. However, a tendency for higher yields with the conventional tillage and the two higher nitrogen fertilization rates was observed (Table 3).

Table 3. Soybean biomass DM yield (kg/ha) for the different treatments. Average values labeled with the same letter are not significantly different ( $P>0.05$ ).

Soil tillage methods	Nitrogen fertilization rates			Average
	F1	F2	F3	
Conventional	3014.8	5439.5	5344.0	<b>4599.4<sup>a</sup></b>
Reduced	2610.0	3472.3	3449.5	<b>3177.3<sup>a</sup></b>
No-tillage	3291.5	2506.3	2940.5	<b>2912.8<sup>a</sup></b>
<b>Average</b>	<b>2972.1<sup>a</sup></b>	<b>3806.0<sup>a</sup></b>	<b>3911.3<sup>a</sup></b>	

### Conclusion

The present study investigated the effects of three soil tillage methods along with three levels of nitrogen fertilization on yields of six energy crops cultivated in a rotation system in central

Greece. The experimental results provided evidence that reduced tillage (with a heavy cultivator) can lead to increased production of energy crops, whilst contributing to energy savings, compared to the conventional method (plowing). The no-tillage method was advantageous under high soil moisture content conditions. Increasing levels of nitrogen fertilization led to increased yields only in the case of rapeseed and sunflower. Reducing levels of nitrogen fertilization to the rest energy crops resulted in high yields, whilst lowering crop production inputs.

### **Acknowledgement**

This research has been co-financed by the European Union (ESF) and Greek national funds through the Operational Program "Education and Lifelong Learning" of the NSRF - Research Funding Program: Thales.

### **References**

- Allen R.G., Pereira L.S., Raes D., Smith M. (1998). Crop Evapotranspiration: Guidelines for Computing Crop Water Requirements, Irrigation and Drainage Paper 56, Rome: United Nations Food and Agriculture Organization (FAO)
- Bescansa P., Imaz M.J., Virto I., Enrique A., Hoogmoed W.B. (2006). Soil water retention as affected by tillage and residue management in semiarid Spain, *Soil Tillage Research*, 87, 19–27.
- Gemtos T., Kavalaris C., Karamoutis C., Fountas S. (2009). The adjustability of three energy crops in Thessaly. *Proceedings of the 6th National Conference in Agricultural Engineering*, 8 – 10 October 2009, Thessaloniki, Greece, 699-706.
- Gemtos T., Kavalaris C., Karamoutis C., Fountas S. (2013). The evolution of organic matter in the soil within a long-term soil tillage comparison experiment. *Agricultural Engineering*, 10-13 (in Greek).
- European Union (2009). Directive 2009/28/EC of the European Parliament and of the Council of 23 April 2009 on the promotion of the use of energy from renewable sources and amending and subsequently repealing Directives 2001/77/EC and 2003/30/EC. *Official Journal of the European Union*, L140/16, 5.6.2009
- Hernanz J.L., Sánchez-Girón V., Navarrete L. and Sánchez M.J. (2014). Long-term (1983–2012) assessment of three tillage systems on the energy use efficiency, crop production and seeding emergence in a rain fed cereal monoculture in semiarid conditions in central Spain. *Field Crops Research*, 166, 26-37.
- Holland J.M. (2004). The environmental consequences of adopting conservation tillage in Europe: reviewing the evidence. *Agriculture, Ecosystems and Environment*, 103, 1-25.
- Küstermann, B., Munch, J.C. and Hülsbergen, K.-J. (2013). Effects of soil tillage and fertilization on resource efficiency and greenhouse gas emissions in a long-term field experiment in Southern Germany. *European Journal of Agronomy* 49, 61-73.
- Soil Survey Staff (1999). *Soil Taxonomy: a basic system of soil classification for making and interpreting soil surveys*, USDA-SCS Agric. Handbook, 436, U.S. Govt. Print. Office, Washington, DC
- Vakakis F. (2007). Energy crops and farm incomes. *Agriculture – Livestock*, 8, 34-42 (in Greek).

## **UNLIMITED USE OF IRRIGATION WATER RESOURCES IN ARID AND SEMI-ARID REGIONS OF IRAN: NO-WIN COMPETITION**

Marzieh KESHAVARZ

Department of Agriculture, Payame Noor University, Tehran, Iran

\*Corresponding author: keshavarzmarzieh@pnu.ac.ir

### **Abstract**

Water shortage as a virtually common feature is a major limitation for agricultural development, in Iran. Climate change is also expected to put extra pressure on Iran's water resources through making the region hotter and drier. These extreme environmental conditions require flexible and adaptive utilization of water resources. However, the average irrigation efficiency is low and the crop pattern, e.g. rice production, does not match the regional water availability conditions. Using qualitative research method in three rice growing villages of Firuzabad County, southwest Fars province, this study aims to identify the main causes of unlimited use of water resources in water scarce regions of Iran. Results indicated that Fars has experienced significant reduction in rice production since 2007. Some rice farmers have modified their cropping systems by growing drought resistance crops. However, some others are still cultivating irrigated rice which is causing the looming water crisis. Finding revealed that personal, financial, institutional, legal and regulatory issues and socio-psychological drivers have constrained sustainable use of scarce water resources. Recommendations are offered to increase the efficiency of water resources and modify cropping system in water scarce regions.

**Keywords:** *Agriculture, climate change, scarce water resources, rice producers, sustainable management*

### **Introduction**

Agriculture as the dominant sector in Iranian rural economy accounts for almost 13% of GDP, 20% of the employed population, 20% of non-oil exports, 85% of raw materials used in the food processing industry and 93% of water withdrawals in Iran (Ardakanian, 2005; IRNA, 2015). However, this country is not well-endowed with water; the per-capita water endowment is approximately one-quarter of the world's mean value (Alyasin, 2005) and lack of adequate water is a major limitation for agricultural development in Iran. Meantime, the demand for water consumption has increased during the recent severe sustained droughts (e.g. 2007–2014). The 2007-2014 drought has led to completely drying up of many internationally renowned wetlands and lakes, significant reduction of river flows and depletion of groundwater resources (Keshavarz et al., 2013; Keshavarz and Karami, 2016). Furthermore, climate change is expected to put extra pressure on Iran's water resources by making the region hotter and drier (Abbaspour et al., 2009; Jamali et al., 2012). For instance, it is estimated that the average annual runoff in Pishin (southeast Iran) and Zayandeh-Rud (center of Iran) basins will decrease by 33% and 40 to 70% around 2040, respectively (Massah Bavani and Morid, 2005; Mohammadnejad, 2010). Moreover, it is projected that the demand for irrigation water will rise soon (Shahkarami et al., 2011), having major implications for agricultural production (Gohari et al., 2013; Moradi et al., 2013). These variable, unpredictable and extreme environmental conditions require flexible and adaptive utilization of irrigation water resources (McAllister et al., 2006; Schmidt and Pearson, 2016). Moreover,

Iran has always suffered from an inefficient agriculture that has heavily relied on limited irrigation water resources (Seyf, 2006). Currently, the average irrigation efficiency is less than 35% and only 5% of the cultivated area is under pressured irrigation. Also, the crop pattern does not match the regional water availability conditions and follows the traditional crop choices and farming practices (Madani, 2014). For instance, high water requirement crops such as rice are still grown in some arid and semi-arid regions of Iran. While 277 out of 609 plains of Iran suffer critical conditions (Forootan et al., 2014). This study aims to identify the main causes of the unlimited and irrational use of the irrigation water resources in water scarce regions of Iran.

### Material and Methods

This study was conducted in Firuzabad county, southwest Fars province, Iran. While the average annual rainfall in this area is 434.8 mm (1971–2016), the mean precipitation decreased to 238.6 mm in 2014. Due to unavailability of sufficient surface water, the agricultural sector has consumed a lot of groundwater. This county was further confronted with a 20 to 30% drop in its water-table and about 140 meters increase of the well depth (Fars News Agency, 2015). Despite groundwater degradation and water scarcity, rice production is still prevalent in the region. This is while the typical amount of water required for irrigated rice in Iran is around 30000-35000 m<sup>3</sup> per hectare. Qualitative research was conducted in three rice growing villages of the county. With this regard, a purposive sample of 19 rice producers were interviewed to identify the main causes of producing rice in the water scarce environment.

### Results and Discussion

#### *Past and present status of rice production in Fars province and Iran*

Rice production in Iran has more than tripled in the last 37 years (from 741 to 2347.7 thousand tons; Jihad-Agriculture ministry, 2015) mainly due to the increased grain yield rather than enhanced cultivation area (Fig. 1). This increase is resulted from development of high-yielding varieties and improved nitrogen fertilization. For instance, the average rice yield of Fars was 5.4 tons per hectare in 2009 that was higher than the world average (Fig. 2).

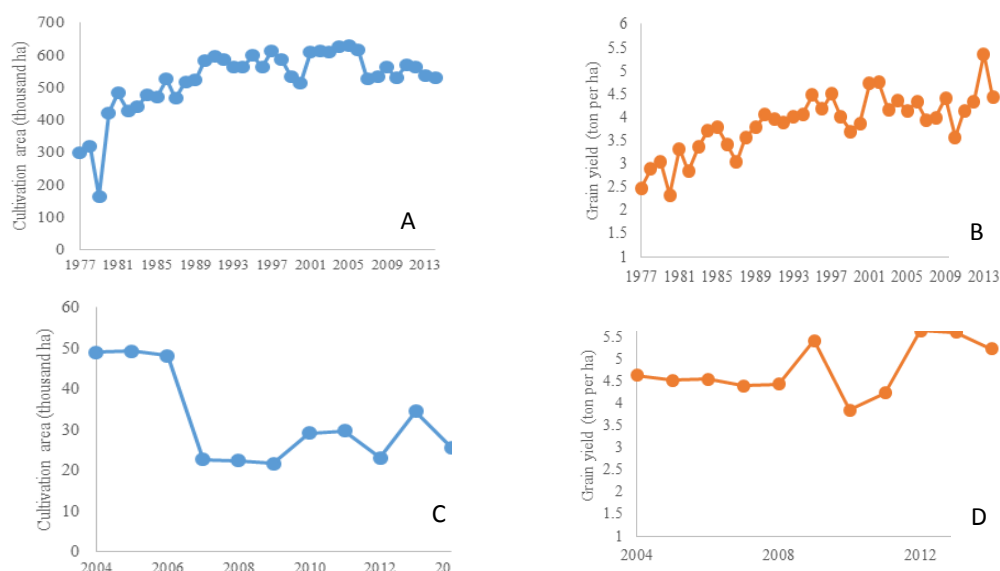


Fig. 1. Rice cultivation area (A, C) and grain yield (B, D) in Iran and Fars province, respectively (Jihad-Agriculture ministry, 2015)

While rice production is promoting in some regions of Iran, i.e. Gilan and Mazandaran provinces, Fars has experienced its significant reduction since 2007 (Fig. 1). The annual total rice cultivation area has decreased from 49.3 to 22.7 thousand hectares from 2005 to 2007 and stagnation of rice production has been observed in the past ten years. The major constraints of the sustainable rice production in many rice growing areas of Fars include drought stress and scarcity of freshwater resources, deterioration of water quality and global warming that reduces rice yield by increasing grain sterility and decreasing biomass production (Madani, 2014). While some rice farmers have modified their cropping system by growing drought resistance crops, some others still cultivate irrigated rice which causes further water crisis.

### **Main causes of rice production in water scarce regions of Fars**

A complex set of factors are considered as the main drivers of rice production under water stress (Table 1). As illuminated in Table 1, low education level and lack of knowledge about many water related issues pose powerful effects on farmers' behavior. Comments indicated that greater awareness and education is needed about water conservation actions, water consumption rates and the possibility of water scarcity. However, Iran has failed to provide a comprehensive plan for empowerment of farmers. Some failure reasons are attributed to low effectiveness of extension services due to poor linkages between extension agents and local people, lack of practical relevance of educations to local and community demands and lack of continuity between different levels of education (Table 1).

Table 1. Drivers of rice production in water scarce regions

Themes	Formulated concepts	Significant statements
Personal	Low level of education	- <i>We're illiterate people. We don't know what's good for society and environment.</i>
	Lack of knowledge about water issues	- <i>I heard from one expert that it takes about 9000 liters of water to produce one kilogram of rice. It is unreal.</i> - <i>I heard that there's a new rice variety that requires only 12000 m<sup>3</sup> water per hectare but I don't know more.</i>
Financial	Poverty	- <i>Our poverty is the root of water crisis.</i> - <i>If we want to change our cropping pattern effectively, our farmed area should be under pressured irrigation. We don't have enough money to improve our irrigation system.</i>
	Lack of income diversification	- <i>How other people can understand our situation? Agriculture experts, public media and even urban people blame us for over-use of water and always talk about conservation of environment. What should we do when we don't have any other income resource?</i> - <i>We have no serious job alternative than farming.</i>
	Access to local markets	- <i>Agriculture experts recommend us to cultivate low water requiring crops such as safflower. No one buys this crop in Fars. We prefer to produce rice which has many consumers in Firuzabad and Shiraz.</i> - <i>Although the process of rice production is difficult but it's market is safe. Everyone likes to buy our rice.</i>
Institutional, legal and regulatory	Inequitable access to low-interest loans	- <i>Banks argue that they don't have enough funds to give us loans. Iran is a rich country, how is it possible?</i> - <i>Even if I want, I can't get a loan. The guarantor has to be a government worker, and I don't have any relatives working for the government.</i>
	Inadequate extension services	- <i>We don't know which cropping system is better for our farm. This is extension agents' fault. Why they never hold water management classes for us?</i> - <i>Agricultural extension service centers don't pay any attention to small scale farmers. They just support famous farmers with more arable lands.</i>
	Uneven geographical distribution of welfare	- <i>All capitals and budgets are spent for urban not rural people. Urban people have everything, but we don't have anything. We think the blame is on the government for our rice production behavior, not us.</i>
	Lack of government control	- <i>We didn't find any policy plans to improves water efficiency in the region or prevent misuse of water resources.</i> - <i>All of us should be restricted, otherwise one farmer obeys the restrictions</i>

		<i>while others use the entire amount of water.</i>
Social- psychological	Distrust in governmental organizations	<ul style="list-style-type: none"> <li>- Officers and extension agents almost always say there's no enough water in the region. They are liars. There is no water scarcity. They want to give our water to other regions. It's better to use water by ourselves.</li> <li>- Governors told us if you avoid rice production we will give you salary for almost three years. No one has received such money.</li> </ul>
	Tragedy of the commons	<ul style="list-style-type: none"> <li>- We own common irrigation wells. If I avoid growing rice others use more water and increase their rice cultivation area.</li> <li>- We always have water competition! Who can ensure if I ignore rice production benefits, others ignore it?</li> </ul>
	Lack of deferred gratification	<ul style="list-style-type: none"> <li>- Folks are saying that rice growers are somehow responsible for this water crisis. My question is who can delay short term gratification for long term sustainability?</li> </ul>
	Cognitive misperceptions	<ul style="list-style-type: none"> <li>- Water management is an engineering issue. How can we improve water use in our small farm?</li> <li>- We have water right and private borehole. It allows us to use water, freely. Does anyone ask you about what you do in your house?</li> </ul>
	Risk aversion	<ul style="list-style-type: none"> <li>- We as small scale farmers are risk averse. Modifying cropping system from rice to other crops is risky. We're afraid if we lose our subsistence.</li> <li>- Who can insure our sustainable livelihood if we avoid production of rice?</li> </ul>

Also, poverty and lack of income diversification are the main drivers of unlimited irrigation water use (Table 1). Although Iran is implementing poverty reduction programs in rural areas, findings revealed that governors have failed to reduce poverty in the area. Poor farmers often lack the financing capacity to improve water use efficiency. Enhancing equity within irrigation systems to support poverty reduction and efficiency through equitable welfare distribution mechanisms is imperative. However, most respondents did not receive any subsidized loans. Budget limitation and farmers' inability to provide a guarantor were the main reasons for refusal. Furthermore, uneven geographic distribution of welfare and lack of access to markets have put extra pressure on water resources and created a no-win competition between rice growers and no-rice grower farmers (Table 1). To prevent further water loss, the government should provide a robust action plan and prohibit overuse of water resources (Table 1). Recently, the government has installed smart groundwater monitoring devices in some regions but effectiveness of this action is unknown and many believe that water crisis in Iran is the result of decades of government mismanagement (Madani, 2014).

As illustrated in Table 1, water use reduction was not considered as an option by farmers due to their distrust in the governors. Building trust and confidence through dialogue among all stakeholders is required for effective regulation of water management issues and averting tragedy of the commons (Table 1), where common groundwater resources are depleted and destroyed through the unregulated and self-interested activities of countless consumers. Risk aversion, lack of deferred gratifications and misperceptions about water rights constraint efficient use of irrigation water, too.

### Conclusions

This study indicated that the roots of water use crisis can be traced back to lack of knowledge, poverty, unequal access to markets, loans and government welfare programs, government mismanagement, as well as social-psychological factors. This problem is normally the product of rapid growth of agriculture sector without considering its dynamic relation to water resources. If water resources are to be sustainable, Iran needs serious control of aggressive groundwater withdrawals, modify the inappropriate crop patterns and reduce irrigation water consumption through empowering farmers. If timely regulatory actions are not taken in these issues, the unintended damages can become fully irreversible (Madani, 2014).

## References

- Abbaspour K.C., Faramarzi M., Ghasemi S.S., Yang H. (2009). Assessing the impact of climate change on water resources in Iran. *Water Resources Research*, vol. 45, no. 10, W10434.
- Alyasin A. (2005). *Water Crisis*. Iranian Society of Consulting Engineers publication, Tehran, Iran, 518 pp. (in Persian).
- Ardakanian R. (2005). Overview of water management in Iran. In: *Policies and Strategic Options for Water Management in the Islamic Countries: Proceedings of the Symposium organized by the Regional Centre on Urban Water Management (RCUWM-Tehran)*, 15–16 December 2003, Tehran, Iran.
- Fars News Agency (2015). Firuzabad water-tables are in critical level. Retrieved from <http://www.farsnews.com/printable.php?nn=8907010096> (accessed 29 May 2015). (in Persian).
- Forootan E., Rietbroek R., Kusche J., Sharifi M.A., Awange J.L., Schmidt M., Omondi P., Famiglietti J. (2014). Separation of large scale water storage patterns over Iran using GRACE, altimetry and hydrological data. *Remote Sensing Environment*, vol. 140, pp. 580-595.
- Gohari A., Eslamian S., Abedi-Koupaei J., Massah Bavani A., Wang D., Madani K. (2013). Climate change impacts on crop production in Iran's Zayandeh-Rud River Basin. *Science of the Total Environment*, vol. 442, pp. 405-419.
- Islamic Republic News Agency; IRNA (2010). Agriculture sector accounts for 20% of non-oil exports. Retrieved from <http://www.irna.ir/fa/News> (accessed 03 June 2017). (in Persian).
- Jamali S., Abrishamchi A., Marino M.A., Abbasnia A. (2012). Climate change impact assessment on hydrology of Karkheh Basin, Iran. *Proceeding of ICE-Water Management*, vol. 166, pp. 93-104.
- Jihad-Agriculture ministry (2015). Investigating the cultivation area and crops yield from 1978 to 2013, Tehran, Iran. (in Persian).
- Keshavarz M., Karami E. (2016). Farmers' pro-environmental behavior under drought: An application of Protection Motivation Theory. *Journal of Arid Environments*, vol. 127, pp. 128-136.
- Keshavarz M., Karami E., Vanclay F. (2013). Social experience of drought in rural Iran. *Land Use Policy*, vol. 30, no. 1, pp. 120-129.
- Madani K. (2014). Water management in Iran: What is causing the looming crisis? *Journal of Environmental Studies and Sciences*, vol. 4, pp. 315-328.
- Massah Bavani A., Morid S. (2005). The impact of climate change on water resources and agriculture production: A case study of Zayandeh-Rud basin, *Research on Water Resources of Iran*, vol. 1, pp. 40-47. (in Persian).
- McAllister R.R.J., Gordon I.J., Janssen M.A., Abel N. (2006). Pastoralists' responses to variation of rangeland resources in time and space. *Ecological Applications*, vol. 16, no. 2, pp. 572-583.
- Mohammadnejad B. (2010). Climate change impact assessment on rainfall-runoff process: Case study of Pishin reservoir basin Iran. Technical report, Sistan and Baluchestan Regional Water Company, Iran, 86 pp. (in Persian).
- Moradi R., Koocheki A., Nassiri Mahallati M., Mansoori H. (2013). Adaptation strategies for maize cultivation under climate change in Iran: Irrigation and planting date management. *Mitigation and Adaptation Strategies for Global Change*, vol. 18, pp. 265-284.

- Schmidt M., Pearson O. (2016). Pastoral livelihoods under pressure: Ecological, political and socioeconomic transitions in Afar (Ethiopia). *Journal of Arid Environments*, vol. 124, pp. 22-30.
- Seyf A. (2006). On the importance of irrigation in Iranian agriculture. *Middle East Studies*, vol. 42, pp. 659-673.
- Shahkarami N., Morid S., Massah Bavani A., Fahmi H. (2007). Risk analysis of changes in crops water requirements under climate change in Zayandeh-Rud river basin. Technical workshop of the impacts of climate change on management of water resources, Regional Centre on Urban Water Management, Tehran, February 13, pp. 123-134. (in Persian).



## **PROMISING AMMONIA MITIGATION OPTIONS IN LATVIA'S AGRICULTURE**

Ligita MELECE

Institute of Agricultural Resources and Economics (AREI), Latvia

Corresponding author: ligita.melece@arei.lv

### **Abstract**

The revised Gothenburg protocol and EU National Emission Ceilings Directive establish ammonia emission reduction targets. Taking into account that the agricultural sector remains the major source of ammonia emissions in both EU and Latvia (86%), the huge effort should be made by agriculture sector to achieve ammonia mitigation. The aim of the paper is to provide the most promising ammonia emissions reduction and mitigation options in Latvia's agricultural production. Following tasks have been covered in the study: 1) to determine the main sources of ammonia emissions in the each of livestock species (dairy cattle, pigs, poultry) and farms' size; 2) to evaluate and to identify the most promising mitigation measures, taking into account the reduction potential, effectiveness and potential costs. The largest proportion of ammonia emission comes from the livestock production: 45.6% from manure management and 19.6% from manure application. The results show that the milk production, pig and poultry industry are the target branches of agricultural production. The most promising emission reduction and mitigation measures have been proposed, out of which the animal feeding strategy and manure application techniques are distinguished as the most effective.

**Keywords:** *Ammonia mitigation, agriculture, feed, manure, Latvia*

### **Introduction**

Ammonia (NH<sub>3</sub>) emissions are contributing to several different negative effects to human health and ecosystems (Sutton et al., 2011). The Convention on Long-Range Transboundary Air Pollution (CLRTAP) is the main international framework for cooperation and measures to limit, to reduce and to prevent air pollution. CLRTAP Protocol, which is also known as the Gothenburg Protocol, was revised in 2012. Based on the revised Protocol the EU National Emission Ceilings Directive - Directive (EU) 2016/2284 on the reduction of national emissions of certain atmospheric pollutants, including NH<sub>3</sub>, has set national emission reduction commitments (EC, 2016). The reduction target of NH<sub>3</sub> emissions for Latvia should be one per cent – 1% for any year from 2020 to 2029; and 1% from any year from 2030, compared with a 2005 baseline. The agricultural sector remains the major source of NH<sub>3</sub> emissions in both EU and Latvia, e.g. 94% and 86%, respectively in 2015 (Eionet, 2017). Therefore the huge effort should be made by agriculture sector to achieve the reduction commitments.

The aim of the paper is to provide most promising NH<sub>3</sub> reduction options in Latvia's agricultural sector. Following tasks have been covered in the study: 1) to determine the main sources of NH<sub>3</sub> in the each of livestock species and farms' size; 2) to identify and to evaluate the most promising mitigation measures, taking into account the reduction potential, effectiveness and potential costs.

## Material and Methods

The literature review seeks to identify the main ammonia emission mitigation and reduction goals and especially the measures to achieve them. The principal materials used for literature review are as follows: different primary and secondary sources of literature, e.g., scholars' articles, research papers and the reports; as well as legislative acts, guidelines and recommendations of both international institutions (EMEP, UNECE) and EU (European Commission, EEA). The main selection criteria of literature were: the most recent ones, peer-reviewed, with similar climatic conditions or technologies, of Latvian origin etc. In order to identify the main sources of ammonia emissions in Latvia, particularly from agriculture, the following secondary data were used: published and unpublished data from Central Statistical Bureau of Latvia (CSB, 2017), as well as the data from CLRTAP (Eionet, 2017). The reference or baseline year – 2005 was chosen in accordance with the EU legislation (EC, 2016). The literature review was conducted, in which systematic review approach was applied, and the descriptive and comparative methods were used. The quantitative estimation of NH<sub>3</sub> emissions trends and main sources was performed using data analysis methods, including simple regression.

## Results and Discussion

### *Main sources of ammonia emissions in Latvia*

The main share (86%) of NH<sub>3</sub> emissions in Latvia was originated by agriculture. In Latvia, total NH<sub>3</sub> emissions show significant growing trend from 2005 to 2015, where coefficient of determination is -  $R^2 = 0.8141$  ( $y = 0.2165x + 16.086$ ; p-value is 0.000145). NH<sub>3</sub> emissions from agriculture significantly increased from 2005 to 2015, but from other sectors significantly decreased in the same period (Figure 1).

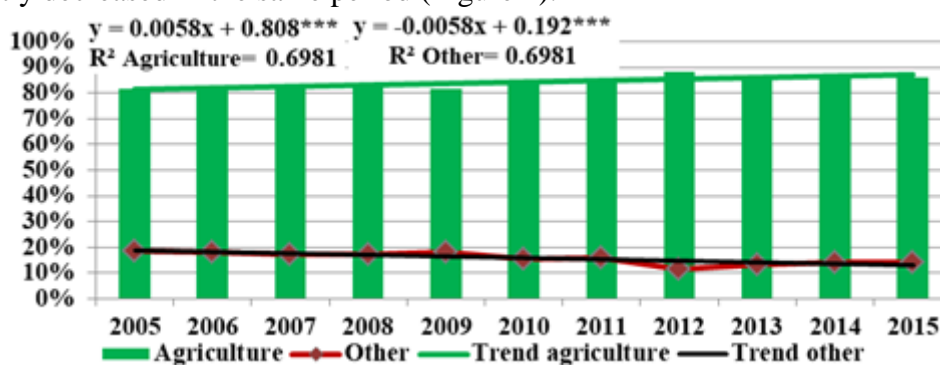


Figure 1. Trends of NH<sub>3</sub> emissions (NH<sub>3</sub> kt) in Latvia, 2005-2015

Source: author's calculations based on data of CLRTAP Data Repository (Eionet, 2017).

The share of NH<sub>3</sub> emissions from manure management was 45.6% in 2015, where 20.7% came from dairy cattle (Table 1). NH<sub>3</sub> emissions from manure management cover emissions from animal housing, grazing and manure storage (EMEP/EEA, 2016). Application of inorganic nitrogen (N) fertilizers, which accounts for 31.6%, is the second main source of NH<sub>3</sub> emissions from agriculture sector (Table 1).

Table 1. Agriculture origin NH<sub>3</sub> emissions in Latvia by source, from 2010 to 2015

Source	2010	2011	2012	2013	2014	2015	% of total	
Manure management	Dairy cattle	3.44	3.44	3.46	3.47	3.51	3.34	20.7%
	Non-dairy cattle	0.63	0.65	0.67	0.7	0.73	0.74	4.6%
	Swine	1.90	1.81	1.72	1.77	1.67	1.55	9.6%
	Laying hens	0.56	0.51	0.51	0.51	0.5	0.49	3.0%
	Broilers	0.20	0.17	0.23	0.23	0.22	0.24	1.5%
	Other animals	0.75	0.37	0.47	0.47	0.64	0.56	6.2%
Application	Inorganic N fertilizers	3.93	3.97	4.42	4.56	4.80	5.10	31.6%
	Animal manure	2.83	2.87	2.93	3.04	3.1	3.17	19.6%
Other	0.29	0.35	0.3	0.33	0.34	0.35	3.2%	
Total:	14.58	14.51	15.19	15.64	16.15	16.14	100.0%	

Source: author's calculations based on data of CLRTAP Data Repository (Eionet, 2017).

In Latvia NH<sub>3</sub> emissions have increased substantially since 2005 by 20.1% - Table 2). Moreover, the emissions from inorganic N fertilizers application have almost doubled (by 96.2%), but manure application grew by 19.2%.

Table 2. Changes of NH<sub>3</sub> emissions from main sources in Latvia, comparing 2005 and 2015

Source	2005	2015	Changes 2015/2005, %	
	NH <sub>3</sub> emission, kt			
Manure management	Dairy cattle	3.87	3.34	-13.7%
	Swine	2.23	1.55	-30.5%
	Laying hens	0.47	0.49	4.3%
	Broilers	0.16	0.24	50.0%
Application	Inorganic N fertilizers	2.6	5.1	96.2%
	Animal manure	2.66	3.17	19.2%
Other	1.45	2.25	55.2%	
Total:	13.44	16.14	20.1%	

Source: author's calculations based on data of CLRTAP Data Repository (Eionet, 2017).

Despite the farms with more than 50 cattle have been distinguished as intensive (EC, 2013), currently those are not recognised as industrial source (EC, 2017). EU Directive 2016/2284 states that the EU Member States could protect small farms and could ensure that impacts (i.e. economic) on small and micro farms are taken into account (EC, 2016). The dairy cattle holdings with more than 50 animal places account for 48.5%, but non-dairy cattle for - 62.1% (Figure 2). Since 2004 the proportion of dairy cattle in the small holdings (fewer than 10 animals) has dropped sharply from 61% to 23%, and this trend could continue. The cattle grazing are less NH<sub>3</sub> emissions originated and more difficult managed stage of rearing. Accordingly, the low-protein feeding for non-dairy cattle is not a priority in Latvia, particularly in mid-term. Consequently, the target holdings should be dairy cattle with 50 and more cattle.

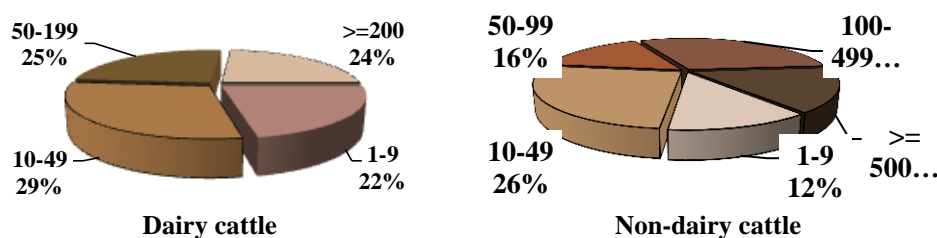


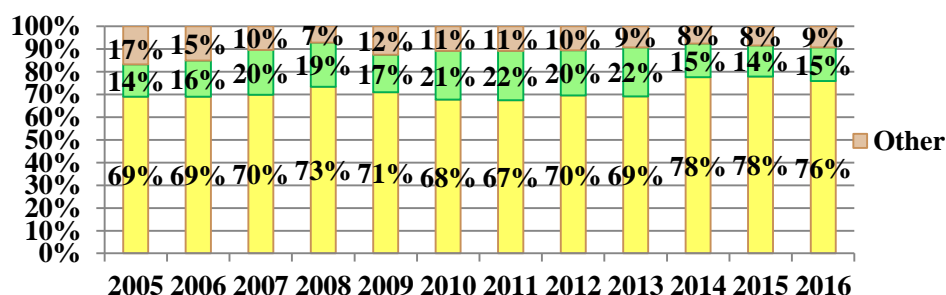
Figure 2. Share of number of livestock by holding size in Latvia, 2016

Source: author's calculations based on published and unpublished data of CSB, 2017.

Directive 2010/75/EU on industrial emissions includes as industrial installations intensive livestock holdings with more than 40,000 places for poultry; with more than 2,000 places for pigs (over 30 kg); with more than 750 places for sows. In Latvia the pig and poultry rearing is concentrated in large holdings, where 76.6% of sows are placed in 15 holdings with more than 500 animals, 78.5% of pigs are fattened in 17 holdings with more than 5,000 animals, but 91.0% of poultry are located in ~ 3-4 holdings with more than 5,000 birds (CSB, 2017). Consequently, the NH<sub>3</sub> reduction measures will cover the major part of livestock, but will affect smaller number of farms, which will facilitate the implementation and support.

The intensive rearing of poultry and pigs is regulated by EU Decision 2017/302, which establishes best available techniques (BAT): nutritional management; feed preparation; housing; collection, storage and processing of manure; and manure land spreading.

The main sources from application of inorganic N fertilizers were cereals and rape areas (Figure 3). Since the large holdings (more than 150 ha) accounted 60.4% of the total sown area, 64.8% of cereals area (45% of farms with more than 300 ha), 77.2% of winter wheat area, and 89.1% of rape area (CSB, 2017), the main target group of agricultural holdings could be large ones.



The share of inorganic N fertilizers' application by crop in Latvia, 2005-2016

Source: author's calculations based on published and unpublished data of CSB, 2017.

### Main NH<sub>3</sub> emissions abatement measures

ECE Guidance suggests NH<sub>3</sub> emission abatement measures in the following areas: nitrogen (N) management, taking into account the whole N cycle; livestock feeding strategies; animal housing techniques; manure storage types; manure application and fertilizer application techniques (UNECE, 2014).

**N management** provides to establish an N input-output balance at the farm level that is aimed to increase the N use efficiency (NUE). Taking into account high implementation and maintenance cost (~ 200-500 EUR/farm/year) this measure could not be as priority for Latvia.

**Livestock feeding strategies** are implemented through: phase feeding; low-protein or low crude protein (CP) feeding (Bittman et al., 2014; UNECE, 2014). Low-protein feed as one of the most cost-effective measure decreases NH<sub>3</sub> emissions in both housing and storage, and following application to land (Hou et al., 2016; Loyon et al., 2016). The low CP diet does not negatively affect the milk quality, but increases NUE, significantly decreases NH<sub>3</sub> emissions, and N output (Bittman et al., 2014; UNECE, 2014; Hristov et al., 2015). Accordingly, producers have financial benefits, because the feed cost is reduced, the need of inorganic fertilizers decreases, and farm profitability increases.

**Manure storage and application**, particularly slurry, is a significant source of emissions. Cover slurry or solid manure during storage is proposed by many scholars (Bittman et al., 2014; EC, 2017). Slurry storages covered by chopped straw, granules, artificial film, peat have significantly decreased NH<sub>3</sub> emissions. Moreover, only natural crust significantly decreases NH<sub>3</sub> emissions by 65% (Hou et al., 2015). The application techniques for slurry (shallow injection, band spreading and trailing shoe), reduces NH<sub>3</sub> emissions by 70-95% (Misselbrook et al., 2016). Some researchers reported lower reduction levels, for example, Hou et al. (2015) argue that reduction by band spreading is 55% (37–67%), incorporation -

70% (50–82%), and injection - 80% (72–86%). Higher reductions could be achieved when incorporation takes place immediately after land spreading (UNECE, 2014; Santonja et al., 2017). Promising manure management techniques such as composting and compacting are not the subject of the evaluation, because there is no previous experience for it in Latvia.

**Application of inorganic N fertilizer** is significant source of N-based emissions (NH<sub>3</sub>, N<sub>2</sub>O) and nitrate leaching. Even though alternative N fertilizers to urea decreased NH<sub>3</sub> emission by 22–55% (UNECE, 2014; Misselbrook et al., 2016; Pan et al., 2016), the urea is commonly used due to high content of N. Recommended NH<sub>3</sub> reduction measure is the use of urease inhibitors (Bittman et al., 2014; Misselbrook et al., 2016; Oenema, 2016), which significantly decreased NH<sub>3</sub> volatilization (UNECE, 2014; Misselbrook et al., 2016; Pan et al., 2016). NH<sub>3</sub> reduction potential is variable; for example, Abalos et al. (2014) reported reduction by 58%, but Ni et al. (2014) indicated wider range - 26–89%. Despite largely proposed use of urease inhibitors as a method for NH<sub>3</sub> mitigation, some evidence indicates that more effective is urea and ammonium based fertilizers' injection and incorporation, compared with urease inhibitors or coating use (Table 4). Due to variability of the reduction efficiency of urease inhibitor, the recommendations should be assessed under different (specific) climatic and soil conditions (Ni et al., 2014), as well as to clarify the financial benefits and to compare another options in certain circumstances (Abalos et al., 2014).

Table 4. NH<sub>3</sub> emissions reduction measure efficiency (reduction potential and costs) for urea and ammonium based fertilizers

Fertilizer	Application technique	NH <sub>3</sub> reduction, %	Cost, EUR/ kg NH <sub>3</sub> -N saved
Urea	Injection	> 80	-0.5–1
	Incorporation	> 50	-0.5–2
	Urease inhibitors	> 30	-0.5–2
	Coating	~ 30	-0.5–2
Ammonium carbonate	Ban	~100	-1–2
Ammonium-based fertilizers	Injection	> 80	0–4
	Incorporation	> 50	0–4

Source: based on Bittman et al., 2014; Oenema, 2016.

Considerably, the most promising mid-term measures in Latvia could be incorporation of urea and ammonium based fertilizers, as well as choosing the appropriate application conditions (soil conditions, weather conditions, i.e. temperature etc.).

## Conclusion

Taking into account that NH<sub>3</sub> emissions from the Latvian agriculture have significantly increased since 2005, the selection of effective reduction measures and their implementation in order to reach mitigation goals is a major challenge. The reduction measures in pig and poultry production should be aimed at larger or industrial farms according to the latest EU regulations. Besides, a major part of livestock is placed in large holdings. In general, the most promising NH<sub>3</sub> emission reduction measures in Latvia could be the following: balanced and low-protein content feeding strategies for intensive breeding of dairy cows, pigs and poultry; low-emissions manure (i.e. slurry) storage and application, including manure incorporation; and urea incorporation. The main tasks or priorities of further research are: 1) the selection of priority measures; 2) identifying the need for state supporting tools and instruments, including EU funds (e.g., Rural Development Plan 2014–2020); and 3) the determination of the necessary studies in the field of livestock husbandry and crop production mainly oriented to the nitrogen use efficiency improvement. The involvement of experts and stakeholders (i.e. farmers) is essential. Besides, future research needs to develop models for forecasting impact of NH<sub>3</sub> reduction measures. At the same time, the cost-benefit analysis of chosen most promising abatement measures should be performed.

## **Acknowledgement**

This study was supported by the Ministry of Agriculture of the Republic of Latvia as a part of the research project „Selection and assessment of effectiveness of ammonia emissions mitigation and reduction measures in agriculture“ (No 10.9.1-11/17/886).

## **References**

- Abalos, D., Jeffery, S., Sanz-Cobena, A., Guardia, G., Vallejo, A. (2014). Meta-analysis of the effect of urease and nitrification inhibitors on crop productivity and nitrogen use efficiency. *Agriculture, Ecosystems and Environment*, 189, 136-144.
- Amon, B. (2016). Housed livestock, manure storage and manure processing. Joint DG ENV & TFRN workshop “Towards joined-up nitrogen guidance for air, water and climate co-benefits”. October 11-12, Brussels.
- Bittman, S., Dedina, M., Howard C.M., Oenema, O., Sutton, M.A. (eds) (2014). *Options for Ammonia Mitigation: Guidance from the UNECE Task Force on Reactive Nitrogen*. Centre for Ecology and Hydrology, Edinburgh, UK.
- CSB (2017). Statistics Database. <http://www.csb.gov.lv/dati/statistikas-datubazes-28270.html>
- EC (2013). Report from the Commission to the European Parliament and the Council Report from the Commission on the reviews undertaken under Article 30(9) and Article 73 of Directive 2010/75/EU on industrial emissions addressing emissions from intensive livestock rearing and combustion plants. COM(2013) 286 final, Brussels, 17.5.2013.
- EC (2016). Directive (EU) 2016/2284 of the European Parliament and of the Council of 14 December 2016 on the reduction of national emissions of certain atmospheric pollutants, amending Directive 2003/35/EC and repealing Directive 2001/81/EC. OJ, L 344, 1–31.
- EC (2017). Commission Implementing Decision (EU) 2017/302 of 15 February 2017 establishing best available techniques (BAT) conclusions, under Directive 2010/75/EU of the European Parliament and of the Council, for the intensive rearing of poultry or pigs. OJ, L 43, 231–279.
- Eionet (2017). Central Data Repository, Latvia, National emission inventories (CLRTAP). <http://cdr.eionet.europa.eu/lv/un/clrtap/inventories/>
- EMEP/EEA (2016). EMEP/EEA air pollutant emission inventory guidebook – 2016: <https://www.eea.europa.eu/publications/emep-eea-guidebook-2016>
- Hou, Y., Velthof, G.L., Oenema, O. (2015). Mitigation of ammonia, nitrous oxide and methane emissions from manure management chains: a meta-analysis and integrated assessment. *Global Change Biology*, 21, 1293-1312.
- Hou, Y., Bai, Z., Lesschen, J. P., Staritsky, I. G., Sikirica, N., Ma, L., Sikirica, N., Ma, L., Velthof, G.L., Oenema, O. (2016). Feed use and nitrogen excretion of livestock in EU-27. *Agriculture, Ecosystems and Environment*, 218, 232-244.
- Hristov, A.N., Heyler, K., Schurman, E., Griswold, K., Topper, P., Hile, M., Dinh, S. (2015). Case study: Reducing dietary protein decreased the ammonia emitting potential of manure from commercial dairy farms. *Professional Animal Scientist*, 31(1), 68-79.
- Loyon, L., Burton, C.H., Misselbrook, T., Webb, J., Philippe, F.X., Aguilar, M., Doreau, M., Hassouna, M., Veldkamp, T., Dourmad, J.Y. Bonmati, A. (2016). Best available technology for European livestock farms: Availability, effectiveness and uptake. *Journal of Environmental Management*, 166, 1-11.
- Misselbrook, T., Bittman, S., Cordovil, C., Rees, B., Sylvester-Bradley, R., Olesen, J., Vallejo, A. (2016). Field application of organic and inorganic fertilizers. Joint DG ENV

- & TFRN workshop “Towards joined-up nitrogen guidance for air, water and climate co-benefits”. October 11-12, Brussels.
- Ni, K., Pacholski, A., Kage, H. (2014). Ammonia volatilization after application of urea to winter wheat over 3 years affected by novel urease and nitrification inhibitors. *Agriculture, ecosystems and environment*, 197, 184-194.
- Oenema, O. (2016). Principles of overall nitrogen management. Joint DG ENV & TFRN workshop “Towards joined-up nitrogen guidance for air, water and climate co-benefits”. October 11-12, Brussels.
- Pan, B., Lam, S.K., Mosier, A., Luo, Y., Chen, D. (2016). Ammonia volatilization from synthetic fertilizers and its mitigation strategies: A global synthesis. *Agriculture, Ecosystems and Environment*, 232, 283-289.
- Santonja, G.G., Georgitzikis, K., Scalet, B.M., Montobbio, P., Roudier, S., Sancho L.D. (2017). Sancho; Best Available Techniques (BAT) Reference Document for the Intensive Rearing of Poultry or Pigs. Publications Office of the European Union, Luxembourg.
- UNECE (2014). Guidance document on preventing and abating ammonia emissions from agricultural sources. ECE/EB.AIR/120. <https://www.unece.org/env/lrtap/welcome.html>

## A QUALITATIVE METHOD FOR DETERMINATION OF NICOTINE IN LITTERED CIGARETTE BUTTS

Marija SRBINOSKA<sup>1\*</sup>, Vesna RADOJIČIĆ<sup>2</sup>, Nermina ĐULANČIĆ<sup>3</sup>, Stefka KIRKOVA<sup>4</sup>

<sup>1</sup>University St.Kliment Ohridski-Bitola, Scientific Tobacco Institute, 7500 Prilep, Republic of Macedonia

<sup>2</sup>University of Belgrade, Faculty of Agriculture, 11080 Belgrade, Republic of Serbia

<sup>3</sup>University of Sarajevo, Faculty of Agriculture and Food Science, 71000 Sarajevo, Bosnia and Herzegovina

<sup>4</sup>Tobacco and Tobacco Products Institute, 4108 Plovdiv-Markovo, Republic of Bulgaria

\*Corresponding author: srbinoska.marija2014@gmail.com

### Abstract

Discarded cigarette butts are toxic, non-biodegradable, waste that create environmental health risks and an economic burden. It is estimated that 1.69 billion pounds of cigarette butts end up as toxic waste annually. In areas with substantial amounts of butts, environmental hazards may arise as nicotine and other chemicals, heavy metals, additives, pesticide residues are leached from the filters and tobacco. The aim of this study was to optimization of qualitative analysis of nicotine in discarded cigarette butts using chemical test (Dragendorff's reagent). Orange colored precipitation with Dragendorff's reagent indicated the presence of nicotine which was confirmed by gas chromatographic (GC-FID) method with liquid-liquid extraction of butts. Ten samples of most popular cigarette brands were selected to cover the low, medium and high range of nicotine yields had to be consistently smoked down to about 1 cm from cigarette filters. The nicotine content in smoked cigarette butts (CBs) with and without remnant tobacco was measured using Dragendorff's test and ISO 10315. Our results confirm the nicotine concentration of orange colored precipitation obtained with Dragendorff's reagent with nicotine concentration measured by GC-FID. The nicotine concentration in littered butts without remnant tobacco was range from 0.24 to 1.36 mg per butt and with remnant tobacco was higher about 20 to 25 %. An accurate analytical method for determining nicotine in littered cigarette butts (CBs) has been developed. This method is found to be low-cost, quick and valuable for analysis of moderate and significant levels of nicotine in cigarette butts (CBs).

**Keywords:** *cigarettes, butt, nicotine, environment, Dragendorff's reagent*

### Introduction

Filters are recognized as an integral part of cigarette design and are used extensively to meet range of product parameters such as draw resistance, and more importantly reduction of tar and nicotine yields. Manufactured cigarettes are the most commonly used form of tobacco, accounting for 92.3% of tobacco product sales worldwide, and most of them are filter-tipped (Euromonitor). With 5.8 trillion cigarettes consumed worldwide in 2014, and nine trillion expected by 2025, the global environmental burden of cigarette waste is also significant (Thomas *et al.*, 2014; Eriksen *et al.*, 2015). The impact that tobacco has on the environment is less well recognized. The World Health Organization (WHO) and Framework Convention on Tobacco Control (FCTC) address the environmental concerns regarding tobacco in Article 18. Both cigarettes smoke itself and the post-consumption waste from cigarettes represent potential point sources for environmental contamination.

Cigarette butts (CBs) are the single most collected item in urban and environmental trash cleanups. An estimated 4.5 trillion of the annual 6 trillion cigarettes sold do not end up in a



dustbin or ashtray, but are deposited somewhere into the urban and environment area as post-consumption waste. Assuming that each filter weighs 170 milligrams, the weight of all butts discarded annually is about 175 200 tonnes (Novotny *et al.*, 2015). Cigarette butt (CBs) littering is very often in urban area. Many smokers who do not properly dispose of their butts, lighting material, and packaging do not consider their behavior littering (Rath *et al.*, 2012). Studies have consistently found that a great majority of smokers litter cigarettes after smoking (76.7% reported by Patel *et al.* (2013), and 84% by Wilson *et al.* (2014)). The problem has increased in recent years with government legislation for smoking restrictions in public buildings and restaurants forcing smokers outside, where butts are often littered. Typically, discarded cigarette butts consist of three components: unsmoked remnant tobacco (including partially smoked/charred tobacco on the end), the filter of a filtered cigarette and a paper wrap. Each of these components of the discarded cigarette butt presents its own concerns. Cellulose acetate is used in the majority of commercial filters but some filters are also made from either paper or polypropylene. The cellulose acetate fibers are a slowly degradable plastic in the environment, with an estimated degradation of 18 months or longer in ideal conditions (Ach, 1993). These fibers, each about 20  $\mu$  in diameter, are treated with titanium dioxide and over 15,000 of them are packed tightly together, using triacetin as a binding agent, to create a single filter (Norman, 1999). Most cigarette filters are surrounded by two layers of paper and rayon wrapping, the porosity of which acts to control the airflow through the filter. Cigarette paper also has many chemicals, including glues to hold the paper together and alkali metal salts of organic acids such as sodium acetate to keep the cigarette burning while smoking (Norman, 1999). Although the environmental impact of this waste has not yet been quantified, the large quantity of discarded butts may allow leachates to affect the quality of aquatic environments and soil. Few studies have investigated nicotine and chemical components in CBs by different chromatographic methods (Moriwaki *et al.*, 2009; Slaughter *et al.*, 2011; Novotny and Slaughter, 2014). There are a wide range of factors that can impact the chemicals retained in cigarette butts. These include the brand of the cigarette, the length of the cigarette butt, the temperature during the aging process, the number of puffs taken while the cigarette was being smoked and the degradation of the cigarette butt. The nicotine content released in smoke and retained in filters depends from cigarette design, consumers smoking behavior and filter efficiency. In commercial filter-tipped cigarettes nicotine normally constitutes from 1.0 to 1.5 percent of the tobacco weight, so that each cigarette contains an average of 10 to 15 mg per gram of nicotine. The amount of nicotine, chemically transformed during smoking, is unforeseeable and depends on the burning temperature. The rate of deposition of nicotine depends on the chemical composition and the size of particles in the tobacco smoke (Pankow *et al.*, 2003; Kibet *et al.*, 2016). If we assume that the 20% of this amount goes into smoke and 50% is decomposed during combustion. In this case the amount of nicotine remaining in the single butt is not significant. What multiplies the problem is a large number of discarded CBs. Here we propose a simple and rapid chemical test using Dragendorff's reagent (potassium iodide-bismuth nitrate), which is widely used in routine detection of alkaloids. The aim of this study was to optimization of qualitative analysis of nicotine in discarded cigarette butts using chemical test (Dragendorff's reagent). Orange colored precipitation with Dragendorff's reagent indicated the presence of nicotine which was confirmed by gas chromatographic (GC-FID) method with liquid-liquid extraction of butts.

## Material and methods

### Sample preparation

Sampling and analysis were conducted during May/June of 2017. Ten samples of most popular cigarette brands filters were purchased in a convenience store to cover the low, medium and high range of nicotine yields.

The cigarettes are chosen to have the same type of filter and filter length and therefore similar filtration efficiency. Cigarettes are conditioned at 22°C and at 60% relative humidity according to ISO 3402: 1999. In order to minimize variability between cigarettes, they were weight ( $\pm 3\%$  of mean weight) and pressure drop ( $\pm 3\%$  of mean of pressure drop) selected.

All cigarette samples was smoked in smoking machine Borgwaldt RM 20/CS under ISO smoking regime (ISO 3308:2012) (35 ml volume and 2 s duration every 60 s, without blocking of filter ventilation) to about 1 cm from cigarette filters. The resulting CBs after machine smoking were collected in in zipped plastic bag and stored in the dark at room temperature.

### Materials

Acetonitrile, 25 mM phosphate buffer (pH 7.8), ethanol, *n*-heptadecane, bismuth subnitrate, glacial acetic acid, potassium iodide, sodium hydroxide, and hydrochloric acid. All reagents are analytical grade. Dragendorff's reagent was prepared according of the directions in The International Pharmacopoeia - Sixth Edition from 2016.

### Dragendorff test

In order to qualitatively determine the nicotine in the CBs (with and without remnant tobacco) the cellulose acetate is dissolved in acetonitrile to release any trapped nicotine.

The filter butts from five to seven cigarettes are placed in a 125 ml Erlenmeyer flask and added 50 ml of acetonitrile. The flask is shaken on a mechanical shaker about 30 min until the cellulose acetate is dissolved. The cellulose acetate is precipitated from solution by addition of 50 mL of 25 mM phosphate buffer (pH 7.8) in water. The aqueous extract was filtered twice through filter paper.

In the tube was added 5 mL aqueous extract, then 0.5 mL of methanol and 0.5 mL of 8M sodium hydroxide (NaOH). The tube was closed and vigorously shaken. The contents are filtrated in another test tube. In another test tube, weigh 2 mL of the extract after alkalization, and then add 2 mL of 2M hydrochloric acid (HCl) and 1.0 mL of the Dragendorff's reagent. The tube is closed and vigorously shaken. Leave to stay for a few minutes. It is observed obtaining orange staining of the solution and simultaneous precipitation.

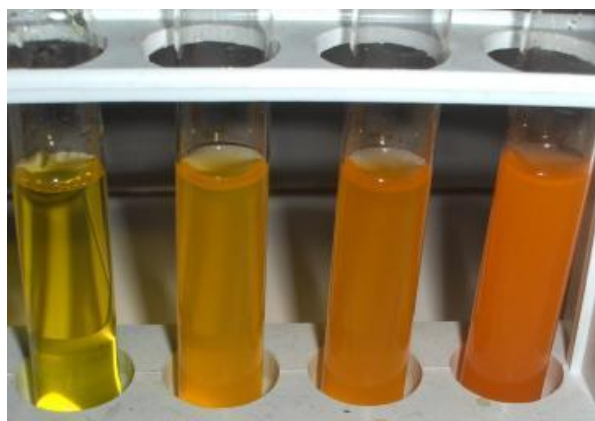
### Gas chromatographic (GC-FID) procedure

The CBs were extracted into 20 mL of a methanol solution containing 1 mg/mL sodium hydroxide and 0.24 mg/mL *n*-heptadecane internal standard. The flask containing the extraction solution was stoppered and shaken on a flat-bed orbital shaker at medium speed for a minimum of 40 min. The nicotine content of the extract was determined by using an Agilent 7890B gas chromatograph with a Varian CP Wax 52 CB, 0.53 mm  $\times$  2 m  $\times$  25 m, fused silica column and flame ionization detector (FID) using ISO 10315 with modification.

## Results and Discussion

The amount of retained nicotine in the filter tip after smoking depends on the filter design, the types of tobacco mixture, how the cigarette was smoked, and the mass transfer behavior of combustion products along the cigarette. The smokers have a wide range of smoking habits that can impact emission and deposition of nicotine on filter tip. Regarding the sample preparation we perform machine smoking allows controlling variables such as the size and duration of puffs taken on the cigarette and reproducible generating mainstream smoke.

Although there may be differences in cigarette emissions using a smoking machine compared to a human, we consider that machine smoking obtained reproducible deposition of nicotine on filter tip. Qualitative analysis of nicotine in CBs was carried out using chemical test (Dragendorff's reagent) The heavy metal atom (BiI<sub>4</sub>) combines with the nitrogen in the alkaloid to form ion pairs. This ion pair forms insoluble orange red colored complex (Pederson 2006). The first step is to dissolve the cellulose with acetonitrile to release the trapped nicotine on the filter butts. After the filter is dissolved, the cellulose acetate is precipitated by addition of phosphate buffer and an aliquot of the filtered solution is tested for alkaloid presence. First we optimize Dragendorff's test for determination of presence of nicotine in aqueous extract of CBs (Pharmaceutical Chemical Analysis: Methods for Identification and Limit Tests). Extraction of retained nicotine from CBs (with and without remnant tobacco on) carried out as follow: in 5 mL aqueous extract was added 0.5 mL of methanol and 0.5 mL of 8M sodium hydroxide (NaOH). Without the addition of methanol during the extraction, the extraction efficiency was less, but was highly variable. The addition of methanol helps to increase efficiency. Free-base nicotine is also the dominant form of nicotine on the cigarette filter when freshly smoked and addition of sodium hydroxide leads to deprotonation of the present monoprotonated and diprotonated form of nicotine. The extract was found to be very efficient when 0.5 mL of 8M sodium hydroxide (NaOH) was added to the solution, but less led to inefficient recovery of nicotine. Alkaloid detecting reagents are solutions of the salts of heavy metals such as Dragendorff's (potassium iodobismuthate solution KBiI<sub>4</sub>). The mechanism of action is proposed to occur via coupling of the reagent's heavy metal atom in the reagent with the nitrogen in the alkaloids to form ion pairs. The nitrogen of pyrrolidine ring of nicotine is protonated due to the acetic acid in present of Dragendorff's reagent and the ion pairs to form insoluble orange red colored precipitate. Color disappears with alkaloid's solution in extremely low concentration (Picture 1).



Picture 1. Dragendorff test for nicotine detection in cigarette butts

Confirmation of the nicotine in CBs with and without remnant tobacco also is carried out with GC-FID after extraction of nicotine retained in CBs with methanol solution containing 1 mg/mL sodium hydroxide. Table 1 summarizes mean concentrations of measurement of nicotine retained in the CBs with and without remnant tobacco for of each cigarette samples analyzed by gas chromatography

Table 1. Concentrations of measurement of nicotine retained in the CBs with and without remnant tobacco (n=3, mean±SD)

Sample No.	Labeled nicotine concentration (mg/cig.)	Determined nicotine concentration without tobacco (mg/butt)	Determined nicotine concentration with tobacco (mg/butt)
1	0.3	0.24±0.1	0.28±0.0
2	0.3	0.26±0.1	0.31±0.1
3	0.4	0.61±0.3	0.73±0.4
4	0.4	0.54±0.2	0.67±0.5
5	0.4	0.50±0.4	0.59±0.4
6	0.6	0.91±0.2	1.07±0.7
7	0.6	0.79±0.6	0.99±0.6
8	0.6	0.89±0.7	1.09±0.3
9	0.8	1.24±0.6	1.50±0.3
10	0.8	1.36±0.3	1.61±0.4

Our results confirm the nicotine concentration of orange colored precipitation obtained with Dragendorff's reagent with nicotine concentration measured by GC-FID. The nicotine concentration in littered butts without remnant tobacco was range from 0.24 to 1.36 mg per butt and with remnant tobacco was higher about 20 to 25 %.

### Conclusions

Given the frequently littering of cigarette butts, and the release of nicotine, cigarette butts are assessed to be a relevant threat to the quality of urban environment. While most smokers and nonsmokers today understand that cigarette butt is an environmental problem, a minority of smokers still do not recognize discarded cigarettes butts as waste.

Our results demonstrate that the Dragendorff test can be a useful and simple qualitative method for determine of amount of nicotine retained in in littered cigarette butts (CBs).

Comparison suggests that, for the measurement of nicotine, which is normally conducted by GC with internal standardization, the reproducibility is visible than that observed in Dragendorff test.

Dragendorff test is found to be low-cost, quick and valuable for analysis of moderate and significant levels of nicotine in cigarette butts (CBs). Additionally, the pathways of nicotine released from cigarette butts to urban environment are in need of investigation.

### References

- Ach A. (1993). Biodegradable plastics based on cellulose acetate. Part A Pure and Applied Chemistry. Journal of Macromolecular Science, pp. 30(9), 733-740.
- Eriksen M., Mackay E.M., J.; Schlugern N., Gomeshtapel F.I., Drope J. (2015).The Tobacco Atlas, 5 th Ed. The American Cancer Society, Atlanta, GA, USA.
- Euromonitor International.Historical retail sales, million sticks, available countries, 2003-2013. [Database].<http://www.euromonitor.com>. Accessed 20 Feb 2017.
- ISO 10315 (2013). Cigarettes -- Determination of nicotine in smoke condensates -- Gas-chromatographic method.
- ISO 3308 (2012). Routine analytical cigarette-smoking machine -- Definitions and standard conditions.
- ISO 3402 (1999). Tobacco and tobacco products -- Atmosphere for conditioning and testing.

- Kibet J., Kurgat C., Limo S., Rono N., Bosire J. (2016). Kinetic model of nicotine in mainstream cigarette smoking. *Chemistry Central Journal*.pp.2-9.
- Moriwaki H., Kitajima S., Katahira K. (2009). Waste on the roadside, 'poi-sute' waste: its distribution and elution potential of pollutants into environment. *Waste Manag.* 29, 1192–1197.
- Norman A. (1999). Cigarette manufacture: cigarette design and materials. In: Davis DL, Nielsen MT, editors. *Tobacco: production, chemistry and technology*. Oxford: Blackwell Science; 1999. pp. 353–87.
- Novotny T.E., Bialous S.A., Burt L., Curtis C., da Costa V.L., Iqtidar S.U., Liu Y., Pujari S. (2015). The environmental and health impacts of tobacco agriculture, cigarette manufacture and consumption *Bulletin of the World Health Organization*. 93:877-880.
- Novotny T.E., Slaughter E. (2014). Tobacco product waste: An environmental approach to reduce tobacco consumption. *Current Environmental Health Reports*. 1(3), 208–216.
- Pankow J.F., Tavakoli A.D., Luo W., Isabelle L.M. (2003). Percent free base nicotine in the tobacco smoke particulate matter of selected commercial and reference cigarettes. *Chemical Research in Toxicology*.16(8):1014–8.
- Patel V., Thomson G.W., Wilson, N. (2013). Cigarette butt littering in city streets: a new methodology for studying and results. *Tob. Control* 22, 59–62.
- Pederson O. (2006) *Pharmaceutical Chemical Analysis: Methods for Identification and Limit Tests* CRC Press, pp. 13-15.
- Rath J. M., Rubenstein R.A., Curry L.E., Shank S.E., Cartwright J. C. (2012). Cigarette Litter: Smokers' Attitudes and Behaviors *Int. J. Environ. Res. Public Health* 2012, 9(6), 2189-2203.
- Slaughter E., Gersberg R.M., Watanabe K., Rudolph J., Novotny T.E. (2011). Toxicity of cigarette butts, and their chemical components, to marine and freshwater fish. *Tob. Control*, 20(Suppl 1),i25–i29.
- Wilson N., Oliver J., Thomson, G. (2014). Smoking close to others and butt littering at bus stops: pilot observational study. *Peer J.* 2, e 272.

## CONSEQUENCES OF FUTURE EXPANSION AT THE ARCTIC TREELINE IN NORTHERNMOST NORWAY

Oddvar SKRE<sup>1\*</sup>, Stein Rune KARLSEN<sup>2</sup>, Jan Åge RISETH<sup>2</sup>, Frans E. WIELGOLASKI<sup>3</sup>

<sup>1</sup>Skre Nature and Environment, Fanaflaten 4, N-5244 Fana, Norway.

<sup>2</sup>Norut Northern Research Institute, NO - 9294 Tromsø, Norway

<sup>3</sup>Institute of Bioscience, University of Oslo, Norway

\*Corresponding author: oddvar@nmvskre.no

### Abstract

Seedlings of mountain birch (*Betula pubescens* var. *tortuosa*), were transplanted to a site close to the town Vardø, in the arctic part of the Varanger area in northernmost Norway. The site is partly snow-free, sheltered by a willow thicket, and partly on an exposed ditched peat bog with thick snow cover from a nearby snowfence. Annual measurements were carried out on survival and growth parameters. The objective of this review study is to evaluate the consequences of future climate and land-use changes on the birch treeline and local communities on the basis of earlier studies. The preliminary conclusion from this study is that local climate may be more important than the overall climatic variation in the adaptation and reforestation process in northernmost Fennoscandia. In this process, the subarctic willow and shrub vegetation seems to be an important factor influencing the microclimate and seedling establishment. Species and provenances originating from areas with similar latitudes and climatic conditions as the reforestation area, seemed to be most successful. The Varanger area has always been a meeting place between different cultures, i.e. the Sami, Norwegian, Finnish and Russian population. The study indicates that in a changed climate the birch forest area would expand because there will be more willow growth and consequently more safe sites for birch seedling establishment and growth, which would also create a better local climate for the human population. In this process, local birch populations that are adapted to a more coastal climate, would have an advantage. Since birch has been shown to be an important resource for all these cultures, this would decrease the level of conflicts between the different groups of stakeholders about the resources in the area.

**Keywords:** *Northernmost Norway, mountain birch, Arctic treeline, treeline.*

### Introduction

The Varanger peninsula west of the city of Vardø (Fig 1) and the coastline along the adjoining Varanger fjord, is located in the arctic-boreal transition area, between 70-71°N, and 27-31°E in northeasternmost Norway. Most of the area is a true arctic tree less undulating inland plain at 2-300 m altitude, where the highest mountain peak reach 636 m altitude. The dominant treeline species is mountain birch (*Betula pubescens* var. *tortuosa*) with patches of rowan (*Sorbus aucuparia*) and abundant growth of willow species (mostly *Salix phylicifolia* and *S. glauca*) outside the tree line (Karlsen *et al.*, 2005). In the southern and eastern part of the peninsula there are large areas of wetlands and willow thickets. The mean annual precipitation is in the range 365 to 550 mm and mean July temperatures between 9.8 and 12.3°C. The first immigrants after the deglaciation 12 000 years ago were hunters and fishers, mostly on the rich populations of reindeer and marine resources (fish, whale and seal), and there are numerous remains of ancient settlements along the coast (Slettjord, 1993). These are believed to be the forerunner of what was later defined as the Sami population in the area. However,

from about 700 A.C. immigrants from southern Norway started to settle along the coast, where they were living of fishing and fur trade with Russia. The oldest city in northern Norway, Vardø, at the easternmost coast of the peninsula, was established around Vardøhus castle in 1307, to protect Norway/Denmark from Russian and Swedish influence. Around 1500 the wild reindeer population had decreased to a minimum due to overexploitation, and part of the native Sami population in the area then turned partly to a nomadic life form where they started to keep reindeer as domestic animals, travelling up to 200 km between summer pastures at the coast and winter pastures with lichen (*Cladonia* spp.) in the inland areas. Another part continued their fishing and hunting activities and combined this with a small livestock. Their winter settlements were located in the inner part of the fjord, while the summer settlements were located further out along the seaside (Schanche, 2002). Over-grazing and excessive clear cutting have permanently damaged the ecosystems of the outermost coast of the Varanger peninsula more than ecosystems further inland. Currently, reindeer herding has been restored and have grown to be a viable and prosperous industry. However, climate change with milder winters causes ice formation after thawing periods. This makes the lichen difficult or impossible to reach by the animals (cf. Tømmervik *et al.*, 2004; Tømmervik *et al.*, 2005; Riseth *et al.*, 2011).

The ecosystems of these coastal districts are now characterized by low regrowth due to the harsh climate with an average tetratherm temperature of June, July, August and September just below 8°C in recent years. However, it should be possible to get an “Environmental forest” to survive in the Vardø area, particularly by the present climate change (Skre *et al.*, 2002; Skre *et al.*, 2005), by choosing the right tree species and provenances and by protection and good shelter especially to the young seedlings (Skre *et al.*, 2017). This is true especially for the dominant treeline species *Betula pubescens* var. *tortuosa*, but also for other low tetratherm temperature requiring deciduous trees like *Populus tremula*, *Prunus padus*, *Alnus incana*, *Sorbus aucuparia*. Re-vegetation of most coastal districts in Finnmark county today, therefore, probably will require both shelterbelts, protection of populations from grazing, and species adapted to local climate and soil. Indigenous willows, such as *Salix lanata* and *Salix phyllicifolia* grow rapidly and form natural shelterbelts on the coast, often up to 5 m high. As the willow thickets grow older, hardy genotypes of larger and less wind-tolerant species can be transplanted into the natural shelterbelts formed by the willows (without too strong shading) and in small ditches in the lee of furrowed soil ridges on a mixture of mineral and organic soil (Slettjord, 1993).

With this background, the aim of this review study is to evaluate the consequences of the expected climate and land-use changes on the treeline at different scales and their implications for local communities, by summarize some recent results from transplanted birch provenances, and discuss the implications for local communities.

## Background

Seedlings from 8 populations of mountain birch (*Betula pubescens* var. *tortuosa*), Fig 1 and Table 1, were transplanted to a subalpine site in Kilpisjärvi (510 m altitude) and an Arctic site in Vardø (15 m altitude). Fig 2 shown a view of the Vardø site. In Table 1 the position and altitudes of the seed populations are shown with the mean January ( $t_1$ ) and July temperatures ( $t_7$ ) in °C. The continentality is determined mainly by the amplitude between  $t_1$  and  $t_7$  (Ovaska *et al.*, 2005). As a result, populations from Utsjoki (FU), Kevo (FJ and FK), Kilpisjärvi (FKi) and Abisko (SAb) were classified as continental and those from Narsassuaq (GNa), Hafnarskogur (IHa), Blefjell (NB), Melbu (NMe) and Hammerfest (NHa) as oceanic (cf. Fig. 1). The seedlings were raised in the greenhouse at University of Tromsø, and transplanted in 2002 to the Vardø and Kilpisjärvi sites as five replicates with 1 m<sup>2</sup> plots and 20 plants per

population and replicate (Ovaska *et al.*, 2005). The results from this extensive long time study was recently analysed and published (Skre *et al.*, 2017).

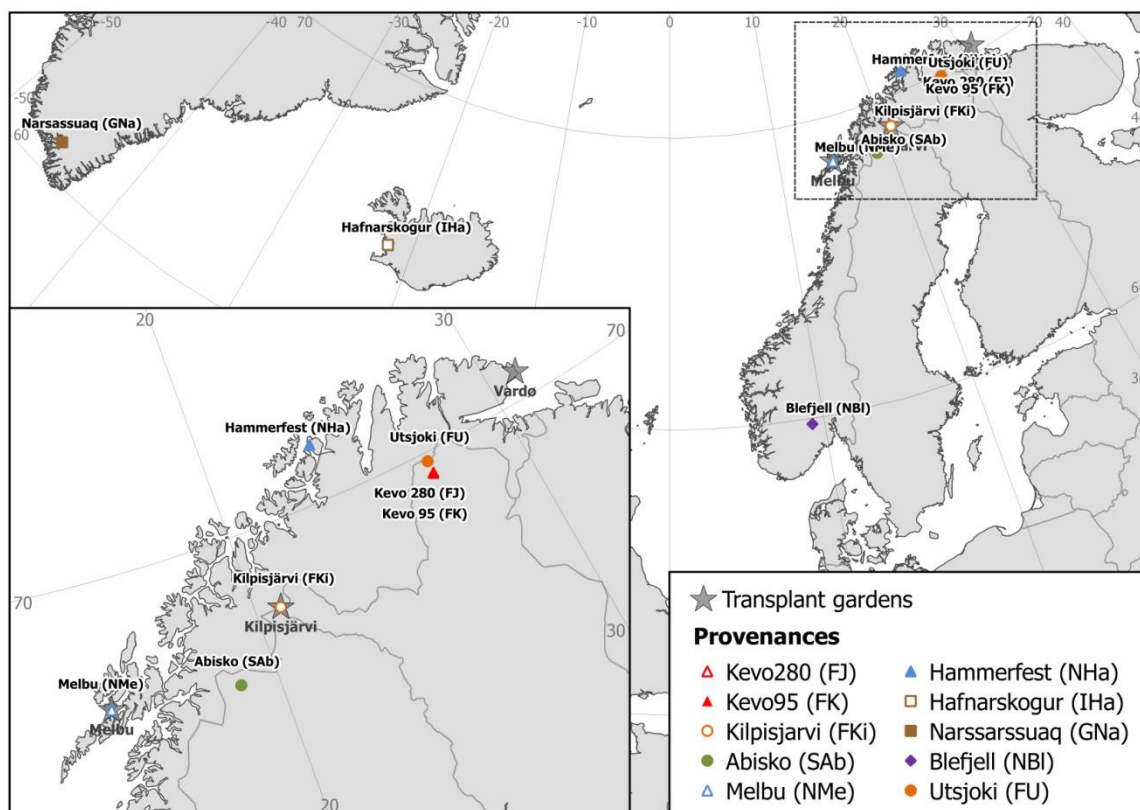


Fig 1. Location of the transplanted gardens at Vardø and Kilpisjärvi (Skre *et al.* 2017). The map also shows the location of mountain birch provenances transplanted to Vardø and Kilpisjärvi. The Varanger peninsula is located just west of the city of Vardø.

## Results and Discussion

**Birch ecology.** Recently, Skre *et al.* (2017) analysed the extensive dataset of transplanted birch at the Vardø and Kilpisjärvi site (Fig. 1). The survival rates during 2010-14 at Vardø and Kilpisjärvi (planted in 2002) are shown in Fig. 3. At the continental Kilpisjärvi site there was a strong latitudinal effect where the three southernmost populations (NBI, GNa and IHa) were less successful than their northern relatives, but also a certain effect of different oceanicity. At the Vardø site, the northern oceanic plants from Hammerfest (NHa) were the most successful in terms of survival rates at both sites. Skre *et al.* (2017) also found that measurements on total living height partly confirmed the results of the survival rates, but with generally much lower growth rates in the plants growing at the Vardø site than at the Kilpisjärvi site, in agreement with summer temperatures (Table 1).

In contrast to the relatively small macroclimatic differences between Vardø and Kilpisjärvi, a clear difference was found within the Vardø site, between the two different parts of the site (Skre *et al.*, 2017), illustrating the effect of different snow cover and growing season (*cf.* Holtmeier and Broll, 2005). In this respect the three continental populations (FK, FK<sub>i</sub>, SAb) seemed to be most sensitive. Negative height increments due to dieback were found in all populations at the four cold and wet plots (Skre, unpubl.). In terms of survival rates and height increment, the warm and dry plot at the Vardø site was comparable to the Kilpisjärvi site (Skre *et al.*, 2017).



Table 1. Origin of seed populations, with position, altitude (m), mean temperatures 1961-90\* in °C of January ( $t_1$ ) and July ( $t_7$ ), The localities are classified as oceanic (-) when the difference between  $t_7$  and  $t_1$  is below 20°C (Ovaska *et al.*, 2005).

No	Population	Continentally	Altitude m	Latitude	Longitude	$t_1$	$t_7$
1	Kevo 280 (FJ)	+	280	69.8	27.0	-12.1	11.8
2	Kevo 95 (FK)	+	95	69.8	27.0	-13.6	13.3
3	Kilpisjärvi (FKi)	+	500	69.0	20.8	-10.6	11.2
4	Abisko (SAb)	+	360	68.3	18.8	-10.3	11.4
5	Melbu (NMe)	-	40	68.5	14.8	-1.0	13.1
6	Hammerfest (NHa)	-	70	70.7	23.7	-5.5	12.3
7	Hafnaskogur (IHa)	-	20	64.5	-21.9	-0.3	10.2
8	Narsassuaq (GNa)	-	70	61.2	-45.4	-3.3	7.0
9	Blefjell (NBI)	+	750	59.8	9.2	-5.6	13.5
10	Utsjoki (FU)	+	200	69.9	27.0	-12.8	12.5
	Vardø	-	13	10.3	31.1	-4.3	9.1



Fig 2. View of the Arctic Arboretum in Vardø September 2010. In front the cold and wet birch replicates, in the background to the left the warm and dry replicate, sheltered by the willow thicket and the conifer plantation behind. Photo Oddvar Skre.

It is interesting to notice that plants from Iceland (IHa) showed relatively high survival rates in spite of its southern origin (*cf.* Table 1). This adaptation may be partly climatic (Myking, 1999) but also genetic as a result of inbreeding with *B nana* (Anamthawat-Jonsson *et al.*, 1993; Thorsson *et al.*, 2001).

The present study supports studies on birch ecology as influenced by climate change (*e.g.* Tømmervik *et al.*, 2005; Ovaska *et al.*, 2005; Johansen and Karlsen 2005; Bjerke *et al.*, 2014; Bjerke *et al.*, 2017; Skre *et al.*, 2017) indicating that climate change with milder winters and longer growing season as well as increasing precipitation may favour mountain birch plants

adapted to an oceanic climate, that are less sensitive to frost and insect damages than continental populations. This strongly indicates that mountain birch would be a good indicator for such changes in the future. As expected, the various birch provenances seem to be best adapted to survive and grow in the climate of their origin, while transplantation to a different climate, makes the plants less adapted. Plants with high demands for dormancy breaking (Myking and Heide, 1995), *i.e.* southern and oceanic provenances would have an advantage (Vitasse *et al.*, 2014), since also spring frosts caused by premature dehardening would be more common (*cf.* Myking, 1999).

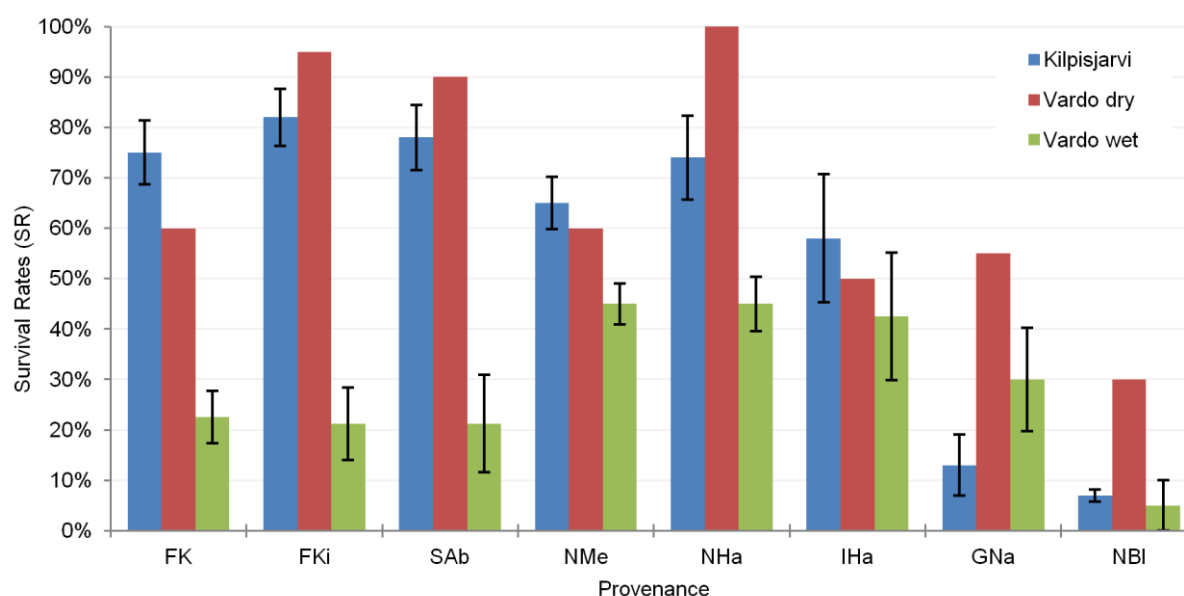


Fig 3. Mean survival rates (%) with confidence limits 2010-14 in birch seedlings from birch provenances (*cf.* Table 1 and Fig 1) at the cold and warm parts of the Vardø site and in Kilpisjärvi. See Table 1 for acronyms and locations of seed populations. After Skre *et al.*, (2017).

Further, predictions for the Varanger region (Hanssen-Bauer *et al.*, 2017) indicate an annual temperature increase of 2.1-6.7°C (depending of the scenario used) comparing 1971-2000 with 2071-2100, and 11-17% increase in annual precipitation,. These scenarios towards a more oceanic climate along the coast of northern Scandinavia, is associated with increased risk of insect attacks (Jepsen *et al.*, 2011). Polycormic birch with high degree of inbreeding with *B. nana* would then have an advantage (Nilsen and Wielgolaski, 2001). Similarly, oceanic birch provenances (IH, NMe, NHa) would be expected to expand at the expense of continental relatives (FKl, FK, SAb) because they are more adapted to spring frosts (*e.g.* Skre *et al.*, 2005). Similar relationships may be used to predict future changes on species level. Scenarios of future forest in northernmost Norway indicate reduction of the continental lichen rich alpine heaths, and such changes would have consequences for the reindeer grazing system, as the predicted changes would lead to a decrease in the vegetation types that have high winter grazing accessibility for reindeer (Karlsen *et al.*, 2017).

**Mountain birch as a socio-ecological factor in northernmost Norway.** Earlier investigations seem to indicate that in addition to climate, land-use change like overgrazing by reindeer and abandonment of farmland is an important driver of change (*cf.* Körner and Paulsen, 2004, Bryn, 2008; Aune *et al.*, 2011). The frequent insect attacks by geometrid moths are also related to climate change. Increased reindeer grazing as well as insect attacks would be expected to slow down treeline advance as stated by Neuvonen *et al.* (1999) and Jepsen *et al.*

(2008), while reduced reindeer grazing would enhance treeline advance (Neuvonen *et al.*, 1999). The study also indicated that local climate may be equally important than the overall climatic variation in the adaptation and reforestation process in northernmost Fennoscandia. In this process, the subarctic willow and shrub vegetation seems to be an important factor, influencing the microclimate and seedling establishment. Different snow and temperature conditions are the main selective factors, and the northern Hammerfest population (NHa) seemed to be most successful at this site. Finally, birch plants growing close to treeline seem to be subjected to frequent frost damages causing dieback of annual shoots and negative height increment. The birch forest has traditionally been used by the Sami for different purposes (*e.g.* Aikio and Müller-Wille, 2005) *i.e.* firewood heating, building material and handicrafts, and is a valuable resource for the aboriginal Sami population, but have also been very important for the Norwegian settlements along the coast (Slettjord, 1993). As a result, large areas along the eastern coast of the Varanger Peninsula were deforested. During the last centuries, there have also been many conflicts between the different cultures and life forms in the Varanger area, *i.e.* between Sami reindeer herders and Norwegian and Finnish («kvenish») sheep farmers about summer pastures and birch forests (Riseth 2007). The central part of the Varanger Peninsula is since 2006 a national park area, where construction and roadbuilding activities are restricted because of the wildlife and vegetation (Riseth, 2007). Altogether, this mixture and interactions between different cultures and life forms makes the Varanger peninsula a very good example of commitment of local communities to their environment, including the relationship and partnership between different stakeholders about sharing resources and ecosystem services. The main traditional products from the farmers in the area is sheep and cattle meat and milk products, while the reindeer herders produce reindeer meat and handicrafts, *e.g.* hide, carved reindeer horn and birch wood products. The sheep and reindeer husbandry in the study area is providing a number of ecosystem services, like landscape protection and biodiversity, and preserving cultural and spiritual values, as well as income and employment. During the recent decades, the economy has gradually changed from primary to secondary sector activities like agrotourism (small restaurants, farm shops and hotels) where tourists can stay overnight with breakfast, taste local food and buy locally produced handicrafts, as well as performing guided tours and hiking trips in the national park and along the coast for recreation, and visits to bird cliffs and fishing villages.

### **Conclusion**

Studies on traditional sustainable and balanced use of ecosystem services by different stakeholders/cultures, *e.g.* reindeer herders, sheep farmers, local enterprises (*e.g.* Müller-Wille *et al.*, 2005), indicate how to make use of them in a sustainable way in an arctic environment and how possible conflicts between user groups has been solved in a successful way. The present study seem to indicate that although local birch provenances seem to be best adapted at present, more oceanic provenances may have an advantage in the future, and in a future climate with extended birch and willow growth along the Arctic coast of Norway, balanced use of grazing areas by sheep farmers and/or reindeer herders would be easier to achieve. With better grazing conditions, good relationships between reindeer herders and conservationists and ecotourism in the national park area in the inner part of Varanger peninsula, would also be expected. However, because the lichen is a limiting factor for reindeer grazing in winter, the changed climate would represent a challenge for reindeer herders, and compensation measures like strict population control and/or supplementary winter food would be necessary. In this respect, the increased birch and willow growth would represent a valuable resource – not only for reindeer herders, but also for sheep farming, sustainable tourism and the well-being of the local population.

## References

- Aikio MS., Müller-Wille L. (2005). Sámi approaches to mountain birch utilization. In: Wielgolaski FE (ed) *Plant Ecology, Herbivory and Human Impact in Nordic Mountain Birch Forests*, p 255-268. Springer: Ecological Studies 180.
- Anamthawat-Jonsson K., Heslop-Harrison JS., Tomasson T. (1993). Genetics, cytogenetics and molecular genetics of Icelandic birch; Implications for breeding and reforestation in cold climates. In: Alden J, Mastrantonio JL, Ødum S (eds) *Forest Development in Cold Climates*, p 357-368. Plenum Press, N.Y.-London.
- Aune S., Hofgaard A., Söderström L. (2011). Contrasting climate and land-use driven tree encroachment patterns of subarctic tundra in northern Norway and the Kola peninsula. *Can J For Res* 41: 437-4.
- Bjerke JW., Karlsen SR., Høgda KA., Malnes E., Jepsen JU., Lovibond S., Vikhamar-Schuler D., Tømmervik H. (2014). Record-low primary productivity and high plant damage in the Nordic Arctic Region in 2012 caused by multiple weather events and pest outbreaks. *Environmental Research Letters*. 9: 084006 (14 pp.).
- Bjerke JW., Treharne R., Vikhamar-Schuler D., Karlsen SR., Ravolainen V., Bokhorst S., Phoenix GK., Bochenek Z., Tømmervik H. (2017). Understanding the drivers of extensive plant damage in boreal and Arctic ecosystems: Insights from field surveys in the aftermath of damage. *Science of the Total Environment* 599-600: 1965–1976.
- Bløndal S. (1993). Socioeconomic importance of forests in Iceland. In: Alden J, Mastrantonio JL, Ødum S (eds) *Forest Development in Cold Climates*, p 1-14. Plenum Press, N.Y.-London.
- Bryn A. (2008). Recent forest limit changes in southeast Norway; effects of climate change on regrowth after abandoned utilization? *Norwegian J Geogr* 62:251-270
- Hanssen-Bauer I., Førland, EJ., Haddeland I., Hisdal H., Lawrence D., Mayer S., Nesje A., Nilsen JEØ., Sandven S., Sandø AB., Sorteberg A., Ådlandsvik B. (2017). Climate in Norway 2100 – a knowledge base for climate adaptation. Norwegian Environment Agency. Report 1/2017. <http://www.miljodirektoratet.no/M741/>
- Holtmeier F-K., Broll G. (2005). Sensitivity and response of northern hemisphere altitudinal and polar treelines to environmental change at landscape and local scales. *Global Ecol Biogeogr* 14: 395-410.
- Jepsen JU., Hagen SB., Ims RA., Yoccoz NG. (2008). Climate change and outbreaks of the geometrids *Operophtera brumata* and *Epirrita autumnata* in subarctic birch forests; evidence of a recent outbreak range expansion. *J. Animal Ecology* 77: 257-264.
- Johansen B., Karlsen SR. (2005). Monitoring vegetation changes on Finnmarksvidda, northern Norway, using Landsat MSS and Landsat TM/ETM+ satellite images. *Phytocoenologia* 35:969-984.
- Karlsen, SR., Elvebakk A., Johansen B. (2005). A vegetation-based method to map climatic variation in the arctic-boreal transition area of Finnmark, north-easternmost Norway. *Journal of Biogeography*, 32: 1161-1186.
- Karlsen, SR., Tømmervik H., Johansen B., Riseth, JÅ. (2017). Future forest distribution on Finnmarksvidda, North Norway. *Clim Res* <https://doi.org/10.3354/cr01459>
- Körner C., Paulsen J. (2004). A world-wide study of high-altitude treeline temperatures. *J Biogeogr* 31:713-732.
- Myking T. (1999). Winter dormancy release and budburst in *Betula pendula* Roth. and *B. pubescens* Ehrh. ecotypes. *Phyton* 39: 139-146.
- Myking T., Heide OM. (1995). Dormancy release and chilling requirements of buds of latitudinal ecotypes of *Betula pendula* and *B. pubescens*. *Tree Physiology* 15: 697-704.

- Müller-Wille L., Aikio MS., Luhta V. (2005). Manging the Nordic mountain birch ecosystem: Local communities and the state in Finland's forestry. In: Wielgolaski FE (ed) *Plant Ecology, Herbivory and Human Impact in Nordic Mountain Birch Forests*, pp 313-326. Springer: Ecological Studies 180.
- Neuvonen S., Niemelä P., Virtanen T. (1999). Climate change and insect outbreaks in boreal forests; the role of winter temperatures. *Ecol Bull* 47: 63-67.
- Nilsen J., Wielgolaski FE. (2001). Effects of fertilization and watering on morphology in young mountain birch plants of different provenances – a pilot study. In Wielgolaski FE (ed) *Nordic Mountain Birch Ecosystems*, pp 71-76. Man and Biosphere Series vol 27. UNESCO, Paris and Parthenon, NY.
- Ovaska JA., Nilsen J., Wielgolaski FE., Kauhanen H., Partanen R., Neuvonen S., Kapari L., Skre O., Laine K. (2005). Phenology and performance of mountain birch provenances in transplant gardens; Latitudinal, altitudinal and oceanity-continentiality gradients. In: Wielgolaski FE (ed) *Plant Ecology, Herbivory and Human Impact in Nordic Mountain Birch Forests*, p 99-115. Springer: Ecological Studies 180.
- Riseth, JÅ. (2007). An Indigenous Perspective on National Parks and Sámi Reindeer Management in Norway. *Geographical Research*, June 2007 45(2):177-185
- Riseth, JÅ., Tømmervik H., Helander-Renvall E., Labba N., Johansson C., Malnes E., Bjerke JW., Jonsson C., Pohjola V., Sarri L-E., Schanche A., Callaghan TV. (2011). Sámi traditional ecological knowledge as a guide to science: snow, ice and reindeer pasture facing climate change. *Polar Record*, 47: 202-217.
- Schanche, K., (2002). Varangersamenes sesongflyttinger. [The seasonal migrations of the Varanger Sami] In: G.J. Valen, K. Skavhaug, K. Schanche (eds.): *Flytting og forandring i Finnmarks fortid. Artikkelsamling fra museene i Finnmark.*, pp. 44-58.
- Skre O., Baxter R., Crawford RMM., Callaghan TV., Fedorkov A. (2002). How will the Tundra-Taiga interface respond to climate change? *Ambio Special Report 12*: 37-46.
- Skre O., Nilsen J., Næss M., Igeland B., Taulavuori K., Taulavuori E., Laine K. (2005). Effects of temperature changes on survival and growth in mountain birch populations. In Wielgolaski FE (ed) *Plant Ecology, Herbivory and Human Impact in Nordic Mountain Birch Forests*, p 87-98. Springer: Ecological Studies 180.
- Skre O., Wertz B., Wielgolaski FE., Szydłowska P., Karlsen SR. (2017). Bioclimatic effects on different mountain birch populations in Fennoscandia. *Clim Res* <https://doi.org/10.3354/cr01457>.
- Slettjord, S. (1993). Development of an environmental forest and arboretum at the outer coast of Finnmark County, Norway. In: Alden, J., Mastrantonio, J.L. and Ødum, S. (eds.): *Forest development in cold climates*, pp. 437-452. Plenum Press, N.Y. – London.
- Thorsson AT., Salmela E., Anamthawat-Jonsson K. (2001). Morphological, cytogenetic and molecular evidence for introgressive hybridization in birch. *J Hered* 92 404-408.
- Tømmervik H., Johansen B., Tombre I., Thannheiser D., Høgda KA., Gaare E., Wielgolaski FE. (2004). Vegetation changes in the Nordic mountain birch forests; the influence of grazing and climate change. *Arctic Antarctic Alpine Res* 36: 323-332.
- Tømmervik H., Wielgolaski FE., Neuvonen S., Solberg B., Høgda KA. (2005). Biomass and production on a landscape level in the mountain birch forests. In: Wielgolaski FE. (ed) *Plant Ecology, Herbivory and Human Impact in Nordic Mountain Birch Forests*, p 165-182. Springer: Ecological Studies 180.
- Vitasse Y., Lenz A., Körner C. (2014). The interaction between freezing tolerance and phenology in temperate, deciduous trees. *Frontiers in Plant Science* 5

## SHEAR STRENGTH OF THE SELECTED COAL MINING WASTES

Andrzej GRUCHOT<sup>1\*</sup>, Eugeniusz ZAWISZA<sup>1</sup>, Gabriela CISEK<sup>2</sup>, Tymoteusz ZYDRON<sup>1</sup>

<sup>1</sup>Department of Hydraulic Engineering and Geotechnics, University of Agriculture in Kraków, Poland

<sup>2</sup>Graduate of Department of Soil Mechanics and Earth Structures, University of Agriculture in Kraków, Poland

\*Corresponding author: rmgrucho@cyf-kr.edu.pl

### Abstract

The tests aimed at the determination of the influence of granulation, compaction and the shear rate on the shear strength parameters, which is the angle of internal friction and cohesion of the unburnt coal mining waste from the mine "Anna" from Upper Silesia (Poland) with grain sizes less than 10 and 40 mm. The tests were conducted in a standard (sample size 12×12×7.5 cm) and a medium size (sample size 30×30×13.6 cm) direct shear apparatus respectively for finer and coarser material. The shear rate was 0.1 and 1.0 mm·min<sup>-1</sup>, and the maximum value of the shear stress in the range of relative deformations up to 10% was assumed to be the shear criterion. The test samples were formed at the optimum moisture content to achieve a degree of compaction  $I_s = 0.90$  and 1.00. According to the geotechnical nomenclature, the examined waste was classified as multi-fractional medium sand gravels ( $d < 40$  mm) or fine sand gravels ( $d < 10$  mm). The carried out research revealed a significant effect of granulation on the values of the shear strength of the coal mining waste – as the grain thickness increased, the angle of internal friction decreased and cohesion increased. There was a similar effect of compaction and shear rate on the shear strength parameters for both grain sizes of the examined waste. The increase in compaction caused an increase in the angle of internal friction and cohesion, and the increase in shear rate resulted in a slight increase in the angle of internal friction and a noticeable reduction in cohesion.

**Key words:** *Coal mining wastes, Earth structures, Angle of internal friction, Cohesion.*

### Introduction

The use of industrial waste for earth structures, in particular for road construction, has become of major importance in recent years. This is due to, among others, the shortage of masses of soil used for the construction of motorways, expressways, city bypasses and other investments. In addition, industrial waste is cheap and can compete effectively with mineral raw soil materials.

Coal mining waste used in the broadly understood earth structures is mainly produced in the mining industry (gangue in the case of hard coal mining) but also in mineral processing (mineral waste) (Gruchot, 2016; Skarzyńska, 1997). Utilization of the waste for road construction requires assessment of their usability, which is based mainly on their geotechnical properties, and in particular the parameters of shear strength (angle of internal friction and cohesion). The values of these parameters influence the stability of the embankments or the bearing capacity of the subsoil. It is therefore important to define them correctly by applying the appropriate test method (test apparatus) to the planned working conditions after incorporating the waste into the structure.

For the purposes of engineering practice, direct shear apparatus is used to determine the angle of internal friction and cohesion of coarse-grained soils, such as the coal mining waste (Gruchot, 2016; Zadroga, 1994). The general principle of the test consists in measuring the

limit of soil resistance at a known normal load, and the sample shearing occurs in the plane or zone forced by the construction of the apparatus. In the case of the coarse-grained materials, there is a problem of selection of the grain size to the dimensions of the sheared sample. According to Pisarczyk (2004) the width of the apparatus box should be at least 4 to 6 times greater than the maximum diameter of the sheared material grains. That is why it is recommended to use the medium-sized apparatus where the research can be done on a material with a particle size similar to the natural.

The study aimed at the determination of the effect of granulation, compaction and shear rate on the shear strength parameters of the selected coal mining waste. For the research, there was used unburnt coal mining waste from the Coal Mine "Anna" in the Upper Silesian Coal Basin in southern Poland, with natural granulation as well as the granulation less than 40 and 10 mm.

### **Tests methods**

Basic physical properties and compactibility parameters of the tested coal mining waste were determined by standard methods. Granulometric composition was determined by sieve method for particles coarser than 0.063 mm and areometric method for finer particles, and the density of solid particles by means of a volumetric flask in distilled water. Optimum moisture content and maximum dry density of solid particles were determined in a Proctor's apparatus in a cylinder with a volume of 9.8 and 2.2 dm<sup>3</sup> for the waste with a grain size finer than 40 and 10 mm respectively, at the compaction energy 0.59 J·cm<sup>-3</sup>.

Determination of the shear strength parameters of the material with grains finer than 40 mm was performed in a medium-sized direct shear apparatus for samples of the cross-section dimensions 30×30 cm and the height of 13,6 cm. Whereas, the tests of the material of the granulation finer than 10 mm were conducted in a standard direct shear apparatus for samples of the cross-section dimensions 12×12 cm and the height of 7,5 cm (Cisek, 2004). Intermediate frames were used to limit the impact of interlocking the grains on the cohesion values in both pieces of apparatus, which led to obtaining a 3.0 cm thick (6 intermediate frames) and 1.0 cm thick (5 intermediate frames) shear zone, in the standard and medium-sized shear apparatus, respectively. It was assumed, that the thickness of the shear zone should be equal or close to the maximum diameter of the tested material grain. The samples were formed directly in the box of the apparatus, at the moisture content close to the optimum one, until the degree of compaction  $I_s = 0.90$  and 1.00. Consolidation and shearing of the samples were performed at normal stresses of 50, 100 or 110, 200, 300, 400, 600 kPa. The shear rate was 0.1 and 1.0 mm·min<sup>-1</sup>, and the maximum value of the shear stress in the range of relative deformations up to 10% was taken as a shear criterion.

### **Results and discussion**

#### **Petrographic composition**

The petrographic composition of the investigated coal waste was dominated by claystone, which accounted for 82%, mudstone interlayers being adjacent to claystone were 14%. The content of the carbon shale together with the coal chips was low and amounted to 3%. Sandstone chips were also present in the tested material in an amount of 2% (Fig. 1).

#### **Physical properties**

In the coal mining waste with the natural granulometric composition, the gravel was the dominating fraction that amounted to 68%, sand fraction was 16%, cobbles 8%, and silt and clay fraction – almost 8%. In the material with the granulation finer than 40 or 10 mm, the gravel fraction also dominated, and amounted to 71 and 58%, respectively, the sand fraction,

was 28 and 20%. Whereas the content of the finest fractions, i.e. silt and clay was 9% in the material of the granulation finer than 40 mm and over 14% in the material of the granulation finer than 10 mm (Fig 2). According to the geotechnical nomenclature (PN-EN ISO 14688-2:2006), the tested waste of the natural granulation was classified as multi-fractional medium gravel with a small content of cobbles, and sandy medium gravel ( $d < 40$  mm) or sandy fine gravel ( $d < 10$  mm) (Tab. 1).

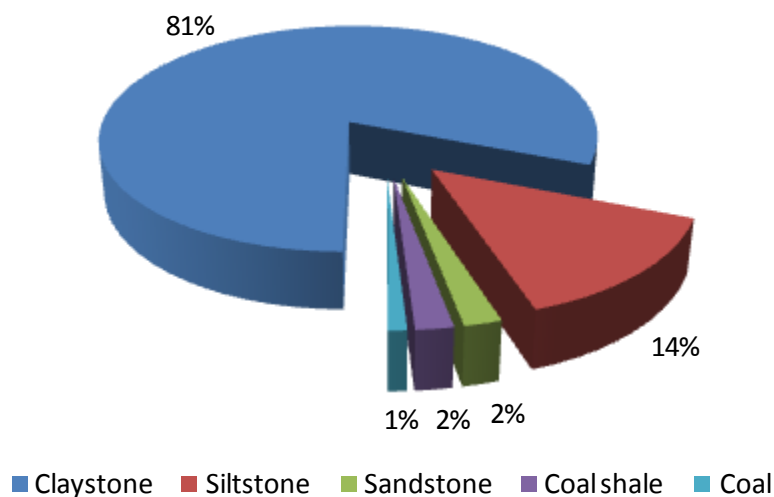


Fig. 1. Petrographic composition of the tested material

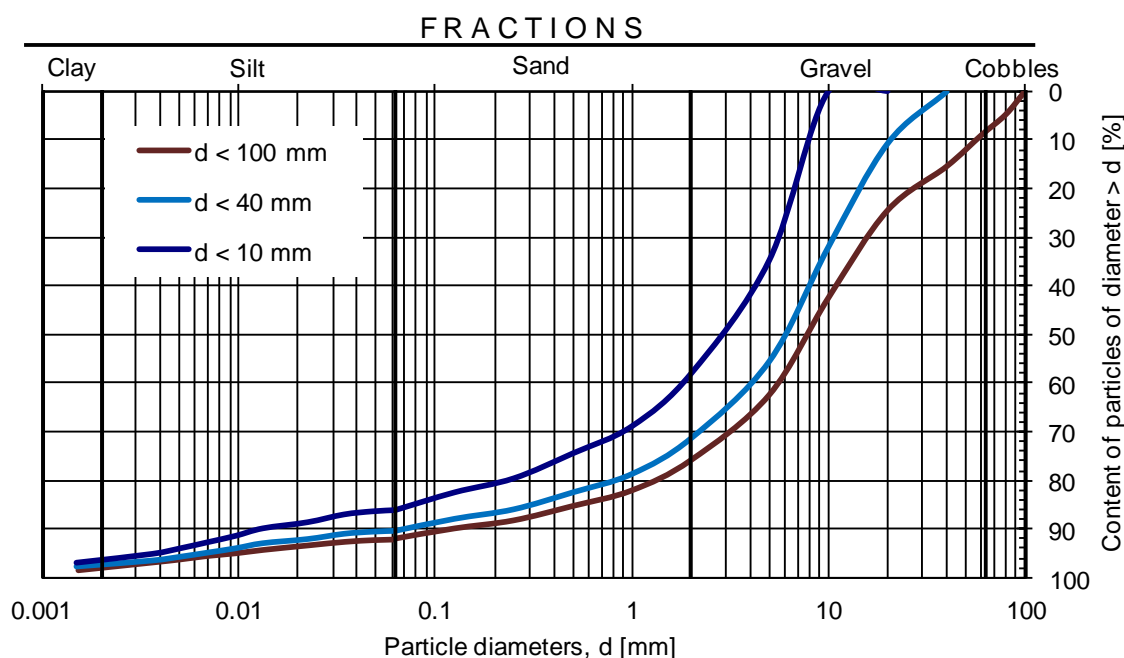


Fig. 2. Grain size distribution curves of the tested coal mining waste

Density of solid particles of the coal mining waste was equal  $2.39 \text{ g}\cdot\text{cm}^{-3}$ . Maximum dry density of solid particles of the waste finer than 10 mm was  $1.76 \text{ g}\cdot\text{cm}^{-3}$  and increased up to  $1.86 \text{ g}\cdot\text{cm}^{-3}$  with increasing thickness of the grain size up to 40 mm, at the moisture content decreasing with the increase of the grain size and amounting to 12 and 8.5%, respectively.



Table 1. Geotechnical characteristics of the tested coal mining waste

Parameter	Grain size distribution		
	d < 100 mm	d < 40 mm	d < 10 mm
Fraction content (%):			
- cobbles, Co (> 63 mm),	8.1	0.0	0.0
- gravel, Gr (2–63 mm),	67.9	70.7	58.0
- sand, Sa (0.063–2 mm),	16.2	20.3	27.5
- silt, Si (0.002–0.063 mm),	5.3	6.0	10.3
- clay, Cl (< 0.002 mm).	2.5	3.0	4.2
Uniformity coefficient [–]	85.7	106.7	300.0
Coefficient of curvature [–]	6.1	8.8	13.8
Content of grains greater than 10 mm [%]	42	32	–
Soil name according to (PN-EN ISO 14688-2:2006)	medium gravel with a small content of cobbles (coMGr)	sandy medium gravel (saMGr)	sandy fine gravel (saFGr)
Density of solid particles [ $\text{g}\cdot\text{cm}^{-3}$ ]	2.39		
Optimum moisture content [%]	–	8.50	11.95
Maximum dry density of solid particles [ $\text{g}\cdot\text{cm}^{-3}$ ]	–	1.855	1.76

### Shear strength parameters

The obtained values of the angle of internal friction were high and ranged from 33 to 40° and cohesion ranged from 22 to 39 kPa for the coarser waste (d < 40 mm). For the finer waste (d < 10 mm) the same parameters values ranged respectively from 37 to 41° and from 15 to 38 kPa (tab. 2). There was a clear effect of compaction and grading on the values of the angle of internal friction and cohesion at both shear rates.

The increase of the value of the angle of internal friction together with the increase of the compaction from  $I_s = 0.90$  to 1.00 for the waste of the granulation finer than 40 mm was by 2 and 4° (by 5 and 12% relatively), and for the waste of the granulation finer than 10 mm was smaller and was by 1 and 2° (2.5 and 5% relatively) (Fig. 3a). The smaller values from the given increment range were obtained at the higher shear rate, i.e.  $1.0 \text{ mm}\cdot\text{min}^{-1}$ . The increase of the shear rate from 0.1 to  $1.0 \text{ mm}\cdot\text{min}^{-1}$  resulted in an increase in the angle of internal friction by 5 and more than 2° for the coarser waste, and by about 2 and 1.5° for the finer waste, with larger increment of these parameters occurring at smaller compaction ( $I_s = 0.90$ ).

The increase in the compaction resulted also in the increase in the cohesion of the tested coal waste. For the waste of the granulation finer than 40 mm, the increase amounted to by about 7 and 13 kPa (by 20 and 58 % relatively), and for the waste of the granulation finer than 10 mm – by 14 and 9 kPa respectively at the shear rate 0.1 i  $1.0 \text{ mm}\cdot\text{min}^{-1}$  (Fig. 3b). The increase in the shear rate caused the decrease in cohesion by 5 and 11 kPa for the coarser waste and by 9 and 15 kPa for the finer waste, at the compaction  $I_s = 0.90$  and 1.00 respectively.

An analysis of the impact of the grain size revealed that the highest values of the angle of internal friction were obtained for the waste of the granulation finer than 10 mm, and they were higher by 4 and 2°, at the shear rate  $0.1 \text{ mm}\cdot\text{min}^{-1}$  and by 2 and 1°, at the shear rate  $1.0 \text{ mm}\cdot\text{min}^{-1}$  in relation to the coarser waste (Fig. 3a) at the compaction  $I_s = 0.90$  and 1.00 relatively.

The highest values of the cohesion were obtained for the coarser waste. The increase in the grain size of the tested materials caused the decrease in cohesion by 8 and 1 kPa at the shear

rate  $0.1 \text{ mm}\cdot\text{min}^{-1}$ , and by 6 and 11 kPa at the shear rate  $1.0 \text{ mm}\cdot\text{min}^{-1}$ , at the degree of compaction  $I_s = 0.90$  and  $1.00$  respectively.

Hence, it can be concluded that the increase in the compaction were followed by the decrease in differences between the values of the shear strength parameters of the waste of different granulation.

Table 2. Values of angle the of internal friction ( $\phi$ ) and cohesion (c) of the selected coal mining wastes

Shear rate	Degree of compaction	Grain size distribution			
		d < 40 mm		d < 10 mm	
$v_s$ [ $\text{mm}\cdot\text{min}^{-1}$ ]	$I_s$ [-]	$\phi_{40}$ [°]	$c_{40}$ [kPa]	$\phi_{10}$ [°]	$c_{10}$ [kPa]
0.1	0.90	33.4	32.3	37.4	24.1
	0.95	36.1	34.9	38.5	32.8
	1.00	37.4	38.8	39.2	37.9
1.0	0.90	38.0	21.6	39.6	15.1
	0.95	39.3	29.9	40.0	18.3
	1.00	39.8	34.1	40.6	24.0

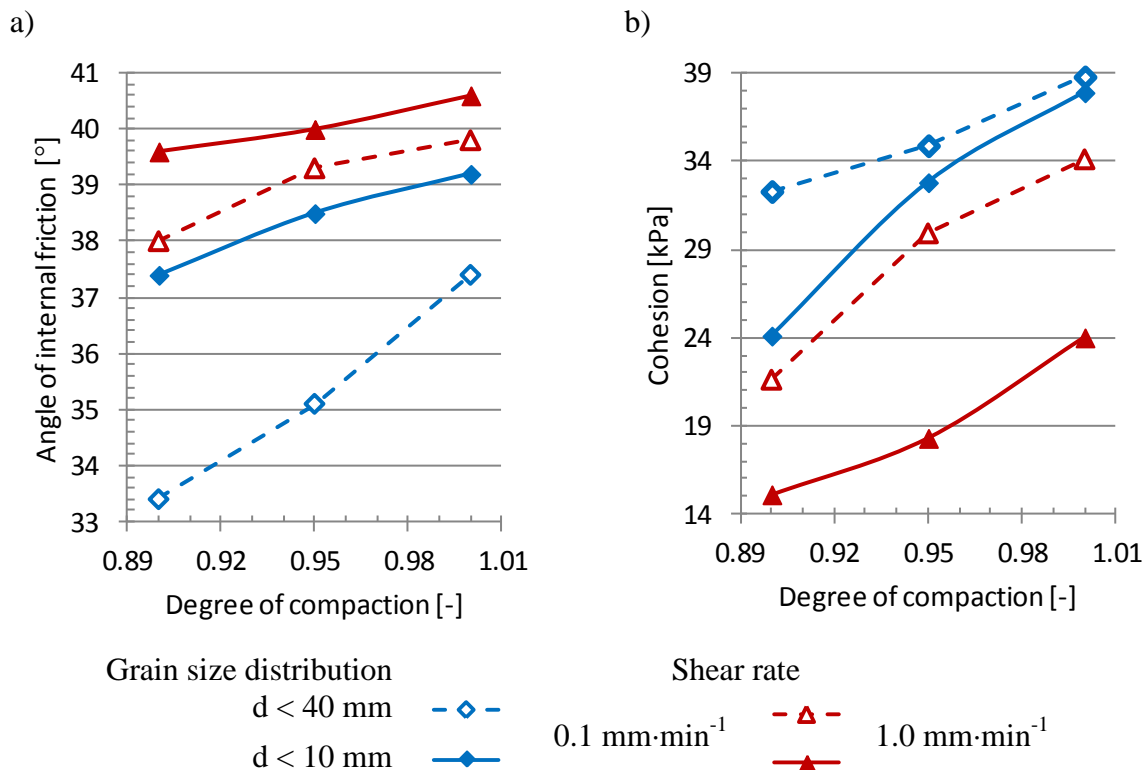


Fig. 3. Influence of compaction on the angle of internal friction (a) and cohesion (b)

### Conclusion

The conducted research showed the impact of the granulation on the angle of internal friction and cohesion of the coal mining waste from the coal mine "Anna". The effect of compaction and shear rate on the shear strength parameters for both tested ranges of the waste granulation was also found. The increase in compaction caused the increase in the angle of internal friction and cohesion, and the increase in the shear rate resulted in the slight increase in the angle of internal friction and the significant reduction in cohesion.

It should be noted that the coal mining waste is characterized by geotechnical properties, which largely depend on their petrographic composition and grain size distribution as well as the time of their storage. Sifting thicker fractions can cause significant changes in petrographic and granulometric composition. Therefore, it is recommended to carry out tests in medium-sized apparatus, on the material with the granulation close to the natural one.

### **References**

- Cisek G. (2004). Badania wytrzymałości na ścinanie odpadów powęglowych, wpływ zastosowanej aparatury. Praca magisterska. Akademia Rolnicza w Krakowie, Zakład Mechaniki Gruntów i Budownictwa Ziarnego, maszynopis. [Cisek G. (2004). Shear strength tests of the coal mining wastes, impact of applied apparatus. Master's thesis. Agricultural University in Krakow, Department of Soil Mechanics and Earth Structures, typescript.]
- Gruchot A. (2016). Utylizacja odpadów powęglowych i poenergetycznych do celów inżynierskich jako czynnik kształtowania i ochrony środowiska. Zeszyty Naukowe Uniwersytetu Rolniczego w Krakowie, Rozprawy, 410. [Gruchot A. (2016). Utilisation of coal mining wastes and fuel ashes for engineering purposes as a factor of environmental development and protection. Scientific Journal of University of Agriculture in Krakow, Dissertations, 410.]
- Pisarczyk S. (2004). Grunty nasypowe. Właściwości geotechniczne i metody ich badania. Oficyna Wydawnicza Politechniki Warszawskiej, Warszawa, ss. 238. [Pisarczyk S. (2004). Made soils. Geotechnical properties and methods of their investigation. Printing House of Warsaw University of Technology, Warsaw, pp. 238.]
- PN-EN ISO 14688-2:2006. Badania geotechniczne. Oznaczanie i klasyfikowanie gruntów. Część 2: Zasady klasyfikowania. Polski Komitet Normalizacyjny, Warszawa. [PN-EN ISO 14688-2:2006. Geotechnical surveys. Determination and classification of ground. Part 2. Classification rules. Polish Committee for Standardization, Warsaw.]
- Skarżyńska K.M. (1997). Odpady powęglowe i ich zastosowanie w inżynierii lądowej i wodnej. Wydawnictwo Akademii Rolniczej w Krakowie. [Skarżyńska K.M. (1997). Colliery spoils and their application in civil engineering. Printing House of Agricultural University in Kraków.]
- Zadroga B. (1994). Metody określania właściwości mechanicznych odpadów. Inżynieria Morska i Geotechnika, 3, 127–132. [Zadroga B. (1994). Determination of mechanical properties of waste materials. Marine Engineering and Geotechnics, 3, 127–132.]

## **NATURAL EVALUATION OF RURAL NASIELSK COMMUNE AREA FOR LANDSCAPE MANAGEMENT IN TOURISTIC ASPECT (POLAND)**

Beata FORNAL-PIENIAK

Warsaw University of Life Sciences, Faculty of Horticulture, Biotechnology and Landscape Architecture  
Department of Environmental Protection, Nowoursynowska 166, 02-787 Warsaw, Poland

\*Corresponding author: beata\_fornal\_pieniak@sggw.pl

### **Abstract**

Natural values are the main potential aspects for development of rural communities. It was presented natural evaluation method focused on classification values of landscape. The whole stages of natural evaluation depend on the main purpose of research. The main question is: it will be doing for example for tourism or protection aspects? Proper selected criteria of natural evaluation are first success of this method. The purpose of this paper was to classify natural values of Nasielsk commune and to formulate directions for protection and touristic aspects. Nasielsk commune is located in the north-east part of Poland. It was recognized natural elements and prepared selected criteria of evaluation as diversity of plant communities, naturalness of vegetation, protected forms, water surface, Natura 2000 habitats, vegetation available for recreation. Natural evaluation included division of study area into landscape special units, formulated criteria to assessment, scale of values. Scale of values was characterized by points from 1 to 5 points. Areas with different natural values were distinguished. Areas were classified into three groups: areas with high natural values, areas with medium natural values and areas with low natural values. The last stage of work was formulating directions for protection and tourism on studied area.

**Keywords:** *Evaluation, Rural areas, Landscape management.*

### **Introduction**

Natural evaluation is very important and usefulness method for characteristic of biotic and abiotic values of landscape elements (Mazurski, 2012, Myga-Piątek 2007, Żarska 2011, Żarska et.al. 2014). There were presented many evaluation methods focused on quality of landscape elements as LANDEP method (Landscape Ecological Planning), GEM (*General Ecological Model*). The whole stages of natural evaluation depend of the main purpose of research. Is it will be doing for tourism or protection aspects? Natural evaluation is most often done with the addition of bonitation assessment, which takes into account the different characteristics of the environment. So far, no universal method has been developed for natural evaluation. The most appropriate way is to mix and modify the various methods to adjust the evaluation criteria to the area being analyzed. The basic problem of preparing natural evaluation is the selection of the proper basic field. For the implementation of the evaluation of the landscape, the division of the examined area into the "basic assessment" fields is used. Using the term "basic field" we mean a unit of space, which can be uniquely attributed to a certain value obtained in the evaluation of the environment (Bajerowski 2007). There are three basic criteria for determining the shape and size of the basic fields: separation of units corresponding to administrative fields, artificial separation of homogeneous geometric fields, the unmistakable advantages of which are equal surfaces, which makes them comparable. Often within the boundaries of one field there are areas of varied nature, the separation of natural units - geocomplexes, which are homogeneous internally and characterized by

uniform features and values of the landscape, but they have uneven surfaces (Balloon 2007). The next step is to formulate proper criteria of natural evaluation for example for landscape management. The main purpose of this article is natural evaluation for tourism aspect on example of Nasielsk commune in Poland.

### Material and Methods

Nasielsk commune is located on central part of Poland covering an area of 205,77 square kilometers. It is a typical agricultural commune with mosaic parts where natural plant communities are growing. Forests are represented by few communities as: *Peucedano-Pinetum* on upper sandy habitats, *Tilio-Carpinetum* on fresh soils and *Frago-Alnetum* along the river valleys. It was observed here many local depressions where wet meadows (*Molinion*) are occurred. Water and rushes plants are strictly connected with the rivers and local small natural ponds. It was also recognized fresh meadows and pastures. Synatropical plants (*Artemisetea vulgaris*) are growing mostly on fields and settlements.

Methodology is included fields and indoor studies. It was recognized natural elements and prepared selected criteria of evaluation as diversity of plant communities, naturness of vegetation, protected forms, water surface, Natura 2000 habitats, vegetation available for recreation.

Natural evaluation was included division of study area into landscape special units, formulated criteria to assessment, scale of values. Scale of values was characterized by points from 1 to 5 points.

#### Bonitation points:

5 point – very high values/occurring

3 - 4 points – high values/occurring

2 points – medium value/occurring

1 point – low value/occurring

The last stage of analysis was distinguished areas with different natural values. Areas was classified into three groups: areas with high natural values (10 and above 10 points), areas with medium natural values (from 5 to 9 points), areas with low natural values (from 1 to 4 points).

### Results and discussion

Different types of special-landscape units were distinguished in Nasielsk commune. They are represented by forests (59 units), river valleys (2 units), settlements (14 units) and agriculture units with mosaic of fields, pastures and meadows (29 units).

Forest unities are represented by coniferous community (*Peucedano-Pinetum*) and deciduous community (*Tilio-Carpinetum*).

River valley unities – are characterised by riparian forests, rushes and water plants and wet meadows (*Molinetalia*).

Settlement units – are included villages and small towns with accomanio vegetation (gardens, orchards, allotments).

Agriculture unities – have mosaic structure with fields, fresh meadows and pastures.

The most valuable special-landscape units are represented by river valleys, forests and one agriculture unit (A23) with share of groups of trees and small agriculture ponds with water and rushes vegetation. Riparian forests, water and rushes plant communities are dominated in river valleys. These units are the most valuable in studied area. Only one protected form as ecological ground is located on the south part of Nasielsk commune (A23).



Fig. 1. Division of study area into spatial-landscape units (Fornal-Pieniak, 2017)

Table.1. Natural evaluation of Nasielsk commune (Fornal-Pieniak, 2017)

Criteria	F1-F59	F45	A1-A29	A23	S3-S14	S1	S2	RV1-RV2
Diversity of plant communities	2	2	3	3	2	2	1	5
Naturness of vegetation	5	5	3	3	1	2	2	5
Protected forms *	0	0	0	1	0	0	0	0
Water surface	0	0	0	2	0	0	0	4
Natura 2000 habitats*	0	1	0	0	0	0	0	0
Vegetation available for recreation	3	3	2	2	2	1	2	4
<b>Sum</b>	<b>10/I</b>	<b>11/I</b>	<b>8/II</b>	<b>11/I</b>	<b>5/II</b>	<b>5/I</b>	<b>5/I</b>	<b>18/I</b>

\*1 point/if occurring, 0 point if no occurring

F – forests special-landscape units

A – agriculture special – landscape units with share of fields, pastures and meadows

S – settlement units

RV – river valley units

**Areas with different values and availability for touristic aspect:**

I – areas with high natural values for protection and tourism aspects(10 and more points) – 62 special-landscape units

II- areas with medium natural values for protection and tourism aspects (from 5 to 9 points) – 43 special landscape units

III–areas with low natural values for protection and tourism aspects (from 1 to 4 points) – non It is observed landscape fragmentation and human pressure on natural elements in Polish rural areas (Orłowski and Nowak 2007). Agricultural communes as Nasielsk are dominated in Poland. That's why proper management is demanded for keeping existing natural values. It is a priority in political strategy of commune how to shaping the landscape for touristic of protection aspects. Evaluation is very easy and usefulness method which help to classified landscape values (Żarska et al. 2014). Natural vegetation is the most valuable element in ecological corridors because of high biodiversity of plant species (Żarska et al. 2014). Polish river valleys are not meliorated yet and characterised by rare vegetations as riparian forests, water and rushes vegetation (Żarsak B. et al. 2014). Moreover old forests do not take a large areas too so small group of plantings and small forests should be keeping in good condition in rural landscapes (Liro and Szacki 1993, Shields et al. 2000). These whole presented reasons describe the purpose of natural evaluation on rural areas

### **Conclusions**

- 1.Natural evaluation is very useful and important stage of landscape analysis for proper management, for example for touristic and protection aspects of Nasielsk commune.
2. It was achieved 52 special landscape units with high natural values and 43 special landscape units with medium values. It was no areas with low landscape values.
3. The preparation of the evaluation of the area for tourism and recreation is an indispensable process indicating the potential of the municipality's tourism.
4. It is important to emphasize the importance of drawing up such studies by local governments interested in the development of tourism in their region.

### **References**

- Balon J., 2007. Unifikacja typów geokompleksów w skali kraju podstawą waloryzacji krajobrazu. [w] Waloryzacja środowiska przyrodniczego w planowaniu przestrzennym. Red. Kistowski M. i Korwel-Lejkowska B. Wyd. Uniwersytet Gdański, Gdańska - Warszawa, s.25-33
- Liro A. Szacki J. (1993). Korytarz ekologiczny – przykład problematyki. Człowiek i środowisko vol.17 (4), pp. 299-312
- Mazurski K. (2012). The Concept of Landscape and Its Evaluation. Kraków: Proksenia.
- Myga-Piątek U. (2007). “Culture Landscape as Value and Turistic Poroduct—Problem of Evaluation and Protection.” Culture Landscape—Quality, Values, Protection, Problems of Landscape Ecology XVIII: 201-212.
- Orłowski G. Nowak L. (2007). The importance of marginal habitat for the conservation of old trees in agricultural landscape. In Landsc. Urban Plan. no. 79, pp. 77-83.
- Shields D. F., Simon A. J., Steffen J. L. (2000). Reservoir effects on downstream river channel migration. Env. Con. vol.1 (27), pp.54-66.
- Żarska B., Fornal-Pieniak B., Zaraś-Januszkiewicz E. (2014). Landscape protection and planning. Selected issues. Wyd. SGGW.
- Żarska, B. (2011). Ochrona krajobrazu. Warsaw: SGGW, pp.254

## **SPECIES RESTITUTION – A WAY TO IMPROVE FLORISTIC DIVERSITY OF MEADOW COMMUNITIES IN „SKARPA URSYNOWSKA” NATURE RESERVE (POLAND)**

Maria JANICKA<sup>1\*</sup>, Bogumiła PAWLUŚKIEWICZ<sup>2</sup>

<sup>1</sup>Department of Agronomy, Warsaw University of Life Sciences – SGGW, Poland

<sup>2</sup>Department of Environmental Improvement, Warsaw University of Life Sciences – SGGW, Poland

\*Corresponding author: maria\_janicka@sggw.pl

### **Abstract**

The landscape reserve „Skarpa Ursynowska” is one of the 12 nature reserves situated in Warsaw (Poland). It was created in 1996 to protect piece of the high Vistula escarpment along with meadows and peat bogs of high natural values, which are located at the foot of Vistula escarpment. Cessation of management (from 1998 year) and the neglected, non-functioning drainage system for many years, as well as the storm canal banks covered with the concrete, have contributed to changes in habitat conditions and in botanical composition of post-marsh meadow communities. Floristic impoverishment of meadow communities, development of herbaceous (mainly willow) communities and invasive, arable land weeds and ruderal plants were demonstrated. These communities were characterized by small natural values, which reduced the aesthetic and landscape value of the reserve. The inadequate protection status of the meadow communities of the “Skarpa Ursynowska” reserve obliges to take action to stop the above mentioned processes and to restore the multi-species meadow communities. For this purpose, seedlings of wild flowers, dicotyledonous plant species (grown in laboratory conditions from seeds obtained from natural sites) were planted. The studies were carried out during 2015–2016. The growth and development of plants, the condition and range of the populations and the threats of 22 plant species were determined. It was found that most populations of species from drier habitats survived and unsuccessful were especially species with higher water requirements. On that basis, further protective measures were established.

**Keywords:** *Restitution of meadow species, wild flowers, post-marsh meadow, „Skarpa Ursynowska” nature reserve, Poland.*

### **Introduction**

The flora of the meadows and pastures is one of the most endangered elements of the vegetation. The impoverishment of the floristic diversity is being observed in the whole world, in various types of grassland communities (Pärtel *et al.*, 2005). The threat to the Polish flora, although lesser than in Western Europe, increases rapidly (Trąba *et al.*, 2006; Warda and Kozłowski, 2012; Kucharski, 2015). The community of floristic-rich “lowland hay meadows” *Arrhenatherion elatioris* (6510-1), for example, becomes more and more sparse. It is typical for the areas outside the rivers’ floods, on the eutrophic and mesotrophic habitats, not especially humid or dry. Thanks to colourfully flowering plants these meadows belong to the most decorative elements of the landscape (Kozłowski, 2002). The most important reasons of the decreasing in floristic diversity of the meadows are the habitats’ fragmentation and their degradation, caused mainly by the irrational human activity (Plantureux *et al.*, 2005; Winter *et al.*, 2008). More than 1/3 of the threatened species in Poland dies because of too small ranges of the local plant populations (Falińska, 2004). The excessive drying of the habitats, especially on the organic soils, influences the intensification of the decomposition



process, the mineralisation of organic substance and the decreasing in physicoaquatic properties of the soils (Kozłowska, 2005). These changes are progressed due the abandonment of management, what causes negative changes in the species composition of the meadow communities (Zarzycki and Misztal, 2010; Sienkiewicz-Paderewska *et al.*, 2012; Janicka *et al.*, 2016). It is being evaluated that the half of grassland in Poland is neglected or degraded, and the part – excluded from use. The improvement of the floristic diversity of the meadows' communities requires the active protection and the restoration of the flora. The choice of the method depends on the species, the restoration area and financial possibilities (Hedberg and Kotowski, 2010; Scotton *et al.*, 2012). The seedlings' production and planting is the best method of the rare and threatened species' introduction, which dispersal is limited, and the species of low light, nutrients and water-competition, what effects the low survivability of the seedlings and young plants in the presence of primary sward (Walker *et al.*, 2004; Wallin *et al.*, 2009). The aim of the studies was the evaluation of the possibilities of increasing in meadow communities' floristic diversity as the result of species introduction to the impoverished meadow-patches dominated by *Arrhenatherum elatius* in the landscape reserve “Skarpa Ursynowska” and the restoration of its environmental values, basically the landscape and aesthetical functions.

### Material and methods

**The study area.** The landscape reserve “Ursynowska Slope” is one of the twelve natural reserves in Warsaw (Poland). It was established in 1996 to protect the part of the high Vistula Slope (the highness of the slope in the reserve area – 5-18 metres, gradient 24-60<sup>0</sup>) with the meadows and peatlands of high natural value at its background (20,8 ha, the insulation cover 155,35 ha) (The Edict, 1996; 2011). That area is the part of Warsaw Area of the Protected Landscape (The Edict, 2007). It is characterised by the presence of 126 taxa of the vascular plants, including *Dryopteris cristata*, the threatened species (Category V according to Zarzycki *et al.*, 2002) (Wysocki and Budzikowski, 1996; Grabowska, 2016). Amongst the mycobiota three species from The Red Book of Polish Plants and Fungi are being noticed (Snopek 2016). The reserve serves as the migration corridor, provides the nesting or breeding sites for the amphibians, birds and mammals. It is the refuge for the invertebrates with many rare species, including daylight butterflies, such as *Lycaena dispar*, *Polyommatus bellagrus* and *Cupido argiades* (Kozłowski and Sielezniew, 1996; Snopek, 2016).

The meadow site covers 12 quarters (10.7 ha). It was drained and managed in the years 1952-1953. In the seventies and eighties of XX century the intensive pasture-meadow management was carried out on that area. After the system transformation the management was limited to the one, summer cut. Since 1998 the meadow communities are not being mowed.

The water conditions are being shaped with constant groundwater inflow from under the slope and frequent surface runoff. As the result the low peats on the loose sands were developed (Pawłat *et al.*, 1996). On the majority of the meadow area the muck soils, subtype peaty-muck (30-40 centimetres of muck layer) with strongly decomposed peat (25-50 centimetres) are present. Below the sandy formations and locally gyttja occur. The soils in the root layer characterise themselves by very large amounts of phosphorus (more than 1050 mg P·kg<sup>-1</sup> d.m. of the soil), very small amounts of potassium (85-228 mg K·kg<sup>-1</sup> d.m. of the soil) and pH in the range from 5.5 to 6.8 (Janicka *et al.*, 2016). The groundwater level maintains during the vegetation period at 60-90 (120) cm.

The surveys were carried out in the years 2015-2016. The vegetation period in 2015 was unusually warm and dry, the Vinczeffy hydrothermic index was equal only to 0.091 mmC<sup>-1</sup>. The July, August and September were described as extremely dry (Vinczeffy, 1984). The winter period 2015/2016 characterised itself by low temperatures and the lack of snow

coverage. In 2016 the summer was not such hot as in 2015 and the hottest month was June. The water supply for the plants was generally good.

**The methods.** In the spring of 2015 (after the previous cutting of sward) twenty two native plant species were introduced to the *Arrhenatherion elatioris* community (Tab.1). The diaspores were collected on the meadows of PLH 140016 protection area near Mniszew (Kozienice county, Mazovian voivodeship) in 2014. The seedlings from the laboratory were planted in the northern part of the reserve (geographical coordinates 52°16' N; 21°05 E). The following parameters were being determined: (1) the plants' growth and development – once a month the heights were measured, in three points on the diagonal of the area covered by peculiar species and the developing phase was determined, (2) the community range (in cm<sup>2</sup>), (3) the community condition in the 5-points scale:

very poor condition, more than 80% of the plants wither or yellow,

poor condition, 50-80% of the plants wither or yellow,

average condition, 30-50% of the plants wither or yellow,

good condition, 5-30% of the plants wither or yellow,

very good condition, plants brightly green, traces of withering or yellowing.

The results were analysed statistically with use of the variance analyses (ANOVA) and the Tukey test with significance level 0.05.

Table 1. The characteristics of the plant species planted in the reserve “Ursynowska Slope”

	Species*	Family	Life form	Durability	Plant no.	Height (cm)
1	<i>Achillea millefolium</i> L.	<i>Asteraceae</i>	H	B	48	21.6
2	<i>Allium angulosum</i> L.	<i>Amaryllidaceae</i>	G	B	13	24.4
3	<i>Armeria maritima</i> (MILL.) WILLD.	<i>Plumbaginaceae</i>	H	B	33	5.6
4	<i>Artemisia campestris</i> L.	<i>Asteraceae</i>	C	B, S	17	12.3
5	<i>Centaurea stoebe</i> L.	<i>Asteraceae</i>	H	B, D	22	14.6
6	<i>Cnidium dubium</i> (SCHKUHR) THELL.	<i>Apiaceae</i>	H	B	1	25
7	<i>Dianthus deltoides</i> L.	<i>Caryophyllaceae</i>	C	B	14	10.8
8	<i>Eryngium planum</i> L.	<i>Apiaceae</i>	H	B	27	11.2
9	<i>Galium boreale</i> L.	<i>Rubiaceae</i>	H	B	17	44.8
10	<i>Hypericum perforatum</i> L.	<i>Hypericaceae</i>	H	B	25	14
11	<i>Inula britannica</i> L.	<i>Asteraceae</i>	H	B	7	2.7
12	<i>Lysimachia vulgaris</i> L.	<i>Primulaceae</i>	H	B	48	17.7
13	<i>Lythrum salicaria</i> L.	<i>Lythraceae</i>	H	B	9	49
14	<i>Plantago lanceolata</i> L.	<i>Plantaginaceae</i>	H	B	17	22.9
15	<i>Potentilla erecta</i> (L.) RAEUSCH.	<i>Rosaceae</i>	H	B	42	7.9
16	<i>Rumex acetosa</i> L.	<i>Polygonaceae</i>	H	B	9	14.9
17	<i>Sanguisorba officinalis</i> L.	<i>Rosaceae</i>	H	B	1	22.2
18	<i>Scabiosa ochroleuca</i> L.	<i>Dipsacaceae</i>	H	B, D	22	14.1
19	<i>Thalictrum flavum</i> L.	<i>Ranunculaceae</i>	H	B	23	4.5
20	<i>Tragopogon pratensis</i> L.	<i>Asteraceae</i>	H	D	42	27.1
21	<i>Verbascum thapsus</i> L.	<i>Scrophulariaceae</i>	H	D	5	9
22	<i>Veronica longifolia</i> L.	<i>Plantaginaceae</i>	H	B	36	17.9

Life form: H – hemicryptophyte, G – geophyte, C – herbaceous chamaephyte,

Durability: B – perennial, D – biennial plant, S – subshrub

Historical-geographic group: Ap – apophytes, M – metaphytes

\*The nomenclature of the species according to Mirek *et al.* (2002).

## Results and Discussion

In the literature dedicated to the aim of the study the risk of meadows' disappearing in the "Ursynowska Slope" reserve due to secondary succession connected with the lack of regular use was considered many times (Wysocki and Budzikowski, 1996; Rutkowska *et al.*, 1999; Janicka, 2000; Janicka and Kwiecień, 2004; Grabowska, 2016). The environmental evaluation of the *Arrhenatherion elatioris* communities, carried out in the years 2013-2015, shown the significant dumbing down of the species composition of the meadow communities, the development of the *Filipendulo-Petasition* communities and the invasive, segetal and ruderal plants. These communities are characterized by low natural values, what is being denoted by the low values of Shannon-Wiener coefficient (0.34-0.95) and the natural valorisation index (1.8-2.1) (Janicka *et al.*, 2016). The significant share of *Urtica dioica*, dominating on 1/3 of non-forest communities' area, impacts the decreasing the aesthetic and landscape values of the reserve. Furthermore, that species indicates the mineralisation of the organic substrate and permanent drying and softening of the outer layer of the soil. The condition of the meadow communities in the reserve is the result of abandonment of management and neglected, non-functional for many years reclamation system and the covering with concrete the banks of the storm channel. The improper state of these communities protection obliges to perform the activities up to stop of the sward degradation processes. Twenty two species of wild flowers were introduced for that purpose.

The hierarchic data clustering for two estimated parameters (the range and conditions of the community) of the introduced species made possible to set apart two basic groups of different probability level (Fig.1). In the first one the fast developing and systematically increasing their ranges species, which may be used for the introduction to the reserve area, were placed. Four of them should be distinguished: *Achillea millefolium*, *Veronica longifolia*, *Dianthus deltoides* and *Inula britannica*. These species underwent the unfavourable weather conditions as well as the competition of the old sward vegetation. The ranges of their communities in the second year of the surveys were about 4-10 times larger than in the previous year (Tab.2). Additionally, four species (*Tragopogon pratensis*, *Verbascum thapsus*, *Centaurea stoebe* and *Plantago lanceolata*), which communities developed rapidly and were characterised by the widest ranges in the first year, but the next year, after forming the flower buds and setting up the seeds, died out or their ranges decreased significantly, were included to that group. The prime three of the mentioned species are biennial, well tolerated the droughts. They may develop successfully in the following years from the seeds of the soil seed bank. *Plantago lanceolata*, on the other hand, is the low, rosette species, shade-sensitive species. It was present in the reserve area in the former period, when the sward was partially grazed. Introducing that species, one has to remember about systematic sward cutting-off.

In the second, assigned with the use of data clustering method, group of the species the ones characterized by poor development after planting and quick coming out of the sward, were placed. The following four shown poor conditions in the short time after planting: *Armeria maritima*, *Lythrum salicaria*, *Sanguisorba officinalis* and *Thalictrum flavum* (Tab.2). The strong drying out of the habitat, long-lasting summer drought in 2015 or too strong competition of the primeval sward species could be the reasons of their elimination. The disappearance of *Armeria maritima* was the effect of serious harms of the leaves, caused by the birds. It is worth stressing that from the species mentioned above *Sanguisorba officinalis* and *Lythrum salicaria* were present before in the reserve area, but they cannot be recommended at present habitat conditions.

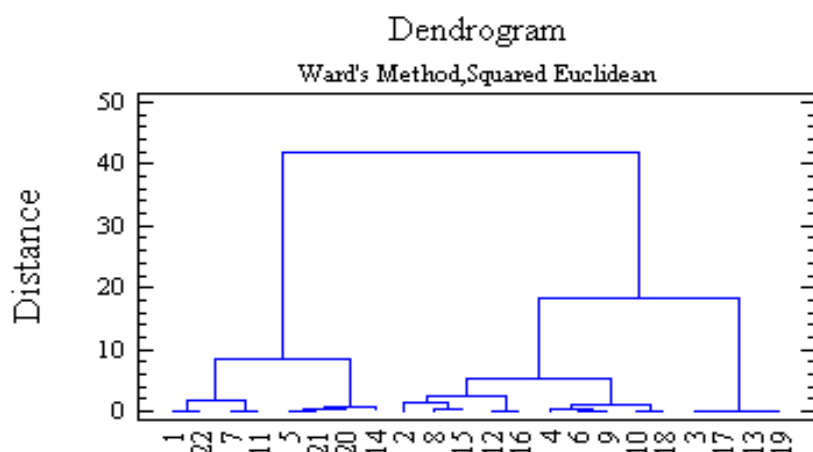


Fig. 1. The dendrogram and the groups of the species of similar range and community condition (the average from the study period). The numbers of the species are in accordance with the ones in the tables.

Table 2. The state of the populations of planted species during first two years of the vegetation (September 2015 and 2016)

No	Species	Height (cm)		Range (cm <sup>2</sup> )		Condition (scale 5 <sup>o</sup> )	
		2015	2016	2015	2016	2015	2016
1	<i>Achillea millefolium</i> L.	29.0	87.7	1085	4116	4.8	5.0
2	<i>Allium angulosum</i> L.	9.0	-	-	-	4.0	-
3	<i>Armeria maritima</i> (Mill.) Willd.	-	-	-	-	2.0	-
4	<i>Artemisia campestris</i> L.	18.3	*	485	192	4.0	3.1
5	<i>Centaurea stoebe</i> L.	26.3	62.0	2421	217	4.6	3.4
6	<i>Cnidium dubium</i> (Schkuhr) Thell.	6.3	47.0	-	-	4.0	4.2
7	<i>Dianthus deltoides</i> L.	16.5	32.0	637	3500	5.0	4.3
8	<i>Eryngium planum</i> L.	12.7	*	576	332	3.5	2.2
9	<i>Galium boreale</i> L.	8.0	43.0	-	-	3.5	4.7
10	<i>Hypericum perforatum</i> L.	19.0	60.7	-	387	4.4	5.0
11	<i>Inula britannica</i> L.	11.0	27.0	312	3249	5.0	4.5
12	<i>Lysimachia vulgaris</i> L.	15.7	34.5	-	1471	2.5	3.8
13	<i>Lythrum salicaria</i> L.	-	-	-	-	1.7	-
14	<i>Plantago lanceolata</i> L.	26.7	42.3	2050	276	4.9	4.7
15	<i>Potentilla erecta</i> (L.) Raeusch.	12.0	20.0	393	-	4.0	2.7
16	<i>Rumex acetosa</i> L.	18.0	34.0	1155	576	3.2	2.8
17	<i>Sanguisorba officinalis</i> L.	-	-	-	-	1.8	-
18	<i>Scabiosa ochroleuca</i> L.	16.7	79.7	360	447	4.5	4.4
19	<i>Thalictrum flavum</i> L.	8.0	-	-	-	1.7	-
20	<i>Tragopogon pratensis</i> L.	36.7	66.7	1543	614.0	4.4	3.5
21	<i>Verbascum thapsus</i> L.	27.5	*	2836	*	4.7	3.7
22	<i>Veronica longifolia</i> L.	27.3	76.7	708	4117	4.8	5.0
NIR <sub>0.05</sub>		8.7	20.4	1015	319	2.18	ns

- eliminated, \* shorter vegetation, \*\* destroyed by the animals

## Conclusions

The results of the study denote the efficiency of the species introduction (especially the ones of drier habitats) to the *Arrhenatherion elatioris* communities and improving their floristic diversity. The planted species will be monitored during next years. The stabilisation or increase in population size of the species, affirmed by multi-years observations, will be able to consider as the full success. The authors seem that the steps to the right direction, encouraging to the next tries of another plant species introduction, occurred before in the reserve or in similar meadow habitats of the same geobotanical region, were made. The detailed cognition of various plant species reactions in changed habitat conditions will allow for the working out the strategy of restoration the meadow communities of high species richness, and in consequence the improving of landscape and aesthetical functions of the reserve. To secure their long-lasting the regular management (twofold mowing) is recommended.

## References

- Falińska K. (2004). Ekologia roślin [Ecology of plants]. Wydawnictwo Naukowe PWN, Warszawa, 1-512 [In Polish].
- Grabowska E. (2016). Flora rezerwatu „Skarpa Ursynowska” pod wpływem antropopresji [The flora of “Skarpa Ursynowska” nature reserve influenced by human impact]. *Przegląd Przyrodniczy* XXVII, 2, 3-27 [In Polish with English summary].
- Hedberg P., Kotowski W. (2010). New nature by sowing? The current state of species introduction in grassland restoration, and the road ahead. *Journal for Nature Conservation* 18, 304-308.
- Janicka M., (2000). Changes in floristic composition of meadow sward under the influence of habitat conditions and neglecting in the management. *Proceedings of the International Symposium “Conventional and ecological grassland and management”*, Tartu, Estonia, 69-74.
- Janicka M., Kwiecień R. (2004). Zmiany składu gatunkowego runi łąkowej po pięciu latach od zaprzestania użytkowania [The changes in species composition of sward after desistance from meadow management for five years]. *Łąkarstwo w Polsce*, 7, 101-111 [In Polish with English summary].
- Janicka M., Pawluśkiewicz B., Dąbrowski P. (2016). Waloryzacja zbiorowisk łąkowych z udziałem *Arrhenatherum elatius* i *Bromus inermis* ukształtowanych w wyniku zaniechania użytkowania na terenie rezerwatu „Skarpa Ursynowska” [Natural and usefulness valorization of the meadow communities with the share of *Arrhenatherum elatius* and *Bromus inermis* formed as the result of managing abandonment in the “Skarpa Ursynowska” nature reserve]. *Polish Journal of Agronomy*, 27, 71-80 [In Polish with English summary].
- Kozłowska T. (2005). Zmiany zbiorowisk łąkowych na tle różnicowania się warunków siedliskowych w charakterystycznych obszarach dolin rzecznych Polski Centralnej [Change of meadow communities under differing habitat conditions in characteristic areas of river valleys of central Poland]. *Woda-Środowisko-Obszary Wiejskie. Rozpr. Nauk. i Mon.* 14., pp. 208 [In Polish with English summary].
- Kozłowski M.W., Sielezniew M. (1996). Wstępna inwentaryzacja motyli dziennych (Lepidoptera, Rhopalocera) Skarpy Ursynowskiej SGGW i terenów przyległych [The Ursynow Slope area butterflies (Lepidoptera, Rhopalocera) preliminary inventarisation]. *Sci. Rev. Eng. Env. Sci.* 9: 85-94 [In Polish with English summary].

- Kozłowski, S. (2002). Trawy w polskim krajobrazie [Grasses in the Polish landscape]. [In:] Polska księga traw, ed. L. Frey, W. Szafer Institute of Botany, PAS Press, Krakow, 301-322 [In Polish with English summary].
- Kucharski, L. (2015). Vegetation in abandoned meadows in central Poland: Pilsia valley. Case study. *Acta Sci. Pol. Agricultura*, 14(2), 37-47, [www.agricultura.acta.utp.edu.pl](http://www.agricultura.acta.utp.edu.pl).
- Mirek Z., Piękoś-Mirkowa H., Zajac A., Zajac M. (2002). Flowering plants and pteridophytes of Poland: a checklist. W. Szafer Institute of Botany, PAS Press, Krakow.
- Pawlat H., Wanke P., Wolski P. (1996). Warunki wodno-glebowe tarasu nadzalewowego Wisły w rejonie Skarpy Ursynowskiej [Water and soil conditions of up-terrace of Vistula River Valley in the Skarpa Ursynowska (Ursynow Slope) area]. *Rev. Eng. Env. Sci.* 9: 31-37 [In Polish with English summary].
- Pärtel, M., Bruun, H.H., Sammul, M. (2005). Biodiversity in temperate European grasslands: origin and conservation. *Grassland Sci. Eur.*, 10, 1-14.
- Plantureux S., Peeters A., McCracken D. (2005). Biodiversity in intensive grasslands: Effect of management, improvement and challenges. *Agronomy Research* 3(2), 153–164.
- Rutkowska B., Janicka M., Szymczak R., Ślusarek A. (1999). Wpływ warunków siedliskowych i zaniedbania pratotechniki na zmiany florystyczne runi łąkowej [The influence of habitat conditions and neglecting in the management on changes in the floristic composition of meadow sward]. *Folia Universitatis Agriculturae Stetinensis* 197, *Agricultura*, 75: 271-278 [In Polish with English summary].
- Scotton M., Kirmer A., Krautzer B. (red.) (2012). Practical handbook for seed harvest and ecological restoration of species-rich grasslands. CLEUP, Padova, Italy, 1-116.
- Sienkiewicz-Paderewska, D., Borawska-Jarmułowicz, B., Mastalerczuk, G., Chodkiewicz, A., Stypiński, P. (2012). Wpływ zaprzestania koszenia na roślinność łąki trzęślicowej (*Molinietum caeruleae*) [Effects of mowing cessation on *Molinietum caeruleae* meadow vegetation]. *Woda-Środowisko-Obszary Wiejskie*, 12(1), 167-179 [In Polish with English summary].
- Snopek A. (2016). Problemy funkcjonowania rezerwatu przyrody na kampusie akademickim: przykład rezerwatu Skarpa Ursynowska (Warszawa) i Foret de Dorigny (Ecublens, Szwajcaria) [The problems of nature reserve on academic campus: Skarpa Ursynowska (Warsaw, Poland) and Foret de Dorigny (Ecublens, Switzerland) case studies]. *Przegląd Przyrodniczy* XXVII, 4, 133-146 [In Polish with English summary].
- Trąba Cz., Wolański P., Oklejewicz K. (2006). Różnorodność florystyczna wybranych zbiorowisk nieleśnych w dolinie Sanu [Floristic diversity of selected nonforest plant communities in the San River valley]. *Annales UMCS Sect. E*, 61, 267–275 [In Polish with English summary]. Floristic diversity of selected nonforest plant communities in the San river valley Floristic diversity of selected nonforest plant communities in the San river valley Floristic diversity of selected nonforest plant communities in the San river valley
- The Edict (1996) Zarządzenie Regionalnego Ministra Środowiska, Zasobów Naturalnych i Leśnictwa z dnia 14 czerwca 1996 r. w sprawie uznania za rezerwat przyrody [Regulation of the Regional Minister of the Environment, Natural Resources and Forestry of 14 June 1996 on recognition as a nature reserve]. M.P. 1996, nr 42, poz. 410-411 [In Polish].
- The Edict (2007) Rozporządzenie Nr 3 Wojewody Mazowieckiego z dnia 13 lutego 2007r. w sprawie Warszawskiego Obszaru Chronionego Krajobrazu [Regulation No. 3 of the Mazowieckie Province Governor dated 13 February 2007. on the Warsaw Protected Landscape Area.]. Dz.U. of 2004r. Nr 92, poz. 880 and of 2005r. Nr 113, poz. 954 i Nr 130, poz. 1087 [In Polish].

- The Edict (2011) Zarządzenie RDOŚ w Warszawie z dnia 19 lipca 2011 r. w sprawie rezerwatu przyrody „Skarpa Ursynowska” [Order of the Regional Directorate for Environmental Protection in Warsaw of 19 July 2011 on the nature reserve "Skarpa Ursynowska"], access in May 2017. [<http://bip.warszawa.rdos.gov.pl>] [In Polish].
- Vinczeff I. (1984). The effects of some ecological factors on grass yield. Proceedings of the 10th General Meeting of European Grassland Federation, Ås, Norway, 76-79.
- Walker K.J., Stevens P. A., Stevens D. P., Mountford J. O., Manchester S. J., Pywell R. F. (2004). The restoration and re-creation of species-rich lowland grassland on land formerly managed for intensive agriculture in the UK. *Biological Conservation* 119, 1-18.
- Wallin L., Svensson B. M., Lönn M. (2009). Artificial dispersal as a restoration tool in meadows sowing or planting? *Restoration Ecology*, 17, 270-279.
- Warda M., Kozłowski S. 2012. Grassland – a Polish resource. *Grassland Science in Europe* 17, 3–16.
- Winter C., Lehmann S., Diekmann M. (2008). Determinants of reproductive success: A comparative study of five endangered river corridor plants in fragmented habitats. *Biological Conservation* 141, 1095-1104
- Wysocki C., Budzikowski H. (1996). Roślinność Skarpy Ursynowskiej (na odcinku między ul. Arbuzową a Ciszewskiego) [Vegetation on the Ursynow Slope with the area between Arbuzowa St. and Ciszewskiego St.]. *Rev. Eng. Env. Sci.* 9: 75-83 [In Polish with English summary].
- Zarzycki J., Misztal A. (2010). Abandonment of farming practices: impact on vegetation. *Grassland Science in Europe* 15, 133–135.
- Zarzycki K., Trzcńska-Tacik H., Różański W., Szeląg Z., Wołek J., Korzeniak U. (2002). Ecological indicator values of vascular plants of Poland. *Biodiversity of Poland*. Vol. 2. W. Szafer Institute of Botany, PAS Press, Kraków.

## TESTING THE RAPID IDENTIFICATION SYSTEM AS AN INNOVATIVE TOOL FOR ENVIRONMENTAL ASSESSMENT OF FARMS

Jerzy Mirosław KUPIEC<sup>1\*</sup>

<sup>1</sup>Poznań University of Life Sciences, Department of Ecology and Environmental Protection,  
Piątkowska street 94C, 60-649 Poznań, Poland

\*Corresponding author: jerzy.kupiec@up.poznan.pl

### Abstract

The aim of the research was the valorization of farms with different areas, specialization and intensity of production using a comprehensive evaluation method. The scope of work covered 404 farms with data from 2008-2014. The area of the farms ranged from 1 to 1001 ha. The elements subjected to the bonitational assessment were divided into two modules - production and environmental modules. The production module included: the share of selected agricultural land and crop groups, the use of mineral nitrogen and phosphorus fertilizers, industrial feed consumption and animal stocking. The following elements were evaluated in the environmental module: dates of application of manures and number of days to be mixed with soil, method of preparation of silage, management of domestic sewage, size of buildings for storage of solid and liquid manures, year of construction of slabs for solid manure, tanks and cesspool. The points received in individual farms ranged from 49 to 148. Three groups of farms were identified on the basis of cluster analysis. The results showed that such elements as specialization, farm size, a share of arable land and grassland, stocking density, mineral fertilizers and industrial feed consumption were important for the identification of potentially hazardous farms. Differences in nitrogen fertilizer consumption varied in particular groups of farms from 16 to 169 N kg·ha<sup>-1</sup>. Nitrogen equivalent in industrial feeds indicated the consumption even at 500 N kg·ha<sup>-1</sup>.

**Keywords:** *rapid identification system (RIS), comprehensive assessment of farms, non-point pollution*

### Introduction

Agricultural production is a branch of the national economy, which operates on very large areas. Farms use natural resources to achieve productive effects. Agro-ecosystems are not an isolated part of the area. They are strongly interconnected and interact with biogeosystems. Their condition often depends on the quality of agricultural production in the region. The problem of non-point pollution has been present for several decades. A particular risk for the environment is the dissipation of unused nutrients in agricultural production. The emission of macronutrients into natural ecosystems can cause unfavorable physical, chemical and biological changes. That is why the monitoring and control system on farms is so important. The only tool for controlling agricultural production is the balance of nutrients (Kupiec 2015). In the EU and OECD countries it is mandatory (Regulation... 2002, Kopiński 2005). However, the lack of standardization of the method makes that the results are often unreliable and incomparable. Such an approach may result in an incorrect assessment of the facts. However, the balance of nutrients only estimates the part of agricultural production. The problem is the lack of a comprehensive farm assessment methodology for their potential environmental impacts, which will take into account, in addition to the nutrient circulation, several other equally important parameters that may contribute to the deterioration of environmental indicators. The purpose of the research was a comprehensive analysis of



potential risks of the environment from a representative group of farms characterized by large diversity in terms of area, specialization and intensity of land management.

### Material and Methods

The research was partially financed by the National Science Centre Research Project No: N N305 372238. There 404 farms located in 294 towns, 161 communes and 10 provinces (Dolnośląskie, Kujawsko-Pomorskie, Lubelskie, Lubuskie, Łódzkie, Mazowieckie, Pomorskie, Warmińsko-Mazurskie) have been selected for the research. The average size of the farm was 47.6 ha. Among the analyzed farms, 15% had no animals and among the selected farms, the largest group was medium-sized farms in the range of 11-50 hectares (75%).

The potential environmental hazard assessment from the surveyed farms were made on the basis of a comprehensive method based on basic production and environmental parameters that could have a negative impact on soil, water, atmospheric environment and biodiversity. The selected elements were quantified with the use of point bonitation (Kupiec 2017). The rapid identification system (RIS) allows to identify farms that may be a potential threat to the quality of the environment and can be used in order to monitor and control agricultural units. The essence of this system is two modules: production and environment (Figure 1).

#### Production module

It includes elements directly linked to the production process, i.e. plant and animal production:

share of arable land and permanent grassland [%],

share of selected groups of plants that most influence on the process of reproduction or degradation of organic matter in soil (cereals, industrial crops, roots, vegetables, intensive orchards, smallseed papilionaceae, leguminous, pasture crops and green manure) [%],

livestock density calculated on the basis of the Regulation of the Council of Ministers (Journal of Laws 2005, No. 92, item 769) [ $\text{LSU}\cdot\text{ha}^{-1}$ ],

consumption of nitrogen and phosphorous mineral fertilizers [ $\text{kg N}$  and  $\text{P}\cdot\text{ha}^{-1}$ ],

consumption of industrial feed - calculated on the basis of nitrogen equivalent (0.043) - average nitrogen content in industrial feeds most frequently registered on farms (Kupiec 2008):

$$N_{pp} = \Sigma pp \times 0.043$$

where:  $N_{pp}$  - nitrogen in industrial feed,  $\Sigma pp$  - sum of industrial feed calculated per the area of agricultural land [ $\text{kg N}\cdot\text{ha}^{-1}$ ].

#### Environmental module

This module is based on the practices of organization and management on the farm:

the date of application of solid and liquid manures was assessed on the basis of the months in which the farmers applied them on the fields.

the lack of buildings for the storage of manures were calculated according to the formula:

$$B_b = Z - S$$

where:  $B_b$  - the lack of building,  $Z$  - demand for: concrete plate ( $\text{m}^2$ ) or tank ( $\text{m}^3$ ),  $S$  - current state: concrete plate ( $\text{m}^2$ ) or tank ( $\text{m}^3$ )

The 5% tolerance threshold was applied due to changes of inventory strength over the year. The lack of building was converted into percentages and the score was assigned according to the following divisions: scores by compartments.

age of the building [year of construction],

period from application to plough manures [number of days],

the way of preparing silage - variants: concrete floor with drainage tank, foil sleeves, concrete floor without drainage tank, on the ground isolated with foil, on the ground without isolation, the way of water waste management - variants: domestic wastewater treatment plants, sewerage system, waste water treatment plant or reception by municipal services, agricultural using.

The minimum number of points for a particular feature is 0 and a maximum number of points is 16.

### Results and Discussion

The total number of points awarded in individual farms ranged from 49 to 148 (average 96). The smallest of them received farms without animals and the largest ones with pigs (Table 1), indicating a potentially higher level of environmental standards in this group of farms. Breeding swine is a serious environmental hazard resulting primarily from the production of excrements (Marszałek et al. 2011) and the emission of various gases into the atmosphere (Tofant et al 2003). The high level of the consumption of industrial feed has also been recorded in pig farms. In Poland in the years 2000-2014 their production increased by about 101%. Breeding swine is in the second place after the poultry in terms of consumption of this type of feed (Urban 2015).

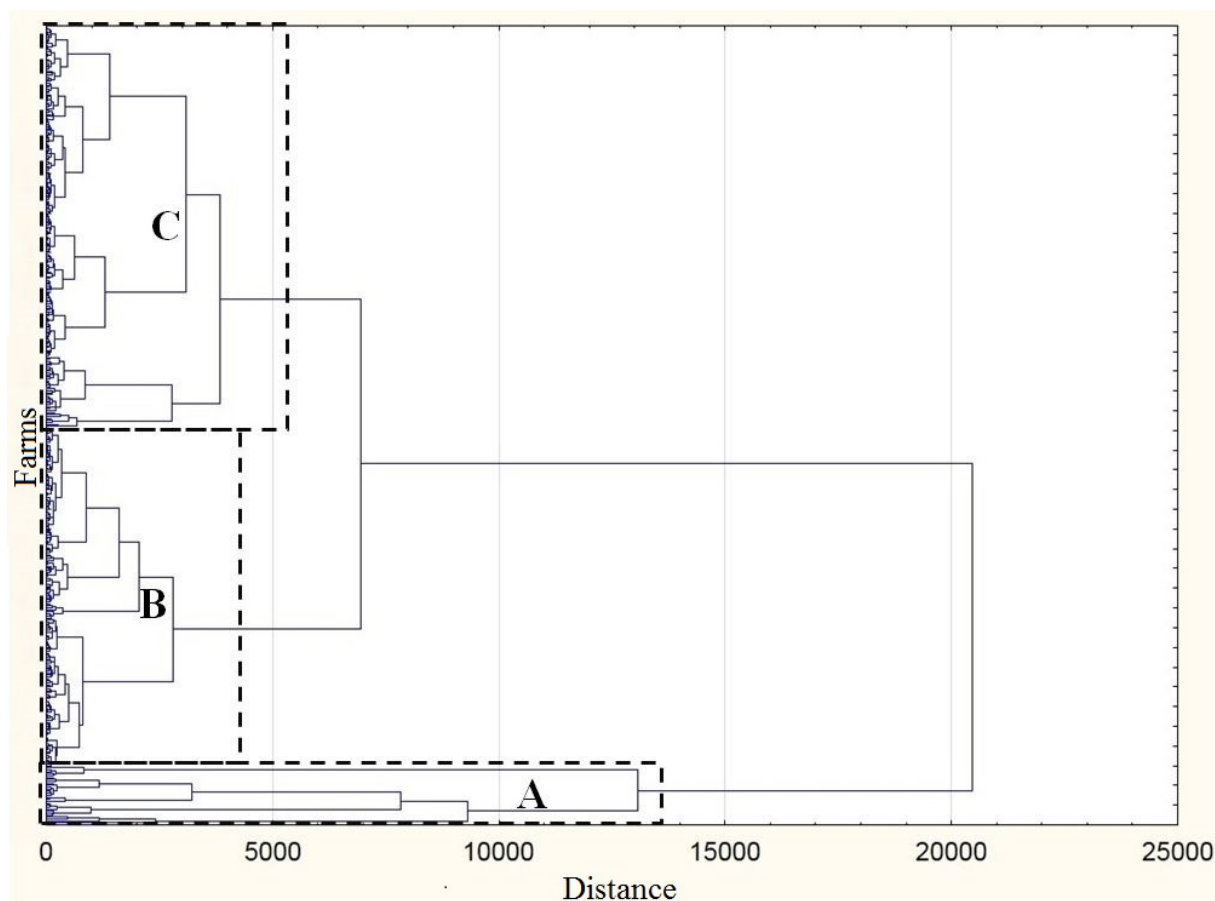
Table 1. The score assessment according to specialization group

The scope of points	The share of farms [%]	The share of specialization groups [%]								
		F	F < 0,15	CF	SF	CF/SF	SF/CF	PF	HF	EE/SF
<60	4	88	6	6	0	0	0	0	0	0
61-80	21	49	6	34	5	2	2	1	1	0
81-100	34	14	4	35	28	11	7	1	0	0
101-120	29	0	5	41	35	8	9	1	0	1
>120	12	0	0	23	64	6	2	4	0	0

F – farms without animals, F < 0.15 – farms with the livestock density below 0.15 LSU·ha<sup>-1</sup>, CF – farms only with cattle, SF – farms only with pigs, CF/SF – farms with cattle > 50% of share and with pigs > 30% of share, SF/CF – farms with pigs > 50% of share and with cattle > 30% of share, PF – farms only with poultry, HF – farms only with horses, EE/SF – farms with sheep > 50% of share and with pigs > 30% of share  
Source: own research

Farms carrying out only plant production can pose a threat mainly from the production module. Only the management of the purchased manures (field application and application to plow) was considered in the environmental module on these farms, but it was rarely quoted. An additional parameter evaluated in the environmental module on non-livestock farms was the management of domestic waste water. There are still cases of agricultural use of domestic sewage in which there may be several types of pollution. The conditions of agricultural waste water use are specified in the Water Law (Journal of Laws of 2001, No. 115, item 1229), Regulation of the Minister of the Environment of 2006 (Regulation... 2006; Journal of Laws No. 137, item 984, as amended) and Code of Good Agricultural Practice (Code... 2004). Among the surveyed farms, 12% of them applied the sewage into the fields.

The analyzed features of the farms were analyzed statistically using cluster analysis on the basis of which three groups of farms (A, B and C, Figure 1) were distinguished.



Source: own research

Fig. 1. The hierarchical tree for analyzed farm features made by the agglomeration method

Group A consisted of farms in large areas targeted at fattening pigs. The intensity of production in these farms was mainly attributed to the high consumption of industrial feed which was 19 times higher than in farms of group B and with livestock above 4 LSU·ha<sup>-1</sup> (Table 2). These farms also received the highest number of points according to the rapid identification system.

Table 2. The differences between groups of farms on the basis of the most discriminating characteristics and results of point bonitation in the groups

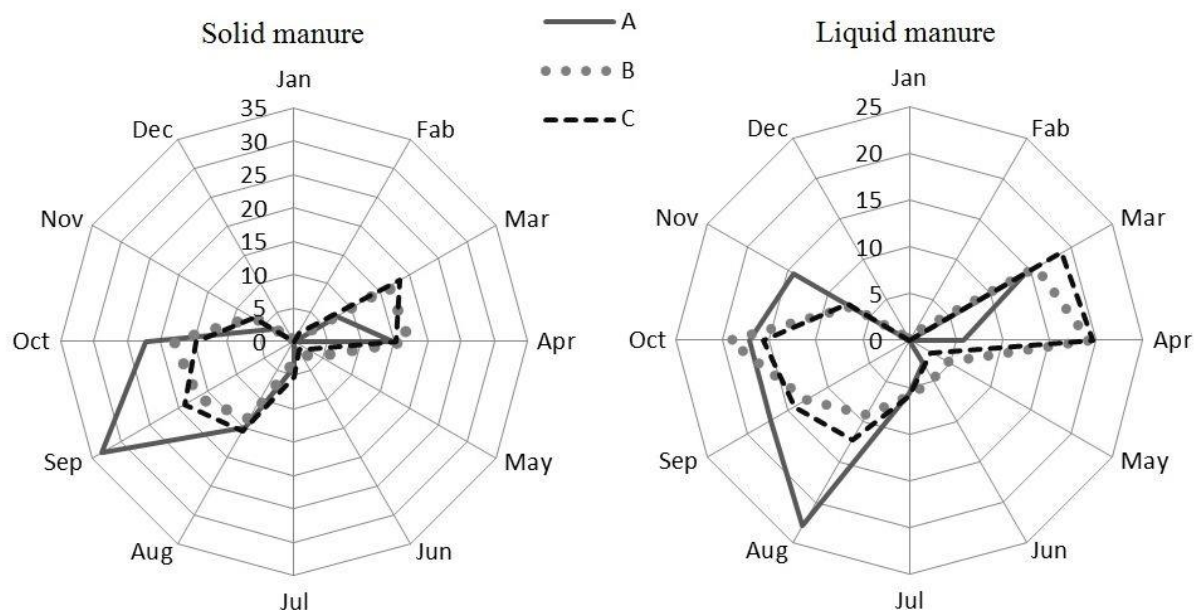
Group	Farm area	Arable land	Grasslands	N min <sup>1</sup>	P min <sup>2</sup>	N of feed <sup>3</sup>	The livestock density	The rapid identification system	
	[ha]	[ha]	[ha]	[kg·ha <sup>-1</sup> ]	[kg·ha <sup>-1</sup> ]	[kg·ha <sup>-1</sup> ]	[LSU·ha <sup>-1</sup> ]	mean	median
A	220.9	92.2	8.5	87	15	500	4.3	105	109
B	41.5	77.0	18.7	16	3	27	1.3	87	88
C	33.5	81.6	11.8	169	21	40	1.4	101	102

<sup>1</sup> nitrogen from mineral fertilizers, <sup>2</sup> phosphorus from mineral fertilizers, <sup>3</sup> nitrogen from industrial feed

Source: own research

The farms of the group B are five times smaller than those belonging to group A and the largest share of grassland was in farms, which was related to the predominance of dairy farms (Table 3). The consumption of fertilizers and industrial feeds was at the lowest level, as was the stocking density which was the lowest in comparison to the other analyzed groups. These farms received the lowest score of the rapid identification system (Table 2). The differences were also observed in the dates of application of manures (Figure 2). Farms of group A

preferred September and October for solid manures and the period between August and November for liquid manures. In the other two groups (B and C) the differences in the time were not significant.



Source: own research

Fig. 2. The preferred dates of application of manures in analyzed farm groups [%]

Group C is the smallest, most equitable share of cattle and pigs (Table 2). They consumed the largest amount of mineral fertilizers - in the case of nitrogen it was ten times more than in farms of group B. The consumption of fertilizers in groups A and C was significant, more than a mean in Poland. The average consumption in the country for the years 2006-2016 was 65-81 kg N·ha<sup>-1</sup> and 9-12 kg P·ha<sup>-1</sup> (Central... 2017). The number of points based on the rapid identification system was also high and exceeded 100 points.

Table 3. The differences between farms on the basis of specialization of production

Group	The share of specialization group* [%]								
	F	F < 0,15	CF	SF	CF/SF	SF/CF	PF	HF	EE/SF
A	22	4	9	57	4	4	0	0	0
B	18	5	42	21	6	5	2	0	0
C	19	4	31	30	8	6	1	0,5	0,5

\* the abbreviations are explained under the table 1

Source: own research

## Conclusion

The comprehensive approach to assessment of farms in terms of their impact on the various components of the ecosystem is justified in the context of conservation of natural resources and improvement of environmental standards in agricultural enterprises. The implementation of the assumptions of the Nitrates Directive (91/676/EEC), the Water Framework Directive (2000/60/EC) and the Sewage Directive (91/271/EEC), but also the obligations resulting from Poland's membership in the OECD, HELCOM or the sustainable development principles is the requirement that Poland must consistently implement. The rapid identification system has been focused primarily on aspects related to dispersion of nutrients. And, the particular

importance in this case is attached to the means of production containing nitrogen and phosphorus used in crops and livestock breeding. These two macronutrients have the greatest impact on adverse changes occurring in natural ecosystems. Currently the only tool for monitoring agricultural production is the nutrient balance. The calculated balances on farms of different specializations show unequivocally, as in this study, that the highest risk is intensive animal production, especially fattening of pigs (Goulding et al. 2008, Kopiński 2012). This is mainly due to the production of large quantities of manures and high fertilization. Pig farms have potential environmental risks because of high farm nitrogen imbalances. With more than a 2:1 ratio of N inputs to outputs, N inputs were 50 percent higher than outputs (Yue et al. 2006). Another problem is the large consumption of industrial feed in such farms, which negatively affect balance sheet balance (Tagliapietra et al. 2004). The balances only cover the circulation of nutrients on the farm. These studies have also highlighted other issues in agricultural holdings, such as large deficiencies in the construction of manure storage, inadequate land pattern or too high livestock density. According to some authors, should seek to seal the agro-ecosystem (Sosulski and Łabętowicz 2007). It is also very important to remember about the internal sources of biogenic pollutants arising from wastewater management, manures or feed preparation (Myczko et al. 2009, The Agricultural... 2012, Kupiec et al. 2015). A detailed analysis of selected farms has shown that large farms with high livestock density, especially the farms specializing in pig breeding, pose the most significant problem in the context of environmental impacts. The biggest deficiencies are found in buildings for the storage of manures and the highest use of industrial feed in farms with pigs. These kind farms received the highest number of points according to the rapid identification system. In the group of medium-sized farms (34 ha) the highest use of N and P mineral fertilizers was recorded. Nitrogen fertilization was sometimes even 10 times higher than in the other groups of farms. These farms also received a large number of points of the rapid identification system. The research has shown that the rapid identification system allows the selection of farms that may have potentially negative impacts on the environment, including water quality. Farms with the high consumption of selected means of production and inappropriate agricultural practices received the highest number of points.

### References

- Central Statistical Office of Poland. (2017). Środki produkcji w rolnictwie w roku gospodarczym 2015/2016 [The means of production in agriculture in the marketing year 2015/2016]. <http://stat.gov.pl/obszary-tematyczne/rolnictwo-lesnictwo/rolnictwo/srodki-produkcji-w-rolnictwie-w-roku-gospodarczym-20152016,6,13.html> [access 15.03.2017].
- Code of Good Agricultural Practice. (2004). Ministry of Agriculture and Rural Development, Ministry of the Environment. [Ed.] I. Duer, M. Fotyma, A. Madej: 93.
- Goulding K., Jarvis S., and Whitmore A. (2008). Optimizing nutrient management for farm systems. *Philos Trans R Soc Lond B Biol Sci.*; 363(1491): pp. 667-680.
- Kopiński J. (2005). Regionalne zróżnicowanie bilansu azotu, fosforu i potasu w rolnictwie polskim w latach 1999-2003 [Regional diversification of nitrogen, phosphorus and potassium balance in Polish agriculture in 1999-2003]. [In:] Nawozy i nawożenie [Fertilizers and fertilization]. [Ed.] W. Lipiński, M. Fotyma, IUNG w Puławach, 2(23), pp. 84-93.
- Kopiński J. (2012). Realizacja celów środowiskowych i ekonomicznych w gospodarstwach o różnych kierunkach specjalizacji [Realization of environmental and economic objectives in farms with different fields of specialization]. *Problems of Agricultural Engineering*: 2 (76), pp. 37-45.

- Kupiec J. (2008). Ocena bilansu składników biogenych (NPK) jako podstawy monitoringu produkcji rolnej w aspekcie ochrony środowiska [Assessment of the nutrient balance (NPK) as a basis for monitoring agricultural production in the aspect of environmental protection]. Ph.D. thesis, University of Life Sciences in Poznan. 210.
- Kupiec J. M. (2015). Przegląd metod bilansowania makroskładników NPK w produkcji rolnej [A review of methods for NPK balancing in agricultural production]. *Inżynieria i Ochrona Środowiska*. 8, 3: 323-342.
- Kupiec J. M. (2017). Ocena potencjalnego zagrożenia dla środowiska ze strony wybranych gospodarstw rolnych z wykorzystaniem systemu szybkiej identyfikacji [Assessment of potential threats to the environment from selected farms using the rapid identification system]. [In]: *Rolnictwo XXI w. – problemy i wyzwania [Agriculture of XXI century – problems and challenges]*. (Ed.) D. Łuczycka. *Idea Knowledge Future*: 396-410.
- Kupiec J. M., Oliskiewicz-Krzywicka A., Stachowski P. (2015). Ocena wybranych elementów gospodarki wodno-ściekowej i obciążenia użytków rolnych makroelementami ze ścieków bytowych w wybranych gospodarstwach Wielkopolski [Evaluation of selected elements of water and sewage management and loading of agricultural land with macroelements from household sewage in selected farms of Wielkopolska]. *Annual Set The Environment Protection*: 17: 1017-1033.
- Marszałek M., Banach M., Kowalski Z. (2011). Wpływ gnojowicy na środowisko naturalne – potencjalne zagrożenia [Impact of slurry on the environment - potential hazards]. *J. Ecol. Health*, 15, 2: pp. 66-70.
- Myczko A., Lenarczyk J., Rudnik K. (2009). Metody magazynowania nawozów naturalnych w gospodarstwach rolnych [Methods of storing manures on farms]. *Woda-Środowisko-Obszary Wiejskie*. 9, 1(25): pp. 39-48.
- Rozporządzenia Rady Ministrów z dn. 10 maja 2005 r. zmieniające rozporządzenie w sprawie określenia rodzajów przedsięwzięć mogących znacząco oddziaływać na środowisko oraz szczegółowych uwarunkowań związanych z kwalifikowaniem przedsięwzięcia do sporządzenia raportu o oddziaływaniu na środowisko [Regulation of the Minister of Environment of 10 May 2005, amending the ordinance on the types of projects that may have significant effects on the environment and the specific conditions associated with the eligibility of an undertaking for the preparation of an environmental impact report] (*Journal of Laws No. 92, item 769*).
- Rozporządzenie Ministra Środowiska z dn. 23 grudnia 2002 r. w sprawie szczegółowych wymagań, jakim powinny odpowiadać programy działań mających na celu ograniczenie odpływu azotu ze źródeł rolniczych [Regulation of the Minister of Environment of 23 December 2002 on the detailed requirements to be met by the programs of measures aimed at reducing the outflow of nitrogen from agricultural sources] (*Journal of Laws No. 4, item 44*).
- Rozporządzenie Ministra Środowiska z dnia 24 lipca 2006 r. w sprawie warunków, jakie należy spełnić przy wprowadzaniu ścieków do wód lub do ziemi, oraz w sprawie substancji szczególnie szkodliwych dla środowiska wodnego [Regulation of the Minister of the Environment of 24 July 2006 on the conditions to be met for the introduction of sewage into waters or to land and on substances particularly harmful to the aquatic environment] (*Journal of Laws No. 137, item 984, as amended*).
- Sosulski T., Łabętowicz J. (2007). Oszacowanie rozpraszania azotu z rolnictwa polskiego do atmosfery oraz wód powierzchniowych i gruntowych [Estimation of dissipation of nitrogen from Polish agriculture into the atmosphere and surface and ground waters]. *Postępy Nauk Rolniczych*. 5: pp. 3-19.
- Tagliapietra, F., Ceolin, C., Schiavon, S. Gallo, L. (2004). Performance produttive e bilancio dell'azoto in allevamenti dediti alla produzione di suini pesanti, medio-pesanti e medi

- nel Veneto [Growth performance and nitrogen balance of growing pigs farms in Northern Italy Veneto] Italian Society of Veterinary Science. Annual meeting, 58, Grado, Gorizia (Italy), 22-25 Sep 2004. v. 58, pp. 483-484.
- The Agricultural Advisory Centre in Brwinów. (2012). Dostosowanie gospodarstwa rolnego do minimalnych wymogów wzajemnej zgodności oraz do warunków bezpieczeństwa i higieny pracy [Adaptation of the farm to the minimum cross compliance requirements and to health and safety at work]. [http://www.cdr.gov.pl/pol/do\\_pobrania/poradnik\\_metodyczny.pdf](http://www.cdr.gov.pl/pol/do_pobrania/poradnik_metodyczny.pdf). [access 13.04.2017].
- Tofant A., Pavicić Z., Matković K., Hadina S., Križanić J. (2003). Pig slurry hygienization with hydrogen peroxide-silver complex an environmentally acceptable disinfectant. *Veterinarski Archiv*; 73 (6): pp. 345-353.
- Urban S. (2015). Zmiany w produkcji pasz treściwych w Polsce [Changes in feed production in Poland]. *Stowarzyszenie Ekonomistów Rolnictwa i Agrobiznesu. Roczniki Naukowe*. 12, 5: pp. 307-311.
- Water Law Act of July 18, 2001 (Journal of Laws of 2001, No. 115, item 1229).
- Yue Z., Hua-Sheng H., Wen-Zhi C., Neng-Wang C., Wei-Ping W. and Luo-Ping Z. (2006). Evaluation of nitrogen balance on pig/crop farm systems in Jiulong River watershed, China. *Aquatic Ecosystem Health & Management* 9, 1, pp. 21-26.

## PLANT BENEFICIAL BACTERIAL STRAIN WITH PHC DECONTAMINATING POTENTIAL

Daria-Gabriela POPA, Oana-Alina BOIU-SICUIA\*, Roxana DUDOIU

Research-Development Institute for Plant Protection, Bucharest, Romania

\*Corresponding author: sicuia\_oana@yahoo.com

### Abstract

Recent concerns regarding environmental safety have drawn attention to the risks of petroleum hydrocarbons (PHC) contaminants. These pollutants are highly toxic mostly because of their persistence in the environment, and long range of toxicological effects. Therefore, we considered that accidental PHC field contamination when using agricultural mechanical systems is an issue that should be suppressed. In these regard we focused on the isolation of potential PHC decontaminating microorganisms. The lignocellulosic fibers are known as good absorbents of PHC, and also they are abundant materials in agricultural lands. From such lignocellulosic fibers, we isolated several bacterial strains, one expressing PHC decontaminating abilities. The new isolated strain BBp1 revealed PHC emulsification ability and was able to disperse the diesel fuel. The BBp1 bacterial strain also showed several plant beneficial traits. The phosphate solubilizing activity of this strain could improve soil fertility, thus contributing in plant growth stimulation. Arginine metabolism revealed in this strain could improve the efficiency of plant nitrogen use, thus regulating plant developmental processes as well as plants response to biotic and abiotic stress. The selected strain can contribute to plant growth stimulation through phytohormones synthesis, as it produces 9.6µg IAA/ml in the culture supernatant (LB broth supplemented with 2.5mM tryptophan).

**Keywords:** *PHC, Bacterial strain, Emulsification, Plant growth stimulation.*

### Introduction

The worldwide concern for human health and environmental protection considered the pollution derived from the diesel oil and its refined products is highly damaging for the soil structure and ground water quality, and highly toxic due to its persistence in the environment and long range of toxicological effects (Hussain et al., 2016; ATSDR, 1999). Soil pollution with petroleum hydrocarbons causes extreme harsh surroundings as it creates hydrophobic conditions, diminish the microbial diversity and growth, produces soil infertility that finally lead to less plant growth, with serious consequences for agriculture. For soil decontamination, bioremediation is a promising biological method, with both technical and ecological benefits (Hussain et al., 2016). The environmental biotechnology improves the negative effects caused by hydrocarbon pollution by using specialized microorganisms or microbial consortia capable of bioremediation of PHC contaminated soil (Onwurah et al., 2007). Several authors demonstrated bioremediation of PHC contaminated soils using native or exogenous microorganisms, usually improving soil aeration, moisture and nutrient content to increase microbial activity (Kulkarni, 2014). As in these study we considered only the accidental PHC field contamination when using agricultural mechanical systems, we focused on the isolation of potential PHC decontaminating microorganisms with plant beneficial applications as agro-inoculants.



## **Material and Methods**

The present study was performed at the RDIPP, Bacteriology laboratory, during 2016 and 2017. The study is focused on beneficial bacteria with PHC decontaminating potential and other traits involved in the improvement of agricultural land. In these regard we focused on the isolation of potential PHC decontaminating microorganisms. With this purpose we isolated some bacterial strains from lignocellulosic fibers, an abundant material in the agricultural lands, known as good absorbents of PHC. For microbial isolation, 1% of lignocellulosic fiber was immersed in distilled water and homogenized by vortex at 2000rpm for 1 minute, incubated for 15 minutes at room temperature and than displayed on Luria Bertani (LB) medium. The obtained bacterial growth was purified using the streak plate method for several sub-culturing on the same medium. During the isolation, there were maintained only the cultures with different colony morphology. The bacterial isolates were microscopically analyzed for their gram reaction and cell morphology. To establish the colonization potential the isolates were analyzed for swimming and swarming motility on LB with 0.3 and 0.5% agar, respectively, as mentioned by (Constantinescu et al., 2010). The bacterial respiratory type was determined by analyzing their growing in LB broth after static incubation. The emulsification potential of the isolated bacteria was evaluated on diesel fuel and engine oil as PHC substrates. Two methods were used to evaluate the emulsification activity of the bacterial strains. In the first method the bacteria were grown in LB broth at 150rpm orbital shaking and 28°C, until 10<sup>8</sup>cfu/ml. The cultures were centrifuged and only the supernatant was used in the emulsification test. The cell free supernatant was mixed with distilled water and PHC substrate in a ratio of 2:2:1 (v/v/v). As a negative control we used uninoculated LB medium instead of bacterial supernatant. The samples were vortex for 2 minutes at 3000rpm and allowed to rest for one hour before analyzing. Emulsification activity was determined by measuring the optical density at 540 nm (Patel and Desai, 1997; Olteanu et al., 2011). For the second method, the bacterial strains were grown in LB broth and modified McKeen medium (Olteanu et al., 2011) for four days in orbital shaking at 150rpm and 28°C. The cultures were centrifuged and the free cell supernatant was used in the emulsification test. Equal volumes of bacterial supernatant and PHC substrate were mixed together at 3000rpm for two minutes and allowed to rest for one day at room temperature before analyzing (Priya and Usharani, 2009). The emulsification index ( $E_{24}$ ) was calculated based on the emulsion layer height ( $H_{EL}$ ), and total height of the sample (TH), using the algorithm mentioned by Satpute et al. (2008):

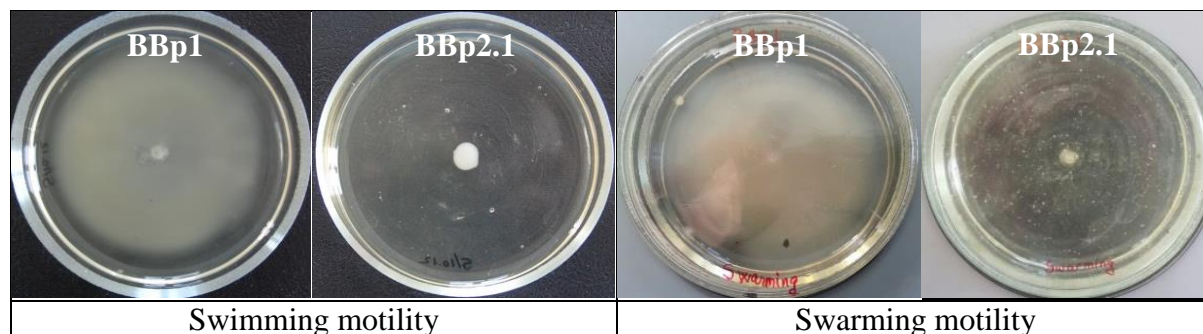
$$E_{24} = \frac{H_{EL}}{TH} \times 100$$

The oil spreading technique was carried out in order to detect the biosurfactant production and potential of hydrophobic PHC solubilization. For this test 40 ml of distilled water were added to a Petri dish of 10cm in diameter, 300 µl of used engine oil were slowly added to the surface of water. After 5 minutes, when the oil stain has spread in a thin layer on the water surface 60 µl of cell free supernatant from 4 days old cultures obtained in modified McKeen medium were slowly added to the surface of the oil. The diameter of clear zone formed by oil dispersion was measured and compared to a negative control of distilled water, and a positive control of 1% SDS (sodium dodecyl sulfate) solution, similarly prepared. The occurrence of clear zone is an indication of biosurfactant production.

Bacterial potential to produce several enzymes, like amylase, arginine dihydrolase, arginine decarboxylase, phosphatase, cellulase, chitinase, and gelatinase, and phytohormones (indole acetic acid, IAA) involved in plant growth promotion were analyzed according to Siciua et al. (2015 a,b, 2016).

## Results and discussion

The analyzed lignocellulosic material revealed a load of  $1.5 \times 10^4$  cfu/g. Two bacterial isolates, BBp1 and BBp2.1, were selected considering the differences in their colony morphology. The isolated bacteria were aerobic, gram positive, with rod shaped cells. Only BBp1 strain revealed swimming and swarming motility (figure 1), these indicating a good colonization potential.

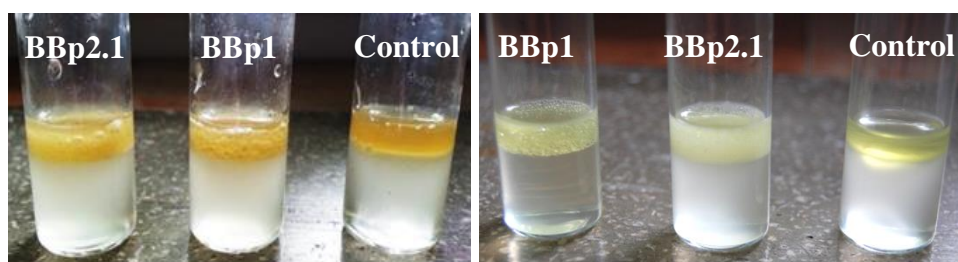


**Figure 1.** *In vitro* motility of BBp1 and BBp2 bacterial isolates

The emulsification potential expressed on the diesel fuel and engine oil revealed that BBp2.1 was more competitive than BBp1 strain, when cultivated on LB medium. However, both strains expressed a better emulsification of the engine oil than the diesel fuel (table 1, fig. 2).

**Table 1.** PHC emulsification activity of the isolated bacterial

PHC substrate	Emulsification activity at 540nm	
	BBp1	BBp2.1
Diesel fuel	0.041	0.121
Engine oil	0.301	0.532



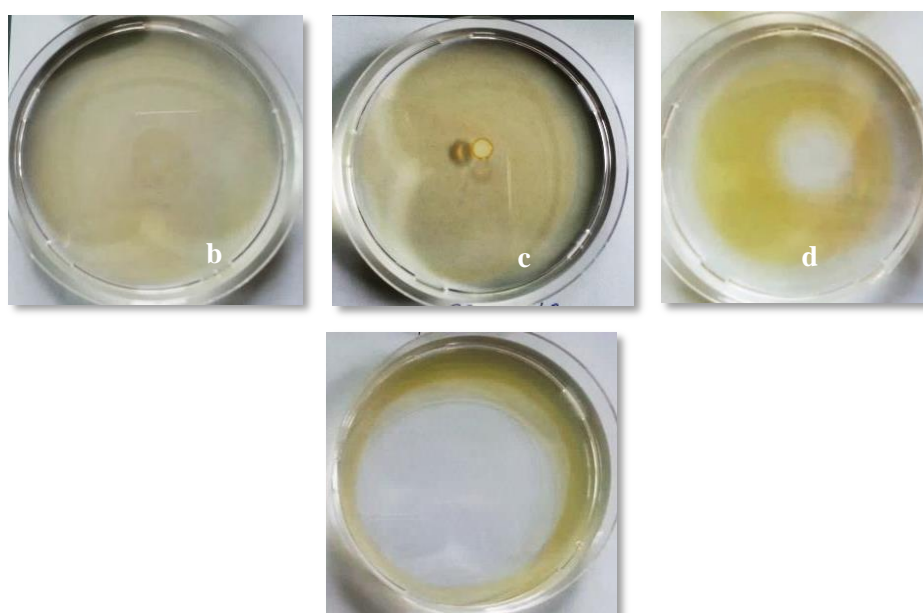
**Figure 2.** Emulsification activity of engine oil (a) and diesel fuel (b) by LB broth bacterial cultures

In the second method the bacterial strains were grown not only in LB broth, but also in McKean medium, known to stimulate biosurfactant production in bacterial cultures. This aspect was better noticed on diesel fuel, when, after 24h of static incubation, both strains expressed low to medium emulsification index values when grown in McKean medium compared to the emulsion stability revealed by the LB cultures supernatant (table 2). However, when the emulsification stability was calculated for the engine oil, no significant differences were revealed among strains activity when cultivated in McKean or LB broth, and both strains (BBp1 and BBp2.1) revealed similar emulsification index values (table 2).

**Table 2.** Emulsification stability after 24h of incubation

Sample type	BBp1		BBp2.1		Control	
	McKeen	LB	McKeen	LB	McKeen	LB
<b>Emulsification index - E<sub>24</sub> (%)</b>						
<b>Diesel fuel</b>	15.4	0	7.7	0	0	0
<b>Engine oil</b>	46.2	50	50	42.3	7.7	3.8

Biosurfactant activity of BBp1 and BBp2.1 in McKeen broth was evaluated through oil dispersion technique on engine oil (figure 3). Performing this test, BBp2.1 revealed poor oil dispersion ability of only 4mm in diameter. The BBp1 strain cleared the engine oil over an area of 18mm in diameter, which represent a quarter (25.7%) of the dispersion potential of the SDS control solution (that revealed a dispersion spot of 7cm in diameter).



**Figure 3.** Clear zones of engine oil dispersion: a. negative control with distilled water, b. BBp2.1. strain, c. BBp1 strain, d. SDS 1% as positive control

Plant beneficial traits were analyzed only for BBp1 strain. This strain revealed arginine decarboxylase, phosphatase, and gelatinase activity (figure 4). However, no amylase, arginine dihydrolase, cellulase and chitinase were detected.



**Figure 4.** *In vitro* trials for BBp1 enzymes production.

Arginine decarboxylase production (a), compared to the negative control (b); clear halo of substrate hydrolysis revealing phosphatase (c) and gelatinase (d) activity.

Arginine decarboxylase triggers one of the pathways of polyamine synthesis. This increases plant growth and development, and plant tolerance to biotic (Rossi et al., 2015) and abiotic stresses (Gupta et al., 2016).

Regarding phosphate fertilizers, many such compounds have poor solubilization in water. However, using plant beneficial microorganism with phosphatase activity could contribute to a better absorption of such nutrients in plants, increasing the efficiency of phosphate fertilizers.

Analyzed for IAA production potential, BBp1 strain revealed 5.3µg IAA/ml of culture supernatant when grown in usual LB broth medium. However, when IAA precursor was added into the medium, BBp1 produced 9.6 µg IAA/ml of culture supernatant of LB supplemented with 2.5mM tryptophan.

### **Conclusions**

A microbial load of  $1.5 \times 10^4$  cfu of cultivable microorganisms was determined per gram of lignocellulosic fiber experimentally used as PHC absorbent in contaminated areas. From this microbial growth, two gram positive bacteria, BBp1 and BBp2.1, were analyzed for their emulsification and dispersion ability of two petroleum hydrocarbons: diesel fuel and engine oil. Although, BBp2.1 revealed a better emulsification activity after one hour of incubation with the PHC substrate; BBp1 revealed that the emulsification activity is more stable after 24h. BBp1 bacterial strain also expressed oil dispersion activity and a better colonization capacity. Therefore, it was also analyzed for plant growth stimulation ability, revealing phytohormones production (9.6µg IAA/ml LB with 2.5mM tryptophan) and several plant beneficial enzymes such as arginine decarboxylase, phosphatase, and gelatinase.

### **References**

- ATSDR (1999). Toxicological profile for total petroleum hydrocarbons (TPH). Agency for Toxic Substances and Disease Registry. Public Health Service, US Department of Health and Human Services, Atlanta, GA.
- Constantinescu F., Siciua O.A., Zamfiropol R., Dinu S., Oancea F. (2010). Beneficial characteristics of some bacterial strains isolated from rhizosphere. *Romanian Journal of Plant Protection*, vol. 3, pp. 6-11.
- Gupta Kamala, Sengupta Atreyee, Chakraborty Mayukh, Gupta Bhaskar 2016. Hydrogen Peroxide and Polyamines Act as Double Edged Swords in Plant Abiotic Stress Responses. *Frontiers in Plant Science*, vol 7, art. 1343, 19p.
- Hussain I., Wimmer B., Soja G., Sessitsch A., Reichenauer T.G. (2016). Evaluation of Plant-Compost -Microorganisms Synergy for the Remediation of Diesel contaminated Soil: Success Stories from the Field Station. EGU General Assembly. *Geophysical Research Abstracts*, vol. 18, EGU2016-2889.
- Olteanu V., Siciua O., Ciuca M., Carstea D.M., Voaides C., Campeanu G., Cornea C.P. (2011). Production of biosurfactants and antifungal compounds by new strains of *Bacillus* spp. isolated from different sources. *Romanian Biotechnological Letters*, vol. 16, no.1, pp. 84-91.
- Onwurah I.N.E., Ogugua, V.N., Onyike N.B., Ochonogor A.E., Otitoju O.F. (2007). Crude soil spills in the environment, Effects and Some Innovative Clean-up Biotechnologies. *International Journal of Environmental Research*, vol. 1, no. 4, pp. 307-320.
- Patel R.M., Desai A.J. (1997). Surface active properties of rhamnolipids from *Pseudomonas aeruginosa* GS3. *J. Basic Microbiol.* 37 (4), 281-286.

- Priya T., Usharani G. (2009). Comparative study for biosurfactant production by using *Bacillus subtilis* and *Pseudomonas aeruginosa*. *Botany Research International*, vol. 2, no. 4, pp. 284-287.
- Rossi F.R., Marina M., Pieckenstain F.L., 2015. Role of Arginine decarboxylase (ADC) in *Arabidopsis thaliana* defence against the pathogenic bacterium *Pseudomonas viridiflava*. *Plant Biol (Stuttg)*, vol.17, no.4, pp 831-839.
- Satpute S.K., Bhawsar B.D., Dhakephalkar P.K., Chopade B.A, (2008). Assessment of different screening methods for selecting biosurfactant producing marine bacteria. *Indian J.Marine Sci.*, vol. 37, no. 3, pp. 243-250.
- Sicuia O.A., Dinu S., Constantinescu F. (2015b). Plant beneficial *Pseudomonas* spp. Strains isolated from rhizosphere. International symposium Priorities of Chemistry for a Sustainable Development – PRIOCHEM, XI edition, Bucharest, 29th - 30th October 2015, Book of Abstracts, p. 53.
- Sicuia O.A., Dinu S., Constantinescu F. (2016). Phytohormone-like producing *Bacillus* increase tomato seedlings quality. *Scientific Bulletin. Series F. Biotechnologies*, vol. XX, pp. 83-88.
- Sicuia O.A., Grosu I., Constantinescu F., Voaideş C., Cornea P.C. (2015a). Enzymatic and genetic variability in *Bacillus* spp. strains with plant beneficial qualities. *AgroLife Scientific Journal*, vol. IV, no. 2, pp. 124-131.

## CONTRIBUTION TO THE KNOWLEDGE OF THE BIOLOGICAL CYCLE OF THE LEAF MINING MOTH CAMERARIA OHRIDELLA DESCHKA DIMIC SPECIES

Miha TĂLMACIU <sup>1\*</sup>, Nela TĂLMACIU <sup>1</sup>, Carmen MIROIU <sup>2</sup>, Ionela MOCANU <sup>1</sup>

<sup>1</sup> University of Applied Life Sciences and Environment” from Iasi, Romania

<sup>2</sup> Phytosanitary National Authority– Vaslui Phytosanitary Departament., Romania

\*Corresponding author: mtalmaciu@yahoo.fr

### Abstract

In the period 2014-2015 were made observations on mining moth chestnut *Cameraria ohridella* Deschka Dimic, in parks and chestnut zone alignments in Huși from Vaslui County. For observations in each year are purchased the pheromone traps type atra-CAM at the Institute of Chemistry "Raluca Ripan" from Cluj. In each of the two years of observations and proceeded to the systematic recording of data on the occurrence and flying insect oviposition, completing the larval stage, the pupa stage and replay each generation cycle. Since visual observations in the field are difficult to track in the number of generations, thanks to the emergence staggered butterflies and then deposit eggs, emergence of larvae of the first egg, so to establish better during each stage in the field I doing so: - I chose trees that have branches below, so that they can get to them from these branches have chosen 10 leaves that we signed with a thread and on them we followed all stages from egg to pupa and adult. On these leaves observation of 3 in 3 days, I followed and noted laying and still other stages: larva, pupa and adult. Basically, I followed the stage of egg, larva, pupa to butterfly leaving the mine by the same leaves and leaflets. With the help of Agroexpert system was calculated sum of effective temperatures required at each stage of development.

**Keywords:** *mining moth, Chestnut, life cycle, stages of development*

### Introduction

The ornamental chestnut, *Aesculus hippocastanum* L, originated in the Balkan Peninsula, is a tree, which in our country is spread everywhere, being a decorative element in green spaces, parks, botanical gardens, institutions, and leaves and especially fruits are of phytopharmaceutical importance, The seeds are used in the production of technical soap, technical oil and glue, and starch extracted from chestnuts is used for the preparation of color pastes and for printing fabrics. Soft, lightweight, slightly resistant wood, impregnates well, good groundwork is used for use as a panel veneer for orthopedic articles. Chestnut is also a honey-like species, its flowers being extensively visited by bees for picking nectar and pollen. However, the ornamental chestnut is to be cultivated mainly as a decorative species in parks, public gardens, on the alignments of the stalls and the boulevards, and is marked by the symmetry of the crown, the early flowering and the display of beautiful flowers, and then through the rich and very elegant foliage. Also supports the trimming of the crown). Although, in general, the ornamental chestnuts to which we refer do not require special measures to combat plant phytosanitary organisms, the trees being vigorous and tolerant to possible damage to various organs, vegetative and reproductive, are more or less affected by many phytopathogens. (Prodan, 1915, quoted by Oltean 2015). However, we can say that for a long time there has been a balance of these harmful organisms, the trees generally growing in the proper way.

This biochemical balance of the ornamental chestnut has been disturbed in recent years by the presence and activity of a new pest - the leaf mining moth - *Cameraria ohridella* (DESCHKA-DIMIĆ, 1986), recently reported in the entomofauna of the countries in Europe, (Beratlić C., 1998) including in our country. Chestnut with white flowers called popular wild or ornamental chestnut (*Aesculus hippocastanum* L.) is preferred by the harmful species occurring in our country and causing premature defoliation.

### Material and method

In the agricultural year 2014-2015, observations were made on the chestnut moth *Cameraria ohridella* Deschka Dimič in the chestnut parks and alignments in the county of Vaslui. For ease of observation every year, trap-attract pheromones are purchased from the Raluca Rîpan Institute of Chemistry in Cluj. In each of the two years of observations, systematically recorded data on the occurrence and flight of the insect, the pond deposition, the larval stage, the cycle and the resumption of the cycle of each generation. Since visual observations in the field are difficult to track in terms of the number of generations (Perju, T., 2004), due to the gradual occurrence of butterflies and then the laying of eggs, the appearance of larvae in the first eggs, so in order to best determine the duration of each stage in the field Proceed as follows: The trees that have the branches below, so that they can reach them, from these branches, I chose 10 leaves that I have a thread of thread and I followed all the stages from egg to stern and adult (Oltean I., 2015). On these observation leaves, from 3 to 3 days, I watched and noted the laying of the eggs and then the other stages: larva, stern and adult. Basically, I watched the egg, larva, sternum stage until the butterfly leaves the butterfly on the same leaves and foliage. With the Agroexpert program the sum of the actual temperatures required for each stage of evolution was calculated.

### Results and Discussion

The research carried out during the year 2014 aimed at studying the biological cycle, the dynamics of adult flight and the influence of climatic factors on *Cameraria ohridella* Deschka Dimič, in order to issue warning bulletins by proposing chemical treatments as measures to limit the population in climatic conditions of Vaslui County.

For the pursuit of *Cameraria ohridella* adult flight, were used the pheromone traps, atra-CAM type. Thus, a trap / location was used, and baits were changed monthly from May to September. Adult flight rating grades were made 3 times a week. In order to correlate the data obtained with the meteorological data, the sums of the actual temperature ranges (over 12°C) were calculated for each stage of evolution. In terms of climatic characterization, the year 2014 recorded a series of higher temperatures in spring compared to the normal multiannual period with values between 1.9-3.9°C (March - May), precipitation (11.2 mm (March) and 10.3 mm (m) and were below normal in April with a 11.3 mm deficit, and the monthly average relative humidity had values Between 74% (March) and 69% (April - May). In the summer, temperatures were higher than the normal multi-annual, with values ranging from 0.7 to 2.1°C, and the rainfall had a deficit in July and August between 14.22 and 22.3 mm, and in June Exceeded normal by 52.6 mm. September has recorded temperatures that exceeded the multi-annual by 1.1°C and rainfall by 46.3 mm. The absolute minimum temperature was -12.7 °C, recorded on January 12; The absolute maximum was + 35.5 °C recorded on July 29, and the last spring frost was on March 29, -2.0°C.

The biological cycle of the chestnut moth in the Vaslui area (Table 1) has observed field conditions with the appearance of adults, pond deposition, larva and pup, the duration of each stage of the insect and the sum of actual temperatures for all generations of the insect.

Under the ecological conditions in the Vaslui area, the mining chest of *Cameraria ohridella* Deschka Dimič, chewed as a snout in the leaves fallen on the ground.

Adults of the third (hymnal) generation appeared on 05.05, at a  $\Sigma (t_n - t_0) = 118.06^\circ\text{C}$  (Table 1). After sexual maturation and mating, which has tree trunks, especially in the morning, 7 days after the appearance of the first butterflies, the females started pond deposition. The first eggs were deposited on 12.05, at a  $\Sigma (t_n - t_0) = 170.69^\circ\text{C}$ . Ponta is deposited throughout the flight of the insect, the last eggs were observed on 19.06. The incubation lasted 6 days, at a mean decade temperature of  $200^\circ\text{C}$  and a relative humidity of 62%.

The first V1 larvae occurred on 18.05, at a  $\Sigma (t_n - t_0) = 209,18^\circ\text{C}$ . The duration of the larval stage was 22 days at a mean decade temperature of about  $20.9^\circ\text{C}$  and relative humidity of 62-70%. The kernel stage was observed on 09.06, at a  $\Sigma (t_n - t_0) = 348.51^\circ\text{C}$ , and after 8 days, the first butterflies of the generation - a, on 17.06, appeared at  $\Sigma (t_n - t_0) = 446, 8^\circ\text{C}$ .

Generation I lasted 36 days (from the first eggs to the first butterflies).

Approximately 10 days after the appearance of the first generation butterflies, the first new eggs on the leaves were observed on 29.06, at a  $\Sigma (t_n - t_0) = 553.71^\circ\text{C}$ .

The incubation lasted about 5 days, the first larvae appeared on 03.07, at a  $\Sigma (t_n - t_0) = 577.7^\circ\text{C}$ . The duration of the larval stage was 22 days, at a mean decade temperature of  $21.80^\circ\text{C}$  and a relative humidity of 67-74%.

The registration of the first knuckles took place on 25.07., At a  $\Sigma (t_n - t_0) = 785.46^\circ\text{C}$ , 10%, and on 28.07 the percentage of the umbilions was 80%, at  $\Sigma (t_n - t_0) = 816.77^\circ\text{C}$ .

The duration of the pupal stage was 10 days, so on 04.08, the first butterflies of the second generation began to appear on a  $\Sigma (t_n - t_0) = 891,91^\circ\text{C}$ .

The second generation lasted 35 days (from the first eggs to the first butterflies).

The butterflies of the second generation began to plow on 08.08, at a  $\Sigma (t_n - t_0) = 939.23^\circ\text{C}$ . Massive egg deposition was recorded on 12.08, 60%.

Approximately 5 days after the pond deposition, the first larvae (V1) occurred on 14.08, at a  $\Sigma (t_n - t_0) = 1002.09^\circ\text{C}$ .

The duration of the larval stage was approximately 23 days at an average temperature of  $23.0^\circ\text{C}$  and a relative decade humidity of 55%.

Complete development of stern transforming larvae. The first knuckles were observed on 07.09, at a  $\Sigma (t_n - t_0) = 1190.71^\circ\text{C}$ , at a rate of 3-4%.

Table 1. The emergence of the first stages of development of *Cameraria ohridella* Deschka Dimič mining moth in 2014

Generation	Stage	Date of first appearance	Stage duration (days)	$\Sigma(t_n - t_0)$
G3 (hiemal)	Adults	05.05	38	$118,06^\circ\text{C}$
G1 36 days	egg	<b>12.05</b>	6	$170,69^\circ\text{C}$
	larvae	<b>18.05</b>	22	$209,18^\circ\text{C}$
	pupae	<b>09.06</b>	10	$348,51^\circ\text{C}$
	adult	<b>17.06</b>	-	$446,80^\circ\text{C}$
G2 35days	egg	<b>29.06</b>	5	$553,71^\circ\text{C}$
	larvae	<b>03.07</b>	22	$577,75^\circ\text{C}$
	pupae	<b>25.07</b>	10	$785,46^\circ\text{C}$
	adult	<b>04.08</b>	38	$891,91^\circ\text{C}$
G3 up to 10 may	egg	<b>08.08</b>	5	$939,23^\circ\text{C}$
	larvae	<b>14.08</b>	23	$1002,09^\circ\text{C}$
	pupae	<b>07.09</b>	212	$1190,71^\circ\text{C}$



On 20.09, at a  $\Sigma (t_n - t_o) = 1237,79^{\circ}\text{C}$ , more than 50% of the larvae were recorded, and on 26-28.09 they were about 91%, at a  $\Sigma (t_n - t_o) = 1243,35^{\circ}\text{C}$ . At this stage, the insect hibernates until May next year for 8 months.

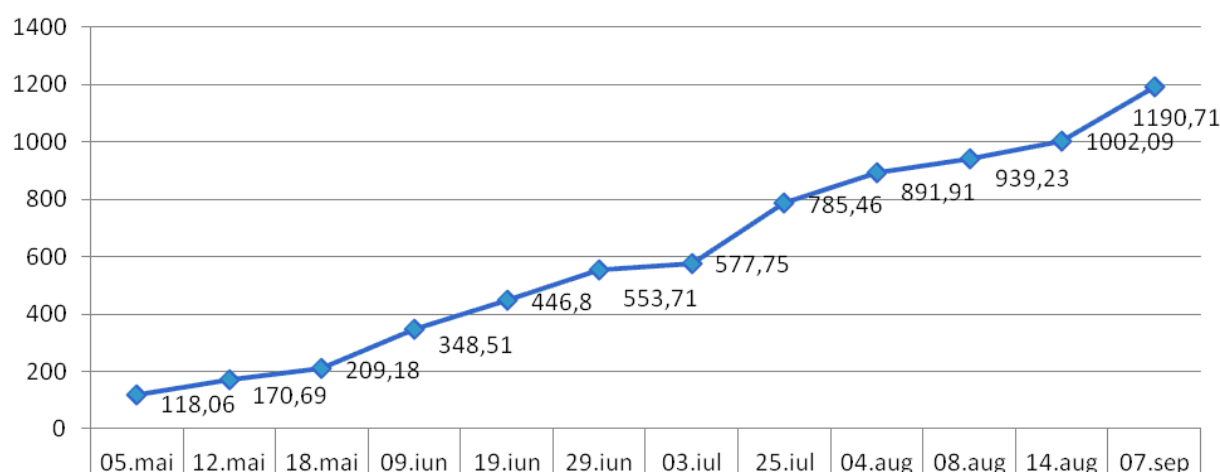


Fig.1. Graphical representation of the first occurrences of the development stages of the chestnut moth in 2014

Table 2. The biological element of the chestnut moth *Cameraria ohridella* Deschka Dimič, In 2014

Year	Generation		
	I	II	III
2014	12 may – 17june	29 june – 04 august	08 august – 10 may

In ecological conditions in the Vaslui area in 2014 (Table 2), the species *Cameraria ohridella* Deschka Dimič has 3 generations, namely: 1st generation (G1) evolved during May 12 - June 23, for 40 days; The second generation (G2) that evolved from June 30 to July 01 for 35 days and the second generation (G3) that evolved from August 8 to May 10, hibernating in the stern stage in fallen leaves on the ground.

The biological cycle of the chestnut moth in the Huși-Vaslui in 2015, area has seen parks and alignments, looking for the appearance of adults, pond deposition, larva and hoop, the duration of each stage of the insect and the sum of effective temperatures for all insect generations.

Adults of the third generation (hyeml) appeared on 10.05, at a  $\Sigma (t_n - t_o) = 85.25^{\circ}\text{C}$  (Table 3).

The butterfly flight and the moonlit moon in May was made heavy by heavy rainfall for 16 days when 179 mm precipitation was recorded, the average deviation was 118.9 mm and the average daily temperatures were relatively small, up to 18 .between 9.6 and 16.20 °C.

After mating and sexual maturation, females began pond deposition on 20.05 at a  $\Sigma (t_n - t_o) = 100.25^{\circ}\text{C}$  and hatched after about 8 days at a mean decay temperature of 20.0°C. Ponta is deposited throughout the flight of the insect, the last eggs were observed on 21.06.

The first V1 larvae appeared on 28.05 on a  $\Sigma (t_n - t_o) = 147.49^{\circ}\text{C}$ , and the stage lasted 24 days at a decade average temperature of approximately 20.0°C. Stage stage was observed on 21.06, at a  $\Sigma (t_n - t_o) = 324.88^{\circ}\text{C}$ , and after 8 days the first butterflies of the generation I appeared on 29.06, at  $\Sigma (t_n - t_o) = 378.77^{\circ}\text{C}$ .

Generation I lasted 40 days (from the first eggs, until the first butterflies).

After sexual maturation and mating, the first generation butterflies deposited the first eggs on the leaves on 05.07, at a  $\Sigma (t_n - t_o) = 427.78^{\circ}\text{C}$ . The incubation lasted about 5 days, the first hirsute larvae appeared on 10.07, at a  $\Sigma (t_n - t_o) = 484.01^{\circ}\text{C}$ . The duration of the larval stage

was 22 days at a decade average temperature of 21.6 - 22.5 °C and a relative humidity of 74%. Starting with 03.08. The first knuckles were recorded, at a  $\Sigma (t_n - t_0) = 736,70^{\circ}\text{C}$ , in the percentage of 20%, and on 05.08 the percentage of the umbilions was 55%, at  $\Sigma (t_n - t_0) = 723,09^{\circ}\text{C}$ . The duration of the pupal stage was 8 days at a mean decay temperature of 24.2°C, so on 11.08, at a  $\Sigma (t_n - t_0) = 833.96^{\circ}\text{C}$ , the first butterflies of the 2nd generation .

The butterflies of the second generation began to plow on 17.08 at a  $\Sigma (t_n - t_0) = 906.95^{\circ}\text{C}$ . The mass deposition of eggs was recorded on 20.08, over 50%. The incubation lasted 5 days, and the first V1 larvae appeared on 22.08, at a  $\Sigma (t_n - t_0) = 949.95^{\circ}\text{C}$ . The duration of the larval stage was approximately 25 days at a decade average temperature of 19.6 °C.

The first knuckles appeared 15. 09, at a  $\Sigma (t_n - t_0) = 1143,25^{\circ}\text{C}$ . Transformation in excess of 50% took place on 20.09, at a  $\Sigma (t_n - t_0) = 1160.19^{\circ}\text{C}$ .

Table 3. The emergence of the first stages of development of *Cameraria ohridella* Deschka Dimič in 2015

Generation	Stage	Date of first appearance	Stage duration (days)	$\Sigma(t_n - t_0)$
G3 (hiemalä)	Adults	10.05	39	85,25 <sup>0</sup> C
G1 40 days	egg	20.05	6	100,25 <sup>0</sup> C
	larvae	28. 05	30	147,49 <sup>0</sup> C
	pupae	19.06	10	315,81 <sup>0</sup> C
	adult	29.06	-	378,77 <sup>0</sup> C
G2 37 days	egg	05.07	5	427,78 <sup>0</sup> C
	larvae	10.07	22	484,01 <sup>0</sup> C
	pupae	03.08	8	736,70 <sup>0</sup> C
	adult	11.08	28	833,96 <sup>0</sup> C
G3 Up to may 2015	egg	17.08	5	906,95 <sup>0</sup> C
	larvae	22.08	20	949,95 <sup>0</sup> C
	pupae	15. 09	212	1143,25 <sup>0</sup> C

$\Sigma(t_n - t_0)$

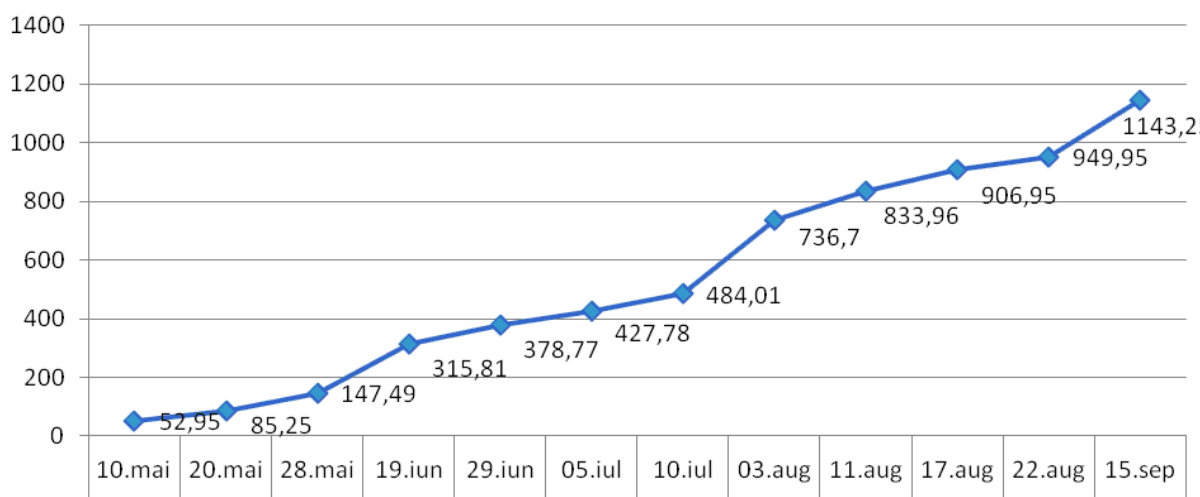


Fig. 2. The graphical representation of the first occurrences of the development stages of the *Cameraria ohridella* Deschka Dimič mining mould in 2015

Table 4. The biological cycle of the chestnut moth *Cameraria ohridella* Deschka Dimič in 2015

Year	Generation		
	I	II	III
2015	20 may – 29 june	05 july – 11 august	17 august – 08 may

Under ecological conditions in the Husi - Vaslui area in 2015, the species *Cameraria ohridella* Deschka Dimič has three generations, namely: the 1st generation (G1) evolved during May 20 - June 29, for 40 days; The second generation (G1) that evolved between July 5 and August 11, for 37 days and the second generation (G1) that evolved during August 17 - May 8.

### Conclusions

In the Husi area, in the four years of observation, the species *Cameraria ohridella* Deschka Dimič shows that every year the insect presents three generations per year and ate in the aft stage in a silky cocoon: generation I - May - June; 2nd generation - July - August Generation II - August - May.

The duration of one generation ranged from 40 days to the first generation and 33 to 35 days to the second generation.

The period from the appearance of the first butterflies to the first eggs is 7 to 10 days, during which sexual maturation and copulation take place.

Eggs are always deposited on mature, mature leaves, never on the barely emerging leaves; The sum of actual temperatures,  $\Sigma (t_n - t_0)$ , required for the pint deposition is above 100°C;

The mining mine needs the spring for butterflies with a lower threshold of  $t_0 = 12^\circ\text{C}$  and a sum of effective temperatures,  $\Sigma (t_n - t_0) \Rightarrow 70^\circ\text{C}$ .

Incubation takes 3 to 10 days depending on temperature and relative air humidity.

Stage of larvae lasts between 20 and 25 days, depending on the temperature and relative air humidity, and the aft stage is 8 to 10 days.

Under the conditions of the Huși area, hibernates from September to May next year for 8 months.

### References

- Beratlief C., Şesan T. (1998). Chestnut miner moth-*Cameraria ohridella* – potentially harmful for chetnut in Romania. Plant Protection Magazine, XI(31): 53-62.
- Georgescu T., Bernardis R. (2005). Spread, damage and measures to prevent and control chestnut leaf mining moth – *Cameraria ohridella* Deschka-Dimic (Lepidoptera - Gracillariidae). Scientific Works - Horticulture Series, 48: 1454-7376.
- Ianovici Nicoleta, et al, (2012). Study on the infestation by *Cameraria ohridella* on *Aesculus hippocastanum* foliage from Timișoara, Annals of West University of Timișoara, ser. Biology, 2012, vol XV (1), pp.67-80.
- Oltean I. et al 2015- Results on Parasitic Level of Larvae and Pupae of *Cameraria ohridella* Deschka-Dimić, Bulletin USAMV series Agriculture 72(1)/2015 Print ISSN 1843-5246; pag. 187-192
- Perju T., et al (2001). Expanding the spreading area of the orchard chestnut moth - *Cameraria ohridella* Deschka-Dimic: identification, biology and the control method. Proplant, Oltchim S.A, 133-144.
- Perju, T., et al (2004). The pests of horse chestnut tree – *Aesculus hippocastanum* L. in Romania. Journal of Central European Agriculture 4 (5): 331 – 336.  
([https://www.eppo.int/.../Cameraria\\_ohridella.do](https://www.eppo.int/.../Cameraria_ohridella.do)).

## EFFECT OF SOME HERBICIDES ON CELLULOSE DECOMPOSITION IN THE SOIL

Dragutin ĐUKIĆ<sup>1</sup>, Aleksandra STANOJKOVIĆ-SEBIĆ<sup>2</sup>, Leka MANDIĆ<sup>1\*</sup>, Marijana PEŠAKOVIĆ<sup>3</sup>, Vesna ĐUROVIĆ<sup>1</sup>, Milica ZELENKA<sup>1</sup>, Ivana BOŠKOVIĆ<sup>4</sup>

<sup>1</sup>University of Kragujevac, Faculty of Agronomy, Cara Dušana 34, 32000 Čačak, Serbia

<sup>2</sup>Institute of Soil Science, T. Drajzera 7, 11000 Belgrade, Serbia

<sup>3</sup>Fruit Research Institute Čačak, Kralja Petra I 9, 32000 Čačak, Serbia

<sup>4</sup>Faculty of Agriculture, University of East Sarajevo, V. Karadžića 30, 71126 Lukavica, Republic of Srpska

\*Corresponding author: lekamg@kg.ac.rs

### Abstract

The effect of simazine (62, 125, 250 and 500 µg/g soil), paraquat (37, 75, 150 and 300 µg/g soil) and 2,4 D (87, 175, 350 and 700 µg/g soil) on cellulose decomposition in two soils (sandy soil and chernozem) was studied. Simazine and 2,4 D were mixed with soil and cellulose (2% powdered cellulose) before humidification, whereas paraquat was introduced into the soil along with water during humidification. The soil receiving no pesticide treatment was the control. The modelled soil samples were incubated in a thermostat at 28 °C for 12 weeks. The amount of water that vaporized was added to the soil on a weekly basis.

Results showed that simazine rates had a slight inhibitory effect on cellulolytic activity in the tested soils. Only the highest rate of 2,4 D caused a considerable degree of inhibition of cellulose decomposition. Paraquat exhibited a higher level of toxicity compared to simazine and 2,4 D. As even the lowest application rates were several times greater than the rates commonly used in agricultural practice, the herbicides tested, when applied at recommended rates, cannot be inhibitory factors in cellulose transformation in these soils.

**Key words:** *herbicides, cellulolysis, soil, microorganisms.*

### Introduction

Research on the effect of different chemical crop protection agents on microbial communities in the soil is of high theoretical and practical importance. Effects of pesticides under soil conditions are quite different from those under laboratory conditions.

On the one hand, some microbial populations have the ability to degrade pesticides and use them as sources of biogenic elements and energy required for physiological processes (Janjić *et al.*, 1996; Regno *et al.*, 1998; Singh, 2008). On the other hand, pesticides can change the biodiversity, activity and rhythm of reproduction of microorganisms (Johansen *et al.*, 2001).

In agricultural ecosystems, herbicides are subjected to transformation and degradation processes, and constantly interact with soil microorganisms. Increasing consideration has been given to the quantitative and qualitative composition of microorganisms and their enzymatic activity as soil quality indicators which are, in agricultural soils, correlated with the herbicide application rate (Zain *et al.*, 2013).

Many authors have studied the effect of pesticides on cellulose decomposition (Szegi, 1972; Malkomes, 1977; Mandić and Đukić, 2007; Baldrian *et al.*, 2011). The application of Paraquat above its recommended label rate reduced cellulose degradation and soil respiration by 39-58%. The degree of inhibition decreases with increasing content of organic matter in the soil i.e. its increasing sorption (Bromilow, 2003). In study on the effect of herbicides (butachlor, pyrozosulphuran, paraquat and glyphosate) on the organic carbon content of the

soil, microbial biomass and activities of the enzymes (amilase, invertase, protease, urease and dehydrogenase), Baboo *et al.* (2013) found a decrease in organic carbon content and microbial biomass in the soil. Many studies have proven that paraquat is active only when it comes in direct contact with the plant, while in the soil it occurs in a strongly bound form (Bromilow, 2003). In field trials, normal rates of paraquat increase the numbers of bacteria, fungi and actinomycetes, whereas high rates are toxic to fungi (Camper *et al.*, 1973). Simazine can lead to changes in the bacterial community structure; however, some bacteria can become involved in simazine biodegradation, and autochthonous microbial communities can metabolize high rates of simazine in agricultural soils (Wan *et al.*, 2014).

The transformation of the cellulose incorporated in the soil in the presence of crop protection agents is dependent on soil texture, humus content, soil pH, the amount of uptakeable nutrients and other factors (Schröder, 1979; Malkomes, 1993). This finding has been confirmed by Ayansina and Oso (2006) through their analysis of the effect of atrazine on organic matter content, soil pH and microbial numbers in the soil.

Manure stimulates cellulose decomposition and detoxification of the abovementioned pesticides as it provides sufficient amounts of nutrients for the massive reproduction of soil microorganisms. Compost and biohumus are additional sources of simazine-degrading microorganisms (Błaszak *et al.*, 2011).

Therefore, non-judicious use of pesticides can affect transformation processes in the soil, primarily the degradation of crop residues. Fresh organic residues originating from plants, animals and microorganisms (biomass) undergo transformation, leading either to their complete mineralization or partially degraded substances which directly or indirectly make up humus. The degree of transformation is dependent on the type of plant material, temperature, water content and the activity of the microbial populations present in the soil. Cellulose, lignin and chitin are the three most common soil biopolymers. Micromycetes exhibit pronounced cellulolytic and chitinolytic activities which make them actively involved in the transformation of cellulose and dead biomass of different soil organisms, which are important sources of soil carbon (Baldrian *et al.*, 2011).

The aim of this study was to examine the effect of herbicides (simazine, paraquat and 2,4 D) on cellulose decomposition in sandy and chernozem soils.

### Material and methods

A model trial was established to determine the effect of pesticides on cellulose transformation in the soil. In the experiment, 2% powdered cellulose was homogenously mixed into 200 g sandy soil (pH<sub>KCl</sub> 6.4; humus-1.7%; N-0.1%; P<sub>2</sub>O<sub>5</sub>-0.068 mg g<sup>-1</sup>; K<sub>2</sub>O- 0.1 mg g<sup>-1</sup>) and chernozem (pH<sub>KCl</sub> 7.2; humus-3.07%; N-0.2%; P<sub>2</sub>O<sub>5</sub>-0.37 mg g<sup>-1</sup>; K<sub>2</sub>O- 0.22 mg g<sup>-1</sup>), and then the treated soil sample was humidified to a moisture content of 60% of maximum water holding capacity. The effect of the herbicides simazine (2-chloro-4,6-bis(ethylamino)-s-triazine), paraquat (dichloro-1,1-dimethyl-4,4-bipyridine) and 2,4 D (2,4-dichlorophenoxyacetic acid) was evaluated. Simazine was applied at 62, 125, 250 and 500 µg/g soil, paraquat at 37, 75, 150 and 300 µg/g soil, and 2,4 D at 87, 175, 350 and 700 µg/g soil in three replicates. Simazine and 2,4 D were mixed with the soil and cellulose before humidification, whereas paraquat was introduced into the soil along with water during wetting. The soil without pesticide treatment was the control. The modelled soil samples were incubated in a thermostat at 28 °C for 12 weeks. The amount of water that vaporized was added to the soil on a weekly basis. The amount of transformed cellulose was determined by the method described by Petkov and Markova (1969). The results obtained were subjected to an analysis of variance. The importance of differences in the level of cellulose degradation (%)

for each individual soils, as dependent on the herbicide application rate, was assessed by LSD test (Statistica SPSS 5).

### Results and Discussion

As shown in Table 1, the three herbicides affected the percent decomposition of powdered cellulose mixed with soil samples, and different results were obtained. No simazine application rate had a significant inhibitory effect on cellulase activity. Similar findings were recorded for 2,4 D, although its highest rates (700 µg/g) inhibited cellulose decomposition by about 17% compared to the control. Paraquat was much more toxic than the other herbicides. The two highest rates (150 and 300 µg/g soil) had a significantly depressive effect on cellulose decomposition. The rate of 300 µg/g soil caused a reduction in cellulose decomposition by about 20% compared to the same process in the control soil. The two lowest rates (37 and 75 µg/g soil) did not prevent cellulose decomposition. Although even the lowest application rates were several times greater than the rates commonly used in agricultural practice, the recommended rate of paraquat in the soil is not an inhibitory factor in cellulose transformation processes. In this regard, as reported by Bromilow (2003), paraquat applied at high rates (1300 mg kg<sup>-1</sup>) had no detrimental effect on cellulose decomposition in the soil; when used at recommended rates, it had no effect on bacterial and fungal activities in the soil. The adverse impact of paraquat on soil organisms is minimized through its high sorption by soil particles. Whitelaw-Weckert *et al.* (2004) observed that it is impossible to determine whether changes in soil microbial population are directly associated with pesticide use or with the indirect effect of pesticides manifested through reduced amounts of organic matter and rhizosphere exudates.

In contrast, Adomako and Akyeampong (2016) found significant changes in the growth and development of soil microorganisms as induced by atrazine, 2,4 D, glyphosate and paraquat applications. The toxic effect of some herbicides was observed immediately after their use, and paraquat treatment had a long-lasting effect on most microorganisms. Microorganisms respond to herbicides in a variety of ways, depending on herbicides themselves, their concentrations, exposure time, chemical and physical soil characteristics, and properties of the microbial populations present in the soil.

Tab.1. Effect of some herbicides on cellulose decomposition in the soil

Herbicides	µg active ingredient per 1g soil	Cellulose decomposition, % relative to the control	
		Sandy soil	Chernozem
Control	-	100 ab	100 ab
Simazine	62	105 a	97 c-f
	125	94 b	92 ef
	250	98 ab	96 def
	500	97 ab	94 def
Paraquat	37	97 ab	105 abc
	75	98 ab	108 a
	150	84 c	90 f
	300	79 c	71 g
2,4 D	87	100 ab	101 a-d
	175	99 ab	107 ab
	350	94 b	99 b-f
	700	83 c	91 f

Means followed by the same lowercase letters in rows are not significantly different ( $p > 0.01$ ) according to LSD test

As the herbicide rate increased, the percentage of cellulose decomposition slightly decreased relative to the control in both soils (sandy soil and chernozem), which was consistent with the reports of many authors on the inhibitory effects of triazine, dinitroaniline and phenoxyacetic acid derivatives on total microbial count, bacterial biodiversity, microbial biomass and enzyme activity (Ayansina and Oso, 2006; Šantrić *et al.*, 2015).

The percentage of cellulose decomposition slightly decreased with increasing simazine rate in both sandy soil and chernozem, most likely due to the effect of simazine on soil microorganisms (Harden *et al.*, 1993; Kodoma *et al.*, 2001).

### Conclusion

The results of this research suggest the following:

- simazine application rates had a slightly inhibitory effect on cellulolytic activity in the soils tested;
- only the highest rate of 2,4 D was significantly inhibitory to cellulose decomposition in both soils;
- paraquat showed a much higher level of toxicity compared to simazine and 2,4 D;
- as even the lowest application rates were several times greater than the rates commonly used in agricultural practice, the herbicides tested, when applied at recommended rates, cannot be inhibitory factors in cellulose transformation processes in these soils.

**Acknowledgement:** This study is part of the project “Improvement of the genetic potential of forage crops and production technologies towards the sustainable development of animal husbandry” – TR 31057 funded by the Ministry of Education and Science, Republic of Serbia.

### References

- Adomako M.O., Akyeampong S. (2016). Effect of Some Commonly Used Herbicides on Soil Microbial Population Journal of Environment and Earth Science, 6(1): 30-38.
- Ayansina A.D.V., Oso B.A. (2006). Effect of two commonly used herbicides on soil microflora at two different concentrations. African Journal of Biotechnology, 5(2): 129-132.
- Baboo M., Pasayat M., Samal A., Kujur M., Maharana K.J, Patel A.K. (2013). Effect of four herbicides on soil organic carbon, microbial biomass-C, enzyme activity and microbial populations in agricultural, International Journal of Research in Environmental Science and Technology, 3(4): 100-112.
- Baldrian P., Voříšková J., Dobiášová P., Merhautová V., Lisá L., Valášková V.. (2011). Production of extracellular enzymes and degradation of biopolymers by saprotrophic microfungi from the upper layers of forest. Plant Soil, 338: 111–125.
- Błaszak M., Pelech R., Graczyk P. (2011). Screening of Microorganisms for Biodegradation of Simazine Pollution (Obsolete Pesticide Azotop 50 WP), Water Air Soil Pollut, 220: 373–385.
- Bromilow R.H. (2003). Paraquat and sustainable agriculture, Biological Chemistry Division, Rothamsted Research, Harpenden, Herts, AL5 2JQ, UK, Pest Management Science Pest Manag Sci, 60: 340–349.
- Camper N.D., Moherek E.A., Huffman J. (1973). Changes in microbial populations in paraquat-treated soils, Weed Research, 13: 231-233.

- Harden T., Joergenses R.G., Mayer B. and Wolters, V. (1993). Soil microbial biomass estimated by fumigation-extraction and substrate-induced respiration in two pesticide-treated soils. *Soil Biol. Biochem.*, 25: 679-683.
- Janjić V., Radivojević Lj., Stanković-Kalezić R. (1996). The effect of herbicides on the microbiological activity of the soil. *Acta herbol.*, 5: 5-17.
- Johansen K., Jacobsen C.S. and Torsvik V. (2001). Pesticide effects on bacterial diversity in agricultural soils – a review. *Biol. Fert. Soils*, 33: 443-453.
- Kodoma T., Ding L., Yoshida M., Yajima M. (2001). Biodegradation of s-triazine herbicide, simazine. *J. Molecular Catalysis*, 11: 1073-1078.
- Malkomes H.P. (1977). Decomposition of cellulose and straw in different soils after herbicide applications, In: *The Interaction of Soil Microflora and Environmental Pollutions. Intern. Symposium. Pulawy*, 211.
- Malkomes H.P. (1993). Effect of pesticides used for seed treatment of potatoes on microbial activities in soil. *Zentralblatt Fur Mikrobiologie*, 148(7): 497-504.
- Mandić L., Đukić D. (2007). Microbiological Purification of Soils Contaminated with Pesticides. *Bulletin of the Republic Institution for the Protection of Nature in Podgorica*, No. 29-30: 175-182.
- Petkov P.D., Marcova T.Ch. (1969). A method of studying cellulose decomposition in soils. *Biologii du Sol. Int. News Bull.*, Paris/N10, pp. 17-20.
- Regno V., Arulgnanendran J., Nirmalakhandan N. (1998). Microbial toxicity in soil medium. *Ecotox. Environ. Saf.*, 39: 48-56.
- Šantrić Lj., Radivojević Lj., Gajić-Umiljendić J., Sarić-Krsmanović M., Đurović R. (2015). Influence of Glyphosate on microbiological activity of different types of soil. XIII Symposium with Plant Protection, Zlatibor, 23-26. November, Proceedings, 93-94.
- Schröder D. (1979). The influence of agrochemical compounds on the decomposition of straw and cellulose in soil. *Journal of Plant Nutrition and Soil Science*, 141(4): 616-625.
- Singh D.K. (2008). Biodegradation and bioremediation of pesticides in soil concept method and recent developments. *Ind. J. Microbiol.*, 48: 35-40.
- StatSoft.Inc. (1995). *STATISTICA for Windows (computer program manual)*. Tulsa. OK: StatSoft.Inc.
- Szegi J. (1972). Effect of few herbicides on the decomposition of cellulose. In: *Proc. Symposium Soil. Microbiol.* J. Szegi, (ed.), Akademiai Kiado, Budapest, Vol. 11, p. 349-354.
- Wan R., Wang Z., Xie S. (2014). Dynamics of communities of bacteria and ammonia-oxidizing microorganisms in response to simazine attenuation in agricultural soil. *Science of the Total Environment* 472: 502-508.
- Whitelaw-Weckert M., Hutton R., Rouse E., Lamont R. (2004). The effect of herbicides and permanent swards on soil microbial populations in the vineyard, SuperSoil 2004: 3rd Australian New Zealand Soils Conference, 5 – 9 December 2004, University of Sydney, Australia.
- Zain N.M.M., Mohamad R.B, Sijam K., Morshed M.M., Awang Y. (2013). Effect of selected herbicides in vitro and in soil on growth and development of soil fungi from oil palm plantation. *Int. J. Agric. Biol.*, 15: 820-826.



## THE ORIGIN AND CONTENT OF Ni IN VERTISOL FROM SERBIA AND PLANTS AVENA SATIVA L.

Jelena MILIVOJEVIĆ<sup>1\*</sup>, Vera ĐEKIĆ<sup>1</sup>, Ljiljana BOŠKOVIĆ RAKOČEVIĆ<sup>2</sup>, Zoran  
SIMIĆ<sup>3</sup>, Kristina LUKOVIĆ<sup>1</sup>

<sup>1</sup>Small Grains Research Centre, Save Kovacevica 31, Kragujevac, Serbia

<sup>2</sup>University of Kragujevac, Faculty of Agronomy, Cara Dusana 34, 32000 Cacak, Serbia

<sup>3</sup>University of Kragujevac, Faculty of Science, Institute of Hemistry, Kragujevac, Serbia

\*Corresponding author: milivojevic54@gmail.com

### Abstract

This paper presents the results of 10 representative samples of Vertisols collected from different land use of ten locations in Serbia (meadows and arable land). The following basic chemical properties were examined: active soil acidity (pH in H<sub>2</sub>O), substitutional acidity (pH in 1M KCl), CaCO<sub>3</sub> content, humus content, content of available forms of phosphorus and potassium, content of clay, CEC, content sand and silt. The paper shows the characteristics, origins, behaviour and content of total and available nickel in the soil and nickel in plants *Avena sativa* L. Average value of the total nickel content of the soil samples was above the MAC (50 mg kg<sup>-1</sup>), and amounts to 54.89 in the soil from the arable land and 56.11 mg kg<sup>-1</sup> of the soil from a meadow, while the average value of readily available nickel was 2.96 mg kg<sup>-1</sup> in the soil from the arable land and 2.88 mg kg<sup>-1</sup> in the meadow land.

The share of available nickel in total nickel was a good indicator of the origin of soil contamination. Since it is determined a percentage of the readily available form in the total nickel (5.45 % in the arable land and 6.04 % from a meadow) is determined, it may be concluded that the Ni content in the soils of Serbia is of natural origin and that there is no danger of input of the elements in the food chain.

**Key words:** *Vertisol, chemical properties soil, plants, nickel*

### Introduction

The contamination of ecosystems may result in phytotoxic and negative effects of heavy metals on the quality of plant products. Heavy metals in the soil are primarily of geochemical i.e. lithospheric origin, and their concentrations in the soil are dependent on their content in the rocks from which the soil parent material has been derived (Ubavić et al., 1995). However, more recently, industrial development and agricultural intensification have led to the use of various substances which contaminate the soil, thus causing an increase in the concentrations of heavy metals in some areas of land due to anthropogenic activities. Recent research has pointed to the increasing presence of heavy metals in agricultural soils (Markoski et al., 2011), which have been additionally threatened by the increasing and improper use of chemicals, waste waters, sewage, sludge and mineral fertilizers. Normal Ni levels range from 2 to 750 mg/kg for soil, and from 0.02 to 5 mg/kg for plant material (Alloway, 1995). In the samples of soil, type Fluvisol, Ni content ranged from 265.70 to 286.05 mg/kg (Jaksić et al., 2013).

The behavior of heavy metals in the soil is governed by a multitude of factors that may affect their mobility and accumulation by plants, the major ones including soil reaction, organic matter content and colloidal clay content (Pelivanoska, 2011). Soil pH has a decisive effect on

Ni mobility and availability in the soil. As soil pH increases from 4.5 to 6.5, the oat kernel Ni content decreases about eight times (Kabati-Pendias, 2011).

Most toxic elements typically react with different organic compounds to form stable complexes with ligands which contain electron-donating oxygen, sulfur or nitrogen atoms. Soil organic matter comprises a large number and variety of functional groups and has high CEC values, resulting in enhanced heavy metal retention ability, mostly through surface complexation, ion exchange, and surface precipitation (Bradl, 2004; Mihaljev et al., 2008).

The toxic effect of elements is based on their irreversible binding to metabolically active groups in amino acids, polypeptides and proteins (Mihaljev et al., 2008). It is generally understood that toxic elements primarily affect the cell membrane, whereas their secondary effects in most cases include damage to the enzymatic systems inside the cell (Milošević and Vitorović, 2008). Heavy metals enter the food chain through plants, and exhibit cumulative properties in the human body by accumulating in some organs or tissues, where they show their harmful effects. Adverse Ni effects range from skin irritation to nervous system damage, in addition to carcinogenic effects.

Cereal crops (oats, barley and triticale) are annual plants considered to be the leading and most important field forage crops for high-quality feed production, used for fresh cut forage or preserved as hay, silage and flour.

The objective of this study was to evaluate factors that affect the behavior and bioavailability of nickel in vertisols of Serbia, to determine total and readily available levels of this heavy metal, and assess its origin and potentially deleterious effects on the environment and plants.

### Materials and methods

Samples were taken from Vertisol in the Ap horizon at ten different locations in Serbia: 1) Milutovac, 2) Priština, 3) Trnava, 4) Rekovac, 5) Vranje (Neradovac), 6) Zaječar, 7) Bela Crkva, 8) Blace, 9) Salaš and 10) Kragujevac. Sub-samples were taken from arable land and meadow ecosystems, from a depth of 0 to 20 cm, after which they were air-dried and crushed in a porcelain mortar up to particles of 2 mm in size. The basic physical and chemical properties of soil were determined using standard methods (Soil. Sci. Yug., 1966). Soil pH was determined in a suspension with water and 1M KCl mixture, with the ratio of soil/solution 1:2.5 after a 0.5 - hour equilibration period; the organic content was determined using the humus method by Kotzmann, the available P<sub>2</sub>O<sub>5</sub> and K<sub>2</sub>O content was determined using the Al method by Egner-Riehm, CEC was determined using the method with 1 M NH<sub>4</sub>OAc, pH 7, and particle size distribution was determined by a pipette method (YSSS, 1966) The pseudo-total content of nickel was determined by atomic adsorption spectrophotometry (AAS, model Perkin–Elmer 3300/96, MHS-10) (Ure, 1995), after digested soil concentration. HNO<sub>3</sub> and then treated with 30 % H<sub>2</sub>O<sub>2</sub>. The content of the available nickel was determined by AAS spectrophotometry, after the extraction with 0.005 M DTPA (Lindsay and Norvell, 1978). In addition a vegetation experiment in pots was performed in Vertisol taken from 10 above mentioned locations. Soil samples, taken from arable land and meadows from a depth of 0-20 cm first air dried, ground and the size of particles of soil samples used in the vegetation experiment was determined. For these tests was taken control variant without fertilization.

The experiment was conducted using “Slavuj” oats (*Avena sativa* L) cultivated with 15 seeds per pot u triplicate; after two weeks the plants were thinned to ten seedlings per pot. The plants were followed 45 days in controlled laboratory conditions. Water was added to obtain optimal humidity. After 45 days the plants were dug up, rinsed with destiled water, and dried at room temperature in a dryer at t=70°C. The dried plants were ground into a powder.

Content of Ni in oats was determined by AAS method, after digestion with HNO<sub>3</sub>-HClO<sub>4</sub> with 30% of H<sub>2</sub>O<sub>2</sub>.

### Results and discussion

The analyses have shown that the samples taken from 10 localities in Serbia were considerably differing regarding their physical and chemical properties (Table 1).

The reaction of soil was found to range in a fairly wide interval of pH values from acid to weakly alkaline reaction (from 4.60 to 6.9 in N KCl). The content of humus was considerably varying, ranging from 2.00 to 5.6% (weakly humus to humus soils), being unaffected by land use. In addition, the content of available phosphorous also ranged in a wide interval. Thus, on the vertisol under meadow, the content of available P ranged from 0.8 to 17.8 mg/100g, whereas on those under field, its content ranged from 0.6 to 28 mg/100g. According to the content of the available P, the Vertisol in question are low to medium supplied with this element. In contrast to the available phosphorous, the soils were found to be rich in potassium (19.0-59.6 mg/100g). In addition, these soils indicated a high cation exchange capacity and, by mechanical composition, could be defined as medium to heavy clay soils. The above-mentioned average values of the investigated properties proved to be very much the same for the arable land and for the meadow vertisol.

**Table 1** Examined physical-chemical characteristics of Vertisols in Serbia

Soil characteristic	Arable land			Meadow		
	Mean	Range	Standard deviation	Mean	Range	Standard deviation
pH (H <sub>2</sub> O)	7.11	5.8–8.1	0.91	6.9	5.6-8.1	0.9
pH (KCl)	6.0	4.6-6.9	0.93	5.8	4.7-7.0	0.9
Humus, %	3.3	2.5-4.0	0.49	3.5	2.0-5.6	1.1
P <sub>2</sub> O <sub>5</sub> mg/100 g	7.7	0.6-28.0	8.83	4.2	0.8-17.8	5.0
K <sub>2</sub> O mg/100 g	34.4	19.0-59.6	11.8	31.1	20.4-53.5	10.4
CEC meq/100g	25.1	15.5-31.5	5.57	23.8	16.9-34.7	6.6
Sand, %	29.6	21.4-36.0	4.80	32.2	22.3-50.5	9.0
Silt, %	24.6	18.8-31.2	3.61	22.8	11.9-29.4	5.6
Clay, %	45.8	33.5-54.4	7.25	44.9	28.9-64.3	11.1
Silt + Clay, %	70.4	64.0-78.6	4.8	67.7	49.5-77.7	9.0
t-test	NS	NS	NS	NS	NS	NS

t-test field:meadow; NS-application of the student t-test showed that there is no statistical significance between the examined characteristics of field and meadow

Nickel concentrations in the tested soils were highly variable, as the result of the soil parent material (Romić and Romić, 2003). Nickel is essential for plant growth and Fe resorption. However, elevated levels of nickel can disturb life processes, by causing chlorosis, intercostal necrosis and root growth retardation. The average Ni content in plants is 0.1–5.0 mg/kg dry matter. Nickel occurs in the soil as sulfate, copper and silicate minerals at concentrations of 5–500 mg/kg (Kastori et al., 1997). Elevated Ni levels are found in soils formed on serpentine rocks, but may also be due to anthropogenic activities associated with the use of sewage sludge, fertilizers, liquid manure and pesticides, or due to the vicinity of industrial plants, mines and other pollutants (Bogdanović, 2007).

High concentrations of Ni in the environment are toxic to all living organisms. As the soil is the main source of Ni for plants, either as a nutrient or toxicant, the determination of its availability is of high importance. Microelements are uptaken from the soil in small amounts, but at concentrations exceeding optimal levels they can have a harmful effect on plant growth and development. Ni levels in some soil samples were above the maximum permissible

concentration (MPC >50 mg kg<sup>-1</sup>, Official Gazette of the RS, Issue 23/1994). Total nickel ranged from 21.1 mg kg<sup>-1</sup> to 145.0 mg kg<sup>-1</sup> in arable soil samples, and from 14.0 mg kg<sup>-1</sup> to 139.0 mg kg<sup>-1</sup> in meadow soil samples, and exceeded the maximum permissible concentration in two locations. The mean value of the pseudo-total concentration of nickel for all arable land and meadow soil samples was 54.89 mg kg<sup>-1</sup> and 56.11 mg kg<sup>-1</sup>, respectively, which was somewhat above the maximum permissible concentration (Tab. 2).

**Table 2** Content of total, available nickel, % of readily available out of total nickel, and Ni concentration in Plants in observed Serbian vertisol

Mode of soil utilisation	Total Ni mg/kg	Available Ni mg/kg	% of readily available out of total Nickel	Ni Concentration in Plants
Arable land	54.89±35.72	2.96±2.11	5.45±1.70	4.92±1.55
	21.1-145.0	1.14-7.88	2.79-8.02	3.17-8.33
Meadow	56.11 ± 37.00	2.88 ± 1.57	6.04±2.95	4.69±1.49
	14.00 - 139.00	0.84 - 5.90	2.15-11.97	2.67-7.67

In soil samples taken from the arable soils, the coefficients of correlation between total Ni content and main soil properties showed that Ni values largely correlated with phosphorus (r=0.54\*), followed by humus (r=0.49\*), CEC (r = - 0.43\*) and silt (r=-0.50\*). Soil organic matter is known to exhibit a large number and variety of functional groups and high CEC values, which results in enhanced heavy metal retention ability, mostly through surface complexation, ion exchange, and surface precipitation. In meadow Vertisol samples, Ni was found to correlate with pH<sub>H2O</sub> (r=-0.41\*), pH<sub>KCl</sub> (r=-0.42\*), clay (r=0.56\*) and silt (r=-0.50\*) contents, and understandably so, since both soil fractions clay and CEC contribute to the total cation exchange capacity of the soil through their individual capacities (Tab.3). To determine the origin of increased levels of nickel in the soils and to assess the risk of this heavy metal entering the food chain on agricultural soils, the soil content of readily available Ni was measured. Readily available Ni concentrations in soil samples ranged between 1.14 mg kg<sup>-1</sup> and 7.88 mg kg<sup>-1</sup> for arable land soil, averaging 2.96 mg kg<sup>-1</sup>, and between 0.84 mg kg<sup>-1</sup> and 5.90 mg kg<sup>-1</sup> for meadow soil, averaging 2.88 mg kg<sup>-1</sup> (Tab. 2) The very low concentrations of readily available Ni indicate the geochemical i.e. natural origin of total Ni derived from the parent material. The results are consistent with the results of other authors. Dozet et. al (2011) reported that the amount of available DTPA-Ni in fluvisol in the interval 0.337 – 4.826 mg/kg, while in cambisol interval is 2.9 -6.9 mg/kg.

**Table 3** Correlation coefficients between total Ni concentration in the soil and plants and its available content in soil and some chemical and physical properties of soil

	Available Ni(DTPA)	pH		Humus (%)	Available		CEC	Clay	Silt
		H <sub>2</sub> O	KCl		P <sub>2</sub> O <sub>5</sub>	K <sub>2</sub> O			
Field									
Total Ni	0.88**	NS	NS	0.49*	0.54*	NS	- 0.43*	NS	- 0.50*
Ni conc. in plants	0.53*	-0.36*	-0.43*	NS	NS	NS	NS	NS	NS
Meadow									
Total Ni	0.41*	0.41*	0.42*	NS	NS	NS	NS	0.56*	-0.50*
Ni conc. in plants	0.70**	- 0.52*	- 0.53*	NS	NS	NS	NS	NS	NS

NS- No statistically significant differences; \*Significant at the 0.05 probability level; \*\* Significant at the 0.01 probability level

The percent contribution of available nickel to total nickel is a good indicator of soil pollution i.e. if this ratio is low, Ni is generally of natural origin (Romić and Romić, 2003). The mean relative amount of Ni, as determined by extraction with 0.005M DTPA, was 5.45 % in arable land soil samples, and 6.044 % in meadow soil samples, which was indicative of its geochemical origin (Tab.2). These values were consistent with previous results (Elrashidi et al., 1979, Valdares et al., 1983, Antić-Mladenović., 2004). As estimated from the presented data, Ni availability in soil samples collected from both ecosystems was not high.

The average critical concentration of Ni in crops is 20 mg/kg, and the average toxic level is 30 mg/kg dry matter (Kastori et al., 1997). Ni content in the tested plants grown on Vertisol samples was far below these values. The average Ni content in oat shoots from the control group was 4.92 mg/kg (range 3.17-8.33 mg/kg) for arable soil samples, and 4.69 mg/kg (range 2.67-7.67 mg/kg) for meadow soil samples (Tab.2).

The analysis of the correlation coefficients showed that the content of Ni in plants was significantly positively correlated with DTPA-extractable Ni ( $r=0.53^*$ ),  $pH_{H_2O}$  ( $r=-0.36^*$ ) and  $pH_{KCl}=-0.43^*$  on arable soil, and with DTPA-extractable Ni ( $r=0.70^{**}$ ),  $pH_{H_2O}$  ( $r= - 0.52^*$ ) and  $pH_{KCl}= -0.53^*$  on meadow soil, indicating the dependence of Ni mobility and accumulation by plants on soil reaction and available Ni levels. Similar findings were presented by Chhotu and Fulekar (2008) in a study on Ni uptake by alfalfa plants, showing that Ni concentrations in plants increased proportionally to the increase in DTPA-extractable Ni in the soil. Furthermore, comparable results on the dominant effect of soil pH were reported elsewhere (Echevarria et al., 2006).

### **Conclusion**

Total nickel ranged from 21.1 mg kg<sup>-1</sup> to 145.0 mg kg<sup>-1</sup> in arable soil samples, and from 14.0 mg kg<sup>-1</sup> to 139.0 mg kg<sup>-1</sup> in meadow soil samples, and exceeded the maximum permissible concentration (50 mg/kg, Official Gazette of the RS, 23/1994) in two locations. Nickel mobility and accumulation by oat plants were dominantly affected by soil pH and DTPA-extractable Ni content. Regardless of the mostly geochemical origin of nickel in the tested Vertisols, due to which its forms in the soil exhibit low mobility and, hence, low availability to plants, continuous monitoring of the levels of nickel, as well as of other heavy metals, is required.

### **Acknowledgements**

Investigations necessary for this papers are part of the project TP 31054 "Development of new cereals cultivation technologies on acid soils by usage of modern biotechnology", financed by the Ministry of Education, Science and Technology Development of Republic of Serbia.

### **References**

- Alloway B.J. (1995): Heavy Metals in Soils, second ed. Blackie Academic and Professional, Glasgow
- Antić-Mladenović S. (2004): Chemistry of nickel and chromium in the soil with their naturally high contents. Doctoral dissertation, Faculty of Agriculture, Belgrade.
- Bogdanović D. (2007): Sources of pollution of land by nickel. Yearbook of scientific papers, 21–28.
- Bradl, H. B. 2004. Adsorption of heavy metal ions on soils and soils constituents. Journal of Colloid and Interface Science, 277, 1-18.
- Chhotu D.J., Fulekar M.H. (2008): Phytotoxicity and remediation of heavy metals by alfalfa (*Medicago sativa*) in soil-vermicompost media, Adv. Nat. Appl. Sci. 2, 141–151.

- Echevarria G., Massoura S.T., Sterckeman T., Becquer T., C. Schwartz C., Morel J.L. (2006): Assessment and control of the bioavailability of nickel in soils, *Environ. Toxicol. Chem.* 25, 643–651.
- Elrashidi, M. A., Shehata, A., Wehab, M. (1979): Content of zinc, cobalt, nickel and lead in saline alkali soils. *Agrochimica* 23, 245-253.
- Jaksić, S., Vučković S., Vasiljević S., Grahovac N., Popović V., Šunjaka D., Dozet G (2013): Akumulacija teških metala u *Medicago sativa* L. i *Trifolium pratense* L. na kontaminiranom fluvisolu. *Hem. Ind.* 67, 1, 95–101.
- Kabata-Pendias A. (2011): *Trace Elements in Soils and Plants*, 4th ed. CRC, Press Taylor and Francis Group, Boca Ration, London, New York.
- Kastori R., Petrović N., Arsenijević-Maksimović I. (1997): *Heavy Metals and Plants in: Kastori R. (red.), Heavy Metals in the Environment*, Research Institute Field and Vegetable Crops Research, Novi Sad, 195–247.
- Lindsay, W.L. and Norvell, W.A. (1978): Development of a DTPA Soil Test for Zinc, Iron, Manganese, and Copper. *Soil Science Society of America Journal*, 42, 421-428.
- Markoski M., Mitkova T., Pelivanoska V., Jordanoska B., Prentović T. (2011): Investigation of the content of heavy metals in agricultural soils in the reon of Struga, Proc1st International Scientific Conference “Land, usage and protection”, *Andrevlje*, 49–54.
- Mead R., Curnow R. N., Hasted A. M. (1996): *Statistical methods in agricultural and experimental biology*, Chapman & Hall, London, 410.
- Mihaljev Ž., Živkov-Baloš M., Pavkov S., Stojanović D. (2008): Contents of toxic elements in samples of alfalfa from the area of Vojvodina, *Contemporary Agriculture*, 57, 35-38.
- Milošević M., Vitorović S. (1992): *Fundamentals of toxicology with elements of ecotoxicology*, Scientific book, Belgrade.
- Pelivanoska V., B. Jordanoska B., Filipovski K., Mitkova T., M. Markoski M. (2011): Heavy metal content in soil and tobacco leaves at the region of Skopje, Republic of Macedonia, *Proc 1st International scientific conference “Land, usage and protection”*, *Andrevlje*, 55–60.
- Republika Srbija (1994): *Regulation on Allowed Quantities of Hazardous and Harmful Substances in Land*, U: *Official Gazette of the Republic of Serbia*, Belgrade, 23/194.
- Romić, M., Romić, D. (2003): Heavy metals distribution in agricultural topsoils in urban area. *Environmental Geology*, 43(7), 795-805.
- Ubavić M., Bogdanović D. (1995): *Agrochemistry*, Faculty of Agriculture, Novi Sad.
- Ure, A. M. (1995). *Methods of analysis for heavy metals in soils*. In "heavy metals in (B. J. Alloway, Ed.), 58–102. Blackie, London.
- Valdares, J.M.A.S., Gal, M., Mingelgrin, U., Page, A.L. (1983): Some heavy metals in soils treated with sewage sludges: their effect on yeald and their uptake by plants. *J. Environ. Qual.* 12, 49-57.
- Yugoslav Society of Soil Science (1966): *Manual for Soil Chemical Analysis. Manual for Soil testing*, Books I, Belgrade.

## INFLUENCE OF FERTILIZATION AND LIMING ON CHANGES OF AGROCHEMICAL CHARACTERISTICS OF SOIL TYPE PSEUDOGLEY

Miodrag JELIĆ<sup>1\*</sup>, Vera ĐEKIĆ<sup>2</sup>, Ivica ĐALOVIĆ<sup>4</sup>, Goran DUGALIĆ<sup>3</sup>, Desimir KNEŽEVIĆ<sup>1</sup>, Nebojša GUDŽIĆ<sup>1</sup>

<sup>1</sup>University of Prishtina, Faculty of Agriculture Lesak, Kopaonicka bb, Lesak, Serbia

<sup>2</sup>Center for Small Grains d.o.o. Kragujevac, Save Kovacevica 31, Kragujevac, Serbia

<sup>3</sup>University of Kragujevac, Faculty of Agronomy, Cara Dusana 34, Čačak, Serbia

<sup>4</sup>Institute of Field and Vegetable Crops, Novi Sad, Serbia

\*Corresponding author: miodragjelic@yahoo.com

### Abstract

The influence of long-term application (over 15 years) of different system of fertilization and liming (applied every 5 years) on the state of agrochemical characteristics of soil type pseudogley were investigated. The trial included an untreated control and three ameliorative fertilization treatments: NP<sub>1</sub>K (120 kg N ha<sup>-1</sup>, 80 kg P<sub>2</sub>O<sub>5</sub> ha<sup>-1</sup>, 53 kg K<sub>2</sub>O ha<sup>-1</sup>), NP<sub>2</sub>K (120 kg N ha<sup>-1</sup>, 160 kg P<sub>2</sub>O<sub>5</sub> ha<sup>-1</sup>, 53 kg K<sub>2</sub>O ha<sup>-1</sup>), NP<sub>1</sub>K + CaCO<sub>3</sub> (120 kg N ha<sup>-1</sup>, 80 kg P<sub>2</sub>O<sub>5</sub> ha<sup>-1</sup>, 53 kg K<sub>2</sub>O ha<sup>-1</sup> + 5 tha<sup>-1</sup> CaCO<sub>3</sub>), NP<sub>1</sub>K + CaCO<sub>3</sub> + manure (120 kg N ha<sup>-1</sup>, 80 kg P<sub>2</sub>O<sub>5</sub> ha<sup>-1</sup>, 53 kg K<sub>2</sub>O ha<sup>-1</sup> + 5 tha<sup>-1</sup> CaCO<sub>3</sub> + 20 t manure ha<sup>-1</sup>). This investigation carried out at the experimental field of Secondary Agricultural-chemical school “Dr Djordje Radic” in Kraljevo. The results of investigation showed a significant effect of long-term application of fertilizers and liming materials to changes in pH, content of N, P<sub>2</sub>O<sub>5</sub>, K<sub>2</sub>O, Fe, Mn, Zn, Al, and partially indicated the composition of adsorption complex of soil and content of humus in soil. The long term application of NP<sub>1</sub>K fertilizer every year in combination with periodical application NP<sub>1</sub>K + CaCO<sub>3</sub> + manure every five year showed the highest efficient influence on changing the characteristics of pseudogley type of soil. Thus, combined application of NP<sub>1</sub>K + CaCO<sub>3</sub> + manure reduced soil acidity (pH<sub>(KCl)</sub>) for 1.8 units, the content of mobile Al (from 13 mg 100 g<sup>-1</sup> to 0.4 mg 100 g<sup>-1</sup>), and the content of Fe and Mn in several dozen mg kg<sup>-1</sup>, and increased content of P<sub>2</sub>O<sub>5</sub> by about 4.2 mg 100 g<sup>-1</sup> and K<sub>2</sub>O content by about 2.1 mg 100 g<sup>-1</sup>.

**Key words:** agrochemical properties, fertilization, liming, soil, pseudogley.

### Introduction

Soil acidity is a major yield-limiting factor for crop production worldwide. The land area affected by acidity is estimated at 4 billion hectare, representing approximately 30 % of the total ice-free land area of the world (Sumner and Noble, 2003). The Republic of Serbia also comprises substantial areas of acid soils, accounting for over 60% of total arable land (Stevanovic et al. 1995). According to Fageria and Baligar (2008), soil acidity produces complex interactions of plant growth-limiting factors involving physical, chemical, and biological properties of soil. The pH can affect the soil environment in many ways through influences on sorption potential, cation availability and microbial degradation rates (Sanderman et al., 2008). Calcium, magnesium, and phosphorus deficiencies or unavailability, and aluminium toxicity are considered major chemical constraints that limit plant growth on acid soils.

Liming is the most common and effective practice for reducing soil acidity related problems (Fageria and Baligar, 2001). Liming of acid mineral soils with agricultural limestone or other liming materials is required to reduce levels of toxicity, increase soil pH and increase

availability of some nutrients which consequently improve crop yields (Jaskulska et al., 2014). Adequate liming eliminates soil acidity and toxicity of Al, Mn, and H; improves soil structure (aeration); improves availabilities of Ca, P, Mo, and Mg, and N<sub>2</sub>-fixation; and reduces the availabilities of Mn, Zn, Cu, and Fe and leaching loss of cations. For several crops, liming results in some chemical changes in the soil such as, increase in pH, effective cation exchange capacity (ECEC), and exchangeable Ca, decrease in toxic elements for example Al<sup>3+</sup> and Mn<sup>2+</sup> and changes in the proportion of basic cations in CEC sites (Tang and Rengel, 2003). The objectives of this study is the long-term effects of fertilization and lime application on some agrochemical characteristics of soil type pseudogley.

### **Material and Methods**

This investigation carried out at the experimental field of Secondary Agricultural-chemical school "Dr Djordje Radic" in Kraljevo. The studied soil is extremely acid pseudogley. For the experiment, 2-field crop rotation of wheat-corn was applied. The experiment was established as randomized block system in three replications on the plots of 100 m<sup>2</sup>. The trial included an untreated control and three ameliorative fertilization treatments: NP<sub>1</sub>K (120 kg N ha<sup>-1</sup>, 80 kg P<sub>2</sub>O<sub>5</sub> ha<sup>-1</sup>, 53 kg K<sub>2</sub>O ha<sup>-1</sup>), NP<sub>2</sub>K (120 kg N ha<sup>-1</sup>, 160 kg P<sub>2</sub>O<sub>5</sub> ha<sup>-1</sup>, 53 kg K<sub>2</sub>O ha<sup>-1</sup>), NP<sub>1</sub>K + CaCO<sub>3</sub> (120 kg N ha<sup>-1</sup>, 80 kg P<sub>2</sub>O<sub>5</sub> ha<sup>-1</sup>, 53 kg K<sub>2</sub>O ha<sup>-1</sup> + 5 t ha<sup>-1</sup> CaCO<sub>3</sub>), NP<sub>1</sub>K + CaCO<sub>3</sub> + manure (120 kg N ha<sup>-1</sup>, 80 kg P<sub>2</sub>O<sub>5</sub> ha<sup>-1</sup>, 53 kg K<sub>2</sub>O ha<sup>-1</sup> + 5 t ha<sup>-1</sup> CaCO<sub>3</sub> + 30 t ha<sup>-1</sup> manure). Fertilizers have used in the form of complex NPK fertilizer (8:24:16, superphosphate (17% P<sub>2</sub>O<sub>5</sub>) and ammonium nitrate (AN) 34.4% N). For maize the same concentrations of P and K were applied, while N was applied in higher dosage of 150 kg N ha<sup>-1</sup>. In the experiment a lime fertilizer "Njival Ca" (product of Paracin glass factory) was applied at a rate of 4.0 t ha<sup>-1</sup>. In wheat total quantity of lime, phosphorus and potassium fertilizers along with 1/3 of nitrogen applied in one plant feeding in early spring. In maize entire quantity of nutrients has been applied after soil preparation. Lime fertilizer has been used periodically every five years (2005, 2010 and 2015). Quantity of the applied well matured manure was 30 t ha<sup>-1</sup>. Other measures of care that have been carried out during the growing season of winter wheat and maize have been standard. Prior to lime and mineral fertilizers applications, surface-soil samples were taken in a random manner with a soil auger from the top 0–20 cm. They were mixed thoroughly and about 1.0 kg composite sample packed in a polythene bag and analyzed in the laboratory. Soil analyzes have been performed by standard chemical methods, as follows: pH in H<sub>2</sub>O and KCl, electrometrically with a glass electrode in a 1:2.5 suspension; content humus by Kotzmann's method; sum of absorbed base cations by Kappen's method; total nitrogen has been determined by the Kjeldahl's method, available phosphorus and potassium by Egner-Riehm's Al method, mobile Al by colorimeter with aluminium acetate buffer, while the content of available forms of heavy metals (Fe, Mn, Zn) have been determined by AAS in 0.1 HCl soil extract.

### **Results and Discussion**

Initial soil characterizations on selected parameters from the study site are presented in Table 1. Agrochemical properties of the treated pseudogley are very unfavorable. The treated soil is highly acid, which in the surface topsoil horizon (0-20 cm) has a relatively low active acidity (pH<sub>(H<sub>2</sub>O)</sub> 5.24), while the deepest layers of the soil there was a significant decrease in acidity (pH<sub>(H<sub>2</sub>O)</sub> 6.04). Exchangeable acidity (pH in KCl) of this type of soil throughout the profile ranges from 4.48 to 4.80. The examined soil is characterized by very unfavorable composition of the adsorptive complex. The values of adsorption capacity, sum of adsorbed base cations, as well as the degree of saturation adsorptive complex with bases, are very low (Table 1).



Table 1. Agrochemical properties of soil type pseudogley

Depth (cm)	Humus (%)	N (%)	pH		T	S	T-S	P <sub>2</sub> O <sub>5</sub>	K <sub>2</sub> O
			H <sub>2</sub> O	KCl					
0–20	2.18	0.14	5.24	4.48	16.71	8.08	8.63	8.0	13.8
20–40	1.84	0.13	5.55	4.58	16.69	9.79	6.90	7.0	13.6
40–60	0.66	0.09	5.46	4.42	26.24	20.02	6.22	1.3	8.5
60–80	0.71	0.07	5.64	4.52	26.29	21.31	4.98	1.0	7.6
80–100	0.63	0.02	6.04	4.80	25.62	22.02	3.60	0.8	4.3

Also it is low (2.18%) humus content in the surface layer (0-20 cm) and significantly decreases with increasing of depth. Reduced humus content in cultivated pseudogley soil profiles, points out the need for a projection of fertilization system and application of pedomeliorative measures, in order to preserve and enrich the adsorptive complex, it is a must to apply ameliorative measure of humification. Analyzed pseudogley profile shows median coverage with total nitrogen in the humus-accumulative horizon. Total nitrogen in the topsoil is represented with an average value of 0.14% and significantly decreases with increasing depth (0.02%). Supply with available phosphorus in this soil type is poor 7.0-8.0 mg 100 g<sup>-1</sup> of soil, in the soil layer from 0 to 40 cm. When it comes to the content of easily available potassium the treated soil is well supplied, and it belongs to an average supplied soil class (13.8 mg 100 g<sup>-1</sup>). Long-term application of only NPK fertilizers influenced the increase of acidity of the soil, while the meliorative application of lime and manure in combination with the application of NPK fertilizers significantly reduced the acidity of the soil (Table 2).

Table 2. Changes of pH, humus content, nitrogen and base cations in the treated soil (0-20 cm)

Years	Variants of fertilizers	pH		Humus (%)	N (%)	T	S	T-S	V (%)
		H <sub>2</sub> O	KCl						
2002 (A)	Control	5.56	4.22	2.20	0.126	19.9	9.6	9.8	50.5
	NP <sub>1</sub> K	5.52	4.20	2.15	0.118	20.2	9.9	9.3	49.3
	NP <sub>2</sub> K	5.55	4.15	2.20	0.134	20.8	9.8	11.2	50.2
	NP <sub>1</sub> K + Ca	6.02	4.98	2.43	0.155	24.4	10.6	12.6	51.2
	NP <sub>1</sub> K + Ca + manure	6.30	5.03	2.44	0.188	27.9	12.8	13.3	54.5
	Control	5.10	3.92	2.24	0.128	19.0	10.0	9.6	49.3

2016 (B)	NP <sub>1</sub> K	5.48	3.48	2.10	0.116	20.6	10.2	9.3	48.3
	NP <sub>2</sub> K	5.36	4.08	2.25	0.123	21.0	10.6	10.3	46.8
	NP <sub>1</sub> K + Ca	7.66	6.26	3.02	0.144	25.4	11.4	10.6	56.6
	NP <sub>1</sub> K + Ca + manure	7.68	6.83	3.12	0.148	28.2	11.0	10.6	58.4

A – initial state, B – present state

The application of NPK fertilizers in relation to the initial state increased the acidity of the soil from 0.23 (pH in H<sub>2</sub>O) to 0.49 pH units (pH in KCl). The periodic meliorative use of lime and manure fertilizers in combination with the application of NPK fertilizers influenced a significant decrease in acidity in relation to control, for: 2.58 in the active and 2.91 pH units, in the case of exchangeable acidity of the soil. In combination with fertilizer NPK variants combined use of lime, manure and mineral NPK fertilizers significantly reduced acidity of the soil (2.37 active and 3.01 pH units exchangeable). In agreement with these results, Foth and Ellis (1997) also pointed out that soil pH change over time due to liming as an increase following application and gradual decrease with time. However, change in soil pH over time in response to lime application depends upon the soil type, lime rate and lime quality (Foth and Ellis, 1997). Lime alone increased soil pH and reduced soil exchangeable acidity when compared to the pre-season and to the control. The increase in soil pH under lime treatment was due to addition of CaO which reacts with water leading to production of OH<sup>-</sup> ions which forms Al(OH)<sub>3</sub> and H<sub>2</sub>O thus raising the soil pH and decreasing exchangeable acidity. On the other hand applied manure through its decomposition releases exchangeable cations to the soil solution, which replace the Al<sup>3+</sup> and H<sup>+</sup> ions in the soil sorption sites (Crawford et al., 2008). Similar results were reported earlier and by other authors (Jelić et al., 2006; Dugalić et al., 2006; Jelić et al., 2013).

Content of the humus and total nitrogen in the soil varied depending on the long-term application of fertilizers. Long-term application of fertilizers showed a certain influence on the change of the adsorptive soil complex (Table 2). Significant changes in T values were obtained in the periodic combined use of lime, manure and mineral NPK fertilizers. As compared to the initial state and the control it is achieved increasing of adsorption capacity for about 8.0 cmol<sup>+</sup> kg<sup>-1</sup>. Sum of adsorbed basic cation (S) showed minimal changes, with the tendency of slight increase under the influence of long-term application of lime, organic and mineral NPK fertilizer. Degree of soil saturation with adsorbed bases (V%) is slightly reduced if NPK has been used for years, while the combined use of lime, manure and NPK fertilizer increasing the degree of base saturation of about 6%. Realized changes of the soil adsorption complex are result of the positive impact of the applied lime and manure to increase soil pH and humus content. Raising the pH of the soil solution enhances the cation exchange capacity, due to the increase in the activity of the hydroxyl groups in the composition of humic acid, and the increase in negative charge of the amphoteric colloid soils (Dugalić and Gajic, 2012). Using of a mineral NPK, manure and lime application for years has led to significant changes in the content of available phosphorus in the soil (Table 3).

Table 3. Changes in the content of some available forms of macro and micro nutrients and aluminium in the studied soil (0–20 cm)

Years	Variants of Fertilizers	P <sub>2</sub> O <sub>5</sub>	K <sub>2</sub> O	Al	Fe	Mn	Zn
		mg 100 g <sup>-1</sup> soil			mg kg <sup>-1</sup> soil		
2002 (A)	Control	7.0	8.5	8.7	227	70	1.7
	NP <sub>1</sub> K	8.3	8.5	9.4	280	54	1.0
	NP <sub>2</sub> K	9.5	8.3	8.7	273	18	1.5
	NP <sub>1</sub> K + Ca	12.9	9.5	1.3	183	23	1.6
	NP <sub>1</sub> K + Ca + manure	13.5	10.7	0.1	122	31	1.9
2016 (B)	Control	4.5	7.7	12.3	320	96	0.8
	NP <sub>1</sub> K	8.3	7.3	13.1	334	128	1.0
	NP <sub>2</sub> K	10.2	6.7	13.0	260	135	1.3
	NP <sub>1</sub> K + Ca	13.3	10.4	0.1	110	44	1.5
	NP <sub>1</sub> K + Ca + manure	16.8	11.3	0.1	115	35	2.0

A – initial state, B – present state

Applying the complex NPK fertilizers with higher dose of phosphorus, using the combined lime and manure along with the regular application of NPK fertilizer had a significant increase in the content of available phosphorus which are relative to a control baseline ranged from 9.8 to 12.3 mg 100 g<sup>-1</sup> soil. Also, the application of lime, manure and NPK fertilizers has achieved a significant increase in available phosphorus content in relation to the use of NPK fertilizers. Accumulation of available phosphorus content in soil is the result of long-term application with a phosphate, and lime spreaders which are intensified mobilization process of the element from the reserve area. Similar results have been noticed by other authors (Dugalić et al., 2006; Jelić et al., 2006; Jelić et al., 2013). Changes in the content of available potassium are less in comparison to changes in the content of available phosphorus (Table 3). Variants with K application, in particular, those which are in addition to the regular application of potassium periodically received lime manure as well, are achieved a substantial increase of available potassium according to the control, and the initial state (2.2-3.6 mg 100 g<sup>-1</sup> soil). Mobility of aluminum in soil is directly dependent on the pH value of the soil. Therefore, the highest content of aluminum was recorded in the control and with the application of the NPK fertilizer in the most acid soil (Table 3). Continuous application of the NPK fertilizer increased the Al content in the soil in relation to the control, as well as the initial state. However, their periodic combined use of the organic, lime and mineral NPK fertilizer has significantly reduced the content of mobile Al in the soil (0.1 mg 100 g<sup>-1</sup> soil) in relation to the initial state and control. Kheyrodin and Antoun (2012) found that manure increased significantly soil P, Ca and Mg contents in the 15–30 cm depth. Application of 2 t ha<sup>-1</sup> of lime decreased exchangeable Al, and increased pH, available Ca and Mg in Cameroon (The et al., 2001). Lime and P fertilizers significantly improved soil pH and available P as reported by

Anetor and Akinrinde (2006), who also attributed increased soil pH with lime which in turn reduced P fixation. Ademba et al. (2010) reported significant increase in soil total P, K, Ca, Mg with sole application of 10 t ha<sup>-1</sup> of manure, 60 kg P<sub>2</sub>O<sub>5</sub> ha<sup>-1</sup> and 250 kg ha<sup>-1</sup> of lime. The et al. (2001) also reported significant increase of exchangeable Ca after application of manure alone or combined with lime and P fertilizer.

### **Conclusion**

Acid reaction and nutritional imbalances, mainly low levels of plant available phosphorus (P) are often limiting factors of soil fertility in Central Serbia. The soil was strongly acidic, with Al toxicity and low exchangeable Ca<sup>2+</sup> and poor availability of P. Residual lime and fertilization had also significant effect on some chemical properties of the acidic soils. Farmers can obtain long term economic gain with one-time application of lime and P fertilizer on P deficient acid soil of the region.

### **Acknowledgements**

\*The present study is the part of the TP 31054 project named “Development of New Technologies of Small Grains Production on Acid Soils Using Modern Biotechnology” funded by the Ministry of Education, Science and Technological development, Republic of Serbia

### **References**

- Ademba, J.S., Esilaba, A.O., Ngari, S.M. (2010): Evaluation of organic and inorganic amendments on nutrient uptake, phosphorus use efficiency and yield of maize in Kisii region. In L. A.Wasilwa, J.Ouda, I.W. Kariuki, N.S. Mangale & M.N. Lukuyu (Eds). Transforming Agriculture for Improved Livelihoods through Agricultural Product Value Chain. Proceedings of the 12th KARI Biennial Scientific Conference. November 8-12, 2010. Nairobi–Kenya.
- Anetor, M.O., Akinrinde, E.A. (2006): Response of Soybean [*Glycine max* (L.) Merrill] to lime and phosphorus fertilizer treatments on an acidic Alfisol of Nigeria. *Pakistan Journal of Nutrition*, 5 (3): 286–293.
- Crawford, Jr.T.W., Singh,U., Breman, H. (2008): Solving problems related to soil acidity in Central Africa’s Great Lakes Region. International Center for Soil Fertility and Agricultural Development (IFDC) – USA.
- Dugalic, G., Katic, S., Vasiljevic, S., Gajic, B., Lazarevic, D., Djalovic, I. (2006): Effect of liming on changes in pseudogley agrochemical properties and alfalfa yield. *Soil and Plant*, 55 (3): 249–257.
- Dugalić, G., Gajić, B. (2005): *Pedology. Manual Laboratory*. Faculty of Agronomy, Čačak.
- Fageria, N.K., Baligar, V.C. (2001): Lowland rice response to nitrogen fertilization. *Commun Soil Sci. Plant Anal.* 32: 1405–1429.
- Fageria N.K., Baligar V.C. (2008): Ameliorating Soil Acidity of Tropical Oxisols by Liming For Sustainable Crop Production. *Advances in Agronomy Journal*, 99: 345–399.
- Foth, H.D. and Ellis, B.G. (1997): *Soil Fertility*, second ed. Lewis Publishers, Boca Raton.
- Jaskulska, I., Jaskulski, D., Kobierski, M. (2014): Effect of liming on the change of some agrochemical soil properties in a long-term fertilization experiment. *Plant, Soil and Environment*, 60 (4): 146–150.
- Jelic, M., Dugalic, G., Milivojevic, J. (2006): Influence of different wheat fertilization system on the fertility of smonitza in the process of degradation. *Soil and Plant*, 55 (1): 29–38.

- Jelic, M., Dugalic, G., Milivojevic, J., Djikic, A., Djekic, V., Tmusic, N., Gudžic, N. (2013): Influence of long-term application of fertilizers and ameliorative measures on soil properties and grain yield. Proceedings, The 1st International Congress on Soil Science, XIII National Congress in Soil Science, (E. Saljnikov, ed.), Serbian Soil Science Society and Instituta of Soil Science, pp. 195–207, Belgrade.
- Kheyrodin, H., Antoun, H. (2012): Tillage and manure effect on soil physical and chemical properties and on carbon and nitrogen mineralization potentials. *African Journal of Biotechnology*, 10 (48): 9824–9830.
- Sanderman, J., Baldock, J.A., Amundson, R. (2008): Dissolved organic carbon chemistry and dynamics in contrasting forest and grassland soils. *Biogeochemistry* 89: 181–198.
- Stevanovic, D., Jakovljevic, M., Martinovic, Lj. (1995): Solution of acid soils problem as prerequisite for food production increase and soil protection. International Conference "Repair of acid soils of Serbia using lime fertilizer Njival Ca". Book of Proceedings, pp. 7–21. Paracin.
- Sumner, M.E., Noble, A.D. (2003): Soil acidification: The world story. In: Rengel, Z, (eds). *Handbook of Soil Acidity*. pp. 1–28. Marcel Dekker, New York.
- Tang, C., Rengel, Z. (2003): Role of plant cation/anion uptake ratio in soil acidification. In: Rengel, Z, (eds). *Handbook of Soil Acidity*. pp. 57–81. Marcel Dekker, New York.
- The, C., Calba, H., Horst, W.J., Zonkeng, C. (2001). Maize grain yield correlated responses to change in acidic soil characteristics after 3 years of soil amendments. Seventh Eastern and Southern Africa Regional Maize Conference, 11th–15th February, 2001. pp. 222–227.

## **AGRO-ECOLOGICAL CONDITIONS OF FRUIT GROWING IN THE PEŠTER (PLATEAU) REGION**

Mira MILINKOVIĆ\*, Olga MITROVIĆ, Žaklina KARAKLAJIĆ STAJIĆ, Jelena TOMIĆ,  
Svetlana M. PAUNOVIĆ, Miodrag KANDIĆ, Rade MILETIĆ

Fruit Research Institute Cacak, Kralja Petra I/9, 32000 Cacak, Serbia

\*Corresponding author: miramilinkovic@yahoo.com

### **Abstract**

Pedological and land capability properties of soil in the Pešter plateau region (the Municipality of Tutin, Serbia), indicate that those are predominantly shallow, poorly fertile soils, rated with class 5 and above. By altitude and relief predisposition, agricultural land is extremely mountainous with the average altitude of approx 1000m. Fruit area takes 0.9% of the territory or 340 ha of the area, with plum dominating in the production structure and a tendency of planting raspberry. Analysis of agro-physical and agro-chemical properties of the soil planned for established fruit plantations show that the soils within the same area are significantly different and require different repair measures accordingly. Agro-physical properties indicate the classification of clay to light clay soil, with medium to high interval of cation exchange capacity (T). Degree of soil saturation with adsorbed bases (V%) corresponds to other parameters tested, with the highest values in the Pešter region, in the zone under peat fields from which the peat is utilized for commercial purposes (V 85.14 to 98.57%). Agro-chemical properties of the soil indicate the soil reaction range from acid to slightly acid, non-carbonic at 60-75% of the sampled surface depending on the depth of sampling and culture grown. A high (> 5%) and very high (> 8%) humus content is present in the surface horizon (0-30 cm) in about 75% of the tested surfaces. In most of the sampled localities a very low content of available phosphorus was recorded (<6 mgP<sub>2</sub>O<sub>5</sub>/100 g of soil) as well as the availability of easily accessible potassium (15-25 mg/100g of soil). For the cultivation of fruit species in these conditions, it is necessary to consider all environmental conditions and then select the type and variety (of the species for cultivation).

**Keywords:** *Agro-ecological conditions, Pešter plateau, Fruit growing.*

### **Introduction**

Pešter plateau region stretches at an altitude of 900 to 1200 meters and is the highest plateau in the Balkans and one of the largest in Europe. Pešter is well known for its specific microclimate, especially during the winter period. Extreme climatic conditions in certain periods of the year, contributed to the development of extensive livestock production, and the development of fruit production takes place gradually, without any particular impact on the balance of agricultural growth. On the part of the Pester plateau, in the municipality of Tutin, extensive plantations of fruit species are present on a total area of 340 ha, predominant fruit species as plums and apples. Other types of fruit are grown in gardens, sporadically. In recent years, there is a trend of establishing modern plantations of hazelnut and raspberry, and a substantial interest in other types of berries and nuts.

Pedological and land capability properties of soil in the Municipality of Tutin indicate that those are predominantly shallow, poorly fertile soils, rated with class 5 and above. High productive soils account for only 33 km<sup>2</sup> of land, i.e. 4.4%. Due to the high altitude, sub-

mountain and mountain conditions, dry areas on one side and waterlogged areas on the other side, as well as a shallow area, it can be said that the agricultural zoning is limited to a small band of up to 800 m above sea level. It is known that proper land management, good agricultural practices (which includes regular soil fertility control and the implementation of the basic principles of fertilization and agrotechnics) can maintain production capacity of land with minimal effects on the environment (Milivojević *et al.*, 2012). The most important preventive measures in the protection of land from degradation are identification of hazards and finding appropriate solutions to overcome them. To this end, a systematic control of fertility i.e. monitoring of soil quality is proposed. (Sekulić *et al.*, 2005). The variability of climate, as well as incomplete agrotechnics due to insufficient application of fertilizers, significantly affect the availability of nutrients in soil, often reducing their accessibility for the plants (Bogdanović, 2009).

The aim of our research is to determine agrophysical and agrochemical characteristics, in agro-ecological conditions of the part of Pester plateau and the possibility of growing different kinds of fruit species.

### Material and Methods

The land is sampled in the fall of 2016, in a rural area of the municipality of Tutin in Serbia. The samples were collected on parcels that are not under orchards (meadows, plough fields, stubble field, fallow land, fodder) and parcels under different types of fruit species, of two depths: 0-30 cm, 30-60 cm. Sampled parcels are marked with GPS coordinates with number of samples in village areas, determined on the basis of arable land and agricultural production, Popis poljoprivrede (2012). Agro-mechanical, physical and chemical analyses included examination of: mechanical aggregate composition of soil by sieving and sedimentation of different mechanical fractions JDPZ (1997), determination of the sum of exchangeable adsorbed alkaline cations ( $S \text{ meq } 100\text{g}^{-1}$ ) (method Kappen-a), the determination of hydrolytic soil acidity ( $H \text{ meq } 100\text{g}^{-1}$ ), cation exchange capacity ( $T \text{ meq } 100\text{g}^{-1}$ ), the level of saturation with adsorbed bases ( $V\%$ ). Agro-chemical characteristics of soil are determined by the following methods: pH of the  $\text{H}_2\text{O}$  and 1 MKCl-in (potentiometrically); humus (by the method of Kotzman); total nitrogen (method according to Kjeldahl); readily accessible phosphorus and potassium (AL method,  $\text{P}_2\text{O}_5$  - colourimetrically,  $\text{K}_2\text{O}$  - light photometrically).

### Results and Discussion

The results of mechanical composition of soil in certain village areas in the Municipality of Tutin are shown in Table 1. At the indicated locations (in villages Velje polje, Detane, Raduša, Gluhavica, Crkvine, Melaje and Leskova ) there is a tendency of fruit production development.

Table 1. Mechanical composition of soil, Municipality of Tutin

Settlement	Dubina	Sadržaj mehaničkih frakcija (%)						Klasa zemljišta
		2-0,2	0,2-0,02	0,02-0,002	<0,002	>0,02	<0,02	
		mm						
Vele polje	0-30	3.28	63.72	25.00	8.00	67.00	33.00	Sandy loam
	30-60	0.57	49.63	33.30	16.50	50.20	49.80	Clay loam
Detane	0-30	1.84	63.86	28.00	6.30	65.70	34.30	Sandy loam
	30-60	8.65	42.45	35.10	13.80	51.10	48.90	Loam
Raduša	0-30	3.08	67.72	21.40	7.80	70.80	29.20	Sandy loam

	30-60	0.59	57.61	30.50	11.30	58.20	41.80	Loam
Gluhavica	0-30	2.14	40.56	40.50	16.80	42.70	57.30	Clay loam
	30-60	3.34	31.76	43.79	21.11	35.10	64.90	Clay loam
Melaje	0-30	0.25	35.55	33.00	31.20	35.80	64.20	Light clay
	30-60	2.52	28.38	33.90	35.20	30.90	69.10	Light clay
Leskova	0-30	0.83	52.07	32.10	15.00	52.90	47.10	Clay loam
	30-60	1.18	48.92	31.10	18.80	50.10	49.90	Clay loam
Crkvine	0-30	8.67	40.13	31.00	20.20	48.80	51.20	Clay loam
	30-60	2.13	43.17	30.50	24.20	45.30	54.70	Clay loam

In most of the tested sites, there is a type of clay soil with some differences with respect to the sampling depth. In villages Detane and Velje polje, in the humus Ah horizon (0-30 cm), the fraction share of physical was clay is 33.00-34.30% and 65.70-67.00% is physical sand. In sub humus horizon (30-60 cm) the fraction share of physical clay is increased, with an approximate increase of the powder and clay fraction. Land at the site Raduša is highly humic and by mechanical composition, light to medium loam. In humus (Ah) horizon, they contain 70.80% of physical sand, of which 3.08 % fraction of coarse sand with prevailing powder fraction in relation to the clay fraction. At the site Leskova near the excavation of peat in Gornji Pešter, the land is classified as clay loam with 15.00-18.80% of fraction clay. In villages Gluhavica and Crkvine, in sub humus horizon there comes to an increased content of physical clay with predominant powder fraction with soils of heavier mechanical texture in relation to the former. At the site of Melaje, the highest content of fraction clay (31.20-35.20%) is recorded and with increasing sampling depth, the land in the class of light clays (ISSS classification). According to the American classification, these soils are classified into loamy sand to clay loam. Relatively favourable mechanical composition of the soil for cultivation of different types of fruit species and limited growing conditions indicate that the recommendation for the cultivation of certain fruit species needs to be seen from different angles. The results of research in Table 2 show that the analysed soils have different adsorptive capacity. Analyses show that there is a medium to high cation exchange capacity of the interval (T). Central cation exchange capacity (12-25 meq 100g<sup>-1</sup>) at the locality Veljo box Detane, Raduša and Gluhavica, a high capacity in Crkvina and Leskova, while at the site Melaje in humus (Ah) horizon a very high capacity > 40 meq 100g<sup>-1</sup> is present (Kutilek, 1978).

Table 2. Physical and chemical characteristics of soil, Municipality of Tutin

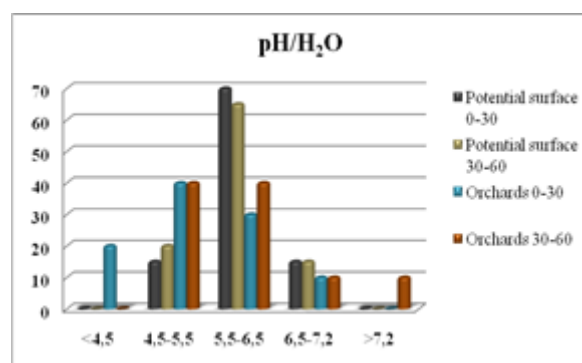
Settlement	Dubina	S	H=T-S	T	V
		meq/100g <sup>-1</sup>			%
Vele polje	0-30	6.08	16.02	22.10	27.51
	30-60	3.69	15.05	18.74	19.69
Detane	0-30	8.75	5.06	13.81	63.36
	30-60	5.90	6.63	12.53	47.09
Raduša	0-30	9.04	10.86	19.89	45.45
	30-60	9.64	11.51	21.15	45.58
Gluhavica	0-30	11.9	8.06	19.96	59.62
	30-60	11.36	7.09	18.45	61.57
Melaje	0-30	42.72	0.62	43.34	98.57
	30-60	28.26	3.74	31.99	88.34
Leskova	0-30	25.63	1.55	27.18	94.30
	30-60	25.66	1.43	27.09	94.72
Crkvine	0-30	29.23	5.40	34.33	85.14
	30-60	26.7	4.21	30.91	86.38



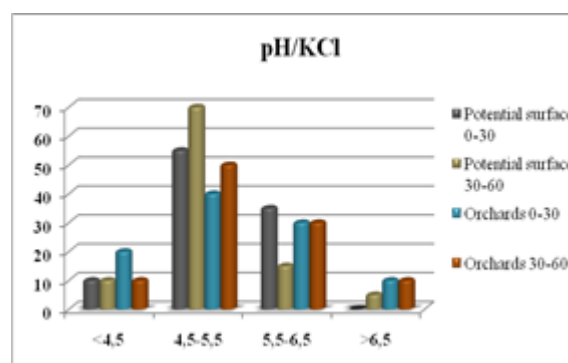
Very high levels of hydrolytic acidity, (15.05 to 16.02 meq 100g<sup>-1</sup>) and low degree of base saturation (V 19.69-27.51%) were measured in the village Velje polje. In the areas of village Raduša values of hydrolytic acidity are high and average degree of soil saturation with adsorbed bases 50.00-80.00% (Baize, 1993). In Gluhavica, values of investigated parameters are lower. Hydrolytic acidity in villages Detane and Crkvine is 4.21-6.63 meq 100g<sup>-1</sup> and V 47.09-86.38%. At the sites Melaje and Leskova, the measured values are very low hydrolytic acidity and high to very high degree of soil saturation adsorbed bases (V 80.00-100.00%).

Agrochemical characteristics of soils in the Municipality of Tutin are shown in Graph. 1-7.

In the humus (Ah) horizon (0-30 cm), of the soils that are now no longer used for cultivation of fruits (fields, meadows, stubble field, forage crops), 70.0% of the samples belong to the class of weakly acidic reaction (pH/H<sub>2</sub>O 5,5- 6,5), and 15.0% of samples each has an acidic (pH 4,5-5,5) or neutral (pH 6,5-7,2) reaction of soil. With increasing the depth of the sampling, in sub humus horizon (30-60 cm), in 20.0% of the samples soil acidity is increased whereas in 65% of the samples soil reaction is slightly acidic. On 30% of sample areas that have been planted with different types of fruit species, the most common are acidic soils (pH 4,5-5,5), then slightly acidic (pH 5,5-6,5), and in humus (Ah) horizon (0 -30 cm) there are also soils with strong acid reaction at two localities (Graph.1).



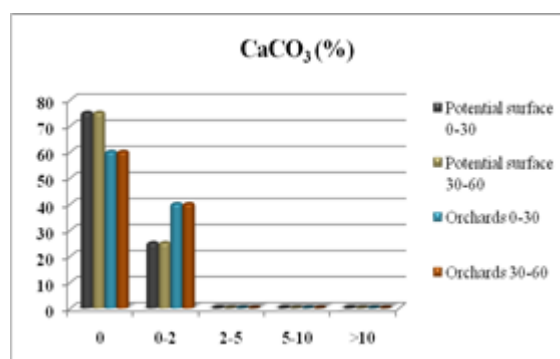
Graph 1. Active acidity of the soil (pH/H<sub>2</sub>O)



Graph 2. Substitution acidity of the soil (pH/KCl)

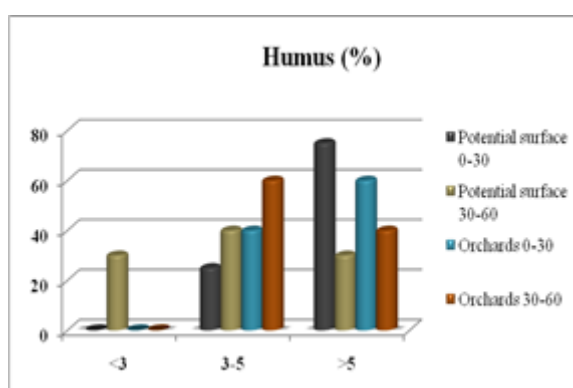
Based on the testing results of substitution acidity of soil (Graph. 2), in the humus (Ah) horizon (0-30 cm) of soil which is now not used for the cultivation of fruit trees, 55.0% of the samples has an acidic reaction (pH/KCl 4, 5-5,5) and in the land under orchards 40% of the samples. Weak acid reaction is found in 30-35% of the samples of all tested surface of the first sampling depth. With increasing depth (30-60 cm), an increase of soil acidity happen in the surfaces that are not under orchards to 70.0% and on surfaces under orchards on 50% of the samples in the class of acid reaction. Weakly acidic and weakly alkaline reaction of the sampled soil under orchards is not distinguished by depths of horizons.

Test results (Graph. 3) show that 75% of the samples are carbonate-free (0% CaCO<sub>3</sub>), and 25% of the samples slightly carbonated (CaCO<sub>3</sub> 0-2%) in both sampling depths, on the surfaces that are not under orchards. 60% of the samples on surfaces that are now used for fruit growing are non-carbonated and 40% is slightly carbonated.

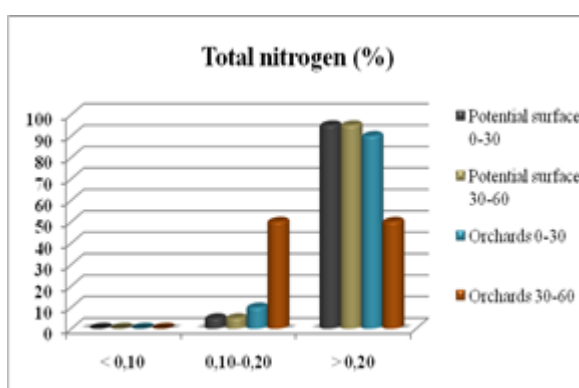


Graph 3. Content of CaCO<sub>3</sub> (%)

Based on the testing results of humus content in agricultural soils (Graph. 4), on the surfaces that are not used for fruit cultivation in the humus (Ah) horizon (0-30 cm), 75% of the soil is highly humic and 25% is humic soil. In sub-humic horizon (30-60 cm), there is a reduction of content of humus and the largest percentage of humic (3-5% of humus), 40% of slightly humic (<math><3</math>% humus) while high humic soils (> 5% humus) are present with 30%. Very high humus content > 8%, is measured in the area of the upper Pester, in the surface horizon of the soil. The surface under various fruit species, depending on the depth of the tested horizon contain from 40-60% of the samples in the class of high humic and highly humic soils.

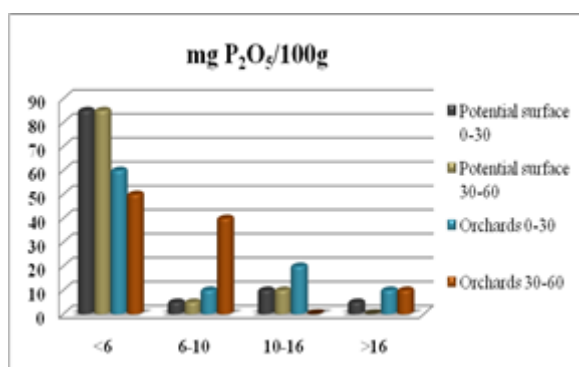


Graph 4. Content of humus (%)

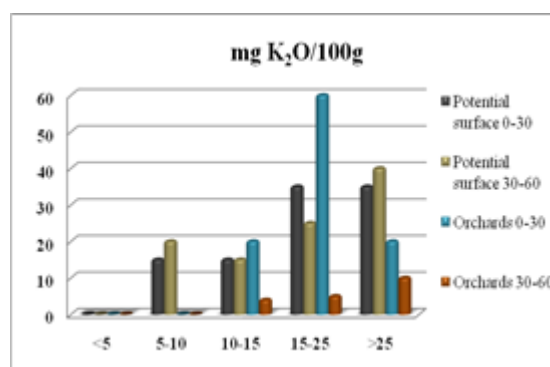


Graph 5. Content of total N (%)

The results of the study shown in Graph. 5 indicate that in the humus (Ah) horizon (0-30 cm) of all tested agricultural areas a high content of total nitrogen in soil (> 0.20%) is found in 90-95% of the samples. Sub humus horizon (30-60 cm) in 95% has a high content of total nitrogen, and in the same soil horizon under orchards, 50% of samples each is with medium and high content of total nitrogen.



Graph 6. Content of easily accessible P<sub>2</sub>O<sub>5</sub> (mg 100g<sup>-1</sup> of the soil)



Graph 7. Content of easily accessible K<sub>2</sub>O (mg 100g<sup>-1</sup> of the soil)

Soils with reaction pH <6 in 1M KCl in the region of Tutin account for 90%. They have lower content of easily accessible P<sub>2</sub>O<sub>5</sub>, so that of the samples from potential fruit growing surfaces in both sampling horizon, 75% of them have very low content (<6 mgP<sub>2</sub>O<sub>5</sub>/100 g soil). Sites of agricultural land under orchards on 50-60% of samples have a very low content of easily accessible phosphorus. The content of easily accessible phosphorus in other threshold value intervals varies in dependence of the sampling depth.

The content of easily accessible potassium (Graph.7), is within the limits of a good supply (K<sub>2</sub>O 15-25 mg / 100 g soil). In the humus (Ah) horizon (0-30 cm) of agricultural area which is now not used for fruit cultivation (fields, meadows, stubble, fodder) in 35.0% of the samples show a high content easily accessible potassium, and the same percentage of the samples is in the limits of optimal values, while in the remaining 30% the content is medium to low. Similar results are also obtained with the samples in sub humus horizon (30-60 cm), with minor discrepancies in relation to the volume of overall sample for this Municipality. In the areas under orchards, an optimal content of easily accessible K<sub>2</sub>O is found in 50-60% of the tested surface, whereas with a depth horizon increases the medium content of this nutrient. Soil cover represents an important ecological factor for a successful fruit breeding. While evaluating benefits, that is, fertility of a soil in relation to the respective soil and the properties of the soil itself (Sekulić *et al.*, 2005). Even in the best quality soils created under natural conditions, there may be a limiting factor, which reduces yields, in relation to the genetic potential for a particular plant species (Hadžić *et al.*, 1993; 2002). Based on the investigation results, there is a noticeable heterogeneity of soil cover in different regions of the Municipality. Mechanical composition has a great influence on the water-air, thermal, biological and nutritional regime of the soil (Gajić, 2006). Soils of shallow profile, profile, a low content of clay with low capacity of absorption of cations and acid reaction, have limiting possibilities for the cultivation of certain types. The content of clay fractions of 20-30% enables optimum potential soil fertility, given that other suitable agroecological conditions of fruit cultivation must be met.

Generally, most fruit species are best suited to moderately moist, deep loam-like soils. Certain fruit species require moderate lime soil aerated, moderately moist and deep enough, with slightly acidic reaction and well provided with accessible nutrients.

### Conclusion

On the majority of tested sites, in the regions with light clay as the class o soil and certain differences with respect to sampling depth, medium to high interval of cation exchange capacity (T), very high values of hydrolytic acidity, (15.05 to 16.02 meq 100g<sup>-1</sup>) and a low degree of base saturation (V 19.69-27.51%) are measured in soils of light clay, where an increase of clay fraction is followed by an increase of the adsorptive capability of soil and degree of base saturation.

In agrochemical terms, active soil acidity on 70.0% of the samples is of slightly acidic reaction and based on substitution soil acidity, acidic reaction is predominant. The field of research shows that 75% of the samples is carbonate-free with the same percentage of highly humic soils. The region of Pester peat areas contains > 8% of humus in the upper horizon. The soil characteristic is a very low content of easily accessible phosphorus (<6 mgP<sub>2</sub>O<sub>5</sub> 100 g<sup>-1</sup>). The content of potassium is within the limits of good supply.

Limiting factors for fruit cultivation are climatic conditions, which require the selection of fruit species tolerant to the existing environmental conditions and the application of corrective measures of soil in accordance with cultivated species.

### **Acknowledgements**

The research was funded by the Ministry of Agriculture and Environment of the Republic of Serbia through the project "Arrangement of agricultural land in the region of Šumadija and Raška, using agromeliorative measures to develop fruit production" and partly by the Ministry of Education, Science and Technological Development of Republic of Serbia (grant number 31080 TR).

### **References**

- Baize D. (1993). *Soil Science Analyses. A guide to current use.* John Wiley & Sons. Chichester.
- Bogdanovic D. (2009). The consumption of fertilizers in our country since the onset of hemispherication to date. XII Congress of Society for the Study of the Land of Serbia, 146.
- Hadžić V., Nešić Lj., Belić M., Milojković N. (1993) Land as a natural resource in food production. Heavy metals and pesticides in the lands of Vojvodina. Institute of Field and Vegetable Crops, Novi Sad, 9-15.
- Hadžić V., Nešić Lj., Belić M., Sekulić P., Pucarević M., Bikit I., Ubavić M. (2002). Characterization of soil for the production of high-value food from wheat and corn . *Land and Plant*, Vol 51, No I, p 65-77, Belgrade.
- Kutílek M. (1978): *Water economical pedology.* SNTL ALFA, Bratislava.
- Milivojević J., Đekić V., Jelić M. (2012). Fertility of the arable land of the production sites of the town of Kragujevac in private ownership. *Vegetable and vegetable production*, Vol. 49 (2), pages (195-201).
- Census of Agriculture, 2012. Republic Institute of Statistics.
- Sekulić P., Hadžić V., Ubavić M., Nešić Lj. (2005). Requirements of seed crops in relation to the land. *Seeds*, Vol. I, (Milošević, M. & Milošević, M.) Scientific Institute of Field and Vegetable Crops, Novi Sad, 267-305.

## PROSPECTS FOR USING SUDAN GRASS AS A SOURCE OF RENEWABLE ENERGY

Snežana JANKOVIĆ<sup>1</sup>, Jela IKANOVIĆ<sup>2</sup>, Ljubiša KOLARIĆ<sup>2</sup>, Ljubiša ŽIVANOVIĆ<sup>2</sup>, Vera POPOVIĆ<sup>3</sup>, Gordana DRAŽIĆ<sup>4</sup>, Sveto RAKIĆ<sup>2</sup>, Vojislav TRKULJA<sup>5</sup>

<sup>1</sup>Institute for Science Application in Agriculture, 68b Blvd. D. Stefana, Belgrade, 11000, Serbia

<sup>2</sup>University of Belgrade, Faculty of Agriculture, 6 Nemanjina Street, Belgrade, 11080, Serbia

<sup>3</sup>Institute of Field and Vegetable Crops, 30 Maksima Gorkog Street, Novi Sad, 21000, Serbia

<sup>4</sup>Singidunum University, Faculty of Applied Ecology “Futura”, 83 Požeška Street, 11030, Belgrade, Serbia

<sup>5</sup>Agricultural Institute of Republika Srpska, 78000, Banja Luka, Bosnia and Herzegovina

\*Corresponding author: sjankovic@ipn.bg.ac.rs

### Abstract

For making solid or liquid biofuels, one can use whole plants of annual or perennial species, if they form large biomass per unit area suitable for commercial processing. A large number of plants worldwide in the vegetation season yield large biomass that can be used in different ways as a source of energy. During the two-year research (2014 and 2015), researchers studied morphological and productive characteristics of the Sudan grass variety *Zora* grown on chernozem, namely: leaf mass, stem mass and biomass yield. The results revealed that the biomass was, on average, higher in the second year than in the first. The biomass yield was statistically significantly higher in 2015 (40.47 t/ha) than in 2014 (36.64 t/ha). A statistically significant positive correlation was found between the leaf mass and the stem mass (0.63), while there was a statistically non-significant positive correlation between the leaf mass and the biomass yield (0.47), as well as between the stem mass and the biomass (0.28).

**Key words:** agro-energy crops, biomass, genotype, morphological characteristics, Sudan grass

### Introduction

In order to secure the supply of necessary fuels, most countries are focusing their research towards finding the most efficient way of using renewable energy sources. According to some statistics, approximately 13% of the world's primary energy nowadays is coming from such sources (Janković et al., 2017).

Various forms of renewable energy sources for making electric power (solar, wind power, water power and chemical energy gained through photosynthesis) are significant for many countries from the aspect of environmental protection (Dražić et al. 2016). The same authors point out that there are a large number of plants worldwide, which in the vegetation season produce large biomass that could be used in different ways as a source of energy. Prior to introducing such plants into the production, it is necessary to study their biological characteristics and their relationship with agro-ecological and soil conditions and then use adequate breeding methods to create genotypes with the highest yield.

The economic justification of using fuels from renewable sources lies in cutting off the funding for importing necessary fossil fuels (Josimović et al., 2014). The production of such fuels is affected by the prices for oil and oil derivatives, then “food versus fuel” dilemma (which can increase or reduce the level of poverty), CO<sub>2</sub> emissions, sustainable development of biofuel production, increased deforestation, soil erosion, reduction of biodiversity, impact

on the sources of drinking water, as well as by energy efficiency and balance. Not all the biofuels have the same effect on the climate or energy security.

With improvements in the process of extraction from different plant and animal materials and other organic waste, biogas could be produced in large industrial plants but also in small and simple on-farm facilities. For making biogas, one can use fresh biomass from energy crops, manure, secondary products of industrial plant processing, different industrial and farm waste, etc. (Grasi et al., 2004; Glamočlija et al., 2015).

The level of biogas development in Europe differs significantly. Countries like Germany, Austria and Sweden have advanced considerably when it comes to using organic waste for obtaining biogas, while in most eastern European countries large amounts of organic waste and its inadequate disposal pose a huge problem, which has a negative impact on the ecosystem. Lack of awareness of obtaining biogas from these inputs should be changed through educating people and providing a technology suitable for processing these unexploited riches (Janković et al., 2017).

It is important to point out that different fuels have a different impact on climate, securing energy safety and on ecosystems. Thus, one should analyse their long-term impact on the society and the ecosystem and synchronise the production of energy crops with the global demand. The preference should be given to those annual and perennial plants whose productive organs are not used in human diet. Concurrently, these plants prevent soil erosion and yield large biomass for biofuel production, and Sudan grass meets both conditions by producing large above-ground biomass suitable for making gas, liquid and solid forms of biofuels (Pataki, 2011; Ikanović et al., 2013).

Sudan grass is less susceptible to unfavourable environmental conditions and therefore it could be grown in a wide area, thriving in arid areas in Europe (Glamočlija et al., 2011). For making biofuels (biogas or liquid biofuels), harvested biomass has to be chopped to pieces, 2-3 cm in size (Janković et al., 2012).

## **Materials and Methods**

The research was conducted during 2014 and 2015. The field experiment was set up in Stara Pazova on chernozem, in a randomised block system with 5 repetitions. The size of the basic plots was 10 m<sup>2</sup> (5 m x 2 m). The subject-matter of the research was the Sudan grass variety Zora, selected at the Institute of Field and Vegetable Crops in Novi Sad. Sowing was carried out in the last 10 days of April, in both years. The standard practices for growing sorghum were used. The plants were harvested at the beginning of the tasselling stage in the second half of July, after which the yield of the freshly harvested stems was determined. The samples of the freshly harvested biomass were used to analyse morphological characteristics (stem mass, leaf mass). The results were analysed by using the statistical package Statsoft 2012.

As for statistical parameters, the authors used the arithmetic mean, while the significant difference between the mean values was determined with the LSD test.

Meteorological conditions in the both years were favourable for Sudan grass (Tab. 1.). The amount of precipitation was almost the same in the both years (406 mm in 2014 and 408 mm in 2015), while the temperatures were 0.83°C higher in 2014 than in 2015 (20.83°C), Figures 1 and 2.

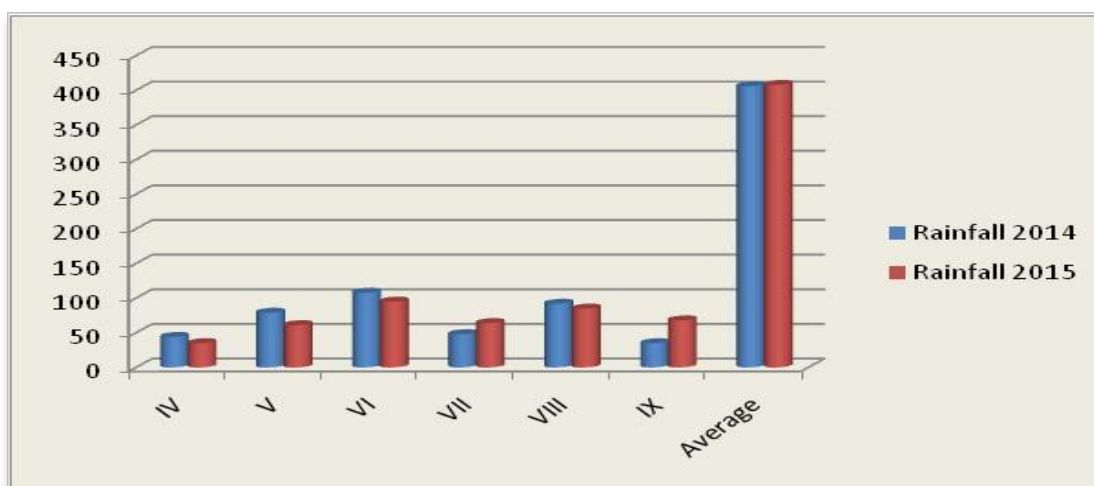


Figure 1. Precipitation during the vegetation season of Sudan grass, mm

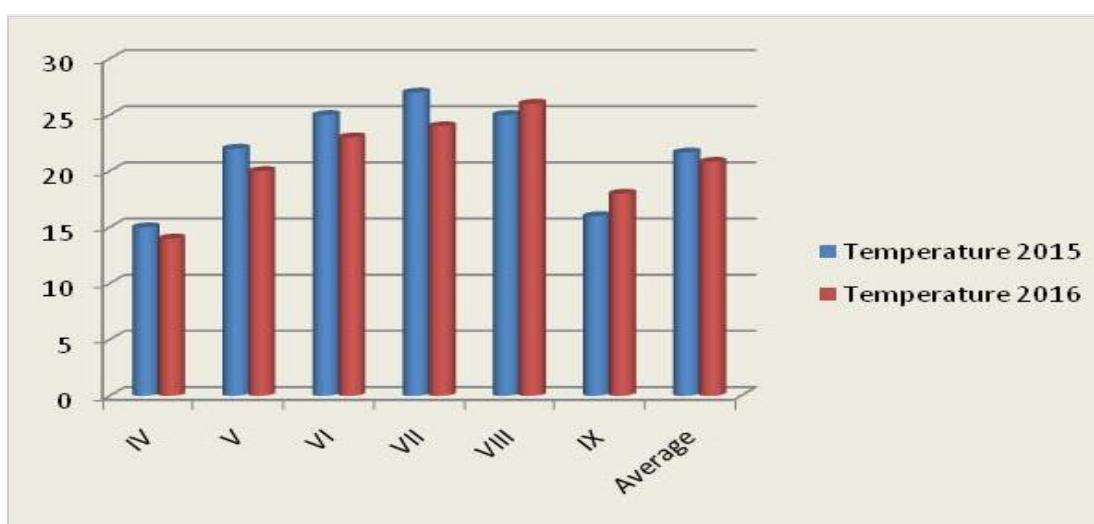


Figure 2. Temperatures during the vegetation season of Sudan grass, °C

### Results and Discussion

From the aspect of environmental protection, Sudan grass could be an alternative “agricultural” crop (on less fertile soil) but also an appreciated energy source in the future, due to its large biomass being a renewable source of energy (Ikanović et al., 2015b). High variability of the *Sorghum* genus enables us to create hybrids for specific use, like hybrids with high concentrations of sugar in the stem, and plants with high concentrations of cellulose are suitable for making bioenergy (renewable energy) (Hovny et al., 2000). Sudan grass is such a plant, and it could be successfully grown in our country. In this research, the year had statistically significant influence on the leaf mass and the biomass yield, Table 1, Figure 3d. In the second year, the mean leaf mass (20.05 g) was statistically significantly higher than in the first year (16.12 g), Table 1, Figure 3a.

Table 1. Descriptive statistics for morphological and production parameters of Sudan grass, variety Zora

Effect	Level of Factor	No	Mean	Std. Dev.	Std. Err	-95,00%	+95,00%
<b>Leaf mass</b>							
Total		10	18.08600	2.769216	0.875703	16.10502	20.06698
Year	2014	5	16.12400	2.185436	0.977357	13.41042	18.83758
Year	2015*	5	20.04800	1.689532	0.755582	17.95017	22.14583
<b>Stem mass</b>							
Total		10	34.12400	7.455467	2.357626	28.79068	39.45732
Year	2014	5	32.16000	7.030505	3.144137	23.43048	40.88952
Year	2015	5	36.08800	8.123590	3.632980	26.00123	46.17477
<b>Biomass yield</b>							
Total		10	38.55700	3.087523	0.976361	36.34832	40.76568
Year	2014	5	36.64400	2.204627	0.985939	33.90659	39.38141
Year	2015*	5	40.47000	2.727545	1.219795	37.08331	43.85669

Parameter		Leaf mass	Stem mass	Biomass yield
LSD	0.5	2.8488	11.0794	3.6167
	0.1	4.1448	16.1194	5.2619

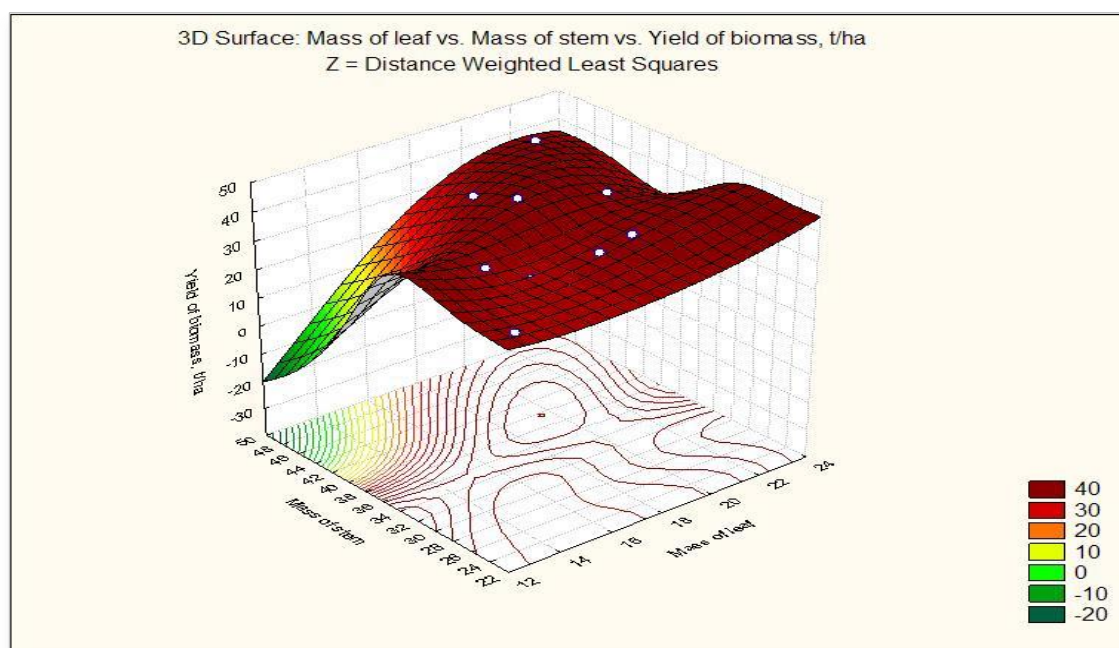


Figure 3. Mean of leaf mass, stem mass and biomass yield



The mean stem mass was higher in the second year (36.08 g) than in the first (32.16 g), but the difference was not significant. The standard error of the mean for the both years was 2.35, Table 1, Figure 3b.

The mean biomass yield was statistically significantly higher in 2015 (40.47 t/ha) than in 2014 (36.64 t/ha), Figure 3c. The standard error of the mean biomass yield was 0.97, Table 1.

#### Correlation of the studied parameters

Data on the variability of Sudan grass and all other plant species and the way of their use are very important for the development of breeding programmes (Ikanovic et al., 2013, 2015a; Glamočlija et al., 2015, Dražić et al., 2016, Kresovic et al., 2016, Sikora et al., 2016, Marišová et al., 2016). The correlation analysis revealed the interaction between variables with statistically significant correlations (Table 2).

A statistically significant positive correlation was found between the leaf mass and the stem mass (0.63), while there were some non-significant positive correlations between the leaf mass and the biomass yield (0.47), and the stem mass and the biomass yield (0.28), Table 2.

Table 2. Correlations of the studied parameters

<b>Variable</b>	<b>Leaf mass</b>	<b>Stem mass</b>	<b>Biomass yield</b>
<b>Leaf mass</b>	1.00	0.63*	0.47
<b>Stem mass</b>	0.63*	1.00	0.28
<b>Biomass yield</b>	0.47	0.28	1.00

The variability of the quantitative and quality characteristics of Sudan grass is significant here and can be used as a good starting point for further breeding work. The leaf and stem characteristics showed a significant influence on the increase in the biomass yield.

Growing energy crops helps in the development of rural areas (through production of inputs), and industrial production, by increasing the possibilities for employment in the primary plant production and in the biofuel production (Marray et al., 2008; Glamočlija et al., 2015).

#### Conclusions

- There are a significant number of plants worldwide, which during the vegetation season produce large biomass that can be used as a source of energy. Prior to introducing these plants into the production, it is necessary to study their biological characteristics and their relationship with the agro-ecological and soil conditions, and accordingly, to apply adequate breeding methods in order to create genotypes with the highest yield.
- From the aspect of environmental protection and due to its large biomass production that can be used as a renewable source of energy, Sudan grass could be an alternative “agriculture” crop (on less productive soil) and also an appreciate energy source in the future.
- The mean stem mass was higher in the second year (36.08) than in the first year (32.16). The mean biomass yield was statistically higher in 2005 (40.47 t/ha) than in 2014 (36.64 t/ha).
- There was a statistically significant positive correlation between the leaf mass and the stem mass (0.63), while non-significant positive correlations were found between the leaf mass and the biomass yield (0.47), and the stem mass and the biomass yield. (0.28)

- In the conditions of extensive climate change accompanied by the increase in global temperatures, the production of Sudan grass could provide inputs and be a source of the local biofuel production.

### **Acknowledgements**

This project was supported by the Ministry of Education, Science and Technological Development of the Republic of Serbia (Projects TR 31066 and TR 31078).

### **References**

- Desai S.A., Rameshwar S., Shrotria P.K. (2000). Variability and Heterosis for Forage Yield and Its Components in Interspecific Crosses of Forage Sorghum, *Karnataka J. Agric. Sci.* 13, 315-320
- Dražić G., Popović V., Ikanović J., Vučković S., Živanović Lj., Tatić M., Kolarić Lj. (2016). Produktivnost biomase agroenergetskih useva –Sorghums - tolerantnih prema uslovima spoljne sredine. / Productivity Biomass Agro-Energy Crops – Sorghums – Tolerants by Environmental Conditions. International Scientific Conference “Agro-energy for Sustainable Agriculture and Rural Development”. Slovak University of Agriculture in Nitra, Faculty of European Studies and Regional Development, September 7th 2016 in Nitra.
- Glamočlija Dj., Jankovic S., Rakic S., Maletic R., Ikanovic J. and Lakic Z. (2011). Effects of Nitrogen and Harvest Period on Biomass and Chemical Composition of Sudan Grass, Fodder Sorghum and Their Hybrid, *Turkish Journal of Agriculture and Forestry*, 35 (2), pp 127-138.
- Glamočlija Đ., Janković S., Popović V., Kuzevski J., Filipović V., Ugrenović V. (2015). Alternativne ratarske biljke u konvencionalnom i organskom sistemu gajenju. Monografija. IPN Beograd / Alternative Crops in Conventional and Organic Growing Systems. Monograph. IPN Belgrade, ISBN 978-86-81689-32-5; COBISS.SR-ID 214569228; 1-355.
- Grassi G., Tondi G., Helm P. (2004). Small-Sized Commercial Bioenergy Technologies as an Instrument of Rural Development. *Biomass and Agriculture: Sustainability, Markets and Policies*. OECD Publication Service, Paris, pp. 277-287.
- Hovny M.R.A., El-Nagouly O.O., Hassaballa E.A. (2000). Combining Ability and Heterosis in Grain Sorghum (*Sorghum Bicolor* (L.) Moench), *Assiut J. Agric. Sci.* 31, 1-16
- Ikanovic J., Popovic V., Trkulja V., Zivanovic Lj., Lakic Z., Pavlovic S. (2013). Morphological Characteristics of the Interspecies Hybrid between Sorghum and Sudan Grass Under Intensive Nitrogen Nutrition, *Genetika, Belgrade*, 45 (1), 31-40. UDC 575:633.17, DOI: 10.2298/GENSR 1301031I, IF 0.492
- Ikanović J., Dražić G., Popović V., Rajić Z. (2015a). Bioenergetski izazov i efikasno korišćenje resursa zemljišta. Comparative Analysis of the Results of the Bioenergy Crop Productivity Grown on Degraded and Fertile Land, *EEE- Energija, ekonomija i ekologija*. List saveza energetičara, 1-2, 96-102. XVII / mart 2015. UDC 620.9, ISSN br.0354-8651
- Ikanovic J., Živanović Lj., Kolarić Lj. (2015b). Agroenergetski usevi u službi ekoremedijacije. Ured. Milovanovic Jelena, Đorđević Slađana: Očuvanje i unapređenje bioloških resursa u službi ekoremedijacije /Conservation and Enhancement of Biological Resources in The Service of Eco-Remediation. Monografija. Futura, Beograd, ISBN 978-86-86859-41-9; COBISS.SR-ID 215624972; 193-262. 1-407.

- Janković S., Rakić S., Ikanović J., Kuzevski J., Živanović LJ., Lakić Ž. (2012). Correlation Coefficients of Morphological-Productive Traits of Species of Sorghum Genus, *Biotechnology in Animal Husbandry*, 28 (3), 585-595.
- Janković S., Glamočlija Đ., Prodanović S. (2017). Energetski usevi, Tehnologija proizvodnje i prerade / Energy Crops. Technology of Their Growing and Processing. Institut za primenu nauke u poljoprivredi, ISBN: 987-86-81689-35-6., pp 272.
- Josimović B., Ilić M., Filipović D., Jovović A., Marković I. (2014). Osvrt na stratešku procenu uticaja na životnu sredinu strategije razvoja energetike Republike Srbije do 2025. godine. /An Overview of The Strategic Evaluation of the Energetics Development Strategy of the Republic of Serbia to 2025 and Its Impact on the Environment. Međunarodno savetovanje, Energetika 2014, Zbornik radova, Zlatibor 25-28.03.2014. UDC 620.9. ISSN 0354-8651 Savez energetičara časopis Energija, ekonomija, ekologija. List saveza energetičara, str 55-61.
- Kresović B., Ikanović J., Rajić Z., Tapanarova A., Dražić G., Popović V. (2016): Kanarska trava kao isplativ i cenjen energent budućnosti / Canary Grass as a Viable Energy Source and Its Future. *Energetika 2016 –Energija, ekonomija, ekologija*, 24-27.3.2016., 1-2, 142-150.ISSN:0354-8651;UDC662.756.3:622.636
- Mađžarević A., Crnogorac M., Živković M., Ivezic D., Petković T. (2014). Procena razvoja politike ublažavanja uticaja na klimatske promene i prilagođavanje klimatskim promenama za Srbiju AMSS metodom. / Evaluation of the Development of the Policy of Mitigating Climate Change and Adjusting Serbian Policies to Climate Change by Using the AMSS Method, Međunarodno savetovanje, Energetika 2014, Zbornik radova, Zlatibor 25-28.03.2014. UDC 620.9. ISSN 0354-8651 Savez energetičara časopis Energija, ekonomija, ekologija. List saveza energetičara, str 148-155.
- Marišová E., Milovanović J., Đorđević S., Jereková Z., Dražić G., Hauptvogel M., Prčik M., Mariš M., Kortla M., Fandel P., Ilkova Z., Gaduš J., Popović V., Ikanović J., Živanović LJ., Radojević U., Kováčik M., Mandalová K. (2016). Agro-Energy for Sustainable Agriculture and Rural Development. Good Practices from Slovakia-Serbia Bilateral Cooperation. Agentúra na podporu výskumu a vývoja and Ministerstvo prosvete, nauke i tehnološkog razvoja, Vlada Republike Srbije- Futura, Faculty of applied ecology, Singidunum University, Belgrade. Monograph. CD Rom Copy, 300. 1-291.
- Murray S.C., Rooney W.L., Mitchell S.E., Sharma A., Klein P.E., Mullet J.E., Kresovich S. (2008). Genetic Improvement of Sorghum as a Biofuel Feedstock: II. Qtl for Stem and Leaf Structural Carbohydrates. *Crop Science*, 48 (6), 2180-2193.
- Pataki I. (2011). Sirak i sudanska trava kao krmne i energetske biljke. / Sorghum and Sudan Grass as Forage and Energy Crops. Zbornik referata sa 45. Savetovanja agronoma Srbije. Institut za ratarstvo i povrtarstvo, Novi Sad, 135-142.
- Sikora V., Popovic V., Zoric M., Latkovic D., Filipovic V., Tatic M., Ikanovic J. (2016). An Agro-Technological Characterization of South-Eastern European Broomcorn Landraces. *Pakistan Journal of Agricultural Research*, 2016, 1-10.

## THE ROLE OF FOREST ECOSYSTEMS IN THE RISK MANAGEMENT OF TORRENTIAL FLOODS (THE GRDELICA GORGE IN SERBIA)

Sonja BRAUNOVIĆ\*, Mihailo RATKNIĆ, Ljubinko RAKONJAC

Institute of Forestry, KnezaViseslava 3, Belgrade, Serbia

\*Corresponding author: sonjabraunovic@yahoo.com

### Abstract

The effects of climate, heterogeneous geological composition, topography, aspect and the quality of forest ecosystems accompanied with adverse human activities brought about intensive erosion processes and frequent torrential floods in the Grdelica Gorge in Serbia. Severe erosion processes led to the loss of soil fertility, devastating effects of torrential flows, poverty of the local population and their migration from the mountain villages into the cities of Serbia. In the 1950's and 1960's, small-scale technical works (torrential dams and inlet structures) were carried out in the riverbeds, while most of the erosion control works were focused on afforestation and establishment of the perennial agricultural cover crop on the surface areas with lower slope inclinations. In order to prevent the development of gully erosion and create favorable conditions for the establishment and growth of seedlings, the conventional afforestation practice by means of dense pit planting was replaced with the construction of biotechnical structures (bench terraces, contour ditches, rustic dams on the slopes etc). These new practices significantly decreased the intensity of erosion and the frequency of torrential floods ( $Z_{\text{mean}} = 0.84$  in 1955,  $Z_{\text{mean}} = 0.33$  in 2016). The paper presents the results of a comparative analysis of the state of forest ecosystems, their share in the total area, population movement, the intensity of erosion and sediment yield in the 1960's and today (the period before and the period after the biological works were carried out).

**Keywords:** *forest ecosystems, risk management, biotechnical structures, the Grdelica Gorge, Serbia.*

### Introduction

In the 1950's, the devastating torrential flows in the area of the Grdelica Gorge (in the south-east of Serbia) continually endangered human lives, arable land and the Belgrade-Thessaloniki highway and railway. No wonder the first organized works on the torrent channel control in this area began in the late 19<sup>th</sup> century (written data from 1907). Different methods and structures for the torrent channel control and the protection of soil against erosion were applied, *i.e.* biological and biotechnical works were applied on the catchment slopes and technical works in the riverbeds. In the period from 1955 to 1966, apart from the dense pit planting as a commonly-used afforestation practice, the application of biotechnical works was initiated and erosion control agrotechnics was introduced in the agricultural production of the hilly-mountainous areas (Braunović, 2013). These biotechnical and biological works were carried out with the aim of rehabilitating the barren land, which occupied 25 % of the Gorge surface area. The pattern of land use, accompanied with the study of climate conditions, topography, geological composition, bedrock and distribution of the observed erosion processes, was one of the key factors in the identification and mapping of erosion process. In order to improve the methods of controlling water erosion and torrential floods, it is necessary to examine the effects of the works carried out so far and their impact both on the state of erosion in the basin and on the protection against torrential floods. The

analysis of the changes in the intensity of erosion in the period from 1953 to 2016 will reveal the causes of its abatement.

### Material and Methods

The 1953 land use pattern was defined on the basis of available documentation (Braunovic, Ratknic, 2012). On the other hand, the current structure of the land use pattern was determined using topographic maps, field mapping and satellite images of the area. Productive areas (forests, degraded forests, meadows and pastures, ploughland, vineyards, orchards, gardens and house yards) and non-productive areas (gullies, rocky grounds, gravel, road network, water courses and settlements) were distinguished and digitized. According to this categorization, there are 2150 homogeneous plots. Sociodemographic characteristics were studied through the analysis of population trends which included 57 settlements (Comparative review of the number of population 1948, 1953, 1961, 1971, 1981, 1991, 2002 and 2011, 2014). We further studied the number and the size of settlements, their population and the population size of the settlements by altitude. The state of erosion was studied in 2 reference periods: in 1953 and in 2016. The 1953 coefficients of erosion ( $Z$ ) were determined based on the available digitized maps of erosion (The state of soil erosion in the Grdelica Gorge and the Vranje Valley, 1956; The Map of Erosion of Serbia, 1983). The erosion coefficients were calculated by the Erosion Potential Model established by prof. Gavrilović (Gavrilović, S., 1972). The values of  $Z$  erosion coefficient were calculated for each homogeneous plot using land survey data (mapping of excessive and intensive erosion processes), data on bedrock, soil, climate and distribution of vegetation. The map was further improved in 2016 with the data obtained from the conducted field research and from satellite images and thematic maps (Ratknić, Braunović, 2016). The total amount of the sediment yield in the catchment was calculated using prof. Gavrilović's Erosion Potential Model.

### Results and Discussion

The comparison of the obtained results with the 1953 data shows that the categories of barren land, forests, meadows and ploughland underwent the most intensive changes (Table 1). Barrens are found on a very small surface area, while the share of ploughland decreased by 26% (due to the abandonment of the ploughland areas above 500 *m a.s.l.*

**Table 1.** Land use pattern in the Grdelica Gorge (in 1953 and in 2016)

LU	1953		2016	
	Area (ha)	Share (%)	Area (ha)	Share (%)
Forests	7792.53	54.55	22865.20	98.58
Degraded forests	6493.77	45.45	329.00	1.42
Forests	14286.30	33.19	23194.20	53.88
Meadows and pastures	3180.95	7.39	10772.61	27.87
Ploughland	14118.43	32.80	2727.59	7.06
Vineyards	628.44	1.46	127.75	0.33
Orchards	-	-	68.26	0.18
Gardens and house yards	185.09	0.43	1296.97	3.36
<b>Productive area</b>	<b>32399.22</b>	<b>75.27</b>	<b>38187.4</b>	<b>88.72</b>
Barren land	9633.25	22.38	105.75	0.06
Beyond the catchment area <sup>8</sup>	1011.53	2.35	4284.53	10.14
<b>Non-productive area</b>	<b>10644.78</b>	<b>24.73</b>	<b>4390.28</b>	<b>11.28</b>
Total	43044.00	100.00	43043.98	100.00

<sup>8</sup> Settlements, built up areas, asphalted roads and water courses

Source: List of torrents of the right and left tributaries of the South Morava River on the Grdelica -Vladičin Han section, 1964; Ratknić and Braunović, 2016

The forests cover of the catchment area increased by 20% and the share of degraded forests decreased by 44% (Figure 1). The right side of the catchment (30234 ha) has 15577.7 ha covered with forests. The coefficient of stocking is 0.51. The left side of the catchment (12818 ha) is covered with forests on 7945.5 ha, 71.4 of which is under degraded forests. The coefficient of stocking of this part of the catchment is 0.64. According to the mean erosion coefficient  $Z_{\text{mean}} = 0.84$ , the Grdelica Gorge area was in 1953 endangered by severe erosion processes. The highest erosion coefficients were determined for the catchments of the Jastrebačka River ( $Z_{\text{mean}} = 1.06$ ), the Palojska River ( $Z_{\text{mean}} = 1.02$ ), the Letoviška River, part of the direct South Morava Basin ( $Z_{\text{mean}} = 0.96$ ) and the Predajene River ( $Z_{\text{mean}} = 0.93$ ). The spatial distribution of the study catchments of the Grdelica Gorge is shown in Figure 2.

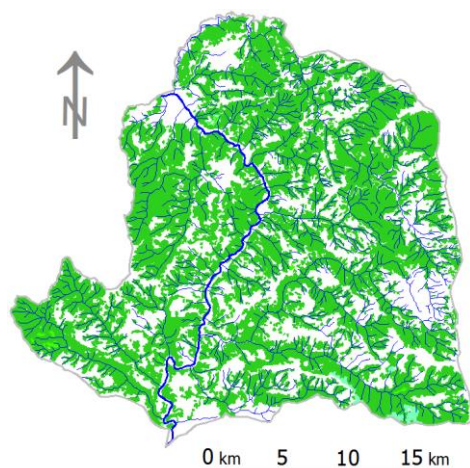


Figure 1. Forest cover map

Source: Authors

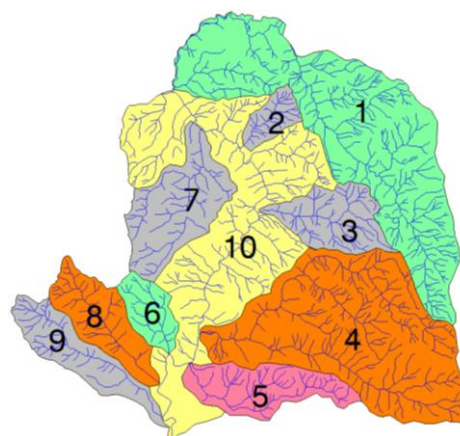


Figure 2. The map of the Grdelica Gorge catchments

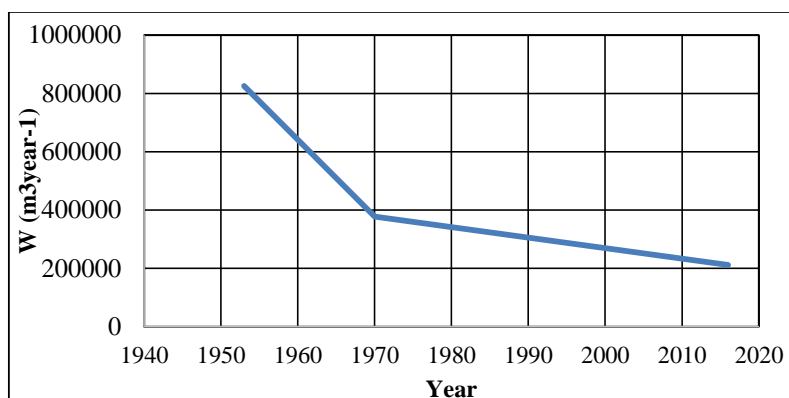
In 2016, a total of 403.06 km<sup>2</sup> or 93.64% of the surface area of the Grdelica Gorge was endangered by erosion processes of different intensities. The mean erosion coefficient was  $Z_{\text{mean}} = 0.34$  (weak erosion). The right side of the basin was characterized by higher  $Z_{\text{mean}}$  values, as was the case in 1953. The processes of severe erosion endangered 0.75% of the total surface area of the gorge.

Table 2. The state of erosion in the Grdelica Gorge catchments in 1953 and in 2016

Catchment	Catchment name	Area (km <sup>2</sup> )	$Z_{\text{mean}}$	
			1953	2016
1	Kozarska River	101.00	0.72	0,27
2	Palojska River	6.87	1.02	0,29
3	Predajane River	19.58	0.93	0,26
7	Bistrica	29.18	0.74	0,21
4	Džepska River	91.88	0.75	0,33
10	Direct basin of the South Morava River	65.44	1.10	0,45
RIGHT TRIBUTARIES		313.95	0.84	0.31
6	Jastrebačka River	9.84	1.06	0.42
5	Koznica	21.57	0.89	0.31
8	Letoviška River	19.60	0.96	0.43
9	Rdovska River	19.36	0.90	0.30
10	Direct basin of the South Morava River	46.12	0.67	0.45
LEFT TRIBUTARIES		116.49	0.80	0.39
Total		430.44	0.83	0.34

Source: Digital Map of Erosion of the Grdelica Gorge, 1953 (Braunović, 2013); Braunović and Ratknić, 2016

The created erosion maps, the data on the share of different categories of destructiveness, as well as the data on the orographic characteristics (Braunović, 2013) make the basis for the calculation of the sediment yield in the study catchments. The obtained results on the changes in the sediment yield in the study period are shown in Graph 1. The sediment yield was reduced by 3.9 times in the period from 1953 to 2016. This reduction was the result of the following factors: reduction in the intensity and the surface area affected by erosion, effects of the conducted erosion control works, abandonment of the arable land at steeper slope inclinations and higher altitudes, natural regeneration of vegetation, *etc.*



Graph 1. Changes in the sediment yield in the study area 1953-2016. (Source: Authors)

The population analysis was done for 57 cadastral municipalities (Figures 3-5). Tables 3-5 show the data on the population trends, the size of settlements and their altitudinal distribution, and Figure 5 shows population projections for 2021 (Penev, 2007).

Table 3. Population trends (1948-2011 Censuses)

Municipality	Population								Reduction (%)		
	1948	1953	1961	1971	1981	1991	2002	2011	1953-1971	1971-2011	1953-2011
Leskovac	12776	13070	14063	14242	14055	13229	12366	10611	+ 9.0	25.5	18.8
Crna Trava	2352	2297	2069	1292	727	359	199	94	43.8	92.7	95.9
Vladičin Han	9094	9351	9932	8679	7484	6029	4682	3304	7.2	61.9	64.7
Surdulica	3127	3461	2976	2271	1901	1185	665	339	34.4	85.1	90.2
Total	27349	28179	29040	26484	24167	20802	17912	14348	17.7	44.2	54.1

Source: Authors

In the period from 1953 to 2016, the population decreased by 51%, mainly in the settlements above 500 m a.s.l., resulting in the abandonment of arable land on steeper slopes, the reduction in the `pressure` on the forested areas and the natural restoration of vegetation. The largest decrease was found in the parts of the municipalities of Crna Trava and Surdulica (Braunović and Ratknić, 2011).

Table 4. Altitudinal distribution of settlements and population

Altitudinal zone	Settlements		Population by census years							
	Number	%	1948	1953	1961	1971	1981	1991	2002	2011
300-500	14	24.6	7974	8381	9458	9225	9331	8795	8281	7118
500-700	18	31.6	7318	7612	7922	7632	7255	6642	5804	4743
700-1000	17	29.8	9199	9383	9038	7797	6608	4851	3518	2332
>1000	8	14.0	2858	2803	2622	1830	973	514	309	155
Total	57	100.0	27349	28179	29040	26484	24167	20802	17912	14348

Source: Authors

The intensive processes of depopulation caused the largest changes in the altitude zone over 1000 m (35-95% reduction) and in the zone from 700 to 1000 m (16.9-75%). The zone from 500 to 700 m had a 38% reduction in the period from 1971 to 2011. The population in the altitude zone of 300-500 m increased in the period from 1948 to 1981, while it decreased by 24% in the last three Censuses (Table 4). In the study period, the number of settlements with a population below 100 inhabitants increased, while the number of the settlements with the population of 301-500 and 501-1000 decreased (Table 5).

Table 5. The number of settlements and the population numbers in the area of the Grdelica Gorge

Settlement size	1953		2011	
	Number of settlements	Population	Number of settlements	Population
below 100	1	51	25	1012
101-300	17	3667	20	3300
301-500	22	8769	6	2334
501-1000	12	8756	2	1480
> 1000	5	6936	4	6222
Total	57	28179	57	14348

Source: Authors

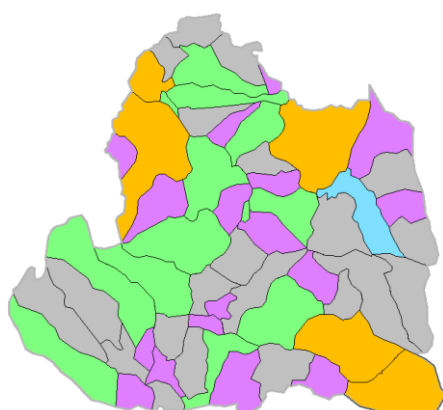


Figure 3. Population in 1953

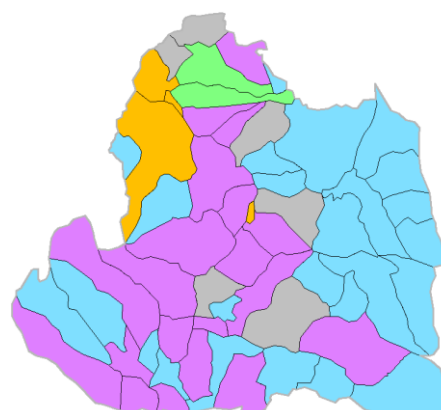


Figure 4. Population in 2011

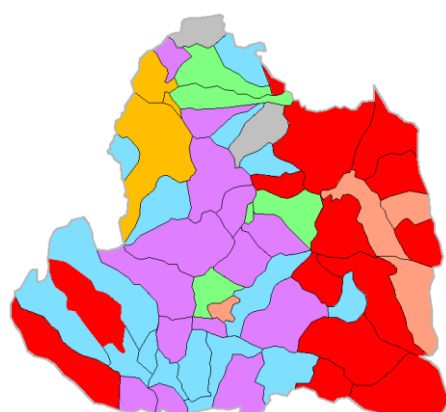


Figure 5. Population projections for 2021

Source: Authors

On the basis of the Register of conducted erosion control works (Jelić, 1978), we further present the scope of the works that include the establishment of mostly conifer plantations on bench terraces, terraces, contour trenches, wattleworks, and grassing of eroded surfaces (Table 6).



Table 6. Register of the works conducted in the Grdelica Gorge (1947-1977)

Grdelica Gorge	Regulations			Cross structures			Biological works	
	Length (km)	Excavation (m <sup>3</sup> )	Wall (m <sup>3</sup> )	Number of structures	Excavation (m <sup>3</sup> )	Wall (m <sup>3</sup> )	Afforest. (ha)	Grass. (ha)
58 torrential catchments	5.96	70405	37389	1087	55472	65087	1041.2	1210.5

Source: Jelić,1978

### Conclusions

In order to improve the methods of torrential flood risk management, a comparative analysis was carried out to examine the changes in the land use pattern and sociodemographic factors, as well as the effects of the conducted works on the intensity of erosion. Non-productive areas (barren land) decreased by 22%, ploughland by 26%, and the areas under forests increased by 20%. The research results show that the conducted EC works (the afforestation of barren land with appropriate soil cultivation techniques on slopes, the appropriate selection of species and methods of planting on the catchment slopes) reduced the intensity of erosion processes in the Grdelica Gorge region. Indirect anthropogenic impacts are the result of accelerated depopulation, demographic aging, reduction of livestock and spontaneous large-scale grassing, while the direct ones resulted from the successful erosion control works performed in the period from 1947 to 1977. The use of forest ecosystems in the protection against erosion through biological and biotechnical works is one of the factors of maintaining the stability of the study area.

### Acknowledgement

This paper was realized as a part of the project ‘The development of technological procedures in forestry with a view to an optimum forest cover realization’ (31070), financed by the Ministry of Education and Science of the Republic of Serbia within the framework of integrated and interdisciplinary research for the period 2011-2017.

### References

- Braunović S. (2013): Effects of erosion control works on the state of erosion in the Grdelica Gorge and the Vranje Valley. Ph.D. thesis, Faculty of Forestry, Belgrade.
- Braunović, S., Ratknić, M. (2011): The impact of the migration of the population from the hilly-mountainous area of Surdulica on the restoration of natural ecosystems. *Ecologica*, No. 64, pp.681-686.
- Braunovic, S., Ratknic, M. (2012): The Change of Land Use - Impact on the Distribution and Intensity of Water Erosion in the Drainage Basin, BALWOIS 2012, Ohrid, Paper No. 495.
- Gavrilović, S., (1972): Engineering in torrential flows and erosion. ‘Construction’, Special Issues, Belgrade
- Jelić, B. (1978): Erosion control works carried out in the Great Morava river basin in the period from 1947 to 1977. ‘Erosion’, No. 9, Belgrade, pp. 25-42.
- Erosion Map of Serbia, 1: 500 000, Institute of Forestry and Wood Industry, Belgrade, 1983.
- Penev, G. (2007): Population Projections of Serbia, Republic of Serbia Review, LI 3, pp. 9-26
- Ratknić, M., Braunović, S. (2016): Status and characteristics of regional water erosion of forest and agricultural land - causes, consequences and erosion control measures, a study, Institute of Forestry, Belgrade (on Serbian)
- <http://www.forest.org.rs/files/studija.pdf> Accessed on 10. 12. 2016.
- Statistical Office of the Republic of Serbia (2014): Comparative review of the number of population 1948, 1953, 1961, 1971, 1981, 1991, 2002 and 2011, Belgrade.

## EFFECT OF THE LOCALITY OF GROWING ON SWEET MAIZE PRODUCTION IN REPUBLIKA SRPSKA

Jela IKANOVIĆ<sup>1</sup>, Sveto RAKIĆ<sup>1\*</sup>, Snežana JANKOVIĆ<sup>2</sup>, Vojislav TRKULJA<sup>3</sup>, Gordana DRAŽIĆ<sup>4</sup>

<sup>1</sup>University of Belgrade, Faculty of Agriculture, Belgrade, Serbia

<sup>2</sup>Institute for Science Application in Agriculture, Belgrade, Serbia

<sup>3</sup>Agricultural Institute, Banja Luka, Bosnia & Herzegovina

<sup>4</sup>“Singidunum” University, “Futura” Faculty of Applied Ecology, Beograd, Serbia

\*Corresponding author: sveto@agrif.bg.ac.rs

### Abstract

Sweet maize has good prospects in Republika Srpska, a place with good market and natural potentials, favourable geographic position and a significant human potential, which is a factor that affects the success of crop production most. The research investigated two sweet maize hybrids – super-sweet sweet maize and normal sweet maize grown during 2013 and 2014 on brown forest-type soil. The following parameters were investigated: plant height, cob length, cob diameter and cob weight. The results show that the genotype, year and locality had a statistically significant impact on plant height. The investigated parameters – average plant height, cob length, cob diameter, cob weight and kernel yield, for both hybrids and both localities, had higher values in 2013 than in 2014. The average plant height, cob length, cob diameter, cob weight and kernel yield were higher in the locality of Banja Luka than in the locality of Dobrnja. The kernel yield was positively and highly significantly correlated with cob length ( $r= 0.83$ ), cob diameter ( $r= 0.87$ ) and cob weight ( $r= 0.60$ ), and positively correlated with plant height. Stronger networking with other countries' agriculture through joint investments and appearance on the global market could significantly improve the economic stability of the counties in South East Europe in general, since food and energy sources of plant origin are the most demanded commodities on the global market.

**Key words:** *sweet maize, locality of growing, morphological and productive properties, correlations, yield.*

### Introduction

Sweet maize is an annual herbaceous plant from the grass family (*Poaceae*), subfamily *Panicoideae*, genus *Maydeae*. This subspecies of maize is grown for its young cobs used exclusively in human diet, directly as cooked or roasted maize but also in the canned food industry (Aćimović, 2003; Sikora *et al.*, 2015). Sweet maize kernels are highly valued foodstuffs for preparing diverse and tasty dishes. Due to its high nutritive value, sweet maize holds first place in grain crop consumption. In our area, this maize subspecies is grown on more and more surfaces, often following the pre-crop and in irrigated fields (Randelović, 2008). With the development of the national processing industry, sweet maize from traditional seasonal food becomes food that is consumed all year round.

Maize production is of great importance in our country and worldwide, since food and energy sources of plant origin are the most demanded commodities on the global market (Ikanović *et al.*, 2015). In mercantile production of all types of hybrid maize, for different use, the main task of production technology is to provide necessary number of plants per unit area and their proper pattern in the field (Popović, 2010, Živanović *et al.*, 2012, Marić *et al.*, 2013a, 2013b).

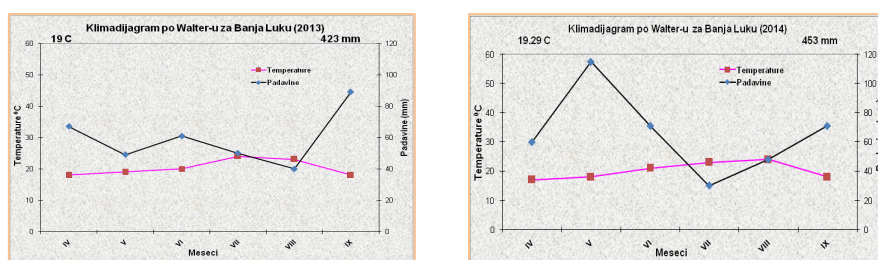
Mercantile sweet maize crops are sown from the beginning of maize sowing in April to stubble sowing at the end of July. In mercantile sweet maize crops, irrigation is a must, starting from the sowing all along to the harvest of cobs with husk (*Sabovljević et al., 1997a, 1997b*). Sweet maize kernels can be preserved longer by freezing or pasteurisation. Due their high nutritive and dietetic value, sweet maize kernels are a highly praised ingredient for different tasty and very nutritious dishes. In Western European countries and the USA sweet maize kernels are quite often used for making different delicacies and therefore they hold first place in grain crop consumption (*Glamočlija et al., 2007*). Daily meals of western European people cannot be imagined without sweet maize. It should be pointed out that nowadays in our country too, sweet maize from a traditionally seasonal product becomes a product that is consumed all year round, due to improvements in kernel processing with the use of pasteurisation or freezing, and having sweet maize in all well-supplied shops (*Glamočlija, 2012*). During processing of kernels, there are also a significant amount of by-products left, plant waste that are used in animal feed, so the whole process of kernel processing and vegetative bio-mass makes one production cycle (*Pandurović et al., 2009; Glamočlija et al., 2013*).

### Material and Methods

As a material for this research, the researchers used the seed of F<sub>1</sub> generation of the following two combinations of sweet maize seed crops, produced by Syngenta: *GSS 8529 F1* – super-sweet sweet maize with a medium period of vegetation (83 days), high yielding potential, plant height of 280 cm, and resistant to maize dwarf mosaic virus (MDMV). Its advantages are: stable yields, regular and wide cobs of 21 cm length and very good husk coverage. It has a good taste and a nice light yellow colour. *ENTERPRAIS F1* – normal sweet maize with the period of vegetation of 93 days. It is very strong and tall, with pronouncedly large cobs, 22-23 cm long. It is resistant to viral infections. The experiments were carried out in two localities: at an experimental field of the Agricultural Institute of Banja Luka and at the village of Dobrnja on Manjača (near Banja Luka) on brown forest soil. In the first locality, the experiment was carried out in the centre-pivot irrigation system, with the soybean as a preceding crop, whereas the experimental field in Dobrnja had also a highly irrigating system but a preceding crop was a fodder mixture comprising fodder peas and oats. Standard cropping practices for sweet maize were applied. During the vegetation period of sweet corn, the researchers in both localities measured the investigated morphological properties – plant height at the stage of maximum growth, cob length, diameter and weight at the stage of technological maturity, and kernel yield. Agrochemical analyses were conducted at a pedological laboratory of the Agricultural Institute in Banja Luka. The analyses identified the contents of basic parameters of fertility, such as: soil pH – potentiometric analysis; CaCO<sub>3</sub> – volumetric analysis according to *Scheibler*; humus – according to *Kotzmann*; total nitrogen – according to *Kotzmann*; easily accessible K<sub>2</sub>O – Al method by *Eigner-Reihm*; easily accessible P<sub>2</sub>O<sub>5</sub> – Al method by *Eigner-Reihm*.

**Soil.** Brown forest soil is mostly moderately hard soil, with a pronounced textural differentiation within the profile. The humus-accumulative horizon is characterised by a favourable water-air regime that comes as a result of a good ratio between large, medium and fine pores. Such soil is well-draining and warm. Chemical properties vary depending on exploitation intensity, erosion intensity, chemical properties of the matrix substrate and the level of soil development. Brown forest soil has no carbonates and it is moderately acidic. It has a medium amount of humus (2-5%) (*Glamočlija et al., 2015*). In areas with this type of soil, a limiting factor can be the climate, namely relatively high annual temperatures and little precipitation. The goal of this research was to investigate the importance of the locality of growing on the hybrids.

**Meteorological conditions.** Meteorological data for 2013 and 2014 were retrieved from the Meteorological Station in Banja Luka. In both production years, temperatures ranged from 19.00<sup>0</sup>C to 19.29<sup>0</sup>C, whereas precipitation was 423 mm in 2013 and 443 mm in 2014, respectively (Graph 1 and 2).



Graph 1 and 2. Total precipitation (mm) and average daily temperatures (<sup>0</sup>C), 2013 – 2014

Maize thrives in good agro-ecological and soil conditions (Sikora et al., 2015). When compared to other maize subspecies, sweet maize is least tolerant to adverse agro-ecological and soil conditions. Hence, it should be grown only on fertile soil, and its sowing should start after spring frosts and be conducted in the irrigation regime, if possible (Ikanović et al., 2007).

### Results and Discussion

The genotype, year and locality had a statistically significant effect on sweet maize plant height. On average, the hybrid *Enterprais* in both localities had higher values for plant height, cob length, cob diameter and kernel yield than the hybrid *GSS 8529*; the latter only had greater cob weight (Table 1). Given that sweet maize is often eaten directly off the cob, cob properties are quite important. Cob shape is very important in the sweet maize processing industry, so breeding is there to create hybrids for different use, i.e. to conform to market requirements (Pajić et al., 2000).

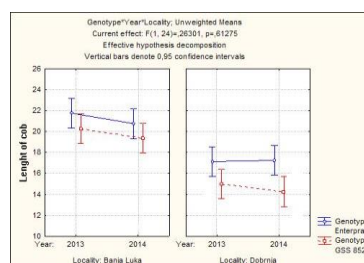
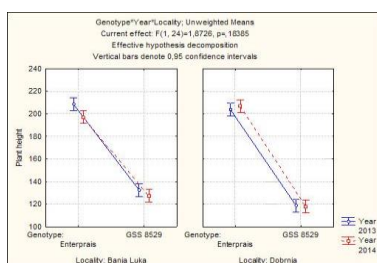
The investigated parameters (average plant height cob length, cob diameter, cob weight and kernel yield) for both hybrids and both localities were higher in 2013 than in 2014. The average plant height, cob length, cob diameter, cob weight and kernel yield were higher in the locality of Banja Luka than in Dobrnja (Table 1, Graph 3, 4, 5 and 6).

In the locality of Banja Luka, the hybrid *Enterprais* had higher values for plant height, cob length, cob diameter and cob weight than the hybrid *GSS 8529*, whereas the hybrid *GSS 8529* had higher kernel yield (Table 1). When observed the average values, the hybrid *Enterprais* had higher values for plant height, cob length, cob diameter and kernel yield than the hybrid *GSS 8529*, whereas the latter had greater cob weight (Table 1). The average cob length for both localities and both hybrids was 18.22 cm (Table 1, Graph 4).

Table 1. Morphological and productive properties of sweet maize hybrids, 2013-2014

Hybrid	Year	Plant height	Cob length	Cob diameter	Cob weight	Kernel yield
<b>Banja Luka</b>						
<i>Enterprais</i>	2013	208.50	21.75	5.48	265.75	17.93
	2014	197.00	20.75	5.53	268.75	17.70
	Average	<b>202.75</b>	<b>21.25</b>	<b>5.50</b>	<b>267.25</b>	<b>17.82</b>
GSS 8529	2013	132.50	20.25	5.25	165.00	18.03
	2014	127.50	19.37	5.08	166.75	17.75
	Average	<b>130.00</b>	<b>19.81</b>	<b>5.16</b>	<b>236.88</b>	<b>17.89</b>
Average		166.37	20.53	5.33	252.06	17.85
<b>Dobrnja</b>						
<i>Enterprais</i>	2013	208.50	17.13	4.35	165.00	11.18
	2014	197.00	17.25	4.20	166.75	10.25
	Average	<b>205.37</b>	<b>17.19</b>	<b>4.28</b>	<b>165.88</b>	<b>10.71</b>
GSS 8529	2013	118.75	15.00	4.23	242.75	9.83
	2014	118.00	14.25	4.25	236.00	9.95
	Average	<b>161.87</b>	<b>14.63</b>	<b>4.24</b>	<b>239.38</b>	<b>9.89</b>
Average 2013		165.87	18.53	4.83	229.00	14.24
Average 2014		162.37	17.91	4.76	225.69	13.91
Average <i>Enterprais</i>		204.06	19.22	4.89	216.56	14.26
Average GSS 8529		124.18	17.22	4.70	238.13	13.89
Average Banja Luka		<b>166.37</b>	<b>20.53</b>	<b>5.33</b>	<b>225.06</b>	<b>17.85</b>
Average Dobrnja		161.87	15.90	4.25	202.63	10.30
Average		<b>164.13</b>	<b>18.22</b>	<b>4.79</b>	<b>227.34</b>	<b>14.07</b>

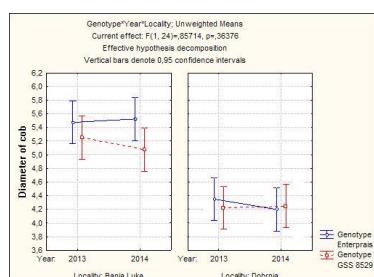
LSD	Plant height				Cob length				Cob diameter				Cob weight				Kernel yield			
	G	Y	L	G x Y x L	G	Y	L	G x Y x L	G	Y	L	G x Y x L	G	Y	L	G x Y x L	G	Y	L	G x Y x L
0.5	1.04	1.04	1.04	2.08	4.08	4.08	4.08	8.17	0.23	0.23	0.23	0.46	2.59	2.59	2.59	5.19	2.87	2.87	2.87	573
0.1	5.64	5.64	5.64	11.29	1.43	1.43	1.43	2.87	0.33	0.33	0.33	0.66	3.58	3.58	3.58	7.17	3.96	3.96	3.96	791



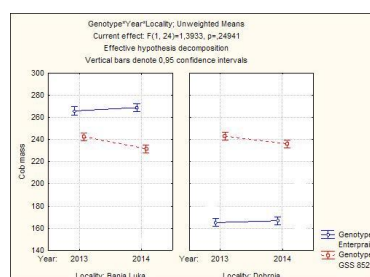
Graph 3. G x Y x L interaction for plant height

Graph 4. G x Y x L interaction for cob length

The average plant height for both localities and both hybrids was 164.13cm (Tab.1, Graph 3). When observed the average values, the hybrid *Enterprais* had higher values for plant height, cob length, cob diameter and kernel yield than the hybrid *GSS 8529*, whereas the latter had greater cob weight (Table 1). The average cob length for both localities and both hybrids was 18.22 cm (Table 1, Graph 4).



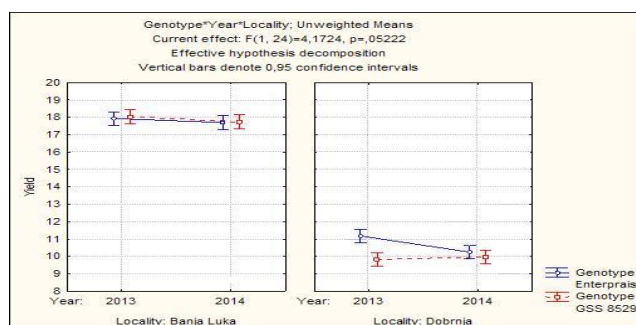
Graph 5. Cob diameter



Graph 6. Cob weight

The average cob diameter for both localities and both hybrids was 4.79 cm (Table 1, Graph 5). The average cob weight for both localities and both hybrids was 227.34 g (Table 1, Graph 6). Apart from yields and pericarp tenderness, each way of use of sweet maize has specific requirements for certain quality (*Pajić et al., 2000*). Taste (sweetness) and cob appearance are most important for fresh consumption of sweet maize. Retaining the sweetness after transportation is also a very important property. The average kernel yield for both localities and both hybrids was 14.07 t ha<sup>-1</sup> (Table 1, Graph 7). In Dobrnja, the hybrid *Enterprais* had higher values for plant height, cob length, cob diameter and kernel yield than the hybrid *GSS*

8529, whereas greater cob weight was recorded for the hybrid GSS 8529 (Table 1). Kernel yield in Banja Luka was statistically significantly higher (17.85 t ha<sup>-1</sup>) than in Dobrnja (10.30 t ha<sup>-1</sup>), Table 1, Graph. 7.



Graph 7. Average kernel yield, t ha<sup>-1</sup>

**Correlations between the investigated parameters.** Kernel yield was positively and highly significantly correlated with cob length ( $r= 0.83$ ), cob diameter ( $r= 0.87$ ) and cob weight ( $r= 0.60$ ), and positively correlated with plant height (Table 2). Cob length was positively and highly significantly correlated with plant height, cob diameter, cob weight and kernel yield (Table 2).

Table 2. Correlation between the investigated parameters

Parameter	Plant height	Cob length	Cob diameter	Cob weight	Kernel yield
Plant height	1.00	0.42*	0.19 <sup>ns</sup>	-0.30 <sup>ns</sup>	0.11 <sup>ns</sup>
Cob length	0.42*	1.0	0.79**	0.37*	0.83**
Cob diameter	0.19 <sup>ns</sup>	0.79**	1.00	0.62**	0.87**
Cob weight	-0.30 <sup>ns</sup>	0.37*	0.62**	1.00	0.60**
Kernel yield	0.11 <sup>ns</sup>	0.83**	0.87**	0.60**	1.00

<sup>ns</sup> – non significant, \* and \*\* significant at the 0.5 and 0.1 levels

Cob weight was highly significantly correlated with kernel yield,  $r= 0.60$  (Table 2). Sweet maize kernels have a high energy and nutritive value, containing up to 80% total carbohydrates (NFE), 8-17% total protein, 10-15% oil, 1.5-2% dietary fibre (cellulose) and about 1% mineral salts (Popović, 2010, Glamočlija et al., 2015). The same authors point out that this group of maize contains twice as less starch (NFE), since the recessive gene slows down its synthesis, retaining monosaccharides and disaccharides to the stage of technological maturity. This type of maize has high protein content, but its kernels contain small amounts of essential amino acids due to the prevailing protein called zein. Kling and Edmeades (1997), Pajić and Dumanović (1998), Jovanović et al. (2006) also point out a high vitamin value of maize, reflected in significant amounts of vitamin V, E and K, as well as in provitamin A in coloured maize. The same authors state there have been a large number of maize hybrids created worldwide for different use – with different lengths of vegetation period, different genes and combinations of genes that increase sugar content in kernels, sugary sweet maize, super-sweet sweet maize – with increased sugar content in kernels.

Almost all the breeding of sweet maize in the world is conducted by private companies, where the breeding material is protected and not available to general public. Sweet maize seed is one of the most profitable commodities.

## **Conclusions**

Sweet maize has good prospects in Republika Srpska, a place with good market and natural potentials, favourable geographic position and a significant human potential, which is a factor that affects the success of crop production most. The genotype, year and locality had a statistically significant impact on plant height. The investigated parameters, such as average plant height, cob, length, cob diameter, cob weight and kernel yield, for both hybrids and both localities had higher values in 2013 than in 2014. The average plant height, cob length, cob diameter, cob weight and kernel yield were higher in Banja Luka than in Dobrnja. The kernel yield was positively and highly significantly correlated with cob length ( $r=0.83$ ), cob diameter ( $r= 0.87$ ) and cob weight ( $r= 0.60$ ), and positively correlated with plant height. Stronger networking with other countries' agriculture through joint investments and appearance on the global market could significantly improve the economic stability of the counties in South East Europe in general, since food and energy sources of plant origin are the most demanded commodities on the global market.

## **Acknowledgement**

The paper is a result of the project TR 31078 funded by the Ministry of Education, Science and Technological Development, Republic of Serbia.

## **References**

- Aćimović B. (2003). Uticaj oblika, veličine i hemijskog sastava semena na klijanje kukuruza / The Impact of Shape, Size and Chemical Composition of Seeds on Maize Germination. Magister thesis. University of Belgrade, Faculty of Agriculture, Belgrade.
- Glamočlija Đ., Ikanović J., Spasić M. (2003). Uticaj dopunske ishrane kukuruza šećerca ekološkim mineralnim hranivima na prinos i kvalitet zrna i nadzemne biomase / The Impact of Side-dressing with Ecological Mineral Fertilisers on Yields, Quality of Grains and Above-ground Biomass of Sweet Maize. Agroiinovacije. Book of Abstracts, Niška Banja, 13.
- Glamočlija Đ., Blažić M., Živanović Lj., Ikanović J. (2007). Proizvodnja kukuruza u uslovima intenzivne ishrane biljaka azotom / Production of Maize in Intensive Nitrogen Plant Nutrition. Proceedings, Belgrade, 31-43.
- Glamočlija Đ. (2012). Posebno ratarstvo (kukuruz) / Special Field Crops Farming (Maize). University of Belgrade, Faculty of Agriculture.
- Glamočlija Đ., Janković S., Popović V., Kuzevski J., Filipović V., Ugrenović V. (2015). Alternativne ratarske biljke u konvencionalnom i organskom sistemu gajenja / Alternative Field Crops in Conventional and Organic Farming Systems. Monograph. Institute for Science Application in Agriculture, Belgrade, 1-355. 150-180.
- Ikanović J., Glamočlija Đ., Sabovljević R., Blažić M., Kulić G. (2007). Uticaj toplotnih uslova na klijavost semena kukuruza šećerca / Impact of Temperature Conditions on Germination of Sweet Maize Seeds. Proceedings, Institut PKB Agroekonomik, Belgrade, 13(1-2), 61-66.
- Ikanović J., Dražić G., Popović V., Rajić Z. (2015): Comparative analysis of the results of the bioenergy crop productivity grown on degraded and fertile land. Energy, economics and ecology. Journal of Association of Power Engineers, 1-2, 96-102.
- Jovanović Ž., Tolimir M., Kaitović Ž. (2006). ZP hibridi kukuruza u proizvodnim ogledima 2005. godine / ZP Maize Hybrids in the Production Trials in 2005. XX Conference on Agronomists, Veterinarians and Technologists, Proceedings, Belgrade, 12 (1-2), 47-52.



- Kling J.G., Edmeades G. (1997). Morphology and growth of maize. Research guide No 9 Training programme, pp. 3-6. International Institute of Tropical Agriculture, Ibaden, Nigeria.
- Marić V., Glamočlija Đ., Popović V., Đukanović L. (2013a). Prinos hibrida kukuruza različitih grupa zrenja u odnosu na gustinu setve u nepovoljnoj godini / The yield of maize hybrids from different maturity groups unfavorable weather. XVII Conference on Biotechnology, Proceedings, Čačak, 15-16 Mar 2013, 18 (20), 77-82.
- Marić V., Glamočlija Đ., Popović V., Đukanović L. (2013b). Prinos NS hibrida kukuruza različitih grupa zrenja u odnosu na gustinu setve / Maize hybrids from different maturity groups over sowing densities. XXVI Conference on Agronomists, Veterinarians and Technologists, Proceedings, Institute PKB Agroekonomik, Belgrade, 20-21 Feb 2013, 19 (1-2), 117-124.
- Pajić Z., Dumanović J. (1998). Specifični tipovi kukuruza / Specific types of Maize. Monograph. Maize Research Institute "Zemun Polje".
- Pajić Z., Dumanović J., Mišović M. And Rošulj M. (2000). Breeding Maize for Nutritional Value and Industrial Use. Maize and Sorghum Breeding at the End of 21st Century. Genetika, 32 (3), 255-282.
- Pandurović Ž., Glamočlija Đ., Stevović V., Dragičević V., Gavrilović M. (2009). Uticaj gustine useva i ishrane azotom na dužinu klipa, broj redova zrna i apsolutnu masu zrna kukuruza / The Impact of Planting Density and Nitrogen Nutrition on Ear Length, the Number of Rows and Absolute Grain Mass of Maize. Journal for Scientific Agricultural Research, 70, 252, 27-34, Belgrade.
- Popović V. (2010). Agrotehnički i agroekološki uticaji na proizvodnju semena pšenice, kukuruza i soje / Agro-technical and Agro-ecological Impacts on Production of Wheat, Maize and Soybean Seeds. Doctoral Dissertation. University of Belgrade, Faculty of Agriculture, 1-145.
- Randelović V., Prodanović S., Glamočlija Đ., Živanović Lj., Dimitrijević B. (2008). Uticaj gustine useva na odnos prinosa i agronomskih osobina kod tri hibrida kukuruza / Effect of Crop Density on Relationship between Grain Yield and Agronomic Traits in Three Maize Hybrids. The Fifth Scientific-Research Symposium on Breeding and Seed Production. Book of Abstracts, Vrnjačka Banja.
- Sabovljević R., Nikolić N., Marković D., Dačić V., Radosavljević N. (1997a). Klijanje hibridnog semena kukuruza u odnosu na tehničku ujednačenost i temperaturu ispitivanja / Germination of Hybrid Maize in Terms of Technical Uniformity and Research Temperature. II JUSEUM, Arandelovac, Book of Abstracts, 32.
- Sabovljević R., Stevanović S., Mišić-Stanković Z., Popović R., Marković D. (1997b). Varijabilnost i klijavost hibridnog semena kukuruza u odnosu na poreklo i temperaturu ispitivanja / Variability and Germination of Maize Hybrid Seed Regarding the Origin and Research Temperature. II JUSEUM, Book of Abstracts, 31.
- Sikora V., Berenji J., Popović V., Brdar Jokanović M., Maksimović L. (2015). Accumulation and distribution of NPK in above ground parts of grain sorghum and maize in intensive production. "Agriculture & Forestry". Podgorica, 61 (1), 223-230, [www.agricultforest.ac.me](http://www.agricultforest.ac.me)
- Živanović Lj., Ikanović J., Popović V., Kajgana M., Rakić S., Milutinović M. (2012). The effect of nitrogen fertilization on yield of maize. Third International Scientific Symposium "Agrosym Jahorina 2012", 215-219.

## **ECONOMIC ASPECTS OF FLOOD CONTROL IN AUTONOMOUS PROVINCE OF VOJVODINA (SERBIA): CASE STUDY FOR THE RIVER SAVA**

Svetlana POTKONJAK<sup>1\*</sup>, Tihomir ZORANOVIĆ<sup>1</sup>, Ksenija MAČKIĆ<sup>1</sup>, Zoran GREGOROVIĆ<sup>2</sup>, Srđan NIKOLETIĆ<sup>2</sup>

<sup>1</sup>University of Novi Sad, Faculty of Agriculture, Novi Sad, Serbia

<sup>2</sup>Hidrozavod DTD Ad, Novi Sad, Serbia

\*Corresponding author: spot@polj.uns.ac.rs

### **Abstract**

The aim of this study was to demonstrate the socio-economic feasibility of protection against flood in the area of the river Sava in Autonomous Province of Vojvodina (Serbia). In this case as a technical solution of protection from external flood water it was proposed construction of new dikes, reconstruction of old dikes and procurement of mobile equipment. The methods that were used for evaluation were: the present value of investment and operating costs, equivalent annual cost, the average economic cost (per 1 ha) of protected areas, average economic cost per protected resident and sensitivity analysis. The study was conducted on the case of the left bank of the Sava River (length 50 km) in order to achieve the optimal level of protection of humans, settlements, agriculture and other material goods in this area. The results of research showed that flood damage to this area could be 3.42 times greater than required investments in the construction of buildings and purchase of related equipment. The largest damage would be on residential buildings and agricultural land. The investments of 3.407 mil. €, in the long term, would protect 23,000 ha of agricultural land, 5,300 hectares of residential and commercial buildings and 135,000 inhabitants.

**Keywords:** *Embankment, Flooding, Investments, Damage, Operating Cost*

### **Introduction**

For the research of the regulation of the Sava River on the territory of Republic of Serbia and Autonomous Province of Vojvodina (APV) can be approached from different aspects (flood control, agriculture, navigation, hydropower). Most commonly it is the integration of development on the entire basin of the Sava River (EC, 2013). In our study, the regulation of the watercourse Sava was investigated from the aspect of planning of the construction and reconstruction of protective objects (embankments) on the left bank between settlements Progar and Hrtkovci which belong to AP Vojvodina (Gregorović and Potkonjak, 2017). In order to achieve the optimal level of protection of people, material goods, infrastructure, industrial plants, cultural and historical monuments from the relevant large waters of the Sava River, the proposed solutions have been analyzed from several aspects (hydrological, hydraulic, economical and ecological). In this paper, emphasis is placed on the economic aspect of flood protection and economic consequences in case the regulation does not realize. In other countries, the problem of flood control is often investigated and always relevant. (UK, Netherlands, Denmark).

The methodological approach to the assessment of flood damage, especially on urban areas, has often been studied and improved in case studies done for individual watercourses. The example of a complex study is for the city of Prague (Genovese, 2006). It contains: risk assessment and flood management, as well as the assessment of flood damage in the previous and future periods.

The European flood protection strategy has been implemented, in great number of countries (in Europe), in the Law on Waters. In the Republic of Serbia, flood protection is regulated in the Law on Waters and the Law on Planning and Construction of objects. There is also a methodology for estimating damage from natural disaster, but it is used only after its occurrence.

### **Material and Methods**

The research was carried out from the hydrological, hydrotechnical, economic and ecological aspects. Each aspect required its own methods of research. In this paper, special attention has been aimed to economic aspects. Solving this problem from the hydrotechnical aspect referred to the selection of water management facilities and their dimensioning that will protect the area from floods for 100- years flood protection. Analysis of the water level of the Sava River, hydrotechnical and geodetic surveys and measurements were used in the selection of types of objects and their dimensioning. In the assessment of economic justification, several methods were used: investment, analytical and differential calculations. The investment calculation is adjusted to the specifics of the proposed technical solution of the embankment. Analytical calculation was used to calculate values and costs of agricultural production, as well as to calculate the annual costs of the functioning of the embankment. Differential calculation in this study was used to calculate lost profit in case the proposed objects are not built. Similar methods of research were used in the Netherlands as well. Brauwer and Kind (2005) presented three different case study examples using cost-benefit analysis in the specific area.

### **Results and Discussion**

On the basis of hydrological research in previous period on the part of watercourse of Sava River in the AP Vojvodina, especially on the left bank between the settlements of Progar and Hrtkovci, a plan for protection from large waters and floods (100-years flood protection) is proposed. The defence line is about 50 km in length. The proposed regulation can be realized in 8 sections that are independent of each other. The construction sequence is ranked according to the effects that can be achieved. The water management facilities that are in this case proposed for the protection of coastal land and settlements are embankments that need to protect 236 ha under settlements, 1017 ha of arable land and 6021 inhabitants. The necessary investments for realization of this plan amount 3,407,788.25 EUR , determined on detailed investment calculations (Table 1). Annual operating costs include: maintenance, insurance, labour and overheads. These costs are compared with investments (Table 1). The largest amount of investment and annual operating costs is in section VI.

Benefits that can be expected after the construction of these objects can be classified as direct and indirect. Direct benefits are manifested through reduction of flood damage on agricultural and municipal building land, residential and commercial objects, roads and other infrastructure. Indirect benefits in this case refer to the enabling of favourable conditions for the development of agriculture, the protection of settlements and population, as well as further economic development of the area. For this purpose, statistical data were collected for settlements and agricultural land that are subjected to further processing (Table 2). Analysis of agricultural production was also performed for 6 most common crops in the municipalities of Ruma and Pecinci, to which belong vulnerable settlements (Table 3).

Based on the previous data, it can be concluded that this area belongs to the moderately populated area with medium sized developed transport infrastructure and medium income

land value. It is defended with 100- years flood protection. The profit calculation is based on the following hypothesis:

Profit-benefits from the construction of these objects in this case also present economic damages that are removed with their construction. Determination of economic benefits, that is elimination of damage on agricultural land and residential and commercial objects that would be under the impact of floods, is done by comparing profit after and before construction of these objects (lost profit).

Table 1. Comparison of investment and annual operating costs

Var.	Section	Investment EUR	Annual operating cost, EUR
I, Var.1	Progar-Kupinovo and sett. Kupinovo	1.058.644,00	14.821,02
II	Kupinovo-Obrež	240.464,00	3.366,49
III	Obrež	0,00	0,00
IV	Obrež-Grabovci	0,00	0,00
V	Grabovci	23.908,17	334,71
VI	Grabovci-Klenak	1.543.618,00	21.610,66
VII	Klenak	534.282,80	72479,96
VIII	Klenak-Hrtkovci	6.870,83	96,19
	Total,EUR	3.407.788,00	47.709,04

\*Source: Authors data from case study

Table 2. Basic information about settlements in the protected area

No.	Settlement	No. settle ment	No. house hold	Persons per household	Area, ha	Agricul. land, ha	No. of dwellings	Floor area, m <sup>2</sup>	Municipa lity	Density /km <sup>2</sup>
1	Prodar	1445	445	3,27			613	49543	Surčin	
2	Kupinovo	1886	668	3,06	8120	2566	800	65997	Pećinci	24
3	Obrež	1308	431	3,25	6559	2119	547	39826	Pećinci	21
4	Grabovci	1189	499	2,97	6465	2098	473	32475	Ruma	23
5	Klenak	2946	1096	2,96	4366	1451	1277	91461	Ruma	58
6	Hrtkovci	3036	1171	2,93	4131	3409	1160	92422	Ruma	82
	Total	11810	4310							

\*Source: Census of Agriculture (2012), Belgrade

In this case, there is no classic profit calculation. There are only annual operating costs of these objects, and instead of generating income, the construction of objects (embankments and mobile equipment) eliminate the economic damage. The degree of accuracy in calculating damages is quite low, but it can provide the basis for determining social economic efficiency. Calculation of profit loss is also based on the assumption that different crops (cereals, industrial and fodder plants, vegetables, orchards) may be planted on this endangered area of 617 ha. The calculation of the effects was performed for each crop individually (Table 3). The obtained costs, profits and production values were used for the calculating potential flood damage for settlements: Kupinovo (Pećinci municipality), Grabovci and Klenak (Ruma municipality). The lower and the upper value of the lost profit depend on the type of crop, (Table 4).

Table 3. Analysis of agricultural production (average values for ten last years)

No.	Crops	Average yield, t/ha		Value of production, €/ha		Costs of production, €/ha		Profit, €/ha	
		Ruma	Pećinci	Ruma	Pećinci	Ruma	Pećinci	Ruma	Pećinci
1	Wheat	5.2	4.63	536	489	377	364	159	125
2	Maize	6.69	6.76	985	761	527	486	458	275
3	Sugar beet	52.86	51.04	1532	1418	1366	1285	166	133
4	Sunflower	2.47	2.54	722	654	459	426	263	228
5	Beans	1.55	1.59	1793	1532	665	607	1128	925
6	Potatoes	1.91	14.89	3840	2348	1351	1241	2489	1107

\*Source: Census of Agriculture (2012), Belgrade

Estimation of damage from possible floods (with and without objects) implies natural and financial amount of absent agricultural production and damages to residential and commercial objects due to floods compared to actual conditions (without floods).

In this case, it is possible to assume different cases of flood damage in this area, depending on the season of flood occurrence and its probability. The assumption is 100% loss of yield.

Table 4. The potential loss of production value and profit

Settlement	Area, ha	Lost profit, € per year		Lost production value, € per year	
		lower value	upper value	lower value	upper value
Kupinovo (Pećinci)	227	28375	251289	111003	532996
Grabovci (Ruma)	138	21942	343482	73968	529920
Klenak	252	40068	627228	135072	967680
Total	617	90385	1221999	320043	2030596

\*Source: Authors data from case study

In the flood damage evaluation, only direct damages are calculated (Table 5). There are also indirect damages that are not insignificant and could amount up to 30% compared to direct damages.

Comparison of damage and total investments (investment for construction + operating costs for a period of 30 years) shows that for the whole project (by 100-year flood protection) flood damage would be 3.42 times higher than the required investment. Observed by sections, the best ratio (damage / investment) is for sections 5, 7 and 1, respectively, while the sections 2, 6 and 8 have unsatisfactory ratio, less than 1. This data can be used to rank the order of construction of individual sections (Table 6).

Unit damages (€/ha) on agricultural land are calculated for the municipalities of Pećinci (1,200.33 €/ha) and Ruma (1538 €/ha) based on the average value of lost production for 6 most common crops (wheat, corn, sugar beet, sunflower, beans and potatoes). The settlements that will be protected by this embankment belong to these municipalities. These values are shown in Table 5, column 4.

In the case of agricultural land and buildings, only direct damages are counted. There were no valid data for the calculation of indirect damages.

Table 5. Calculation of direct damages for 100 - year flood protection

No.	Section	Arable land, ha	Unit damage, EUR/ha	Total damage, EUR	Settlement, no.	Damage, EUR/ha	Total damage, EUR	Total, EUR
I	Progar-Kupinovo Kupinovo	289	1,200.33	346,896.33	150	55,000.00	8,250,000.00	8,596,896.33
II	Kupinovo-Obrež	36	1,200.33.	43,212.00				43,212.00
III	Obrež							
IV	Obrež-Grabovci							
V	Grabovci				9	67,500.00	607,500.00	607,500.00
VI	Grabovci-Klenak	582	1,568.00 1	912,576.00	15	80,833.33	1,212,500.00	2,125,076.00
VII	Klenak	105	1,568.00	164,640.00	62	80,833.33	5,011,666.67	5,176,306.67
VIII	Klenak-Hrtkovci	5	1,568.00	7,840.00				7,840.00
	<b>Total</b>	<b>1017</b>		<b>1,475,164.33</b>	<b>236</b>		<b>15,084,666.67</b>	<b>16,556,831.00</b>

\*Source: Authors data from case study

Table 6. Comparison of damages and total investment (investment+operating costs)

No.	Section	Damages (100- year flood protection) EUR	Investment + operating cost, EUR	Damages (2 and 10 year flood protection), EUR	Ration Damages/Total Investment
I, VI	Progar-Kupinovo and Kupinovo	8,596,896.33	1,503,274.71	2,679,144.00	5,71
II	Kupinovo-Obrež	43,212.00	341,458.87		0,12
III	Obrež		0		
IV	Obrež-Grabovci		0		
V	Grabovci	607,500.00	33,949.59		17,89
VI	Grabovci-Klenak	2,125,076.00	2,191,937.90		0,96
VII	Klenak	5,176,306.66	758,681.62	1,265,376.00	6,82
VII I	Klenak-Hrtkovci	7,840.00	9,756.00		0,80
	Total, EUR	16,556,831.00	4,839.059.31	3,944,520.00	3,42

\*Source: Authors data from case study

### Conclusions

The results of this multidisciplinary research show the complexity of the problems in resolving flood control on the watercourse of Sava . Beforehand it is needed to make observations and field measurements on the basis of which a technical solution for protection will be proposed. The value of the defended assets also affects the selection of solution.

In this study, a part of the watercourse of Sava was observed, between the settlements Progar and Hrtkovci (about 50 km, the left bank), which is under the jurisdiction of the public water management company "Vojvodina Waters". The proposed technical solution for implementation is that the regulation is carried out by sections (a total of 8 sections), by building embankments and purchasing mobile equipment. Economic and environmental analysis should provide other data that are necessary for making a final decision.

The economic aspects of flood control for the proposed location included: the calculation of the required investments, long term operating costs, damages due to flooding (return period 2, 10 and 100 years), lost production value, value of lost property.

On the basis of these parameters, it can be concluded that the realization of this project in whole (all 8 sections) is economically justified. If observed by parts of 3 sections, the calculated economic indicators are worse.

### **References**

- Brouwer R., Kind J.M. (2005). Cost-benefit analysis and flood control policy in the Netherlands. Part in : Cost-benefit-analysis and Water Resources Management. Edward Edgar Publishing, USA, pp 93-123. Bodmin, Cornwall.
- Dubgaard A., et al., (2005): Cost-benefit analysis of river restoration in Denmark. Part in : Cost-benefit-analysis and Water Resources Management. Edward Edgar Publishing, USA, pp 124-150. Bodmin, Cornwall.
- EC (2014). Regional reconstruction and improvement of flood protection infrastructure in the Sava river basin. IPA Project.
- EU (2013). Integration of water protection in development in the Sava river basin. Sava river basin management plan. pp. 82
- Genovese E. (2006). A methodological approach to land use-based flood damage assessment in urban areas: Prague case study. European Commission, Joint Research Centre,
- Gregorović, Z., Potkonjak, S. (2017). Prefeasibility study of construction the flood protection facilities on the left bank of Sava river" from Progar to Hrtkovci settlements. Hidrozavod DTD, Novi Sad, pp. 54.
- Green C. (2000): Best practice methods for valuing flood control benefits. Review III.1. Flood Hazard Research Center, Middlesex, University, UK.
- Pearce D.W., Smale R. (2005). Appraising flood control investments in the UK. Part in : Cost-benefit-analysis and Water Resources Management. Edward Edgar Publishing, USA, pp 71-92. Bodmin, Cornwall.
- Statistical office of the Republic of Serbia (2016). Statistical yearbook of the Republic of Serbia
- Statistical office of the Republic of Serbia (2012). Census of Agriculture. Special publication.
- Zlatić M., Todosijević M., Momirović V. (2015). Economic justification of investment in defense against torrential floods on the example of the Ljubovidja river. Bulletin Faculty of Forestry, Belgrade, no. 112, pp. 121-134.

## EFFECT OF INVASIVE SPECIES *IMPATIENS PARVIFLORA* ON SOIL MICROBIAL INDICES IN THE PROTECTED AREAS IN SLOVAKIA

Lenka BOBULSKÁ\*, Lenka DEMKOVÁ

Department of Ecology, Faculty of Humanities and Natural Sciences, University of Prešov, 17. Novembra 1, 080 01 Prešov, Slovakia

\*Corresponding author: bobulska.lenka@gmail.com

### Abstract

Biological invasions are one of the main threats to natural ecosystems and the impact of invasive plant species on native species, communities, ecosystems and soil biota has been widely recognized over the last decades. Costs of invasive species are estimated to range from millions to billions of euros annually and the success of invasive species has been attributed to their biological and ecological traits. Our study aimed to assess the effect of invasive plant species *Impatiens parviflora* on selected soil microbial indices and physicochemical characteristics. The research was carried out during a vegetation season on 3 protected areas of North-Eastern Slovakia in 2015. Soil reaction, soil organic carbon, bulk density, soil porosity and soil moisture were selected to determine soil physicochemical properties. As the microbial indices, that mainly indicate soil microbial activity, we selected soil microbial respiration and soil enzymatic activity (urease, acid and alkaline phosphatases). The results showed that *I. parviflora* prefers acidic and non-compacted soil conditions. The results also suggested that biology of the invasive plants had the high impact on soil ecosystem and soil enzyme activity played an important role in nutrient cycling in the ecosystems, and thus could be considered as biological indicator of soil health and environmental changes.

**Keywords:** *Impatiens parviflora*, *Enzymatic activity*, *Protected areas*, *Soil characteristics*.

### Introduction

Invasive plants dramatically influence biodiversity in non-native areas and often create monocultures where diverse plant communities previously existed (Zhang *et al.*, 2009). Changes in the plant species composition might result in changes in the enzymatic activities of the microbiota. Such changes could be particularly important in plant communities that are heavily invaded by exotic species. Invasion of those species can alter many ecosystem properties, including important soil function and characteristics (Kourtev *et al.*, 2002). Therefore, the documented impacts on soil properties are diverse. In addition, the same species may have different impacts, depending on local conditions (Dassonville *et al.*, 2008). In general, exotic invasive species have higher net primary productivity and higher turnover rates of carbon and nitrogen, but the opposite pattern was also found. These impacts are also mediated by alteration in soil microbial communities (Herr *et al.*, 2009, Kourtev *et al.*, 2002). Moreover, one of the mechanisms of invasive species success is the production and release of allelopathic compounds by invader that are harmful to plant neighbours (Baležentienė and Renčo, 2014).

Characterization of soil state may be mediated by physical and biochemical parameters related to certain soil processes and functions. Monitoring of soil quality and health relies on the use of specific indicators. Mostly biochemical properties are considered to be the best indicators for assessing soil quality, but their use is limited by the lack of available data



(Doran and Zeiss 2000; Miralles *et al.*, 2007). Soil microbial activities, including enzyme activities, are more sensitive compared to physical and chemical properties to changes in soil quality and can be easily quantified. Soil biochemical properties are regarded as relevant indicators of soil quality from an environmental viewpoint and could be useful for monitoring changes in many type of ecosystems (Kizilkaya *et al.*, 2004; Nowak and Schneider, 2017). The aim of this study is to assess the effect of invasive plant species *I. parviflora* on selected soil physicochemical characteristics and soil microbial indices.

## Material and Methods

### *Site description*

The research was carried out during a vegetation season (July 2015) in 3 protected areas of North-Eastern Slovakia - National Nature Reserve (NNR) Šarišský hradný vrch, National Nature Reserve (NNR) Kokošovská dubina and Nature Reserve (NR) Fintické svahy in 2015. One native site, without *I. parviflora*, was also included for comparative purpose (as Control site). This region is known for its high diversity of animal and plant life, and all these forms are highly responsive to environmental changes. Mostly moderate Cambisols are typical in all researched areas in warm, medium wet climatic regions with the cold winter. The soil was sampled in three different microhabitats - meadows (a habitat without tree vegetation), a habitat close to the stumps (as the bottom part of a tree left) and a habitat under dense tree vegetation, in each natural reserve. Soil samples were taken in triplicates from all the microsites to ensure high homogeneity of the measured data. Obtained data were tested by mathematical-statistical methods from which analysis of variance and regression analysis were used (the Statgraphics software package).

### *Soil physicochemical analysis*

Air-dried soil samples were used to measure soil pH and organic carbon content. Gravimetric soil moisture was calculated on 10g of fresh subsamples after drying in a 105 °C oven for 24 hours. Soil pH was detected in a 1:3 mixture of soil and 0.01M CaCl<sub>2</sub> solution using a digital pH meter. Soil organic carbon (SOC) was determined by the Turin's method. Soil bulk density [t.m<sup>-3</sup>] and porosity [%] were evaluated in a Kopecky physical cylinder with a capacity of 100 cm<sup>3</sup> (Fiala *et al.* 1999).

### *Soil respiration and enzyme assays*

Soil microbial respiration was (SMR) measured by the CO<sub>2</sub> released from 100g samples of field moist soil in 500 mL hermetically sealed flasks at 25 °C for 14 days. CO<sub>2</sub> was captured by its reaction with NaOH (1 mol L<sup>-1</sup>) and titrated with HCl (0.5 mol L<sup>-1</sup>) after the addition of BaCl<sub>2</sub> (1 mol L<sup>-1</sup>). The concentration of the released carbon was estimated in µg C-CO<sub>2</sub> g soil dry<sup>-1</sup> day<sup>-1</sup> (Alef and Nannipieri 1995). Enzymatic activity assays were determined using previously selected analysis of field-moist soil samples, which were sieved and properly homogenized. Activity of acid and alkaline phosphatase was determined by Grejtovský (1991) and urease activity by Khaziev (1976).

## Results and Discussion

All research sites were located in the forest biotopes that naturally give the ecosystem acidic soil reaction. Lower pH was observed in NR Fintické svahy, as well as organic carbon content. All determined soil physical and chemical average parameters are referred in Table 1.

Soil pH is an important factor of soil health despite of the fact that its value changes under internal and external factors. Jurko (1990) and Chmura (2006) confirmed that *I. parviflora* prefers acidic soil reaction, which was also shown in our study. Chmura (2006) also found out the highest influence of chemical features (organic carbon and nitrogen content) of species *I. parviflora* near the stump habitats. Soil physicochemical characteristics are indicators of soil ability to absorb and maintain soil water. Soil bulk density, porosity, soil moisture, organic matter and soil reaction are considered as ones of the basics soil physical and chemical properties (Fazekašová *et al.*, 2011). Soil moisture is considered to be one of the most important factors affecting soil respiration, but our study did not show this significant relation which was also found in the study of Bobuřská *et al.* (2015). The highest soil moisture was also measured in NR Fintické svahy, especially in the stump habitats. Coombe (1956) states that *I. parviflora* grows on non-compacted and structured soils maintained high humidity, except of flooded localities. Bulk density is closely connected to the total soil porosity. In NR Fintické svahy, the presented research encountered both, the highest porosity and the lowest bulk density in soil. The previous studies also proved that the abundance and biological characteristics of *I. parviflora* also depends on soil physicochemical properties (Bobuřská *et al.*, 2016), but our study also confirmed that soil microbial activity is very important factor in characterization of soil state.

Table 1. Soil physicochemical characteristics of three microhabitats in nature reserves

Natural reserves	Microhabitats	pH/CaCl <sub>2</sub>	Bulk density [t.m-3]	Porosity [%]	Soil moisture [%]	SOC [%]
NNR Šarišský hradný vrch	Meadow	6.7	1.33	49.81	26.2	5.13
	Habitat under tree vegetation	6.5	1.15	56.60	35.8	5.08
	Stumps habitat	7.1	0.94	64.53	34.9	4.99
NNR Kokošovská dubina	Meadow	6.2	1.12	57.54	30.7	5.20
	Habitat under tree vegetation	7.0	0.95	64.15	35.8	5.12
	Stumps habitat	6.2	1.11	58.11	36.9	5.08
NR Fintické svahy	Meadow	5.9	0.86	67.55	33.0	5.15
	Habitat under tree vegetation	5.8	0.87	67.17	40.3	5.02
	Stumps habitat	5.4	0.62	76.60	54.8	4,88
Control site		7.2	1.09	49.96	31.5	5.98

Determination of the intensity of microorganisms' respiration is of great importance. It refers not only to the overall biological activity of the soil, but also the speed of mineralization processes. In addition to temperature and humidity, soil respiration is influenced by the quality and supply of nutrients in the soil, soil texture, soil aeration, type of ecosystem, and increasingly also by soil managements. In general, invasive species might increase the activity of microbial parameters, as well as the functional diversity of microbial communities with the significant carbohydrate utilization (Zhang *et al.*, 2009) that characterize stress of the bacterial

communities due to poor nutrient status (Pessi *et al.*, 2012). Also in our study, the sites with the invasive species showed higher values of microbial parameters compared to the control sites (\* $p < 0.05$ ). Average values of the selected soil biological (microbial) parameters, such as soil microbial respiration (SMR) and soil enzymatic activities, are given in Table 2. Soil basal respiration was higher under the stumps habitat that was represented by the highest plant individuals with the most number of flowers/fruits as it was mentioned in the previous biological study of *I. parviflora* (Bobuřská *et al.*, 2016). Castillo and Joergensen (2001) pointed out that almost all biological properties are significantly influenced by environmental management, of which the soil respiration was the parameter most affected by way of different management and many other factors. Same trend was also observed with the soil urease activity that tends to increase the pH of the environment as it produce ammonia as a basic molecule (Monreal and Bergstrom 2000). There are a number of enzymes in soil, depending on diversity of soil organisms and conditions of organic substances turnover. Several factors may affect directly or indirectly the activities of soil enzymes (Okur *et al.*, 2010). Soil reaction differs from the pH optimum for phosphatase activity. Soil phosphatase activity is higher in soils with high humidity and because phosphatases have different optimal pH, therefore are divided into acid and alkaline phosphatases (Speir *et al.*, 2003). Phosphatases are produced not only by the microorganisms, but also by higher plants. In our study, activity of acid phosphatase was higher compared to alkaline phosphatase activity in all localities (\*\* $p < 0.01$ ), which was closely connected to acidic condition on the research sites. Also the activity of acid phosphatase was significantly higher (\* $p < 0.05$ ) in the microhabitat under tree vegetation. The high activity of this enzyme may originate from roots of such higher plants (Senga *et al.*, 2011).

Table 2. Soil microbial characteristics of three microhabitats in nature reserves

Natural reserves	Microhabitats	SMR [ $\mu\text{g C-CO}_2/\text{g soil}$ ]	Urease [ $\text{mgNH}_4^+ \text{ N g}^{-1} \text{ d}^{-1}$ ]	Acid Phosphatase [ $\text{mg P g}^{-1} \text{ 3h}^{-1}$ ]	Alkaline Phosphatase [ $\text{mg P g}^{-1} \text{ 3h}^{-1}$ ]
NNR Šarišský hradný vrch	Meadow	103.55	0.43	377.81	266.23
	Habitat under tree vegetation	127.85	0.55	466.60	305.56
	Stumps habitat	172.05	0.74	394.53	340.09
NNR Kokošovská dubina	Meadow	105.67	0.42	588.54	400.75
	Habitat under tree vegetation	120.41	0.49	603.15	405.83
	Stumps habitat	135.45	0.80	599.11	389.93
NR Fintické svahy	Meadow	112.08	0.52	467.55	334.06
	Habitat under tree vegetation	125.46	0.63	527.17	406.31
	Stumps habitat	129.89	0.92	516.60	440.18
Control Site		100.88	0.41	237.99	250.65

## Conclusion

Soil microbial indices, as well as biochemical are sensitive to not only under the influence management changes, but under the environmental changes. Our findings showed that *I. parviflora*, as invasive plant species, prefers acidic and non-compacted soil conditions. The results also suggested that biology of the invasive plants had the high impact on soil ecosystem and soil enzyme activity played an important role in nutrient cycling in the ecosystems, and thus could be considered as biological indicator of soil health and environmental changes.

## Acknowledgement

The work was supported by the Agency of Ministry of Education, Science, Research and Sport of the Slovak Republic Vega No. 2/0013/16.

## References

- Alef K., Nannipieri P. (1995). Methods in applied soil microbiology and biochemistry. London: Academic Press.
- Baležentienė L., Renčo M. (2014). Phytotoxicity and accumulation of secondary metabolites in *Heracleum mantegazzianum* (*Apiaceae*). *Allelopathy Journal*, vol. 33, pp. 267-276.
- Bobuľská L., Fazekašová D., Angelovičová, L., Kotorová, D. (2015). Impact of ecological and conventional farming systems on chemical and biological soil quality indices in a cold mountain climate in Slovakia. *Biological Agriculture and Horticulture*, vol. 31, pp. 205-218.
- Bobuľská L., Macková D., Malina R., Demková L. (2016). Occurrence and dynamics of *Impatiens parviflora* depending on various environmental conditions in the protected areas in Slovakia. *European Journal of Ecology*, vol. 2, pp. 87-98.
- Chmura D. (2006) Wpływ gatunków inwazyjnych na różnorodność fitocenotyczną rezerwatów Wyżyny Krakowsko-Częstochowskiej. Raport końcowy. (Impact of invasive species on phytocoenotic diversity of the Cracow-Częstochowa Uplands. Final report). Krakow: Instytut Ochrony Przyrody.
- Coombe D.E. (1956). *Impatiens parviflora* DC.. *Journal of Ecology*, vol. 44, pp. 701-712.
- Castillo X., Joergensen R.G. (2001). Impact of ecological and conventional arable management systems on chemical and biological soil quality indices in Nicaragua. *Soil Biology and Biochemistry*, vol. 33, pp. 1591-1597.
- Dassonville N., Vanderhoeven S., Vanparys V., Hayez M., Gruber W., Meerts P. (2008). Impacts of alien invasive plants on soil nutrients are correlated with initial site conditions in NW Europe. *Oecologia*, vol. 157, pp. 131-140.
- Doran J.W., Zeiss M.R. (2000). Soil health and sustainability: Managing the biotic component of soil quality. *Applied Soil Ecology*, vol. 15, pp. 3-11.
- Fazekašová D., Kotorová D., Balázs P., Baranová B., Bobuľská L. (2011). Spatial variability of physical soil properties in conditions of ecological farming in protected area. *Ekológia (Bratislava)*, vol. 30, pp. 1-11.
- Fiala K., Barančíková G., Brečková V., Búrik V., Houšková B., Chomaničová A., Kobza J., Litavec T., Makovníková J., Matúšková L., Pechová B., Váradiová, D. (1999). Partial monitoring system – soil (in Slovak). Bratislava: Výskumný Ústav Pôdoznanectva a Ochrany Pôdy.
- Grejtovský A. (1991). Influence of soil improvers on enzymatic activity of heavy alluvial soil. *Plant, Soil and Environment*, vol. 37, pp. 289-295.

- Herr C., Chapuis-Lardy L., Dassonville N., Vanderhoeven S., Meerts P. (2009). Seasonal effect of the exotic invasive plant *Solidago gigantea* in soil pH and P fraction. *Journal of Plant Nutrition and Soil Science*, vol. 170, pp. 729-738.
- Jurko A. (1990). *Ekologické a socioekonomické hodnotenie vegetácie. (Ecological and socio-economic assessment of vegetation)*. Bratislava: Príroda.
- Khaziev F.K. (1976). *Soil enzyme activity*. Moscow: Nauka.
- Kizilkaya R., Akin T., Bayrakli B., Salam M. (2004). Microbiological characteristics of soil contaminated with heavy metals. *European Journal of Soil Biology*, vol. 40, pp. 95-102.
- Kourtev P.S., Ehrenfeld J.G., Huang W.Z. (2002). Enzyme activities during litter decomposition of two exotic and native plant species in hardwood forest of New Jersey. *Soil Biology and Biochemistry*, vol. 34, pp. 1207-1218.
- Miralles I., Ortega R., Sánchez-Marañón M., Leirós M.C., Trasar-Cepeda C., Gil-Sotres F. (2007). Biochemical properties of range and forest soils in Mediterranean mountain environments. *Biology and Fertility of Soils*, vol. 43, pp. 721-729.
- Monreal C.M., Bergstrom D.W. (2000). Soil enzymatic factors expressing the influence of land use, tillage system and texture on soil biochemical quality. *Canadian Journal of Soil Science*, vol. 80, pp. 419-428.
- Nowak A., Schneider C. (2017). Environmental characteristics, agricultural land use, and vulnerability to degradation in Malopolska Province (Poland). *Science of the Total Environment*, vol. 590-591, pp. 620-632.
- Okur N., Tuna A.L., Okur B., Altunlu H., Kayikçioğlu H.H., Civelek H.S. (2010). Non-target effect of organic insecticides: Effect of two plant extracts on soil microbial biomass and enzymatic activities in soil. *Environmental Monitoring and Assessment*, vol. 165, pp. 389-397.
- Pessi I.S., Elias S.O., Simões F.L., Simões J.C., Macedo A.J. (2012). Functional diversity of microbial community in soils in the vicinity of Wanda glacier, Antarctic Peninsula. *Microbes and Environment*, vol. 27, pp. 200-203.
- Senga Y., Hiroki M., Nakamura Y., Watarai Y., Watanabe Y., Nohara S. (2011). Vertical profile of DIN, DOC, and microbial activities in the wetland soil of Kushiro Mire, northeastern Japan. *Limnology*, vol. 12, pp. 17-23.
- Speir T.W., Van Schaik A.P., Lloyd-Jones A.R. (2003). Temporal response of soil biochemical properties in a pastoral soil after cultivation following high application rates of undigested sewage sludge. *Biology and Fertility of Soils*, vol.38, pp. 377-385.
- Zhang Ch. B., Wang J, Qian B.Y., Li W.H. (2009). Effects of the invader *Solidago Canadensis* on soil properties. *Applied Soil Ecology*, vol. 43, pp. 163-169.

## THERMOPHILIC BIOMETHANIZATION OF AGRICULTURAL WASTE IN CODIGESTION: EFFECT OF PESTICIDES

Juana FERNÁNDEZ-RODRÍGUEZ\*, Beatriz DE DIEGO-DÍAZ, Francisco Javier PEÑAS

Department of Chemistry, University of Navarra (Pamplona) Spain

\*Corresponding author: juanafernandez@unav.es

### Abstract

Anaerobic digestion (AD) is becoming one of the most feasible and efficient options for agro-industrial waste management. However, this kind of waste can contain certain substances from the industrial activity, which could potentially inhibit or, at least, modify the biomethanization process. Pesticides are widely used in agricultural activities. Mancozeb is an ethylene dithiocarbamate fungicide with broad spectrum used in crops. It reacts with and inactivates sulfhydryl groups of aminoacids and enzymes of fungal cells, disrupting of respiration, lipid metabolism and production of energy. Tefluthrin is a synthetic pyrethroid insecticide used to control a wide range of soil pests. It causes neurotoxicity and is a sodium channel modulator. This paper assesses the influence of the presence of mancozeb and tefluthrin on thermophilic (55°C) anaerobic co-digestion (carrot, cabbage, green pea, artichoke and fava and broad bean) of synthetic agroindustrial waste. The main results show that the pesticides improve the biomethanization process referred to generation of biogas (123%), consumption of volatile solid –VS- (18%), removal of chemical oxygen demand (5%) and yield of biogas measured like mL biogas/ VS consumed (117%), between other parameters. Anaerobic codigestion on presence of pesticides seems feasible and improved in comparison with the codigestion without these substances.

**Keywords:** *Agricultural waste, Co-digestion, Thermophilic, Pesticides.*

### Introduction

Anaerobic Co-digestion (ACoD) of several organic wastes is a useful configuration in biomethanization, since it allows higher resource recovery and more stable operation than mono-digestion. Additionally, co-digestion has advantages like improving nutrient balance in the digester (Kim *et al.*, 2004), increasing methane production (Zaher *et al.*, 2009) and enhancing system economics (Arnell *et al.*, 2016). In fact AD setups without codigestion are only economically feasible under limited conditions, but scenarios which use codigestion have the potential to contribute to nutrient over-application without nutrient separation technology (Astill *et al.*, 2016). Temperature operation in biomethanization is an important factor to taking account. In this way, three are the main temperature ranges: psychrophilic (to 20°C, optimal 15°C), mesophilic (from 20 to 45°C, optimal 35°C) and thermophilic (from 45°C, optimal 55°C). Thermophilic offers better rates of degradation, speed of growth of microorganisms and hygienization of the final sludge, but also, higher electrical consumption and level of non-biodegradable substrate. In addition, with respect to micro and macroinorganic nutrients, it may not be sufficiently bioavailable to maintain efficient enzymatic processing in thermophilic range.

Codigestion of agricultural waste is a widespread technology to deal with this kind of organic waste (Xing *et al.*, 2014; González-González *et al.*, 2013). To increase the agricultural production, pesticide can be applied to the soil. Most of them are industrial and chemical

products. In this sense, the agricultural waste can contain rests of these chemical products. Two of them are mancozeb and tefluthrin, both are pesticides wide range.

Mancozeb is a fungicide which inactivates and reacts with sulfhydryl (SH) groups of aminoacids and enzymes of fungal cells, disrupting of lipid metabolism, respiration and production of ATP. It is based on a coordination product of zinc ion and manganese ethylene bisdithiocarbamate (until 37.0% weight), being until 7.4% manganese and almost 1% zinc.

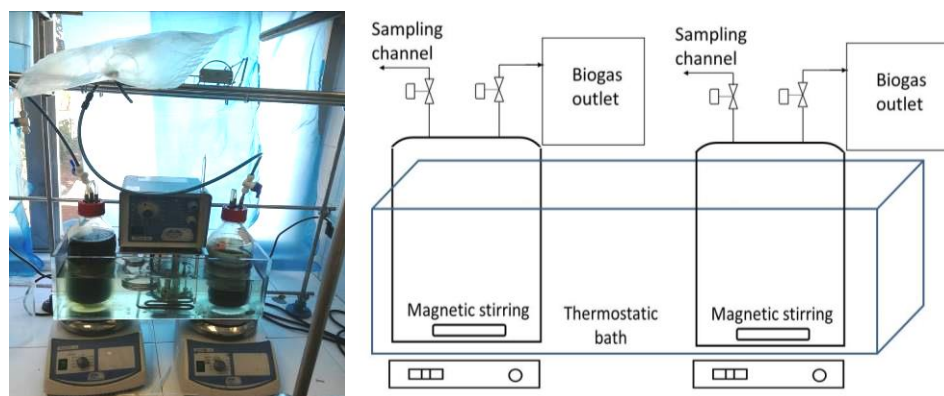
Mancozeb shows the capacity of inhibiting the growth and proliferation of a wide range of different fungi such as *Alternaria*, *Botrytis*, *Cercospora*, *Colletotrichum*, *Mycosphaerella*, *Peronospora*, *Phytophthora*, *Rhizoctonia* and *Septoria*.

Other pesticide wide range is Tefluthrin, an insecticide that targets a wide range of myriapods and insects from the orders dermaptera, lepidoptera, diptera and coleoptera, as well as their larvae. Tefluthrin is highly liposoluble, persistent and in vapour stage also has repellent activity. It is disposed directly on the earth along with the seeds to be harvested or prior to the seeding process.

In this paper, the effect of the pesticides presence, Mancozeb and Tefluthrin, on the biomethanization of agricultural waste is studied. Codigestion of several wastes and thermophilic range (55°C) has been selected.

### Material and Methods

The experimental system consisted in sets of batch continuous stirred-tank reactors (total volume of 1L and working volume of 0.6L). In the cap of the digesters two ports allowed biogas collection in a 5L fluorinated ethylene propylene bag (SKC) and sampling (Figure 1). The digesters were stirred magnetically and placed in a thermostatic bath (thermophilic 55°C). Biogas generation was quantified by bubbling it in a water gas-meter and its content in CH<sub>4</sub> was determined by NaOH displacement after being biogas bubbled in this alkaline solution (Walker *et al.*, 2009).



**Figure 1:** Picture and scheme of the reactors set

Synthetic agricultural waste was prepared in base of a group of vegetables: artichoke, green pea, bean, carrot and cabbage and green bean (Table 1). The reactors were operating in wet range (5-6% Volatile Solids); completed with 0.35L of organic waste; 0.2L of adapted inoculum and 0.05 L of the nutrient solution proposed by Sevillano *et al.* (2011). Pesticides were added to the reactors according to the concentration of field: Mancozeb (ACoD+M) 0.31 g/L and Tefluthrin (ACoD+T) 0.06 g/L. Additionally, a combination of both pesticides (ACoD+M+T) (0.31 g/L + 0.06 g/L) was tested and other system, blank of the experiment, without pesticides (ACoD).

Analytical methods were carried out according to standardized methods (APHA, AWWA, WPCF, 2012). Total solid (TS), volatile solid (VS) total chemical oxygen demand (COD<sub>T</sub>) and

were analysed from the reactor. Alkalinity and soluble chemical oxygen demand (COD<sub>s</sub>) required centrifugation of samples and later filtering through 0.45 µm and 0.2 µm.

Table 1. Characterization of the substrate and inoculum

Substrate	Scientific name	Percentage in reactor (%)	TS (%)	VS (%)	COD <sub>t</sub> (gO <sub>2</sub> /L)	COD <sub>s</sub> (gO <sub>2</sub> /L)	pH	Alkalinity (mgCaCO <sub>3</sub> /L)
Inoculum	---	33.3	1.10	1.00	7.50	5.50	6.60	900
Nutrients	---	8.3	---	---	---	---	---	---
Artichoke	<i>Cynara scolymus</i>	6.7	10.45	9.86	56.43	29.88	7.03	1150
Green Pea	<i>Pisum sativum</i>	19.3	24.02	23.21	56.14	25.93	6.98	970
Bean	<i>Vicia faba</i>	6.9	17.82	17.13	42.03	22.48	8.21	1200
Carrot	<i>Daucus carota</i>	7.3	7.39	6.80	49.37	20.85	6.76	1050
Cabbage	<i>Brassica oleracea var. gemmifera</i>	3.8	15.52	14.21	54.98	26.53	8.34	1410
Green bean	<i>Phaseolus vulgaris</i>	14.4	13.58	12.74	45.40	23.71	7.52	1320

## Results and Discussion

The evolution of the main parameters has been studied. The pH has shown different values according with the anaerobic stage. During the 8-9 first days, it was reduced until 4-4.5 due to the hydrolysis and acidogenesis. NaOH was used to increase the pH in the reactor in order to favour the methanogenic population. From this time to the end of the processes, the value of pH was close to 7-7.5, optimal for methanogenics. Alkalinity is a parameter use to estimate the stability of the process since the concentration of Volatile Fatty Acids (VFA) begins to increase; these are neutralized by the alkalinity to bicarbonate. In all cases, alkalinity has been in values around 20g/L, what is giving information about the high stability of the systems.

VS have decreased in all cases (Figure 2a), being the best results for the conditions in presence of pesticides, 58% reduction approx. in ACoD in front of 70% approx. (Table 2). The production of biogas is shown in the Figure 2b. It was higher (55-220%) in the reactors with pesticides comparing without them (2506 mL). The maximum biogas collected was in ACoD+T, 8206 mL. In all cases, the total biomethanization of the waste in the operational conditions lasted 15-20 days approx.

COD total was decreasing during the biomethanization, but it was not the same with COD soluble. In this case, the values were increasing until more than 200% over the initial value in ACoD+T. It can be supposed that in different conditions after these assays, the production of biogas can be higher, because it still remains organic soluble matter in the reactor.

TOC removal also showed higher values in ACoD+M (38.44%) comparing with ACoD (18.22%)

Relating to the productivity, the reactors with pesticides obtained better results than the system operating only in codigestion (112 mL biogas/gVS consumed). The higher productivity was reached in ACoD+T with 357.6 mL biogas/gVS, followed by ACoD+M with 224.0 mL biogas/gVS (Table 2). The productivities referred to biogas production per COD consumed are similar to the previous one. The minimum productivity was ACoD (95.9 mL biogas/gCOD), being ACoD+M (464.3 mL biogas/gCOD) and ACoD+T (367.5 mL



biogas/gCOD) the maximums. The results obtained are not in concordance to those obtained previously. There is not so much studies dealing with the effect of pesticides in biomethanization, but Khalil *et al.*, 1991 concluded that mancozeb caused a pronounced inhibition of methanogenesis from glucose was observed at a concentration of 100 mg/L. Perhaps the industrial formats of pesticides contain micronutrients that aim the biomethanization process.

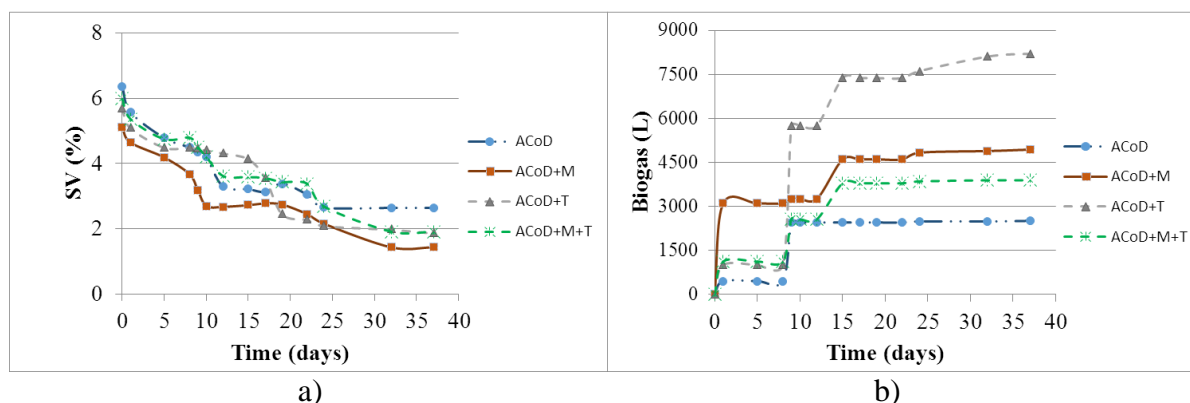


Figure 2. Evolution of the VS (a) and biogas (b) in the reactors

Table 2. Main parameters in anaerobic codigestion of agricultural waste in presence of pesticides

	ACoD	ACoD+M	ACoD+T	ACoD+M+T
TS cons (%)	49.48	51.82	57.00	58.62
VS cons (%)	58.55	71.95	67.33	68.05
COD <sub>t</sub> cons (%)	36.07	19.52	12.34	29.43
COD <sub>s</sub> prod (%)	74.49	164.22	218.56	102.74
TOC cons (%)	18.22	38.44	10.54	10.25
Biogas (mL)	2506.7	4935.3	8206.1	3887.9
Biogas/VS cons (mL/g)	112.0	224.0	357.6	159.0
Biogas/COD <sub>t</sub> cons (mL/g)	95.9	464.3	367.5	102.3

Kinetic study of the consumption of VS was developed. The Figure 3 shows the graphical adjust to the VS logarithm. The order of reaction and the velocity constant are similar in all cases (Table 3).

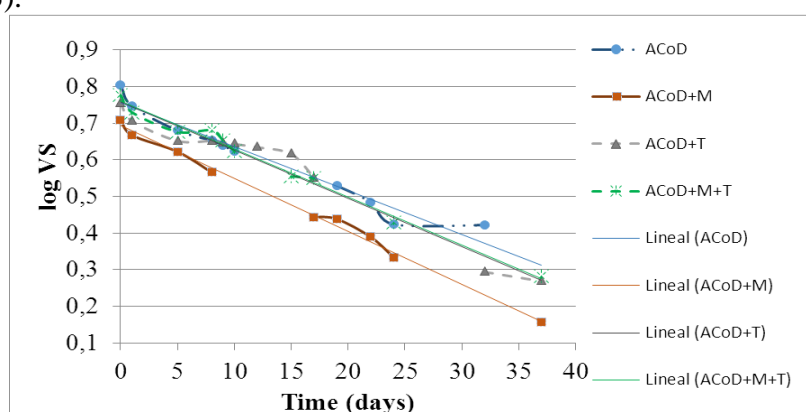


Figure 3. Velocity of the anaerobic reactions in codigestion of agricultural waste in presence of pesticides

Table 3. Kinetic parameters in anaerobic codigestion of agricultural waste in presence of pesticides

	ACoD	ACoD+M	ACoD+T	ACoD+M+T
General equation $y = \log VS$ $x = \text{time (days)}$	$y = -0.012x + 0.7568$	$y = -0.0144x + 0.6939$	$y = -0.0131x + 0.7579$	$y = -0.0131x + 0.7611$
$R^2$	58.55	71.95	67.33	68.05
Order of reaction (n)	-0.012	-0.0144	-0.0131	-0.0131
Log (k)	0.757	0.694	0.758	0.761
$k (d^{-1})$	5.712	4.942	5.727	5.769

### Conclusions

The main results obtained in this paper indicate that the AD of several agricultural organic (ACoD) wastes can be feasible in thermophilic range. The ACoD in presence of pesticides, mancozeb and tefluthrin, has shown better results than the codigestion without pesticides. The reduction of VS was around 70% average in pesticide presence and 58% without. In this way, the production of the biogas was higher in the system with tefluthrin (8206 mL), followed to mancozeb (4935 mL) comparing with ACoD without pesticides (2506 mL). Additionally, the productivity measured as mL biogas/gVS consumed was of 357.6 and 224.0 with mancozeb and tefluthrin respectively; whereas it was of 112.0 in ACoD. The order and the velocity of the anaerobic reactions seem to be similar in all studied cases.

### Acknowledgements

This work has been supported by the University of Navarra (Research Plan PIUNA project 2015-06); the Ministry of Economy and Competitiveness of Spain (Project CTQ2014 59312P) and Navarra Bank Foundation. The authors also like to thank the Friends Association of the University of Navarra for the grant of Beatriz de Diego.

### References

- APHA, AWWA, WEF. (2012). Standard Methods for examination of water and wastewater. 22nd ed. Washington: American Public Health Association, pp.1360 ISBN 978-087553-013-0
- Arnell M., Astals S., Åmand L., Batstone D.J., Jensen P.D., Jeppsson U. (2016). Modelling anaerobic co-digestion in Benchmark Simulation Model No. 2: parameter estimation, substrate characterisation and plant-wide integration Water Research, Vol. 98, pp. 138–146 <http://dx.doi.org/10.1016/j.watres.2016.03.070>
- Astill G.M.; Richard Shumway C.R. (2016). Profits from pollutants: Economic feasibility of integrated anaerobic digester and nutrient management systems. Journal of Environmental Management. Vol. 184(Pt 2): pp. 353-362.
- González-González, A.; Cuadros, F.; Ruiz-Celma, A; Lopez-Rodriguez, F. (2013). Energy-environmental benefits and economic feasibility of anaerobic codigestion of Iberian pig slaughterhouse and tomato industry wastes in Extremadura (Spain) Bioresource Technology. Vol. 136. pp. 109-116

- Khalil E. F., Whitmore T.N., Gamal-El-Din H., El-Bassel A., Lloyd D. (1991) The effects of pesticides on anaerobic digestion processes. *Environmental Technology* Vol.12 (6), pp. 471-475
- Kim H.W., Han S.K., Shin H.S. (2004). Anaerobic co-digestion of sewage sludge and food waste using temperature-phased anaerobic digestion process *Water Science Technology*. Vol. 50 (9), pp. 107–114
- Sevillano, X., Isasi, J.R., Peñas, F.J. (2011) Performance of a fluidized-bed bioreactor with hydrogel biomass carrier under extremely low-nitrogen availability and effect of nitrogen amendments. *J Chem Technol Biotechnol*. 87. 3. pp. 402-409.
- Walker, M., Zhang, Y., Heaven, S., Banks, C. (2009). Potential errors in the quantitative evaluation of biogas production in anaerobic digestion processes. *Bioresource Technol*. 100. pp. 6339-6346.
- Xing W Chen, X; Zuo J; Wang C; Lin, J; Wang K. (2014). A half-submerged integrated two-phase anaerobic reactor for agricultural solid waste codigestion. *Biochemical Engineering Journal* 88 pp. 19–25
- Zaher U., Li R., Jeppsson U., Steyer J.P., Chen S. (2009) GISCOD: general integrated solid waste co-digestion model. *Water Res.*, 43 (10), pp. 2717–2727  
<http://dx.doi.org/10.1016/j.watres.2009.03.018>

## EFFECT OF NUTRIENTS ON BIOMETHANIZATION OF AGRICULTURAL WASTE: STUDY OF TEMPERATURES

Beatriz DE DIEGO-DÍAZ, José Manuel Alejandro CERDÁN, Francisco Javier PEÑAS, Juana FERNÁNDEZ-RODRÍGUEZ\*

Department of Chemistry, University of Navarra, Spain

\*Corresponding author: juanafernandez@unav.es

### Abstract

Anaerobic codigestion has shown to be feasible to manage organic waste. Different wastes treated together can be the supplement of nutritional deficiencies for the microorganisms involved. In this study, the presence of macromolecules and trace elements on anaerobic codigestion of agricultural waste has been assessed. An extra nutrients solution containing elements, which play a key role in the anaerobic microbiological metabolism, was used at three different temperature conditions: mesophilic (35°C), intermediate (42°C) and thermophilic (55°C). The main results showed that at 35°C in the presence of nutrients, biogas production reached 6.2L, almost 1.5-fold the production of biogas without them. Additionally, productivity was 359.3mL-CH<sub>4</sub> / g-VS, which is 1.9 times higher than that for the process without nutrients. At 42°C up to 55% of VS were eliminated and more than 10.0L-biogas were produced, while biomethanization without extra nutrients solution only reached 7.4L. The anaerobic codigestion at 55°C showed that biogas production also surpassed 10.2L in the presence of nutrients and 146.99mL-CH<sub>4</sub> / g-VS were obtained, being these results 1.2-fold those obtained for the process without extra solution. Results for each temperature showed that the nutrients solution could contribute to the biomethanization process of codigestion waste. Furthermore, 35°C was the temperature range at which the impact of nutrients was more remarkable.

**Keywords:** *nutrients solution, anaerobic digestion, agricultural waste, temperature*

### Introduction

Anaerobic codigestion (AcoD) has shown to be an effective approach when optimizing biomethanization of organic waste. The combination of various substrates leads to nutritional augmentation through synergies established between different types of feedstock (Jang *et al.*, 2016). The microbial consortia has, therefore, access to an enriched media with a proper nutritional balance. The main objectives of AcoD should be favoring beneficial interactions, avoiding inhibition and enhancing methane production (Astals, *et al.*, 2013; Mata-Alvarez *et al.*, 2011). AcoD presents several advantages regarding economic, technological and environmental aspects. Among the economic advantages, sharing potential costs between industries and higher biogas production can be found. The latter can be translated in higher economic feasibility of the treatment plant (Macias-Corral *et al.*, 2008). Additionally, an anaerobic process for waste treatment is already environmentally positive. This is because the environmental impact is less than that with aerobic processes as the greenhouse gas emissions are lower.

AD has already shown to be able to stabilize organic waste, among which agricultural residue is worth-mentioning. The activity derived from agriculture generates a great amount of waste that cannot longer be utilized for commercial purposes. Therefore, the codigestion of these

substrates that are linked to the same sector can be treated together and both agronomic and energetic valorization can be implemented (Hobbs *et al.*, 2017).

However, AcoD can be further optimized through extra nutrients or elements that can improve the C/N balance or microbial metabolism. Mineral solutions containing trace elements can enhance the digestive process. Among them, nickel, cobalt, iron and molybdenum have shown to have a positive effect on the stabilization of anaerobic waste (Choong *et al.*, 2016).

Also, operative conditions such as temperature can play a key role in the process. Generally, biomethanization is performed at psychrophilic (<20°C), mesophilic (20-45°C) or thermophilic (45-60°C) range and each of them can impact the process. Each range shows its general advantages and disadvantages. Thermophilic range, for instance, contributes to the removal of pathogens and antibiotic resistance genes, and yields higher CH<sub>4</sub> productions. On the other hand, operative costs derived from higher energetic requirements have to be considered in life cycle assessments.

In this study, AcoD at three different temperatures (35°C, 42°C and 55°C) was carried out. Also, the effect of a nutrient solution on biomethanization performance was assessed at the same operative conditions.

### Material and Methods

Stirred anaerobic digesters with a total volume of 1 L and a working volume of 0.6 L were used. Batch assays were carried out with codigestion of various vegetables using 0.2 L of adapted inoculum, which was taken from an anaerobic digestion treatment plant of local wastes. Reactors were set-up according to total solids (TS) in order to work at a wet range (4-10% of TS). The synthetic waste used in this study was a combination of 6 vegetables from a commercial product. The characterization of each substrate is described in Table 1.

The reactors that contained the extra nutrients (W/) were filled up with 0.05 L of the solution, while this volume for the reactors without extra nutrients was filled up with water (W/O). The nutrient solution used in this study was taken from Sevillano *et al.* (2011).

The parameters that were monitored are chemical oxygen demand (COD), TS, volatile solids (VS), pH and alkalinity. These were analyzed according to the Standardized Methods (APHA, *et al.*, 2012). Biogas was collected in 5-L Tedlar bags (SKC, USA) and was quantified using a water gasometer through water displacement and its content in methane using a gasometer with an alkaline solution. Results were contrasted with a biogas analyzer (Geotech Biogas-5000, UK). This research was performed at the University of Navarra (Spain) by the Environmental Technology Group.

Table 1. Vegetable characterization.

Substrate	Substrate (scientific name)	TS (%)	VS (%)	Total COD (gO <sub>2</sub> /L)	Soluble COD (gO <sub>2</sub> /L)	pH	Alkalinity (mgCaCO <sub>3</sub> /L)
Inoculum	---	1.1	1.0	7.5	5.5	6.6	900
Artichoke	<i>Cynara scolymus</i>	10.5	9.9	56.4	29.9	7.0	1150
Green Pea	<i>Pisum sativum</i>	24.0	23.2	56.1	25.9	7.0	970
Bean	<i>Vicia faba</i>	17.8	17.1	42.0	22.5	8.2	1200
Carrot	<i>Daucus carota</i>	7.4	6.8	49.4	20.9	6.8	1050
Cabbage	<i>Brassica oleracea</i> var. <i>gemmifera</i>	15.5	14.2	55.0	26.5	8.3	1410
Green bean	<i>Phaseolus vulgaris</i>	13.6	12.7	45.4	23.7	7.5	1320

## Results and Discussion

Temperature and nutrient results are summarized in Table 2. Temperature studies for both conditions showed how thermophilic range (T55) yielded the highest biogas productions with up to 8.1 L and 10.1 L for W/O and W/, respectively (Fig. 1c). This is in accordance with the literature, as thermophilic range has shown to yield higher productions than mesophilic conditions (Peces *et al.*, 2013). Also VS removal was the most successful at T55, managing to remove 68.6% and 63.3% of VS for W/O and W/. The latter was 1.31-fold higher than the same condition at mesophilic range (M35) (Fig. 2). Productivities, however, showed better results at an intermediate temperature (I42). This had to do with relatively high biogas and methane generations and a lower solids removal in comparison to the other operative conditions. I42 produced 1049.9 mL-biogas/g-VS and 409.8 mL-CH<sub>4</sub>/g-VS for W/O, which is 2.81-times the biogas productivity at T55 and 3.39 that of CH<sub>4</sub>. This is because, in spite having a similar biogas and CH<sub>4</sub> generation, the solids removal was considerably higher at T55. On the other hand, M35 granted a more stable process with a less demanding pH control. This can also be seen attending to the CH<sub>4</sub> content. For M35 the total CH<sub>4</sub> production reached 70-72% for both conditions, while for I42 and T55 it only accounted with 27-39% of the total biogas produced. Nutrient studies showed a clear difference between W/O and W/ for every temperature. Biogas productions were always higher for W/, being W/ 1.27-1.37 times higher than W/O. It is also worth-mentioning, that the differences for each temperature were higher at lower temperatures. This can be explained by the effect of temperature on AcoD, as explained before (Fig. 1). Also, total CH<sub>4</sub> was higher for W/, showing T55 once again less differences than the other conditions. This is in accordance with the literature, as various studies have shown how supplementation enhances AD (Choong *et al.*, 2016; Wintsche *et al.* 2016). Regarding productivities, only I42 showed better values for W/O than W/. For W/ at M35 biogas and CH<sub>4</sub> productions per g-VS consumed were 1.88 and 1.93 times higher than those for W/O, respectively. The same scenario can be seen for T55. However, these were only 1.48 and 1.21-fold.

Biogas production begins to arrest at different times for each condition. However, when comparing nutrients effect, it is W/ that generally continues to produce biogas for longer than W/O (Fig. 1).

Additionally, statistical studies on biogas production and VS removal showed that for each temperature, W/O and W/ were significantly different ( $\alpha < 0.05$ ).

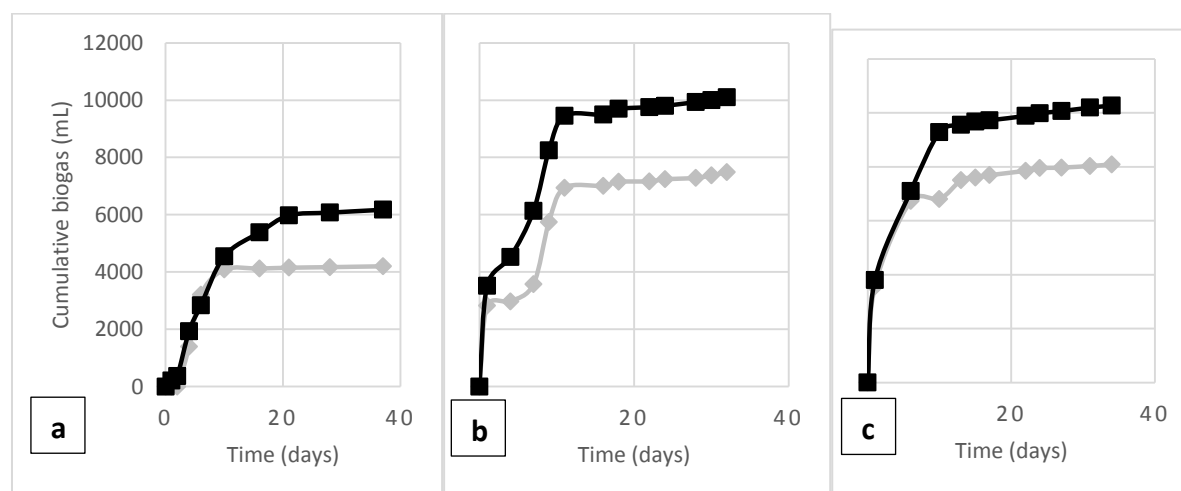


Figure 1. Cumulative biogas production. a) 35°C b) 42°C c) 55°C.

◆) W/O ■) W/.

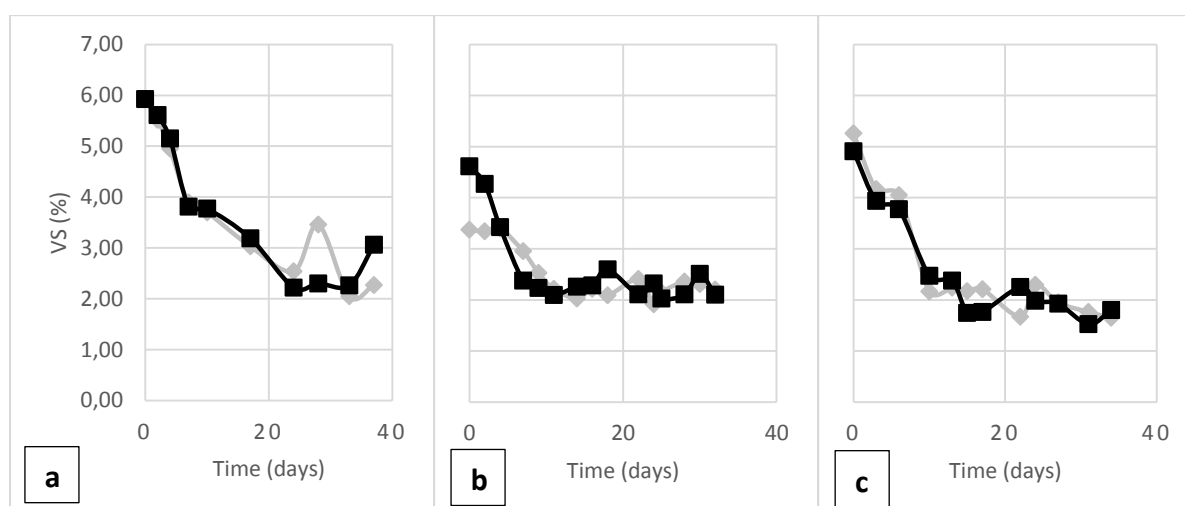


Figure 2. VS (%) evolution throughout the process. a) 35°C b) 42°C c) 55°C.

◆) W/O ■) W/.

Table 2. Overall results for AcoD at different temperatures without (W/O) and with (W/) nutrient solution.

	M35		I42		T55	
	W/O	W/	W/O	W/	W/O	W/
<b>TS removal (%)</b>	43.3	32.3	25.0	29.6	50.1	40.8
<b>VS removal (%)</b>	61.7	48.3	34.7	54.5	68.6	63.3
<b>TOC removal (%)</b>	74.1	61.7	72.0	55.8	30.2	13.8
<b>Biogas (mL)</b>	4199.5	6173.0	7375.0	10105.0	8085.0	10265.0
<b>CH<sub>4</sub> (mL)</b>	2940.2	4443.3	2879.0	3895.0	2618.7	2743.0
<b>Biogas/TS removed (mL/g)</b>	249.2	490.3	1092.6	1129.1	501.8	814.8
<b>Biogas/VS removed (mL/g)</b>	191.6	359.3	1049.9	670.41	373.5	550.1
<b>CH<sub>4</sub>/TS removed (mL/g)</b>	174.5	352.9	426.5	435.2	162.5	217.7
<b>CH<sub>4</sub>/VS removed (mL/g)</b>	134.1	258.6	409.8	258.5	121.0	147.0
<b>Time (≈days)</b>	10	21	16	16	13	15

### Conclusions

AcoD on agricultural wastes has shown to be an efficacious process at the three temperatures studied. The condition that yielded higher biogas productions was the thermophilic range, with up to 10.3 L with nutrient solution and almost 8.1 L without them. Also solids removal was highest at this temperature. However, methane content (>70%) was highest at 35°C due to the stability of the process. Nutrient studies showed that the presence of a mineral solution enhances the AcoD at every operative condition assessed in this study. As described elsewhere (Choong *et al.*, 2016), the optimal proportion of trace elements and micronutrients should be studied, especially because the effect of each one is yet to be elucidated.

### **Acknowledgements**

This work has been supported by the University of Navarra (Research Plan PIUNA project 2015-06); the Ministry of Economy and Competitiveness of Spain (Project CTQ2014 59312P) and Navarra Bank Foundation. The authors also like to thank the Friends Association of the University of Navarra for the grant of Beatriz de Diego.

### **References**

- APHA, AWWA, WEF. (2012). Standard Methods for examination of water and wastewater. 22nd ed. Washington: American Public Health Association, pp.1360. ISBN 978-087553-013-0
- Astals, S., Nolla-Adrèvol, V., Mata-Alvarez, J. (2013). Thermophilic co-digestion of pig manure and crude glycerol: process performance and digestate stability. *J Biotechnology*. Vol. 166. 3. pp. 97-104.
- Choong, Y.Y., Norli, I., Abdullah, A.Z., Yhaya, M.F. (2016). Impacts of trace el element supplementation on the performance of anaerobic digestion process: A critical review. *Bioresource Technology*. 209. pp. 369-379.
- Hobbs, S.R., Landis, A.E., Rittmann, B.E., Young, M.N., Parameswaran, P. (2017). Enhancing anaerobic digestion of food waste through biochemical methane potential assays at different substrate: inoculum ratios. *Waste Management*. doi: 10.1016/j.wasman.2017.06.029.
- Jang, H.M., Ha, J.H., Kim, M.S., Kim, J.O., Kim, Y.M., Park, J.M. (2016). Effect of increased load of high-strength food wastewater in thermophilic and mesophilic anaerobic co-digestion of waste activated sludge on bacterial community structure. *Water Research*. Vol. 99. pp. 140-148.
- Macias-Corral, M., Samani, Z., Hanson, A., Smith, G., Funk, P., Yu, H., Longworth, J. (2011). Anaerobic digestion of municipal solid waste and agricultural waste and the effect of co-digestion with dairy cow manure. *Bioresour Technol*. Vol. 99, pp. 8288-8293.
- Mata-Alvarez, M., Dosta, J., Mace, S., Astals, S. (2011). Codigestion of solid wastes: A review of its uses and perspectives including modeling. *Crit Rev Biotechnol*. Vol. 31(2). pp. 99-111. doi: 10.3109/07388551.2010.525496
- Peces, M., Astals., Mata-Alvarez, J. (2013). Response of a sewage sludge mesophilic anaerobic digester to short and long-term thermophilic temperatura fluctuations. Vol. 233. pp. 109-116.
- Sevillano, X., Isasi, J.R., Peñas, F.J. (2011). Performance of a fluidized-bed bioreactor with hydrogel biomass carrier under extremely low-nitrogen availability and effect of nitrogen amendments. *J Chem Technol Biotechnol*. Vol. 87. 3. pp. 402-409.
- Wintsche, B., Glaser, K., Sträuber, H., Centler, F., Liebetrau, J., Harms, H., Kleinstüber, S. (2016). Trace elements induce predominance among methanogenic activity in anaerobic digestion. *Frontiers in Microbiology*. <https://doi.org/10.3389/fmicb.2016.02034>



## EVOLUTION OF SOME EDAPHIC PROPERTIES IN AN AGRICULTURAL SOIL AFTER ITS CHANGE OF USE - RAINFED TO IRRIGATED

Antonio SÁNCHEZ NAVARRO, Juan SÁNCHEZ MARTÍNEZ, María José DELGADO INIESTA\*

Department of Agricultural Chemistry, Geology and Edaphology, Campus de Espinardo (30100), University of Murcia, Spain

\*Corresponding author: delini@um.es

### Abstract

This study aims to assess the influence of cropland use change (rainfed to irrigated) on some soil properties. To this effect, three profiles (P1, P2, P3) were sampled and analysed to determine macromorphology and electrical conductivity, as well as total organic carbon, total nitrogen, base cations (Na, K) and assimilable phosphorous and micronutrient (Fe, Mn, Cu, Zn) concentration. The profiles were located in the closest point of three different rainfed patches. Cropland use change occurred in 1998 for P2 and P3. Sampling of profiles took place in 2003 (P1 and P2) and 2015 (P3). Analytical results were submitted to one-way ANOVA, comparing the same horizons of the three profiles. Use change led to organic carbon enrichment ( $\approx 6 \text{ g}\cdot\text{Kg}^{-1}$  in P1;  $\approx 10 \text{ g}\cdot\text{Kg}^{-1}$  in P3) and browning of the Ap horizons. As a result, the soil evolved from a Cambic Calcisol (P1, P2) to a Fluvic Calcic Kastanozem (P3). The highest concentration of phosphorous was measured in surface layers of P3 ( $37 \text{ mg}\cdot\text{Kg}^{-1}$ ), which might be linked to soil carbon enrichment; in contrast, a slight nitrogen-leaching process was detected in deep horizons (P2, P3), likely caused by nitrogen lixiviation and intense irrigation. EC values were doubled in P2 ( $2.3 \text{ ds}\cdot\text{m}^{-1}$ ), due to salinity of irrigation water, organic amendment and fertirrigation. Lower values of EC were measured in P3 ( $1.4 \text{ ds}\cdot\text{m}^{-1}$ ), as a result of a readjusted management. Potassium concentrations were higher in Ap horizons, especially in P2 ( $0.5 \text{ g}\cdot\text{Kg}^{-1}$ ); sodium concentration evolved similarly to EC; micronutrients accumulated in upper horizons similarly to potassium. Irrigation and fertilisation schedule have proved to be appropriate for the intensive management of the cropland, reducing soil salinisation and increasing soil fertility. Furthermore, crop rotation and addition of organic compost were key points to favour a carbon sequestration process in the soil, promoting a classification change to a more developed soil.

**Keywords:** *Change of use, salinisation, fertility, carbon sequestration, nitrogen, Spain.*

### Introduction

In the last few years, with the agricultural development of the Mediterranean Basin, soil salinisation processes and loss of soil fertility have been enhanced (Al-Jaloud, 1994) due to the indiscriminate use of poor quality water and the excessive addition of manures. The European Commission (2003) issued a report in which it stated that 1-3 millions of hectares of land in Europe hold this concern, mostly in the Mediterranean Basin. Arid and semi-arid regions, such as the southeast of Spain, especially suffer from the effects of high salt contents in the soil (Hernández-Bastida et al., 2004). In Spain, the 18 percent of 3.5 millions of hectares of irrigated crops is seriously affected by or in serious risk of soil salinisation (European Commission, 2002). However, the most intense degradation has been occurring in the last decades, due to the utilisation of inadequate agricultural practices. In an area where periods of severe drought are frequent and cultivations require high contents of water and

nutrients, the trend has been to apply fertilisers and manures as well as to utilise poor quality water for irrigation and inadequate tillage (Arnaldos, 2001), which progressively leads to an increase in the number of hectares of soil disabled by the loss of their properties.

The present study is framed in this context, which has been conducted in a land located in the municipality of Puebla de Don Fadrique, in the province of Granada (SE Spain). This area has experienced, in the last few years, a remarkable change in the model of cultivation. In particular, a significant proportion of the cultivation soils has evolved from a rainfed and extensive agriculture to an irrigated agriculture. Concurrently, traditional rainfed crops have been replaced with horticultural crops (broccoli, tomato, celery, potato, etc.), whose management implies moving from an agrosystem which is slightly aggressive to the environment, to another one in which processes such as soil degradation, pollution and overexploitation of aquifers are frequent.

As some authors point out, these processes of soil degradation are manifested throughout the soil profile. Thus, vertical distribution of total organic carbon (TOC) shows a great variability in agricultural soils (Van Oost et al., 2007).

Therefore, this study aims to assess, in short and long term, the influence of cropland use change (rainfed to irrigated) on some soil properties, the suitability of agricultural management techniques and its agroenvironmental influence.

### **Material and methods**

The experimental patch is located in the SE of Spain, with an average yearly precipitation around 473 mm and an average yearly temperature of 12.70 °C, being framed within the supramediterranean bioclimatic stage. The study area has highly seasonal nature, with minimum temperatures of around -10 °C and maximum temperatures of around 40 °C.

Three complete soil profiles were sampled following the FAO Guidelines for Soil Description (1977). Profile 1 (P1), sampled in 1998, corresponds to a rainfed cereal soil. Profiles 2 and 3 (P2 and P3), were sampled in the same location, but in 2003 and 2015, respectively.

During the 1998 and 2015 period, the patch has been used to cultivate vegetables throughout the summer period: broccoli (2 years), tomato (4 years), pepper (1 year), lettuce (7 years) and maize (1 year). Likewise, crop rotations with arable crops such as barley, oat and vetch have been carried out during the autumn and winter seasons. Water supply varied from 6,200 m<sup>3</sup>·ha<sup>-1</sup> in tomato cultivations to 4,000 m<sup>3</sup>·ha<sup>-1</sup> in lettuce crops and it was considered as good quality water by Wilcox and Green combined index. The organic amendment consisted in 20,000 kg·ha<sup>-1</sup> of sheep manure, applied biennially, and supplemented with macro and micronutrients by fertirrigation (N, P<sub>2</sub>O<sub>5</sub>, MgSO<sub>4</sub>, K<sub>2</sub>SO<sub>4</sub> y HNO<sub>3</sub>), whose concentration was adjusted according to crop requirements.

Following the World Reference Base (2006), soil samples were air-dried, sieved with a 2 mm sieve and processed in order to analyse their properties and features. Soil colour was described using a Munsell Colour Chart, whereas TOC, electrical conductivity (EC), assimilable phosphorous, total nitrogen (TN), texture and assimilable metals (Fe, Mn, Cu y Zn) were measured using the Soil Survey Laboratory Methods Manual (USDA, 1996).

A one-way ANOVA and Tuckey's Test were carried out in order to seek significant differences among P1, P2 and P3 horizons.

## Results and discussion

P1, P2 y P3 were relatively developed, containing an Ap-Bw-C sequence. The macromorphological study of the complete profiles revealed changes in the Ap horizon depth. In fact, P2 and P3 have an Ap horizon divided in Ap1 and Ap2, with more than 50 cm deep, whereas the Ap horizon of P1 is around 30 cm deep (Table 1). This might be explained by the subsoiling process at 50-60 cm deep occurring in P2 and P3 for cropland use change. As a consequence, part of the previous Bw was integrated in the upper horizon. Soil texture in P1, P2 and P3 is silty clay loam for Ap and Bw horizon, clay loam for Ck1 and loam for C2, except in P1, which is clay loam. Soil structure is blocky subangular for Ap and Bw in the three profiles. Hence, cropland use change did not affect soil structure. Regarding soil colour, Ap1 horizon darkened remarkably quick due to the addition of manure and crop wastes (Table 1). Furthermore, Bw presents reddish tones, soil structure and a lower carbonate content than the underlying horizons, so it was denoted as a cambic horizon.

Table 1. Macromorphological aspects of interest.

Horizon	Profile	Depth (cm)	Colour (Dry)	Colour (Moist)	Mottling
Ap1	P1	0-32	10YR 6/3	10YR 4/2	
	P2	0-13	10YR 6/3	10 YR 4/3.5	X
	P3	0-20	10YR 5/3	10YR 3/3	X
Ap2	P1	0-32	10YR 6/3	10YR 4/2	
	P2	13-53	10YR 6/3	10YR 4/4	X
	P3	20-50	10YR 6/2	10YR 4/3	X
Bw	P1	32-51	10YR 5/4	10 YR 3.5/4	
	P2	53-72	2.5 Y 5/1	7.5 YR 4/4	
	P3	50-68	10YR 7/2	10YR 5/3	
Ck1	P1	51-70	10 YR 7/4	10YR 6/4	
	P2	72-100	10YR 7/4	10YR 5/6	X
	P3	68-92	10YR 7/2	10YR 6/3	X
C2	P1	70-92	10 YR 8/4	10 YR 7/4	
	P2	72-110	10YR 8/4	10YR 6/8	
	P3	92-125	10YR 8/2	2.5YR 6/4	

P1, P2 and P3 had low to moderate TOC contents which diminish in depth (Table 2). Similar results were obtained in the same cropland area by other authors (Pérez-Pujalte et al., 1990). The highest values were obtained in the upper horizons (especially in P2 and P3  $\approx 10 \text{ g}\cdot\text{kg}^{-1}$ ) while the lowest values were found in the C horizons ( $< 3 \text{ g}\cdot\text{kg}^{-1}$ ). The statistical analysis revealed significant differences in TOC contents among P1, P2 and P3, specifically in Ap1, Ap2 and Ck1 horizons, which have been justified through the application of manure in alternate years.

The results suggest that a carbon sequestration process would have been manifesting in the soil, favoured by the cropland use change (Hontoria et al., 2004). The carbon sequestration process has been extensively studied in mild and humid climate (Heath et al., 2002) and tropical climate (Fearnside, 2000), but is still relatively unknown in soils under the effect of a Mediterranean climate. These soils often contain low levels of TOC that are even decreased due to mineralisation of organic substances, especially when the application of inorganic fertilizers is prioritized and inadequate agricultural labours are carried out (Stevenson & Cole, 1999). Nevertheless, areas with Mediterranean climate have a high potential to fix carbon, and favour the development of interesting ecological functions (FAO, 2004).

TN contents (Table 2), in general, did not vary significantly with the cropland use change. The highest values of TN were found in the upper horizons of P1 and P2 ( $1.1 \text{ g}\cdot\text{kg}^{-1}$  y  $1.2 \text{ g}\cdot\text{kg}^{-1}$ , respectively). However, N accumulation was detected in C2 and Ck1 horizons of P2 and P3, with a maximum of  $0.9 \text{ g}\cdot\text{kg}^{-1}$  and exceeding the concentrations measured in the surface. This might be explained by a large supply of manure and basal-dressing fertilisers in order to satisfy the demanding nutritional requirements of crops, as well as by an excessive irrigation that led to soil washing and N leaching to deeper horizons (Riley et al., 2001).

Table 1. TOC, TN and P content, C/N ratio and EC in P1, P2 and P3 horizons.

Horizon	Profile	Depth (cm)	TOC ( $\text{g}\cdot\text{kg}^{-1}$ )	TN ( $\text{g}\cdot\text{kg}^{-1}$ )	C/N	EC ( $\text{dS}\cdot\text{m}^{-1}$ )	P ( $\text{mg}\cdot\text{kg}^{-1}$ )
Ap1	P1	0-32	7.8 a	1.1	7.1 a	1.0 a	4.8 a
	P2	0-13	10.4 c	1.3	8.0 b	2.3 c	13.5 b
	P3	0-20	9.5 b	0.8	11.5 c	1.4 b	37.2 c
Ap2	P1	0-32	7.8 a	1.1	7.1 a	1.0 a	4.8 a
	P2	13-53	8.6 b	1.2	7.4 a	1.6 b	10.5 b
	P3	20-50	10.4 c	0.6	16.5 b	1.5 b	21.7 c
Bw	P1	32-51	6.7	0.8	8.2	1.2 a	1.1 a
	P2	53-72	8.0	0.8	9.7	1.2 a	3.1 b
	P3	50-68	5.8	0.6	9.5	1.6 b	6.9 c
Ck1	P1	51-70	2.9 a	0.5	5.6	0.5 a	1.1 a
	P2	72-100	4.7 c	0.6	8.5	2.3 c	3.6 b
	P3	68-92	3.8 b	0.7	5.5	1.4 b	6.2 c
C2	P1	70-92	2.8 b	0.4	6.6 c	0.4 a	1.1 a
	P2	72-110	1.0 a	0.9	1.1 a	2.2 c	6.4 c
	P3	92-125	2.3 b	0.7	3.2 b	1.7 b	3.8 b

C/N ratio was significantly different in Ap1, Ap2 and C2, reaching values from 7 to 9 in Ap and Bw of P1 and P2, whereas the maximum values were found in Ap2 of P3 (C/N=15) (Table 2). In C horizons of P2 and P3, C/N ratio was the lowest found, as a result of the increase of N mentioned in the previous section. In conclusion, P3 contained the best C/N ratio, favoured by the presence of high concentrations of TOC, which highlights the sustainability of the crop management and the organic amendments applied.

EC values varied significantly in all horizons with the cropland use change (Table 2). In P1, EC was lower to  $2 \text{ dS}\cdot\text{m}^{-1}$ , while in P2 horizons it was above that value, except in Bw ( $1.2 \text{ dS}\cdot\text{m}^{-1}$ ) and Ap2 ( $1.6 \text{ dS}\cdot\text{m}^{-1}$ ); therefore, the first 5 years of vegetables cultivation has led to increases of EC in P2 which are 2-fold and 4-fold higher for upper and deeper horizons, respectively. These increases could be related to the incorporation of soluble salts such as sulphates, chlorides or nitrates to the soils, coming from the application of organic amendments, fertirrigation ( $\text{K}_2\text{SO}_4$ ,  $\text{MgSO}_4$ ) or irrigation water ( $30 \text{ mg}\cdot\text{l}^{-1}$ ). EC in P3 showed values between P1 and P2, but in any case reached  $2 \text{ dS}\cdot\text{m}^{-1}$ , which is a significant reduction with P2. This fact is explained by adjustments in the composition and quantity of the manure and a process of salt washing caused by a period of intense rains occurring in 2011-2012.

Regarding to base cation concentrations, cropland use change caused a short-term enrichment in Na and K (P2) (Table 3). Both cations were found in similar concentrations, which concurrently changed in time, showing significant differences in Ap, Bw and Ck1 along the study period. The quick increase of K would be related to inputs coming from organic amendments, irrigation and fertirrigation. In P3, Na and K concentrations were reduced, reaching values prior to the cropland use change. This reduction was likely produced by the

adjustments of the manure and the process of salt washing as mentioned for EC. In the case of K, the reduction of its concentration could also be linked with a greater demand for crops.

P distribution in P1, P2 and P3 was similar, with the highest concentrations in the upper horizons and increasing over time (Table 2). According to Abdala et al. (2012), this fact is produced because P is adsorbed to soil colloids and increases of TOC enhance that process. Therefore, cropland use change has largely affected assimilable P concentrations, determining its progressive accumulation, fundamentally in Ap1 and Ap2 horizons.

Micronutrient concentrations (Fe, Mn, Cu y Zn) showed similar dynamics, increasing over time until reaching values 3-fold higher (P2) and 8-fold higher (P3) than in P1 (Table 3). On the one hand, these results could be explained by an excessive addition of manure in order to avoid nutritional deficiencies in the cultivations. On the other hand, the calcareous nature of the soil hinders micronutrients solubility, leading to a concentration decrease in deeper horizons. It could be expected that the major part of micronutrients are adsorbed to organic matter (Larchevêque et al., 2006), reason that would justify the fact that the maximum concentrations of micronutrients were measured in the horizons with higher contents of that component. The statistical analysis revealed the presence of significant differences among the profiles, being able to affirm that the cropland use change has contributed to a progressive accumulation of Fe, Cu, Mn and Zn in the soil, especially in the upper horizons.

Table 3. Assimilable elements in P1, P2 and P3 horizons.

Horizon	Profile	Depth (cm)	Na	K	Fe	Mn	Cu	Zn
			(g·kg <sup>-1</sup> )		(mg·kg <sup>-1</sup> )			
Ap1	P1	0-32	0.2 a	0.4 b	2.4 b	4.8 b	1.4 b	0.5 a
	P2	0-13	0.5 b	0.5 c	2.1 a	8.1 c	1.2 a	0.6 b
	P3	0-20	0.2 a	0.3 a	6.8 c	1.7 a	2.8 c	3.2 c
Ap2	P1	0-32	0.2 a	0.4 b	2.4 a	4.8 a	1.4 b	0.5 a
	P2	13-53	0.4 b	0.4 b	2.6 b	5.5 b	1.2 a	0.6 b
	P3	20-50	0.2 a	0.2 a	6.2 c	9.0 c	2.5 c	1.8 c
Bw	P1	32-51	0.2 a	0.2 b	2.7 a	5.3 b	1.2 b	0.4 b
	P2	53-72	0.4 b	0.3 c	7.2 b	29.1 c	1.0 a	0.3 a
	P3	50-68	0.2 a	0.1 a	8.7 c	5.2 a	2.4 c	2.5 c
Ck1	P1	51-70	0.2 a	0.1 b	2.4 b	1.2 a	0.5 a	0.8 b
	P2	72-100	0.4 b	0.2 c	2.0 a	24.0 c	0.7 b	0.5 a
	P3	68-92	0.2 a	0.1 a	6.5 c	4.1 b	1.9 c	1.6 c
C2	P1	70-92	0.2 a	0.1 b	2.0 a	0.3 a	0.5 a	0.3 a
	P2	72-110	0.2 a	0.1 a	2.1 b	6.5 c	0.6 b	0.5 b
	P3	92-125	0.3 b	0.1 b	5.6 c	1.9 b	1.3 c	0.9 c

P1 and P2 are classified (IUSS Working Group WRB (2014) as Cambic Calcisols (Aric, Fluvic, Loamic) for only presenting a calcic horizon and a cambic horizon. In contrast, P3 includes, apart from the previous horizons, an A mollic horizon; consequently, it is classified as Fluvic Calcic Kastanozem (Aric, Cambic, Loamic). This change in the classification suggests that the crop management has acted as a brake on the degradation of the crops and has produced a positive development of the soil.

### Conclusion

In the 17 years of soil monitoring, cropland use change has not produced a significant soil degradation, even some properties have significantly improved, especially at A horizon. In this sense, an enrichment of organic carbon, macro and micronutrients have been observed. As a consequence of the increase of organic matter, soil colour has darkened, leading to a change in its taxonomy. Moreover, this increase may contribute to the reduction of climatic change through carbon storage. Cropland use change has led to an increase in salt concentration in all horizons, although the initial trend of linear increase has been attenuated, even decreased, when comparing P2 and P3, due to the adjustments of fertirrigation programs. Therefore, the treatments used have proved to be appropriate, even advisable, for the intensive management of the cropland. Likewise, evidences of leaching of N and other salts have been detected due to the presence of mottling in the Ck1 horizon of P2 and P3, as well as by the EC values.

### **References**

- Abdala, D, Kumar, A., Riberio, I. & Hugo, V. (2012). Phosphorus saturation of a tropical soil and related P leaching caused by poultry litter addition agriculture, *Ecosystems and Environment*, Vol. (162), pp. 15–23.
- Al-Jaloud, A. (1994). Effect of irrigation with treated municipal wastewater on soil and crops. *Journal of King Abdulaziz's University*, Vol. (5), pp.77-88.
- Arnaldos, R. (2001). Study of the soil salinity in the central-eastern sector of the Campo de Cartagena (Murcia). PhD Thesis. University of Murcia, 249 pp.
- European Commission. (2002). towards a thematic strategy for soil protection. Brussels, Belgium: European Commission, pp. 179-end.
- European Commission. (2003). extent, causes, pressures, strategies and actions that should be adopted to prevent and to combat salinization and sodification in Europe. Directorate-General for Environment, Erosion Working Group (Task 5; Salinisation and sodification). Brussels, Belgium: European Commission, 10 pp.
- FAO. (1977). Guidelines for soil profile description. Rome, Italy: FAO, 70 pp.
- FAO. (2004). Carbon sequestration in dryland soils. World soil resources report, Vol. (102). Rome, Italy: FAO, 112 pp
- FAO. (2006). Guidelines for soil description. Rome, Italy: FAO, 100 pp.
- Fearnside, P. (2000). Global warming and tropical land-use change: greenhouse gas emissions from biomass burning, decomposition and soils in forest conversion, shifting cultivation and secondary vegetation. *Climatic Change*, Vol. (46), pp. 115-158.
- Heath, L., Birdsey R. & Williams D. (2002). Methodology for estimating soil carbon for the forest carbon budget model of the United States. *Environmental Pollution*, Vol. (116), pp. 373-380.
- Hernandez-Bastida, J., Vela-De-Oro, N. & Ortiz, R. (2004). Electrolytic conductivity of semiarid soils (Southeastern Spain) in relation to ion composition. *Arid Land Resource Management*, Vol. (18), pp. 265-281.
- Hontoria, C., Rodríguez, J, & Saa, A. (2004). Organic carbon content in soil and control factors in Iberian Peninsula. *Edafología*, Vol. (2), pp. 149-157.
- IUSS Working Group WRB. (2006). World Reference Base for Soil Resources 2006. World Soil Resources Reports, No. 103. Rome, Italy: FAO, 132 pp.
- IUSS Working Group WRB. (2014). World Reference Base for Soil Resources 2014. World Soil Resources Reports, N°. 106. Rome, Italy: FAO, 181 pp.
- Larchevêque, M., Ballini, C., Korboulewsky, N. & Montès, N. (2006). The use of compost in afforestation of Mediterranean areas: Effects on soil properties and young tree seedlings. *Science of Total Environment*, Vol. (1-3), pp. 220-230.

- Pérez-Pujalte, A., Ibáñez, M. A., Torres, M., Oyoarte, C., Guirado, J., Mendoza, R. (1990). Soil map at scale 1:100,000. Sheet 951 (Orce). Project LUCDEME. Ministry of Agriculture, Fisheries and Food, ICONA. Madrid, Spain: Revisatlas, 162 pp.
- Riley, W., Ortiz-Monasterio, I. & Matson, P. (2001). Nitrogen leaching and soil nitrate, nitrite, and ammonium levels under irrigated wheat in northern Mexico. *Nutrient Cycling in Agroecosystems*, Vol. 61, pp. 223–236.
- Stevenson, F. & Cole, M. (1999). *Cycles of soil*. N.Y., U.S.A: John Wiley & Sons, 427 pp.
- USDA (1996). *Soil Survey Laboratory Methods Manual*. Soil Survey Investigations Report. No. 42, Version 3.0, 693 pp.
- Van Oost K., Quine, T.A., Govers, G., De Gryze, S., Six, J., Harden, J.W., Ritchie, J.C., McCarty, G.W., Heckrath, G., Kosmas, C., Giraldez, J.V., da Silva, J.R., Merckx, R. (2007). The impact of agricultural soil erosion on the global carbon cycle. *Science*, Vol. (5850): pp. 626-629.

## EXPLORING THE USE OF SWAT TO MODEL A SMALL MARLY AGRICULTURAL CATCHMENT IN TUNISIA

Insaf MEKKI<sup>1\*</sup>, Rim ZITOUNA CHEBBI<sup>1</sup>, Najet SOUISSI<sup>1</sup>, Frédéric JACOB<sup>1,2</sup>, Damien RACLOT<sup>2,3</sup>

<sup>1</sup>INRGREF, B.P. 10, 2080 Ariana, Tunisia

<sup>2</sup>IRD, UMR LISAH, 2 place Viala, 34060 Montpellier, France

<sup>3</sup>IAV, Medinat Al Irfane, Rabat, Morocco

\*Corresponding author: insaf.mekki@laposte.net

### Abstract

Mediterranean rainfed agricultural landscapes provide ecosystem services such as water harvesting, agricultural production and erosion mitigation. Assessing the impact of global changes (e.g., land use, climate forcing) on these services can be useful for streamlining agrosystem management. Such assessment can be done by implementing land surface models that simulate the spatiotemporal dynamics of the targeted processes, provided model simulations are constrained with reference data. Model calibration at the catchment scale is challenging within semiarid mediterranean agricultural landscapes, because of gaps between complex hydro-agricultural processes and simplified model descriptions in relation to extreme events, spatial heterogeneities and crack distribution across different land uses on vertisols. The aim of this paper was to explore the capability of the Soil and Water Assessment Tool (SWAT) model to predict the hydrological regime within a small agricultural catchment in the Cap Bon peninsula in Tunisia. The study took place within the Kamech catchment that belongs to the OMERE long-term monitoring system (<http://www.obs-omere.org/>). Measurements under the common cereals/ legumes/ pasture cropping systems were used to adjust model parameters to the conditions induced by different land use practices under edaphic conditions related to vertisols. Numerous field observations within the catchment were used to evaluate the ability of SWAT to mimic the spatiotemporal dynamics of the hydrologic regime.

**Keywords:** *Hydrological processes, SWAT, cracks, agricultural catchment, Tunisia*

### Introduction

Models that can simulate hydrological budget of agricultural catchments have main implications to support decisions about management strategies related to land use change, climate change, water allocation, and pollution control (Abbaspour *et al.*, 2007). Soil and Water Assessment Tool (SWAT) is a process-based continuous hydrological model (Srinivasan *et al.*, 2010; Arnold *et al.*, 2012; Gassman *et al.*, 2014). It was recommended by Dechmi *et al.*, (2012) as the most suitable model for long-term simulations in catchments dominated by agricultural land uses, since its original design was to assess the impact of land management practices on water, sediments and agricultural residues. It has been successfully applied in numerous studies for evaluating the impact of land management practices on hydrological budget within large scale basins (Eckhardt *et al.*, 2002; Schneider *et al.*, 2007; Srinivasan *et al.*, 2010; Mukundan *et al.*, 2015). It has been used and validated to simulate ecological, hydrological and environmental processes under multiple climates and management conditions throughout the world, and it is extremely useful to link crop yields and basin hydrology over long time periods (Neitsch *et al.*, 2011). However, using SWAT is a



delicate task when addressing Mediterranean agricultural catchments typified by semiarid climate and marly soils. Precipitation distribution, land use and subsequent agricultural practices, water requirements combined with varying soil properties induce significant spatiotemporal variations for runoff processes (Mekki *et al.*, 2006). In addition, vertisols or vertic intergrades soils with highly dynamic shrink-swell behaviour generate extreme seasonal variations in soil infiltration rates and make hydrological regime much more complex across several spatial scales from micro to catchment scales (Inoubli *et al.*, 2016). To our knowledge, such challenging conditions have not been investigated up to now with SWAT, and it is necessary to investigate the model capabilities to properly mimic the hydrological regime within Mediterranean agricultural catchments with semiarid climate and marly soils. This is now possible thanks to several time series of measurements collected in the framework of long-term environmental research observatories. The aim of this paper was to describe the work progress, with a focus on the SWAT capabilities to mimic surface water flows in response to land use.

## **Material and Methods**

### **Study area and data**

The experiment took place within the 2.6 km<sup>2</sup> size Kamech small marly agricultural catchment that belongs to the OMERE long-term monitoring system (<http://www.obs-omere.org/>). Kamech is located upstream of the Lebna catchment, Cap Bon peninsula, Tunisia. The climate is classified as semiarid Mediterranean. It is typified by rainfalls mostly concentrated in autumn and winter (75% of the total annual rainfall occurs between October and April) and by dry summer periods with high temperature and evaporation rates (Figure 1). The long-term (1996-2016) average annual precipitation is 650 mm, but annual precipitation is highly variable, between 400 to 1000 mm. The mean inter-annual temperature is 14 °C, and the mean annual evapotranspiration is 1200 mm (Zitouna-Chebbi *et al.*, 2014). The rainfall variability is very large, including periods without runoff and periods with extreme rainstorm events. The latter occurred between May and October, with short durations and high rainfall intensity. The hydrological regime is typified by the highly predominance of hortonian overflow process and significant hydrological connectivities. Catchment elevation ranges from 100 to 200 m. The main soil types are vertisols, luvisols, cambisols and regosols. However, the main part of the catchment is underlain by clay texture, and the soils are therefore merged into two main types: vertisols or assimilated (65% of the catchment), and regosols (35%). Soil depth and topsoil conditions are highly variable (Mekki *et al.*, 2006). Vertisols or assimilated correspond to deep soils (>2 m) while the regosols correspond to thin soils (<1 m). About 60% of the catchment area exhibit a strong potential for shrinking and swelling processes with numerous wide and deep open cracks throughout the dry summer period (Inoubli *et al.*, 2016). The catchment is dominated by annual croplands (70 % of the catchment area) mainly located over slopes lower than 15%. Land use includes rainfed cropping systems (cereals, legumes, spices and fallow), and natural pasture vegetation (pastures-annual and pastures-shrubs). The most common crops are winter cereals (wheat, triticale, oat and barley), and legumes (fababean, chickpeas, peas, fenugreek). The catchment landscape is typified by small agricultural fields, and by a large panel of tillage and management operations. SWAT requires land use, soil type and digital elevation model (DEM) data (Neitsch *et al.*, 2011). Each of these data was obtained within the framework of the OMERE observatory and used as input for the model. Precipitation and runoff have been monitored continuously at the level of the catchment outlet since 1994 (<http://www.obs-omere.org/>). The datasets are detailed in Raclot and Albergel (2006), Mekki *et al.*, (2006), and Albergel *et al.*, (2007). Meteorological data have been recorded by the weather station at the

catchment outlet since 1994, and they were used in the current study to estimate potential evapotranspiration (PET) as detailed in Zitouna-Chebbi *et al.*, (2014).

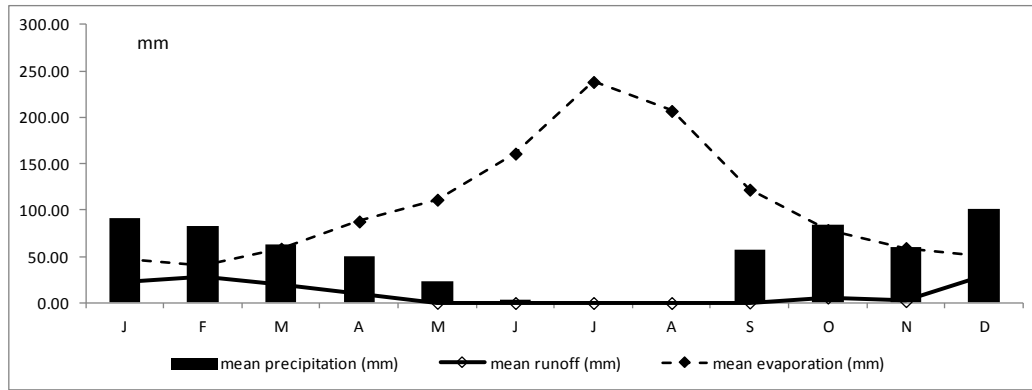


Figure 1: Mean monthly rainfall, runoff and evaporation at the Kamech catchment outlet for the period 2005 to 2012.

### Model description, implementation and calibration / validation

SWAT is a continuous-time, semi-distributed, process-based, river basin scale model (Arnold *et al.*, 2012). It operates at a daily time step, and it requires a large panel of input parameters. Main model inputs are related to hydrography, terrain, land use, soil, weather and management practices (Srinivasan *et al.*, 2010). In this study, ArcSWAT (Version 2012.10.2) for ArcGIS10.2 platform was used. The catchment terrain was characterized using 2 slope classes; 0-15%, >15%. The impacts of land use on water flows were assessed both at the catchment scale and on the Hydrologic Response Units (HRUs) where measurements were available. SWAT model provides, for each sub-basin and for each HRU, the amount of the surface runoff, potential and actual evapotranspiration, percolate and stored water in the soil profile at the end of simulation time step (day, month, year). The soil water balance is conceptualized in SWAT using the following Eq. (1) as described in Neitsch *et al.*, (2011):

$$SW_t = SW_0 + \sum_{i=1}^t [R_{day} - Q_{surf} - E_a - W_{seep} - Q_{gw}] \quad (1)$$

Where  $SW_t$  is the soil water content [mm],  $SW_0$  is the initial soil water content on day 1 [mm],  $t$  is the time [days],  $R_{day}$  is the daily precipitation [mm],  $Q_{surf}$  is the amount of surface runoff [mm],  $E_a$  is the evapotranspiration [mm],  $W_{seep}$  is the amount of water entering the unsaturated zone [mm], and  $Q_{gw}$  is the amount of return flow [mm]. The model defines two phases: the land phase and the water, or routing, phase of the hydrological cycle. For the current study, the model was run from 2004 to 2012 using the SCS curve number method to simulate surface runoff and the Penman-Monteith approach to simulate the evapotranspiration. Simulated flow has been compared to the observed data at the outlet of the catchment. We used SWAT - Calibration and Uncertainty Program (SWAT-CUP) and its Sequential Uncertainty Fitting algorithm (SUFI-2) to achieve calibration (Abbaspour *et al.*, 2015). The selection of the calibrated parameters relied upon sensitivity analysis procedure and upon analyses previously carried out by various authors (Neitsch *et al.* 2011; Arnold *et al.*, 2012; Ha *et al.*, 2017). Sensitivity analysis included saturated hydraulic conductivity (SOL\_K), available water capacity of the soil layer (SOL\_AWC), and baseflow recession constant (ALPHA\_BF). The SCS runoff curve number (CN) also was included because of its influences on the surface-subsurface hydrological processes. The calibration relied on these parameters and modelling performance was evaluated by Nash and Sutcliffe coefficient (NS).

## Results and Discussion

Although the SWAT model is still in calibration phase, some analyses are reported here, where simulations rely on a simple classification of HRU based on dominant soil type, land use, slope and a subdivision of the catchment into 30 sub-basins. The years 2004 and 2005 served as a warm-up period for model simulations. The daily discharge values were loaded to SWAT-CUP and compared with the discharge simulated by SWAT. The initial results for uncalibrated model were not very good, with low and unreliable river discharge values. The NS coefficient for daily flow with uncalibrated model ranged between -0.12 and 0.45 depending on sub-basins. Therefore, we calibrated the model at a monthly time scale by using the river discharge measurements at the catchment outlet. As previously reported by former studies, the global sensitivity analysis showed that saturated hydraulic conductivity (SOL\_K), available water capacity of the soil layer (SOL\_AWC), and baseflow recession constant (ALPHA\_BF) are the most sensitive parameters for river discharge calibration. The model was well calibrated dynamically, and the simulations depicted the seasonality trend of infiltration-runoff response with a strong relationship between surface runoff and rainfall, but some peaks were not well simulated. The figure 2 illustrates the results at the catchment outlet and at one sub-basin. Monthly NS was 0.5 for the calibration period on sub-basins, which was considered satisfactory. Similarly, mean simulated and observed flows were in agreement, with a slight under-prediction by the model on average. The simulated monthly stream flow at one sub-basin and at the catchment outlet during the calibration period (2004-2012) closely matched with the observed stream flow (Figure 2). The NS,  $R^2$ , and PBIAS values for monthly predictions of stream flow over the calibration period at the catchment outlet were 0.57, 0.54, and -23.3%, respectively, demonstrating an acceptable agreement between simulations and observations, with regards to the uncertainties on hydrograph data.

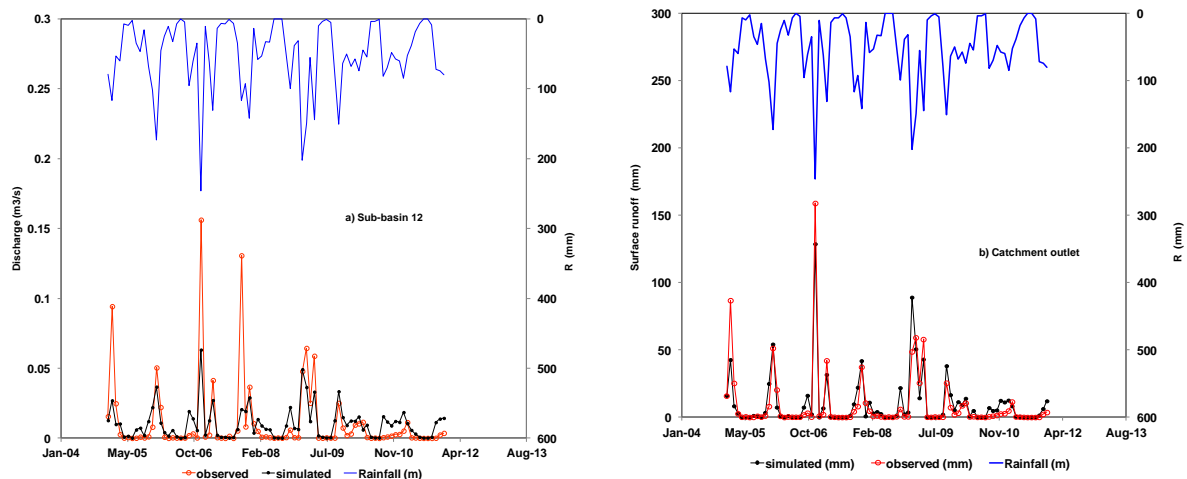


Figure 2. Observed and simulated monthly streamflow after calibration at: a) one sub-basin (12), and b) the catchment outlet.

Most runoff events happened between October and March with variable rates. The surface runoff occurring during September to November had the highest uncertainty. At this stage, it is ascribed to the pedotransfer functions used for parameterizing soil hydraulic properties. These functions were developed at the point scale, and they might tend to underestimate soil hydraulic properties (SOL\_AWC and SOL\_K) since they did not reflect spatial variability induced by preferential flow paths that affect the behaviour at larger scales. Also, open cracks

are widespread across Kamech in autumn and they are likely to induce high variations in soil hydraulic properties that drive runoff at the beginning of the hydrological year. This increase in soil hydraulic conductivity and available soil water content during the calibration process is highly connected with the presence of macropores (cracks) and preferential paths within the soil profile within the Kamech catchment. In addition, the underestimation of runoff flows observed in all the sub-basins and at the catchment outlet, might be primarily explained by the occurring of rainstorm events with a short duration and high rainfall intensity. Therefore, using daily precipitation does not enable to predict accurately these runoff events.

The temporal dynamic of potential evapotranspiration (calculated using Penman-Monteith method) was well captured. However, simulated values were far too low as compared to observed data, and ET under-estimation during summer reached up to 40%. The prediction uncertainty was larger in summer than in winter, which makes prediction unreliable for these months. At the annual timescale, the initial assessment of SWAT simulations for the Kamech catchment showed satisfying results for the hydrological budget. The preliminary results of simulations indicated that the runoff amounts were low (less than 20% of the annual rainfall amount) and that actual evapotranspiration (ET<sub>a</sub>) was relatively high (more than 40% the annual rainfall amount). The model structure was able to capture the temporal trend of hydrological behavior of some HRU, as well as of annual discharge. The main annual ET<sub>a</sub> component was related to the cropping growth period. The fraction of ET<sub>a</sub> was low during wet year, while it corresponded to almost 60% of total rainfall during a dry year.

### **Conclusions**

SWAT was implemented in the Kamech catchment in Tunisia in order to evaluate the model capability to predict the hydrologic response within a small marly agricultural catchment under semiarid climate. Although the SWAT model is still in calibration phase, first analysis results are reported here. Our study showed the significant benefit of long-term measurement dataset for constraining model simulations. Indeed, we noted significant simulation improvements after calibration based on hydrological data time series, and simulations give reasonable estimations of the monthly stream flows at the outlet. However, for a complete complexity overview and an appropriate simulation of the considered processes, a multi-calibration procedure is necessary, where the latter must account for the stream flow, but also for cracking characteristics of soils, for actual evapotranspiration, for sediment concentrations and for crop yield. Research is currently underway to address these issues and for better model calibration at different time and space scales. Future works are also needed to analyze the influence of land use choices on crop water requirements, on soil water availability, and on sediment production at the catchment outlet. The availability of a reliable set of sub-daily data is likely to increase the capability of SWAT to serve a useful tool for optimizing ecosystem services such as water conservation, agricultural production, and soil erosion mitigation.

### **Acknowledgements**

Financial support for this study was provided by the ANR TRANSMED ALMIRA project (grant agreement no. ANR-12-TMED-0003-01). The OMERE observatory (<http://www.obs-omere.org>), funded by the French institutes INRA and IRD and coordinated by INRGREF Tunis, INAT Tunis, and UMR LISAH Montpellier, is acknowledged for providing the data used in this study. The authors would like to acknowledge all the staff of OMERE who achieves a very demanding work for running, maintaining and operating all equipment and field data collection.

## References

- Abbaspour K.C., Rouholahnejad E., Vaghefi S., Srinivasan R., Yang H., Kløve B. (2015). A 5 continental-scale hydrology and water quality model for Europe: Calibration and uncertainty of a high-resolution large-scale SWAT model, *J. Hydrol.*, 524: 733-752, doi:10.1016/j.jhydrol.2015.03.027,.
- Abbaspour K.C., Yang J., Maximov I., Siber R., Bogner K, Mieleitner J., Zobrist J., Srinivasan R. (2007). Spatially-distributed modelling of hydrology and water quality in the prealpine/ alpine Thur watershed using SWAT. *Journal of Hydrology*, 333: 413-430.
- Albergel J., Nasri S., Lamachère J.M. (2007). "Les lacs et barrages collinaires: infrastructures hydrauliques d'aménagement et de conservation des terres agricoles en zone semi-aride méditerranéenne. *Sols de Tunisie*, 7-20.
- Arnold JG., Moriasi DN., Gassman PW., Abbaspour KC., White MJ., Srinivasan R., Santhi C., Harmel RD., van Griensven A., Van Liew MW., Kannan N., Jha MK. (2012). SWAT: model use, calibration, and validation. *Transactions of the ASABE*, 55: 1491-1508.
- Dechmi F., Burguete J., Skhiri A. (2012). SWAT application in intensive irrigation systems: Model modification, calibration and validation. *J. Hydrol.*, 470-471: 227-238, doi:10.1016/j.jhydrol.2012.08.055.
- Eckhardt K., Haverkamp S., Fohrer N., Frede H.G. (2002). SWATG, a version of SWAT99.2 modified for application to low mountain range catchments, *Phys. Chem. Earth*, 27: 641-644.
- Gassman PW., Sadeghi AM., Srinivasan R. (2014). Applications of the SWAT model special section: overview and insights. *Journal of Environmental Quality*, 43: 1-8.
- Ha L.T., Bastiaanssen W.G.M., van Griensven A., van Dijk A.I.J.M., Senay G.B. (2017). SWAT-CUP for Calibration of Spatially Distributed Hydrological Processes and Ecosystem Services in a Vietnamese River Basin Using Remote Sensing. *Hydrol. Earth Syst. Sci. Discuss.*, <https://doi.org/10.5194/hess-2017-251>.
- Inoubli N., Raclot D., Moussa R., Habaieb H., Le Bissonnais Y. (2016). "Soil cracking effects on hydrological and erosive processes: a study case in Mediterranean cultivated vertisols". *Hydrological Processes*, 30(22): 4154-4167. DOI: 10.1002/hyp.10928.
- Mekki I., Albergel J., Ben Mechlia N., Voltz M. (2006). Assessment of overland flow variation and blue water production in a farmed semi-arid water harvesting watershed. *Physics and Chemistry of the Earth*, 31: 1048-1061.
- Mukundan R., Pierson DC., Schneiderman EM., Zion MS. (2015). Using detailed monitoring data to simulate spatial sediment loading in a watershed. *Environ. Monit. Assess.*, 187: 532. DOI 10.1007/s10661-015-4751-8.
- Neitsch S.L., Arnold J.G., Kiniry J.R., Williams J.R. (2011). *Soil and Water Assessment Tool, Theoretical Documentation: Version 2011*. Grassland, Soil and Water Research laboratory, Agricultural Research Service and Blackland Research Center, Texas, USA.
- Raclot D. and Albergel J. (2006). Runoff and water erosion modelling using WEPP on a Mediterranean cultivated catchment. *Physics and Chemistry of the Earth*. 31:1038-1047.
- Schneider K., Ketzer B., Breuer L., Vaché K. B., Bernhofer C., Frede H.G. (2007). Evaluation of evapotranspiration methods for model validation in a semi-arid watershed in northern China. *Adv. Geosci.*, 11: 37-42.
- Srinivasan R., Zhang X., Arnold J. (2010). SWAT ungauged: hydrological budget and crop yield predictions in the Upper Mississippi River basin. *Transactions of the ASABE*, 53: 1533-1546.

Zitouna-Chebbi R., Prévot L., Jacob F., Mougou R., Voltz M. (2012). Assessing the consistency of eddy covariance measurements under conditions of sloping topography within a hilly agricultural watershed. *Agricultural and Forest Meteorology*, 164: 123-135.

## THE DETERMINATION AND LIMITATION OF AMMONIA LOSSES FROM UREA FERTILIZERS WITHIN SOILS BY USING DIFFERENT ORGANIC MATERIALS

Ali Rıza DEMIRKIRAN

University of Bingöl, Faculty of Agriculture, Department of Soil Science and Plant Nutrition, Bingöl, Turkey,  
\*Corresponding Author: ademirkiran2000@gmail.com

### Abstract

After using nitrogen fertilizers to soil a part of the nitrogen in the fertilizer losses with volatilization are important in agriculture. Sometimes the loss of level with volatilization has reach to 50 %. The purpose of this investigation is to determine nitrogen losses as  $\text{NH}_3$  volatilization, effect of some factors on the losses and being limited some materials in soil samples. In the experiment, urea from the nitrogen fertilizers were applied to soil samples and these samples were dried in the closed system under constant air flow. In addition to this experiment, the ammonia losses from nitrogenous fertilizer (urea) were studied to limit with mixing some different organic materials (bark talk of pine (BToP), peat, straw, wood shaving) to this samples. The soil samples were selected from 3 areas in the Pazarcık-Kahramanmaraş, Turkey. To limitation of  $\text{NH}_3$  losing by BToP was added to the soil at the level of 0, 5, 10, and 20%. As the nitrogen source urea and ammoniawas added to the soil at the level of 0, 250, and 500 kg N/ha. In a closed system it was held air compressed to the soil+BToP+nitrogen solution mixings at 8 hours and 1 bar/minute at atmospheric pressure. Then  $\text{NH}_3$  losing was held in the boric acid solution in the closed and air controlled system. The absorbed  $\text{NH}_3$  in this system was determined with titrimetric method. According to the results, 50% of minimum limitation was obtained from BToP treatments and 65,57% as maximum limitations of ammonia losses at 300 ppm with wood shaving application. Absorption by peat in this experiment recovered at 11.6% and 20.6% of the volatilized ammonia.

**Key words:** *Nitrogen fertilizers, Volatilization, Organic material, Soil.*

### Introduction

Nitrogen fertilizers present high solubility and are effective for agricultural practices. Some of nitrogen in the nitrogenous fertilizers using to soil has been lost by volatilization and this losing has been reached to high levels (Allison, 1955). Urea is characterized as the granulated solid nitrogenous fertilizer of highest N concentration (45 %). Among the sources of N in the world, it has lower market value and is the most used. Therefore, there is some concern regarding on its use due to the fact that its application on surface promotes N losses by volatilization in the form of  $\text{N-NH}_3$ . Among the advantages of urea, besides the high N concentration and low cost, one may mention the low expenses with transportation, storage and application, high solubility, low corrosive properties as well as easiness to mix with other sources (Cantarella & Raij, 1986; Melgar et al., 1999; Pereira at al., 2009).

The  $\text{NH}_3$  losing from being the urea was obtained relating with pH and other factors. In the high levels of pH urea has changed to ammonium by hydrolyzing and then been ammonium carbonate importantly (Fenn and Kissel, 1975; Sağlam, 1976b; Du Plessis and Kroontje, 1964; Terman and Hunt, 1964). Nitrogen may be from the soil in the form of gases. A considerable loss of  $\text{NH}_3$  may occur when  $\text{NH}_4^+$  -salts are applied to calcareous soils. Such high pH soils should not to treated with  $\text{NH}_4^+$  -salts. The same is also true for the use of urea

as a top dressing (Cooke, 1972). When the nitrogen fertilizer was given to the soil  $\text{NH}_3$  losing by volatilization has changed according to the fertilizer types and soil conditions. In addition to the matter it has appeared to increasing nitrogen level giving to the soil has been increased to the  $\text{NH}_3$  losing. Separately, the soil texture has affected the  $\text{NH}_3$  losing (Fenn and Kissel, 1975; Sağlam, 1976a). According to the studies of Sağlam et al. (1997), loss of from urea was obtained between 9.66 and 14.44% at the level of 100 and 150 kg N/da respectively.

According to the Lehr and van Wesemael (1961), urea application leads to the loss of  $\text{NH}_3$  by volatilization as it is very rapidly converted to  $\text{NH}_4^+$  particularly in alkaline soils. This losing of nitrogen by volatilization is changed according to the  $\text{CaCO}_3$  content of soil, pH, type of fertilizer, type using of fertilizer, level of fertilizer etc. (Sağlam, 1976a). The calcium carbonate content of soil is important affected factor to losing in the nitrogen fertilizer as ammonia. In general, with increasing to the  $\text{CaCO}_3$  content of the soil is increase losing of nitrogen as ammonia. According to the researches, it has been obtained correlation between the  $\text{CaCO}_3$  content of the soil and losing of nitrogen as ammonia (Fenn and Kissel, 1975). It has been known that pH level effects to the  $\text{NH}_3$  losing. On the other hand, with increasing to the reaction of soil is increased losing of nitrogen as ammonia (Sağlam, 1976a).

Bark of trees mainly used as power fuel as replacement for natural fuel (oil and gas). Recently, the bark, complex chemical mixture of many organic compounds bearing a large amount of hydroxyl, carboxyl, methoxyl functional groups etc. has also been used as an environmental pollution control product, e.g., erosion controller and slope stabilizer, odor scavenger in sulfate pulp mills and oil pollutant, mulch, and soil conditioner, replacement with phenol in resolve adhesives, etc. (Fengel and Wegener, 1984; Alma and Kelley, 2002).

In this study, for the determination of ammonia losses it was used different organic materials (bark talk of pine: BToP, peat, straw, wood shaving) in laboratory experiment and the losses from nitrogenous fertilizer- urea were determined with these organic materials to limit with mixing to this soil samples.

## Materials and Methods

### 1. The experiment with using of BToP

To limitation of  $\text{NH}_3$  losing Bark Talk of Pine (*Pinus brutia* L.) (BToP) was added to the soil at the level of 0, 5, 10, and 20%. As the nitrogen source urea fertilizer (N: 46 %) was added to the soil at the level of 0, 250, and 500 kg N/ha. In a closed system it was held air compressed to the soil+BToP+nitrogen solution mixings at 8 hours and 1 bar/minute at atmospheric pressure. Then  $\text{NH}_3$  losing was held in the boric acid solution in the closed and air controlled system. Experimental set-up for absorption of  $\text{NH}_3$  comprised two 500-mL conical flasks, in the first conical flask was packed soil+ure samples, and the second conical flask was filled with 50-mL boric acid solution. There was also an air source by compressor in this system for air transport and increasing volatilization of  $\text{NH}_3$ . The absorbed  $\text{NH}_3$  in this system was determined with using 0.002 N HCl as titrimetric method. Physical and chemical analysis of 3 soils and BToP used in the study was given into the Table 1 and Table 2.



Table 1. Physical and chemical analysis of soils used.

Soil	pH	EC CaCO <sub>3</sub> O.M.			Na <sup>+</sup> K <sup>+</sup> Ca <sup>++</sup> Mg <sup>++</sup>				P Zn Fe			Texture			
		%			meq.100 g <sup>-1</sup>				mg.kg <sup>-1</sup>			Sand	Loam	Clay	Group
1	8,15	0,125	26,32	2,28	0,17	0,71	29,27	12,55	26,02	0,25	5,03	23,96	26,81	49,24	C
2	8,02	0,100	22,07	2,14	0,11	0,79	31,29	5,69	11,56	0,21	7,77	21,60	35,50	46,90	C
3	8,01	0,186	4,84	1,48	0,21	0,77	35,12	12,36	17,20	0,26	5,40	17,65	19,19	63,16	C

The soil samples were selected from 3 areas in the Pazarçık-Kahramanmaraş, Turkey (Elinç, 2000; Güvercin 2001) in this study and were used to determine NH<sub>3</sub> losing by volatilization.

Table 2. Physical and chemical contents (%) of BToP (Fengel and Wegener, 1984).

Bark Talk of Pine	Lignin	Ash	Carbohydrates		Extractives	Constitute of Pine
			Cellulose	Hemicellulose		
BToP	23,7	3,5	35,2	19,0	18,6	10-20

## 2. The experiment with using of straw and wood shaving

To limitation of NH<sub>3</sub> losing straw and wood shaving were added to the soil at 2 g level of organic materials. The nitrogen source urea (N: 46 %) fertilizer as 100, 200, and 300 ppm doses were mixed to 10 g soil. In a closed system it was held air compressed to the soil+straw or wood shaving+nitrogen solution mixings at 8 hours and 1 bar/minute at atmospheric pressure. Then NH<sub>3</sub> losing was held in the boric acid solution in the closed and controlled air system. For absorption of NH<sub>3</sub> experimental set-up designed with two 500-mL conical flasks, in the first conical flask was packed soil+organic material+nitrogenous solution fertilizer samples, and the second conical flask was filled with 50-mL boric acid solution to absorb NH<sub>3</sub> losses. There was also an air source by compressor in this system as income and outcome for increasing volatilization of NH<sub>3</sub>. The absorbed NH<sub>3</sub> in this system was determined with using 0.002 N HCl as titrimetric method. The texture analysis of soils was determined as clay.

## 3. The experiment with using of peat

An apparatus to measure ammonia losses in soil+peat+nitrogenous fertilizer (urea) samples by volatilization was developed under laboratory-controlled conditions. The apparatus has a sample and an absorption chamber system. The absorption chamber systems were used a controlled capture system which comprised a 500-mL flask container with a lid with an air inlet (8 hours and 1 bar/minute) and outlet on top side. The soil+peat+urea sample was set as 25 g soil+0.4 g peat+urea fertilizer (100 and 200 kg N/ha) and without peat as control to each application. The pure water enriched with these nitrogenous fertilizers and applied to the soil in the controlled system. The pump outlet was connected to the absorption system, forcing the head-space gases to bubble-up through a 2% boric acid solution, so absorbing the volatilized ammonia was determined with using 0.005 N H<sub>2</sub>SO<sub>4</sub>.

## Results and Discussions

### 1. The losses and of NH<sub>3</sub> (%) with using BToP

The environmental pollution and theirs effecting factors have been studies in recent years. These studies have aimed regulating and reducing this pollution. It follows that ammonia pollution must be managed without excessive contribution to soil, water, or air pollution and be compatible with efficient using nitrogen fertilizers. Comparative ammonia (NH<sub>3</sub>) losses were assessed using BToP as a static sorbent in this laboratory study. The loss of NH<sub>3</sub> (%) from urea was given into the Table 3.

Table 3. The losses and of NH<sub>3</sub> (%) from urea and limiting with using BToP .

Soil	Urea treatment, kg N/ha	Losses of NH <sub>3</sub> , %				Limitation of losses of NH <sub>3</sub> with BToP treatment, %		
		Control	BToP treatment, %			5	10	20
		0	5	10	20			
1	250	3,6	3,3	3,2	3,2	8,3	11,1	11,1
	500	6,9	5,6	5,2	5,1	18,8	24,6	26,1
2	250	3,6	3,2	2,9	2,9	11,1	19,4	19,4
	500	4,4	3,9	3,1	3,0	11,4	29,5	31,8
3	250	4,2	4,2	3,5	3,5	0	16,7	16,7
	500	7,2	5,9	5,5	5,5	18,1	23,6	25,0
Min.	250	3,6	3,2	2,9	2,9	0	11,1	11,1
	500	4,4	3,9	3,1	3,1	11,4	23,6	25,5
Max.	250	4,2	4,2	3,5	3,5	11,1	19,4	19,4
	500	7,2	5,9	5,5	5,5	18,8	29,5	31,8

For having high calcareous soils and clay content, at the 1<sup>st</sup> and 2<sup>nd</sup> samples maximum limitations were obtained from BToP treatments. But for having low calcareous soils, at the 3<sup>rd</sup> sample 31.8% of maximum limitation was obtained from BToP treatments. Bark of trees especially in this BToP mainly may be used as a limitation matter to loss of NH<sub>3</sub> by volatilization.

## 2. The losses and of NH<sub>3</sub> (%) with using straw and wood shaving

Comparative ammonia losses from nitrogenous fertilizers were determined and limited with using straw and wood shaving as sorbent were added to the soil and fertilizer compound. The losses of NH<sub>3</sub> (ppm) from urea and ammonium sulfate fertilizers were given into the Table 4.

Table 4. The losses of NH<sub>3</sub> (ppm) from urea fertilizers with using straw and wood shaving.

Fertilizer	N dose, ppm	The losses of NH <sub>3</sub> , ppm	N losses, %	Limitation of N losses, %	
				Straw	Wood shaving
Urea	100	3,50	3,50	2,42 (30,86%)	2,80 (20,00%)
	200	3,50	1,75	1,33 (24,00%)	1,54 (12,00%)
	300	3,50	1,17	0,89 (23,93%)	0,99 (15,39%)

For having soil with high clay content, the losses of ammonia from urea fertilizer were limited to 20.00% as maximum limitations of ammonia losses at 100 ppm with wood shaving application. With application of urea the losses of ammonia were limited 30.86% as maximum limitations of ammonia losses at 100 ppm with straw application. Generally, the losses of ammonia were increased with increasing of urea - nitrogen content. The losses from two fertilizer types were limited with using straw and wood shaving, but cause of two types organic material level was used 2 g in the high level of fertilizer applications to limiting of ammonia losses decreased with high level of nitrogen applications.

## 3. The losses and of NH<sub>3</sub> (ppm) with using of peat

The volatilized ammonia was determined from the controlled system at the concentration of NH<sub>3</sub>-N (Table 5). Absorption by peat in this experiment recovered at 11.6% and 20.6% of the volatilized ammonia.

Table 5. The losses of NH<sub>3</sub> (ppm) from urea with using peat.

Fertilizer	Nitrogen doses, kg/ha	The losses of NH <sub>3</sub> , ppm	NH <sub>3</sub> losses with peat, ppm	Limitation of N losses, %
Urea	100	3,08	2,97	11.6
	200	3,36	3,00	20.6

### Conclusion

Separately, in this subject it is necessary to many studies will be to limitation of volatilization. A special injection assembly is to apply it into the soil at a depth of 15 to 20 cm to avoid loss of NH<sub>3</sub> by volatilization. In many cases it is not opportune to apply all the nitrogen in one dressing but rather to split the total amount into two or several application. This type of nitrogen treatment is particularly common in intensive cropping systems where crop yields are high and where large amounts of nutrients are applied. Comparative ammonia (NH<sub>3</sub>) losses were assessed using BToP, wood, straw, and peat as a static sorbent in this laboratory study. According to the results, to using BToP, straw, wood and peat as a static sorbents were determined 31.8%, 20.0%, 30.9%, and 20.6% of maximum limitation of ammonia losses at using urea fertilizer, respectively. Absorption of ammonia by different organic materials as in this experiment recovered at high levels of the volatilized ammonia.

### References

- Allison, F.E., 1995. The enigma of soil nitrogen balance sheets, *Advances in Agronomy VII*: pp. 231-250.
- Alma M.H. and Kelley, S.S., 2002. The application of pyrolysis molecular beam mass, *Biomass and Energy*, Volume: 22, pp. 411-419.
- Cantarella, H. & Raij, B.van. 1986. Adubação nitrogenada no Estado de São Paulo. In: SANTANA, M.B.M., coord. Adubação nitrogenada no Brasil. Ilhéus, CEPLAC, Sociedade Brasileira de Ciências do Solo, p.47-49.
- Cook, G.M., 1972. Fertilizing and maximum yield, Crosby Lockwood and Son Ltd., London.
- Du Plessis, M.L.F. and Kroontje, W., 1964. The relationship between pH and ammonia equilibria in soil, *Soil Sci. Soc. Amer. Proc.* 28:751-754.
- Elinç, F., Güvercin, E., Demirkıran, AR. 2000. The heavy metal contents of the Golia wheat in the center and Türkoğlu towns in Kahramanmaraş, *Proceedings of International Symposium on Desertification, 2000*, Konya, Turkey.
- Fengel, D. and Wegener, G., 1984. *Wood chemistry, ultrastructure, reactions*, Walter de Gruyter, Berlin.
- Fenn, L.B. and Kissel, D.E., 1975. Ammonia volatilization from surface applications of ammonium compounds on calcareous soils: Effects of calcium carbonate content, *Soil Sci. Soc. Amer. Proc.* 39:631-633.
- Güvercin, E., 2001. Kahramanmaraş'ta buğday plantasyonlarında çinko ve demir durumunun belirlenmesi, Kahramanmaraş Sütçü İmam Üniversitesi Fen Bilimleri Enstitüsü, Yüksek Lisans Tezi, Kahramanmaraş (Turkish).
- Lehr, J.J. and Van Wesemael, J.G., 1961. Volatilization of ammonia on calcareous soils, *Landouwk, Tijdschr.*, 73, 1156-1168.
- Melgar, R., Camozzi, M.E., & Figueroa, M.M. 1999. *Guia de fertilizantes, enmiendas y productos nutricionales*. Buenos Aires, Instituto Nacional de Tecnología Agropecuária, p.13-25.

- Pereira H.S., Leão A.F., Verginassi A., Carneiro M.A.C., 2009. Ammonia volatilization of urea in the out-of-season corn, *R. Bras. Ci. Solo*, 33: 1685-1694.
- Sağlam, M.T., 1976a. The losses of nitrogen as ammonia from soils using nitrogen fertilizers, Ataturk University, Agricultural Faculty, Erzurum, Turkey, 6(2):217-239
- Sağlam, M.T., 1976b. The study of N-losses and mineralized-N in Erzurum, Hasankale and Erzincan Plains, Ataturk University, Agricultural Faculty, Erzurum, Turkey,
- Sağlam, M.T., 1979. The losses of nitrogen as ammonia from soils in East Black sea region and Erzurum Plains, Ataturk University Press, Agricultural Faculty, Erzurum, Turkey, 165:667-672
- Sağlam, M.T., Tok, H.H., Adiloğlu, A., Öner, N., Demirkıran, A.R., ve Bellitürk, K., 1997. The losses of nitrogen as ammonia using different nitrogen fertilizers taken from Trace region Turkey, 1<sup>st</sup> Trace Region Soil and Fertilizer Symposium, pp. 239-242
- Terman, G.L., and Hunt, L.M., 1964. Volatilization losses of nitrogen from surface applied fertilizers as measured by crop response, *Soil Sci. Soc, Amer, Proc.*, 28:7.

## THE USE OF SOME WASTES IN *PRIMULA VULGARIS* CULTIVATION

Ebru YÖN<sup>1</sup>, Özgür KAHRAMAN<sup>2\*</sup>

<sup>1</sup>Canakkale Onsekiz Mart University, Graduate School of Natural and Applied Sciences, Landscape Architecture, Tezioglu Campus, 17020, Canakkale, Turkey

<sup>2\*</sup>Canakkale Onsekiz Mart University, Faculty of Architecture and Design, Department of Landscape Architecture, Terzioglu Campus, 17020 Canakkale, Turkey

\*Corresponding author: ozgurkahraman@comu.edu.tr

### Abstract

The population growth, migration from rural to urban areas, industrial developments increase the number and amount of waste day after day. Wastes can be reused in different areas like agricultural and industrial areas. This study was carried out to determine the usage chances of some wastes such as sawdust, coconut fiber, hazelnut husk and sewage sludge in *Primula vulgaris* cultivation between January and April, 2017. *Primula vulgaris* plants were cultivated in growing media such as 50 % coconut fiber + 50 % soil (S1), 50 % sewage sludge + 50 % soil (S2), 25 % sewage sludge + 75 % soil (S3), 25 % sawdust + 75 % soil (S4), 50 % sawdust + 50 % soil (S5), 25 % hazelnut husk + 75 % soil (S6) and 50 % hazelnut husk + 50 % soil (S7). The study was designed as a randomized plot design with 3 replications and 6 plants were used in each plot. Leaf number, leaf length, plant diameter, number of flowers, flower diameter, E.C. and pH of drainage water were measured as parameters every four weeks. These parameters were analyzed statistically by analysis of variance, Duncan's multiple comparison test and Pearson correlation with SPSS 23 software. Plant height were best value in S1 (11.22 cm), S4 (10.28 cm), S5 (9.94 cm), S6 (10.50 cm) and S7 (11.56 cm) within 4 weeks and best values in a term of number of flowers were obtained from S1 (12.28), S3 (12.89), S5 (14.61), S6 (14.11) and S7 (13.67).

**Keywords:** *Primula vulgaris*, Wastes, Substrate, Cultivation, Ornamental plants.

\*\* This study "The use of some wastes in the cultivation of *Primula vulgaris*" was produced from a master thesis titled

### Introduction

In recent years with the increasing population growth, some activities performed by human beings have resulted in a noticeable effect on the environment of some of the wastes that have emerged. Taking into consideration the possibility of adaptation to the environment in case of elimination of these wastes, it is a matter which should be considered in terms of the possibility of benefiting and acquiring in the communal public order. The most important consumption component of the ornamental plant sector is the growing media. It is seen that natural soil and peat are used as a filling material most in the ornamental plant cultivation of our country, especially in outdoor ornamental plants. When sustainable agriculture and environment are considered together, the use of natural soil as a filling material for flowerpot is not appropriate. At the same time, the soil cannot provide sufficient plant growth performance since it cannot provide the desired characteristics for the growing media of ornamental plant. On the other hand, although natural peat beds are renewable sources, they are not considered as an eco-friendly method and they even get reactions due to reasons such as the formation of the limited beds taking a long time, destruction of environmental integrity

with excavations and deterioration of the carbon dioxide cycle (Özdemir and Dede, 2014). The soil is considered to be a three-phase system consisting of solid, liquid and gaseous substances. For a good plant growth, a certain balance is required among these three phases (Demirbaş, 2010). For this reason, it is possible to establish a balance between the components of soil by adding supplemental material to the growing media. In an ideal growing media, sufficient ventilation should be provided for the root system of the plant, it should have sufficient water holding capacity, it should be able to protect its structure for a long time and be completely free from weed seeds, diseases and harms. It should not contain any substances that may poison the plants, it should provide support and stability to the plants. It should be easy to provide and cost-effective (Megep, 2008). *Primula vulgaris* Primulaceae family *Primula* forms the genus from. The major species that are important are *P. vulgaris* and *P.veris*. This plant, whose origin is estimated to be Turkey or Paşaeli, nowadays grows in a wide area from Western Europe to East Turkestan and is cultivated as an ornamental plant. It grows on the foothills of Turkey's Eastern Anatolia and Northeast Anatolia Region and on grass. It is cultivated in a peat or leaf decay with lightly structured soil mixtures in terms of organic substance (Meb, 2012). *Primula vulgaris* is one of the ornamental plants commonly used in landscape fields.

This study was carried out to determine the usage chances of some wastes on cultivation of *Primula vulgaris*.

### Material and Methods

This study was carried out between January and April 2017 in a private residential garden located in the center of Çanakkale province. Seedlings with an average plant height of 7.5 cm and a hill diameter of 16.7 cm was used as plant substance. *Primula vulgaris*. Seedlings were provided from a private company that cultivates ornamental plants in Çanakkale. After opening the drainage holes of 40x50x25 cm sized styrofoam flowerpots, 50 % coco peat + 50 % soil (S1), 50 % sewage sludge + 50 % soil (S2), 25 % sewage sludge + 75 % soil (S3), 25 % sawdust + 75 % soil (S4), 50 % sawdust + 50 % soil (S5), 25 % hazelnut husk + 75 % soil (S6) and 50 % hazelnut husk + 50 % soil (S7) mixes were placed in the flowerpots. The flowers of seedlings were plucked before planting, and on January 6th, 2017, the seedlings were sewn with a distance of 12.5 cm. The completely randomized design of the plot was set up in 3 replications according to pattern of the plot and 6 seedlings were placed in each replicate (in the flowerpot). After planting, the seedlings were irrigated until the drainage water came out, and irrigation was carried out according to climatic conditions in later periods. E.C. (mS/cm), pH, number of leaves (number), leaf length (cm), crown diameter (cm), number of flowers (number/plant) and flower diameter (cm) measurements were made every four weeks in the experiment. Variance analysis with SPSS 23 statistical software and Duncan's multiple comparison test ( $p < 0.05$ ) were applied to the obtained data.

### Results and Discussion

At the end of the 8th week of cultivation of *Primula vulgaris*, plants with 50 % sewage sludge + 50 % soil (S2) and 25 % sewage sludge + 75 % soil (S3) from growing media were lost due to high E.C. value. At the end of the 4th week, it occurred at E.C. 5.43 mS/cm in S2 media, at 3.60 mS/cm in S3 media and between at 0.53 and 0.67 mS/cm in the other S1, S4, S5, S6 and S7 medias. The pH of the growing media ranged from 7.45 to 8.31. The highest pH was detected in S2 media. 8th and 12th week data were not obtained due to plant deaths in S2 and S3 medias. Akat et al. (2015) stated that in plants of different proportions, *Limonium sinuatum* 'Compindi White', which they cultivated in the mixture of sewage sludge and soil,

death did not occur in the plants where the sewage sludge was used directly but some values fell.

According to the variance analysis; it was determined that the growing media did not make any difference on the number of leaves at 4th, 8th, and 12th weeks. The number of leaves was 9.44 to 13.23 units in the 4th week, 9.89 to 11.78 units in the 8th week and 6.72 to 8.72 units at the end of the 12th week (Figure 1). Although there was no statistical difference between growing medias, the lowest values at the end of the 4th week in the multiple comparison test were obtained from the sewage sludge mixtures. The highest values occurred in S1, S4, S5, S6 and S7 medias. A decrease in the number of *Primula vulgaris* leaf was observed at the 8th and 12th weeks.

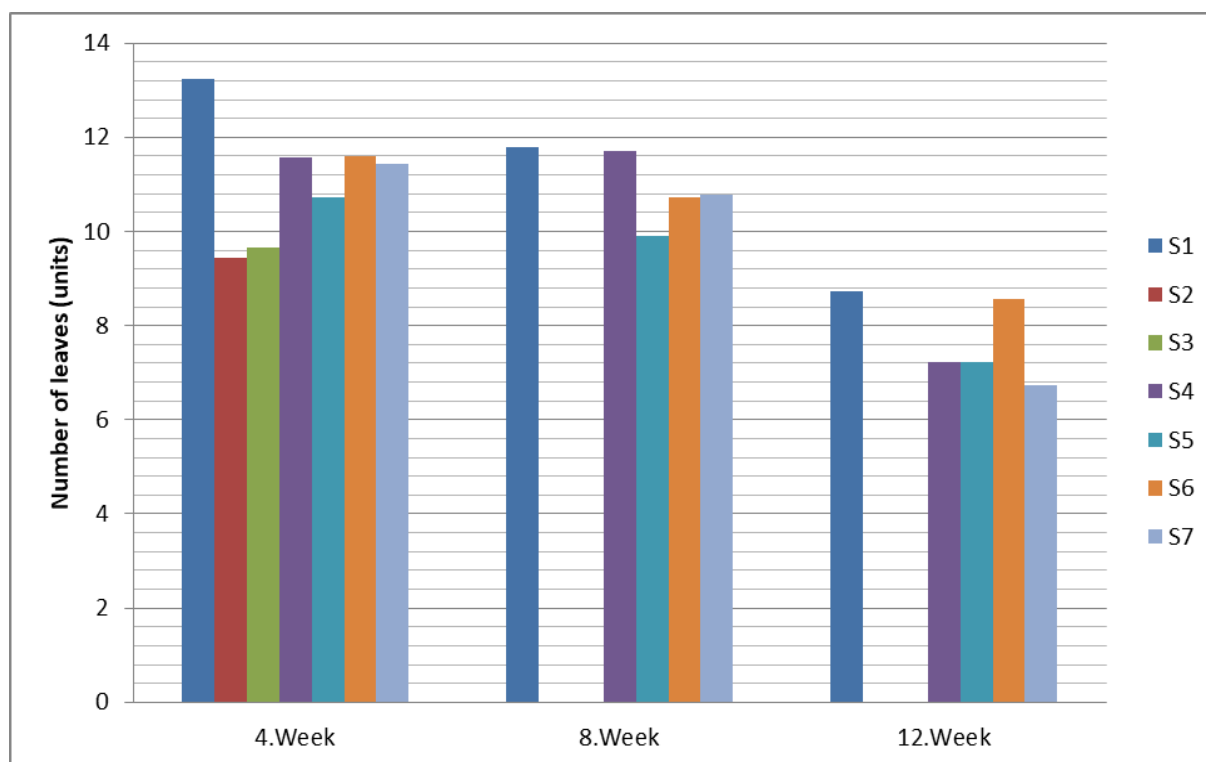


Figure 1. Effect of growing medias on the number of leaves.

The effect of growing medias on leaf length was found to be insignificant. In the first statistical group, the leaf length values of the 4th week were S7 (8.97 cm), S3 (8.69 cm), S6 (8.30 cm) and S1 (7.97 cm) medias according to the multiple comparison test (Figure 2). Leaf length occurred between 8.25-9.97 cm at 8th week and 7.25-10.36 cm at 12th week. Dede et al. (2012) suggests a mixture of 50 % hazelnut husk + 50 % sewage sludge in palm cultivation. Similar results were also obtained in this study.

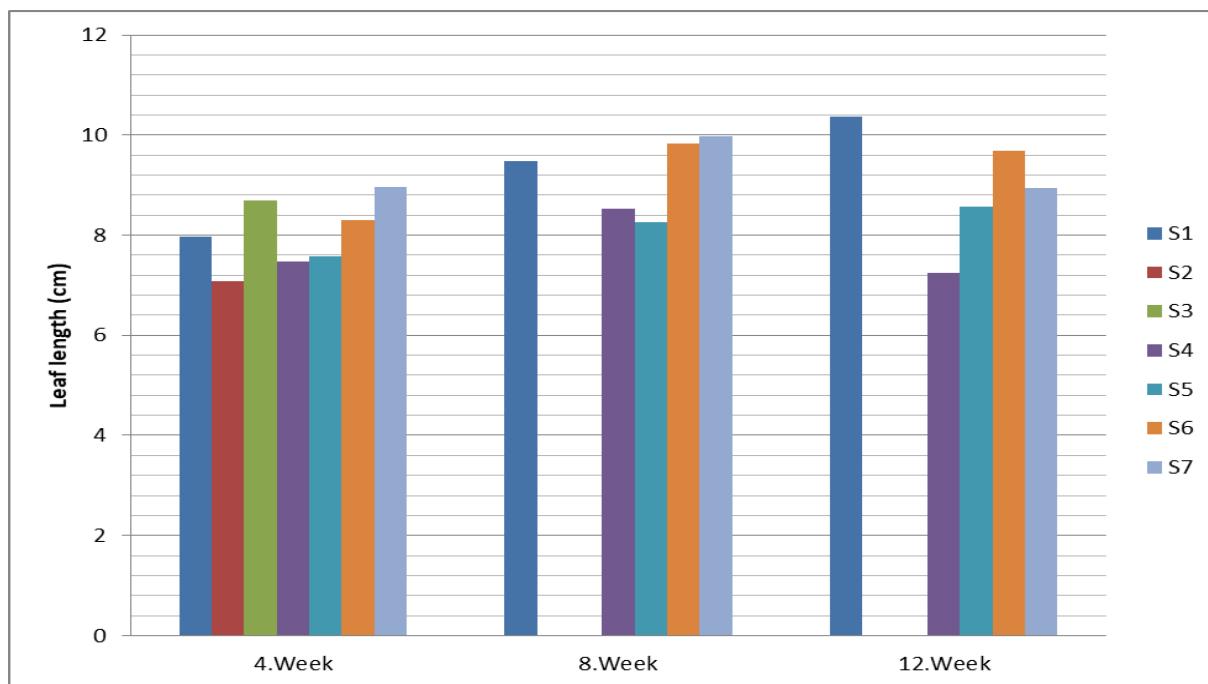


Figure 2. The effect of growing medias on leaf length.

According to the variance analysis, the effect of growing media on crown diameter was found to be insignificant at 4th and 12th week and it was found to be significant with 95% confidence at 8th week. The lowest crown diameter of the 4th week was 15.64 cm and the highest crown diameter was 17.42 cm (Figure 3).

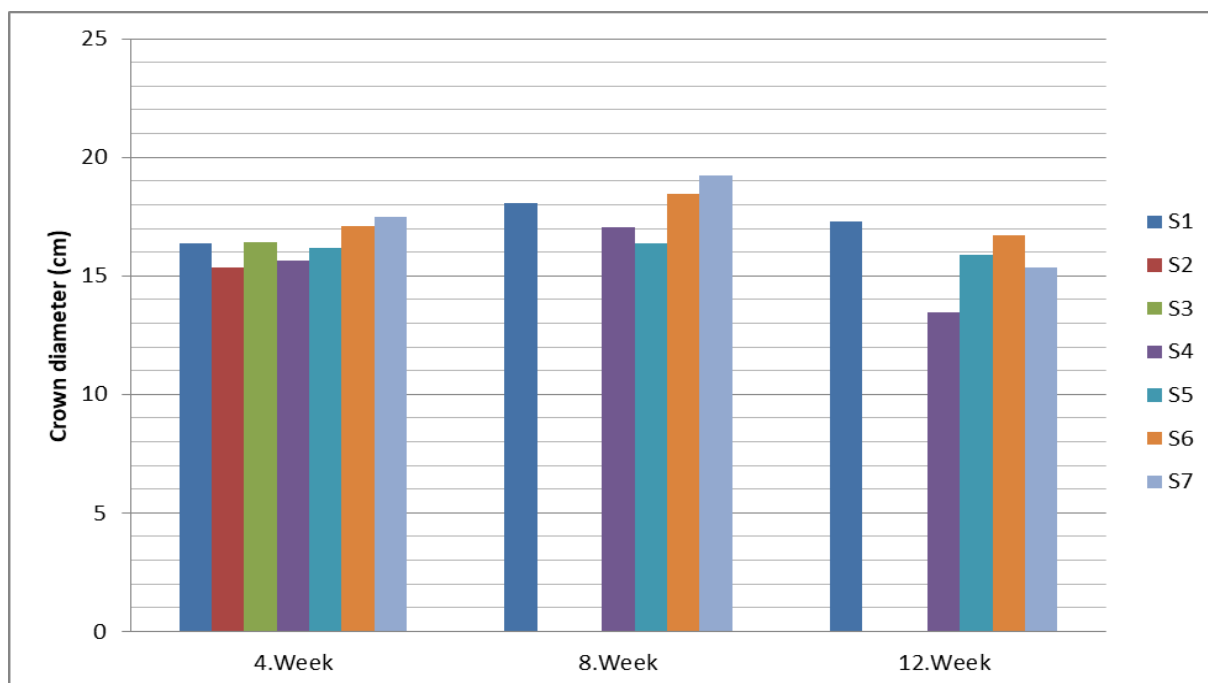


Figure 3. The effect of growing medias on crown diameter.

Three statistical groups were formed at the 8th week in terms of crown diameter. S7, S6 and S1 medias were in the first group, S6, S4 and S1 medias were in the second group.



In the study, the effect of growing medias on the number of flowers was found to be statistically significant at the 4th week ( $p < 0.05$ ) and 12th week ( $p < 0.01$ ), and it was found to be insignificant at the 8th week. The highest number of flowers in the 4th week was obtained from S5, S6, S7, S3 and S1 medias (Figure 4).

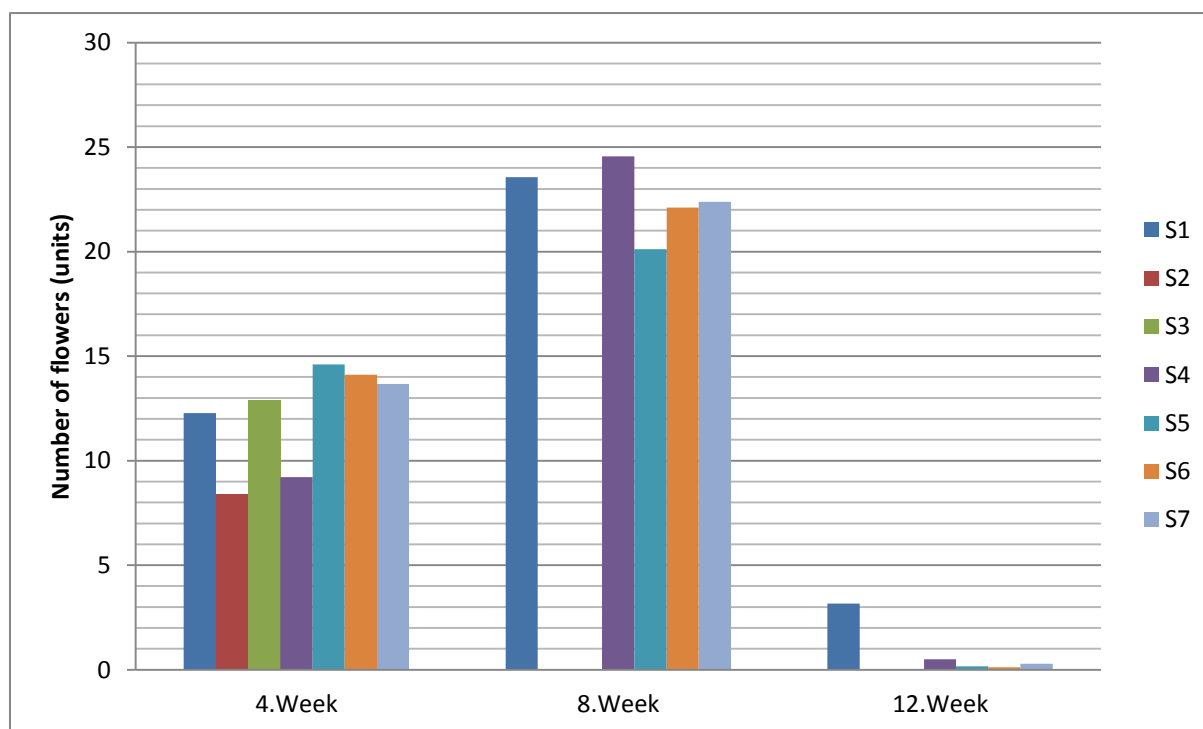


Figure 4. The effect of growing medias on the number of flowers.

The number of flowers in 8th week ranged from 19.94 to 24.56. In the 12th week, a decrease in the number of flowers was observed and the highest value occurred in S1 media. Demirkan et al. (2014); *Clarkia amoena* Ünal et al. (2011); *Freesia* species stated that the sewage sludge, which is mixed in increasing proportions to the soil in, increases the number of flowers. No effect of growing medias on flower diameter was detected. The diameter of the flower was 4.44 to 5.25 cm at the 4th week and 5.22 to 5.44 cm at the 8th week. The highest flower diameter was found in the S1 media.

### Conclusions

After cultivation, the results showed that it is possible to grow the *Primula vulgaris* in all the medias except the wastewater sewage sludge. The amount of salt in the media needs to be reduced in order to be able to cultivate in the wastewater sewage sludge media. The use of all the growing medias added to the soil after the composting process has been carried out effectively will be suitable for sustainable cultivation. Carrying out studies on the use of wastes repeatedly in the cultivation of ornamental plants will ensure the widespread use of waste.

### Acknowledgment

This study was produced from the master thesis titled "The use of some wastes in the cultivation of *Primula vulgaris*" by Çanakkale Onsekiz Mart University, Graduate School of Natural and Applied Sciences, Landscape Architecture Department. We would like to thank Çanakkale Onsekiz Mart University, Graduate School of Natural and Applied Sciences, Landscape Architecture Department for their contributions.

### References

- Akat H., Demirkan G., Akat Ö., Yağmur B., Yokaş İ. (2015). Effects of sewage sludge applications on plant growth, yield and flower quality of *Limonium sinuatum*. Journal of Agriculture Faculty of Ege University, 52 (1):107-114.
- Dede Ö.H., Dede G., Özdemir S. (2012). The use of hazelnut husk and biosolid in substrate preparation for ornamental plants. Vol.7(43), pp. 5837-5841.
- Demirbaş A.R. (2010). Growing ornamental plants. Samsun Directorate of Provincial Food Agriculture and Livestock, Farmer Education and Publication Branch Publications, 64p, Samsun, Turkey.
- Demirkan G.Ç., Akat H., Yokaş İ. (2014). Effects of sewage sludge on the growth and flower development of *Clarkia amoena*. Journal of Agricultural Faculty of Uludag University, 28 (2):49-57.
- MEGEP. (2008). Horticulture. Preparation of Soilless Culture. Life-Long Learning General Directorate, Strengthening of Vocational Education and Training System Project (MEGEP), 62p, Ankara.
- MEB. (2012). Agricultural Technology. Cultivation of Indoor Ornamental Plants 2, Ministry of National Education, 70p, Ankara.
- Ünal M., Karaca A., Camcı Ç.S., Çelik A. (2011). Effects of Sewage Sludge Originated from Urban Waste Water Treatment Plant on Growth of *Freesia* Spp. and Some Properties of Soil, Selçuk University, Journal of Selçuk Agriculture and Food Science, 25 (2): 46-56.
- Özdemir S., Dede Ö.H. (2014). Organic growing media for ornamental plants. Sakarya Chamber of Agriculture Publications, Sakarya.

## COMPREHENSIVE EVALUATION OF IRRIGATION SCHEMES: A CASE STUDY IN SEYHAN AND CEYHAN RIVER BASINS IN TURKEY

Fatih BARUTÇU<sup>1\*</sup>, Yunus BÜLBÜL<sup>2</sup>

<sup>1</sup>Directorate of Agricultural Production Enterprise, Agricultural Extension and In-Service Training Center  
(Adana TAYEM), Adana, Turkey

<sup>2</sup>South Yüreğir Water User Association, Adana / TURKEY

\*Corresponding author: fatihbarutcu44@gmail.com

### Abstract

Çukurova which is characterized by the Mediterranean ecosystem is the most important plain in Turkey. About 10% of the agricultural proceeds of Turkey has been produced in the region and 5% from Seyhan and Ceyhan River Basins. This study was carried out in the Lower Seyhan and Ceyhan River Basins located in the Çukurova in southern of the Turkey.

In this paper, the cumulative impact of existing irrigation projects in Seyhan and Ceyhan Basin was evaluated by considering technical, economic, social and training problems. Irrigation efficiencies were computed according to the amount of water diverted into the canals and crop evapotranspiration. Physical state of the irrigation infrastructure was examined. In order to determine judicial attitudes and behaviours of farmers related to irrigation, a survey was conducted with 253 farmers.

The findings obtained and survey results showed that there were many problems related to irrigation efficiency, irrigation management, irrigation infrastructure, training and extension issues. Performance of irrigation practices, especially in the efficiency of water application is still too low, i.e. 41-44% in the catchment level. This is due to inadequate irrigation infrastructure and farmers lacking the management skills to manage their irrigation systems properly. As a result, the immediate improvement of the irrigation infrastructure are needed besides improvement the farmers' irrigation management skills.

**Keywords:** *irrigation management, irrigation infrastructure, irrigation efficiency, Lower Seyhan Plains, Lower Ceyhan Plains*

### Introduction

Soil and water resources are the first among the most important natural wealth of the community. Society of the social and economic aspects of development, said the development of these resources and rational use is of paramount importance. The development and rational use of these resources are great importance.

In 2025, the world population is predicted to increase to 8 billion (UN, 2013) Therefore, food sufficiency and security will be most important problems of the world in future. Feeding the growing population, meeting the raw material needs of the agricultural industry, increasing the share of the national product of the agricultural sector depends on increased production in agricultural areas. Irrigation is one of the most influential factor in increasing agricultural production obtained from unit area. The overall objective of irrigation investments, intended for soil and water resources development, is to increase to the highest level of welfare of the population working in agriculture along with increasing agricultural production. Since agriculture continues to be the main water consumer, improved agricultural water use in irrigated agriculture will have a direct impact on local and regional water demands. Improved agricultural water use results in higher crop yields. In order to achieve this improvement,

some technical advances in two key areas are anticipated: (i) irrigation network water management and (ii) on-farm irrigation management.

Irrigation infrastructure is one of the key factor for governments to increase productivity and economic growth and meet its policy objectives. More specifically, irrigation is crucial for the part it plays in responding to the challenges of climate change, agricultural drought, desertification, food security, sustainability, enhancing economic development, reducing migration and enhancing social inclusion (Barutçu et al., 2013).

As a result, the purpose of this study is to evaluate the cumulative impact of existing irrigation projects in Seyhan and Ceyhan River Basin by considering technical, economic, social and training problems, and to identify local farmers' judicial attitudes and behaviours on irrigation and irrigated agriculture.

### Material and Methods

In this study, agricultural irrigation and related problems in Lower Seyhan and Lower Ceyhan Plains were determined and evaluated by the participation of relevant stakeholders and field studies. Net irrigation area of the plains is 261636 hectares (Figure 1). The main material of the study is based on measurement, observation, extended review of secondary data and the original data collected by surveys from the agricultural enterprise owners making production in the Lower Seyhan and Ceyhan plains. Irrigation efficiency was computed according to the amount of water diverted into the canals, crop pattern, crop evapotranspiration and net irrigation area. In order to determine judicial attitudes and behaviours of farmers related to irrigation, a survey was conducted face to face with 253 farmers in 75 villages. Surveyed villages and towns were randomly selected in Seyhan, Yüreğir, İmamoğlu, Ceyhan, Karataş and Yumurtalık districts where production is intensively performed. Besides the information on the participants, different topics on irrigated agriculture, irrigation infrastructure and irrigation organisation were examined.

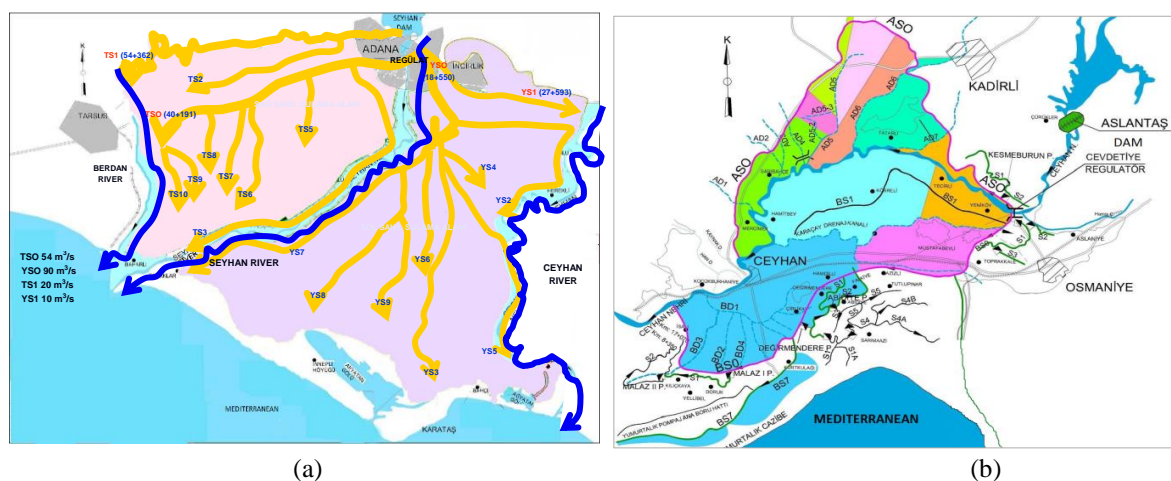


Figure 1. Lower Seyhan (a) and Lower Ceyhan Plain (b) irrigation scheme

## Results and Discussion

Agricultural irrigation and related problems in Lower Seyhan and Lower Ceyhan Plain have been determined and evaluated by the participation of related stakeholders and field studies considering current situation.

In the study area, 96.8% of the irrigated land was designed according to the open canal system. The remaining 3.2% is irrigated by pumped irrigation. When it is evaluated on the basis of conveyance line, pipeline system is used in 9.8% of water transmission lines while open canal system is used in 90.2%. The main irrigation canals are trapezoidal and covered with concrete, and the majority of secondary canals are in oval type.

Planning and designing the irrigation infrastructure according to the open canal system bring with many problems related to agricultural irrigation. More than 50% of the problems identified related to irrigation in the region have been associated directly or indirectly with open irrigation canal transmission lines by relevant stakeholders in face-to-face meetings. Although open canals have high water carrying capacity and smooth easier to use depending topography, water transmission losses in open canals are quite high. These transmission losses include evaporations from canal water surface, leaks at canal connection points, losses resulting from breakage of canals. Inadequate maintenance and repair in canals increase the leakage losses. Some data obtained and calculated for LSP irrigation and LCP irrigation were given below.

Table 1. Irrigation performance values of LSP and LCP irrigation projects (average of 5 years between 2012-2016)

Land	Irrigation efficiency (%)	Irrigation ratio (%)	Irrigation area (ha)	Irrigated area* (ha)	Crop water requirement (hm <sup>3</sup> )	Water consumption (m <sup>3</sup> /ha)	Water delivered (hm <sup>3</sup> )
LSP	41.1	88	153143	145026	770,4	13272	1876
LCP	44.2	83	107394	96970	463,2	10899	1542

\*Including aftercrop and non-network irrigation

Water use efficiency (WUE) in the region was quite low ranging 28.1 to 58.1 for the last 5 years. When other losses and leaks in the transmission and distribution were added, the total irrigation efficiency in the Lower Seyhan Plain (LSP) and Lower Ceyhan Plain (LCP) was determined to be 41.1% and 44.2% respectively in average (Table 1). The increase in irrigation efficiency in recent years in LCP is due to reducing water given to the network because of decrease in water resources and drought. The most important reason for lowering irrigation efficiency is the fact that the water transmission networks are consisting of open canals. Another important reason is that the efficiency of on-farm irrigation systems is too low. Similar to our result Özekici et al. (2007) revealed that canal tail losses were determined 36,6% and 11,5% in two different WUAs. Additionally, total irrigation efficiency is determined as %48 and %53 in LSP (Tekinel et al, 1988). One can understand from the results; it has not been any progress in the irrigation efficiencies for last 30 years.

Irrigation rate in the irrigated areas was 88% in LSP and 83% in LCP for an average of 85% for 2012-2016. The amount of unirrigated area in irrigated farmlands is approximately 30250 ha. As a result of surveys conducted with farmers, the reasons for non-irrigating in irrigated areas were given in Figure 2.

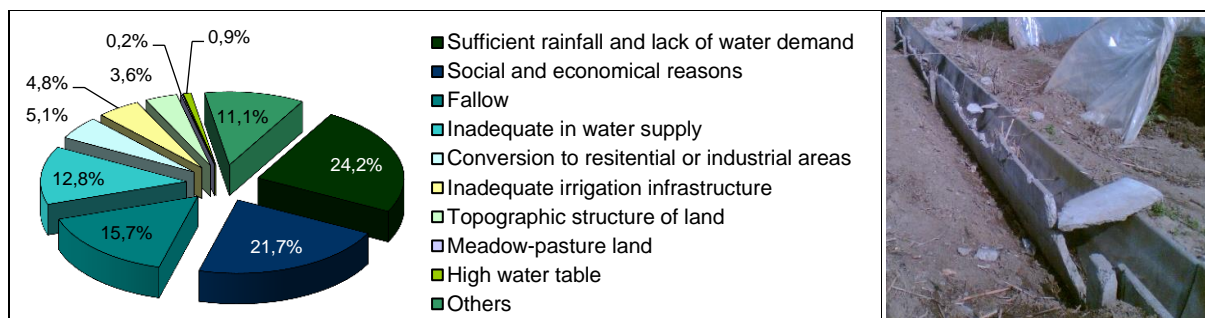


Figure 2. The ratio of unirrigated area and reasons in the area having irrigation infrastructure

One can understand from the figure above, the most important reason (23%) for giving up irrigation is that the producers find the precipitation to be sufficient and they are not in demand of water for irrigation depending on the crop pattern. Especially wheat, barley and so on. Producers have not preferred to irrigate the crops particularly wheat, barley and other crops in the cereal group, depending on the rainfall. The other important reason for not irrigating was social and economic reasons (22%). Especially in the areas where water distribution are made with pumping, the high irrigation water charges economically challenged the producers. Ultimately, producers could prefer to cultivate crops that need less water. The use of variable speed pumps and high-efficient (energy efficient) electric motors in such pumped irrigation areas can reduce pumping energy costs by 10 to 40% depending on flow demand conditions (Barutçu, 2005, Barutçu et al. 2007). Therefore, it is considered important that the technological transformation of such pumping stations as soon as possible in terms of energy efficiency and profitability of production.

Another important reason was the inadequacy of water resources (13%) due to poor irrigation infrastructure and organization. Failure to supply irrigation water at the amount and time requested by the farmer could eventually lead farmer to give up irrigation.

The fact that irrigation infrastructures in the region are old is one of the factors that increase the need for maintenance and repair. According to the data of 2016, the maintenance and repair costs of irrigation network were approximately €6 357 293. In the calculations, maintenance and repair costs per unit area were determined as 24,3 €/ ha. Considering that these facilities have complete their economic lives, the costs mentioned above will continue to increase much more each year. On the other hand, existing underground drainage systems also cannot function due to filling their economic life and does not meet the needs hence it need to be renewed. For this reasons, in the region, it is necessary to project the new irrigation infrastructures as collective pressurized irrigation systems, and to replace the structures that have completed their economic life must be transformed into pressure irrigation system over time.

In the existing irrigation facilities in the region, the water supplied to the land cannot be measured because the existing irrigation infrastructure is not appropriate for measuring water at the field level. Only the water given to the canal can be measured. Inadequacy of farmers' knowledge and skills on irrigation, lack of practice to apply balanced and measured water to crops, and lack of irrigation system tools and equipment affect production. On the other hand, the water used by the farmer is charged on the basis of area and cultivated crop (Barutçu et. al, 2013, Özekici et.al., 2007). Because water fees are not determined on the volume basis, farmers tend to use more water than they need. Beside this, the wrong mentality like "more water, more yield" in the farmers leads them to extreme irrigation. In terms of effective use of irrigation water, it is absolutely necessary that water supplied to the land should be priced according to basis of volume by measuring it. Therefore, the development of the existing irrigation infrastructure is important for conservative water use and the future of the agriculture sector.

The small size of the irrigation area increases the maintenance, repair and investment costs. Optimum area size for a water user association in Turkey is recommended as 7,000 ha. There are total of 34 irrigation associations within the region. The area of only 9 of these is more than the optimum area size. The remaining WUA's have the area below the optimum limit. The average area operated by WUA's is 3209 ha. When unit costs WUA's per hectare were analysed, it was seen that the costs of 12 of the 18 WUA's in LSP and 6 of the 9 WUA's in LCP were higher than the average cost. It was observed that costs of small irrigation associations were high due to the fixed operating costs. The fact that the operating area of the WUE's is very small, increases the maintenance, repair and investment costs in other words the irrigation water prices. WUA's that have small operating areas are needed to reorganise by combining to reach the optimum area size

Although there were water prices differences among the irrigation associations, it was found that irrigation water prices in the pumped irrigation region were minimum 3 times higher than water prices in gravity irrigation areas in 2016. The high irrigation water prices in these areas force producers to switch from irrigated agriculture to rainfed agriculture. This caused some irrigation facilities to not being operated particularly in pumped irrigation areas. For this reason, energy costs should be reduced in irrigation sector.

Increasing the value of agricultural production depends on obtaining more quantities of production and better quality products in agricultural areas. The realization of this situation is possible with the training of the farmer, in other words by agricultural extension. Extension services in the region are carried out by the staff of the Provincial Directorate of the Ministry of Food, Agriculture and Livestock but are not carried out effectively due to the insufficient number of trained personnel. Inefficient and ineffective extension services has adverse effects on water resources, agricultural environment and production quality. Thus, there is a tendency to use excessive water. Hence water losses such as surface runoff, deep seepage could be increased. As a result, irrigation efficiency falls. As a consequence, many problems such as poor preparation of land for irrigation, drainage, high groundwater, salinity may emerging.

In the survey conducted within the study, 83% of respondents stated that they had never been trained on irrigation. Therefore, it could be said that extension services in the region was very lack in irrigation. The Ministry of Food, Agriculture and Livestock, particularly the

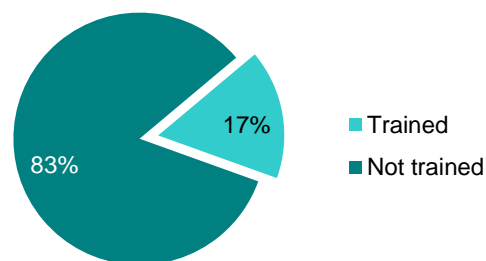


Figure 3. Share of farmers having irrigation training

irrigation cooperatives and associations, have a major duty for extension. These institutions should work together to eliminate the training requirement that the farmer needs for irrigation. According to survey results, when the on-farm irrigation methods were evaluated, it was seen that the using rate of surface irrigation methods in the region was 51% and the remaining 49% was in pressurized irrigation systems. In pressurized irrigation systems, drip irrigation methods had a bigger share with 28% (Figure 4). The respondents were also asked which irrigation method they would like to prefer for their effective use of water resources. 74% of the respondents preferred drip irrigation system. One can understand from this result that the advantages of drip irrigation systems in many respects have been recognized by farmers. Among the reason of drip irrigation preferences; better plant nutrition, lack of labour cost, low water consumption, ease of operation and high yield were prioritized. Those who prefer surface irrigation mostly answered that low investment cost due to the existence of canal system and the absence of additional energy costs (Figure 5).

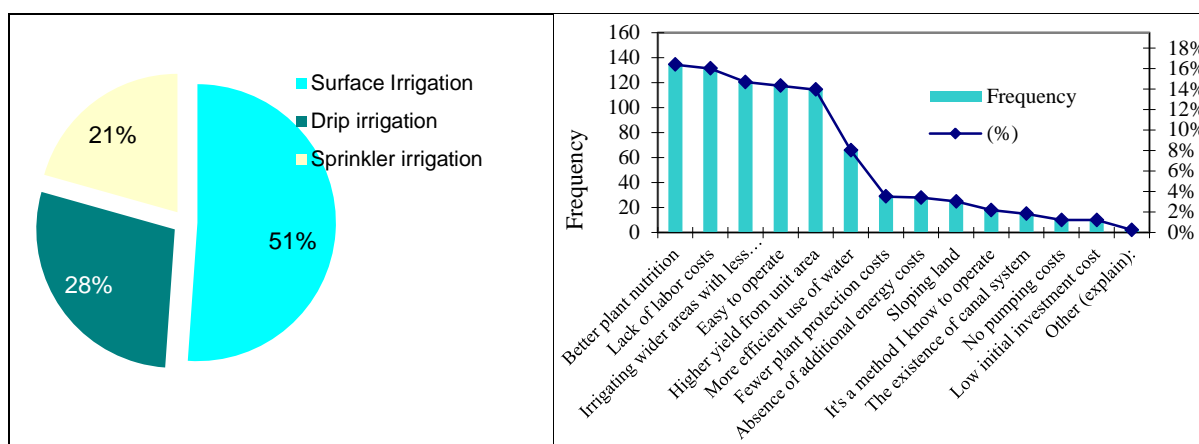


Figure 4. Rate of the irrigation methods Figure 5. Reasons for selection irrigation system

The respondents reported the most important irrigation problems they faced in their production areas as high irrigation water price, water shortage, inadequacy of drainage canals, high energy costs for pumping, inadequate and unbalanced water distribution respectively (Figure 6). The high irrigation water price are due to the high maintenance and repair costs. In addition, when determining irrigation water prices, it can be said that introducing a participative, transparent and standard approach will change the high perception of water rates.

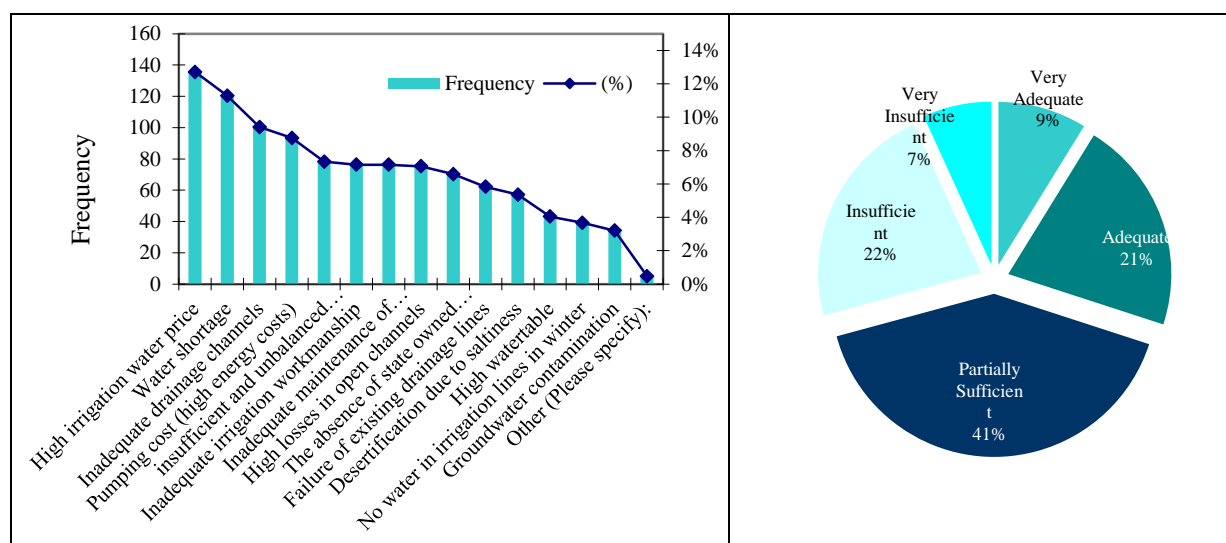
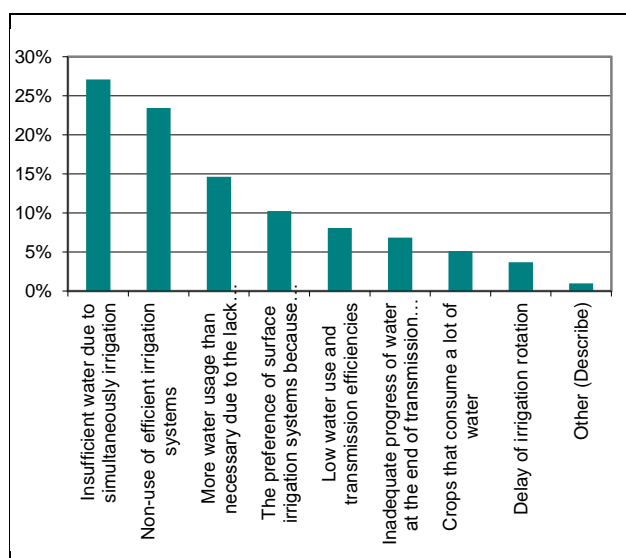


Figure 6. Irrigation problems of respondents

Figure 7. Water sufficiency assessment

When respondents asked if irrigation water is sufficient during the whole production season, those who think that is inadequate had a share of 29% in total. The share of those who think that irrigation water is very inadequate in this group was 7%. It was noted that this group was consisted mainly of farmers who are farming at the end of irrigation lines so they could not benefit from irrigation water sufficiently. 41% of respondents who think irrigation water “partially sufficient” declared that they did not have serious water problem throughout the irrigation season although they suffered from water shortages in small levels (Figure 7). The perception of irrigation water as inadequate in the region, which has plenty of water resources shows troubles of inefficiency in the transmission and usage of irrigation water and organisational problems in distribution of irrigation water. Moreover, most farmers have no technical knowledge of the amount of water they need for irrigation.





Most of those who suffer from water shortages have declared that the water in the canals was not sufficient due to the simultaneous use of water (Figure 8). This is also the result of the fact that night-time irrigation is not very common in the region. The water level in the canals falls due to the simultaneous irrigation especially during the daytime hours and the farmers at the end of the irrigation lines cannot benefit from irrigation water at desired level. On the other hand, in evaluations on the use of open canals, the biggest problem (30.6%) was reported as the lack of maintenance and repair.

Figure 8. Reasons of water shortage according to respondents

If irrigation water is sufficient for each period, 62% of the respondents think to change their cropping patterns. It has been determined that the respondents who have this idea are more monoculture farmers. This shows that if the water is sufficient, there will be a change in the crop patterns of the region with the tendency towards the competitive products which are economically profitable (Figure 9).

According to the interviewees, the services provided by irrigation related institutions and institutions are not adequate with share of 42% in total. Only 20% of the interviewees think the services are adequate. One can find out from this result that the services provided are not well publicized to the beneficiaries (Figure 10).

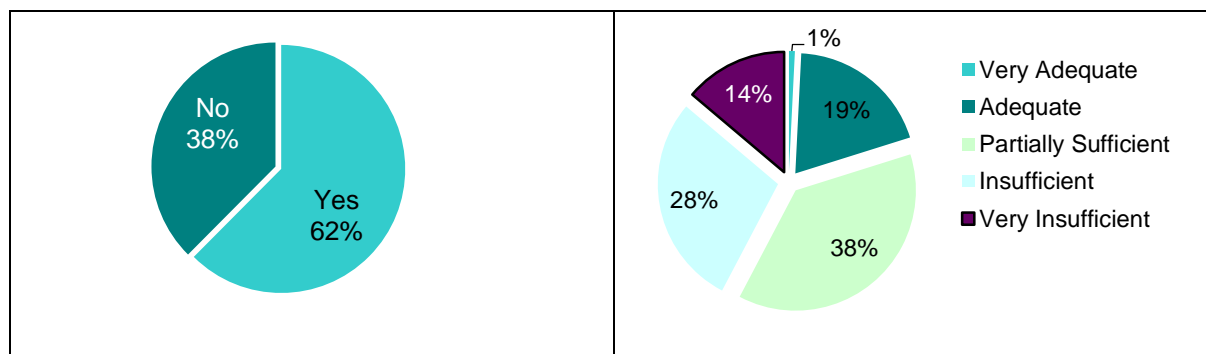


Figure 9. Tendency of changing crop pattern Figure 10. Sufficiency of the services provided

On the other hand, 43% of the interviewees thought consulting agricultural institution related to irrigation in solving irrigation problems. Having only about 5% of those who thought to get technical support from universities shows that the communication between the university and the producers is weak. The private sector has also a significant influence on the producers in solving irrigation problems with a share of 24%.

### Conclusions

As a result of the field studies and survey results, it has been determined that there was excessive water use in both plains. Irrigating most of the areas with surface irrigation methods unconsciously causes a lot of problems, especially in poor drainage areas, and also prevents the efficient distribution of the irrigation water which is sufficient for the region.

The average irrigation efficiency in the region is around 41-44%. Although there are many reasons of low irrigation efficiency, an important problem is the type of the on farm irrigation method and the application technique of the method used. Efficiencies of surface irrigation systems is very low in the region. For example Önder et al. (2004) have found irrigation efficiency 48-60% on corn-cultivated fields using surface irrigation. However, it is known that the efficiencies of surface irrigation systems in some developed countries can rise up to 85% depending on the type of the surface irrigation method. Accordingly, it is possible to increase the water use efficiencies to the higher levels by training in the region.

As a result of the field surveys, it has been understood that farmers have had significant problems such as irrigation costs, maintenance and repair of irrigation networks, water distribution, drainage, training and extension. The research findings revealed that local producers did not have sufficient information on irrigated agriculture and that the relevant institutions were not successful at the desired level for irrigation extension and farmer training.

It is predicted that if all the projects in the Seyhan Basin are to be implemented in the future, there will be 20% water shortage in arid years (Selek et al., 2008). For this reason, design of the new investments must be projected as collective pressurized irrigation network besides replacing existing irrigation projects that have completed their economic life with pressurized irrigation system over time. Conversion of Lower Seyhan Plain Irrigation into a pressurized closed irrigation network by taking the irrigation water directly from the Seyhan Dam Lake is an option that should be taken into consideration.

### **References**

- Anonymous, (2012-2016). Annual Reports of Water User Associations (2012-2016). DSI the 6. Regional Directorate, Adana.
- Barutçu F., Bülbül R., Uyan, A., Tepeli, E., Çınar M., Sarıtaş H. (2013). An Analysis of Adana Agricultural Irrigation Infrastructure, Irrigation Problems and Suggested Solutions (Adana Tarımsal Sulama Altyapısının Analizi Sulamanın Sorunları ve Çözüm Önerileri), *Editor: Barutçu F.*, Adana.
- Barutçu, F., Lamaddalena, N. Fratino, U. (2007). Energy Saving For a Pumping Station Serving an On-Demand Irrigation System: Study Case. Options of Mediterranean, Number 56-Vol.I, Sayfa 367-379. 2007.
- Barutçu,F., (2005). Energy Saving Criteria for Optimal Design of a Pumping Station Serving an On-Demand Irrigation System. MSc. Thesis. Instituto Agronomico Mediterraneo di Bari/İtalia.
- DSİ, (2012-2016). Annual Reports (2012-2016). State Hydraulic Works the 6. Regional Directorate, Adana.
- Önder S, S. Donmai T.Nagano and B. Özekici, (2004). Irrigation efficiency in selected field plots Under Lower Seyhan Irrigation Project. pp89-92. Proceeding of the International Workshop for the research Project on the Impact of Climate Change on Agricultural Production System (ICCAP). November 2004 Cappadocia, Turkey
- Özekici, B., Donma, S., Önder, S. (2007). Impact of Climate Change on Agricultural Production in Arid Areas (ICCAP): The possible Effect of Climatic Changes on the Irrigated Agriculture of Seyhan Basin. Project Final Report:TOVAG-JPN-08. Adana, Turkey.
- Selek B., Tunçok, İ.K. and Ercan, S. (2008). Evaluation of Seyhan River Basin with Existing and Planned Irrigation Projects. Irrigation-Drainage Conference Proceedings Book, Adana.

Tekinel, O., Benli, B., Çevik, B., Yazar A. and Kanber, R. (1988). Monitoring and Evaluation of Large Irrigation Projects in Turkey. Operating and Maintenance seminars, General Directorate of State Hydraulic Works (Sept., 1988)

[www.turkstat.gov.tr](http://www.turkstat.gov.tr)

[www.un.org](http://www.un.org)

## SATURATED HYDRAULIC CONDUCTIVITY OF ANATOLIAN SOILS

Gülay KARAHAN<sup>1\*</sup>, Sabit ERŞAHİN<sup>2</sup> Ahmet Sami EROL<sup>3</sup>

<sup>1</sup>Cankırı Karatekin University, Faculty of Forestry, Department of Landscape Architecture, Turkey

<sup>2</sup>Cankırı Karatekin University, Faculty of Forestry, Department of Forest Engineering, Cankırı, Turkey

<sup>3</sup>Selcuk University, Cumra Vocation School, Konya, Turkey

\*Corresponding author: gkarahan03@gmail.com

### Abstract

Hydraulic conductivity is an essential base for applied research in soil and water management, landscape, and environmental disciplines. Saturated hydraulic conductivity ( $K_s$ ) is one of the most important soil physical properties, which is considered in planning of irrigation and drainage and predicting other soil hydrological processes. However, it has been frequently reported that measurement of  $K_s$  is laborious, time-consuming, and expensive due to its high spatial variability and this has motivated researchers to develop indirect methods such as pedotransfer functions (PTFs) for developing  $K_s$ -database in regional and national scales. In this study, we reviewed studies for  $K_s$  conducted on Anatolian soils. PTFs were reviewed regarding their type, predictors used, and their performance. The majority of studied PTFs were developed on alluvial, colluvial, and alkaline soils in semi-arid and semi-humid climates. Multiple linear regression, continuous and class PTFs, and neural networks have been common PTFs, and soil texture, bulk density, organic matter content, pH, and EC have been common predictors used with these PTFs. Root mean squared error, mean absolute error, and coefficient of determination were the commonly used criteria used in verification and validation of the PTFs. Studies conducted on  $K_s$  are inadequate and research is still needed to develop an adequate database for nationwide use.

**Keywords:** *Hydraulic conductivity, PTF, Resource management, Turkish soils*

### Introduction

Soil saturated hydraulic conductivity ( $K_s$ ) is a basic characteristic used in modeling of water flow and solute transport in soils. It can be measured directly by field or laboratory methods, however, both of them are time consuming, labor intensive, and expensive processes. In addition, Merdun et al. (2006) noted that the results of direct measurements may not be accurate due to spatial and temporal variability in soil physical and hydraulic properties. Therefore limited conditions led researchers to develop indirect methods using different techniques.

Mathematical models have been developed to predict saturated hydraulic conductivity from easily measurable basic parameters due to the importance of  $K_s$  in hydrologic cycle. There are many studies containing different models and techniques for predicting  $K_s$  from basic soil properties; empirical (Hazen, 1892; Puckett et al., 1985; Nemes et al., 2005; Parasuraman et al., 2006; Ghanbarian-Alavijeh et al., 2010), quasi-physical (Kozeny, 1927; Carman, 1937; Ahuja et al., 1984; 1989; Rawls et al., 1993; Arya et al., 1999; Timlin et al., 1999), physically-based (Katz and Thompson, 1986; Xu and Yu, 2008; Skaggs, 2011; Porter et al., 2013; Hunt et al., 2014; Ghanbarian et al., 2016), and numerical (Zhang et al., 2005; Elliot et al., 2010; Mostaghimi et al., 2013; Ghanbarian and Daigle, 2015; Dal Ferro and Morari, 2015) (Ghanbarian et al., 2016).

According to Pachepsky and Rawls (2004), many models have been developed to quantify  $K_s$ , but pedotransfer functions preferred for  $K_s$  estimation is commonly done using empirical

relationships linking  $K_s$  to soil basic properties such as textural fraction and organic matter content, etc. PTFs are completely empirical model which predict soil properties from easily measured or available datas. In PTFs, basic soil properties are used as input, hydraulic functions are also obtained as output of model (Bouma, 1989). However, literatures in predict of  $K_s$  using PTFs are limited and generally they restricted to assessments at small scales.

There are also many studies about soil saturated hydraulic conductivity and PTFs conducted on Anatolian soils. However, the use of PTFs for  $K_s$  in Turkey is very new and the first study was done in 2004 by Tombul et al. Published PTFs for predicting soil saturated hydraulic conductivity are very inadequate. Candemir and Gülser (2012) also noted that there are limited studies related to prediction of saturated hydraulic conductivity of fine-textured, especially alkaline soils.

The aim of this study is encourage to researchers for new researches by giving information about PTF studies conducted on Anatolian soils. We evaluated the performance of ten published PTFs between 2004 and 2016 in predicting the soil saturated hydraulic conductivity for Anatolian soils.

### **Material and Methods**

In totally, 887 soil samples were used in studies conducted on ten different regions of Anatolia in Turkey between 2004 and 2016. Although the studied regions represent to different climatic and soil characteristics, there is not enough PTF studies for Anatolian soils as seen from the map (Fig.1). A summary of the soil datasets used in this paper were given on Table (1).

Soil samples were taken from different depths (0-15, 0-20, 15-30, 30-60, and 60-90 cm). Using predictive input datas consisting of soil texture (PSD), bulk density (BD), organic matter content (OM), soil pH, electrical conductivity (EC), field capacity (FC), permanent wilting point (PWP), cation exchange capacity (CEC), volumetric moisture content (VMC), soil moisture content (SMC), sodium absorption ratio (SAR), exchangeable Na percentage (ESP), specific surface area (SSA), aggregate stability index (ASI), penetration resistance (PR), calcium carbonate ( $\text{CaCO}_3$ ), soil color, soil depth, and soil morphological properties such as coefficient of linear extensibility (COLE), structure class (SC), structure type (ST), structure size (SS), pore size (PS), pore quantity (PQ), root size (RS), root quantity (RQ), mottles quantity (MQ), soil plasticity, and stickiness. The studied regions have alluvial, colluvial, and alkaline soils and semi-arid and semi-humid climates.

Pedotransfer functions used in this study were developed using various techniques for predict the  $K_s$  from other soil parameters; multiple linear regression (Merdun et al., 2006; Öztekin et al., 2007; Candemir and Gülser, 2012; Yakupoğlu et al., 2013; Gülser and Candemir, 2014; Karahan and Erşahin, 2016), artificial neural networks, ANN (Merdun et al., 2006; Haghverdi et al., 2014), support vector machines (Haghverdi et al., 2014), Rosetta (Tombul et al., 2004; Haghverdi et al., 2010), and continuous and class PTFs (Mihalikova et al., 2015).

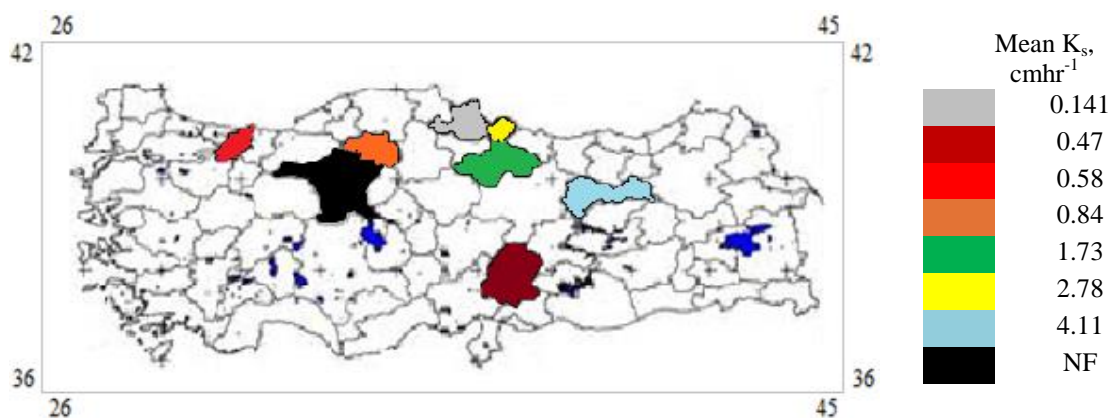


Figure 1. Soil sampling areas of assessed PTFs studies (NF: Not found)

Table 1. Description of datasets used for predicting of  $K_s$

Dataset	Location	Samples	Soil properties	Predictors
P1 Tombul et al. 2004	Kurukavak Subbasin in Sakarya Basin	Sandy loam (46) Loam (29) Sandy clay loam (51)	Alluvial	PSD, BD, OM
P2 Merdun et al. 2006	Erzincan Plain	195 cores samples (0.2 m length and 0.048 m diameter) 0–30, 30–60, 60–90 cm Medium texture, silt content (0.447)	Alluvial	PSD, BD, PS
P3 Öztekin et al. 2007	Yesilirmak Valley	From 5 profiles 19 horizons, undisturbed soil cores (7.6 cm diameter and 7.6 cm height)	Alluvial over lacustrine materials	PSD, BD, OM, CEC, pH, VMC
P4 Haghverdi et al. 2010	Different parts of Turkey	91 undisturbed soil cores (0-30 cm depth) Sand (% 31.9) Silt (% 28.6) Clay (% 39.5) OM (% 1.16) BD (% 1.19)	NF	PSD, BD, OM
P5 Candemir and Gülser, 2012	Bafra Delta Plain	76 disturbed soil samples from cultivated lands (0-20 cm depth) mostly fine-textured clay (76%) clay loam (24%)	14% slightly 66% moderate 20% strongly alkaline	SAR, ESP
P6 Yakupoğlu et al. 2013	Kahramanmaraş Narlı Plain	25 disturbed samples (0-15 cm depth) (5.5 cm diameter and 5.0 cm height) Mostly silty soil Mean 487 g kg <sup>-1</sup>	Alluvial Fluvaquents Xerofluvents	PSD, CEC, pH, FC, PWP
P7 Haghverdi et al. 2014	Ankara City	135 disturbed and undisturbed (100 cm <sup>3</sup> ) samples (0–30 cm depth)	Fine-coarse textured soils	PSD, BD, pH, FC, PWP, EC, SMC
P8 Gülser and Candemir, 2014	Çarşamba and Bafra Plains	30 samples (0- 20 cm depth)	Alluvial Colluvial	PSD, BD, OM
P9 Mihalikova et al. 2015	Büyükçay Watershed of Cankırı	84 samples fine textural class slightly acid slightly alkaline	Entisols Inceptisols	PSD, OM, pH, FC, PWP, EC, SD, Depth

P10 Karahan and Erşahin, 2016	Cankırı City	60 samples (0-15 cm ) 60 samples (15-30 cm) paddy field, grassland	Gypsic Ustorthends	PSD, BD, OM, pH, FC, WP, EC, CEC, SSA, ASI, PR, CaCO <sub>3</sub> , Color, COLE, SC, SS, ST, PS, PQ, RS, RQ, MQ, Plasticity, Stickiness,
----------------------------------	--------------	--	-----------------------	--

P: Paper, PSD: Particle size distribution, BD: Bulk density, PS: Pore size, OM:Organic matter, CEC: Cation exchange capacity, VMC: Volumetric moisture content, SMC: Soil moisture content, SAR: Sodium absorption ratio, ESP: Exchangeable Na percentage, FC: Field capacity, PWP:Permenant wilting point, SD: Saturation degree, SSA: Specific surface area, ASI: Agregatte stability index, PR: Penetration resistance, CaCO<sub>3</sub>: Calcium carbonate, COLE: Coefficient of linear extensibility, SC: Structure class, ST: Structure type, SS: Structure size, RS: Root size, RQ:Root quantity, MQ: Mottles quantity, NF: Not found

The goodness of fit of PTFs was evaluated according to model criterias Table (2).

Table 2. The list of datasets and PTFs properties on the prediction set

	Dataset	PTF type	Model criteria	Performance %			
P1	NF	Rosetta	RMSE	0.051-0.088			
P2	130 samples for development 65 samples for validation	Multiple-linear regression	RMSE	0.013-0.938			
		ANN	R <sup>2</sup>	0.637- <b>0.979</b>			
			RMSE	0.020-3.511			
P3	Suctions of 330-cm (FC), 15000-cm (PWP)	Multiple-linear regression	R <sup>2</sup>	0.510-0.860			
			MRE	-1.553			
			ARPE	57.71%			
P4	91 undisturbed soils 70% samples for development 30% samples for test	Jabro PTF Puckett PTF Neurotheta PTF Rosetta PTF Turkey PTF	RMSE	MBE    r			
			1.29	0.32    0.31			
			2.80	2.63    0.50			
			1.63	1.39    0.48			
			1.61	1.23    0.13			
0.74	0.11    0.69						
P5	76 randomly sampling	Multiple-linear regression Three groups of PTF models 1) physical or chemical properties 2) physical and chemical properties in the first order 3) physical and chemical properties in the second order	RMSE	0.059-0.114			
			R <sup>2</sup>	0.273-0.804			
P6	25 disturbed samples	Multiple-linear regression	R <sup>2</sup>	0.846			
P7	cross-validation technique  65% for training 15% samples for cross-validation 20% samples for performance	SVM	RMSE	0.054			
			r	0.87			
			MBE	-0.011			
P8	NF	Multiple-linear regression	r	0.955			
			P9	k-NN method 66 samples for estimation 18 samples for reliability	Continuous PTF	R <sup>2</sup>	0.922
					Class PTF	MAE	2.72
			MSE	10.11			
P10	80 samples for training 40 samples for validation	Multiple-linear regression	R <sup>2</sup>	<b>0.95</b>			
			ME	0.0042			
			RMSE	0.203			
			MAE	1.145			

P: Paper, FC: Field capacity, PWP: Permenant wilting point, ANN: Artificial neural networks, SVM: Support vector machine,

ME: Mean error, MAE: Mean absolute error, MBE: Mean bias error, MSE: Mean squared error, MRE: Mean residual error, ARPE: Average relative percent error, kNN: k-nearest neighbour technique, NF: Not found

## **Results and Discussion**

In published PTFs, generally multiple-linear regression (MLR), Artificial neural networks (ANN), Support vector machine (SVM), Continuous and Class PTF, and Rosetta used for PTF type and determination coefficient ( $R^2$ ), root mean square error (RMSE), mean absolute error (MAE), mean error (ME), mean absolute error (MAE), mean bias error (MBE), mean squared error (MSE), mean residual error (MRE), and average relative percent error (ARPE) were used for model performance.

We evaluated performance of models according to  $R^2$  and RMSE model criterias. In these studies, MRL was used for predicting the saturated hydraulic conductivity in 5 of ten papers (Table 2). The highest values of  $R^2$  (0.97 and 0.95) were found in Merdun et al. (2006) and Karahan and Erşahin (2016), respectively. The highest determination coefficient values for estimating  $K_s$  were found for medium and clay soil texture classes. ANN was used for predicting the saturated hydraulic conductivity in 2 of ten papers (Table 2). The values of  $R^2$  (0.95 and 0.82) and RMSE (0.020 and 0.047) were found in Merdun et al. (2006) and Haghverdi et al. (2014), respectively. SVM was used for predicting the saturated hydraulic conductivity in 1 of ten papers. The values of  $R^2$  (0.75) and RMSE (0.054) were found in Haghverdi et al. (2014). Rosetta was used in 2 of ten papers. The values of  $R^2$  (NF and 0.75) and RMSE (0.051 and 1.61) were found in Tombul et al. (2014) and Haghverdi et al. (2010) respectively. Class and Continuous PTFs were used for predicting the saturated hydraulic conductivity in 1 of ten papers. The values of  $R^2$  (0.92) and MSE (71.56) were found in Mihalikova et al. (2015) (Table 2).

In  $K_s$  modeling studies, soil parametric variables are generally preferred. However, it's well known that a slight change in soil structure has a considerable impact on  $K_s$  since  $K_s$  is strongly controlled by soil pores and their geometry and their orientations in soils (Karahan and Erşahin, 2016). Their results were highly promising, suggesting that soil morphological properties can be used besides soil parametric variables in  $K_s$  modeling studies. Pore size distribution and bulk density, which are the most common parametric variables in PTFs, have been also the most used input data in these evaluated studies. Except from other physical and chemical properties, Merdun (2006) and Karahan and Erşahin (2016) are the first and only studies which used soil morphological properties as input data of model (only PS and SS, SQ, ST, PS, PQ, RS, RQ, MQ, COLE, plasticity, and stickiness, respectively) (Table 1). The success of the models can be attributed to effect of these variables on  $K_s$ .

For paper ten, the best model performance occurred with the multiple linear regression ( $R^2$ : 0.97 and 0.95). Published PTFs based on MLR gave better prediction than SVM and Rosetta in these papers. Even though the performance of SVM is slightly worse than that of MRL and ANN. There are a number of studies which compared the performance of PTFs types. Merdun et al. (2006), Fereshte (2014) noted that MRL showed better performance than ANN.

PTFs have some limitations which effect the it's performance. Schaap and Leij (1998a) noted that PTFs were used due to its simplicity and successful results although they have some limitations. Therefore, train (develop) and test (validate) datas should be determined correctly as well as soil sampling for the performance of pedotransfer functions (Schaap and Leij, 1998a). Moreover, the number of soil samples should be sufficient and choosing more input variables to correctly represent the field. However, estimating soil properties were restricted to 2-3 soil input properties in evaluated published papers (Tombul et al. 2004; Merdun et al. 2006; Haghverdi et al. 2010; Candemir and Gülser, 2012; Gülser and Candemir, 2014) whereas more soil properties use as input variables will improve the model result. In addition, it is mentioned that some factors such as vegetation, climate, and geograpy effect soils types and properties and the performance of PTFs studies. Because, recent studies in PTF should be



focus on the development of better functions to predict soil hydraulic properties for different geographical areas or soil types and determination of the most important basic soil properties as input (Pachepsky and Rawls, 1999). Cemek et al. (2015) also noted that PTF can not perform very well in predicting soil moisture because every PTF is not suitable for all soil types.

### **Conclusions**

In this study, we evaluated ten papers available in the literature to estimate soil saturated hydraulic conductivity ( $K_s$ ) using PTFs. The published PTFs are inadequate for prediction and determination of  $K_s$  for Anatolian soils. It is not correct to evaluate the success of the PTFs with few samples. Even though the study was carried out on the 10 published papers about saturated hydraulic conductivity of Anatolian soils, this study is important with regard to effect of morphological properties on saturated hydraulic conductivity. Soil morphological properties in addition to physical and chemical properties as input data for predict to  $K_s$  can improve the model performance. Therefore, future work must be testing PTF's performance by adding soil morphological properties and these studies should be increased for obtain a nationwide  $K_s$  database on Anatolian soils. In addition, the PTFs have some problems in some conditions. Overall, applying same PTF under different conditions regions is not correct and does not give reliable results. Therefore, for saving time and labour, and practical for larger scale applications, studies of PTFs should motivate researchers to work on it further. So that estimate saturated hydraulic conductivity using PTFs can be possible with a large database that consists of various soil samples from all around the Anatolia. Because it have not been done so far.

### **References**

- Cemek B., Arslan H., Güler, M., Küçüktopçu, E. (2015). Estimation of Field capacity and permanent wilting point using artificial neural network. 2<sup>nd</sup> International Conference on Sustainable Agriculture and Environment. September 30-October 3, Konya, Turkey.
- Ghanbarian B., Taslimitehrani V., Pachepsky Y.A. (2016). Scale-Dependent Pedotransfer Functions Reliability for Estimating Saturated Hydraulic Conductivity. *Catena*. 10.015.
- Öztekın T., Cemek B., Brown L.C. (2007). Pedotransfer Functions for the Hydraulic Properties of Layered Soils. *GOÜ. Ziraat Fakültesi Dergisi*, 2007, 24 (2), 77-86
- Candemir F., Gülser C. (2012). Influencing Factors and Prediction of Hydraulic Conductivity in Fine-Textured Alkaline Soils, *Arid Land Research and Management*, 26:1,15-31.
- Gülser C., Candemir F. (2014). Using soil moisture constants and physical properties to predict saturated hydraulic conductivity. *Eurasian Journal of Soil Sc (EJSS)*, 3(1), 77-81.
- Haghverdi A., Öztürk H.S., Ghodsi S., Tunçay T. (2012). Estimating saturated hydraulic conductivity using different well-known pedotransfer functions. *Wagenin.*, 1-4 May 2012.
- Haghverdi A., Öztürk H.S., Cornelis W.M. (2014). Revisiting the pseudo continuous pedotransfer function concept: Impact of data quality and data mining meth. *Geoderma*, 226, 31-38.
- Karahan G., Erşahin S. (2016). Predicting saturated hydraulic conductivity using soil morphological properties. *Eurasian J Soil Sci* 2016, 5 (1) 30 – 38.
- Merdun H., Çınar Ö., Meral R., Apan M. (2006). Comparison of artificial neural network and regression pedotransfer functions for prediction of soil water retention and saturated hydraulic conductivity. *Soil and Tillage Research*, 90(1), 108-116.

- Miháliková M., Başkan O., Dengiz O. (2015). Capability of different interpolation models and pedotransfer functions to estimate soil hydraulic properties in Buyukcay Watershed. *Environ Earth Sci* (2015) 74:2425-243.
- Pachepsky Y.A., Rawls W.J. (1999). Accuracy and reliability of pedotransfer functions as affected by grouping soils. *Soil Sci. Soc. Am. J.* 63, 1748–1757.
- Pachepsky Y.A., Rawls W.J. (2004). *Development of Pedotransfer Functions in Soil Hydrology*. Elsevier, Amsterdam.
- Schaap M. G., Leij F. J.(1998a). Database-related accuracy and uncertainty of pedotransfer functions. *Soil Science*, 163(10), 765-779.
- Yakupoğlu T., Şişman A. Ö., Karagöktaş M., Demir Ö. F. (2013). Predicting of Saturated Hydraulic Conductivity Values of Soils with Pedotransfer Functions. *SDU Journal of the Faculty of Agriculture* 8(1).
- Tombul M., Akyürek Z., Sorman A. Ü. (2004). Research Note: Determination of soil hydraulic properties using pedotransfer functions in a semi-arid basin, Turkey. *Hydrology and Earth System Sciences Discussions*, 8(6), 1200-1209.

## THE EFFECT OF SALINITY ON SEED GERMINATION PERFORMANCE OF TEDERA

Gülcan KAYMAK\*, Zeki ACAR

OMU Agricultural Faculty, Atakum, Samsun Turkey  
\*Corresponding author: gulcankaymak92@gmail.com

### Abstract

This study was carried out to determine the effect of different salt concentrations on seed germination performance of 85 different Tedera genotypes with 4 replicates at seed Laboratory of Agronomy Department in Ondokuz Mayıs University, Samsun, Turkey. In study, five different salt concentrations (0 (Control), 25, 50, 75, 100 mM) were used. For germination tests the seeds put inside petri dishes and process were performed at a fully controlled climatic chamber with a constant temperature (24°C) and 60% aerial relative humidity. In control test, the seeds achieved full germination level in 11 days but as salt concentration increase, germination period was also increased up to 30 days for 100 mM concentration. Increasing salt concentration affected on negatively germination ratio, seedling and root weights and seedling length. For example, while germination ratio was about 48.77% for control, it was decreased to 11.37% for 100 mM dose. Decreasing rate was 76.69%. The least decrease was observed for fresh seedling rate against to increasing NaCl doses. Decreasing rate were 42.86%, 82.49% and 81.70% for fresh seedling weight, root length and shoot length, respectively at 100 mM dose.

**Key words:** *Tedera*, *Salt Tolerance*, *Germination*, *Seed*

### Introduction

In order to plants grow normally enough moisture must be found in soil. If moisture content of soil would decline in root zone plant water consuming level is decrease. Another factor that is affect water consuming level is salinity. In the soil, when underground water rise to surface and moisture evaporate to atmosphere and salt particles stay on surface in arid and semiarid regions, thus salinity is occur (Kwiatowsky, 1998; Kara, 2002). In these regions, salt particles could not transport to depth levels of soil because of less precipitation and high evaporation in arid and semiarid regions (Saruhan *et al.*, 2008). Regard the salinity, there would be important differences amongst the families, genus and species, furthermore the cultivars in the same species were effected differently from salinity. Though, plants are effected from salinity throughout the whole growing stages, the most susceptible phase is germination period (Khan *et al.*, 2010; Kusvuran *et al.*, 2007; Zamani *et al.*, 2010). Salt affect germination process negatively by increasing osmotic pressure of soil moisture, in addition Na<sup>+</sup> and Cl<sup>-</sup> ions cause toxic effect on germinating seeds (Mohammadi, 2009). *Bituminaria bituminosa* is naturally grows in our region. It is an important natural feed source for livestock, because of its adaptation to marginal lands and keeps the greenery throughout the year. Even if depends on the genotypes, *Bituminaria bituminosa* plants have a level tolerance to saltiness. Aim of this study is to determine saltiness tolerance level of *Bituminaria bituminosa* genotypes in seed germination stage.

## Material and Methods

This study was carried out in seed Laboratory of OMU Agricultural Faculty with using the seeds of 85 *Bituminaria bituminosa* genotypes collected from Central Black Sea Region of Turkey in 2017. The seeds scarified with sandpaper in order to ease water absorption and germination. Seeds were germinated in five different NaCl solutions as 0 (Control), 25, 50, 75 and 100 mM with 4 replications. 20-seed placed between blotting paper in petri dishes and watered with 10 ml solution for each genotype and each dose. Blotting papers changed every two days and watered again with 10 ml solution. All process was conducted inside a germination chamber fixed at 24°C and 60% humidity. After process completed germination ratio, seedling weight, root and stem length was determined. Germination process lasted 30 days for 100 mM dose while it was 12 days for control dose, because salinity was slow down germination (Day *et al.*, 2008). Identifying statistical analysis was applied to data as considered average of genotypes by using SPSS 17.0 software program.

## Results and Discussion

Regard the germination ratio, seedling weight, root and shoot length, wide range variations were determined amongst the *Bituminaria bituminosa* genotypes (Table 1). Average germination ratio was 48.77% for Control, but this value decreased linearly as salt concentration increase and it declined to 11.37% at 100 mM NaCl dose. In other word, declining rate of germination ratio reached to 76.69% for 100 mM NaCl dose (Table 1; Figure 1). Though *Bituminaria bituminosa* plants have limited tolerance to salinity and mineral compiling, level of tolerance is depends on genotype and environmental conditions (Walker and Bernal, 2007). On the other hand, probably increasing salinity doses would be prevented water absorption and made toxic effects to seeds and decreased germination. In order to start metabolic activity inside the seed, firstly it has to absorb some moisture. Additionally, salt stress prevents synthesis of gibberellin (Bozcuk, 1991) and it causes decrease of a amylase activity (Adda *et al.*, 2014) during germination process. Thus, degradation of carbohydrates is decrease and in the result germination process is slow down.

Fresh seedling weight was decrease as NaCl doses increased. While fresh seedling weight was 0.21 g at Control, it was decreased to 0.12 g at 100 mM NaCl dose (Table 1 and Figure2). When we assumed fresh seedling weight as 100% at Control, it was decrease to 42.86% at 100 mM NaCl dose. But decreasing rate was less compare to the other investigated traits. Despite Na<sup>+</sup> and Cl<sup>-</sup> are necessary minerals for plants, they cause toxic effect in high levels (Kacar *et al.*, 2009).

Root and shoot lengths are most important parameters to determine the effect of salt stress. Because roots absorb the moisture and shoots transmit water to necessary organs. For this reason, root and shoot lengths show reactions of plants against to salt stress (Bahrani and Hagh Joo, 2012). Consider root length of *Bituminaria bituminosa* genotypes, the value was altered from 0 to 8.30 cm while average root length was 2.17 cm for Control, it decreased to 0.38 cm for 100 mM NaCl dose and declining ratio was 82.49 % (Table 1 and Figure 3). Under stress conditions, plants synthesis abscisic acid, ethylene and brassinosteroids. Those chemicals stimulate root elongation at low doses, but decelerate in higher dose (Julkowska *et al.*, 2014).

Table1. Identifying statistic values of *Bituminaria bituminosa* genotypes in terms of germination ratio, seedling weight, root and shoot length

Traits	Statistics	0 mM NaCl	25 mM NaCl	50 mM NaCl	75 mM NaCl	100 mM NaCl
<b>Germination ratio (%)</b>	Average	48,77	46,99	31,18	26,67	11,37
	Declining rate (%)	-	3,65	36,07	45,31	76,69
	Standard error	1,84	1,54	1,32	1,38	1,13
	Minimum	6,67	0	0	0	0
	Maximum	100	100	100	100	53,33
<b>Fresh seedling weight (g)</b>	Average	0,21	0,2	0,18	0,15	0,12
	Declining rate (%)	-	4,76	14,29	28,57	42,86
	Standard error	0,003	0,004	0,005	0,005	0,012
	Minimum	0,08	0	0,05	0,1	0
	Maximum	0,53	0,52	0,52	0,51	0,47
<b>Root length (cm)</b>	<i>Average</i>	<i>2,17</i>	<i>1,85</i>	<i>1,39</i>	<i>1,1</i>	<i>0,38</i>
	Declining rate (%)	-	14,75	35,94	49,31	82,49
	Standard error	0,08	0,08	0,06	0,06	0,11
	Minimum	0,2	0,1	0	0	0
	Maximum	5,1	8,3	4	4,1	4,5
<b>Shoot length (cm)</b>	Average	4,59	3,99	2,19	1,73	0,84
	Declining rate (%)	-	13,07	52,29	62,31	81,70
	Standard error	0,12	0,09	0,05	0,05	0,05
	Minimum	1,8	1,1	0,9	0	0
	Maximum	7,57	11,2	4,9	4,5	4,2

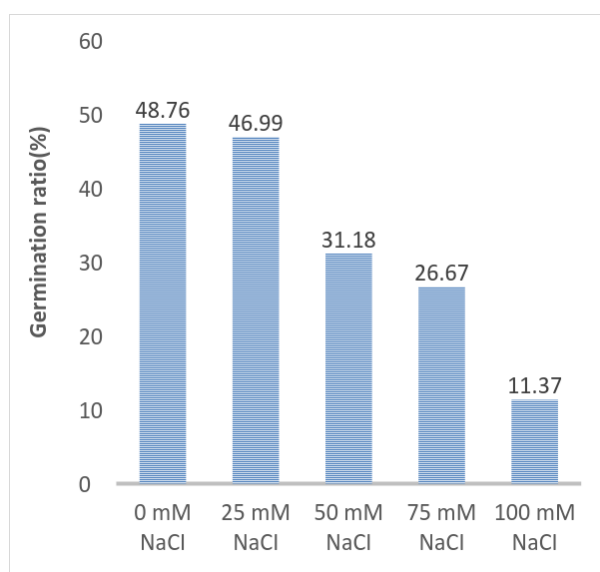


Figure 1. Effect of salt concentrations on germination ratio

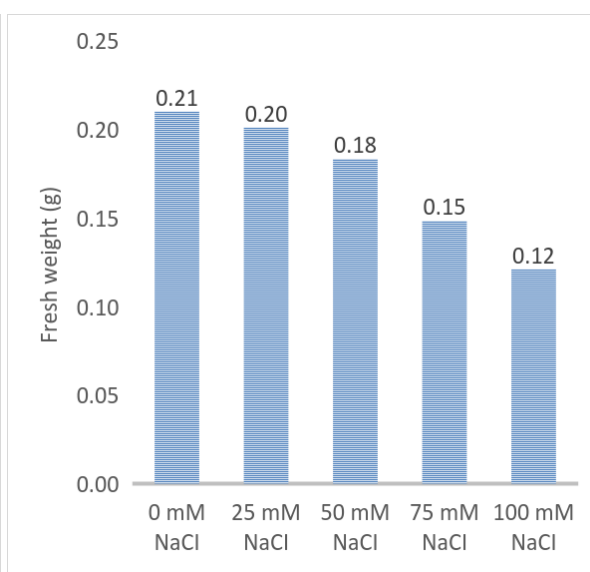


Figure 2. Effect of salt concentrations on fresh seedling weight

Effect of NaCl concentrations on shoot length was similar to effects on root length. Average shoot length was determined as 4.59 cm for Control, but it was decreased to 0.84 cm for 100 mM NaCl dose. In other word, average shoot length was decrease about 81.70% at the highest dose (Table 1 and Figure 4).

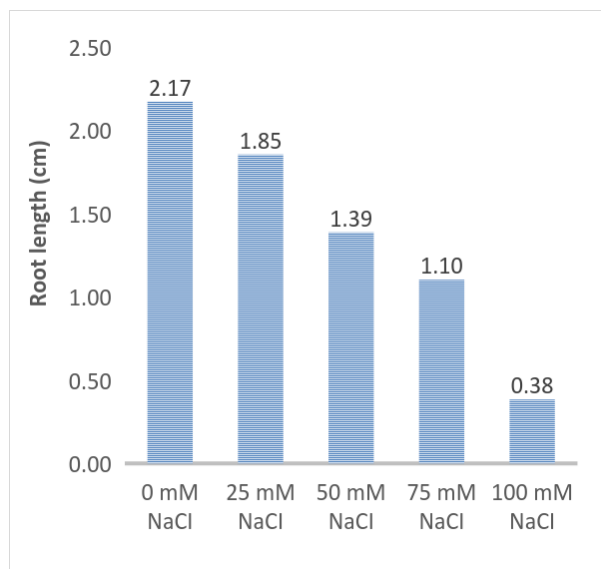


Figure 3. Effect of salt concentrations on root length

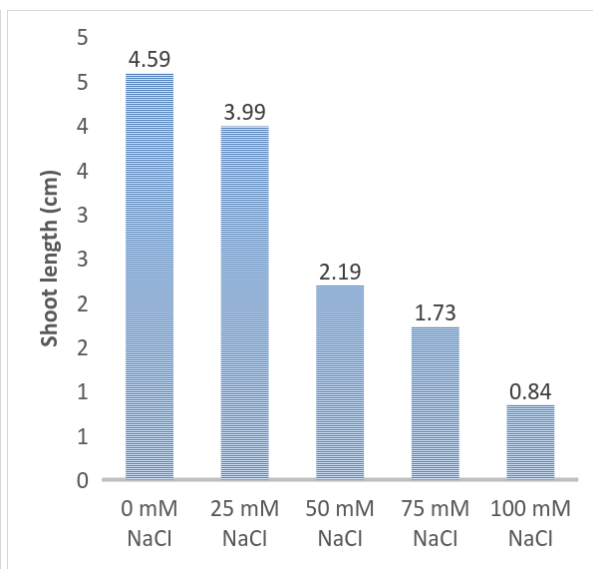


Figure 4. Effect of salt concentrations on shoot length

### Conclusion

All of the investigated traits were affected negatively from increasing NaCl concentrations. The least effected characteristic was fresh seedling weight. Compare to Control, decreasing rate of fresh seedling weight for 100 mM NaCl dose was 42.86%. The same value was more than 76% for the other traits. But there were wide range of variation amongst the *Bituminaria bituminosa* genotypes for all investigated characteristics.

### Acknowledgement

Thanks to Ondokuz Mayıs University Project Management Office because of financially support the Project (Grant No: PYO.ZRT.1904.16.004).

### References

- Adda, A., Regagba, Z., Latigui, A., Merah, O., 2014. Effect of salt stress on  $\alpha$ -amylase activity, sugars mobilization and osmotic potential of *Phaseolus vulgaris* L. seeds var. 'Cocorose' and 'Djadida' during germination. *Journal of Biological Sciences*, 14: 370-375.
- Bahrani, A. and M. Hagh Joo. 2012. Response of Some Wheat (*Triticum aestivum* L.) Genotypes to Salinity at Germination and Early Seedling Growth Stages *World Applied Sciences Journal* 16 (4): 599-609.
- Bozcuk, S., 1991. The effect of salinity on germination and the determination of the salt tolerance limit in some cultivated plants. *Natural Turk Journal of Biology*, 15(2), 144-151.

- Day, S., Kaya, M. D. ve Kolsarıcı, Ö. 2008. The effects of NaCl concentrations on the germination of some confectionery sunflower genotypes. Tarım Bilimleri Dergisi- Journal of Agricultural Sciences, Ankara Üniv. Ziraat Fak. 14 (3): 230-236.
- Julkowska , M.M., Hoefsloot, H.C.J., Mol, S., Feron, R., Boer, G-J de, Haring, M.A., Testerink, C., 2014. Capturing Arabidopsis root architecture dynamics with ROOT-FIT reveals diversity in responses to salinity. (Web page: <http://www.plantphysiol.org/content/early/2014/09/30/pp.114.248963.full.pdf> (Date accessed: April13, 2015).
- Kacar, B., Katkat, V., Öztürk, Ş., 2009. Bitki Fizyolojisi-Plant Physiology (3. Baskı). Nobel Yayınları No: 848. Ankara, 556 s.
- Kara, T., 2002. Irrigation Scheduling to Present Soil Salinization from a Shallow Water Table, Acta Horticulture, Number 573, pp. 139-151.
- Khan M A, Ungar I A & Showalter A M (2000). Effect of sodium chloride treatments on growth and ion accumulation of the halophyte *Haloxylon recurvum*. Communications in Soil Science and Plant Analysis 31(17-18): 2763-2774.
- Kuşvuran Ş, Ellialtıoğlu Ş, Abak K & Yaşar F (2007). The reactivity of some melon genotypes to salt stress. Tarım Bilimleri Dergisi- Journal of Agricultural Sciences 13(4): 39-404.
- Kwiatowsky, J., 1998. Salinity Classification, Mapping and Managment in Alberta.
- Mohammadi G R (2009). The influence of NaCl priming on seed germination and seedling growth of canola (*Brassica napus L.*) under salinity conditions. American-Eurasian Journal Agriculture & Environment Science 5(5): 696-700.
- Saruhan, V., Üzen, N., Eylen, M., Çetin, Ö., 2008. Effects of soil salinity on cultivated plants and concrete examples. İklim Değişikliği Sempozyumu, 13-14 Mart, Ankara.
- Walker, D.J., Bernal, M.P., 2007. The Influence of Heavy Metals and Mineral Nutrient Supply on *Bituminaria bituminosa*. Water Air Soil Pollut (2007) 184:335–345
- Zamani S, Nezami M T, Habibi D & Khorshidi M B (2010). Effect of quantitative and qualitative performance of four canola cultivars (*Brassica napus L.*) to salinity conditions. Advances in Environmental Biology 4(3): 422-427.

## THE EFFECTS OF CUTTING FREQUENCY ON BOTANICAL AND QUALITY TRAITS OF A LOWLAND PASTURE

Çaglayan CANDAN, Ilknur AYAN\*, Mehmet CAN, Zeki ACAR

Ondokuz Mayıs University, Agricultural Faculty, Department of Agronomy, Samsun, Turkey

\*Corresponding author: ilknuray@omu.edu.tr

### Abstract

This study was conducted to determine the effects of different cutting frequency on forage yield and botanical composition of a lowland natural range in Engiz Village of Ondokuz Mayıs County of Samsun Province during 2013 and 2014 spring growing periods. The experiment was established according to randomized block design with four replicates. Total hay yield was ranged from 1460.9 to 2741.9 and from 1009.5 to 3410.5 kg ha<sup>-1</sup> in 2013 and 2014, respectively. The ratios of grasses, legumes and the other species in botanical composition ranged between 31.24-57.19, 20.77-42.79 and 8.75-47.13%, respectively. Crude protein ratios of hay were determined as 11.62-20.27% for grasses, 17.44-26.32% for legumes and 18.06-24.31% for the other species. While ADF ratios ranged between 28.38-38.27% for grasses, 22.54-34.67% for legumes and 23.48-32.33% for the other species; NDF ratios were determined between 46.61-60.27% for grasses, 35.19-46.68% for legumes and 38.49-52.64% for the other species. While phosphorus content of hay was adequate, potassium, calcium and magnesium was high. K/Ca+Mg and Ca/P ratios ranged between 0.82-2.76 and 1.98-8.60, respectively. In the light of the results obtained from this study, the pasture should be grazed concerning appropriate animal density; otherwise the weeds could increase at the low density grazing conditions. In order to sustain pasture yield, suitable range management program should be prepared and applied.

**Keywords:** *Cutting frequency; hay yield; botanical composition; mineral contents.*

### Introduction

One of the most important problems to be solved in the development of Turkey animal breeding quality is the regular fulfilling of cheap and plentiful roughage needs. In addition to compliance with the animal feed physiology of forage due to its quality and low price, the usage of more expensive and intensive or concentrated feed used in the human diet has been reduced in animal nutrition. The low price of roughage such as hay, green and silo forage increases the [profitability](#) of animal breeding firms (Buyukburc, 1999). Considering the dynamic nature of natural pastures in Turkey, to determine the time-dependent changes in the quality and quantity is essential. In addition, regard the balance between livestock feeding and pasture management, to determine the amount of forage, botanical composition and yield of the pasture is really important (Gokkus and Koc, 2001; Holechek *et al.*,1995; Vallentine 1990). The main aim of this study was to determine the time-dependent changes in quality and quantity of hay meadows by considering the dynamic nature of the Black Sea lowland pastures and animal interactions. It was also aimed to determine the yield and botanical composition of the grass consumed by the animals simultaneously.



## **Material and Methods**

This study was conducted at Engiz Village of Ondokuzmayis town of Samsun Province during 2013 and 2014. The soil properties of the experimental area show clay structure when examined in texture. High organic matter content (5.16%), very low nitrogen content, low phosphorus (1.846 ppm), and moderate lime (1.19%) and salt (560.3  $\mu\text{mhos/cm}$ ) content was determined. Pasture soil was also slightly alkaline with pH 7.8. The average temperature of Samsun was 13.9<sup>0</sup>C in long-time period, while in 2013 and 2014 it was measured as 14.7<sup>0</sup>C and 15.9<sup>0</sup>C, respectively. For many years, the total annual rainfall of Samsun was 707.0 mm as the average while in 2013 and 2014, this value was determined to be 515.9 and 525.0 mm, respectively. The experiment was established according to randomized block design with four replicates. The applied different cutting frequencies were; each week cutting, cutting biweekly, cutting triweekly, cutting four weeks, cutting five weeks, cutting six weeks, cutting seven weeks and cutting by changing location every week. Only one cage has been placed in every parcel of the study area. In all harvests two 0.21 m<sup>2</sup> areas were cut, after plants were sorted according to family and they were dried at 60<sup>0</sup>C until constant weight and ground to pass through 1 mm screen. Chemical characters; dry matter, crude protein, ADF, NDF, Ca, Mg, K, P content of samples were determined by using Near Infrared Reflectance Spectroscopy (NIRS, “Foss 6500”) with software package program “IC-0904F”. Statistical analysis was performed with SPSS 17.0 program.

## **Results and Discussion**

The data obtained in 2013 and 2014 showed that there was statistically significant difference between cutting frequencies in terms of grasses, other species and total of hay yields ( $p \leq 0.01$ ), while no statistically significant difference was observed in terms of legume yield. In 2013 the highest grass yield was obtained from cutting every seven week (1134.6 kg ha<sup>-1</sup>), and the least was obtained with cutting triweekly (497.6 kg ha<sup>-1</sup>); while in 2014 the highest yield was in plots cutting every week by changing place of cages (Figure 1).

The legume yield in different years was not statistically different. The legume yields were range between 471.2 kg ha<sup>-1</sup> (cutting biweekly) and 892.7 kg ha<sup>-1</sup> (cutting by changing location every week) in 2013 and 788.5 kg ha<sup>-1</sup> (cutting by changing location every week) and 425.4 kg ha<sup>-1</sup> (each week cutting) in 2014. (Figure 2). The highest yield of other species was obtained with cutting by changing location every week, 830.7 kg ha<sup>-1</sup> and 1081.4 kg ha<sup>-1</sup> in 2013 and 2014, respectively. (Figure 3). The highest yield for plants from the other families is taken from cutting which is made by changing the places of the cages every week as 830.7 kg ha<sup>-1</sup> in 2013 year, is taken from cutting which is made by changing the places of the cages every week as 1081.4 kg ha<sup>-1</sup> in 2014 year (Figure 3). According to whole hay yield, when we evaluate botanical composition rates for treatments in 2013, it was seen that in treatments number 1,2,6,7 and 8 grasses, in treatments number 3, 4 and 5 legumes have the highest rates. The highest hay yield was obtained from number 8 treatment the spots of the cages and cut (every week) as 3411 kg ha<sup>-1</sup> in 2014. Operation number 1 follows treatment number 8 which includes reaping every week but fixing the places of cages (2121.6 kg ha<sup>-1</sup>) and the lowest hay yield was taken from the operation number 4 with 1010 kg / ha<sup>-1</sup>. According to participation to botanical composition for whole hay yield, in treatments number 3,5,7 and 8 grasses, in treatments number 4 and 6 legumes and in treatments 1 and 2 plants from the other species rank in the front (Figure 4).

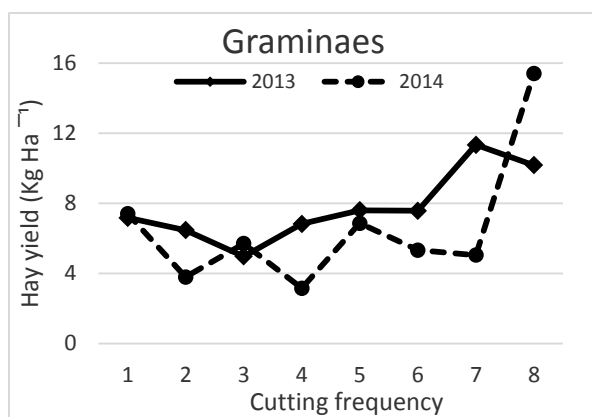


Figure 1. Grasses hay yield in lowland natural range

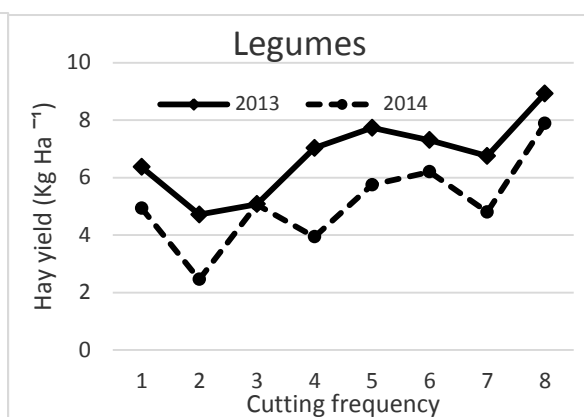


Figure 2. Legumes hay yield in lowland natural range

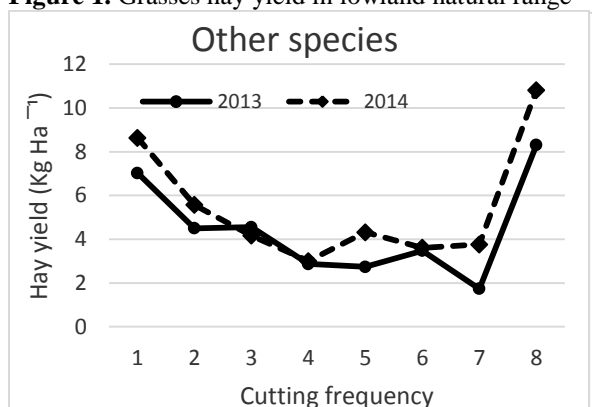


Figure 3. Other species hay yield lowland natural range

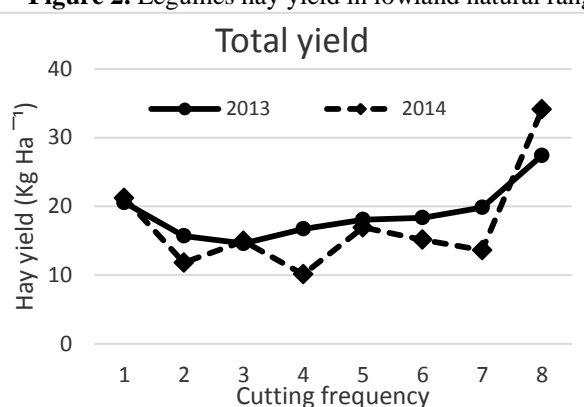


Figure 4. Total hay yield lowland natural range

In Turkey, because of grasslands are rich for grasses (Erkovan *et al.* 2003, Terzioğlu and Yalvaç, 2004, Türker, 2006, Şen and Hatipoğlu, 2010, Nadir *et al.* 2012) it was determined that grasses ratio was over 30% at whole plots. According to applied different reaping frequencies at a base grassland; determinations of the ratios of raw protein, ADF, NDF, Ca, Mg, K, P, K/(Ca+Mg) and Ca/P for grasses, legumes and other species in year 2013-2014 are shown at Table 1. The crude protein ratios determined according to 2013 year reports are changed between 11.62-20.27% for grasses, 17.44-26.32% for legumes, 18.06-24.3% for other species; according to 2014 year reports 14.43-20.14% for grasses, 18.84-25.11% for legumes, 16.46-23.23% for other species (Table 1). Ratios of crude protein determined in this study are same as the results of Aydın and Uzun, 2000; Acar *et al.*, 2001 and higher than the results of Çınar, 2001; Türker, 2006; İptaş *et al.*, 2007; Tan and Yolcu, 2001; Acar *et al.*, 2009. The maturation period of plants and the climate and soil in which they grow also effect the ratio of crude protein. It was detected that in 2013 year the ADF ratios which determined according to different reaping frequencies changed between 28.38-38.27% for grasses, 22.54-34.67% for legumes, 23.48-28.37% for other species, in 2014 year 28.90-33.46% for grasses, 23.82-32.8% for legumes, 25.34-32.33% for other species. Evaluating the quality class of forage regarding to ADF composition, obtained other species were in the very good (%31-35) class. As growing stage of forage plants advance, usually ADF ratio is increase. At trial, it was detected that in 2013 year NDF rates which determined according to different reaping frequencies changed between 46.61-60.25% for grasses, 35.19-46.25% for legumes, 38.49-43.09% for other species; and in 2014 year 49.38-56.07% for grasses, 36.72-46.68% for legumes, 40.63-52.64% for the other species.

Table 1. Some chemical traits in botanical composition of a lowland natural range

<b>Grasses</b>																		
Cutting frequency	Crude protein		ADF		NDF		Ca		Mg		K		P		K/Ca+Mg		Ca/P	
	2013	2014	2013	2014	2013	2014	2013	2014	2013	2014	2013	2014	2013	2014	2013	2014	2013	2014
1	19.90	15.96	29.76	31.49	46.61	51.44	1.04	0.93	0.23	0.24	3.18	2.78	0.45	0.39	2.50	2.38	2.31	2.38
2	20.27	20.14	30.14	28.90	51.08	50.28	0.96	1.09	0.22	0.3	3.16	2.63	0.45	0.42	2.68	1.89	2.13	2.60
3	19.56	17.19	28.38	29.02	50.19	50.47	0.85	0.88	0.23	0.25	2.70	2.57	0.43	0.40	2.50	2.27	1.98	2.20
4	16.32	19.14	30.67	30.27	50.49	49.38	0.83	1.37	0.22	0.34	2.90	2.01	0.40	0.38	2.76	1.18	2.08	3.61
5	15.97	14.43	32.04	33.46	51.15	56.07	0.94	0.78	0.25	0.23	2.47	2.41	0.35	0.38	2.08	2.39	2.69	2.05
6	15.50	16.49	31.66	32.07	53.73	52.73	0.83	0.93	0.21	0.24	2.50	2.46	0.37	0.40	2.40	2.10	2.24	2.33
7	11.62	15.65	38.27	31.61	60.25	51.37	0.72	0.93	0.22	0.26	2.11	2.81	0.30	0.39	2.24	2.36	2.40	2.38
8	18.06	16.88	30.70	31.74	47.94	54.19	1.17	0.91	0.28	0.23	2.61	2.64	0.37	0.41	1.80	2.32	3.16	2.22
<b>Legumes</b>																		
Cutting frequency	Crude protein		ADF		NDF		Ca		Mg		K		P		K/Ca+Mg		Ca/P	
	2013	2014	2013	2014	2013	2014	2013	2014	2013	2014	2013	2014	2013	2014	2013	2014	2013	2014
1	26.10	23.33	22.54	23.82	35.19	36.72	1.70	1.69	0.28	0.36	2.67	2.77	0.43	0.39	1.35	1.35	3.95	4.33
2	26.32	25.11	24.49	24.31	41.21	40.14	1.71	1.72	0.31	0.36	2.64	2.45	0.42	0.39	1.31	1.18	4.07	4.41
3	25.28	20.69	25.67	30.50	40.64	43.26	1.73	1.70	0.34	0.34	2.46	2.38	0.41	0.36	1.19	1.17	4.21	4.72
4	25.33	22.56	22.78	28.91	36.74	41.84	1.70	1.81	0.30	0.38	2.60	2.28	0.41	0.38	1.30	1.04	4.15	4.76
5	21.11	22.75	29.61	28.08	41.72	43.40	1.59	1.69	0.28	0.34	2.77	2.52	0.39	0.4	1.48	1.24	4.08	4.23
6	17.98	18.84	31.77	32.80	44.16	46.68	1.54	1.57	0.28	0.33	2.34	2.15	0.34	0.36	1.29	1.13	4.53	4.36
7	17.44	23.65	34.67	24.91	46.25	38.71	1.53	1.66	0.23	0.34	2.49	2.46	0.33	0.40	1.41	1.23	4.64	4.15
8	23.88	19.48	24.64	32.36	38.27	46.05	1.66	1.54	0.30	0.33	2.46	2.22	0.39	0.37	1.26	1.19	4.26	4.16
<b>Other Species</b>																		
Cutting frequency	Crude protein		ADF		NDF		Ca		Mg		K		P		K/Ca+Mg		Ca/P	
	2013	2014	2013	2014	2013	2014	2013	2014	2013	2014	2013	2014	2013	2014	2013	2014	2013	2014
1	24.31	23.23	26.16	26.36	41.01	40.63	1.73	1.75	0.37	0.39	2.97	3.03	0.40	0.38	1.41	1.42	4.33	4.61
2	19.51	22.58	28.15	25.61	40.13	42.18	1.64	1.74	0.34	0.41	3.08	2.81	0.35	0.37	1.56	1.31	4.69	4.70
3	22.89	20.18	27.34	28.8	43.09	45.30	1.81	1.84	0.40	0.41	2.15	2.58	0.32	0.34	0.97	1.15	5.66	5.41
4	23.80	22.22	23.48	29.17	38.49	41.81	1.78	2.11	0.38	0.51	2.74	2.27	0.38	0.33	1.27	0.87	4.68	6.39
5	21.08	20.24	27.62	29.21	41.18	40.81	2.15	1.94	0.49	0.47	2.16	2.75	0.25	0.35	0.82	1.14	8.60	5.54
6	23.67	16.46	27.24	32.33	42.25	52.64	1.69	1.74	0.36	0.36	3.01	2.35	0.40	0.28	1.47	1.12	4.23	6.21
7	18.06	22.09	28.37	25.34	40.89	40.94	1.67	2.06	0.36	0.46	3.02	2.53	0.31	0.28	1.49	1.00	5.39	7.36
8	20.65	20.44	27.25	27.28	41.31	42.42	1.61	2.07	0.34	0.46	2.27	2.27	0.32	0.26	1.16	0.90	5.03	7.96

At quality classification for NDF ratios it was determined that grasses produce good/average forages, legumes produce good forages, other species produce very good forages in 2013 year and very good/ good forages in 2014 year. As the reaping interim increased, ratios of NDF also increased. The phosphorus content of grasses was detected to be 0.30 – 0.45% in 2013 and 0.38 – 0.42 % in 2014. The phosphorus content of legume in 2013 was 0.33 – 0.43%, and in 2014 it was 0.36 – 0.40%. The phosphorus content of other species were 0.25 – 0.40% in 2013 and 0.26 – 0.38 % in 2014.

The potassium content of grasses was detected to be 2.11 – 3.18% in 2013 and 2.01 – 2.81 % in 2014. The potassium content of legume in 2013 was 2.34 – 2.77%, and in 2014 it was 2.15 – 2.77 %. The potassium content of other species were 2.315– 3.08% in 2013 and 2.27 – 3.03% in 2014. The Ca content of grasses ranged between 0.72 – 1.17% in 2013 and 0.78 – 1.37 % in 2014. The Ca content of legume ranged between 1.53 – 1.73% in 2013 and 1.54 – 1.81% in 2014. The Ca content of other species were 1.61 – 2.15% in 2013 and 1.74 – 2.11% in 2014. The magnesium content of grasses was 0.21 – 0.28% in 2013, 0.23 – 0.34 % in 2014, the magnesium content of legume was 0.23 – 0.34% in 2013, 0.33 – 0.38% in 2014. The Magnesium content of other species were 0.34 – 0.49% in 2013 and 0.36 – 0.51% in 2014. Mg contents of some species were higher than recommended value (0.2%) by Tajeda *et al.* (1985). The K/Ca + Mg ratio of grasses in 2013 was 1.80 – 2.76, in 2014 1.18 – 2.39, while this ratio for legume was 1.19 – 1.48 in 2013 and 1.04 – 1.35 in 2014. The K/Ca+Mg ratio of other species were 0.82 – 1.56 and 0.87 – 1.42 in 2013 and 2014, respectively. It is recommended that K/(Ca+Mg) ratio of forages should be below 2.20 (Mayland and Grunes 1979, Kidambi *et al.* 1989; Aydın and Uzun, 2008). K/ (Ca+Mg) ratios of all species, except grasses were below 2.20. The Ca/P ratio of grasses ranged between 1.98 – 3.16 in 2013, 2.05 – 3.61 in 2014. The Ca/P ratio of legume ranged between 2.90 and 4.64 in 2013, 4.15 and 4.76 in 2014. The Ca/P ratio of other species ranged between 4.23 – 8.60 in 2013, 4.61 – 7.96 in 2014.

### Conclusion

While grazing planning on this type of pasture areas, benefit ratio and botanical composition should be considered together. The frequency of utilization of the pasture could be very important. To determine the degree the degradation of pasture vegetation and take measures accordingly, is so important to start pasture management. Pastures should be grazed at an appropriate frequency. There could be an increase of weeds at light grazing pastures. Ensuring sustainability in pasture an appropriate grazing plan should be done by considering pasture vegetation, climatic conditions, soil structure, type and intensity of grazing animals. In the lights of the results obtained from this biannual study, it was considered both forage yield and nutritious value of forage, grazing the pasture every 3 or 4 week is more favorable than the other treatments.

### References

- Acar, Z., Ayan, İ., Gülser, C., 2001. Some morphological and nutritional properties of legumes under natural conditions. *Pakistan Journal of Biological Science*, 4(11), 1312 – 1315.
- Acar, Z., Ayan, İ., Önal Aşçı, Ö., Başaran, U., Mut, H., 2009. Biodiversity in terms of morphological properties and nutritional values of some naturally growing forage grass species. *J. Environ. Biol. Sci.*,583-589 .
- Aydın, I., F. Uzun, 2000. Effect of different improvement methods on yield and botanical composition of natural pasture in Salur Village of Ladik Town. *Turk J Agric For* 21: 301-307.

- Aydin İ. and F. Uzun, 2008. Potential decrease of grass tetany risk in rangelands combining N and K fertilization with MgO treatments. *Europ.J. Agronomy* 29 (2008 ) 33-37
- Buyukburc, U., 1999. A Research on the Grazing Capacity and Improvement of Dereagzi Range at Çamlıbel Area in Province Tokat. Turkey 3. Field Crops Congress, 15 – 18 November, Vol III, 1 – 5, Adana.
- Çınar, S., 2001. A study on the determination of yield and botanical composition of Hanyeri village range in Tufanbeyli, Adana, Turkey. Ms Thesis C.U. Science Inst. P. 78.
- Erkovan, H. I., Koç, A., Serin, Y., 2003. Some vegetation properties of Bayburt (Turkey) province rangeland. Proceedings of the 12th Symposium of the European Grassl and Federation, 26-28 May, 617-619, Pleven, Bulgaria.
- Holechek, J. L., R. D. Pieper and Herbel C. H. 1995. Range Management Principles and Practices. Prentice Hall Inc., 526 p.
- Gokkus, A. And Koc, A., 2001. Pasture and Range Management. Atatürk Üniv. Ziraat Fak. Ders Published No: 228, 329p, Erzurum.
- İptaş, S., Karadağ, Y., Yavuz, M., Acar, A.A., 2007. Determination of Yield and Quality Characteristics of Some Perennial Grasses Forage Crops under Tokat – Kazova Conditions. Turkey VII. Field Crops Congress, 25 – 27 June 2, 66 – 69, Erzurum.
- Kidambi, S.P., A.G. Matches and Griggs. 1989. Variability for Ca, Mg, K, Cu, Zn and K/(Ca+Mg) ratio among 3 wheat grasses and sainfoin on the southern high plains. *J. Range Manage.* 42: 316-322
- Mayland, H.F. and D.L. Grunes. 1979. Soil-climate-plant relationship in the etiology of grass tetany. In: V. Rendings and Di L. Grunes (Ed.). *ASA Spec. Publ. 35*, ASA, Madison. pp. 123-175
- Nadir, M., S., İptaş, Y. Karadağ and H. Kır, 2012. Tokat Province village of Yeşilyurt natural pastures Botanical Composition, Dry Matter Yield and Quality Determination. *Tarım Bilimleri Araştırma Dergisi* 5 (2): 115-117, ISSN: 1308-3945
- Şen, C. Ve Hatipoğlu, R. 2010. A study on vegetation of some village ranges in Kilis Province, Turkey. *C.U. J. Of Sci. And Eng.* 24(3): 28-37.
- Tajeda, R., L.R. McDowell, F.G. Martin and J.H. Conrad. 1985. Mineral element analyses of various tropical forages in Guatemala and their relationship to soil concentrations. *Nut. Rep. Int.*, 32: 313-324.
- Tan, M., and Yolcu, H., 2001. The Nutrition Value of Some Wild Plants as a Forage Crops. Turkey 4. Field Crops Congress, 17 – 21 September, Vol III, 199 – 204, Tekirdağ.
- Terzioğlu, Ö., Yalvaç, N., 2004. A Research on Determination of Grazing Starting Time Hay Yield and Botanical Composition of Natural Rangelands in Van Region Yüzüncü Yıl Üniv. Agricultural Faculty Yüzüncü Yıl Üniversitesi, Ziraat Fakültesi, *J. Agric. Sci.*, 14(1): 23-26.
- Türker, A.H., 2006. Research On Hay Yield And Botanical Composition of an Afforestation Area Protected Since 1997 in Topak Ardıç Locality of Oluk Koyak Village, Tarsus-Mersin Çukurova University, Science Institute, Field Crops Department, Master Thesis
- Vallentine, J. F. , 1990. *Grazing Management*. Academic Press, Inc., 533 p.

## **EVALUATION OF DIFFERENT AGRICULTURAL PRODUCTION SYSTEMS AND ENVIRONMENT RELATIONSHIP APPROACHES**

Makbule Nisa MENCET YELBOGA\*, Cengiz SAYIN

Akdeniz University Agricultural Faculty Department of Agricultural Economics Antalya, Turkey

\*Corresponding author: nmencet@akdeniz.edu.tr

### **Abstract**

Agriculture has become the most important part of the global economy since the 1950s. While local trade gives the place to complex commercial networks and trade relations, agriculture as well as modern economy in agriculture and the accumulation of capital have become “industrial sector”. Until the early years of 90s, with almost every country being in the first place, the main objective of the developed countries is to increase agricultural yield per unit area and thus ensure maximum profit by decreasing the production cost. The most prominent milestone is called “green revolution” which is scientific developments on plant nutrition products and plant protection pesticides. That the agricultural production increase is much higher than the desired level, revealing waste and demand problems along with the ecological crisis and the developments in demographics bringing up different purposes to the agenda. Awareness is arisen among the consumers with interest of sustainable and healthier agricultural production and food consumption in all over the world. It is essential that all the systems regarding food production and consumption in the future have to be based on ecological and integrated approaches. Besides, minimum environmental impacts and efficient natural resources usage should be considered as criteria in these systems. Different approaches upon dynamic agricultural production system will be evaluated in a holistic way in this study.

**Keywords:** *Agriculture, ecological crises, consumption.*

### **Introduction**

People, who have made little changes in the biosphere during their lifetime as gatherers and hunters, have begun to take control of nature with the invention of fire. As known so far, the relationship between humanity and nature had started before the start of agriculture. However, after agricultural activities had started, this relationship provided people with intervention power to the nature and it has continued as a structural lifestyle afterwards. G.Child said that, thanks to agriculture, “by making an active partnership with nature instead of living in nature” people have become productive. In the 18th century, F. Engels said that human should not be proud of being superior to nature even it’s for agricultural purposes, and people, who destroy forests to earn more, are responsible for desertification and poverty in these countries. There are also philosophers remarking that nature can always win in this comparison (Fotourechi ve Sahinoz, 2016; Ponting, 2007). In the book "The Vulnerable Planet," he argued that the arrival of the end of great civilizations like the Sumerians is the reason for the superiority of nature and the construction on the capacity that nature can carry (Foster, 2002; Burkett, 2009). The three functions of agriculture which is seen as the basis of civilization are classified as: keeping a human being who is a part of nature in contact with nature, humanitarianism and gentrification of people’s extensive environment, producing foodstuffs and other materials needed for human life

(Schumacher, 2010). With switching to permanent settlement, living areas have been established, agriculture and industry activities have been started and the natural exploitation capacity of people, who are breaking away from nature and slowly drifting away, have increased. Therefore, environmental problems have increased too. There are many factors related to the ecosystem and the continuity of rural life, as well as the increase in production, the creation of surplus value and the reduction of product costs during agricultural activities. These items cannot be explained only by classical agricultural economy principles or cost elements. For example, problems such as hunger or food security in the world, the disappearance of rainforests, genetically modified organisms, or pesticide residues cannot be explained only by economic models. For this reason, in this study, the relations between agriculture and environment were tried to be reinterpreted with different schools of thought.

### **Material and Method**

The materials of this study are the structured secondary data within the scope of research project '109O169' financed by TUBITAK. For this purpose, studies on agricultural economics, ecology, anthropology and social environment have been compiled and this paperwork was created.

### **Results and Discussion**

When natural resources are converted to a "commodity", and eventually turned into capital accumulation, today's environmental problems have also begun. Especially after the Second World War, agricultural products have become subject to international agreements and international trade network have begun to be directed by multinational companies. While local trade leaving its place to complex commercial networks and associations, agriculture has also begun to become a "sector" with the accumulation of modern economy and capital. Especially in the developed countries, until the beginning of the 1990's, increasing agricultural production and achieving maximum profit with scale economy has become the main purpose. In this process, to increase production and hence income, the policy, which is adopted by developed countries and recommended for other countries, is "green revolution" policies. Together with these policies, the monetary economy in cities has also moved to the villages and the input markets behind the agricultural production and producers have begun to form important consumer masses. When the "green revolutionary politics" produced in contrast with its name begin to show its effect, the increase in agricultural production is much higher than desired, surplus and effective demand problem aroused. Thus, while ecological crises are occurring in areas with particularly fragile ecosystems, "ecological injustice" has begun to become a debated subject too. The "sustainability" antithesis produced to overcome these problems has not been sufficient to resolve structural ecological problems in developing countries. Given the threats to ecology in the agricultural fields, any agricultural activity affects the environment; however, at the same time agricultural production is also exposed to negative externalities from environmental pollution. In this case, we can say that the relations between agriculture and the environment emerge bilaterally. Agriculture is "one of the causes of environmental pollution", especially because of modern production methods. In traditional societies, the natural production was returned to the soil through manuring. However, this balance does not seem possible in the presence of the techniques developed today. The disruption of cycle between living things causes a problem called "metabolic fracture". Agriculture can no longer find the natural conditions of its production in its natural ways, instant, readily emerging and ready to use because all these conditions have turned into a separate industry. Today, this discourse is taken even further by Clark and York (2010),

accusing "modern agriculture, turning oil into the art of turning food into food". Reducing the transformation and environmental relations in agricultural production systems to the "scale" level is missing in many respects. Establishing standards in the production or production process, establishing and certifying traceable systems may seem refreshing for food security for consumers at a certain level of income, but as long as the soil becomes inefficient, the economic crises deepen and financial problems increase, this method will also be difficult to produce. When "scale size" and "small business problem in agriculture" is considered by focusing on cost reduction and high profits, wrong investment decisions could be given. The separation of agricultural land into small pieces and production is important for producers who do not have sources of income other than land, even if they are not rational. The issue of ownership in agricultural land is still important in many countries. The international conventions, resolutions and practices against the mentioned problems are rooted in the 1972 Stockholm Human and Environmental Conference. Gandhi's statement, "Poverty is the biggest polluter," quoted by Gupta (1993), provoked a wide response in this conference. Thus, the economic, social and environmental dimension of development brought up to the agenda. If a country has employment in the agriculture sector, preferably over 50%, and if the share of agriculture in national income is important, you cannot both impoverish and improve its environment. The 'Boundaries of Growth' declaration published in the Roma Club emphasized the contradiction between economic growth and sustainability, but it was accused by many countries. Nowadays, either to keep the agriculture sector alive and save the natural resources innovative and traditional approaches combined to implement in different part of the world. These approaches could be summarized at below;

- a. **Bioregional approach:** What is important now in the agriculture sector is not the more production but the holistic healing that will be provided in the rural area. For this reason, "bioregional" approaches have begun to be adopted. Because, the economics of a bioregion takes its character from nature's laws and conditions. In an economic system defined in this way, it is anticipated that it will have the capacity to plan and share resources in the region it is in, to develop in the safest rate and most ecologically advanced manner. This idea claims that world need instead of more production rural area need holistic improvements or recovery. Because, the economy in a bioregional zone constitute its own characters from the nature law and specific conditions. The defined area allows farmers to plan in an appropriate way and use rationally resources for the future.
- b. **Agro-ecological approach:** This approach is essential to built proper Agricultural policies. To motivate the farmers with financial supportive or some tax exemption implementations for preventing biodiversity losses.
- c. **Free Nature Friendly System Certificate:** This system is applied in Mexico to sustain the farming in disadvantage arable land. For example, local governments give subsidies to farmers keep forest and land. They also tried to reduce carbon emissions in those plantations and succeed in return.
- d. **Climate friendly production system:** Agriculture to total food system emissions is from 7,300 to 12,700 MtCO<sub>2</sub>e per year. Of global anthropogenic emissions agriculture is estimated to account for about 60% of N<sub>2</sub>O and about 50% of CH<sub>4</sub> (Warford et.al, 2010). It's about 14% to 24% of total global emissions (Vermeulen et. al., 2012). The system foreseen adaption and mitigation with sustainability.
- e. **Consume local foods:** After organic production system, a new trend is now consuming local foods. This approach is also covering climate smart agriculture approach. Because according to this, organic food is not enough to protect nature. Solution is combining local organic food to reduce carbon emission with reducing transporting long distance.



## **Conclusion**

All over the world, there is a considerable awareness about the current production of agricultural products and food consumption. Future systems for food production and consumption are needed to be based on a holistic and ecological point of view. Also, in the development of food products and in systems to be applied in food, minimum environmental impacts and effective use of natural resources have to be made important criteria. The ecological crisis in the world should be emphasized more according to Zizek (1992). The crisis is not important only because of its actual danger, namely survival of human, but because it questions our perceptions of "nature". Individuals have different reactions to ecological crises. Zizek divides these reactions into three parts. First idea is: "I certainly know that the issue developed by those who are reluctant to take the ecological crisis seriously is so critical but still I don't believe it, I am not ready to include it to my symbolic universe, so I can continue to pretend that ecological problems will not affect my daily life". The other reaction may realized obsessive to ecological crises. The person in question thinks that "If I do not do it, it will cause a horrible disorder". The third type of reaction is "it is a punishment for our exploitation of nature ruthlessly, making the nature a throwaway object and a warehouse where we supply materials". The outcome of responders in this way is that we need to live as part of nature, adapt ourselves to its rhythm and root in it. Zizek says, with a Lacanian approach, about the ecological crisis, we should learn to accept it without making sense of it. Human being can both heal and destroy the environment that provides his own development. The situation of the environment, affects both a better life and economic development. The idea that 'individual efforts will always bring the world to a better position' should not be just a 'positive and optimistic' idea. To maintain this, the need for collective plans and programs is likely to be greater than ever.

## **References**

- Burkett, P. 2004. Marx ve Nature, Epos publishing, Trans., Ercument Ozkaya, Ankara.
- Clark, B and York, R., 2010. Leaks and Transformation: Ecological Crises, Monthly Review, ISSN: 1306 3766, January 2010, Number:22.
- Foster, J.B., 2002. Vulnerable Planet, Epos publishing, Trans., Hasan Under, Ankara
- Fotourechi, Z and Sahinoz, A., 2016.Environmental Economics and Policies, Imaj publications, Ankara.
- Gupta, A. 1993. Environment and Development in the Third Countries, Kabalci Publishment, Translator Sukru Alpagut, İstanbul.
- Ponting, C., 2007. A new green history of the world: The environment and the collapse great civilization, Vintage Books, London.
- Schumacher, E.F., 2010. "Small is Beautiful", Turkish publication is Varlik Publishment, 5. Edition, Translator: Osman Cetin Deniztekin.
- Vermeulen, S.J., Campbell, B.B., Ingram, J.I., 2012. Annual Review of Environment and Resources 2012 37:1, 195-222
- Warford, J., Munasinghe, M. And Cruz, W. 2010. The Greening Economic Policy Reform, Vol.1., World Bank, Washington Dc.
- Zizek, S. 1992. An Introduction to Jacques Lacan Through Popular Culture , Looking Awry, Trans. Tuncay Birkan, Metis Publications, Ankara.

## DETERMINATION OF RELATIONSHIPS AMONGST THE ALTITUDE, GROWING CHARACTERISTICS AND YIELD FOR TEDERA

Zeki ACAR, Mehmet CAN\*, Celal BAYRAM, Elif ÖZTÜRK, Ilknur AYAN

OMU Agricultural Faculty, Atakum, Samsun, Turkey

\*Corresponding author: zir.mehmet@gmail.com

### Abstract

This study was carried out with 86 *Bituminaria bituminosa* genotypes collected from Central Black Sea Region of Northern Anatolia in Samsun (Turkey) in 2012. After seed cleaning, germination tests and scarifying the seeds with sandpaper, seeds were sown in small pots. In November of 2012, the seedlings were transplanted to experimental field. Neither fertilizer nor water applied throughout the study and spring (6 times with 10 days interval in April and May) and autumn elongation. Hay yield and harvesting number in the second year of the plants (2014) were observed during the study. According to correlation analysis, increasing altitude that the genotypes were collected from affected other traits, negatively. In other words, as the altitude increased, the genotypes started elongation later in spring and autumn, and hay and seed yields and harvested number were decreased. There were positive linear correlation between hay yield and autumn and spring elongations. Though autumn and spring elongations affected the seed yield of genotypes positively, relationships only between seed yield and mid of May elongation and hay yield were significant ( $p \leq 0.05$ ).

**Key words:** *Tedera*, yield, relationship, elongation.

### Introduction

There are 150 species in *Bituminaria* genus held inside *Fabaceae* family (Hooker and Jackson, 1960). *Bituminaria bituminosa* (*Bitbit*) is a perennial herbaceous species in *Bituminaria* genus. Its origin is Mediterranean environment and distributed to Turkey, Western Syria, Crimea peninsula, Cyprus, Caucasia region, Israel, North part of Africa, Portugal, Spain, Canary Islands and the other parts of Southern Europa (Davis, 1965). *Bitbit* is a herbaceous deep rooted perennial legume that has been used by farmers in the Canary Islands for hundreds of years where it is grazed in situ or is cut and fed green to dairy goats (Méndez, 2000). It is an extreme drought tolerant species, and produce good quality feed throughout the year. *Bitbit* remains green in summer and autumn in Mediterranean-type climates with minimal loss of leaves (Gulumser and Acar, 2012; Finlayson *et al.*, 2012). The var. *bituminosa* has a wide adaptation across the Canary Islands (300-1000 mm) and is the only one present in the Mediterranean basin. In the Iberian Peninsula it is found in environments ranging from 250-1000 mm of rainfall and up to 1250-1500 m of altitude (Stenberg *et al.*, 2006; Méndez *et al.*, 2006). Natural distribution of *Bitbit* is in coastal provinces, located such as Samsun, Sinop, Kastamonu, Trabzon, Zonguldak, Antalya, Adana, Mersin, Hatay, Mugla, Izmir, Canakkale, Tekirdag and Yozgat in North, West and South of Anatolia (Kilinc *et al.* 1998; Akcin *et al.* 2010). A strong relation was determined amongst the altitude, hay and seed yield, spring and autumn elongation of *bitbit* genotypes (Acar *et al.*, 2016). The main aim of the study was to obtain more detailed information about relationships amongst yield, harvest number, spring and autumn elongation, original altitudes of genotypes.

## Materials and Methods

Seed samples of 86 *Bitbit* genotypes were collected from Central Black Sea Region in 2012. Regarding the altitude, *Bitbit* plants naturally grow from just nearby the sea (3 m) to south-eastern skirts of Mount Dranaz (985 m). After seed cleaning and germination tests, seeds were scarified and sown in small pots. In November of 2012, the seedlings were transplanted to the experimental field with 70 cm\*70 cm spaces as 20 plants for each genotype. Measurements were realised on 10 plant samples for all genotypes in 2014. Plant height in spring was measured on April 1 (1.04.2014), April 2 (17.4.2014), April 3 (25.4.2014), May 1 (8.5.2014), May 2 (15.5.2014) and May 3 (22.5.2014). Last harvest was performed at the end of September and plant height data about autumn growing before winter were taken at the beginning of November. In 2014, samples of 86 *Bitbit* genotypes were determined hay yield (g/plant) and seed yield (g/plant). 55 genotypes gave twice harvest but 31 genotypes only once. Linear correlation and some regression analysis were performed amongst the traits with SPSS 17.0 program.

## Results and discussion

Linear correlation analysis results amongst the traits can be seen at Table 1. The altitude affected the measured traits negatively. As altitude increased, plant heights in autumn and spring, hay yield, seed yield and harvest number decreased. While effects of altitude on plant height in autumn, April 1,2,3, May 1 and harvest number are significant or highly significant ( $p \leq 0.05; 0.01$ ); on seed and hay yield and plant height in May 2 and 3 are nonsignificant. Effect of altitude on plant height decreased by the growing period progress in Spring season.

Table1. Linear correlation values amongst the traits and their significance levels.

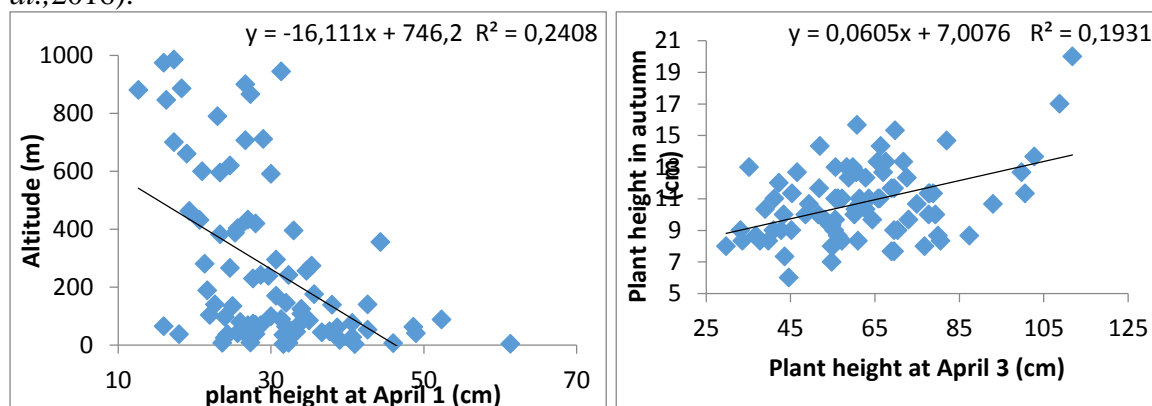
Traits	Altitude (m)	Plant height in autumn (cm)	Plant height in spring (cm)						Hay yield (g/plant)	Seed yield (g/plant)	Harvest number
			April1	April2	April3	May1	May2	May3			
Altitude (m)	1										
Plant height in autumn (cm)	-,224*	1									
Plant height in spring (cm)	April 1	-,491**	,363**	1							
	April 2	-,410**	,376**	,840**	1						
	April 3	-,327**	,440**	,361**	,510**	1					
	May 1	-,237*	,395**	,278**	,457**	,956**	1				
	May 2	-,168	,387**	,263*	,424**	,899**	,947**	1			
	May 3	-,204	,374**	,214*	,354**	,869**	,899**	,915**	1		
Hay yield (g/plant)	-,096	,278*	,262*	,435**	,605**	,649**	,612**	,590**	1		
Seed yield (g/plant)	-,016	,163	,144	,194	,207	,184	,215*	,088	,260*	1	
Harvest number	-,337**	,064	,318**	,320**	,362**	,341**	,298**	,240*	,345**	,122	1

\*indicated values at  $p \leq 0.05$ ; \*\*indicated values at  $p \leq 0.01$  levels are important.

More hay yield was obtained from the genotypes when elongations in autumn and spring were high. The genotypes with elongation earlier in Spring, had higher hay yield and number of harvest (Table 1).

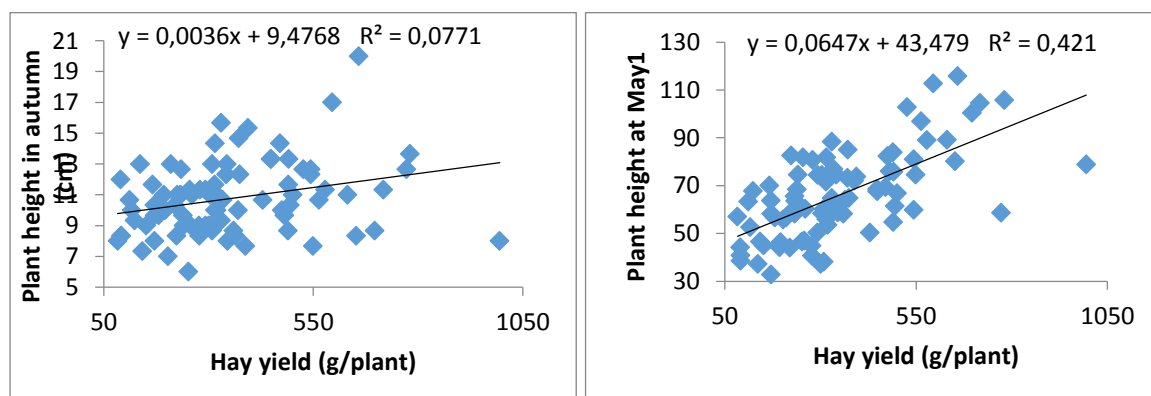
The genotypes from high altitudes started elongation later than the others (Figure 1). The effect of plant height in autumn on elongation in april 3 was statistically significant ( $r=$

0.440\*\*), there was a strong correlation between plant heights in autumn and april 3 (Table 1 and Figure 2). The plants adapted to high altitudes generally have dormancy characteristics and they stay dormant in autumn, winter and early spring period to survive in harsh conditions (Acar *et al.*, 2016; Kilinc and Kutbay, 2004). *Bitbit* genotypes adapted to high altitudes had less elongation in autumn and also started to elongate late in spring (Acar *et al.*, 2016).



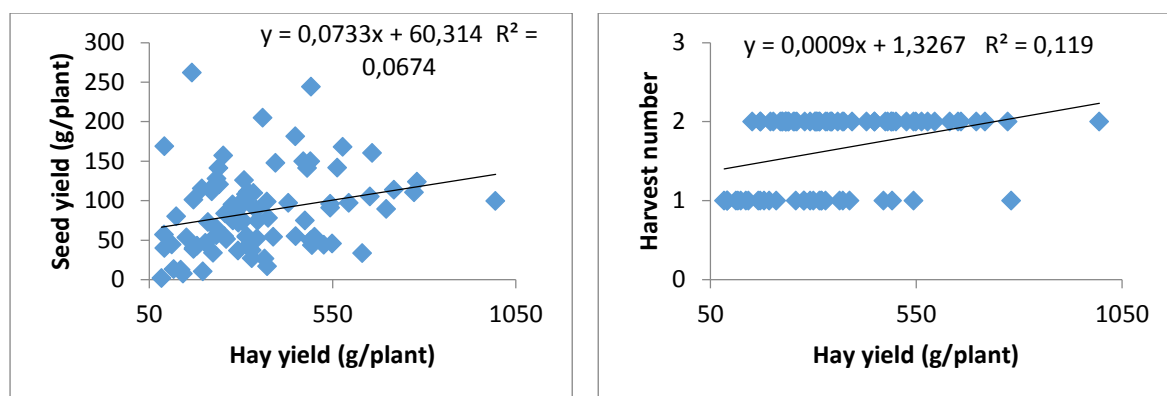
Figures 1. and 2; 1) Relations between altitude and plant height at April 1; 2) Relations between plant height in autumn and at April 3

There were statistically significant correlation between hay yield and plant height in autumn ( $r=0.278^*$ ) and at May 1 ( $r=0.649^{**}$ ) (Table 1 and Figures 3 and 4). The genotypes taken from low altitudes started elongation early in spring and continue their growth until autumn and they gave more cutting and higher hay yield than the others. Probably those genotypes have better regeneration ability. Furthermore, if a genotype started elongation early it has more time and natural resources for growing. Even if the plants keep growing and greenery in summer period, there are the best environmental conditions in spring, thus earlier genotypes have more advantage compare to the others.



Figures 3. and 4; Relations between plant height in autumn and hay yield; May 1 and hay yield

There was a significant correlation between seed yield and hay yield ( $r=0.260^*$ ) (Table 1 and Figure 5). The genotypes have more branches and grow vigorously, those gave both more hay and more seed yield. It is not surprised that increasing number of harvest causes increasing hay yield (Figure 6). Despite the decreasing hay yields through to sequencing harvests, the genotypes had higher number of harvest gave higher hay yield.



Figures 5. and 6; Relations between seed yield and hay yield; harvest number and hay yield

The genotypes stayed dormant in winter, they started elongation late and natural consequence of this situation, number of harvest decreased. Some researchers determined clear differences amongst *Bitbit* genotypes in terms of cold tolerance, harvest number and hay yield (Correal, 2012; Real *et al.*, 2014; Acar *et al.*, 2016).

### Conclusions

There was a strong relation amongst the altitude, *Bitbit* genotypes, and growing characteristics. The genotypes adapted to high altitudes had a slight growth in autumn and they also started elongation later than the others in spring. They survived in cold period owing to dormancy or semi-dormancy. This behaviour of *Bitbit* plants is similar to alfalfa.

### Acknowledgment

Thanks to Turkish Scientific Technical Research Council (TUBITAK) because of financially support the Project (Grant No: TOVAG 111 O 651).

### References

- Akçin, A.A., Akçin, A., Kutbay, G. 2010. A study on flora of Çakmak Dam and its surroundings (Çarşamba, Samsun/Turkey). *Biological Diversity and Conservation*, 3(1), 28-44.
- Correal, E., 2012. Workshop on Suitable for Mediterranean Areas: The Case of *Bituminaria* spp. 28-30 November 2012, Sassari/Italy (Unpublished).
- Davis, P.H., 1965. *Flora of Turkey And The East Aegean Islands*. 1965 – 1988. 1 (1965); 2 (1967); 3 (1970); 4 (1972); 5 (1975); 6 (1978); 7 (1982); 8 (1984); 9 (1985); Edinburgh Univ. Press. Edinburgh.
- Hooker, J.D., Jackson, D., 1960. *Index Kewensis An Enumeration of The Genera and Species of Flowering Plants*. Vol. II. Oxford: Oxford University Press. P. 643-645.
- Finlayson, J., Real D., Nordblom, T., Revell, C., Ewing M., Kingwell, R. 2012. Farm level assessments of a novel drought tolerant forage: Teder (Bituminaria bituminosa C.H. Stirt var. albomarginata). *Agricultural Systems* 112 (2012) 38–47
- Kilinc, M., Kutbay, H.G., Akcin, A., 1998. *Flora of Kocadag and surroundings XIV*. National Biology Congress, 7 – 10 September, 1998, Vol. I, p:95 – 111, Samsun, Turkey (in Turkish).
- Kilinc, M. and Kutbay, H.G. 2004. *Plant Ecology*. Palme press. Ankara, Turkey. P:432 (in Turkish).

- Méndez, P., 2000. The tедера hay (*Bituminous bituminous*): an appetizing forage for the goat. In '3 Iberian Meeting of Pastures and Forages', pp. 412–414. Galicia, Spain.
- Mendez, P., Santos, A., Correal, E., Rios, S., 2006. Agronomic traits as forage crops of nineteen populations of *Bituminaria bituminosa*. *Grassland Sci. Eur.* 11, 300–302.
- Real, D.; Oldham, C.M.; Nelson, M.N.; Croser, J.; Castello, M.; Verbyla, A.; Pradhan, A.; Van Burgel A.; Mendez, P.; Correal, E.; Teakle, N.L.; Revel, C.K. and Ewing, M.A., 2014. Evaluation and breeding of tедера for Mediterranean climates in southern Australia. *Crop & Pasture Sciences*, <http://dx.doi.org/10.1071/CP13313>.
- Sternberg, M., Gishri, N., Mabjeesh, S.J. 2006. Effects of grazing on *Bituminaria bituminosa* (L.) Stirton: a potential forage crop in Mediterranean grasslands. *J. of Agronomy and Crop Sci.* 2006, 192. 399-407.

## IMPACTS OF ROW SPACING AND SOWING DATE ON FORAGE COWPEA (*Vigna unguiculata* L. Walp.) HAY YIELD AND QUALITY

İlknur AYAN<sup>1</sup>, Mehmet CAN<sup>1\*</sup>, Hanife MUT<sup>2</sup>, Zeki ACAR<sup>1</sup>

<sup>1</sup>Faculty of Agriculture, Ondokuz Mayıs University, Samsun, Turkey

<sup>2</sup>Faculty of Agriculture, Bozok University, Yozgat, Turkey

\* Corresponding author: zir.mehmet@gmail.com

### Abstract

Cowpea is often used as human and animal nutrition and green manure. This study was conducted in order to determine the effects of different row spacing and sowing-time on hay yields and some properties of forage cowpea cultivar “Ülkem” and a genotype in ecological condition of Amasya-Suluova. Different row spacing (30, 45, 60, 75 cm) and sowing time (1 May and 1 June) were used according to split block design. In this study, plant height, main stem width, branch number, pod weight, leaf ratio and hay yield were determined.

In this study, it was clear that the cultivar Ülkem was superior to the promising genotype; higher yields were obtained in sowing date 1<sup>st</sup> May; larger row spacing caused decreasing of hay yield. The highest forage yields were determined at 30 cm row spacing (15.87 and 9.78 t/ha) for both sowing date. Crude protein ratios of hay varied from 18.61% to 20.00%. NDF ratios of hay were 33.21% and 32.73% for 1<sup>st</sup> May and 1<sup>st</sup> June sown, respectively. Average ADF ratios were 30.09% and % 30.81 for the same sowing dates. P, K, Ca and Mg contents were 0.35% and 0.37%, 1.97% and 2.01%, 1.51% and 1.56%, 0.49% and 0.52% for 1<sup>st</sup> May and 1<sup>st</sup> June sown, respectively. In conclusion, in order to obtain high and quality forage yield, Ülkem cultivar should be planted with 30 cm row space at the beginning of May in Suluova conditions.

**Keywords:** *forage cowpea, hay quality, row spacing, hay yield, sowing date,*

### Introduction

Cowpea (*Vigna unguiculata* L. Walp) is a substantial food and a valuable part of the conventional cropping systems in the drier region tropics of Asia, Africa and Central America (Mortimore et al., 1997). This precious tropical and subtropical legume is especially important for the semi-arid regions of the tropics for forage, green pods and grains (Adeyanju et al., 2007; Ali et al., 2004). Cowpea is one of the plants among legumes regarding resistance to high temperature and drought. Considering the temperature rise and reduction of water resources due to global climate change, it is emerging as a plant to be worked on. Cowpea is often used as human and animal nutrition and green manure. Green herbage, hay, silage and seeds of cowpea are used for animal nutrition. Cowpea hay is a nutritious balanced fodder for animals (Singh et al., 2003) and has a great function in feeding animals. Having a high nutritive value of green forage cowpea, hay contains 14-21% crude protein, while the seeds have the rate of 18-26% crude protein. It is stated that cowpea is grown alone for forage yield. However, it could be grown mixed with maize, sorghum and millets for silage (Ismail and Hall, 2000; Saricicek et al., 2002; Bilgili, 2009; Basaran et al., 2011; Ayan et al., 2012). The biggest technical constraint in livestock production in Turkey is forage deficiency especially during summer period when pasture vegetation is dry. So there is a need for new warm-season forages to fill forage gap in this

period. In general, solutions to forage shortages during the summer months have included the use of perennial and annual warm-season species for pastures, hay, or silage. The objective of the present study was to investigate forage yield, some quality characters and mineral contents of a cowpea cultivar Ülkem and a genotype in response to four different row spaces and two planting dates.

### **Material and Methods**

The study was carried out in 2013 and was designed as split plots with 4 replicates in Amasya-Suluova (Turkey) ecological conditions. The experiment was designed as sowing dates at main plots, inter row distances at split plots and cultivars at split-split plots. The experimental plots consisted of four rows, each 5 m in length with 50 cm row spacing. Throughout the vegetation period (from May to September) of 2013 total rainfall were 103.1 mm, mean temperature was 19.5 °C, average value of relative humidity was 62.0 %. Released forage cowpea cultivar "ÜLKEM" and a promising cowpea genotype were examined to figure out the effects of different row spacing (30, 45, 60 and 75 cm) and two sowing dates (1<sup>st</sup> May and 1<sup>st</sup> June). In this study, plant height, main stem width, number of branches, leaf ratio and hay yield were determined. Crude protein, acid detergent fiber (ADF), neutral detergent fiber (NDF), K (Potassium), Mg (Magnesium), P (Phosphorus) and Ca (Calcium) contents of samples were determined by using near infrared reflectance spectroscopy (NIRS) 13-15. With software program coded IC-0904FE. The study was completed in irrigated conditions three times. Irrigation process was continued until soil humidity comes to field capacity. All data obtained from this study was analyzed by using SPSS 17.0 program. The differences amongst the mean values were calculated according to DUNCAN test.

### **Results and Discussion**

Average performance of the released forage cowpea cultivar "Ülkem" and genotype regarding forage yield and quality over sowing dates and row spacing are shown in Table 1. Average plant height of the genotypes and the cultivar Ülkem sown on 1<sup>st</sup> May was 166.18 cm, however it was found 110.10 cm on those which were sown on 1<sup>st</sup> June. In both sowing times, plant height increased as row spacing increased. The longest average plant height was found 75 cm and 60 cm. Overall, the cultivar Ülkem sown on May 1, and the genotype sown on June 1 had highest plant heights. Average stem diameter sown on May 1 was 12.01 mm and 9.39 mm sown on June 1. Increasing row spacing caused increasing stem diameter as well. The stem diameter of Ülkem was lower than the stem diameters of the genotype. The number of branches of the genotypes sown on May 1 and June 1 was 5.67 and 4.39, respectively (Table 1). Even if cowpea is a warm season plant, late spring period is very suitable for vegetative grow. Thus, the sowing date of May 1 is superior to June 1 in terms of plant height, branch number and stem diameter. As increase of row spacing each plant has more opportunity to take water, nutrients and sunlight.



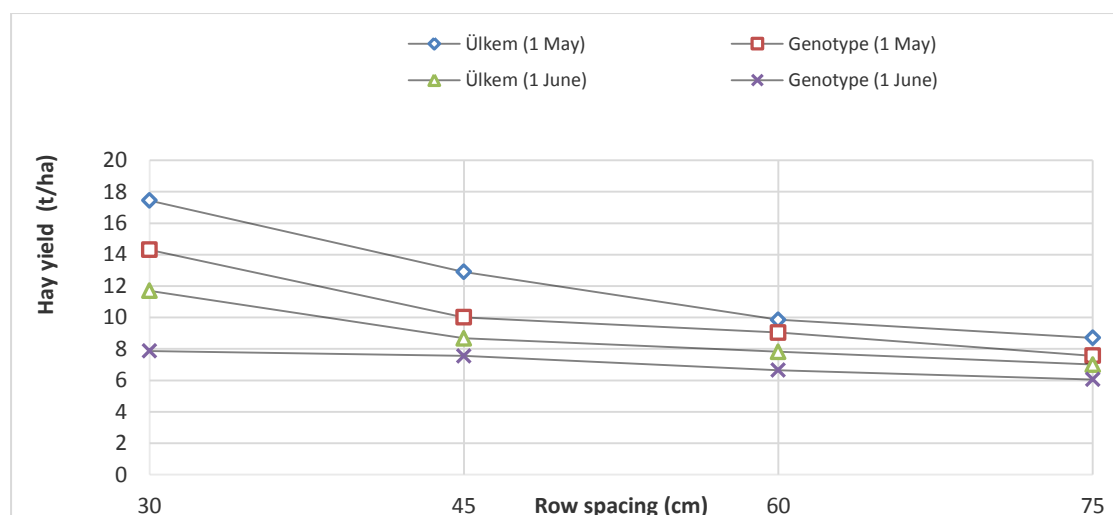


Figure 1. Forage yields of cultivar Ülkem and a genotype grown in different row spacing in sowing dates of 1<sup>st</sup> May and 1<sup>st</sup> Jun

Average hay yield was found 11.22 t ha<sup>-1</sup> in the genotypes sown in May 1 and 7.91 t ha<sup>-1</sup> in the genotypes sown in June 1. The highest hay yield in both sowing date was determined at 30 cm row spacing. Hay yield also increased in parallel to increase of number of plant per square meter. Rest of the row spacing is statistically located in the same group. More hay yield was obtained from Cultivar Ülkem in all treatments of row spacing (Figure 1). With a longer growing time period owing to early sowing, higher hay yield was obtained from the genotypes sown in May 1. One of the most important factors determining the forage yield of cowpea is appropriate sowing date (Mojaddam and Nouri, 2014). There were no statistical differences in terms of leaf ratio. Average leaf ratio was found 69.15% in the genotypes sown in May 1 and 69.70% in the genotypes sown in June 1. More leaf ratio was measured in Cultivar Ülkem compared to the genotypes.

Table 1. Sowing date and row spacing impacts on forage yield and yield performances of cowpea

Row spacing (cm)	Promising cowpea genotype (G.) and Ülkem cultivar *					
	Sowing date 1 <sup>th</sup> May			Sowing date 1 <sup>th</sup> June		
	G.	Ülkem	Mean	G.	Ülkem	Mean
	<b>Forage yield (t ha<sup>-1</sup>)</b>					
30	14.30	17.44	<b>15.87 a</b>	7.87	11.69	<b>9.78 a</b>
45	10.01	12.90	<b>11.45 b</b>	7.55	8.68	<b>8.11 b</b>
60	9.04	9.86	<b>9.44 b</b>	6.65	7.81	<b>7.23 b</b>
75	7.56	8.71	<b>8.13 b</b>	6.06	7.01	<b>6.53 b</b>
Mean	<b>10.23</b>	<b>12.23</b>	<b>11.22 A</b>	<b>7.03</b>	<b>8.80</b>	<b>7.91 B</b>
	<b>Plant height (cm)</b>					
30	135.10	144.80	<b>139.95 c</b>	107.70	70.60	<b>89.15 c</b>
45	148.20	160.80	<b>154.50 bc</b>	118.47	98.13	<b>108.30 bc</b>
60	171.87	186.13	<b>179.00 ab</b>	116.27	109.33	<b>112.80 ab</b>
75	179.20	203.40	<b>191.30 a</b>	116.93	143.40	<b>130.165 a</b>
Mean	<b>158.59</b>	<b>173.78</b>	<b>166.18 A</b>	<b>114.84</b>	<b>105.37</b>	<b>110.10 B</b>
	<b>Main stem width (mm)</b>					
30	10.95	11.21	<b>11.08</b>	9.03	8.83	<b>8.93</b>
45	12.16	11.42	<b>11.79</b>	9.75	9.03	<b>9.39</b>
60	12.21	12.43	<b>12.32</b>	9.97	9.06	<b>9.52</b>

<b>75</b>	12.97	12.80	<b>12.89</b>	10.05	9.43	<b>9.74</b>
<b>Mean</b>	<b>12.07</b>	<b>11.97</b>	<b>12.01 A</b>	<b>9.70</b>	<b>9.09</b>	<b>9.39 B</b>
	<b>Number of branches per plant</b>					
<b>30</b>	5.27	5.73	<b>5.50</b>	3.47	4.13	<b>3.80</b>
<b>45</b>	5.43	5.83	<b>5.63</b>	4.20	4.47	<b>4.34</b>
<b>60</b>	5.50	6.00	<b>5.75</b>	4.60	4.47	<b>4.54</b>
<b>75</b>	5.60	6.07	<b>5.84</b>	4.87	4.93	<b>4.90</b>
<b>Mean</b>	<b>5.45</b>	<b>5.91</b>	<b>5.67 A</b>	<b>4.29</b>	<b>4.50</b>	<b>4.39 B</b>
	<b>Leaf ratio (%)</b>					
<b>30</b>	70.38	78.38	<b>74.38</b>	71.16	72.38	<b>71.77</b>
<b>45</b>	68.69	74.71	<b>71.70</b>	69.58	69.89	<b>69.74</b>
<b>60</b>	63.74	68.43	<b>66.09</b>	68.23	69.69	<b>68.96</b>
<b>75</b>	60.97	67.92	<b>64.45</b>	67.71	68.93	<b>68.32</b>
<b>Mean</b>	<b>65.95</b>	<b>72.36</b>	<b>69.15</b>	<b>69.17</b>	<b>70.22</b>	<b>69.70</b>

\*There are no differences amongst the means indicated same letter at the same line and same column at 0.05 ( $P \leq 0.05$ ) probability level.

Table 2. Sowing date and row spacing impacts on quality parameters (nutritional value) of cowpea forage yield

Row spacing (cm)	Promising cowpea genotype (G.) and Ülkem cultivar *					
	Sowing date 1 <sup>th</sup> May			Sowing date 1 <sup>th</sup> June		
	G.	Ülkem	Mean	G.	Ülkem	Mean
	<b>Crude protein ratio (%)</b>					
<b>30</b>	18.97	18.91	<b>18.94</b>	19.79	19.30	<b>19.55</b>
<b>45</b>	19.53	19.59	<b>19.56</b>	19.60	20.22	<b>19.91</b>
<b>60</b>	19.37	19.25	<b>19.31</b>	19.49	18.61	<b>19.05</b>
<b>75</b>	19.04	18.70	<b>18.87</b>	19.21	19.67	<b>19.44</b>
<b>Mean</b>	<b>19.23</b>	<b>19.11</b>	<b>19.17</b>	<b>19.52</b>	<b>19.45</b>	<b>19.49</b>
	<b>Percent of acid detergent fiber (ADF)</b>					
<b>30</b>	34.09	32.32	<b>33.20</b>	31.48	30.09	<b>30.79</b>
<b>45</b>	25.27	27.77	<b>26.52</b>	29.30	26.81	<b>28.06</b>
<b>60</b>	30.04	34.53	<b>32.29</b>	31.99	31.67	<b>31.83</b>
<b>75</b>	32.91	29.53	<b>31.22</b>	29.66	29.72	<b>29.69</b>
<b>Mean</b>	<b>30.58</b>	<b>31.04</b>	<b>30.81</b>	<b>30.61</b>	<b>29.57</b>	<b>30.09</b>
	<b>Percent of neutral detergent fiber (NDF)</b>					
<b>30</b>	35.62	34.23	<b>34.93</b>	33.11	33.01	<b>33.06</b>
<b>45</b>	29.42	30.87	<b>30.14</b>	32.22	30.73	<b>31.48</b>
<b>60</b>	32.25	37.25	<b>34.75</b>	34.20	33.71	<b>33.95</b>
<b>75</b>	33.26	32.80	<b>33.03</b>	31.71	33.17	<b>32.44</b>
<b>Mean</b>	<b>32.64</b>	<b>33.79</b>	<b>33.21</b>	<b>32.81</b>	<b>32.65</b>	<b>32.73</b>
	<b>Phosphorus (% P in dry matter)</b>					
<b>30</b>	0.36	0.36	<b>0.36</b>	0.37	0.38	<b>0.38</b>
<b>45</b>	0.33	0.36	<b>0.35</b>	0.37	0.37	<b>0.37</b>
<b>60</b>	0.37	0.37	<b>0.37</b>	0.38	0.37	<b>0.38</b>
<b>75</b>	0.33	0.35	<b>0.34</b>	0.36	0.38	<b>0.37</b>
<b>Mean</b>	<b>0.35</b>	<b>0.36</b>	<b>0.35 B</b>	<b>0.37</b>	<b>0.38</b>	<b>0.37 A</b>
	<b>Potassium (% K in dry matter)</b>					
<b>30</b>	2.16	2.15	<b>2.16</b>	1.96	2.31	<b>2.14</b>
<b>45</b>	1.58	1.93	<b>1.76</b>	1.80	2.01	<b>1.91</b>
<b>60</b>	2.19	2.18	<b>2.19</b>	2.07	2.13	<b>2.10</b>

<b>75</b>	1.53	2.03	<b>1.78</b>	1.67	2.16	<b>1.92</b>
<b>Mean</b>	<b>1.86 b</b>	<b>2.07 a</b>	<b>1.97</b>	<b>1.87 b</b>	<b>2.15 a</b>	<b>2.01</b>
	<b>Calcium (% Cain dry matter)</b>					
<b>30</b>	1.43	1.46	<b>1.45</b>	1.63	1.45	<b>1.54</b>
<b>45</b>	1.73	1.53	<b>1.63</b>	1.60	1.52	<b>1.56</b>
<b>60</b>	1.40	1.40	<b>1.40</b>	1.56	1.56	<b>1.56</b>
<b>75</b>	1.70	1.43	<b>1.57</b>	1.68	1.47	<b>1.58</b>
<b>Mean</b>	<b>1.57</b>	<b>1.46</b>	<b>1.51</b>	<b>1.62</b>	<b>1.50</b>	<b>1.56</b>
	<b>Magnesium (%Mg in dry matter)</b>					
<b>30</b>	0.47	0.47	<b>0.47</b>	0.53	0.48	<b>0.51</b>
<b>45</b>	0.55	0.52	<b>0.54</b>	0.55	0.52	<b>0.54</b>
<b>60</b>	0.46	0.46	<b>0.46</b>	0.51	0.51	<b>0.51</b>
<b>75</b>	0.55	0.47	<b>0.51</b>	0.56	0.49	<b>0.53</b>
<b>Mean</b>	<b>0.51</b>	<b>0.48</b>	<b>0.49</b>	<b>0.54</b>	<b>0.50</b>	<b>0.52</b>

\*There are no differences amongst the means indicated same letter at the same line and same column at 0.05 ( $P \leq 0.05$ ) probability level.

There was no statistical difference between treatments in terms of crude protein content. The crude protein content ranged from 20.22% to 18.61% (Table 2). Cowpea fodder is a rich source of crude protein up to 184 g kg<sup>-1</sup> (Khan et al., 2010). NDF and ADF rates of May 1 and June 1 sowing dates were 33.21% - 32.73%; 30.09% - 30.81%, respectively. The CP, ADF and NDF contents of the cowpea genotypes studied indicated that they came within the high quality forage group according to standards developed by the Hay Marketing Task Force of American Forage and Grassland Council (Rohweder et al., 1978). Low of stem diameter and high protein content in the second sowing time could cause lower ADF and NDF values. The average Mg content of May 1 and June 1 sowing dates were 0.49% - to 0.52%, while the average Ca contents were determined to be 1.51% - 1.56%. Average P content of May 1 and June 1 were 10.35%, and 0.37%. K contents of genotypes were greater in both sowing dates than the cultivar Ülkem. K content of May 1 and June 1 were 1.97% and 2.01% (Table 2). The mineral matter needs of gestating or lactating beef are 1.8 -4.4 g kg<sup>-1</sup> for Ca, 0.4 - 1 g kg<sup>-1</sup> for Mg, 6 - 8 g kg<sup>-1</sup> for K and 1.8 - 3.9 g kg<sup>-1</sup> for P (NRC, 1996; Tekeli and Ates, 2005). Tajeda et al. (1985) reported that forage should contain at the level of 2 g kg<sup>-1</sup> Mg and at least 3 g kg<sup>-1</sup> Ca for the ruminant. For this respect, P, Mg, Ca and K content of the forage in released forage cowpea cultivar “Ülkem” and genotype were higher than animal needs recommended by the previous studies.

### Conclusions

In future farming system, the importance of cowpea, known as resistant to high temperature and drought, is likely to increase due to changing climatic conditions. Cowpea can play an important role to fill forage gap by cutting for hay or by grazing during summer-autumn period when pasture yield is very low. Kiesling and Swartz (1997) reported that lambs grazing on cowpea had greater total gain and carcass weight than lambs grazing on sudangrass, fed corn/soybean meal or corn/whole cottonseed with certain ratios. In this study, 30 cm distance, 1<sup>st</sup> May sowing date and cultivar Ülkem has emerged as the most suitable for forage production.

## References

- Adeyanju, A.O., M.F. Ishiyaku, L.O. Omoigui, 2007. Inheritance of time to first Flower in Photo-insensitive cowpea (*Vigna unguiculata* (L.) Walp.). *Asian Journal of Plant Science*. 6(2): 435-437.
- Ali, Y., Z. Aslam, F. Hussain, A. Shakur, 2004. Genotype and environmental interaction in cowpea (*Vigna unguiculata*-L) for yield and disease resistance. *Int. J. Environ. Sci. & Tech.* 1:119.
- Ayan, İ., Mut, H., Basaran, U., Acar, Z., OnalAsci, O., 2012. Forage potential of cowpea (*Vigna unguiculata* L. Walp.). *Turkish Journal of Field Crops*, 17(2): 135 – 138.
- Basaran, U., Ayan, İ., Acar, Z., Mut, H., OnalAsci, O., 2011. Seed yield and agronomic parameters of cowpea (*Vigna unguiculata* L.) genotypes grown in the Black Sea Region of Turkey. *African Journal of Biotechnology*, 10(62): 13461-13464.
- Bilgili, U., 2009. Forage cowpea (*Vigna unguiculata* (L.) Walp.). *Forage Crops, Volume II. Legume Forage Crops* (Ed: R. Avcioglu, R. Hatipoglu and Y. Karadag), Izmir/Turkey, p.448.
- Ismail, A.M., Hall, A.E., 2000. Semidwarf and standard-height cowpea response to row spacing in different environment. *Crop. Sci.*, 40:1618-1623.
- Khan, A., A. Bari, S. Khan, N.S. Hussain, I. Zada, 2010. Performance of cowpea genotypes at higher altitude of NWFP. *Pak. J. Bot.* 42:2291.
- Kiesling, D.O., H. A. Swartz, 1997. Growth and carcass characteristics of lambs grazing cowpea, sudangrass or fed in drylot. *Small Rum. Res.* 26:171.
- Mojaddam, M., A. Nouri, 2014. The effect of sowing date and plant density on yield and yield components of cowpea. *Bulletin of Environment, Pharmacology and Life Sciences*, 3(8):31 – 36.
- NRC (National Research Council), 1996. *Nutrient Requirements of Beef Cattle* (7th Ed.) National Academy Press, Washington, D.C.
- Rohweder, D.A., R.F. Barnes, N. Jorgenson, 1978. Proposed hay grading standards based on laboratory analyses for evaluating quality. *J. Anim. Sci.* 47:747.
- Sarıççek, B.Z., Ayan, İ., Garipoğlu, A.V., 2002. The effect of sole and mix sowing of maize and some legumes on silage quality. *OMÜ Journal of Agricultural Faculty*. 17(3):1 – 5.
- Singh, B.B., H.A. Ajeigbe, S.A. Tarawali, S. Fernandez-Rivera, M. Abubakar, 2003. Improving the production and utilization of cowpea as food and fodder. *Field Crops Res.* 84:169.
- Tajeda, R., L.R. McDowell, F.G. Martin, J.H. Conrad, 1985. Mineral element analyses of various tropical forages in Guatemala and their relationship to soil concentrations. *Nutrition Reports International*, 32: 313.
- Tekeli, A.S., E. Ates, 2005. Yield potential and mineral composition of white clover (*Trifolium repens* L.)-tall fescue (*Festuca arundinacea* Schreb.) mixtures. *J. Cent. Eur. Agric.* 6:27

## A RESEARCH ON POMEGRANATE (*Punica granatum* L.) GROWING AND THE STATE OF SELECTION STUDIES IN TURKEY

Mikdat ŞİMŞEK<sup>1\*</sup>, Ersin GÜLSOY<sup>2</sup>

<sup>1</sup>Department of Horticulture, Faculty of Agriculture, Dicle University, Diyarbakir, Turkey

<sup>2</sup>Department of Horticulture, Faculty of Agriculture, Iğdir University, Iğdir, Turkey

\*Corresponding author: mikdat.simsek@dicle.edu.tr

### Abstract

Pomegranate for which Asia Minor is the gene centre is a tropic and subtropic fruit and one of the oldest cultivated agricultural products. According to 2015 statistics Turkey has 445.750 tons of total pomegranate production. In Turkey, pomegranate is one of the many investigated fruit species in selection studies. The richness of our country on genetic variation of this species provides facility for achievement in breeding studies in a short period of time. Because this fruit is cultivated on many regions of Turkey, it is extremely important to develop varieties proper for many areas. Pomegranate is one of the most important fruit species that are consumed in Turkey. Therefore, some of several superior pomegranate types obtained during the selection studies performed in different areas of our country to date have been registered as cultivar. The some pomegranate varieties located in the registered list of Food, Agriculture and Livestock Ministry are Fellahyemez (01N04), Katırbaşılı (31N07), Ekşilik (01N07), Hicaznar (07N08), İzmir-1264, İzmir-1499, İzmir-1513, Erdemli-Aşınar (33N11), İzmir-23, İzmir-26, Ernar (07N03), Lefan (31N06), Silifke Aşısı (33N16), Ekşi Gökmar (33N12) and Mayhoş-IV (07N14). This study aimed to determine the status of pomegranate cultivation and to demonstrate of some pomegranate types selected from different regions to produce better quality and more efficient pomegranates in Turkey.

**Keywords:** *Pomegranate, Genetic resources, Selection, Production*

### Introduction

Pomegranate (*Punica granatum* L.) is a popular fruit of tropical and subtropical regions that is native to the area stretching from Iran to the Himalayas in northern India (Fawole and Opara, 2013; Parvizi *et al.*, 2016). A pomegranate is a fruit tree, which in recent years has seen great expansion in several countries, especially those with Mediterranean like climates, where fruit of excellent quality can be obtained. Pomegranates are cultivated in the Mediterranean Basin, Southern Asia and several countries in North and South America (Hernández *et al.*, 2014). The main regions for pomegranate cultivation and production are Iran, Afghanistan, India, Mediterranean countries (Morocco, Spain, Turkey, Tunisia and Egypt) and Middle Eastern countries (Melgarejo *et al.*, 2009; Gundogdu and Yilmaz, 2013). Pomegranate cultivars are mainly grown in the Aegean, Mediterranean and Southeastern Anatolian regions of Turkey. Nowadays, pomegranate growing is increasing, especially in these regions because of their suitable ecological conditions (Derin and Eti, 2001). According to 2015 statistics Turkey has 445.750 tons of total pomegranate production (TUIK, 2015). Turkey has different pomegranate genotypes and forms because it is one of the origins of the pomegranate. Therefore, various selection and breeding studies have been carried out and a quite number of pomegranate genotypes have been determined in some regions of Turkey. Up to now, many pomegranate varieties in Turkey have been obtained by selection in other

regions. Some pomegranate varieties in the registered list of Food, Agriculture and Livestock Ministry are Fellahyemez (01N04), Katırbaşı (31N07), Ekşilik (01N07), Hicaznar (07N08), İzmir-1264, İzmir-1499, İzmir-1513, Erdemli-Aşınar (33N11), İzmir-23, İzmir-26, Ernar (07N03), Lefan (31N06), Silifke Aşısı (33N16), Ekşi Gökmar (33N12) and Mayhoş-IV (07N14) (Golukcu *et al.*, 2008). However, Turkey still has many valuable pomegranate genotypes. Objectives of this research are to highlight the pomegranate potential, to examine some of the pomegranate selection studies and to shed light on the future work of pomegranate of Turkey.

### Turkey's Pomegranate Production Potential

Turkey's total pomegranate production is given in Table 1. In this table, our country's total pomegranate production of 1995, 2000, 2005, 2010 and 2015 were 53.000, 59.000, 80.000, 208.502 and 445.750 tons, respectively. In addition, in these years, The yield per pomegranate tree were 23, 24, 25, 32 and 33 kg, respectively. As seen in the table, Turkey's pomegranate potential production have increased.

**Table 1.** Turkey's total pomegranate production.

Year	Area covered by bulk fruit (ha)	Production (t)	Average yield per tree (kg)	Number of fruitful trees	Total number of trees
1995	4.640	53.000	23	2.304.000	2.799.000
2000	4.675	59.000	24	2.485.000	3.294.000
2005	6.700	80.000	25	3.220.000	4.629.000
2010	20.607	208.502	32	6.431.358	12.110.150
2015	30.751	445.750	33	13.310.323	17.382.612

The regions of pomegranate production more than 1.000 tons were given in Table 2. As seen from the Table 2, Mediterranean, Aegean and Southeast Anatolia regions rank first, second and third with 136.332, 88.497 and 72.550 tons of pomegranate productions respectively. Considering the yield per pomegranate tree of the regions, West Anatolia, Mediterranean and Northeastern Anatolia Regions rank the first, the second and the third with 42, 40 and 37 kg of pomegranate productions respectively (TUIK, 2015).

**Table 2.** Total pomegranate production of Turkey's Regions (TUIK, 2015).

Regions	Area covered by bulk fruit (ha)	Production (t)	Average yield per tree (kg)	Number of fruitful trees	Total number of trees
<b>Southeast Anatolia</b>					
Anatolia	7.255	51.790	22	2.378.768	3.396.251
West Marmara	0.250	2.484	22	114.591	184.792
Aegean	8.850	146.080	32	4.593.047	5.488.731
East Marmara	0.508	7.258	29	246.506	338.387
<b>Eastern Anatolia</b>					
Anatolia	0.187	1.932	42	46.090	100.350
Mediterranean	13.633	234.609	40	5.841.431	7.747.966

The provinces with a pomogrenate production more than 5.000 tons is given in Table 2. Antalya, Mersin and Denizli provinces rank first, second and third with 107.237, 61.919 and 45.594 tons of production, respectively (Table 2) (TUIK, 2015). Considering the yield per pomegranate tree of the provinces, Mersin and Karaman, Mardin, and Adana province rank first, second and third with 47 and 47, 46, and 44 kg of pomegranate productions respectively. Şanlıurfa province is the last with a production of 12 kg (TUIK, 2015).

**Table 3.** Pomegranate production of Turkey's Important Provinces.

<b>Provinces</b>	<b>Area covered by bulk fruit (ha)</b>	<b>Production (t)</b>	<b>Average yield per tree (kg)</b>	<b>Number of fruitful trees</b>	<b>Total number of trees</b>
<b>Adıyaman</b>	1.243	5.112	19	268.750	732.995
<b>Antalya</b>	5.737	107.237	40	2.675.648	3.334.156
<b>Adana</b>	2.156	39.715	44	899.427	1.180.802
<b>Bilecik</b>	0.318	5.759	37	156.900	209.228
<b>Gaziantep</b>	1.760	19.370	32	613.778	679.590
<b>Denizli</b>	2.677	45.594	32	1.430.527	1.740.672
<b>İzmir</b>	0.702	11.854	27	433.069	572.234
<b>Hatay</b>	1.224	20.769	27	777.830	1.014.585
<b>Kilis</b>	1.095	9.651	24	394.236	438.040
<b>Manisa</b>	0.536	5.605	24	232.890	296.320
<b>Mersin</b>	4.062	61.919	47	1.327.730	1.978.233
<b>Şanlıurfa</b>	2.140	9.261	12	791.282	1.120.672
<b>Türkiye</b>	30.751	445.750	33	13.310.323	17.382.612

### Some Selection Studies on Pomegranate in Turkey

1. Gundogdu (2006) determined the tree and fruit characteristics of important pomegranate genotypes grown in Pervari town of Siirt province. During the observation, the fruit weights of 25 genotypes ranged from 197g to 328 g. These genotypes were classified as sweet based on their acidity content. The twelve genotypes were chosen for fruit juice industry because they met the suitable criteria. Seed yield varied from 56.60 % to 66.40 %. Seed color was either pink or red. Total soluble solid content in fruit juice ranged from 13 % to 25 %. All investigated 25 genotypes were found to advisable for economical production.

2. Muradoglu *et al.* (2006) selected wild pomegranate genotypes grown in Hakkari province of Turkey. During the observation, it was described desirable pomological traits of 46 pomegranate genotypes selected from Çukurca district (Hakkari). These genotypes had a range of 131-337 g for fruit weight, 60.0-81.0 mm for fruit height, 30.8-88.9 mm for fruit width, 11.0-26.1 mm for calyx length and 11.2-18.1 mm for calyx diameter. In addition, the total soluble solid content was between 12.2 % and 17.6 %. The values of pH ranged from 2.6 to 3.8. The acidity was between 1.5 % and 2.9 %. The genotypes had green or yellow colored bottom skins, red or pink colored seeds, soft, semi-hard and hard hardness seeds. Their seed percentage changed between 49.5 % and 71.5 %. Many genotypes were considered promising.

3. Ak *et al.* (2009) determined some pomological traits of different pomegranate varieties grown in Sanliurfa-Turkey. The cultivated varieties in this study was selected by growers among chance seedlings. In this paper, the traits of some regional pomegranate varieties were

compared. These varieties were Katir Nari, Kus Nari, Millesi, Suruc Tatli Nari, Boncuk, etc. selected in Southeast Anatolia, especially in Sanliurfa province. Other varieties such as Devedisi, Mayhos, Cekirdeksiz, Fellahyemez were selected in other parts of Turkey.

**4.** Gundogdu *et al.* (2010) determined some pomological traits of pomegranate grown in Şirvan (Siirt) region. In the study, fruit weights ranged from 161.45 g to 302.35 g; fruit heights ranged from 60.79 mm to 78.67 mm; fruit diameters ranged from 67.27 mm to 86.92 mm; fruit volumes ranged from 177.5 ml to 305.0 ml; fruit juice amounts ranged from 69 ml to 121 ml; fruit densities ranged from 0.84 g cm<sup>-3</sup> to 1.17 g cm<sup>-3</sup>; seed weights ranged from 80.00 g to 162.35 g; calyx heights ranged from 16.58 mm to 34.64 mm; calyx half-diameters ranged from 9.32 mm to 14.27 mm; Soluble solid contents (SSC) ranged from 12 brix to 16 brix; pH ranged from 3.63 to 5.87; shape indices ranged from 0.84 to 1.03; and total acidity ranged from 0.47% to 1.08%. Moreover, sub skin color, upper skin color, seed hardness, fruit taste, seed color, upper fruit compartment, sub fruit compartment, compartment number, compartment appearance, easiness in separating arils, fruit pulp weights were also determined.

**5.** Ercisli *et al.* (2011) determined 19 promising pomegranate genotypes originating from the Coruh Valley in using fluorescent dye AFLP markers and capillary electrophoresis. Four AFLP primer combinations were used, generating a total of 297 fragments, 213 of which were polymorphic (73.0%). Resolving powers of the AFLP primers ranged from 0.700 to 1.018, with a total of 3.440, while polymorphism information contents ranged from 0.707 to 0.837 with an average of 0.764. UPGMA clustering of the genotypes showed two major groups. Most of the fruit characteristics of the genotypes within the same group were variable. Therefore, the results showed that molecular characterization is necessary to get reliable relationships among pomegranate genotypes and AFLP markers can be used effectively in pomegranate.

**6.** Orhan *et al.* (2013) determined the morphological diversity among pomegranate genetic resources from Coruh Valley located in Northeastern part of Turkey. This valley is accepted one of the 34 hotspots in terms of plant biodiversity in the world. Pomegranate cultivation in this region is one of the main agricultural activities with viticulture. In spite of importance and richness of pomegranate biodiversity from this region, local germplasm of this region has not been investigated yet. For this reason pomegranate (*Punica granatum* L.) population of 10.000 seedling shrubs was examined with regard to morphological fruit properties. In the study, 56 promising pomegranate genotypes were selected from the valley. There was huge morphological variation among genotypes, in terms of particular fruit color, fruit weight, fruit dimensions, aril color and fruit firmness. The genotypes exhibited a range of 147-769 g for fruit weight, 65.19- 107.08 mm for fruit width, 56.84-96.93 mm for fruit length, 2.69-6.05 mm peel thickness and 14.8-49.8 kg/cm<sup>2</sup> fruit firmness. The selected promising genotypes were preserved in a collection parcel as perspective parental genotypes for future breeding activities.

**7.** Okatan *et al.* (2015) described the desirable pomological and chemical traits of seventeen pomegranate genotypes selected from Narlidere district (Bitlis) in between 2010–2011 years. They found considerable variation on fruit weight, aril weight, fruit length and fruit width that important for pomegranate breeding ranged from 99.77 to 515.97 g, 14.16 to 41.92 g, 51.03 to 90.99 mm and 58.99 to 103.11 mm among genotypes, respectively. In this study, It was determined that soluble solid content, titratable acidity, pH and juice yield of genotypes varied between 5.96 to 9.13%, 0.12 to 0.91%, 2.51 to 4.52 and 48.58 to 72.07%, respectively.

**8.** İkinci and Kilic (2016) determined the some pomological and chemical properties of local pomegranate (*Punica granatum* L.) genotypes for high adaptation to local climate grown in the Siverek (Şanlıurfa) county between the years of 2012-2014. In this study, out of the 26 pomegranate genotypes 15 of them were identified as promising cultivars. Fruit weight



ranged from 267.72-650.56 g, fruit length ranged from 69-92.72 mm, fruit width ranged from 80.12-109.61 mm, fruit volume ranged from 275.00-731.67 cm<sup>3</sup>, fruit juice amount ranged from 81-98 ml; fruit density ranged from 0.868-0.974 g.cm<sup>-3</sup> and 1000-grain weight ranged from 141.33-361.33 g among the selected pomegranate genotypes. The soluble solid content, pH and titratable acidity of promising genotypes were determined between 12.64-16.68 brix, 2.84-3.31 and 0.55-2.99% of pomegranate, respectively.

In Turkey, a number of research studies have been executed on pomegranate. For instance; pomological studies on pomegranate varieties of Aegean region (Dokuzoguz and Mendilcioglu, 1978), selection of Mediterranean region pomegranates grown in Mediterranean region of Turkey (Onur and Kaska, 1985), selection of Mediterranean region pomegranates (Yilmaz et al., 1992), combination breeding of pomegranates (Onur and Tibet, 1995), determination of fruit properties of Pervari (Siirt) pomegranates (Kazankaya et al., 2003), pomological properties of growing pomegranates in Hizan (Yildiz et al., 2003), the pomegranate genetic resources in Turkey (Yilmaz et al., 2011), morphological diversity among pomegranate genetic resources from Northeastern part of Turkey (Orhan et al., 2013).

### Conclusion

As stated earlier, a number of research studies have been carried out on pomegranate, regarding both agronomy and selection. As a result, pomegranate production has been increasing day by day in Turkey. In this study, status of pomegranate potential production was determined and some promising pomegranate genotypes for fresh consumption and processing were selected from different regions in Turkey. These promising genotypes also indicate their importance for genetic resources and for breeding purposes in the future.

### References

- Ak, B.E., Ozguven, A.I., Ikinci, A., Yilmaz, C., Parlakci, H. (2009). Some pomological traits of different pomegranate varieties grown in Sanliurfa-Turkey. *Acta Hort.*, 818 (15): 115-119.
- Golukcu, M., Tokgoz, H., Kiralan, M. (2008).. Some properties of important pomegranate (*Punica granatum* L.) cultivar's seeds grown in Turkey. *Gıda*, 33 (6): 281-290.
- Derin, K., Eti, S. (2001). Determination of pollen quality, quantity and effect of cross pollination on the fruit set and quality in the pomegranate. *Turk J Agric For.*, 25 (2001): 169-173.
- Dokuzoğuz, M., Mendilcioglu, K. (1978). Pomological studies on pomegranate varieties of Aegean region. Aegean University, Journal of Agricultural Faculty, 15 (12): 133-159.
- Ercisli, S., Kafkas E., Orhan, E., Kafkas, S., Dogan, Y., Esitken, E. (2011). Genetic characterization of pomegranate (*Punica granatum* L.) genotypes by AFLP markers. *Biol Res.*, 44 (4): 345-350.
- Fawole, O.A., Opara, U.L., 2013. Developmental changes in maturity indices of pomegranate fruit: a descriptive review. *Sci. Hortic.*, 159 (2013): 152-161.
- Gundogdu, M. (2006). Selection of local types in pomegranate (*Punica granatum* L.) populations of Pervari (Siirt). YYU Science Institute (MSc Thesis), Van-Turkey.
- Gundogdu, M. (2006). Selection of local types in pomegranate (*Punica granatum* L.) populations of Pervari (Siirt). YYU Science Institute (MSc Thesis), Van-Turkey.
- Gundogdu, M., Yilmaz, H., Sensoy, R.İ.G., Gundogdu, Ö. (2010). Pomological traits of pomegranate grown in Sirvan (Siirt) region. *YYU J AGR SCI*, 20 (2): 138-143.

- Gundođdu, M., Yilmaz, H. (2013). Determination of fruit vitamin C, sugar and nutrient contents of some standard pomegranate (*Punica granatum* L.) cultivars and genotypes. *YYU J AGR SCI*, 23 (3): 242-248.
- Hernández, F., Legua, P., Martínez, R., Melgarejo, P., Martínez, J.S. (2014). Fruit quality characterization of seven pomegranate accessions (*Punica granatum* L.) grown in Southeast of Spain. *Scientia Horticulturae*, 175 (2014): 174–180.
- Ikinci, A., Kilic, M.E. (2016). Some pomological and chemical characteristics of local pomegranate (*Punica granatum* L.) genotypes grown in Siverek (Şanlıurfa). *YYU J AGR SCI*, 26 (4): 556- 562.
- Kazankaya, A., Gundođdu, M., Askın, M.A., Muradoglu, F. (2003). Fruit properties of Pervari (Siirt) pomegranates. Proceedings of 4th National Horticultural Congress, 08-12 September, 2003, Antalya-Turkey, 141-143.
- Melgarejo, P., Martínez, J.J., Hernández, F., Martínez, R., Legua, P., Oncina, R., Martínez-Murcia, A. (2009). Cultivar identification using 18S-18S rDNA inter-genic spacer-RFLP in pomegranate (*Punica granatum* L.). *Sci. Hortic.*, 120 (2009): 500–503.
- Muradoglu, F., Balta, M.F., Ozrenk, K. (2006). Pomegranate (*Punica granatum* L.) genetic resources from Hakkari, Turkey. *Research Journal of Agriculture and Biological Sciences*, 2 (6): 520-525.
- Okatan, V., Akca, Y., Ercisli, S., Gozlekci, S. (2015). Genotype Selection for Physico-Chemical Fruit Traits in Pomegranate (*Punica granatum* L.) in Turkey. *Acta Sci. Pol. Hortorum Cultus*, 14 (2): 123-132.
- Onur, C., Kaska, N. (1985): Selection of pomegranates (*Punica granatum* L.) grown in Mediterranean region of Turkish Journal of Agriculture and Forestry, 9 (1): 25-33.
- Onur, C., Tibet, H. (1995). Combination breeding of Pomegranates. II. National Horticultural Congress of Turkey. 3-6 October 1995, Adana, 677-680.
- Orhan, E., Ercisli, S., Esitken, A. (2013). Morphological diversity among pomegranate genetic resources from Northeastern part of Turkey. *Journal of Food, Agriculture and Environment*, 11 (2): 470-473.
- Parvizi, H., Sepaskhah, A.R., Ahmadi, S.H. (2016). Physiological and growth responses of pomegranate tree (*Punica granatum* (L.) cv. Rabab) under partial root zone drying and deficit irrigation regimes. *Agric. Water Manag.*, 163 (2016): 146–158.
- Yildiz, K., Muradoglu, F., Oguz, H.I., Yilmaz, H. (2003). Pomological characteristic of pomegranate varieties grown in Hizan town of Bitlis. Proceedings of 4th National Horticultural Congress. 8–12 September, 2003, Antalya-Turkey, 238–240.
- Yilmaz, C., Canan, I., Ozguven, A.I., Yilmaz, M. (2011). The pomegranate genetic resources in Turkey. II. International Symposium on Pomegranate and Minor-Including Mediterranean–Fruits: ISPMMF-2009, Book Series of *Acta Horticulturae*, 890 (28): 207-213.
- TUIK, 2015. <http://www.tuik.gov.tr>.

## **EVALUATION OF AGRICULTURAL ENVIRONMENT INDICATORS WITHIN THE SCOPE OF AGRICULTURAL SUSTAINABILITY**

Tuba BEŞEN<sup>1\*</sup>, Emine OLHAN<sup>2</sup>

<sup>1</sup>Bati Akdeniz Agricultural Research Institute, Turkey

<sup>2</sup>Ankara University, Agricultural Faculty, Department of Agricultural Economics, Turkey

\*Corresponding author: tubabesen@gmail.com

### **Abstract**

In this work, the concept of sustainability and the indicators of the agricultural environment are explained. In the study, agri-environmental sustainability was assessed by index method in Sinop province Sarıkum Lake basin. The index consisted of ten indicators: ratio of farm operators applied synthetic fertilizer, ratio of farm operators applied pesticide, ratio of farms faced with soil erosion, ratio of protected area, ratio of farm operators who were satisfied with the existence of the protected area, ratio of farm operators making soil analysis, ratio of farm damaged by wild animals, crop diversity, the size of land with the slope more than 20% total land, and number of land parcels. As a result, the level of agri-environment sustainability was found on the unsatisfactory level in Sinop Province, Sarıkum Lake Basin. However, the use of unconscious input in the research area was common, damage to wild animals in the land was high, and amount of protected area was low. Despite the damage of wild animal, satisfaction levels of the farmers' were very high in this area. This result requires a separate sociological investigation. In this basin, supports based on the environment should be extended (support of ÇATAK, organic agriculture, and good agricultural practices), the amount of protected area should be increased to the micro catchment level, population control methods should be developed by conducting a research for wild boar population.

**Key words:** *Sustainability, agriculture, indicator, index, Sinop.*

### **Introduction**

Agriculture is the most important sector which provides food for humankind. Increased consumption, global climate change, and increased population make agriculture much more important for humankind than ever. Turkey is located in Mediterranean basin, one of the most affected areas from climate changes according to IPCC reports. For this reason, agricultural studies should be focused on effective natural resources use. In this study, agricultural sustainability, agricultural environment indicators in agricultural sustainability are explained, agri-environment indicators used within the context of EU CAP (Common Agricultural Policy) are mentioned. The agri-environmental sustainability has been revealed with selected area based on agri-environment indicators in Sarıkum Lake Basin, Sinop province, Turkey. The agri-environment index includes ten indicators.

The meaning of sustainability differs from one person to another one. According to Jacobs (1995), sustainability has 386 different definitions (Rigby et al., 2001). The definition of sustainability was introduced by the report first "The Borders of Growth" published by the Club of Rome (Akgül, 2010). Sustainability concept launched in 1972 during the United Nations Human and Environment Conference gained a formal conceptual meaning in the report of Our Common Future in 1987.

The present situation in the world was first announced by Stockholm United Nations Declaration on Human Environment (Anonymous 1972) in 1972, the concept of sustainable development started to be used internationally with the Brundtland Report in 1987 (Anonymous 2016, b). 1992 United Nations Conference on Human and Environment in Rio (Anonymous 1992), 2000 United Nations Millennium Summit on Millennium Declaration (Anonymous 2000) and Millennium Development Goals, 2002 Johannesburg Sustainable Development Summit, The United Nations Conference on Sustainable Development, the Conference on Sustainable Development for the Transformation of the Earth for Humanity and the Planet (Anonymous 2015) emerges as the basis for activities that have evolved in this process and that have made international efforts to ensure that all policies are environmentally sound. These studies, which laid the basis for sustainability at the international level, have shaped policies and practices at a national level.

Sustainability is the main principle of Rio Declaration and Agenda 21, which was established in the United Nations Environment and Development Conference in 1992. According to Agenda 21, the concept of sustainability is multidimensional and includes ecological, social and economic objectives (Anonymous, 2001b). With Agenda 21, the decision to form national sustainability strategies and the sustainability strategies that became a national obligation has been transformed into a strategy that each sector must put forward.

In order to ensure the sustainability of human life and for a progressive development we also need to ensure the sustainability of resources (Harrison 1993). The sustainability of development depends on the sustainability of natural resources ( Berkes 1991).

If the increase of human well-being is continuous, the continuity of the environment and natural resources must be ensured. In this context, environmental sustainability is at the forefront and means the sustainability of natural resources. The level of use of resources must not exceed the rate of self-renewal of these resources and also the proportion of released pollutants must not exceed the rate at which natural resources are able to handle with these pollutants (Kaypak 2011).

When assessing sustainability, it is necessary to evaluate the temporal and spatial effects of human activities, as well as the environmental, social, economic and institutional dimensions and their interactions (Anonymous, 2001a). In order to achieve sustainability, social, environmental and economic dimensions need to be balanced (Tschirley 1996).

Three basic components of sustainability, economic, social and environmental factors are taken independently at first. Then, the assessment shows that there is a relation between them. But now Hart (1999)'s approach accepts that environment dimension involves social and economic dimensions (Figure 1).

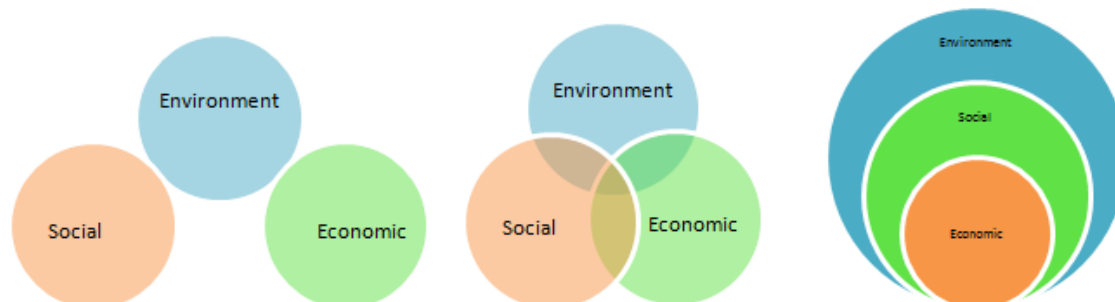


Figure 1 Sustainable development approach

The assessment of sustainability in agriculture is very complex (Gorrie 1999, Andreoli and Tellarini 2000). Many international studies have been carried out on the evaluation of

agricultural sustainability by index method. Studies of agricultural sustainability can cover much larger areas such as the region, the country and even the EU from the farm level (Rigby et al., 2001, Vecchione 2010).

The index sizes and indicators, index development methods are different from each other and these studies reveal different approaches in the determination of agricultural sustainability.

Indicators and indices are used to identify and measure sustainability. Operational definitions and indicators in policy decisions is a precondition for the implementation of sustainability (Rennings and Wiggering, 1997). A good indicator should provide many criteria (Tate 2000). Walker (1998) cited the indicator as a set of many features that could be used to quantify a given terrain, watershed or ecosystem conditions (Walker 2002). Meyer (1992) identified the indicators as measurable environmental features that can be observed by field observation, field sampling, remote sensing or by combining existing data (Walker 2002).

The basic functions of environmental indicators are to give clear and simple messages to the public and to non-expert decision makers about what is happening in the environment. The introduction of open messages in this way will enable decision makers to shed light on the most important points in complex environmental issues without getting lost in detail. As complex environmental issues become more understandable, people can expand their understanding of environmental issues while creating a computable format for the creation of environmental policies. It also helps to evaluate economic and environmental issues together (Anonymous 2002). Agri-environmental indicators are useful tools for analyzing the relationship between agriculture and the environment and identifying trends in this evolving interaction (Anonymous 2017a).

In January 2000, the European Commission published the policy document "Indicators for the Integration of Environmental Concerns into the Common Agricultural Policy", which identified a set of agri-environmental indicators to serve the following purposes:

- provide information on the state of the environment in agriculture,
- understand and monitor the linkages between agricultural practices and their effects on the environment,
- provide contextual information, particularly concerning the diversity of the EU's agro-ecosystems,
- assess the extent to which agricultural and rural development policies promote environment-friendly farming activities and sustainable agriculture,
- inform the global assessment process of agricultural sustainability (Anonymous 2017a).

The Commission is currently working on the development and improvement of the agri-environmental indicators. A streamlined set of 28 indicators is under development, close to cooperation with the Member States (Anonymous 2017a).

Bockstaller et al. (2008) describe what different agro-environmental indicators produced in previous years were and how they worked in the development of these indicators. They have examined the applications of different indicator groups in terms of nitrogen loss and pesticide risk. It has been stated that the indicators related to farmer activities may be based on one or more variables, indicating that the indicators can also be transformed into more complex simulation models in the operational area evaluating pollutant emissions. Niemeijer (2002) studied in three approaches to the development of environmental indicators in policy-based and theory-based approaches to policy development. Moore et al. (2014) used information gathered from local, especially in their studies of agricultural sustainability in small-scale agricultural enterprises.

## Materials and Methods

The research area is located in the Central Black Sea Region, in the north of Sinop province (Turkey) and in the coordinates of 654000-664000 D and 4642000-4654000 K (36 Zone, UTM, WGS-84 m). Basin includes Sarıkum, Başaran, Gümüşsuyu, Tekke, Yeniçam, Selbeyi and İncepınar villages (Anonymous 2017b).

The material of the study is gathered both from original data which have been collected through the questionnaire form from farmers randomly selected in the province of Sinop, Sarıkum Lake Basin and from the available literature review.

The methods that used in this study were collected in two sub-headings. One is used for data collection method, another one consists of the analysis of collected data. The questionnaires consist of 100 questions under 3 separate headings

In selected sample size, the proportional approach that best represents the main mass is used (Miran 2002, Miran 2003, Sahin and Miran 2007, Cankurt and Miran 2010). The main mass is 413. A sample size of 40% was determined with a 10% error margin in the 90% confidence interval.  $P = 0.2$ . The total number of farmers in Erfelek and Merkez districts is 2060.

$$n = \frac{Np(1-p)}{(N-1)\sigma_{p_x}^2 + p(1-p)}$$

n: Sample size

N: Number of farmers

p: proportion of farmers in the basin

$\sigma_{p_x}^2$  : Variance

The sample size was calculated 40 as the proportional sampling Formula was used 90% confidence interval and 10% error margin. Index method used to calculate agri-environment sustainability (Anonymous 2002, Demiryürek et al. 2013, Ceyhan 2010, Vecchione 2010). The aggregation of two or more indicators to form an index comprises four-part process are a selection of variables, data transformation, the weighting of index and valuation of the index (Anonymous 2002, Ceyhan 2010). Transformation methods include normalization, standardization, and distance to policy target analysis of data (Anonymous 2002, Ceyhan 2010). In index valuation, maximum and minimum values are determined from existing real figures rather than a theoretical maximum or theoretical minimum. So, maximum and minimum values were assigned for all indicators and used in equation 1 and 2 (Ceyhan 2010).

$$Indeks = 1 - \frac{[\text{Maximum value}] - [X]}{[\text{Maximum value} - \text{Minimum value}]} \quad Indeks = 1 - \frac{[X] - [\text{Maximum value}]}{[\text{Minimum value} - \text{Maximum value}]}$$

Ten indicators used: ratio of farm operators applied synthetic fertilizer (%), ratio of farm operators applied pesticide (%), ratio of farms faced with soil erosion (%), ratio of protected area (%), ratio of farm operators who are satisfied with the existence of the protected area, ratio of farm operators make soil analysis (%), ratio of farm wild animal damaged (%), crop diversity, the size of land that their slope is more than 20%/total land (%), number of land parcels. Indicators used in this study were field-specific indicators, and implementation in another area may not be correct (Waney et al. 2014). Each indicator weighted equally. From this, each indicator multiplied by ten out of 100. Agri-environment sustainability index was calculated by summing the indicators.

## Results and Discussion

Research results showed that sample farms conducted their activities on 64.61 da of farmland, in which only 2.5% of that irrigated consisted of 5 different plots, on average. Farm households compromised 4 people on average. Farm operators averaged 57 years old and their education levels were moderate. The average annual agricultural income per business is 27.257 TL. Agricultural income per decare is 422 TL. Meadow pasture and feed crops constitute 51.17% of farm land.

Agri-environmental sustainability is defined by ten indicators. Environmental sustainability level in the basin is unsatisfactory.

Table 1 Agri-environment sustainability index

Indicators	Value	Index value
Fragmentation farm index	0.44	4.4
Crop diversity.	0.38	3.8
The ratio of farms faced with soil erosion (%).	0.29	7.1
The ratio of farm operators applied a pesticide (%).	0.44	5.6
The ratio of farm operators applied synthetic fertilizer (%).	0.68	3.2
The ratio of farm operators makes soil analysis (%).	0.22	2.2
The ratio of the protected area (%).	0.12	1.2
Ratio of farm operators who are satisfied with the existence of the protected area (%)	0.94	9.4
Ratio of farm wild animal damaged (%)	0.94	0.6
The size of land that their slope is more than 20%/total land (%)	0.19	8.1
Agri-environmental sustainability		45.6

As it can be understood from the indicators, the rate of chemical fertilizer usage is high despite the fact that the number of farmers who make soil analysis in the basin is not much. The ratio of farm operators applied synthetic fertilizer is 68%, the index value is 3.2. The ratio of farm operators make soil analysis is 22%. The addition of fertilizer that does not need soil affects soil structure as well as crop production in the negative direction. This indicator is also an indication of the level of environmental consciousness of the farmers (Kızılaslan and Kızılaslan 2005). However, the levels of pesticide use are high in the basin. Usage of pesticide affects the entire habitat negatively, especially soil and water resources (Olhan 1997, Algan and Bilen 2005, Dişbudak 2008). The ratio of farm operators applied pesticide 44%, the index value is 5.6. The unconscious use of chemical fertilizers and pesticides in these farms located around the protected area may cause much greater environmental problems. As in the world, environmentally friendly agricultural activities are supported in Turkey too. ÇATAK (Environmentally Based Agricultural Land Protection) supports, good agricultural practices and organic farming supports are that kinds of support. ÇATAK scheme aims to protect the quality of soil and water, to provide sustainability of natural resources, to prevent erosion and to reduce adverse effects of agricultural practices on the environment. These three supports should be wide spread in villages located in protected areas and/or in buffer zones of protected areas. In this way, the use of chemical fertilizers and the use of pesticides can be reduced or controlled. Sustainable use of soil and water resources will also be ensured. The high variety of crops in the farms has an environmental positive effect and supports the conservation of bio diversity. Crop diversity index is 3.8. The high

level of fragmentation has a positive effect on sustainability at the environmental dimension. Because small-scale businesses produce biodiversity, landscape, environmental protection and local products (Vecchione 2010). The number of parcels on farms ranges from 1 to 12. Fragmentation farm index value 4.4. The high rate of slope is a high risk of erosion in the research area. Erosion, one of the most important problems of agricultural land, affects agricultural sustainability negatively (Doğan 2011). The ratio of farms faced with soil erosion is 29%, index value 7,1. In 19% of the study area, the slope is over 20, while in 81% the slope is below 20%. The index value of slope indicator is 8,1. The low rate of slope in most of these basins is a factor that reduces the risk of erosion. It is advisable to use terracing or soil-covering plants in sloping terrain. The need to protect the Sarikum Lake Basin due to its rich biological diversity and the fact that it is one of the world's bird migration routes, hosts five different ecosystems. In addition, these properties in the Sarikum Lake basin make it more inevitable that the existing environmental balance is more fragile and affects all ecosystems hosted by a false application in the field. For this reason, the presence of protected areas within the Sarikum Lake Basin has a positive impact on environmental sustainability (Demirayak 2002). The ratio of protected area 12%, index value was 1.2. The low amount of protected area in this basin has a negative impact on environmental sustainability. The border of the protected area should be enhanced micro basin level (the border of the research area). The ratio of farm operators who are satisfied with the existence of the protected area quite high (94%), the index value is 9.4. The fact that there is a positive view towards protected areas is a reflection of the importance given to environmental values. This indicator also indicates that the Sarikum Lake basin will be successful in supporting environmental conditions as one of the landmarks that can be covered by Natura 2000 in terms of its environmental characteristics. The number of wild animals in this basin was also high, with a high level of biological diversity. The wild boar population in the basin was quite high. The wild boar damage was present in 94% of the farms. Index value is 0.6. This shows that wild animals and human conflict are high. The high level of the wild boar populations in the basin suggests that there is also a type of imbalance between species. Populations need to be provided at a certain level to ensure a balance between species and to reduce human animal conflict.

### **Conclusions**

As a result, the level of agri-environment sustainability was found to be on the unsatisfactory level in Sinop Province, Sarikum Lake Basin. However, the use of unconscious input in the research area was common, damage to wild animals in the farm was high, and amount of protected area was low. Despite the high wild animal damage, farmers' level of satisfaction from the protected area was very high. This result requires a separate sociological investigation. In this basin, support based on the environment should be extended (support of ÇATAK, organic agriculture, and good agricultural practices), the amount of protected area should be increased to the micro catchment level, population control methods should be developed by conducting a research for wild boar population.

### **Acknowledgements**

\*This work was compiled from the results of the Agricultural Sustainability Assessment Project in Sarikum Lake Basin, Sinop province, supported by the General Directorate of Agricultural Researches and Politics, Ministry of Food, Agriculture, and Livestock.



## References

- Anonymous 1972. Report of The United Nations Conference on The Human Environment. A.cONF.48/14/Rev.1 Stockholm 5-16 June 1972. United Nations
- Anonymous 1992. Report of The United Nations Conference on Environment and Development. A.cONF.151/26 (Vol.I)
- Anonymous 2000. Resolution Adopted by the General Assembly (without reference to a Main Committee (A/55.I.2)) 55/2. United Nations Millennium Declaration. A/RES/55/2.
- Anonymous. 2001a. Agri-Environmental Indicators to Describe Agriculture Sustainability. Statistical Commission and Economic Commission for Europe. Commission of The European Communities. EUROSTAT. Working Paper No:21. Conference of European Statisticians. Joint ECE.eurostat Work Session on Methodological Issues of Environment Statistics. Ottawa. Canada.
- Anonymous. 2001b. Statistical Information Needed for Indicators to Monitor the Integration of Environmental Concerns into the Common Agricultural Policy. Communication from the Commission to the Council and The European Parliament. Brussels. 20.03. 2001. COM (2001) 144 Final. Commission of the European Communities.
- Anonymous. 2015. Draft Outcome Document of the United Nations Summit for The Adoption of The Post /2015 Development Agenda. United Nations General Assembly. A/69.I.85. A12 August 2015.
- Anonymous 2016b. Web: <http://www.un-documents.net/our-common-future.pdf>. Erişim tarihi Haziran/2016
- Anonymous 2017a Improving Rural Development Methodology by Ecosystem Approach. 2. Progress report. Ankara.
- Anonymous 2017b [https://ec.europa.eu/agriculture/envir/indicators\\_en](https://ec.europa.eu/agriculture/envir/indicators_en)
- Akgül. U. 2010. Sürdürülebilir Kalkınma: Uygulamalı Antropolojinin Eylem Planı. (Sustainable Development: Action Plan of Applied Anthropology) Ankara Üniversitesi. Dil ve Tarik Coğrafya Fakültesi. Antropoloji Dergisi. Sayı: 24 Sayfa: 133-164 DOI: 10.1501/antro\_0000000023 Yayın Tarihi: 2010
- Algan. F.T. ve Bilen. S.. 2005. Toprak Kirlenmesi ve Biyolojik Çevre ((Soil Pollution and Biological Environment). Atatürk Üniversitesi Ziraat Fakültesi Dergisi. 36 (1). 83-88. ISSN 1300-9036
- Andreoli. M. and Tellarini. V. 2000. Farm sustainability evaluation: methodology and practice. Agriculture, Ecosystems and Environment 77. 43 52
- Berkes. M.F. 1991. Çevre ve Ekoloji (Environment and Ecology). Remzi Kitabevi. İstanbul.
- Bockstaller. C. At. Al. 2008. Agri-environmental Indicators to Assess Cropping and Farming Systems. A Review. Agron. Sustain. Dev. 28 (2008) 139-149 Cınra. EDP Sciences. 2008. Doi:10.1051.agro:2007052.
- Cankurt. M. and Miran. B. 2010. Tractor Brand Preferences of Farmers: An Analytical Hierarchy Process Approach. Tatım Makinaları Bilimi Dergisi (Journal of Agricultural Machinery Science) 2010. 6(1). 13-17
- Ceyhan. V. 2010. Assessing The Agricultural Sustainability of Conventional Farming Systems in Samsun Province of Turkey. African Journal of Agricultural Research Vol. 5(13). pp. 1572-1583. 4 July 2010 <http://www.academicjournals.org.aJAR> ISSN 1991-637X ©2010 Academic Journals.
- Demirayak. F.. 2002. Biyolojikçeşitlilik-Doğa Koruma ve Sürdürülebilir Kalkınma (Biodiversity-Nature Conservation and Sustainable Development). TÜBİTAK Vizyon 2023 Projesi Çevre ve Sürdürülebilir Kalkınma Paneli için hazırlanmıştır.
- Demiryürek. K. Ceyhan.V. Argunhan. E. 2013. Organik ve Konvansiyonel Fındık Yetiştiriciliği Faaliyetlerinin Sürdürülebilirliği (Sustainability of Organic and

- Conventional Hazelnut Cultivation Activities). Türkiye 5. Organik Tarım Sempozyumu. Ondokuz Mayıs Üniversitesi 27-27 Eylül. 2013. Samsun
- Dişbudak. K. 2008. Avrupa Birliği'nde Tarım-Çevre İlişkileri ve Türkiye'nin Uyumu (Agriculture-Environment Relations in Europe and Adaptation of Turkey). Tc. Tarım ve Köy İşleri Bakanlığı. Dış İlişkiler ve Avrupa Birliği Koordinasyon Dairesi Başkanlığı. AB Uzmanlık Tezi. Ankara. 2008.
- Doğan. O.. 2011. Türkiye'de Erozyon Sorunu Nedenleri ve Çözüm Önerileri ( Causes of Erosion Problem in Turkey and Suggested Solution.). Bilim ve Aklın Aydınlığında Eğitim. Nisan 2011. Sayı: 134. Sayfa: 62-69.
- Gorrie. G. 1999. Sustainable Indicators in a Policy Context. Australian Government Department of Agriculture, Fisheries and Forestry. Canberra, Australia.
- Harrison. Paul. 1993. The Third Revolution (Population, Environment and Sustainable World). Penguin Boks. London.
- Kaypak. Ş. 2011. Küreselleşme Sürecinde Sürdürülebilir Bir Kalkınma İçin Sürdürülebilir Bir Çevre(A Sustainable Environment for Sustainable Development in the Globalization Process ). KMÜ Sosyal ve Ekonomik Araştırmalar Dergisi. Yıl: 13. sayı: 20. ss:19-33.
- Kızılaslan. H. Ve Kızılaslan. N. 2005. Çevre Konularında Kırsal Halkın Bilinç Düzeyi ve Davranışları (Tokat İli Artova İlçesi Örneği) ( Awareness Levels and Behaviors of Rural People in Environmental Issues (Case of Artova District of Tokat Province))Uluslararası Yönetim İktisat ve İşletme Dergisi. Cilt 1. Sayı 1.
- Miran. B. 2002. Temel İstatistik (Basic Statistics). Ege Üniversitesi Basımevi. İzmir. 288s.
- Miran. B.. 2003. Temel İstatistik (Basic Statistics). Ege Üniversitesi Basımevi. Bornova. İzmir.
- Moore. A., Dormody. T., VanLeeuwen. D and Harder. A.. 2014. Agricultural Sustainability of Small – Scale Farms in Lacluta, Timor Leste. International Journal of Agricultural Sustainability Volume 12. Issue 2. 2014 DOI. 10.1080/14735903.842341. pages 130-145.
- Niemeijer. D. 2002. Developing indicators for environmental policy: data-driven and theory-driven approaches examined by example. Elsevier. Environmental Science & Policy 5 (2002) 91–103
- Olhan. E. 1997. Türkiye'de Bitkisel Üretimde Girdi Kullanımının Yarattığı Çevre Sorunları Ve Organik Tarım Uygulaması-Manisa Örneği ( Problems of Environment Created by Using Input in Production and Application of Organic Farming-Manisa Example). Doktora Tezi (basılmamış). Ankara Üniversitesi. Ankara.
- Rennings. K., Wiggering. H.. 1997. Steps towards indicators of sustainable development: linking economic and ecological concepts. Ecological Economics 20. 25–36.
- Rigby. D., Woodhouse. P., Young. T., Burton. M.. 2001. Constructing a Farm Level Indicator of Sustainable Agricultural Practice. ELSEVIER. Ecological Economics 39 (2001) 463-478.
- Şahin. A. ve Miran. B. 2007. Çiftçi Algılarına Göre Ürünlerin Risk Haritası: Bayındır İlçesi Örneği(Risk Map of Products According to Farmer Perceptions: Bayındır District Example.). Ege Üniv. Ziraat Fak. Dergisi. 2007. 44 (3):59-74 ISSN 1018-8851.
- Tate. J. (2002). Void dwellings - a "headline" indicator? Sustainable Development 10(1): 36-50. The Energy & Biodiversity Initiative. (2002). Biodiversity Indicators for Monitoring Impacts and Conservation Actions.

- Tschirley. J. B. 1996. Use of Indicators in Sustainable Agriculture and Rural Development. Sustainable Development Department (SD) Dimensions. Food and Agriculture Organization (FAO). Rome.
- Vecchione. G. 2010. EU Rural Policy: Purposal and Application of an Agricultural Sustainability Index. Munich Personal RePec Archive.
- Walker. J. 2002. Environmental Indicators and Sustainable Development: In McVicar. T.R., Li Rui, Walker. J., Fitzpatrick. R.W. and Liu Changming (eds). Regional Water and Soil Assessment for Managing Sustainable Agriculture in China and Australia. ACIAR Monograph No. 84. 323–332. <http://.aciar.gov.au/files/node/468.mn84section4technologytransferchapters24-29.pdf>
- Waney. NFL, Soemarno, Yuliaty Y, Polli B. (2014). Developing Indicators of sustainable agriculture at the farm level. IPSR Journal of Agriculture and Veterinary Science (IOSR-JAVS). E-ISSN:2319-2380. p-ISSN:2319-2372. Volume 7. Issue 2.II(Mar-Apr. 2014). PP 42-53. [www.iosrjournals.org](http://www.iosrjournals.org)

## ACETAMEPRID TOXICITY ON LIVER STRUCTURE IN MALE ALBINO MICE

Leila SAADI<sup>1\*</sup>, Sarra LAMRANI<sup>2</sup>, Rafika MATALLAH<sup>2</sup>

<sup>1</sup>Biology and physiology department, SNV Faculty, Blida 1 University, Algeria

<sup>2</sup>ENS, Kouba, Algeria

\*Corresponding author : saadileila4@gmail.com

### Abstract

The research for pesticide toxicity on non-target mammals has been the subject of many studies. Neonicotinoids, including acetamiprid are among the most widely used insecticides worldwide since 1991 on several agricultural crops. The main aim of this work is to study the short-term toxicity of acetamiprid on mice liver structure which is the major site of metabolism including detoxification. Eighteen adult male albino mice were divided into three groups, group 1 was kept as control, which is administered orally with distilled water whereas groups 2 and 3 were administered with acetamiprid. The insecticide was given at two dose levels (1/20 LD<sub>50</sub> and 1/30 LD<sub>50</sub>) through oral route for 15 days. The mice receive water and food every day at will. The liver sections were observed with optical microscope. At the end of treatment, the mice are sacrificed, and the liver is removed for study by light microscopy. Body weight gain showed a non-significant increase in all mice. However, microscopic observation showed significant alterations in the hepatic parenchyma. The histopathological effects included disorganization of the hepatic architecture in some areas, frequent sinusoids dilatation, congestion in the central vein, thickening of portal vein's endothelial membrane, swelling and vacuolization of local hepatocytes in addition to nuclear hypertrophy. These results are in favor of an inflammatory process at the tissue level. According to the results, we conclude that even low doses of acetamiprid can be toxic to adult male mice at the tissue level.

**Key words:** *Acetamiprid; Liver; Male mice; Histopathology; Toxicity.*

### Introduction

With the introduction of the neonicotinoids, an important economic advantage was obtained in the improvement of the agro-alimentary productivity (Maienfisch et al., 2001). Acetamiprid, neonicotinoid insecticide, is an extensively used for crop protection worldwide from the last decade due to its low soil persistence and high insecticidal activity at very low application rate (Pisa et al., 2015). The selective toxicity of acetamiprid to insects and not to mammals reported to be due to differences in the structure and binding affinity at the nicotinic acetylcholine receptor (Tomizawa and Casida, 2003). Acetamiprid exposure leads to block a type of neuronal pathway which causes the accumulation of acetylcholine which leads to paralysis and eventually death of the insect pests (Iwasa, 2004). In the mammals, several works announced signs of toxicity of acetamiprid with concentrations lower than the lethal amount (Mondal et al., 2014). These signs comprise morpho-functional deteriorations on the level of certain vital organs such as the liver, the kidneys, the lungs and the brain (Keshta et al., 2016) associated with disturbances of biochemical parameters (Shakthi Devan et al., 2015). Therefore, the present study was carried out to investigate the effect of two different doses of acetamiprid on histology of liver in male albino mice.

## Material and Methods

Male albino mice a rodent species, was selected as experimental animal and were obtained from from the national institute of the agricultural research, Algeria. Mice were kept in cages for at least 7 days prior to dosing for acclimatization to the laboratory conditions in a wire topped polypropylene cage with paddy husk bedding. The animals were maintained for a period of acclimatization under controlled conditions of temperature ( $22 \pm 2^\circ\text{C}$ ) and humidity ( $65 \pm 10\%$ ) with 12h light and dark cycle. The control and treated animals were given food in pellet form and water *ad libitum*. The Faculty Institutional Animal Ethics Committee approved this experimental protocol.

The mice were randomly selected, marked by tail painting to permit individual identification. After acclimatization animals were divided into three groups consisting of 6 mice each. Group 1 served as control, groups 2 and 3 were treated with acetamiprid doses at the rate of 1/20 LD50 and 1/30 LD50. The doses were administered by oral gavage for 15 days. All groups of mice were weighed and sacrificed. The tissues of liver were removed and immediately fixed in 10% formaldehyde. After the routine procedure, the fixed tissues were embedded in paraffin and 5  $\mu\text{m}$  thick tissue sections were stained with routine haemotoxylin and eosin in order to examine under light microscopy. All data were expressed as mean  $\pm$  standard error. The statistical significance of the mean differences between control and treated groups was analyzed by ANOVA, with Tukey HSD post hoc test for multiple comparisons. Statistical calculations were performed with the SPSS 11.5 computer program (SPSS Inc. Chicago, Illions, USA). The values of ( $P < 0.05$ ) were taken as the cut-off value to consider differences statistically significant.

## Results and Discussion

According to the results, it appears that treatment with both doses of acetamiprid does not affect growth in mice (fig.1) and does not produce any signs of toxicity and mortality during 15 days exposure.

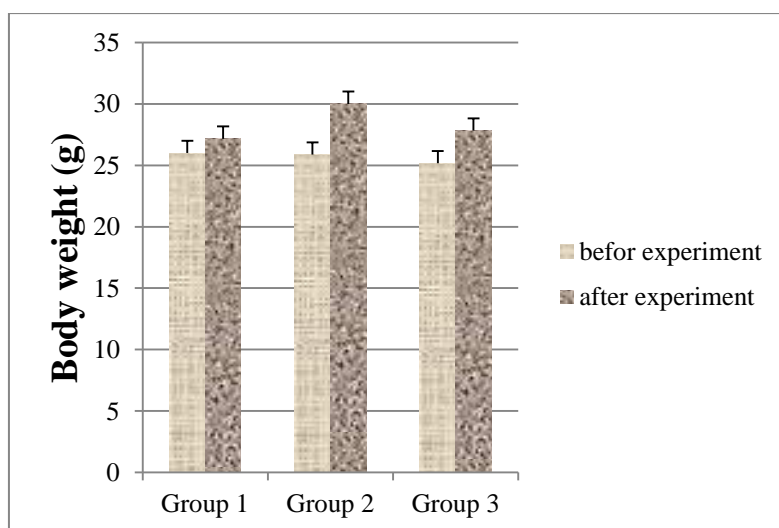
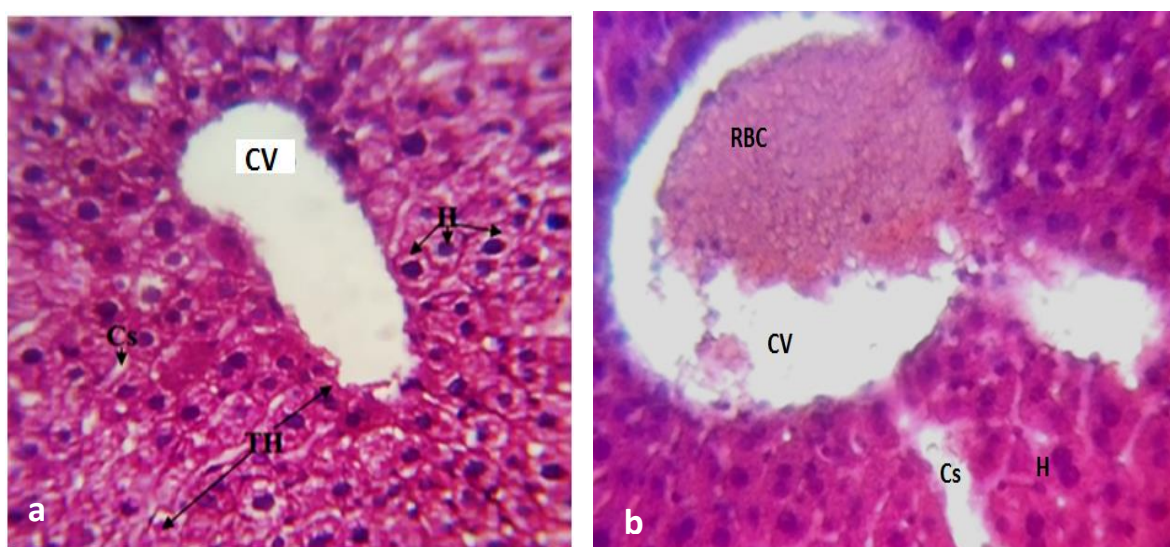


Fig. 1 Effect of acetamiprid treatment on mice body weight (g). Group 1 was kept as control, which is administered orally with distilled water whereas groups 2 and 3 was administered with acetamiprid at the rate of 1/20 LD50 and 1/30 LD50 respectively.

Liver is a target organ for detoxification and is prone to various disorders as a consequence of exposure to environmental pollutants. Histopathological alterations in tissue may be used as a

rapid method to evaluate the toxic effects of chemicals in different tissues and organs (Hinton and Lauren, 1990; Bernet *et al.*, 1999). Histopathological examination of liver specimens taken from control group showed normal histological structure of the central vein and surrounding hepatocytes in the parenchyma (Fig.2a). Compared with those of control, liver sections of mice treated with 1/20 LD50 and 1/30 LD50 of acetamiprid for 15 days showed heavily congested central vein and blood sinusoids, mononuclear cell infiltration, hypertrophied hepatocytes and cytoplasm vacuolization. The major histopathological changes in liver following an exposure to acetamiprid were showed in Figure 2 b-f. These results are in agreement with study conducted by Mondal *et al.* (2014) who reporting no significant changes in liver parenchyma of rats received 25 mg/kg, 100 and 200 mg/kg of acetamiprid. Our study confirms that lead by Rasgele *et al.* (2015) who noted vacuolar degeneration and sinusoidal dilatation in the liver parenchyma of mice treated with different doses of Acetmiprid. There are a few studies on the histological effects of acetamiprid on different tissues and organs in the different organisms. It has been reported that acetamiprid damaged seminiferous tubules and Leydig cells of mice (Zhang *et al.*, 2011); renal corpuscles and tubules in kidney of mice (Zhang *et al.*, 2012). However, previous studies also demonstrated that neonicotinoid insecticides such as imidacloprid and thiamethoxam have caused impairment of the histopathological parameters in different organisms. It was reported in rats that imidacloprid induced heavily congested central vein and blood sinusoids and leukocyte infiltration in liver (Mohany *et al.*, 2011 and condensation of nuclear material in neurons, degenerative changes in glial cells, congestion in blood vessels and vesicular bodies in different brain regions (Kishandar *et al.*, 2013). It is observed in layer chickens a degeneration, coagulative necrosis and hemorrhages in liver and hemorrhages, vacuolar degeneration of tubular epithelial cells as well as focal coagulative necrosis in kidney (Kammon *et al.*, 2010). It was also indicated that thiamethoxam caused histopathological changes in liver of rats (Shalaby *et al.*, 2010) and mice (Al-Sharqi *et al.*, 2012). All the study suggested that toxic responses occur relatively more frequently in the liver, mainly because the liver is a predominant organ for the metabolism, and is also the first major organ to be exposed to ingested toxins, due to its portal blood supply (Popp and Cattley, 1999).



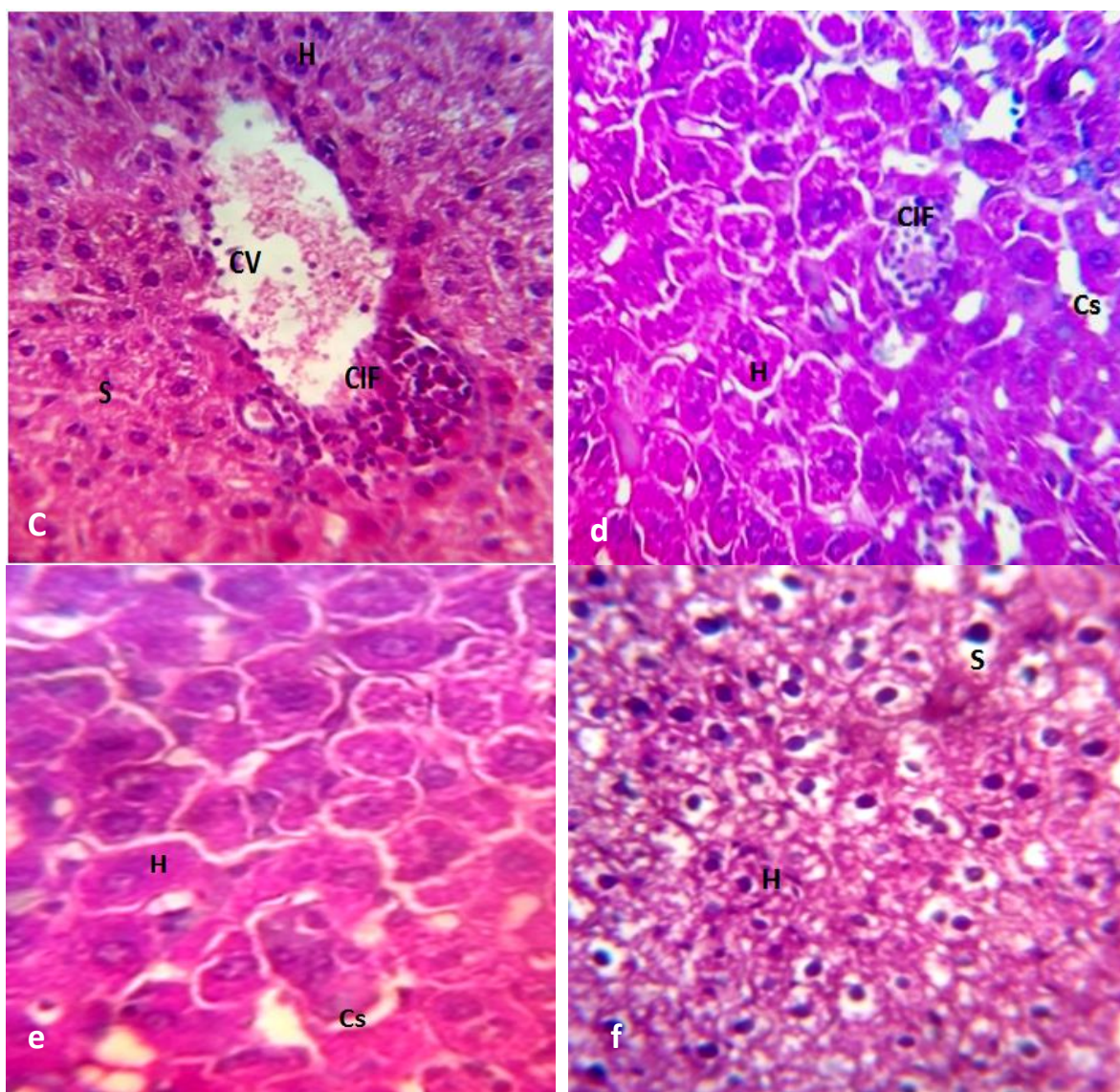


Fig. 2 The photomicrograph of mice liver sections (x400). (a), control group showing normal histological structure of hepatocytes (H) ; (b-f), the liver treated with acetamiprid showing dilation of sinusoids (Cs) with congestion and accumulation of red blood cell (RBC) in vein central (b), cell infiltration (CIF) (c,d), hypertrophic hepatocytes (e) and cytoplasm vacuolization (S) (f).

### Conclusion

According to the histopathological findings in this study, exposure to 1/20 LD50 and 1/30 LD50 acetamiprid led to toxicological effects on the liver tissue of mice. These results showed that tissue alterations caused by chemicals in liver may result in functional problems and may lead to cell in animals. However, to gain better insight into the damaging potential of acetamiprid, further studies at molecular level should be conducted.

### Acknowledgements

We are thankful to the Head, Doyen of SNV Faculty, for providing facilities for conducting research.

## References

- Al-Sharqi S. A. H., Alwan M. J., Al-Bideri A. W. (2012). Histological changes induced by the action of Actara 25 wg insecticides in mice. *International Journal of Advanced Biological Research*, vol. 2, pp.760–765.
- Bernet D., Schmidt H., Meier W., Burkhardt-Holm P., Wahli T.(1999). Histopathology in fish proposal for a protocol to assess aquatic pollution. *Journal of Fish Diseases*, vol. 22, pp. 25–34.
- Hinton D. E., Lauren J. C. (1990). Integrative histopathology approaches to detecting effects of environmental stress on fishes. *Am. Fish. Soc. Symp*, vol. 8, pp. 51– 66.
- Iwasa T., Motoyama N., Ambrose JT.,Roe M.R.(2004).Mechanism for the differential toxicity of neonicotinoid insecticides in the honey bee, *Apis mellifera*. *Crop Protection*, vol.23, pp.371-378.
- Kammon A.M., Brar R.S., Banga H.S., Sodhi S. (2010). Patho-biochemical studies on hepatotoxicity and nephrotoxicity on exposure to chlorpyrifos and imidacloprid in layer chickens. *Veterinarski Arhiv*, vol. 80(5), pp. 663-672.
- Keshta A. T., Hataba A. A., Mead H. M. I., El-Shafey N. M. (2016). Oxidative stress and biochemical changes induced by thiamethoxam and acetamiprid insecticides in rats. *World Journal Of Pharmacy And Pharmaceutical Sciences*, vol. 5, pp. 44-60.
- Kishandar N., Jacob D.,Murali Krishna C. (2013). Histopathological Studies of Neonicotinoid Insecticide Imidacloprid on Different Regions of Albino Rat Brain. *International Journal of Toxicology and Applied Pharmacology*, vol.3(4), pp 73-77.
- Maienfish P., Huerlimann H., Rindlisbacher A., Gsell L., Dettwiler H., Haettenschwiler J., Sieger E., Walti M. (2001). The discovery of thiamethoxam: a second-generation neonicotinoid. *Pest Manag Sci*. Vol. 57(2), pp.165-76.
- Mohany M., Badr G. Refaat I., El-Feki M. (2011). Immunological and histological effects of exposure to imidacloprid insecticide in male albino rats. *African Journal of Pharmacy and Pharmacology*, vol. 5(18), pp. 2106-2114.
- Mondal S., Ghosh R. C., Karnam S.S., Kamal Purohit Shalaby S. E. M., Farrag A. R. H., El-Saed G. S. M. (2014). Toxicopathological changes on Wistar rat after multiple exposures to acetamiprid. *Veterinary World*, vol. 7(12), Pp. 1058-065.
- Pisa L., Amaral-Rogers V., Belzunces L., Bonmatin J.-M., Downs C., Goulson D., Kreutzweiser D., Krupke C., Liess M., McField M., Morrissey C., Noom D., Settele J., Simon-Delso N., Stark J. D., Van der Sluijs J. P., Van Dyck H., Wiemers M. (2015). Effects of neonicotinoids and fipronil on non-target invertebrates. *Environmental Science and Pollution Research*, vol. 22(1). pp 68–102.
- Popp J.A., Cattley R.C. (1991). Hepatobiliary system, in:Handbook of Toxicologic Pathology. Haschek, W. M., C. G. Rousseaux, Eds. Academic Press Inc. San Diego.
- Shakthi Devan R.K., Akhilesh M., Prabu P. C., Mandal T.K. (2015). Sub-chronic oral toxicity of acetamiprid in Wistar rats. *Journal of Toxicological and Environmental Chemistry*, vol. 97, pp.1236-1252.
- Rasgele P.G., Oktay M., Kekecoglu M., Muranli F.D.G. F. D. (2015). The histopathological investigation of liver in experimental animals after short-term exposures to pesticides. *Bulgarian Journal of Agricultural Science*, vol. 21(2), pp. 446–453.
- Tomizawa M., Casida J.E. (2003).Selective toxicity of neonicotinoids attributable to specificity of insect and mammalian nicotinic receptors. *Annual review entomol*, vol. 48, pp. 339–364.
- Zhang J. J., Wang Y., Xiang H. Y., Li M. X., Li W. H., Ma K. G., Wang X. Z., Zhang J. H. (2011). Oxidative stress: role in acetamiprid-induced impairment of the male mice reproductive system. *Agricultural Sciences in China*, vol. 10, pp.786–796.



Zhang J. J., Wang Y., Xiang H. Y., Zhang H. J., Wang X. Z. (2012). Nephrotoxicity of acetamiprid on male mice and the rescue role of vitamin E. *Journal of Animal and Veterinary Advances*, vol.11, pp. 2721–2726.

## **SCIENCE AND TECHNOLOGY INNOVATION FOR SUSTAINABLE DEVELOPMENT**

Atef HAMDY\*, Nouredin DRIOUECH, Adel ALY

International Centre for Advanced Mediterranean Agronomic Studies of Bari (CIHEAM-Bari), Valenzano (Bari), Italy

\*Corresponding author: hamdy@iamb.it

### **Abstract**

Nowadays, technically and politically, there is a growing international consensus about science and technology (S&T) being a key for achieving global sustainable development. It is well recognized worldwide that international science and technology cooperation initiatives could play an important role in steering developing economies towards sustainable development. However, most of the information we have clearly indicate that very few countries, if any, have the capacity knowledge platforms and resources to do this alone. Initiatives are needed to integrate certain elements, including science and technology and knowledge transfer, in the long run, and to build effective knowledge networks involving the local community and variety of stakeholders, including business stakeholders. To put such initiatives in action, however, requires more effective partnerships, and cooperation between regions, between countries, between institutions and between people. This cooperation should be both North-South and South-South oriented and between governments, academia, and business in both developed industrialized countries and developing ones. Furthermore, such cooperation should be fundamentally directed towards fostering capacity building in science and technology, facilitating effective diffusion of scientific knowledge and technology transfer and towards developing knowledge infrastructure and networks. Those approaches are indeed the driving force that helps in providing a platform appropriate for most countries to learn and find innovative ways of taking ownership of their sustainable development areas, especially ecological problems related to land degradation, climate change and fresh water shortage. In this way, those country would find options and innovative modalities to tackle the challenges of producing more with less water.

**Key words:** *Agriculture, knowledge transfer, S&T, cooperation, sustainable development*

### **Introduction**

As we enter the twenty-first century the pace of technological advances continues to accelerate, with great potential to improve the lives and livelihoods of people in developing and developed countries, and with profound implications for the global economy **UNESCO (2007)**.

Technically and politically it is fully agreed that the road to the promising future, all, we are looking for can be found through science and technology. Being far away from science and technology and or both being neglected from our daily practices are the main factors seriously and negatively affecting any environmental performance improvement ,while even more importantly the raising of the resource efficiency and profitability (**OECD, 2015**). Indeed there is nothing new in what was mentioned above, hence, on the globe it is well recognized the important means the emerging new innovation technologies are providing to deal with the challenges we are facing .Today despite of the political momentum generated

started since the **Rio Earth Summit of 1992** and the follow up and adoption of series of multilateral environmental conventions of key issues the degradation of the global environment goes on. Ecological problems such as lost of biodiversity, land degradation, ozone layer depletion, climate change, fresh water shortages and marine and coastal areas deterioration are more and more frequent. This is the actual situation that demonstrates clearly that if we continue to devour our ecological capital in this way, the bio-capacity of our planet to meet our needs will be seriously jeopardized. Here comes the important role science, technology and innovation could provide being the key elements to be used in order to achieve the sustainable developing goals (SDGs). Indeed, (STI) have the potential to increase the efficiency, effectiveness and impact of our efforts to meet the ambitious of the 2030 agenda for sustainable development and create benefits for society, the economy, and the environment (**OECD, 2015; ECOSOC, 2013; UN, 2015**). Now there is consensus that STI is critical to any strategy to improve quality of life and the socio economic and environmental situation of any country as shown in **Box 1**.

### **ISSUES to the WHAT's and the HOW's of Science and Technology**

The What's, those are the today challenges. The what's could be addressing the following issues:

- What technology do we want to encourage and develop?
- What are the technologies that can bring true benefits to society?
- What technologies can be readily transferred to regions where they can be best used?
- What beneficial technologies can be developed locally?
- What technologies show the most promise for the future?
- What types of research do we want to fund?
- What science should be exploring so that they can be applied to provide beneficial technologies?

Answering the above mentioned What's issues will result in an appropriate identification types of technologies emphasizing on those that restore or improve the environment and draw upon natural resources without significant long-term depletion of resources.

THE HOW'S: the further step which is relatively difficult is addressing the how's is uses the representing stand desire policy key elements including:

- How best to establish the right technologies for sustainable development and how to overcome barriers to their implementation?
- How to develop institutions and decision making so as to promote implementation, greater openness and participation by different sectors and a better balance sometimes conflicting aspects?
- How to improve the measurement of sustainability through the integration of economic, social and environmental aspects.
- How best to enhance international cooperation between industrialized developed countries and developing ones?
- How can technologies be transferred around the world and perfected locally to overcome the surrounding barriers?

The above fore mentioned What's and How's will be mostly discussed in this paper.

### **BOX (1) Sciences and Technology Innovation (STI): Major Impacts**

Economically: STI are the main drivers of productivity increase in all sectors, from manufacturing to agriculture and basis of economic growth.

Environmentally: STI provide the answer of managing resources and reducing pollution, addressing climate change and preserving bio diversity.

Socially STI: help reduce disease and safe guard our health and well being while maintaining the general quality of life.

### **Science and Technology Innovation (STI): The Policy**

The overlap in STI policy occurs due to the existing gaps in policy articulation and design, insufficient capacity to conduct policy evaluation and monitoring, and a lack of coordination between policy making, governmental interventions and business environment. The Policy should give answers to the following issues: (i) How does innovation policy fit into the broader context of industrial development strategies? (ii) What are the most critical areas of coordination? (iii) What lessons can be drawn from countries experiences in promoting policy coordination and how to be applied to other countries?

The main elements of an optimal science policy inclusive of technology and innovation are the followings (**Box 2**)

### **Box (2): Optimal Science Policy: Main Elements**

- The linkage between innovation and research
- New initiatives undertaken in view of emergence of blue economy at international, regional national and local levels
- Coherence at the levels of policy-conceptualization and design, and policy implementation and coordination
- Monitoring and evaluation mechanisms
- Innovation practices and research policies across different countries and regions both developed and developing.

### **STI National Strategies**

Those strategies serve several functions in government policy making: First, articulate the governments' vision regarding the contribution of STI to their countries social and economic development. Second, they set priorities for public investment in STI and identify the focus on government reforms. Third, the development of these strategies can engage stakeholders ranging from the research community, funding agencies business, and civil society to regional and local governments in policy making implementation.

### **STI: Focusing Issues**

There are several issues where STI POLICY should be focusing on among them:

- Prioritize critical areas like agriculture, climate variability and change, communication, energy, food security, environment and water management.

- Promote inter disciplinary research
- Foster use of innovation from both strategic and non-strategic sectors of research
- Invest into young innovators through education training and monitoring.
- Search strategic alliance and partnerships with other nations both in policy and implementation spaces
- Discuss ethical, social, and economic dimensions of emerging technologies.

### **STI And How Best To Be Effectively Implemented**

Despite consensus on the transformation potential of STI there remains a lack of clarity on how best to effectively implement it for inclusive and sustainable development. To address this gap we must develop a common understanding of an effective conceptual framework that will enable STI to be economically and socially inclusive. The critical components of this framework are effective institutions digital infrastructure, appropriate legal and regulatory frameworks and incentives for investment, and a work force to the future. Equally it is critically needed to first chart the practical steps required for balanced and integrated development. In this regard some of the core elements of an effective innovation system for inclusive and sustainable development are as follows: first, to harness the potential of STI for inclusive and sustainable development through engaging all actors in the innovation system to ensure plans incorporate the economic social and environmental dimensions of sustainable development. However this will not happen automatically. Harnessing STI for inclusive and sustainable development will require committed deliberate actions for integrated government approach. Second, effective institutions as they are the foundation of effective STI creation, development and implementation. Indeed institutions define the rules and principles and establish the infrastructure pattern for interactions. Third, committing to and incentivizing investment in STI. This is critical element as for innovators often lack funding at crucial stages will result in preventing basic research as well as early-stage startup (ECOSOC, 2004; WCS, 1999; Juma and Lee, 2005).

### **International CIT Cooperation**

In many cases developing countries are simply not technologically capable of using innovative cleaner technology and moving towards the sustainable development in harmony with the nature. Here, it is to be stressed that unless the new technologies are adequately diffuse and applied at the global level, their optimal effectiveness will never be attained. The today's challenge is how to enable the developing countries to properly utilize these technologies through international cooperation although the priorities and needs of the developing countries are not those of the developed ones. Here, comes the important role could have the international science and technology cooperation between developed industrialized countries and the developing ones. Such cooperation can have several means such as conducting programmes to combat environmental problems, the coordination of collaborative R&D programmes, facilitating technology transfer and through providing the developing countries with the technical and financial assistance they are in real need to. Globally as a blue print it is totally accepted that sustainable development can be effectively achieved only close collaboration among countries Here the question to be raised what are the developing countries major duties, and what are the tasks of developed countries in strengthening international science and technology co-operation ?

### **Developing Countries Major Duties**

Governments of developing countries can play an important role in improving education, R&D and technology policies to enable their countries to more effectively reap the benefits of international cooperation. They could also play a crucial role in the identification of the

country specific barriers, needs and steps towards the introduction of environmentally sound technologies. **Hamdy and Trisorio Liuzzi (2004)** reported that in order to solve environmental problems of developing countries, firstly, they must increase their own efforts through implementing strategic structural adjustment programmes and striving for scientific and technological progress. Secondly, they should strengthen international cooperation especially between developed and developing countries and their ability in the research and development of new technologies to be applied and used appropriately in the developing countries in order to enable those countries to solve successfully their environmental problems. In this regard, current international SIT cooperation programmes need to be assessed from the perspective of the needs of the developing countries, and good practices should be identified and diffused.

### **Developed Countries: Major Tasks**

The developed countries can assist the developing countries in vital areas like improving the institutional capacity building and human resources development in the field of environmental technologies (UN, 2000). Scientific and technological Capacity building, including personnel training, cooperative research and supply of basic scientific research instruments and apparatus should be actively supported. Those items represent the crucial elements required for effective favorable environmental conditions. Successful long-term partnerships in technology cooperation necessarily require continuing systematic training and capacity building at all levels over an extended period of time . It is necessary to improve conditions and processes on information access to and transfer of technology including state-of-the-art technology and related know-how in particular to developing countries.

Information and communication techniques are a key role in science and technology development (**Soutr & Maclean, 2012**). Access to and capacity to use relevant ICT need to be improved and the appropriate infrastructure to be developed in most developing countries. Further the developed countries can have an effective role in improving and the dissemination of the knowhow by building the knowledge networks those linking business, universities ,research institutions and the local community to build up local, national regional innovation systems. In addition one of the tasks of developed countries is the set up of policies, frameworks conducive to increasing demand for cleaner technologies as well as enhancing the flows of technologies arising from their publicly funded R&D programmes. As crucial task the developed countries should bear their historical responsibilities and play a key role in environmental protection, increase their financial contribution to provide new and additional funding for the developing countries.

### **International S&T Cooperation: Major Barriers**

In both developed and developing countries there are existing barriers hindering the contribution the international science and technology cooperation can make to the diffusion and stimulating environment innovative technology (**Metz et al., 2000, Chase, 1997**). Developing countries often face difficulties in accessing appropriate scientific knowledge and technical skills. Their own knowledge base needs to be strengthened and the qualified human resources that are needed to develop and implement environmental technologies must be updated and increased (**Hamdy, 2003**).

Many of the countries particularly those that urgently need to build STI capabilities are facing tremendous constraints in mobilizing financial resources. These financial commitments are currently lacking even within sectors such as climate change or energy access, where financing innovation capacity needs to become a priority of sustainable development. The international community will have to step in to fill this gap.

The migration of the highly skilled human resources in science and technology is a major constraint towards sustainable development. The brain drain of university trained researchers and engineers exert a serious negative impact in building up effective research and innovation capacities and systems in many countries of the developing World. The challenge is how this trend can be diversified to brain circulation or brain return, which should be able to check the one way drain brain from the developing countries.

Another barrier which is notably lowering the cooperation level between developed countries and developing ones that for the latter the inadequacy of the research and development infrastructure and other framework conditions such as effective research network and suitable funding mechanisms to develop and utilize cleaner technologies. Generally for a greater number of developing countries, there is a lack of mature engineering technology for ecological protection, reconstruction and reasonable utilization (**Hamdy and Sardo, 2002**).

Indeed for several development countries, although small scale experiments on non-harmful production technologies have been undertaken yet they are in short supply as there are a number of technical problems need to be addressed before full-scale practical engineering application can be developed. The experience gained from the realized projects is insufficient.

Information is a major obstacle towards sustainable development. The issue of access of information has been addressed in the future we want **UNESCO, 2012** and the public right-to know is fundamental in engaging all relevant stakeholders in sustainable development. Sharing and exchange of information across the three pillars of sustainable development can result in synergies and bring increased benefits for a wide spectrum of users from policy makers to the business community to citizens. Mobile learning and the use of mobile devices for communicating data and information for sustainable development has enormous potential offering new avenues for collaboration and open approaches to innovation and providing real opportunities for this innovation to be truly inclusive.

### **Sustainable Development: The Technological Challenge**

**According to the UN System Task Team (2011)**, technological learning and innovation capacity are cross-cutting issues for inclusive development. Meeting the increasingly environmental challenges, requires access to a range of appropriate technologies. Much of the required technology is already available in the public domain but accessing and linking them to the required knowledge and skills within countries is neither automatic nor costless. It calls for investments in dynamic capabilities, particularly those that shape the ability of national stakeholders to uptake and absorb technologies and make improvements in line with local circumstances. In such a case, the international community as such has a collective responsibility in connecting local technological needs to international technological opportunities which represent a particular challenge for many developing countries. In least developing countries (LDCs) sustainable development implies a well functions STI ecosystems including, interlay, political stability and well functioning institutions ,an educated work force, sound research and education infrastructure and linkages between public and private innovation actors ,enterprises committed to research and development as well as balanced intellectual property rights (IPRS) framework.

### **Research And Knowledge Production And Innovation**

In many developing countries there is still a great need for improving of research innovation activities The dynamic of research and innovation is not a simple response to national policies and national frontiers. rather it is a dynamic that is based upon the social actors that are directly or indirectly involved in the development of scientific activities, individual researchers ,research groups, research institutions ,universities ,high educational institutions,

research communities, enterprises, and public policies enacted by governments and inter-governmental programmes. Things are different for innovation than research, since not all innovations are research based. However, it is important to emphasize that for research, as for innovation, the growth of activities follows a cumulative path. This path dependency is particularly important because new research and innovation activities will always depend upon former investments and former experiences. And, this is true both for research-driven activities as well as for innovation and technology generally. All technologies are constructed on prior experiences and this progressive technological learning builds paths made up of accumulated practices.

### **Technology Diffusion And Transfer Between Developed And Developing Countries**

Technology diffusion is essential in realizing sustainable development goals. However the technology may not be widespread use because of its price, the lack of information on the part of firms or other market failures. Technology transfer and capacity building to adapt, absorb and diffuse technologies, and finally, reach higher level of capability for technological innovation are two sides of the same process. The world community has reached the conclusion that ,developing countries are facing sever constraints in their efforts to advance in the transfer of environmentally sound technology EST transfer and cooperation since they lack adequate financial resources and have limited human institutional capacities. In order to support the transfer of ESTs on terms that will promote their use and rapid diffusion, priorities should be given to the following key areas:

- i) dissemination of and access to information on ESTs;
- ii) institutional development and capacity building;
- iii) financial arrangements, technology cooperation and partnerships.

There is a wide gap in the views between the north and south regarding the technology transfer and its development. The north emphasizes the key role of the private sector as a principal conduit through which technology is developed transferred and disseminated. On the other hand south stresses the need to promote and finance for answers. There is no unique solution or single mechanism which could solve the transfer of environmentally sound technologies and corresponding know-how on favorable terms. Enhancing the transfer of ESTs has stimulated a great deal of debate and discussions. However the topic is still searching for answers. There is no unique solution or single mechanism which could solve all the problems related to ESTs transfer between developed and developing countries. Some framing guidelines are missing, those are needed for setting up effective and efficient action programmes to facilitate ESTs transfer, It should be kept clear in mind that technology transfer between developed and developing countries is not a one-way flow of resources. It works best when it builds upon sustained partnerships or cooperative arrangements in which all partners can realize their interests and share responsibilities and benefits over the entire technology transfer process. For developing countries, it is essential to ensure that the technological solutions fit the conditions, needs and capacities of the potential user, and are consistent with community requirements for sustaining economic growth (**Abu Zeid and Hamdy, 2010**).

### **Indigenous and local knowledge(s) and science(s) for sustainable development**

The adoption of the 2030 Agenda by the UN General Assembly on 25 September 2015 open up a unique chance to align indigenous and local knowledge with national strategies and marginalization planning for sustainable development, climate change, conservation agendas,



and tackling persistent poverty and marginalization of indigenous people and local communities.

Scientific Advisory Board Of the UN-Secretary General (**UNSGSAB**) **2015**; The UN-System Wide Action Plan (**SWAP**) **2015**; **AGENDA (AAAA)**, **2015**; **UN**, **2015**; and The Power of Culture for Development **UNESCO (2012)**, all recognized that traditional knowledge, innovation, and practices of indigenous people and local communities can support social well-being and sustainable livelihoods. These organizations in their meetings on sustainable development and the 2030 new global agenda to take the world on a sustainable pathway reaffirmed and fully agreed that recognition, protection and promotion of indigenous and local knowledge strengthens economic, environmental, social, and cultural resilience within societies and forms knowledge base for addressing critical sustainability problems of the 21 century. In addition they highlighted the synergies between implementing the out-comes of the world conference on indigenous people and the 2030 development AGENDA.

### **Concluding remarks and recommendations**

- Partnerships amongst science and technology communities and indigenous peoples and local communities together with major groups and other stakeholders should be fostered to enhance the implementation of the 2030 sustainable development agenda.
- The widespread and successful EST's transfer to developing countries is in great need to capacity building programmes for managing technological change. Many developing countries continue to lack the level of national scientific capacity including critical mass of well trained scientists, technicians and engineers those are required to generate scientific inventions ;and produce technological innovation ; and to adapt and absorb technologies; In this context ;there is great need for developing and supporting intensive interaction between institutions of education and training and of research development on the one hand and local industries on the other.
- Technology needs assessment (TNA) can be useful tool for environmental technology assessment. TNA can enable the government or the constituencies to identify a portfolio of technology transfer projects and capacity building activities that need to be undertaken to facilitate and possibly accelerate; the development; adaptation and diffusion of EST's in the various developing sectors, Further; it offers opportunities for the collaborations of donors in financing and implementing capacity building projects and in coordinating follow-up activities at the national level.
- Information and communication technologist is at the forefront of technological advances in environmental protection as well as it is also means of spread best practices. Indeed the use of ICT for environmental protection; exchange of experience; information access and technology transfer is becoming an important factor in efforts towards sustainable development. Globally; information technology is no longer restricted to developed industrialized countries either in innovation or application; however in several developing countries still lack the technologies soft ware and hard ware to make adequate use of the rapid development modes of information and communications.
- For the transfer of EST studies have indicated that the problem is not just a lack of financing per se and that the issue more on market development than existence of funds. Considering that this argument is true; particularly within developing countries perhaps there will be no lack of financing. However for most cases the opposite is true and that

mobilizing of investment funds have proved to be the major constraint system are all critically important for understanding and addressing complex challenges and opportunities for people and planet .

- Diverse knowledge systems, encompassing the physical and natural science, social science and humanities as well as indigenous and local knowledge are all critically important for understanding and addressing complex challenges and opportunities for people and planet. In as much as biological diversity underpins the resilience of ecosystems ,like wise cultural diversity underpins sustainable development.

### References

- Abu-Zeid M. and Hamdy A. (2010) (eds). Encyclopedia on Water Resources Development and Management in Arid and Semi –Arid Regions of The Arab World.-Vol 13 Application of New technologies in Water Resources Management .
- ADIS Ababa Action Agenda (AAAA) (2015). [http://WWW.un.org/esa/ffd/wp-content/uploads/2015/08/AAAA\\_outcome.pdf](http://WWW.un.org/esa/ffd/wp-content/uploads/2015/08/AAAA_outcome.pdf)
- Chase Rory I., (1997). The Knowledge Base Organization: An International Survey. Journal of Knowledge Management . Vol I, Issue 1 pp 38.
- ECOSOC (United Nations Economic SOCIAL Council (2004). Promoting the application of science and technology to meet development goals contained In Millennium Declaration. Report of the Secretary. General of the 7th session of the Commission of Science and Technology for Development 24-28 May . Geneva . New York, ECOSOC.
- ECOSOC Annual Ministerial Review (2013). Science. Technology and Innovation for sustainable development .Back ground note 26 November 2012.
- Hamdy A. (2003). Capacity building in water resources sector : Human Resources Development . Rivista Bimestrale : Migrazioni, Risorse Technologie, Uomini E Donna Medio Oriente Nord Africa .ANm 111 ,No 3-4, Maggio , Agosto 2003.
- Hamdy A. and Sardo V. (2002). In sustain of sustainable agriculture . Proceedings of Joint UNU -UNESCO- ICARDA . Int. Workshop on Sustainable management of Marginal Dry Lands . Application of Indigenous knowledge for Costal drylands. Alexandria , Egypt 21-25 September 2002 PP 30-45.
- Hamdy A. and Trisorio Liuzzi G. (2004). Mediterranean climate changes :water related disasters and needed measures .New Medit Vol. 111 No.3 September 2004. Pp 20-27.
- Juma , C and Lee, Y.C. (eds) (2005). Innovation : Applying Knowledge for Development . A Report Of the UN Millenium Projects, s Task force on Science . Technology and Innovation. London Earth can. <http://www.unesco.org/science>.
- Metz B., Davidson R., Martens Q., Willem J., Rooijen, S.n.m.Van, Megrory van. Wie I., (2000). Methodological and Technological Issues in Technology Transfer. A special report of IPCC Working Group 111. Cambridge university
- OECD (2015A). Framework for policy coherence for sustainable development – A self-assessment tool to design ,implement and track progress of mutually supportive policies for sustainable development Preliminary Draft for discussion (2015).
- OECD (2015B). Daejeon Ministerial Declaration on Science ,technology and innovation policies for the global and digital age , 21 October 2015, oecd Dsti/STp/Min (2015 (<http://www.oecd.org/Science/sci-tec/Stiministerial-2015.htm>).
- Rio Earth Summit – The United NATIONS (1992). United Nations Conference on Environment and Development ( UNCED), Rio de Janeiro , £- 14 June 1992. Informal name the Earth Summit.

- Souter D. and MacLean (2012). Changing our understanding of sustainability : The impact of information and technologies and the internet. International Institute for sustainable development. Winnipeg.
- UNESCO (2007). Science, Technology and Gender: An International Report. Published in 2007 by the United Nations Educational, Scientific and Cultural Organization- Paris, France.ISBN 978-92-3-104072-6.
- UNESCO (2012). The power for culture for development (2010).
- UNESCO/SCIENTIFIC ADVISORY BOARD OF THE UN SECRETARY GENERAL(UNSGSAB) (2015). The crucial role of science and technology for sustainable development Agenda.9 JULY 2015.
- United Nations (2000). Un report on Technology Transfer Of ESTS for Climate Change. Intergovernmental Panel for climate change, FCCC, GENOVA United Nations (2015). The Un–SYSTEM Wide Action PLAN (SWAP9 System on The Rights of Indigenous People 2015.
- United Nations (2012). Un General assembly, the Future we want . A/Res/66/288, Resolution adopted by the General Assembly on 27 July 2012. <https://sustainabledevelopment.un.org/rio20futurewewant>.
- UN System Task Team (2011). Science, technology and innovation for sustainable development in the global partnership for development beyond 2015. UN System Task Team on the Post-UN 2015 Development Agenda.
- WCS World Confernce on Science (1999).Science Agenda – Framework for Action of World Conference on science .Science for the 21 st century .Budapest 26 June- 1 july . [www.unesco.org/science\(wcs/eng\).htm](http://www.unesco.org/science(wcs/eng).htm)

## ROLE OF TREES IN AGRICULTURAL LANDSCAPE

Ewa ZARAŚ-JANUSZKIEWICZ, Barbara ŻARSKA, Tatiana SWOCZYNA

Department of Environmental Protection, Faculty of Horticulture, Biotechnology and Landscape Architecture,  
Warsaw University of Life Sciences - SGGW, Poland

\*Corresponding author: ewa\_zaras-januszkiewicz@sggw.pl

### Abstract

Trees and shrubs as the buffer strips play an important role in the landscape, and can be supplemented, if necessary by different landscape structures. For landscape with inadequate or improperly disposed of woody vegetation should be introduced plantings row, belts or clumps. Because the way their location can and should be adapted to the needs of agriculture. The aim of the work was to define the role of trees in shaping the agricultural landscape. The field of research and observation were the fields surrounding the southern boundaries of Warsaw – The Wilanowskie Fields. Observations were made throughout the year. The structure and species composition of the trees were analyzed. On the basis of the observations and the map of potential vegetation, it was proposed to supplement the tree structure to one of the distinctive tree types.

**Keywords:** *Trees, bounds, buffer strip, landslides*

### Introduction

Afforestation, meaning concentrations of trees and shrubs, is an important instrument of protecting and forming agricultural environments, but manners of their introduction should be fitted for requirements of fields. An advantageous influence of afforestation on landscape, distribution from the viewpoint of functions, kind, form, manner of confounding were presented in this paper. It presents most important functions of afforestation in agricultural landscape, first of all, replenishing water in the environment, limiting the erosion of soil and enrichment of landscape.

The trees are primarily farmers' allies in the struggle for better yields. The farm produces a large functional whole with a possibly closed loop of matter. Looking at the countryside, it is necessary to evaluate in it elements such as the size and distribution of fields and the environment: rows, clumps or bushes and trees, watercourses and reservoirs, sequences of arable land and grassland and high woody vegetation, named meadfield trees. Good farming can not do without trees. They are particularly important in the non-forested area, poorly planted with poorly spaced forests, and in areas with light soils, with insufficient rainfall and limited groundwater and soil resources. Trees are an essential element of the landscape, stabilizing the conditions of agricultural production, as:

- they protect the fields from harmful winds on average 15-26%, maximum 50-70%,
- they contribute to the storage of water - they reduce the water loss caused by soil evaporation by an average of 25%, affect the soaking of the soil in the summer and in the winter of its freezing,
- they raise the humidity of the air in the ground layer, ie they increase the condensation of water vapor in the plants, on their surface and in the soil, also due to the greater amount of precipitation,
- limit wind erosion,

- limiting the water erosion, ie the surface runoff of water to the underground advantage which is particularly important in the rippled area,
- they reduce the daily air temperature fluctuations in this occurrence of spring frosts, raise the soil temperature to a depth of 20 cm on average by 0.2°C,
- they are a habitat for the life of many organisms, including useful ones, which help to combat crop pests (biodiversity).

Landslides, strips or clumps should be planted to the landscape with insufficient or inadequately placed vegetation. Since the way they are located can and should be adapted to the needs of agriculture, it should be regarded as the most important tree formation, especially in lowland woodlands.

### **Material and Methods**

The method chosen was:

- study of literature and basic materials concerning the role of trees in the shaping of the agricultural landscape and the role of trees in their functioning,
- field studies based on the implementation of dendrological species of general character - species and localization within the group structure, using the Braun-Blanquet method, general dendrological inventory was carried out with the definition of species composition, horizontal and vertical structure, phytosociological analysis; based on a map of potential and real vegetation, plant selection was made.

Parallel research has been carried out on literature related to the history of trees and shrubs in buffer strips at the borders of Polish research, their role in contemporary agriculture and field research related to the inventory of selected areas, the definition of species and the spatial structure. The study was carried out to formulate indications for the creation of field crops to improve landscaping and to create models that take into account landscaping guidelines.

Fields of field research were selected in the administrative boundaries of Warsaw – the Wilanowskie Fields.

The information collected was the first to implement the typology of trees and spatial structure. Then assigned tree groups were observed to a predetermined type. In the final phase, the spatial and species structure of the examined and observed group was supplemented according to the model developed for the specific tree type and selected species of trees and shrubs according to the habitat and potential vegetation map.

### **Results and Discussion**

Today, agricultural areas in Poland account for about 60%, and trees and shrubs are the most important environmental elements in such a landscape. They along with herbaceous vegetation form a network of exceptionally valuable microbes, which is particularly important in lowland areas, where forest stands are a substitute for forest (Budzyński, 1996).

In the open landscape - non-forested, special attention is given to small clusters of trees, small groves, reeds. The most important in the shaping of the natural balance are not the single trees, but those that form whole systems that connect to the forest surfaces (Bałazy and Ryszkowski, 2001).

In the structure of open and agricultural landscaping, field crops are always elements that fulfill many different functions. Their role to protect sediments and usable land from the destructive or cumbersome effects of climate factors has been appreciated for hundreds of years. The best example of this is the protected network of lines and streaks of trees lines and hedges in the Atlantic belt of Western European countries (Meiggs, 1989). In central Europe

plantings are usually used single or multi-tiered trees and shrubs established to protect crops, settlements, roads, wind, noise, dust (Jakubowski, 1994).

Already in the Baroque, roadside were planned. Avenue plantings stretched straight through the mountains and valleys, fulfilling a unique spatial function as a green belt separating the open landscape. Today, most of these belts have been removed by the widening of roads, withstood usually only those they are growing along local roads (Obmiński, 1975).

In Poland, Gen. Dezydery Chłapowski (1788-1879) was the pioneer. Napoleonic officer, General attending the November uprising, farmer worker who educated shelterbelts England. Chłapowski in the 20's the nineteenth century on the area of 10.000 ha introduced the band of buffer strips. These purposeful plantings of field plants were geared towards improving climatic conditions and reducing wind erosion. Today, this area, with tree-huts established is unique in the country and is located within the Agroecological Landscape Park, founded in 1992 (Ryszkowski and Bałazy, 1998).

### Forms, types and structure of trees buffer strips

The trees we distinguish depending on their location, the mutual arrangement of trees and bushes, and the shape and size of the area occupied. We can distinguish the following forms of trees:

**single** - formerly known as unit, loosely located in the open landscape single trees and shrubs (eg field pear), occupy little space;

**rows** - trees and bushes linearly arranged, planted in a single row, most commonly found in roadside and floodplains. They may be one or two sides;

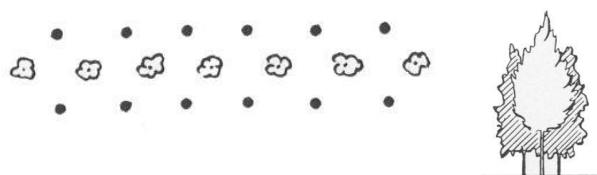


Figure 1. Rows (Hejmanowski, 1964, Meggis 1989).

**belts** - at least a 2-row width of trees not more 20 m (along rivers, near industrial plants);

**group** - cluster of trees and shrubs of any shape, with an area of no more than 0.02 hectares, in the group there are several of the same species (frequent on pasture) should be created in the land of agricultural land. The form is also a field fighter. Especially valuable as a living environment for many animals (birds, small mammals, insects);

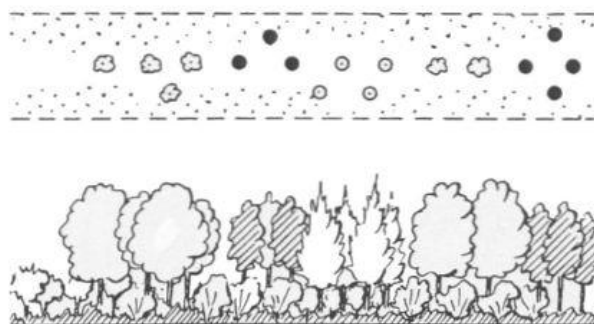


Figure 2. Group trees (Hejmanowski, 1964, Meggis 1989).

**clump** - trees where they are mixed together within one clump of any shape, the same species of trees, has the same biocenotic properties as grouped trees;

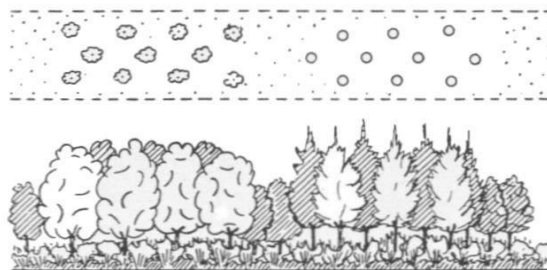


Figure 3. Clump trees (Hejmanowski, 1964, Meggis 1989).

**surface** - trees above 0.10 ha. Their optimum size is 2 ha. They are planted in fields of different species of trees and bushes, but due to the way they are managed they do not form a forest. They are a kind of refuge to provide shelter and food for many species of birds, mammals, insects (Hejmanowski, 1964).

### Structure of buffer strips

The structure of the tree plantings can be called by specifying the relative position relative to each other trees and shrubs in the vertical and horizontal directions. Branches can also be divided in terms of structure differentiation. We distinguish vertical and horizontal structure (Karg, Karlik, 1993):

- the vertical structure depends on the vegetation of the tree forming the tree,
- one-storey - the crowns of trees are situated at a similar level, there are no high altitude differences between them,
- two-storey - the trees form two non-overlapping crown layers,
- multi-storey - most often found in fertile habitats. There is a layer of trees, bushes acting as an undergrowth (their height can not exceed 5 m) and a fleece, which includes herbaceous plants and pods up to a height of 0.5 m (Obmiński, 1978).

Crowns of high, medium and low trees penetrate. In such trees, the aboveground space is better utilized (Karg, Kundziewicz, 1992).

Storeyed building of shelterbelts conforms them to the teams natural variety and brings valuable artistic elements to the landscape and contributes to better development in the same biocenosis plantings, as well as neighboring areas (Hejmanowski, 1964).

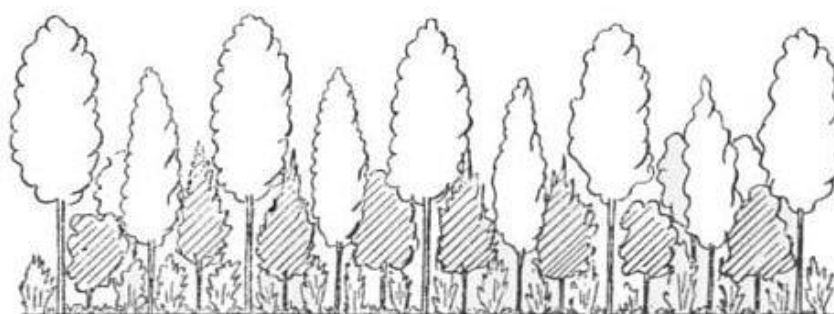


Figure 4. Buffer strip with multi-storey structure (Hejmanowski, 1964, Meggis 1989).

Horizontal structure - we can characterize it by the notion of space and distance.

Scantlings - refers to the group tree plantings, and the belt surface, can be regular with equal distances (eg. square, rectangular), or irregular; It should be dense, similar to that used for afforestation. Trees with a dense grove better fulfill the biocenotic and landscape functions. Distance - also known as the interval between components; It concerns single-row trees and hedges can be eg 0.8 m (Hejmanowski, 1964)

### **Buffer strips trees complexes**

Buffer strips trees complexes are well-functioning in terms of biocenosis in the environment, improving plastic values in the open landscape. The tree plant is characterized by one-storey construction, short-crowned trees, suitable species selection, which depends on the habitat and character of such a team. The species system should contain 90% of the primary species and 10% of the species. Shrubs in such bands serve as a lining, also serve as a border. Such teams can be created for all types of trees (Hejmanowski, 1964).

### **Hedges**

Shrubs and trees planted straggly to form hedges. Plants grow at low intervals and usually do not reach their maximum height. Hedge hedges should be compact hedges their branches grow up. In the hedges forming the field plants, their spatial structure is important, which should be adequate to the existing environmental conditions. Types of hedges:

- low hedges: not exceeding 2 m high, they are often low shrubs,
- high hedges: *Sambucus nigra*, *Cornus sanguinea*, *Corylus avellana*, *Rhamnus cathartica* (Kremer, 1997),
- trees hedges: *Fraxinus excelsior*, *Alnus glutinosa*, *Carpinus betulus* (Kremer, 1997).

Trees grow mostly in striped form surrounded by shrubs (Kremer, 1997).

Hedges emphasize terrain, are the determinant of space when it is divided. Hedges can have different functions: curtain walls, wind, snow (Jackowska, 2000).

The species composition of the tree is also divided by the number of species they form:

- single species - a tree that forms one species of tree or shrub irrespective of the floor and the number of varieties,
- multispecies - planting consisting of two or more species of trees, shrubs or trees and shrubs.

### **Buffer strips shaping**

In Poland in the nineteenth century, General Dezydery Chłapowski was the first to see the possibilities of shaping agricultural landscapes with the aid of field plants. He drew attention to their effect on wind erosion; he recommended planting protective plants from north and west, but alternating at a distance. He found that the foliage influenced the shaping of the local microclimate. They reduce the evaporation of water from the soil, and increase the humidity (Jackowska, 2000).

The problem of shaping of tree beds in the landscape should be treated comprehensively already at the stage of design and execution. Depending on the purpose we want to achieve, the trees have the required functions (Zajaczkowski, 2005).

Consider all environmental conditions. Forests are often not suitable for forestation. Rare species are also hardly ever used, but for biocenotic reasons, it is worthwhile to use them in small groups.

When creating whole tree-planting groups, it is important to keep in mind the possibility of using ornamental values of particular tree and shrub species. This is a task for landscape



architects, because artistic sense is important here. One can only give general guidelines that should guide the design of such trees:

- do not create monotonous and monotonous single-
- even multi-species trees, but with a large construction on a large surface will look monotonous,
- compositions will be mixed with doped trees and shrubs that can enhance decorative and biocenotic qualities,
- too many species with contrasting leaf colors or crowns, can create a droopy effect,
- too many alien species should be avoided,
- objects (roads, canals) running through forest areas should not be planted (the forest wall is sufficiently bordered);
- should not cut trees and bushes, they should maintain their natural habitat (Hejmanowski, 1964).

### **Selection of species of trees and shrubs**

The selection of trees should be adapted to the soil and climatic conditions of the habitat, and also for the purpose of the given tree. The tree that creates a natural combination of species is not only more resistant to external environmental conditions, but also more aesthetic and viable. Whereas selection does not necessarily have to be limited to plants from one substitute community, vegetation does not have to have the same species composition as the naturally occurring or semi-natural phytocenoses (Wysocki, Sikorski, 2000). Buffer strips should have such a species composition that their properties can fulfill specific functions. It must be taken into account that trees and shrubs will not be provided with care as they are planted in the city. Therefore vitality and resilience to adverse environmental conditions are important. Such characteristics are predominantly native species (Zajączkowski, 2005). When making selections also from plants of foreign origin, you need to know exactly what their requirements are, in their case no origin is taken into account, but the possibility to perform specific functions in the project of our plantation (Wysocki, Sikorski, 2000).

Native species planted in a suitable habitat are characterized by optimal growth, high health and well tolerated by unfavorable conditions. The pattern, therefore, should be planted spontaneously. The bushes that make the species physiologically consistent with the habitat are more resistant to external factors, are more vigorous and aesthetical, thus increasing the stability and resistance of all phytocenoses to unfavorable factors. Habitat requirements mainly concern fertility and humidity (Wysocki and Sikorski, 2002).

The selection should be based on native species that are better suited to our conditions, both habitat and climate. Introducing alien species to naturalistic plantings is quite risky. Selection of species for existing plants depends on ecological conditions and aims to improve their stability, climate and decorative features. Selection made on the phytosociological basis requires knowledge of the habitat.

I defined the habitat based on the map of potential vegetation. Its use in shaping the selection is necessary. Potential vegetation is an abstract state to which the vegetation in the area is tending. In phytosociological terms, it is simply an expression of habitat conditions. Knowing from the map the potential vegetation can roughly be defined, so the characteristics of the habitat. Habitats where, if not the final community, there are substitute communities within the circle of substitute communities. Their type depends on the external impact to which the subject is subject, eg cattle grazing, mowing, stripping (Wysocki, Sikorski, 2002).

Today's potential natural vegetation in the Wilanowskie Fields a hail subcontinental linden - oak - hornbeam (*Tilio - Carpinetum*) var. typical for central Poland (Wysocki, Sikorski, 2000, Matuszkiewicz, 2006).

Within the Wilanowskie Fields prevail phytocenoses shrubby, meadow, grassland and ruderal belong to the circle of communities foster hornbeam forests (*Tilio - Carpinetum*) and alluvial ash - alder (*Circaeo - Alnetum*) as a result of specific water conditions in podnuża slope (exudates), in depressions off-road, near ditches. Habitat is there a more moist, ground water comes up to almost the same surface.

State is a target species selected supplement composition woodlots (increase in species diversity), so that:

- improve their stability (also by increasing the area of the trees),
- structure,
- climatic function,
- decorative values.

The middlefield buffer strips are a bit like a forest border bordering the open field. There are two distinctly different environments here. Where the forest ends and a meadow or arable field begins, plants and animals from the forest and the agro-ecosystem meet. The mixed communities of trees and bushes can be considered as a very narrow and stretched form of forest consisting almost exclusively of the edge. There are many phenomena typical of the contact between the two environments. Trees are specific, they do not belong to forest communities or shrubs. They are a mosaic composition of fragments of forest vegetation, scrub and peat. So the choice should take that into account.

Species, trees and bushes, selected for bushes, and bushes from the *Pruno spinosae - Crataegum*, are the clans of the *Rhamno - Prunetea* Rivas Goday et Carb. 1961, from the forest shrub community and the association Berberidio Br.-Bl. (1947) 1950.

### **General characteristics of the buffer strips present in the Wilanowskie Fields**

Basing on Wysocki, Sikorski (2000) and Matuszkiewicz (2006) the buffer strips in the Wilanow Fields are relatively young planted. The dominant species are poplar species: *Populus tremula*, *Populus alba*, Willow ivy (*Salix caprea*). In the eastern part of the plots, many meadows that are not mown are overgrown with groves composed almost entirely of the birch (*Betula pendula*).

Clump-like foliage is made up of species such as various species of poplars and willows, *Pyrus pyraeaster*, *Crateagus monogyna*, and common woodpecker (*Padus avium*), *Tilia cordata*, *Quercus robur*, ash (*Fraxinus excesior*), black alder (*Alnus glutinosa*), are characteristic species of the gras.

The shallow bushes mainly produce species such as willow, poplar and black alder (*Alnus glutinosa*). In the southern part of the planted stripes mainly consists of white willow (*Salix alba*) with a mixture of ash (*Fraxinus excesior*). The rows of trees are poplar (*Populus nigra*), small-leaved lime (*Tilia cordata*). Many individual trees form monstrous multi-stage hawks (*Crateagus monogyna*) and *Quercus robur* L.

### **The buffer strips subdivision**

As a result of inventory during field work, the following tree sharing was made:

- hedges - trees in the form of small clumps and tight draws,
- trees - multi-row tree growing between the fields,
- row crops - single row trees on the road,
- watering - shrubs occurring at watercourses: canals and drainage ditches, where water is maintained all year round, trees that have an indirect belt or clump character,
- single middle fields trees.

### Characteristics of the existing state on one example

Tree lying in the north of the Wilanow Fields, a small tree consisting of a picturesque white willow. It grows at a small ditch, but not filled with water even in the spring.

Tree species: *Salix alba*.

The shrub layer represents the species: *Crataegus monogyna* (single-hawed horn) and *Sambucus nigra* (without black).

Climatic function: The tree is in the north-south direction and functions properly.

Habitat: fertile and with increased humidity at the ditch.

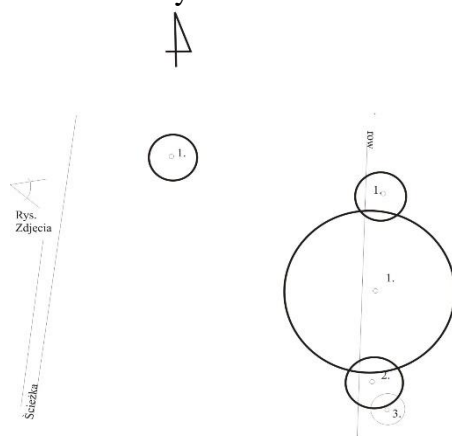


Figure 5. Top view – inventory.



Spring



Summer



Autumn

Figure 6. Photos of chosen buffer strip - clump in different seasons of the year.



Figure 7. Existing stay.



Figure 8. The status of the proposed selection.

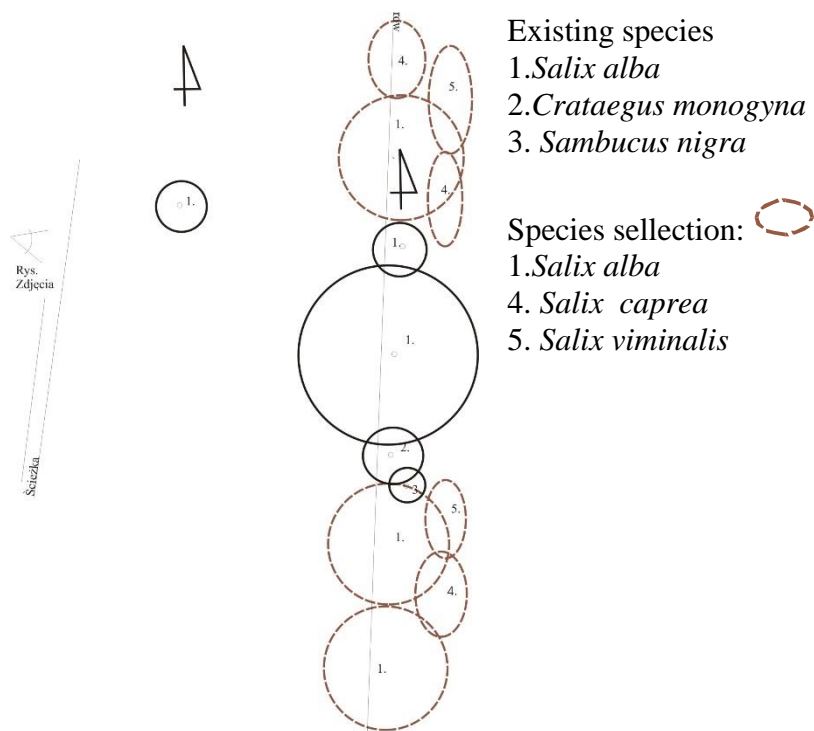


Figure 9. The status of the proposed selection.

## Conclusions

Lastly, it is important to add that there are different types of foliage between fields:

1. Single - single trees (solitaire), eg field pears or shrubs,
- 2 Rows - linearly arranged trees and shrubs, eg along roads,
3. Pulleys - a 20 m wide strip of breadth, eg along rivers or around plants,
4. Group - clusters of trees and shrubs of < 0.02 ha, eg pasture,
5. Clump - clusters of trees and bushes with an area of 0.02-0.1 ha, eg,
6. Surface - trees with an area of > 0.1 hectares, which due to the way of management do not constitute a forest, such as woodland wasteland.

Assuming and cultivating the foliage, one should know that:

- The tree index should be about 10 trees per hectare;
- Well-planted along watercourses and in the field;
- Plants should be planted firmly so that they do not bounce off the wind but absorb it (the most effective are 2 or 3-storey woods, forming the wall from the ground to the tree top);
- It is best if the trees are made up of species that are not intermediate hosts of pests and diseases of plants (eg beetle, cherry, buckthorn); Birch, ash, maple, lime, willow, poplar, as well as bushes such as black, hazel, crumb, plum or many others.

Shaping a buffer strip the instructions below must be realized:

1. Avoid creating single-layer trees, giving the impression of a template and monotony.
2. Trees, even multi-species, but with a template structure, on large spaces, especially on roads, are also monotonous.
3. The variety of wood-based can be contributed by the doped species as so-called. Interfering elements: their role may be double because they may be biocenotic species.
4. Avid species of contrasting colors and shapes should be avoided.
5. It would be advisable to avoid the use of too much exotic and exotic species in the woods; They can be reduced to barnyards and, if necessary, special plantations.
6. Objects such as roads, railways, rivers, canals, running through forest areas, should not be planted, since adjacent forest walls are aesthetically sufficient border.
7. The trees and shrubs in the trees should have a specific natural habit; Making them artificial shapes by crown molding or often, unfortunately propagated clipping hedges to give them forms of geometric bodies should not occur in the landscape.

## References

- Bałazy S., Ryszkowski L. (2001) Strukturalne i funkcjonalne charakterystyki krajobrazu rolniczego; w: Zeszyty Problemowe Postępów Nauk Rolniczych; Poznań
- Budzyński O. (1996) Zakładanie zadrzewień. Poradnik zadrzewieniowca województwa toruńskiego; Wydział Ochrony Środowiska Urzędu Wojewódzkiego: "Turpress".
- Hejmanowski J. (1964) Milewski J.; Terpiński Z.; Poradnik zadrzewieniowca; PWRiL; Warszawa
- Jackowska J. (2000) Żywopłoty wśród pól; Ogrody nr 4 (12); Prószyński i S-ka; Warszawa
- Jakubowski B. (1994) Zadrzewienia śródpolne; Fundacja Greek Park; Warszawa
- Karg J. Kundzewicz Z. (1992) Wstępna ocena wpływu ekotonu na wielkość biomasy owadów epigeionu w agroekosystemach. [in]: Produkcja pierwotna, zasoby zwierząt i wymywanie materii organicznej w krajobrazie rolniczym. Bałazy S., Ryszkowski L.(eds.); Zakład Badań Środowiska Rolniczego i Leśnego PAN; Poznań
- Karg J., Karlik B. (1993) Zadrzewienia na obszarach wiejskich; Zakład Badań Środowiska Rolniczego i Leśnego PAN; Poznań

- Matuszkiewicz Wł. (2006). Przewodnik do oznaczania zbiorowisk roślinnych Polski. PWN, Warszawa
- Meiggs R. (1989) Farm forestry In the ancient Mediterranean; Social Forestry Network; Network Paper 8b.
- Obmiński Z. (1971) Fizjocentryczne znaczenie zadrzewień i drogi jego optymalizacji warunkach przyrodniczo geograficznych Polski; Referat na III Międzynarodową Konferencję Fitomelioracyjną; Warszawa 1971.
- Ryszkowski L., Bałazy S. (1998); Kształtowanie środowiska rolniczego na przykładzie Parku Krajobrazowego im. Gen. Chłapowskiego; Zakład Badań Środowiska Rolniczego i Leśnego PAN; Poznań.
- Witt R. (1997) Przewodnik: Krzewy; Multico; Warszawa 1997.
- Wysocki Cz., Sikorski P. (2000) Zarys fitosocjologii stosowanej; Wydawnictwo SGGW; Warszawa.
- Zajączkowski K. (2005) Regionalizacja potrzeb zadrzewieniowych w Polsce; IBL; Warszawa.

## MERCURY BELONGS TO HEAVY METALS WITH A NEGATIVE IMPACT ON THE ENVIRONMENT

Hanna JAWORSKA\*, Joanna NOWAK, Katarzyna MATUSZCZAK

Department of Soil Science and Soil Protection, Faculty of Agriculture and Biotechnology, UTP University of Science and Technology in Bydgoszcz, 85-029 Bydgoszcz, Bernardyńska 6 St.

\*Corresponding author: hanna.jaworska@utp.edu.pl

### Abstract

Mercury does not undergo the biodegradation, so it persists in the environment for a long period of time. It is easily soluble in soils and is able to migrate deep into the profile. Mercury and its organic compounds are included in various specimens such as plant protection products, fungicides and phosphorous fertilizers ( $0,01-1,2 \text{ mg Hg}\cdot\text{kg}^{-1}$ ) and nitrogenous fertilizers ( $0,01-1,2 \text{ mg Hg}\cdot\text{kg}^{-1}$ ). The aim of these studies was the assessment of the mercury content in soils with intensive agricultural impact. The research was carried on soil samplers originated from plough land after using nitrogenous fertilizers and manure. Soil samples were obtained from four corners and from the middle of  $10 \times 10$  research area and, then, a mixed sample was created. Samples were obtained from two depths -0-20 cm and 20-40 cm. In samples obtained with that technique the texture was marked using the laser method, organic carbon content using the carbon analyzer and nitrogen, pH by the potentiometric method in the KCl solution with  $1 \text{ mol}\cdot\text{dm}^{-3}$  concentration and  $\text{H}_2\text{O}$ ,  $\text{CaCO}_3$  using Scheibler's method, mercury using AMA 254 analyzer, statistic analysis Statistica 12.0. On the basis of the texture analysis examined soils were ranked among sandy loam. Content of fraction  $\phi < 0.002 \text{ mm}$  was ranged between 3.93-5.19%. They were distinguished by C org. content within range  $1.79-7.2 \text{ g}\cdot\text{kg}^{-1}$  and  $\text{pH}_{\text{KCl}}$  within range 6.02-7.72. Mercury contents were within range  $17.72$  to  $30.55 \mu\text{g}\cdot\text{kg}^{-1}$ . Mercury contents were balanced in examined soils. In spite of the established mercury with fertilizers, the concentration growth was not declared in the examined soils.

**Keywords:** *agricultural soil, mercury, nitrogen fertilizers*

### Introduction

Toxic elements such as mercury are natural components of earth's crust. Modernly it may be stated, that the amount of mercury in soils is 2-3 times higher than in pre-industrial era (Monteiro, 1995). World annual emission of this metal is in range from 4400 to 7500 tons (Wojnar, 2006). The average content of mercury in atmosphere is in range from  $1,2 \text{ ng}\cdot\text{m}^{-3}$  to  $4,0 \text{ ng}\cdot\text{m}^{-3}$  (Szykowska 2003). The average content of mercury in European soils is estimated at the level of  $0.02-0.15 \text{ mg}\cdot\text{kg}^{-1}$  (Freedman, 1989; Mihaljevič, 1999). The content of this element in surface horizon of soils located in undeveloped areas in Europe is  $0,037 \text{ mg}\cdot\text{kg}^{-1}$  (Salminen, 2005). Plants absorb mercury directly from the soil as well as from the air. Absorbed amounts mostly depends on the form of occurrence of this element, but also on the species of absorbing plant (Malczyk and Dąbkowska-Naskręt, 2001). The use of mineral and organic fertilizers provides delivery of essential nutrients to the soils. It also causes delivery of usually toxic and undesirable heavy metals and trace elements to soils. The content of mercury in phosphoric fertilizers ranges from  $0,01$  to  $1,2 \text{ mg}\cdot\text{kg}^{-1}$ , while in nitric fertilizers ranges from  $0,3$  to  $3,0 \text{ mg}\cdot\text{kg}^{-1}$ . Usually responsible for the amount of this element

in nitric fertilizers is ammonium sulfate (VI). In Poland phosphoric fertilizers originates mostly from phosphorites and apatites. Mercury also occurs in agriculture as a supplement to seed mortars and plant protection products. The main factors contaminating agroecosystems are: industrial waste, insecticides, herbicides, mineral fertilizers originated from contaminated deposits (Filipek, 2003; Kopeć and Gonddek, 2009).

The aim of the study was to estimate the content of mercury in soils, after the application of organic and mineral and fertilizer plant protection products.

### Materials and methods

Research material was collected from soils from agricultural soils from the village of Kościerzyn Wielki (Poland) with the following geographical coordinates 53° 12' 39" N, 17° 15' 34" E . The material was collected in October 2016 during 2 days of outdoor work. Soil samples were obtained from four corners and from the middle of 10 x 10 research area and, then, a mixed sample was created. Soil samples were collected at 11 points. Samples were obtained from two depths -0-20 cm and 20- 40 cm (Fig.1).

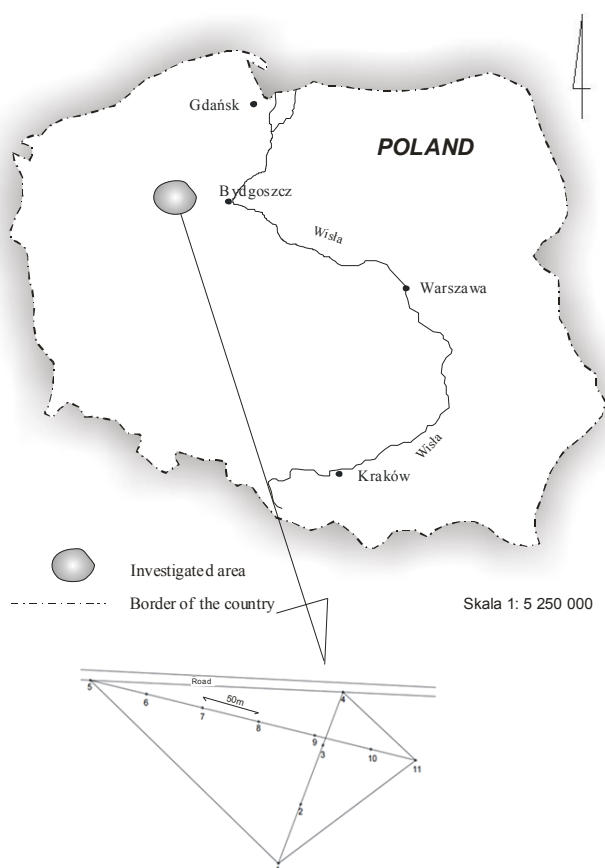


Fig. 1 Location of research points



In the air-dried soil samples, crushed and passed through a 2-mm sieve, the following analysis was conducted: pH using a glass electrode in a 1:5 (by volume) suspension of soil in deionized water (pH in H<sub>2</sub>O) and again in 1 M potassium chloride solution (pH in KCl) (ISO 10390: 2005), total organic carbon content (TOC) using the carbon analyzer and nitrogen, carbonate content in calcimeter according to the volumetric Scheibler's method, soil texture by laser diffraction method using a Mastersizer 2000E (ISO11277:2009) and mercury using AMA 254 analyzer. Statistical analysis of the results was calculated in the Statistica 12.0 for Windows PI software. All analyses were conducted in three replicates and the validation of the results was based on the certified materials (reference soil sample TILL-3 and SO-4 (Canada Centre for Mineral and Energy Technology). The following organic and mineral fertilizers were used on researched soils: ammonium nitrate, urea, bovine manure.

### Results and discussion

The analysis of texture allowed classification of the investigated soils into sandy loam (USDA 2016). The percentage of sand ( $\phi$  2.0-0.05 mm) ranged from 55.37 to 62.18 %, silt ( $\phi$  0.05-0.002 mm) from 33.52 to 42.93 % and clay ( $\phi$  < 0.002 mm) from 3.96 to 5.19 % (Table 1).

Table 1. Percentage of fraction in diameter [mm]

No	Depth [cm]	Texture [%]		
		2.0-0.05 [mm]	0.05-0.002 [mm]	<0.002 [mm]
1.	0-20	55.37	40.41	4.22
	20-40	52.66	42.93	4.41
2.	0-20	56.96	38.77	4.27
	20-40	55.47	39.71	4.82
3.	0-20	58.72	36.61	4.67
	20-40	56.94	37.96	5.1
4.	0-20	57.65	37.69	4.66
	20-40	54.23	40.81	4.95
5.	0-20	59.62	36.63	3.96
	20-40	59.41	36.29	4.1
6.	0-20	59.83	35.69	4.48
	20-40	58.6	36.76	4.64
7.	0-20	62.18	33.52	4.3
	20-40	58.67	36.59	4.74
8.	0-20	59.96	35.33	4.71
	20-40	59.00	36.15	4.85
9.	0-20	59.39	35.84	4.78
	20-40	59.87	35.46	4.67
10.	0-20	57.25	37.97	4.78
	20-40	57.12	37.69	5.19
11.	0-20	54.62	41.37	5.01
	20-40	53.39	40.51	5.1

The granulometric composition affects the transformation of Hg in soils, which is related to the amount of clay material [Boszke et al., 2004]. The content of total organic carbon (TOC) ranged from 1.79 to 7.2 g kg<sup>-1</sup> in surface samples and from 0.76 to 6.05 g kg<sup>-1</sup> in subsurface samples. In the analysed samples pH<sub>H<sub>2</sub>O</sub> ranged from 6.46 to 7.73, while pH<sub>KCl</sub>

from 6.02 to 7.62 in surface samples and  $\text{pH}_{\text{H}_2\text{O}}$  ranged from 6.57 to 7.8, while  $\text{pH}_{\text{KCl}}$  from  $\text{pH}$  6.01-7.72 in subsurface samples. These are worths typical for soils i the researched area. (Wiśniewski and Wojtasik 2014). The content of  $\text{CaCO}_3$  ranged from <1% to 9.3% (Table 2).

Table 2. Selected physicochemical properties and total content of Hg of soils

No	Depth [cm]	TOC [ $\text{g}\cdot\text{kg}^{-1}$ ]	pH		$\text{CaCO}_3$ [%]	Hg [ $\mu\text{g}\cdot\text{kg}^{-1}$ ]
			H <sub>2</sub> O	KCl		
1.	0-20	6.95	7.53	7.46	<1%	29.68
	20-40	4.33	7.29	7.24	<1%	29.05
2.	0-20	6.05	7.57	7.49	51.65	24.83
	20-40	1.79	7.59	7.57	60.28	23.54
3.	0-20	3.69	6.73	6.11	<1%	18.10
	20-40	3.50	6.57	6.01	<1%	17.92
4.	0-20	2.36	7.72	7.62	65.24	19.46
	20-40	1.74	7.80	7.72	78.44	21.41
5.	0-20	7.20	6.57	6.05	<1%	28.33
	20-40	5.95	6.75	6.21	<1%	30.55
6.	0-20	1.97	7.73	7.57	74.59	23.71
	20-40	1.50	7.58	7.40	56.20	24.95
7.	0-20	3.68	6.76	6.35	<1%	24.43
	20-40	3.64	6.78	6.43	<1%	24.76
8.	0-20	3.00	6.79	6.25	46.03	17.72
	20-40	2.81	7.15	6.82	93.20	17.74
9.	0-20	1.48	6.70	6.22	90.94	19.29
	20-40	0.76	6.80	6.25	46.72	17.73
10.	0-20	2.60	6.78	6.53	83.10	20.84
	20-40	2.53	6.72	6.36	44.71	20.58
11.	0-20	4.80	6.46	6.02	<1%	28.61
	20-40	4.46	6.72	6.39	<1%	27.71

The total content of mercury in analysed soils was ranged from 17.72 to 30.55  $\mu\text{g}\cdot\text{kg}^{-1}$ . In surface samples content of total Hg ranged from 17.74 to 29.69  $\mu\text{g}\cdot\text{kg}^{-1}$  and from 17.72 to 30.55  $\mu\text{g}\cdot\text{kg}^{-1}$  in subsurface samples (Table 2). The highest values were determined in surface horizons. were significantly enriched in organic matter. It is commonly known that the crucial parameter in mercury transformation in the environment is the content of organic matter (Dmytriw et al. 1995; Henderson et al. 1998).

Statistical analysis of the obtained results confirms this dependence. The simple correlation analysis allowed to state a significant positive correlation between the content of mercury and the content of C-org. (Table 3).

Table 3. Corelation

Corelation	Clay fraction	pH H <sub>2</sub> O	pH KCl	TOC $\text{g}\cdot\text{kg}^{-1}$
Mercury	- 0.48203	0.051389	0.126466	0.659096

According to Polish Minister of the Environment Regulation (1.08.2016).concerning soil quality standards and earth quality standards the analyzed soils were classified as not

contaminated with mercury. Currently in Poland on the basis of the Regulation of the Minister of Agriculture and Rural Development (2008), the amount of contaminating components in organic and mineral fertilizers and in plant growth aids cannot be higher than 2 mg Hg.

Determination of natural mercury content in soils is difficult to estimate due to the presence of anthropogenic contaminants. Concentration its form and transformations depends on many factors such as the quantity and quality of soil colloids, surface area, pH, sorption capacity, redox conditions or microbial activity. The main properties that lead to transformation of this element in soils are affinity to sulfur compounds, organic matter and volatile properties of elemental form (Yin et al., 1996). Distribution of mercury was mainly the result of anthropopression. Alkaline conditions and low organic matter content in studied soils favoured the retention of Hg species by soil. Furthermore, low organic matter content decreases the formation of soluble organic complexes (Lafont et al. 2013).

Mercury contents were balanced in examined soils. In spite of the established mercury with fertilizers, the concentration growth was not declared in the examined soils.

### **Conclusion**

The total content of mercury in the investigated arable soils ranged from 17,72 to 30,55  $\mu\text{g}\cdot\text{kg}^{-1}$ . In the surface horizon the content of this element ranged from 17,74 to 29,69  $\mu\text{g}\cdot\text{kg}^{-1}$ , and in subsurface horizon from 17,72 to 30,55  $\mu\text{g}\cdot\text{kg}^{-1}$ . These values are normal for the occurrence of this element in soil, which does not eliminate this soil from the agricultural use. It needs to be stated that the use of plant protection products and mineral and organic fertilizers does not influence the content of mercury in soils from the investigated area.

### **References**

- Boszke L., Kowalski A., Siepak J. (2004). Grain size partitioning of mercury in sediments of the middle Odra River (Germany/Poland). *Water Air Soil Pollut.* 159.
- Dmytriw R., Mucci A., Lucotte M., Pichet P. (1995). The partitioning of mercury in the solid components of dry and flooded forest soils and sediments from a hydroelectric reservoir, Quebec (Canada). *Water, Air, & Soil Pollution* 80: 1099-1103.
- Filipek T. (2003). Toxic elements (Cd, Pb, Hg, As) in soils and plants with respect to their acceptable levels in fertilizers and deacidifiers. *Chemist* 11: 334-352.
- Freedman B. (1989). *Environmental ecology*. Academic Press. Inc. San Diego, California.
- Henderson P. J., MCMartin I., Hall G. E., Percival J. B., Walker D. A. (1998). The chemical and physical characteristics of heavy metals in humus and till in the vicinity of the base metal smelter at Flin Flon, Manitoba, Canada. *Environmental Geology* 34: 39-58.
- ISO 11277 (2009.) Soil quality—determination of particle size distribution. in mineral soil material—method by sieving and sedimentation.
- ISO 10390 (2005) Soil quality - Determination of pH.
- IUSS Working Group WRB (2016) World Reference Base for Soil Resources 2016. International soil classification system for naming soils and creating legends for soil maps. World Soil Resources Reports No. 106. FAO, Rome.
- Kopeć M., Gondek K. (2009). Content of mercury in green mountain plants (Black Potok) after 40 years of diversified mineral fertilization. *Environmental Engineering* 21: 7-14.
- Lafont D., Soulages O.E., Acebal S.G., Bonorino A.G. (2013). Sorption and desorption of mercury(II) in saline and alkaline soils of Bahía Blanca, Argentina. *Environmental Earth Sciences* 70, 3: 1379-1387.

- Malczyk P., Dąbkowska-Naskręt H. (2001). Methodological studies on the determination of total mercury content in soils and plant material. *Acta Agrophysica*, 56: 165-171.
- Mihaljevič M. (1999). Mercury. [In]: *Encyclopedia of geochemistry* (eds. C.P. Marshall, R.W. Fairbridge): 387–389. Kluwer Academic Publishers.
- Monteiro L., Furness R. (1995). Seabirds as monitors of mercury in the Marine environment. *Water Air Soil Pollut.* 80:915-921.
- Regulation of the Minister of Agriculture and Rural Development of 18 June 2008 on implementation of certain provisions of the Act on fertilizers and fertilizers (Journal of Laws 2008, no.119,765).
- Regulation of the Minister of the Environment dated 1 September 2016 on assessment procedures for the land surface pollution. (Regulation No. 1395).
- Salminen R. (2005). *Geochemical Atlas of Europe. Part 1. Geol. Survey of Finland, Espoo.*
- Wiśniewski P., Wojtasik M. (2014). Variability of arable and forest soils properties on eroded slopes. *Environmental Engineering*. 39: 198-208.
- Wojnar K., Wisz J. (2006). Mercury in the Polish power industry. "Energetics" - April 2006.
- Yin Y., Allen H.E., Li Y., Huang C. P., Sanders P. F. (1996). Adsorption of mercury (II) by soil: Effect of pH, chlorine, and organic matter. *J. Environ. Qual.* 25: 837-844.

## COMPARISON OF MEASURED AND SIMULATED EC OF SOIL WATER IN RELATION WITH IRRIGATION WATER SALINITY AND LEACHING RATIO

Engin YURTSEVEN<sup>1\*</sup>, M. Sevba ÇOLAK<sup>1</sup>, Sertan AVCI<sup>1</sup>, Hasan S. ÖZTÜRK<sup>2</sup>, Ahmet ÖZTÜRK<sup>1</sup>, Jiri ŠIMŮNEK<sup>3</sup>

<sup>1</sup>Department of Farm Structures and Irrigation, Faculty of Agriculture, University of Ankara, 06110 Dışkapı, Ankara, Turkey

<sup>2</sup>Department of Soil Science and Plant Nutrition, Faculty of Agriculture, University of Ankara, 06110 Dışkapı, Ankara, Turkey

<sup>3</sup>Department of Environmental Sciences, University of California, Riverside, CA 92521, USA

\*Corresponding author, yurtsev@ankara.edu.tr

### Abstract

The soil salinity which affects the plants is the soil water salinity i.e. the EC of soil water absorbed by soil particles which remains within the soil components against the gravity forces, not the EC of soil water extract which is the excess water added to the soil to fill the gaps in the soil volume. In this study the soil water was extracted from the soil after the irrigation practices by using suction probes which were situated at 20, 40, 60 and 80 cm depth of soil columns and the salinities were measured by EC meter (YSI3200), and analyzed Cl<sup>-</sup> by using ion chromatography (Dionex 1600) system. On the other hand, the EC of soil water was simulated by using HYDRUS-1D mathematical model for the same depths of soil and for the same irrigation times.

Experiments were conducted in 40 cm diameter and 115 cm depth soil columns using with 5 irrigation water salinities (0.25-control, 1.5 and 3.0 dS m<sup>-1</sup> with NaCl+CaC<sub>2</sub> and with NaCl+CaSO<sub>4</sub> salts), and two leaching fractions (15% and 35%) with initially saline silty-clay (EC<sub>e1/2</sub>=1.9 dS m<sup>-1</sup>) soil.

The results were evaluated using MAE, RMSE, RE, and R<sup>2</sup>. Results showed that the HYDRUS-1D simulations were significantly close to the measured salinity and Cl<sup>-</sup> values and thus HYDRUS-1D simulations can be used successfully for determining the soil salinity and Cl<sup>-</sup> changes due to the irrigation water salinity and leaching fractions in sandy-loam soils.

**Keywords:** *Hydrus-1D, irrigation water salinity, movement of salts, lysimeters*

### Introduction

Irrigated agriculture is by far the greatest user of water on earth. The limits to the availability of land, and especially of water, necessitate the careful use of these resources, particularly the efficient use of water in irrigation.

In arid and semi-arid climate throughout the world, in irrigated areas, salinization is the most widespread problem, due to the presence of various ions in irrigation water. Salinization generally occurs when salts accumulate in the soil profile at a hazardous level, depending on the relationship between irrigation applied, precipitation, evapotranspiration, and leaching fraction. When the concentration of salts exceeds a level harmful for crops, yields decrease. It is inevitably that some salts accumulate in the root zone since all waters used for irrigation contain soluble ions. The higher the content of salts in irrigation water, the faster the process of soil salinization. Evaporation and transpiration are the predominant mechanisms causing the accumulation of salts in irrigated soils. Both evaporation and transpiration processes remove water from the soil, while leaving salts behind and increasing their concentrations in

the remaining soil water. Therefore, the higher the evaporation and/or transpiration rates, the faster the soil salinization (Corwin et al., 2007; Gonçalves et al., 2006).

Salinity restrains root water uptake of plants by increasing the osmotic pressure in soil water. Thus making it more difficult for plants to extract water from the soil. Some components of salinity may cause specific-ion toxicity and imbalance the nutritional stability of plants. In addition, the salt composition of soil water influences the composition of cations in the exchange complex of soil particles, which may significantly influence soil permeability and tilth (Yurtseven and Sönmez, 1992; Corwin et al., 2007).

Soils not only contain a mixture of salts, but the distribution of these salts is not uniform spatially, nor constant with a soil depth and/or time (Hoffman and van Genuchten, 1983). Excessive salts accumulated in soil profiles of irrigated lands can be leached out by adding more water than required to meet the evapotranspiration needs of the crops. The ratio of additional irrigation water, with respect to evaporation and transpiration, is usually expressed as a leaching fraction (*LF*) or a leaching requirement (*LR*), which are identical mathematical expressions, but with different meanings (USSL Staff, 1954; Rhoades, 1974).

Many methods are available to determine the impact of irrigation water quality and existing farm irrigation management in soil salinity. The most precise assessment of salinity is taking soil samples and carrying out laboratory analyses of salinity and its components using several types of laboratory instruments and methods. However, classical methods of evaluating soil salinity are time demanding, expensive, and require a lot of effort, yet cannot completely cover the spatial and temporal variability at the field scale (Rasouli et al., 2012).

Mathematical models that can consider various soil, climate, and crop factors have been suggested as useful tools for evaluating the optimum management strategies for saline conditions (Ramos et al., 2011; Rasouli et al., 2012). A variety of analytical and numerical models have been developed during the past several decades to predict water and solute transfer processes between the soil surface and groundwater table. The HYDRUS-1D software package (Šimůnek et al. 2008) is one of such models simulating water movement and solute transport in the soil. The objective of this study is to use HYDRUS-1D to analyze salinity changes and solute transport in soil columns irrigated with waters of different quality at different leaching rates and to assess its applicability for practical applications.

## Material And Methods

The experiment was held in Ankara University Agricultural Faculty Campus, between June 9th and September 16th with sunflower. Lysimeters were set up with corrugated PVC tubes of 40 cm diameter and 115 cm height. The soil, was provided from the top 20-60 cm profile of the surrounding cultivated area and sieved and put into lysimeters in equal amounts according to their bulk density. The soil used was sandy-loam and its bulk density is  $1.35 \text{ g cm}^{-3}$ , its pH is 8.03, its EC<sub>p</sub> (at 1:2 saturation) is  $1.92 \text{ dS m}^{-1}$ , its field capacity is 25.1%, and its wilting point is 15.2%. The sunflower used was “Meriç” which is an original variety from Turkey.

A total of 45 lysimeters with 5 salinity levels and 3 irrigation amounts as treatments with 3 replications were used. Experiments were conducted as a factorial experiment in fully randomized design. Irrigation water salinity levels were  $S_1$ =top water ( $0.25 \text{ dS m}^{-1}$ ),  $S_2$ = $1.5 \text{ dS m}^{-1}$  NaCl+CaCl<sub>2</sub>,  $S_3$ = $3 \text{ dS m}^{-1}$  NaCl+CaCl<sub>2</sub>,  $S_4$ = $1.5 \text{ dS m}^{-1}$  NaCl+CaSO<sub>4</sub>·2H<sub>2</sub>O and  $S_5$ = $3 \text{ dS m}^{-1}$  NaCl+CaSO<sub>4</sub>·2H<sub>2</sub>O. Irrigation water was applied with a limited irrigation (75% of required amount) and with leaching fractions of 115% ( $L_{15}$ ) and 135% ( $L_{35}$ ). Drainage water was collected from the cups which were previously put at the bottom of lysimeters.

The experiment was completed with 8 irrigations during growing season with the usage of 40% of available soil water. EC measurements were taken with ECmeter (YSI-3200)

according to USSL (1954). The anion analysis were taken via ion chromatography (DIONEX IC-1600) apparatus according to Anonymous (1993).

To collect the soil solution samples, 4 suction probes were put into the lyzimeters at the depths of 20, 40, 60, and 80 cm, with leaching treatments of L<sub>15</sub> and L<sub>35</sub>, and the samples were taken during irrigation. The results were than compared with those obtained by running HYDRUS-1D simulation model.

The HYDRUS-1D program numerically solves the Richards equation for variably-saturated water flow and the convection-dispersion equation for heat and solute transport. The program may be used to analyze water and solute movement in unsaturated or fully saturated porous media.

This study used the UnsatChem module (Šimůnek and Suarez, 1994) of the HYDRUS-1D software package (Šimůnek et al., 2008), simulating the major ion chemistry/transport and carbon dioxide transport.

In addition to a visual check, field measured values were compared with the results of the HYDRUS-1D simulations using the mean absolute error (*MAE*), the root mean square error (*RMSE*), and the relative error (*RE*) which are defined as follows;

$$MAE = \frac{1}{N} \sum_{i=1}^N |O_i - P_i| \quad (3)$$

$$RMSE = \sqrt{\frac{\sum_{i=1}^N |O_i - P_i|^2}{N-1}} \quad (4)$$

$$RE = \frac{RMSE}{Obs_{avg}} \quad (5)$$

where  $O_i$  and  $P_i$  are observed and model-predicted values in units of a particular variable,  $N$  is the number of observations, and  $Obs_{avg}$  is the mean observed value. In general,  $RMSE \geq MAE$ . The degree at which the  $RMSE$  value exceeds  $MAE$  is usually a good indicator of the presence and extent of outliers, or the variance of the differences between the modeled and observed values (Legates and McCabe, 1999; Kobayashi and Salam, 2000).  $RE$  was used to evaluate the quality of the  $RMSE$  value. The simulation is considered to be excellent when a relative error is less than 10%, good if it is greater than 10% and less than 20%, fair if it is greater than 20% and less than 30%, and poor if it is greater than 30% (Loague and Green, 1991).

## Results And Discussion

In this study the soil salinity (EC) and  $Cl^-$  results were taken into consideration and compared with the HYDRUS-1D simulation values due to EC being the main parameter to explain total soil salinity and  $Cl^-$  being the most movable, i.e., leachable ion in the soil. Statistical parameters enabling us to evaluate the HYDRUS-1D modelling results for EC and  $Cl^-$  are given in Table 1, according to the treatments.

Generally,  $RMSE$  values were greater than  $MAE$  values. Conversely  $RE$  values were variable. The  $RE$  values are for 20 cm depth between 0.07-0.22, for 40 cm depth between 0.83-1.06, for 60 cm depth between 0.99-1.36 and for 80 cm depth between 0.03-0.49. The small values show that the measured and simulated values are consistent (Yurtseven et al 2013).

Table 1. The modelling statistics for EC and Cl<sup>-</sup> values

		S <sub>1</sub> L <sub>2</sub>			S <sub>1</sub> L <sub>3</sub>			S <sub>2</sub> L <sub>2</sub>			S <sub>2</sub> L <sub>3</sub>			S <sub>3</sub> L <sub>2</sub>		
		MAE	RMSE	RE	MAE	RMSE	RE	MAE	RMS E	RE	MAE	RMSE	RE	MAE	RMSE	RE
Cl	20 cm	0.25	0.29	0.19	0.25	0.30	0.19	1.75	2.08	0.19	1.85	2.49	0.19	2.20	3.25	0.11
	40 cm	0.44	0.91	0.91	0.56	0.90	0.80	14.84	20.61	1.06	4.80	8.18	0.85	9.22	19.61	0.96
	60 cm	0.57	1.10	1.31	0.60	1.06	1.07	10.90	15.49	1.16	5.17	9.34	1.21	11.09	23.27	1.36
	80 cm	0.12	0.13	0.12	0.17	0.22	0.16	7.10	10.41	0.96	0.21	0.26	0.03	2.17	3.63	0.15
EC	20 cm	0.05	0.07	0.18	0.03	0.04	0.09	0.11	0.14	0.24	0.06	0.07	0.14	0.22	0.25	0.37
	40 cm	0.14	0.27	0.81	0.15	0.30	0.88	0.18	0.31	0.82	0.18	0.31	0.83	0.22	0.33	0.81
	60 cm	0.16	0.31	1.01	0.17	0.35	1.32	0.17	0.35	1.31	0.17	0.35	1.32	0.23	0.37	1.15
	80 cm	0.09	0.13	0.27	0.03	0.04	0.10	0.06	0.08	0.20	0.08	0.10	0.23	0.07	0.09	0.21
		S <sub>3</sub> L <sub>3</sub>			S <sub>4</sub> L <sub>2</sub>			S <sub>4</sub> L <sub>3</sub>			S <sub>5</sub> L <sub>2</sub>			S <sub>5</sub> L <sub>3</sub>		
Cl	20 cm	1.30	2.15	0.07	0.35	0.52	0.14	0.23	0.31	0.09	1.66	2.63	0.22	1.75	2.19	0.18
	40 cm	9.47	18.85	0.88	1.17	2.29	0.91	1.01	2.18	0.91	4.33	7.38	0.87	4.21	7.07	0.83
	60 cm	10.71	22.35	1.22	1.42	2.75	1.28	1.34	2.63	1.17	4.39	8.59	1.29	4.49	8.27	1.14
	80 cm	2.90	4.14	0.15	0.22	0.28	0.10	0.24	0.32	0.10	1.25	1.86	0.20	2.05	2.98	0.27
EC	20 cm	0.41	0.48	0.55	0.04	0.05	0.09	0.04	0.05	0.10	0.21	0.37	0.54	0.18	0.24	0.37
	40 cm	0.40	0.48	0.80	0.17	0.31	0.85	0.18	0.31	0.84	0.23	0.36	0.86	0.25	0.37	0.84
	60 cm	0.41	0.50	0.99	0.19	0.36	1.25	0.22	0.36	1.17	0.31	0.48	1.19	0.28	0.40	1.09
	80 cm	0.19	0.23	0.42	0.05	0.06	0.15	0.10	0.13	0.30	0.21	0.27	0.49	0.12	0.20	0.42

The graphics of measured and simulated EC and Cl<sup>-</sup> values for 1st, 3rd, 5th, and 7th irrigation applications are shown in figures 1, 2, 3, 4, and 5. In all graphics, the measured and simulated values of EC and Cl, showed to be in sync, i.e., there was a good compatibility. In other



words, HYDRUS-1D simulated the EC and Cl values very closely to that of the measured values.

Measured and simulated values compared with the  $R^2$  (coefficient of determination) statistic as well. This  $R^2$  statistics for EC and  $Cl^-$  are given in Table 2. Generally, the  $R^2$  were considerably high, the average value for EC was 0.826, and the average value for  $Cl^-$  was 0.952.

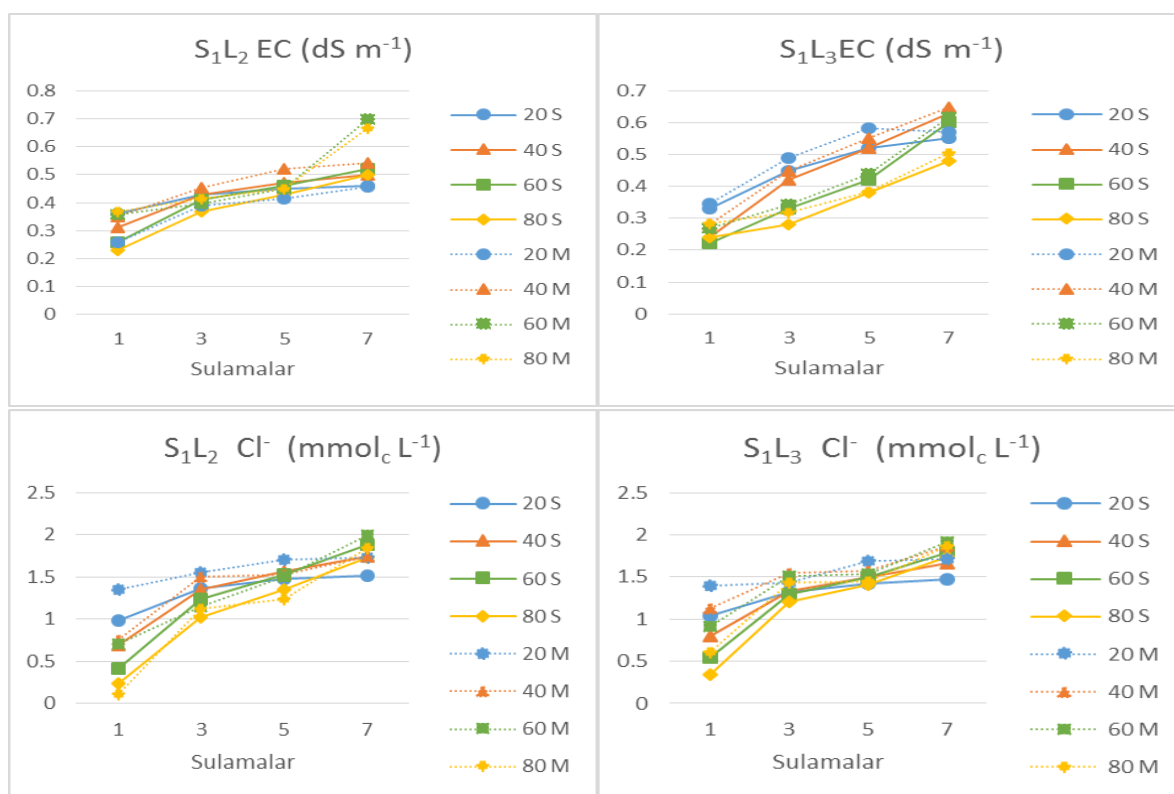
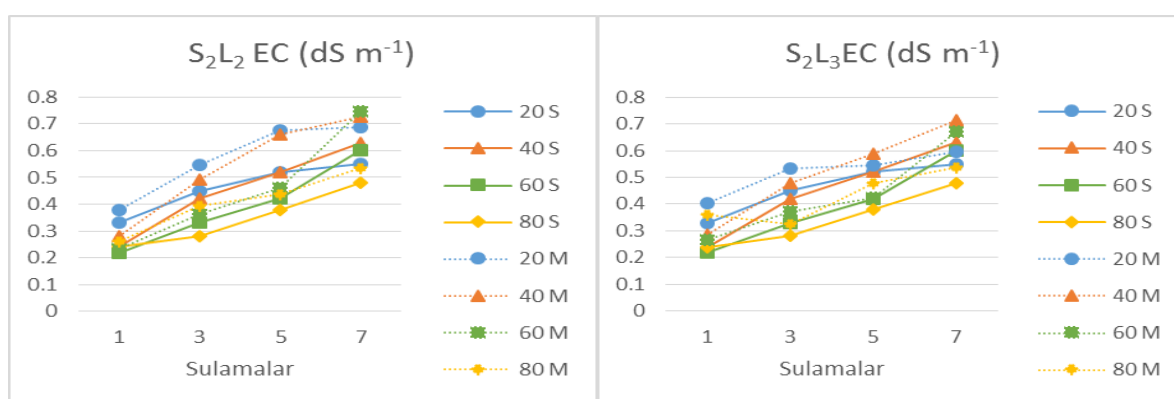


Figure 1. Measured and simulated EC, and  $Cl^-$  graphics during 1st, 3rd, 5th, and 7th irrigations for  $S_1$  treatment



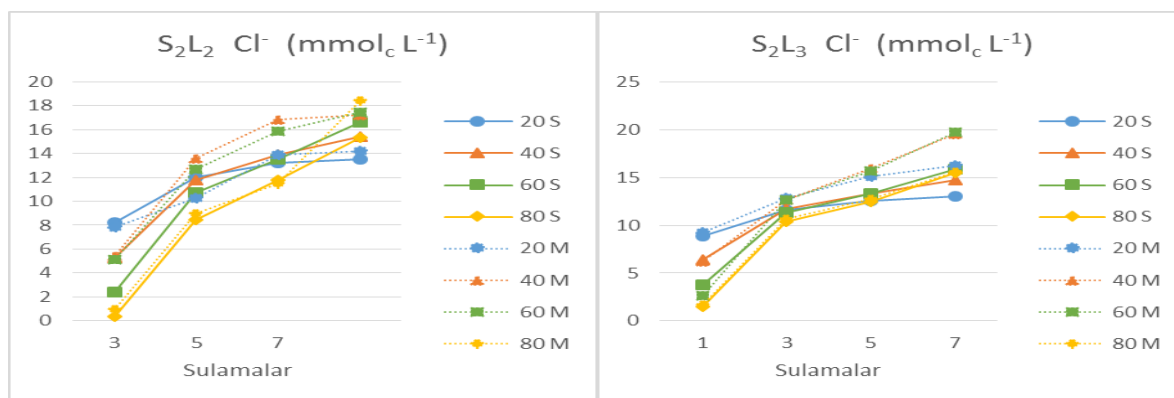


Figure 2. Measured and simulated EC, and  $\text{Cl}^-$  graphics during 1st, 3rd, 5th, and 7th irrigations for  $S_2$  treatment

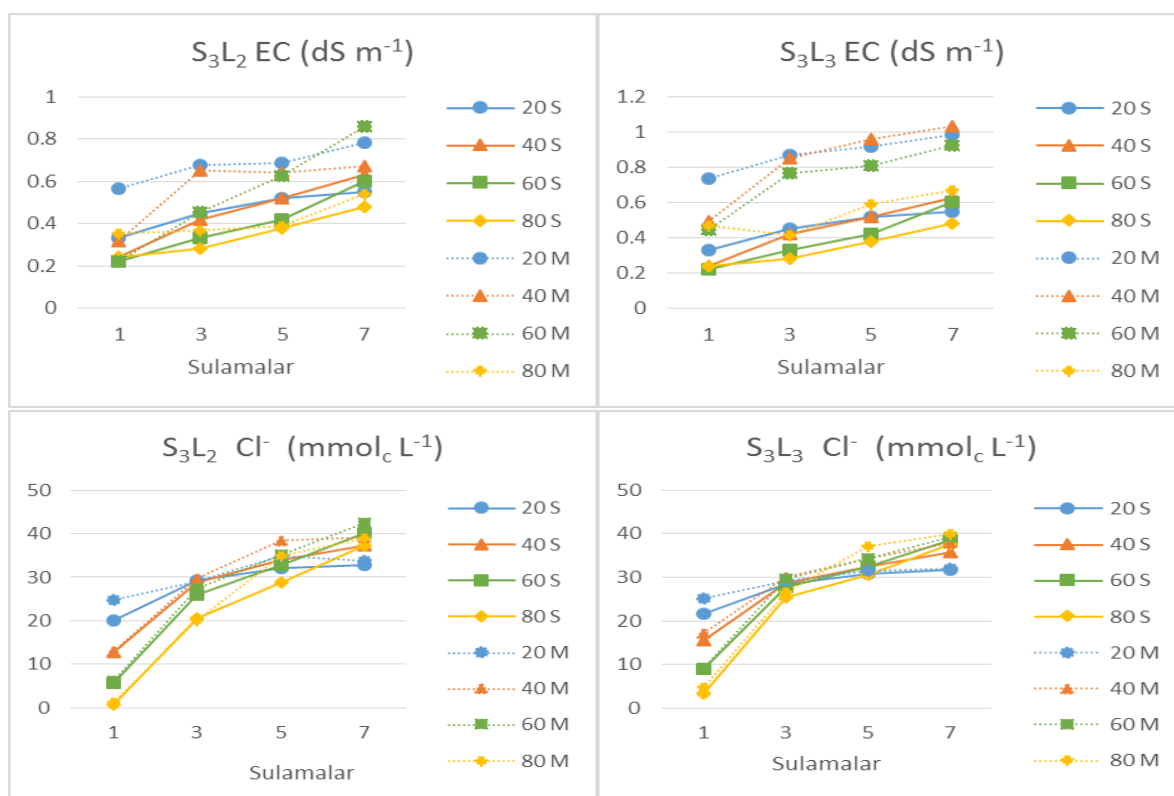


Figure 3. Measured and simulated EC, and  $\text{Cl}^-$  graphics during 1st, 3rd, 5th, and 7th irrigations for  $S_3$  treatment

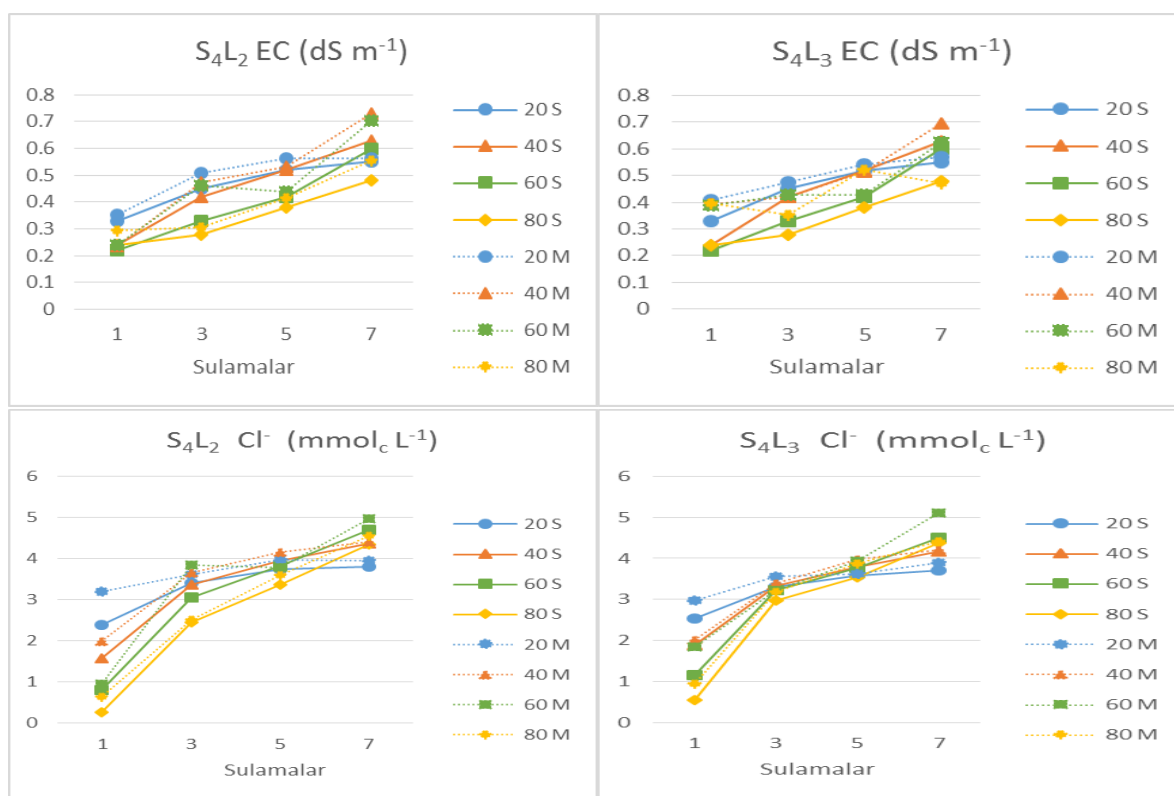


Figure 4. Measured and simulated EC, and  $\text{Cl}^-$  graphics during 1st, 3rd, 5th, and 7th irrigations for  $S_4$  treatment

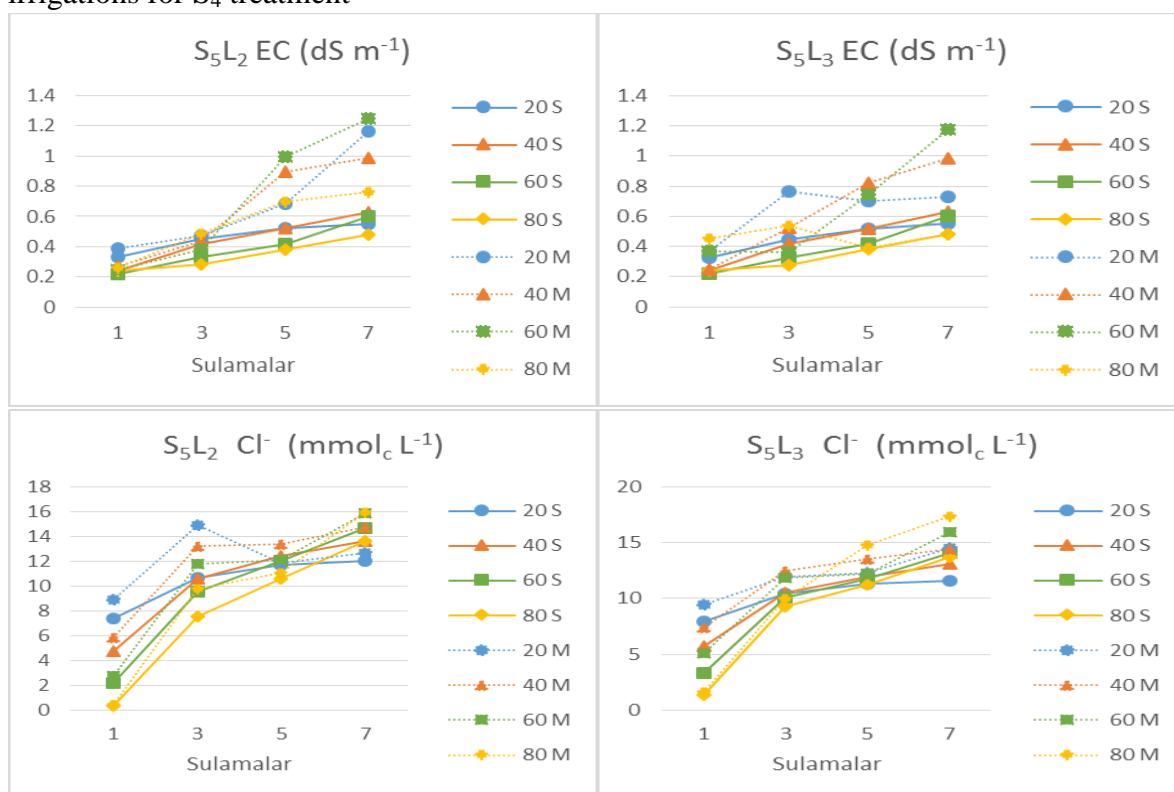


Figure 5. Measured and simulated EC, and  $\text{Cl}^-$  graphics during 1st, 3rd, 5th, and 7th irrigations for  $S_5$  treatment

Table 2. Calculated coefficients of determination ( $R^2$ ) for the regression between measured and simulated EC and  $Cl^-$  values

Konu	EC	$Cl^-$	Konu	EC	$Cl^-$
S <sub>1</sub> L <sub>2</sub>	0.541	0.910	S <sub>4</sub> L <sub>2</sub>	0.942	0.966
S <sub>1</sub> L <sub>3</sub>	0.987	0.948	S <sub>4</sub> L <sub>3</sub>	0.803	0.968
S <sub>2</sub> L <sub>2</sub>	0.964	0.932	S <sub>5</sub> L <sub>2</sub>	0.745	0.940
S <sub>2</sub> L <sub>3</sub>	0.952	0.947	S <sub>5</sub> L <sub>3</sub>	0.718	0.952
S <sub>3</sub> L <sub>2</sub>	0.800	0.979			
S <sub>3</sub> L <sub>3</sub>	0.808	0.978	avrg	0.826	0.952

The correlation between the measured and simulated EC and  $Cl^-$  values were drawn in Figure 6, and the coefficients of determination ( $R^2$ ) for S<sub>2</sub>L<sub>3</sub> treatment is shown as an example.

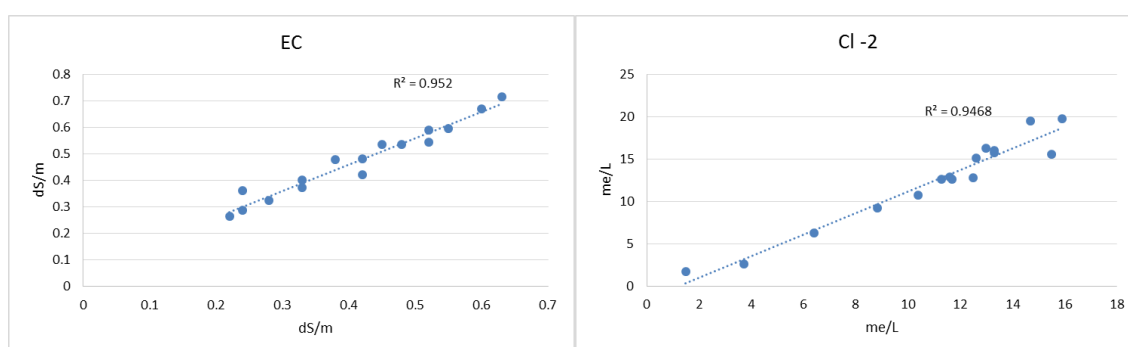


Figure 6. Correlation between the measured and simulated EC and  $Cl^-$  values and calculated coefficients of determination for S<sub>2</sub>L<sub>3</sub> treatment

### Conclusion

In this study, we evaluated the measured and simulated EC and  $Cl^-$  values with HYDRUS-1D using the statistics such as MAE, RMSE, RE, and coefficient of determination ( $R^2$ ).

It can be seen that, HYDRUS-1D simulation model simulated these two parameters and the coefficient of determination at a level of high accuracy. The results showed that HYDRUS-1D was able to successfully simulate soil water salinity and movement of salts (ions,  $Cl^-$ ) in the soil profile. The model describes better scenarios with lower values of salt concentrations (EC). Similar results were obtained for individual ion concentrations. The same results were reported by other researchers (e.g., Gonçalves et al., 2006; Ramos et al., 2011; Yurtseven et al., 2013).

### Acknowledgement

This study has been supported by TUBİTAK (The Scientific and Technological Research Council of Turkey) (TOVAG 114O554)

## References

- Anonymous. (1993). "The determination of inorganic anions in water by ion chromatography; Method 300.0.", U.S. Environmental Protection Agency, Cincinnati, Ohio.
- Ayers, R., and D. Westcot. (1985). Water quality for agriculture, FAO Irrig. Drain. Pap., 29, Rome, Italy, 1985.
- Corwin, D. L., and S. M. Lesch. (2003). Application of soil electrical conductivity to precision agriculture: theory, principles, and guidelines, *Agron. J.*, 95, 455–471.
- Corwin, D. L., J. D. Rhoades, and J. Šimůnek. (2007). Leaching requirement for soil salinity control: Steady-state versus transient models, *Agric. Water Management*, 90, 165-180.
- Gonçalves, M. C., J. Šimůnek, T. B. Ramos, J. C. Martins, M. J. Neves, and F. P. Pires. (2006). Multicomponent solute transport in soil lysimeters irrigated with waters of different quality, *Water Resour. Res.*, 42, W08401, doi:10.1029/2005WR004802.
- Hoffman, G. J., and M. Th. van Genuchten. (1983). Soil properties and efficient water use: Water management for salinity control, Chapter 2C, in: Limitations to efficient water use in crop production, ASA-CSSA-SSSA, p.73-85, USA.
- Kobayashi, K., and M. U. Salam. (2000). Comparing simulated and measured values using mean squared deviation and its components, *Agron. J.*, 92, 345–352.
- Legates, D. R., and G. J. McCabe Jr. (1999). Evaluating the use of "goodness-of-fit" measures in hydrologic and hydroclimatic model validation, *Water Resour. Res.*, 35, 233–241.
- Loague, K., R. E. Green. (1991). Statistical and graphical methods for evaluating solute transport models: overview and application, *J. Contam. Hydrol.*, 7, 51–73.
- Lobell, D. B., S. M. Lesch, and D. L. Corwin. (2010). Regional-scale assessment of soil salinity in the Red river valley using multi-year MODIS EVI and NDVI, *J. Environ. Qual.*, 39, 35–41.
- McNeal, B. L., J. D. Oster, and J. T. Hatcher. (1970). Calculation of electrical conductivity from solution composition data as an aid to in-situ estimation of soil salinity, *Soil Sci.*, 110, 405–414.
- Ramos, T. B., J. Šimůnek, M. C. Gonçalves, J. C. Martins, A. Prazeres, N. L. Castanheira, and L. S. Pereira. (2011). Field evaluation of a multicomponent solute transport model in soils irrigated with saline waters, *J. Hydrol.*, 407(1–4), 29–144.
- Rasouli, F., A. K. Pouya, and J. Šimůnek. (2012). Modeling the effects of saline water use in wheat-cultivated lands using the UNSATCHEM model, *Irrig.Sci.*, doi 10.1007/s00271-012-0383-8.
- Rhoades, J. D. (1974). Drainage for salinity control, In: van Schilfgaarde, J. (Ed.), *Drainage for Agriculture*, Agronomy Monographs No. 17, SSSA, Madison, WI, pp. 433-461.
- Šimůnek, J., and D. L. Suarez. (1994). Two-dimensional transport model for variably saturated porous media with major ion chemistry, *Water Resour. Res.*, 30, 1115-1133.
- Šimůnek, J., and J. W. Hopmans. (2009). Modeling compensated root water and nutrient uptake, *Ecol. Model.*, 220, 505–521.
- Šimůnek, J., M. Th. van Genuchten, and M. Šejna. (2008). Development and applications of the HYDRUS and STANMOD software packages, and related codes, *Vadose Zone J.*, 7, 587-600.
- U.S. Salinity Laboratory Staff (1954), *Diagnosis and Improvement of Saline and Alkali Soils*, U.S. Dept. Agriculture, Handbook 60, U.S. Government Printing Office, Washington DC, p.160.
- Van Genuchten, M. Th. (1980). A closed form equation for predicting the hydraulic conductivity of unsaturated soils, *Soil Sci. Soc. Am. J.*, 44, 892–898.

- Yurtseven, E., and B. Sönmez. (1992). Sulama sularının değerlendirilmesi, Tarım ve Köy İşl.Bk., KHGM, Toprak ve Gübre Araşt. Enst. Md. Yayınları No.181/T-63, 62s., Ankara.
- Yurtseven, E., J. Šimůnek, S. Avcı, and H. S. Öztürk. (2013). Comparison of Ion(Salt) Movement in the Soil Profile Subject to Leaching with the HYDRUS-1D Simulations, Proc. of the 4th International Conference "HYDRUS Software Applications to Subsurface Flow and Contaminant Transport Problems", March 21-22, 2013, Prague, Czech Republic, ISBN: 978-80-213-2380-3, pp. 395-404.
- Yurtseven, E., Öztürk, H.S., and S. Avcı. (2014). Mass Balance Criteria in Soil Salinity Management: Different Irrigation Water Qualities and Leaching Ratio. Journal of Agricultural Sciences, Ankara University Faculty of Agriculture, 20: 103-111.
- Yurtseven, E., Öztürk, H.S., Öztürk, A., Yılmaz, S. (2015). Change in the salinity composition of drainage water in soil columns irrigated by different salinity and varying leaching fractions of water. The proceedings of the International Soil Science Congress on "Soil Science in International years of Soils 2015", (Ed. Dr.Evgeny Shein) 19-23 October 2015 Sochi, Russia. Article Book pp.436-440.

## THE EFFECTS OF IRRIGATION WATER SALINITY AND LEACHING FRACTIONS ON SAR COMPONENTS OF SOIL SOLUTION IN LYZIMETER CONDITIONS

Engin YURTSEVEN<sup>1\*</sup>, Sertan AVCI<sup>1</sup>, M.Sevba ÇOLAK<sup>1</sup>, Hasan S. ÖZTÜRK<sup>2</sup>, Ahmet ÖZTÜRK<sup>1</sup>, Jiri ŠIMŮNEK<sup>3</sup>

<sup>1</sup>Department of Farm Structures and Irrigation, Faculty of Agriculture, University of Ankara, 06110 Dışkapı, Ankara, Turkey

<sup>2</sup>Department of Soil Science and Plant Nutrition, Faculty of Agriculture, University of Ankara, 06110 Dışkapı, Ankara, Turkey

<sup>3</sup>Department of Environmental Sciences, University of California, Riverside, CA 92521, USA

\*Corresponding author, yurtsev@ankara.edu.tr

### Abstract

SAR value is one of the most significant parameters in evaluating soil sodicity. In this study, we analyzed the content of SAR components  $\text{Na}^+$ ,  $\text{Ca}^{+2}$  and  $\text{Mg}^{+2}$  in the soil solutions obtained by using suction probes, during irrigation practices, situated in 20, 40, 60 and 80 cm of soil depths, in relation with irrigation water salinity and leaching fractions in soil columns. Experiments were conducted in 40 cm diameter and 115 cm depth soil columns using with 5 irrigation water salinities (0.25-control, 1.5 and 3.0  $\text{dS m}^{-1}$  with  $\text{NaCl}+\text{CaCl}_2$  and with  $\text{NaCl}+\text{CaSO}_4$  salts), and two leaching fractions (15% and 35%) with initially saline sandy-loam ( $\text{EC}_{\text{sp}1/2}=1.92 \text{ dS m}^{-1}$ ) soil. The  $\text{Na}^+$ ,  $\text{Ca}^{+2}$ , and  $\text{Mg}^{+2}$  concentrations of soil solutions were compared with the same ion concentrations simulated by using HYDRUS-1D mathematical model with the correlation coefficients.

The correlation coefficients ( $R^2$ ) were between 0.870-0.994 for  $\text{Na}^+$ , 0.917-0.984 for  $\text{Ca}^{+2}$ , and 0.337-0.965 for  $\text{Mg}^{+2}$  at 15% of leaching fraction level and were between 0.246-0.986 for  $\text{Na}^+$ , 0.915-0.980 for  $\text{Ca}^{+2}$ , and 0.835-0.956 for  $\text{Mg}^{+2}$  at 35% of leaching fraction level, respectively. The major part of the correlation coefficients were high enough to evaluate a good relation between the measured and simulated concentrations of these ions.

**Keywords:** *Salinity, Hydrus-1D, leach fraction, soil solutions*

### Introduction

Water scarcity and high salinity are major limiting factors for agroproductivity in many arid and semi-arid zones. The future of irrigated agriculture is threatened by increasing water scarcity and the ancient problems of water-logging, salinization, and degraded soil and water quality (Skaggs et al, 2006).

Water quality criteria for irrigation must consider both the direct impact on crop yield and the indirect impact related to effects on soil chemical and physical properties. It is well recognized that the salinity of a irrigation water and the sodium adsorption ratio (SAR), have an interactive effect on soil physical properties. Elevated values of SAR result in decreased hydraulic conductivity, decreased aggregate stability, clay dispersion, swelling of expandable clays, surface crusting and reduced tilth (Suarez et al 2006).

Salinity restrains root water uptake of plants by increasing the osmotic pressure in soil water. Thus making it more difficult for plants to extract water from the soil. Some components of salinity may cause specific-ion toxicity and imbalance the nutritional stability of plants. In addition, the salt composition of soil water influences the composition of cations in the

exchange complex of soil particles, which may significantly influence soil permeability and tilth (Yurtseven and Sönmez, 1992; Corwin et al., 2007).

Soils not only contain a mixture of salts, but the distribution of these salts is not uniform spatially, nor constant with a soil depth and/or time (Hoffman and van Genuchten, 1983). Excessive salts accumulated in soil profiles of irrigated lands can be leached out by adding more water than required to meet the evapotranspiration needs of the crops. The ratio of additional irrigation water, with respect to evaporation and transpiration, is usually expressed as a leaching fraction (*LF*) or a leaching requirement (*LR*), which are identical mathematical expressions, but with different meanings (USSL Staff, 1954; Rhoades, 1974).

Many methods are available to determine the impact of irrigation water quality and existing farm irrigation management in soil salinity. The most precise assessment of salinity is taking soil samples and carrying out laboratory analyses of salinity and its components using several types of laboratory instruments and methods. However, classical methods of evaluating soil salinity are time demanding, expensive, and require a lot of effort, yet cannot completely cover the spatial and temporal variability at the field scale (Rasouli et al., 2012).

Mathematical models that can consider various soil, climate, and crop factors have been suggested as useful tools for evaluating the optimum management strategies for saline conditions (Ramos et al., 2011; Rasouli et al., 2012). A variety of analytical and numerical models have been developed during the past several decades to predict water and solute transfer processes between the soil surface and groundwater table. The HYDRUS-1D software package (Šimůnek et al. 2008) is one of such models simulating water movement and solute transport in the soil. The objective of this study is to use HYDRUS-1D to analyze SAR and its components changes and solute transport in soil columns irrigated with waters of different quality at different leaching rates and to assess its applicability for practical applications.

### Material and Methods

The experiment was held in Ankara University Agricultural Faculty Campus (Turkey), between June 9th and September 16th with sunflower. Lysimeters were set up with corrugated PVC tubes of 40 cm diameter and 115 cm height. The soil, was provided from the top 20-60 cm profile of the surrounding cultivated area and sieved and put into lysimeters in equal amounts according to their bulk density. The soil used was sandy-loam and its bulk density is  $1.35 \text{ g cm}^{-3}$ , its pH is 8.03, its EC<sub>p</sub> (at 1:2 saturation) is  $1.92 \text{ dS m}^{-1}$ , its field capacity is 25.1%, and its wilting point is 15.2%. The sunflower used was “Meriç” which is an original variety from Turkey.

A total of 45 lysimeters with 5 salinity levels and 3 irrigation amounts as treatments with 3 replications were used. Experiments were conducted as a factorial experiment in fully randomized design. Irrigation water salinity levels were  $S_1$ =top water ( $0.25 \text{ dS m}^{-1}$ ),  $S_2$ = $1.5 \text{ dS m}^{-1}$  NaCl+CaCl<sub>2</sub>,  $S_3$ = $3 \text{ dS m}^{-1}$  NaCl+CaCl<sub>2</sub>,  $S_4$ = $1.5 \text{ dS m}^{-1}$  NaCl+CaSO<sub>4</sub>.2H<sub>2</sub>O and  $S_5$ = $3 \text{ dS m}^{-1}$  NaCl+CaSO<sub>4</sub>.2H<sub>2</sub>O. Irrigation water was applied with a limited irrigation (75% of required amount) and with leaching fractions of 115% ( $L_{15}$ ) and 135% ( $L_{35}$ ). Drainage water was collected from the cups which were previously put at the bottom of lysimeters.

The experiment was completed with 8 irrigations during growing season with the usage of 40% of available soil water. EC measurements were taken with ECmeter (YSI-3200) according to USSL (1954). The anion analysis were taken via ion chromatography (DIONEX IC-1600) apparatus according to Anonymous (1993).

To collect the soil solution samples, 4 suction probes were put into the lysimeters at the depths of 20, 40, 60, and 80 cm, with leaching treatments of  $L_{15}$  and  $L_{35}$ , and the samples were taken during irrigation. The results were then compared with those obtained by running HYDRUS-1D simulation model.



The HYDRUS-1D program numerically solves the Richards equation for variably-saturated water flow and the convection-dispersion equation for heat and solute transport. The program may be used to analyze water and solute movement in unsaturated or fully saturated porous media.

This study used the UnsatChem module (Šimůnek and Suarez, 1994) of the HYDRUS-1D software package (Šimůnek et al., 2008), simulating the major ion chemistry/transport and carbon dioxide transport.

In addition to a visual check, field measured values were compared with the results of the HYDRUS-1D simulations using the mean absolute error (*MAE*), the root mean square error (*RMSE*), and the relative error (*RE*) which are defined as follows:

$$MAE = \frac{1}{N} \sum_{i=1}^N |O_i - P_i| \quad (1)$$

$$RMSE = \sqrt{\frac{\sum_{i=1}^N |O_i - P_i|}{N-1}} \quad (2)$$

$$RE = \frac{RMSE}{Obs_{avg}} \quad (3)$$

where  $O_i$  and  $P_i$  are observed and model-predicted values in units of a particular variable,  $N$  is the number of observations, and  $Obs_{avg}$  is the mean observed value. In general,  $RMSE \geq MAE$ . The degree at which the  $RMSE$  value exceeds  $MAE$  is usually a good indicator of the presence and extent of outliers, or the variance of the differences between the modeled and observed values (Legates and McCabe, 1999; Kobayashi and Salam, 2000).  $RE$  was used to evaluate the quality of the  $RMSE$  value. The simulation is considered to be excellent when a relative error is less than 10%, good if it is greater than 10% and less than 20%, fair if it is greater than 20% and less than 30%, and poor if it is greater than 30% (Loague and Green, 1991).

## Results and Discussion

In this study, the calculated SAR and the soil's analyzed components  $Na^+$ ,  $Ca^{+2}$ , and  $Mg^{+2}$  results were taken into consideration and compared with the simulated HYDRUS-1D values, since soil sodicity hazard is mostly explained by the SAR calculation. Statistical parameters in order to evaluate the HYDRUS-1D modelling results for SAR and its components are given in Table 1, according to the treatments.

In general, the MAE and RMSE values increased, and RE values decreased with increasing soil depth. The soil salt and ion concentrations, in general, increase with depth, and it is almost the same for our experiments. As it was mentioned early RMSE values greater than MAE values in every treatment. The RMSE values for all treatments and for different soil depths varied for SAR between 3.37-9.54. The MAE values for all treatments and for different soil depths varied for SAR between 2.24-8.23. Furthermore The RE values for all treatments and for different soil depths varied for SAR between 1.13-1.37. As Loague and Green stated when a relative error is less than 10%; the simulation is good.

Table 1. The modelling statistics for SAR and its components Na<sup>+</sup>, Ca<sup>+2</sup>, and Mg<sup>+2</sup> values

		S <sub>1</sub> L <sub>2</sub>			S <sub>1</sub> L <sub>3</sub>			S <sub>2</sub> L <sub>2</sub>			S <sub>2</sub> L <sub>3</sub>			S <sub>3</sub> L <sub>2</sub>		
		MAE	RMS E	RE	MAE	RMS E	RE	MAE	RMS E	RE	MAE	RMS E	RE	MAE	RMS E	RE
SA R	20 cm	2,61	3,37	1,14	2,28	3,22	1,24	2,59	3,56	1,22	2,43	3,30	1,20	2,41	3,56	1,31
	40 cm	2,98	3,93	1,26	2,16	2,98	1,31	2,93	3,87	1,27	2,67	3,61	1,30	2,73	3,84	1,35
	60 cm	3,54	4,71	1,30	3,90	5,31	1,33	4,01	5,37	1,31	3,88	5,20	1,31	4,62	6,30	1,33
	80 cm	8,02	9,32	1,13	7,38	8,61	1,14	7,74	8,96	1,13	6,60	7,86	1,16	7,94	9,19	1,13
Na <sup>+</sup>	20 cm	5,44	6,95	1,20	5,52	8,22	1,40	4,71	8,39	1,16	4,83	7,54	1,02	6,26	9,52	1,12
	40 cm	8,96	12,78	1,41	10,39	16,22	1,54	16,92	22,39	1,27	11,53	15,66	1,27	16,64	22,61	1,30
	60 cm	23,37	31,26	1,33	25,65	35,12	1,37	27,46	35,88	1,30	23,89	31,15	1,29	30,65	40,41	1,31
	80 cm	57,41	66,76	1,16	50,97	59,08	1,15	54,95	63,59	1,14	45,75	53,66	1,14	59,40	68,71	1,13
Ca <sup>+2</sup>	20 cm	1,46	2,26	0,70	3,19	4,73	1,07	4,98	6,59	0,81	4,93	6,19	0,79	10,54	12,75	0,75
	40 cm	5,20	8,16	1,45	7,69	14,18	1,67	12,63	17,44	1,00	8,38	11,72	1,07	11,01	19,46	0,88
	60 cm	18,60	24,10	1,25	17,00	21,93	1,24	17,40	20,34	0,97	15,59	18,28	0,93	17,16	25,24	1,07
	80 cm	22,82	26,36	1,07	22,12	25,56	1,06	14,61	17,82	0,69	15,43	18,32	0,67	7,26	13,49	0,48
Mg <sup>+2</sup>	20 cm	4,50	5,67	1,23	5,57	8,15	1,44	9,93	11,96	1,12	10,06	11,91	1,11	19,23	22,46	1,09
	40 cm	8,23	13,15	1,59	11,41	20,06	1,75	27,15	37,09	1,35	15,14	20,73	1,34	33,80	46,10	1,34
	60 cm	35,48	47,32	1,33	35,64	47,82	1,34	39,21	52,03	1,32	34,79	46,35	1,32	43,50	57,60	1,31
	80 cm	61,65	71,46	1,16	56,53	65,30	1,15	60,87	70,47	1,15	58,83	68,01	1,14	69,15	81,07	1,15
		S <sub>3</sub> L <sub>3</sub>			S <sub>4</sub> L <sub>2</sub>			S <sub>4</sub> L <sub>3</sub>			S <sub>5</sub> L <sub>2</sub>			S <sub>5</sub> L <sub>3</sub>		
SA R	20 cm	2,24	3,39	1,32	2,50	3,33	1,18	2,46	3,43	1,23	3,54	4,11	1,07	3,21	3,99	1,13
	40 cm	2,42	3,41	1,34	3,28	4,30	1,27	2,56	3,56	1,33	3,34	4,38	1,27	3,14	4,12	1,26
	60 cm	4,37	5,92	1,32	5,08	6,77	1,31	3,76	5,05	1,31	5,96	8,10	1,34	3,50	4,91	1,36
	80 cm	8,23	9,54	1,13	8,53	9,86	1,13	6,47	7,88	1,18	8,96	10,35	1,13	7,26	8,50	1,14
Na <sup>+</sup>	20 cm	6,93	10,64	1,15	7,40	9,89	0,95	6,16	10,12	1,09	10,95	13,03	0,63	7,29	9,15	0,52
	40 cm	14,31	19,38	1,28	20,47	26,33	1,23	12,10	16,32	1,25	20,08	24,10	1,05	16,95	19,95	0,99
	60 cm	32,60	42,86	1,30	34,28	44,68	1,30	24,00	31,23	1,29	41,47	52,46	1,26	27,40	33,32	1,18
	80 cm	62,00	71,66	1,13	62,06	71,67	1,13	49,55	57,49	1,12	66,51	77,06	1,09	46,87	54,72	1,04
Ca <sup>+2</sup>	20 cm	10,72	12,96	0,79	5,79	7,93	0,53	5,94	7,72	0,54	11,18	14,59	0,60	18,11	21,10	1,27
	40 cm	10,76	19,03	0,85	12,22	17,01	0,82	10,66	15,02	1,08	12,18	22,25	0,96	12,61	22,09	1,04
	60 cm	16,69	24,08	0,98	14,80	21,09	1,06	12,63	18,72	1,00	16,50	25,00	1,03	15,41	23,64	1,10
	80 cm	5,98	12,24	0,42	9,04	14,46	0,57	6,89	12,79	0,51	11,91	16,16	0,59	11,85	14,39	0,53
Mg <sup>+2</sup>	20 cm	19,39	23,00	1,11	19,30	22,4	1,10	15,31	17,71	1,09	26,86	32,50	1,14	18,17	21,09	1,06
	40 cm	29,72	39,38	1,30	32,88	44,51	1,33	19,06	25,17	1,29	34,03	46,21	1,33	29,23	39,35	1,31
	60 cm	49,92	66,55	1,32	44,62	59,07	1,31	35,42	46,83	1,31	52,52	70,31	1,33	40,74	53,98	1,30
	80 cm	72,00	84,33	1,15	67,37	77,82	1,14	56,93	65,78	1,14	74,30	86,68	1,15	59,95	69,53	1,13

The graphics of measured and simulated SAR and its components for 1st, 3rd, 5th, and 7th irrigation applications are shown in figures 1, 2, and 3 for the easily soluble salt treatments, i.e., S1, S2 and S3. In all graphics, the measured and simulated values of Na, Ca, and Mg showed to be in sync, i.e., there was a good compatibility. But, the SAR showed a relatively poor compatibility. In other words, HYDRUS-1D simulated the analyzed data Na, Ca, and Mg values very closely to that of the measured values but calculated SAR didn't. Measured and simulated values were compared with the  $R^2$  (coefficient of determination) statistic as well. This  $R^2$  statistics for SAR and its components are given in Table 2. The  $R^2$  graphics are shown in figure 4, 5, and 6, for S1, S2, and S3 treatments respectively.

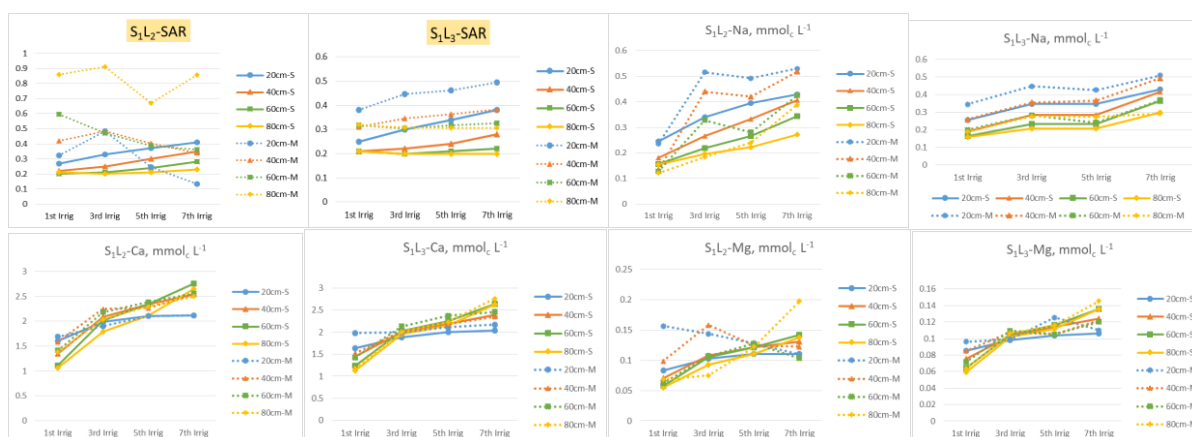


Fig. 1. Measured and simulated SAR, and its components graphics during 1st, 3rd, 5th, and 7th irrigations for S<sub>1</sub> treatment

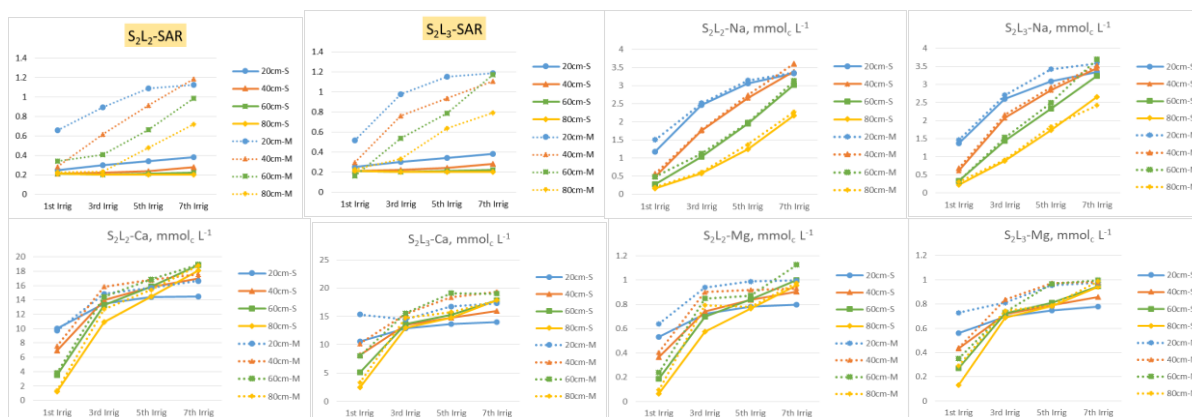


Fig. 2. Measured and simulated SAR, and its components graphics during 1st, 3rd, 5th, and 7th irrigations for S<sub>2</sub> treatment

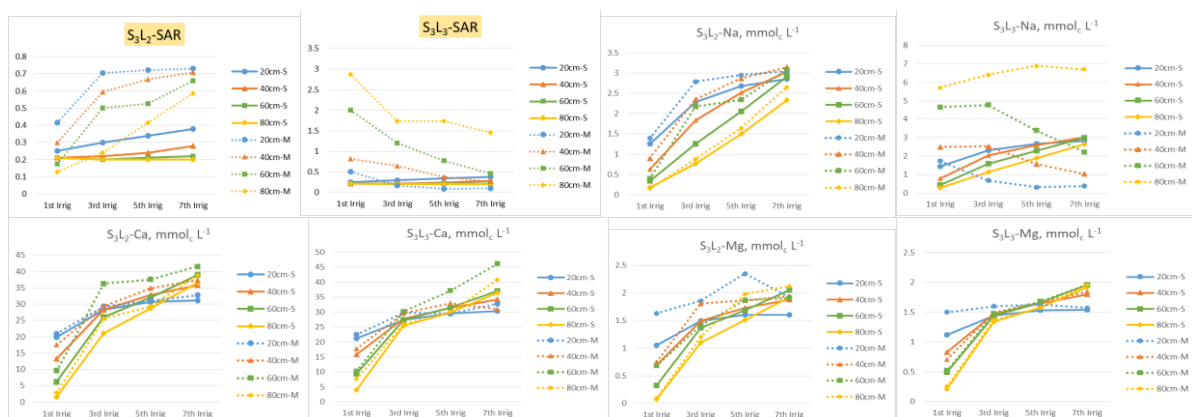


Fig. 3. Measured and simulated SAR, and its components graphics during 1st, 3rd, 5th, and 7th irrigations for S<sub>3</sub> treatment

Table 2. Calculated coefficients of determination (R<sup>2</sup>) for the regression between measured and simulated SAR components Na, Ca, and Mg.

Konu	Na <sup>+</sup>	Ca <sup>+2</sup>	Mg <sup>+2</sup>
S <sub>1</sub> L <sub>2</sub>	0.870	0.949	0.337
S <sub>1</sub> L <sub>3</sub>	0.898	0.939	0.835
S <sub>2</sub> L <sub>2</sub>	0.994	0.984	0.930
S <sub>2</sub> L <sub>3</sub>	0.986	0.915	0.911
S <sub>3</sub> L <sub>2</sub>	0.951	0.947	0.857
S <sub>3</sub> L <sub>3</sub>	0.246	0.928	0.956
S <sub>4</sub> L <sub>2</sub>	0.973	0.917	0.965
S <sub>4</sub> L <sub>3</sub>	0.940	0.967	0.907
S <sub>5</sub> L <sub>2</sub>	0.951	0.979	0.965
S <sub>5</sub> L <sub>3</sub>	0.928	0.980	0.915
Avrg	0.8737	0.9505	0.8578

Average R<sup>2</sup> values for Na, Ca, and Mg are 0.87, 0.95, and 0.86 respectively. These R<sup>2</sup> values are high enough to able to say the measured and simulated values are compatible. The results were compatible with those reported by other researchers (Gonçalves et al., 2006; Ramos et al., 2011; Yurtseven et al., 2013).

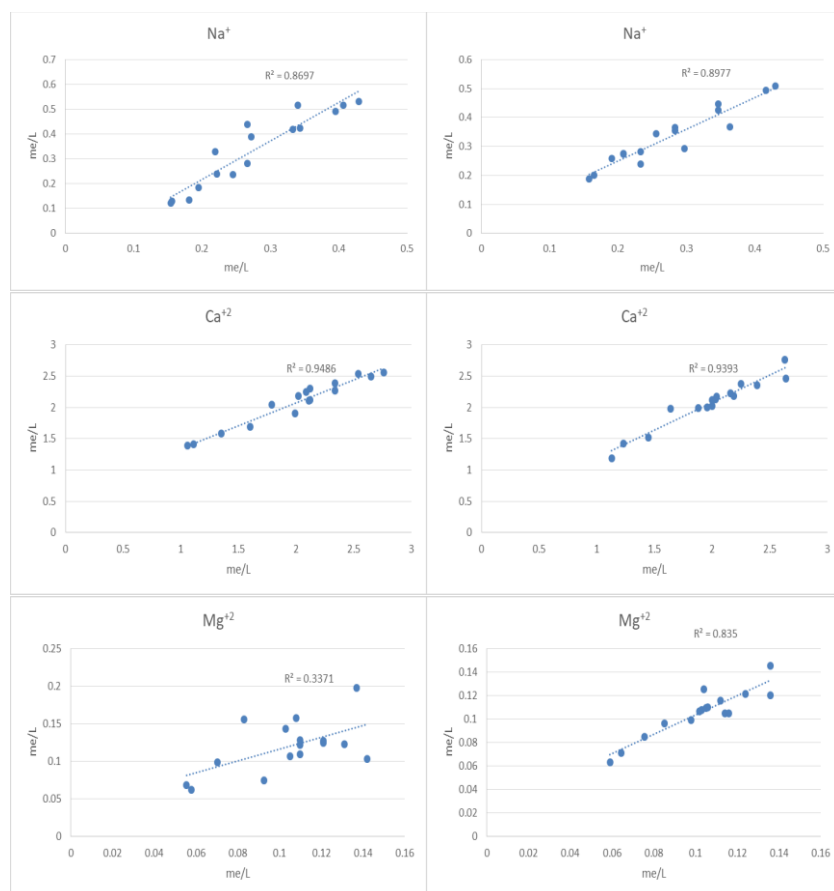


Fig. 4. The SAR components Na, Ca, and Mg R<sup>2</sup> values for S<sub>1</sub> treatment

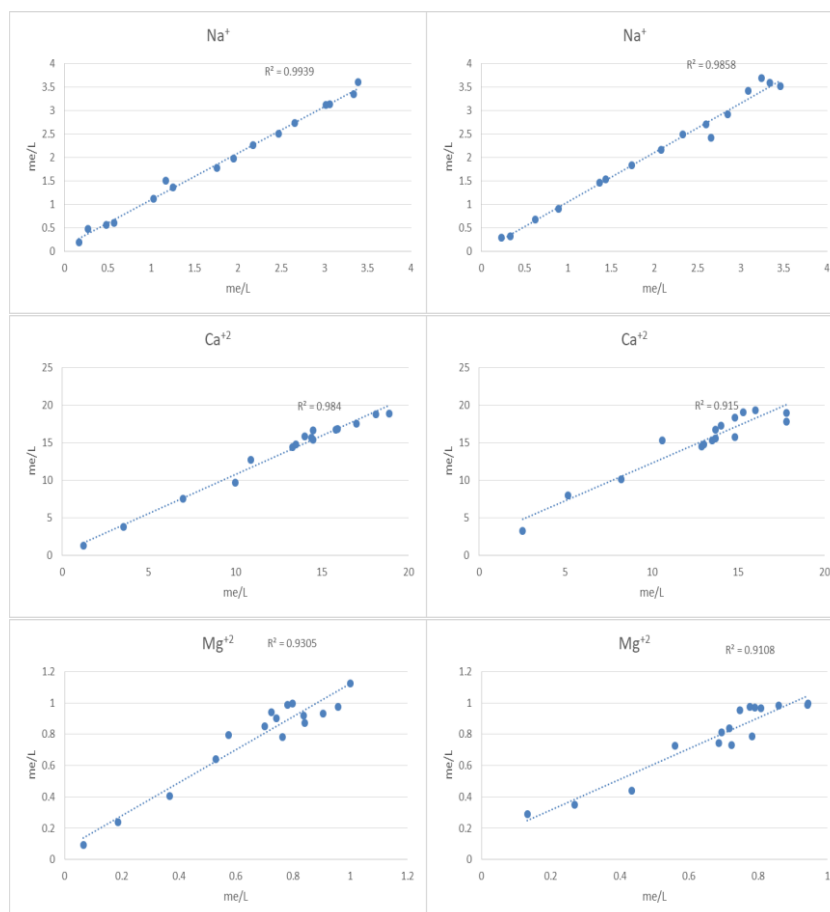
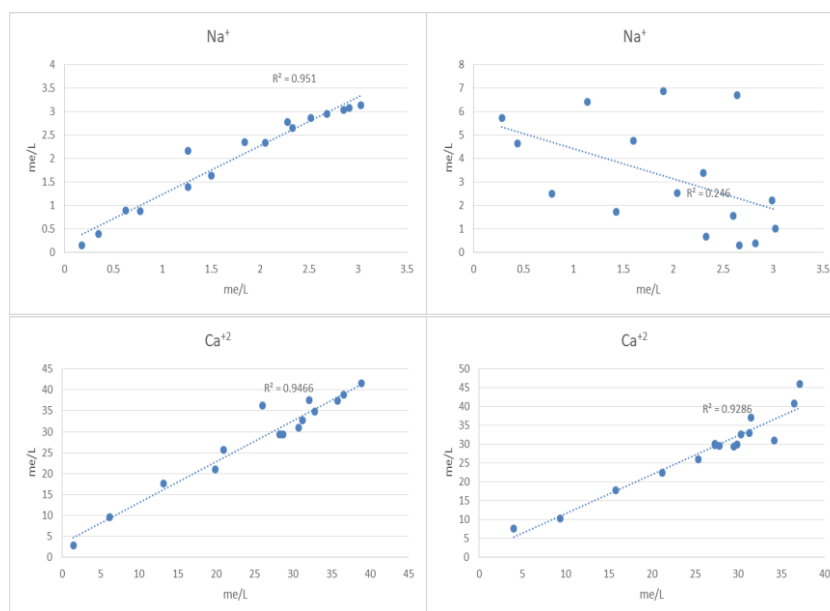


Fig. 5. The SAR components Na, Ca, and Mg R<sup>2</sup> values for S<sub>2</sub> treatment



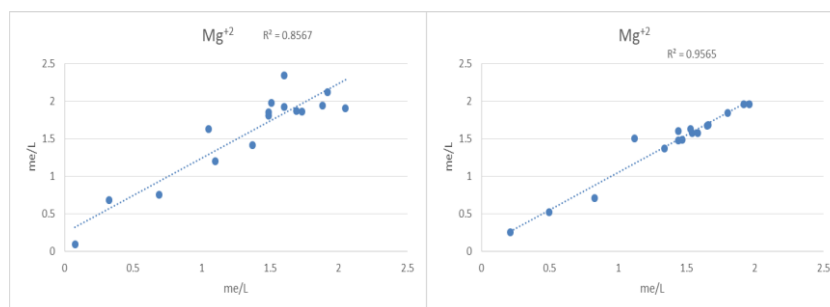


Fig. 6. The SAR components Na, Ca, and Mg R<sup>2</sup> values for S<sub>3</sub> treatment

### Conclusions

In this study, we evaluated the SAR and its components Na, Ca, and Mg by means of measuring and simulating values using HYDRUS-1D and statistical analysis such as MAE, RMSE, RE, and coefficient of determination (R<sup>2</sup>).

It can be said that, HYDRUS-1D mathematical simulation model simulated the SAR components Na, Ca, and Mg parameters with a high accuracy. But it didn't simulate the calculated SAR values in high accuracy.

The results showed that HYDRUS-1D was able to successfully simulate soil water SAR components of Na, Ca, and Mg in the soil profile.

### Acknowledgement

This study has been supported by TÜBİTAK (The Scientific and Technological Research Council of Turkey) (TOVAG 114O554)

### References

- Anonymous. (1993). The determination of inorganic anions in water by ion chromatography; Method 300.0., U.S. Environmental Protection Agency, Cincinnati, Ohio.
- Gonçalves, M. C., J. Šimůnek, T. B. Ramos, J. C. Martins, M. J. Neves, and F. P. Pires. (2006). Multicomponent solute transport in soil lysimeters irrigated with waters of different quality, *Water Resour. Res.*, 42, W08401, doi:10.1029/2005WR004802.
- Hoffman, G. J., and M. Th. van Genuchten. (1983). Soil properties and efficient water use: Water management for salinity control, Chapter 2C, in: *Limitations to efficient water use in crop production*, ASA-CSSA-SSSA, p.73-85, USA.
- Kobayashi, K., and M. U. Salam. (2000). Comparing simulated and measured values using mean squared deviation and its components, *Agron. J.*, 92, 345–352.
- Legates, D. R., and G. J. McCabe Jr. (1999). Evaluating the use of “goodness-of-fit” measures in hydrologic and hydroclimatic model validation, *Water Resour. Res.*, 35, 233–241.
- Loague, K., R. E. Green. (1991). Statistical and graphical methods for evaluating solute transport models: overview and application, *J. Contam. Hydrol.*, 7, 51–73.
- Ramos, T. B., J. Šimůnek, M. C. Gonçalves, J. C. Martins, A. Prazeres, N. L. Castanheira, and L. S. Pereira. (2011). Field evaluation of a multicomponent solute transport model in soils irrigated with saline waters, *J. Hydrol.*, 407(1–4), 29–144.
- Rasouli, F., A. K. Pouya, and J. Šimůnek. (2012) Modeling the effects of saline water use in wheat-cultivated lands using the UNSATCHEM model, *Irrig.Sci.*, doi 10.1007/s00271-012-0383-8.

- Rhoades, J. D. (1974). Drainage for salinity control, In: van Schilfgaarde, J. (Ed.), Drainage for Agriculture, Agronomy Monographs No. 17, SSSA, Madison, WI, pp. 433-461.
- Šimůnek, J., and D. L. Suarez. (1994). Two-dimensional transport model for variably saturated porous media with major ion chemistry, *Water Resour. Res.*, 30, 1115-1133.
- Šimůnek, J., M. Th. van Genuchten and M. Šejna. (2008). Development and applications of the HYDRUS and STANMOD software packages, and related codes, *Vadose Zone J.*, 7, 587-600.
- Skaggs, T.H., J.A.Poss, P.J.Shouse, and C.M.Grieve. (2006). Irrigating forage crops with saline waters:1. Volumetric lysimeter studies. *Vadose Zone Journal*, 5:815-823.
- Suarez, D.L., J.D. Wood and S.M.Lesch. (2006). Effect SAR on water infiltration under a sequential rain-irrigation management system. *Agricultural Water Management*, 86:150-164.
- U.S. Salinity Laboratory Staff. (1954). Diagnosis and Improvement of Saline and Alkali Soils, U.S. Dept. Agriculture, Handbook 60, U.S. Government Printing Office, Washington DC, p.160.
- Yurtseven, E., and B. Sönmez. (1992). Sulama sularının değerlendirilmesi, Tarım ve Köy İşl.Bk., KHGM, Toprak ve Gübre Araşt. Enst. Md. Yayınları No.181/T-63, 62s., Ankara.
- Yurtseven, E., J. Šimůnek, S. Avcı and H. S. Öztürk. (2013). Comparison of Ion(Salt) Movement in the Soil Profile Subject to Leaching with the HYDRUS-1D Simulations, Proc. of the 4th International Conference "HYDRUS Software Applications to Subsurface Flow and Contaminant Transport Problems", March 21-22, 2013, Prague, Czech Republic, ISBN: 978-80-213-2380-3, pp. 395-404.

## **THE ECONOMIC IMPACT OF CLIMATE CHANGE ON AGRICULTURAL WATER DEMAND IN FRANCE**

Pierre-Alain JAYET<sup>\*</sup>, Delphine BARBERIS, Pierre HUMBLLOT

UMR INRA-Agro Paris Tech “Economie Publique”, Grignon, France

<sup>\*</sup>Corresponding author: pierre-alain.jayet@inra.fr

### **Abstract**

Present resource pressures and climate change should strongly impact water's availability and, correlatively, the economic situation of farming systems in terms of irrigation demand. The prospective approach that we develop focuses on the link between climate, crop yield and water, in order to assist public decision-making. The objective is to estimate future water demand in France, in a context of farm gross margin maximization. The method is based on the coupling of the AROPAj agricultural supply model with the STICS crop model. Simulations were performed for three climate projections (SRES-AR4 A1B, A2 and B1) from 2010 to 2100. Due to high inter-annual variability of precipitation and existence of substitutions between agricultural productions, irrigation results don't vary regularly from one “climatic” year to the next. Nevertheless, the results suggest a significant increase in water demand for the three projections in case of prices unchanged. The regional study revealed wide disparities. The most irrigated regions such as Aquitaine, Poitou-Charentes or Pays de la Loire would be characterized by the largest increase in demand for irrigation from the 2011-2020 decade to the 2091-2100 decade. We account of pressure on the resource by simulating changing water price scenarios. As expected, rising costs would contribute to a decline in demand, highly differentiated by region. The most affected regions would correspond to the most irrigated ones in absolute and relative terms.

**Keywords:** *water demand, water prices, climate change, bio-economic supply model.*

### **Introduction**

With 3 billion cubic meters extracted in 2009, agriculture is a significant water-intensive sector of activity in France (Eau France, 2012). Given present resource pressures and the potential harmful effects of climate change (CC), a decline in water availability and, as a consequence, a change in current agricultural systems, are to be feared in the years to come. In France, existence of disparate irrigation practices from one region to another, intensive in the South and less widespread in the North, complicates territorial decision-making.

In order to ensure an optimal resource management, the objective of this work is to estimate future irrigation demand, and analyse the influence of regulatory policies. We adopt a bio-economic approach, widely used in the literature to simulate the behavior of farmers by incorporating agronomic information (Cortignani and Severini 2009; Kampas et al. 2012, Graveline et al. 2014). A prospective analysis centered on the link between climate, yields and water demand, is developed. An agro-economic model, called AROPAj, is used and coupled with STICS, a plant growth simulation tool. Various information such as gross margin and irrigation inputs is obtained at the country's scale on the basis of climatic projections provided by the ARPEGE-CLIMAT model (from 2010 to 2100) related to scenarios proposed by the IPCC (A2, A1b and B1). Thereafter, rising water costs simulations are proposed to symbolize the medium-term importance of pressure on resource in a context



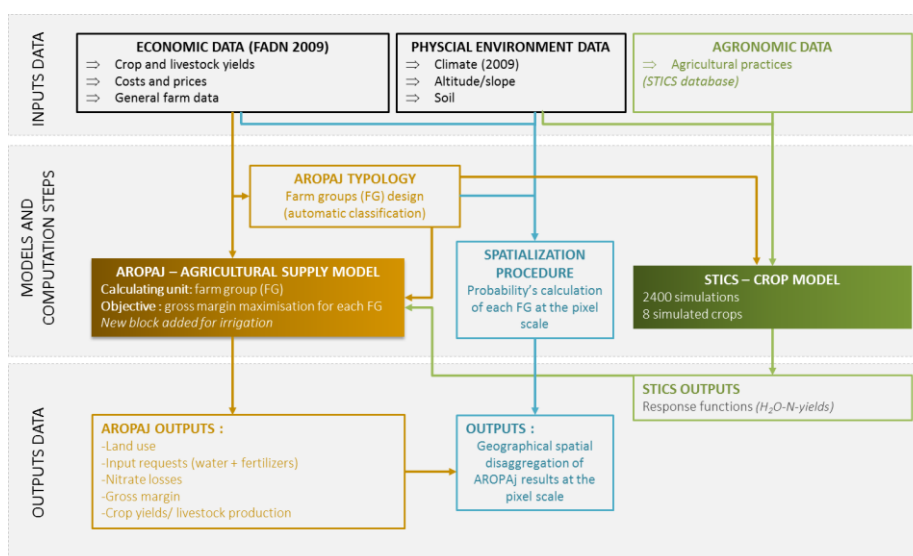
of CC. Although the process is developed at the European level, France was chosen as a case study because of its representation in terms of agricultural production, soil and climatic diversity.

The P. Humblot's approach (2016) has been extended in order to obtain high resolution maps aiming at illustrate the existence of disparate irrigation practices from one region to another. The inter-annual and inter-regional variability of irrigation demand under CC scenarios is evaluated following the extension of simulation times over a period from 2010 to 2100 instead of 2050.

The next section provides the method, including the AROPAj optimization problem, the yield function elaboration, the spatial downscaling procedure and the different scenarios elaborated. Then, the results of the impact of CC on irrigation demand and the effect of water prices changes are described. Finally, the last part delivers concluding remarks and future research perspectives.

### Material and Methods

In order to simulate agriculture response to economic and climate changes, we integrate agronomic information to the AROPAj<sup>9</sup> supply model using STICS, a plant growth simulation tool (Godard et al. 2008; Leclère et al. 2013; Humblot et al. 2016) (refer to **Figure 1**). AROPAj is a linear programming model based on the design of agricultural systems representative of the wide diversity of European productions. The main assumption is the maximisation of agricultural holder's profits under different constraints. The economic agent considered for computation is the farm group. An automatic classification is used to aggregate systems with similar technical and economic characteristics. The data used for the clustering procedure was extracted from the European Farm Accounting Data Network (FADN) of 2009. This typology respects the privacy rules specific to the FADN.



**Figure 7: General method and AROPAj-STICS models coupling**

(In yellow - AROPAj module, in green - STICS module, in blue - spatialization module)

STICS is a dynamic, generic and robust model for simulating the soil-atmosphere-crop system in any region. It operates at a daily time step, over one or two calendar years depending on the type of plant considered (Brisson et al. 2003). Data on climate, soil type

<sup>9</sup> Jayet, P.-A. (n.d.). The European agro-economic AROPAj model. [https://www6.versailles-grignon.inra.fr/economie\\_publique/Publications](https://www6.versailles-grignon.inra.fr/economie_publique/Publications)

and management practices are required as inputs (refer to **Figure 1**). To compensate the lack of information at the farm group scale, a large number of simulations were carried out under different conditions. Various soil types, sowing dates, previous crops and varieties were tested. A total of 2400 combinations were simulated for each farm group and each of the 8 most marketed production in Europe (wheat, maize, barley, rapeseed, sunflower, beet, potato, soya). STICS estimates agricultural and environmental variables such as yields, quantity requested of fertilizers and water applied. These outputs contribute to the conception of H<sub>2</sub>O-N-yield relation calibrated on data "observed" in 2009 via an economic criterion. The method presented in this study is extracted from the work of Humblot et al. (2017). The equation chosen can be expressed as follow:

$$Y = Y_{max} \times (1 - e^{-\sigma(W+W0)}) \times (1 - e^{-\tau(N+N0)})$$

<i>W</i> : water input (m <sup>3</sup> )	<i>W0</i> : rain and initial soil water (m <sup>3</sup> )	$\sigma$ : slope parameter relative to water (m <sup>-3</sup> )
<i>N</i> : nitrogen input (T)	<i>N0</i> : organic and initial soil nitrogen (T)	$\tau$ : slope parameter relative to nitrogen (T <sup>-1</sup> )
<i>Y</i> : yield (T)	<i>Ymax</i> : agronomic potential (T)	<i>Y, Ymax, W, N</i> : quantities obtained per hectar

Response function use helps overcome the lack of information on nitrogen or water costs, respectively called *cn* and *cw* in our method. Instead of assuming a precise value for each component, a reasonable range for *cw* and *cn* is used in accordance with all available information obtained from expert opinion and the literature (Graveline et al. 2014). For water prices, it depends on regions considered. In this way, *cn* and *cw* fluctuate around an average value of 1,89 €/kg and 0,2€/m<sup>3</sup> respectively.

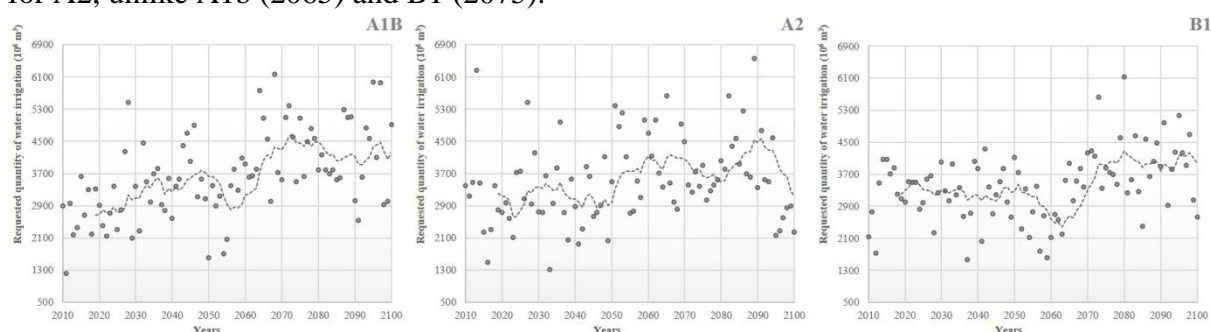
Due to FADN's personal data protection policy, the geographical localization of an individual farm is not provided. Nevertheless, we are able to mobilize physical data and spatial econometric methods to give a probabilistic localization of AROPAj farm group at the pixel scale (refer to **Figure 1**). The spatial disaggregation approach is explained in Chakir (2009) and Cantelaube (2012). This procedure has been extended to integrate the irrigated land proportion. In order to create high-resolution maps, AROPAj outputs are weighted by the probabilities obtained in the previous step. Information on the resources' consumption, yields, gross margin and nitrate losses are calculated at different scales (countries, regions, farms, and/or watersheds).

A first modelling step is based on the evaluation of the CC effect on irrigation water demand in the future, without taking into account any resource management policy. Yield functions are produced based on the ARPEGE-CLIMAT model's climatic projections from 2010 to 2100. Three evolution scenarios, derived from the IPCC SRES, are studied in this paper. They correspond to different levels of radiative forcing (W/m<sup>2</sup>): extreme (A2), medium (B1) and intermediate (A1b) compared to the current constant tendency. In our approach, farmers are maximizing their gross margin, according to yields evolution under future climatic conditions, by optimizing cultivated land allocation and quantities of inputs. Sowing date, varietal choices and previous crop selection remain unchanged. AROPAj results are obtained on an annual time step and calculated per decade from 2011-2020 to 2091-2100. In the following analysis, additional scenarios for increasing access to water costs, *cw*, are simulated to illustrate the medium-term importance of pressure on resource in a context of CC. A multiplication coefficient was applied uniformly to all water prices data. For different climatic evolution from 2010 to 2100 (A2, B1 and A1b), the selected range was +0% to +100% around the initial price with a step of 25%.

## Results and Discussion

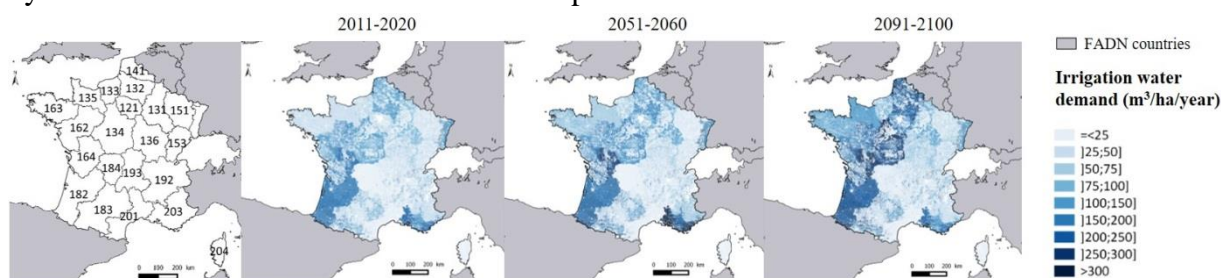
First, simulations were performed for three climate projections (SRES A1B, A2 and B1) from 2010 to 2100, without intervention of any policy. **Figure 2** illustrates the effect of CC on total required irrigation quantities to maximize agricultural gross margin. Each point represents

one modelling for a particular year. Using a 10-year moving averages computation, different dotted trend curves are obtained. The three scenarios are characterized by a potential global demand increase: +70 % for A1b versus +23% for B1 between 2010 and 2100. Under constraints of available water supply, we should expect a relative decline in yields or the emergence of other cropping if this proves to be more beneficial for farmers. For the most extreme scenario A2, it is difficult to obtain a clear trend compared to other climate projections. We can assume that this irregular trajectory is strongly dependent on the inter-annual variability of the rainfall pattern (dates and quantities). Through these results, we demonstrate the importance of using data on various future climate years as opposed to an average climate. Nevertheless, it appears that irrigation water request could be higher for A2. According to the trend curves, water demands would exceed  $3700 \cdot 10^6$  m<sup>3</sup> by the year 2050 for A2, unlike A1b (2065) and B1 (2075).



**Figure 8: Evolution of water demand for three climate projections (A1B, A2 et B1) from 2010 to 2100. The trend curves in dotted lines symbolize the moving averages calculated over 10 years**

**Figure 3** represents the type of maps obtained from the spatial downscaling procedure. In this example, we study the water demand evolution for the intermediate climate scenario A1b. Averages for three decades were calculated: 2011-2010, 2051-2061 and 2091-2100. Values range from 25 to 200 m<sup>3</sup>/ha/year. Classes are created by identifying breakpoints in the data's distribution. A colour change of certain regions, from light to dark shade, symbolizes a potential increase in irrigation demand by 2100. The agricultural systems response to CC appears irregular according to regions. The southwest and western areas of the country (in particular regions Provence-Alpes-Côte-d'Azur, Aquitaine, Centre, Poitou-Charente and Pays de la Loire) would be irrigated a lot in the coming years. It is interesting to note that there is a good correspondence between the 2011-2020 AROPAJ outputs and the data recorded in 2012 by the French Observation and Statistics Department.



Sources : LUCAS 2012, Corine Land Cover 2006, FADN 2009, European Commission data

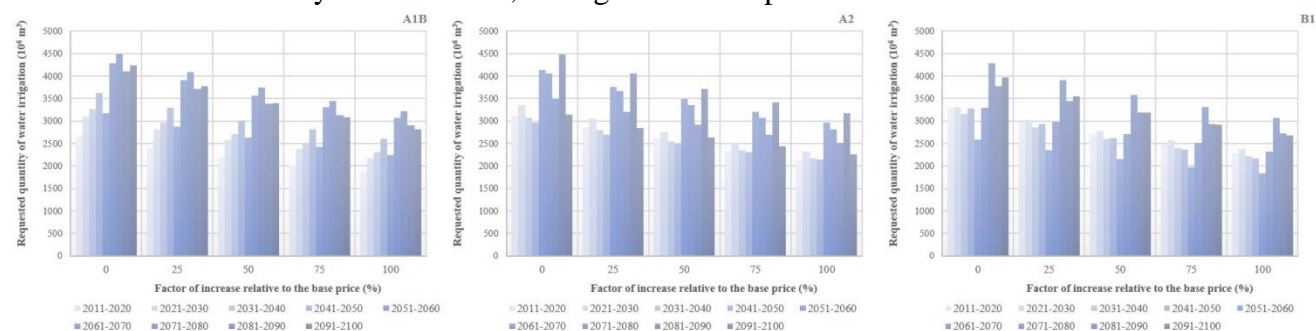
**Figure 9: Evolution of irrigation water demand in France during the periods 2011-2020, 2051-2060 and 2091-2100 (averages per decades) for A1b**

Region legend: 121 - Île-de-France; 131 - Champagne-Ardenne; 132 - Picardie; 133 - Haute-Normandie; 134 - Centre; 135 - Basse Normandie; 136 - Bourgogne; 141 - Nord-Pas-de-Calais; 151 - Lorraine; 152 - Alsace; 153 - Franche-Comté; 162 - Pays de la Loire; 163 - Bretagne; 164 - Poitou-Charentes; 182 - Aquitaine; 183 - Midi-Pyrénées; 184 - Limousin; 192 - Rhône-Alpes; 193 - Auvergne; 201 - Languedoc-Roussillon; 203 - Provence-Alpes-Côte d'Azur

Through this study, we have demonstrated the capacity of the model to capture regional diversity of climate and agricultural systems. Therefore, irrigation results are very heterogeneous both spatially (between regions) and temporally (between climatic years).

In a second step, we introduce regulation policies and we analyse the effect of a possible change in constraints concerning resource access in France on agricultural systems. The procedure remains the same. The only difference concerns the water prices values, ranging from + 0% to + 100% around the initial cost (+0%/+25%/+50%/+75%/+100%), for different climatic evolutions during the period 2010-2100 (A2, B1 and A1b).

**Figure 4** illustrates evolution of the variable "irrigation" for A2, B1 and A1b, from 2011-2020 to 2091-2100, under different constraints of access to the resource. Increasing water prices from 0% to 100% leads to a gradual decrease in demand for each decade and each climate projection. The relation seems to be linear. For instance, multiplying the price by two would divide demand by three for A1b, during 2051-2060 period.

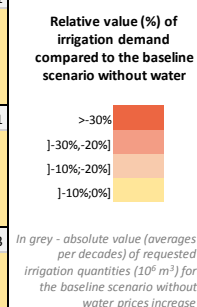


**Figure 4: Impact of changes in water price on irrigation demand (averages per decade) in France for three climate projections (A1B, A2 et B1).**

Relative values of irrigation quantity requested are estimated compared to the baseline scenario in **table 1**. A colour gradient from light yellow to dark red indicates a significant drop in demand from 0 to 100% relative to the outputs obtained in the baseline scenario. We note, in all cases, a decrease differentiated according to the region considered. Some of them would be less sensitive than others such as Bretagne (163) and Limousin (184). Some low-irrigated areas will see their water consumption fall by more than 40% due to the doubling of prices for the decades 2051-2060 and 2091-2100 (121 – Ile de France; 135 – Basse Normandie; 153- Franche-Comté). Nevertheless, even if this variation seems to be significant, these results should be compared with outputs obtained for the other highly irrigated regions more impacted (134 - Centre; 162 - Pays de la Loire; 164 - Poitou-Charentes; 182 - Aquitaine; 183 - Midi-Pyrénées, same regions as in figure 4). These effects are different depending on the period considered (see decades 2011-2020 and 2091-2100 for Poitou-Charente region).

**Table 4: Impact of changes in water prices on irrigation demand for A1b by region during the periods 2011-2020, 2051-2060 and 2091-2100.**

periods	increase in base price	regions																							
		121	131	132	133	134	135	136	141	151	152	153	162	163	164	182	183	184	192	193	201	203	204		
2011-2020	0	34,0	121,9	170,0	53,8	279,7	35,3	98,3	104,3	53,6	168,9	40,4	342,9	107,8	291,2	270,1	237,9	12,2	138,5	38,4	33,9	42,7	0,1		
	25	-16	-7	-14	-5	-15	-15	-10	-10	-10	-9	-14	-5	-5	-10	-7	-15	-2	-11	-13	-14	-3	0		
	50	-29	-16	-25	-9	-25	-27	-16	-16	-18	-17	-23	-11	-10	-20	-12	-24	-6	-20	-23	-28	-6	-1		
	75	-38	-24	-32	-13	-33	-35	-22	-21	-24	-26	-30	-16	-15	-26	-16	-32	-9	-29	-32	-36	-9	-1		
	100	-45	-31	-37	-17	-40	-41	-26	-26	-30	-34	-36	-22	-19	-31	-20	-40	-11	-35	-39	-39	-10	-1		
2051-2060	0	70,0	157,7	190,3	59,9	359,8	57,9	98,5	108,3	30,0	144,9	31,7	374,9	192,8	385,0	298,5	317,3	13,6	120,4	51,0	35,6	73,7	0,1		
	25	-14	-9	-11	-6	-15	-12	-7	-7	-13	-12	-14	-7	-8	-6	-9	-10	-6	-10	-13	-12	-3	0		
	50	-19	-17	-20	-12	-25	-23	-13	-12	-26	-22	-24	-13	-14	-13	-17	-16	-14	-18	-24	-17	-5	0		
	75	-32	-23	-26	-17	-33	-28	-20	-17	-34	-30	-36	-18	-20	-20	-24	-22	-19	-26	-33	-21	-8	0		
	100	-43	-29	-32	-21	-40	-33	-24	-21	-39	-38	-42	-23	-24	-25	-30	-28	-24	-31	-40	-24	-10	0		
2091-2100	0	119,1	148,9	296,8	85,7	646,1	108,5	113,5	215,1	72,8	180,6	53,7	459,5	291,8	429,1	319,2	358,3	22,2	175,5	68,1	38,4	41,6	0,3		
	25	-18	-9	-18	-11	-16	-11	-10	-8	-12	-10	-12	-8	-4	-9	-8	-13	-5	-16	-11	-8	-3	-1		
	50	-33	-24	-27	-22	-24	-24	-20	-15	-22	-20	-30	-18	-9	-16	-15	-21	-9	-27	-20	-14	-5	-2		
	75	-42	-29	-31	-28	-31	-36	-27	-21	-30	-29	-36	-26	-14	-25	-20	-30	-13	-34	-27	-27	-6	-3		
	100	-45	-33	-40	-34	-37	-42	-34	-27	-36	-37	-41	-38	-18	-31	-26	-36	-18	-40	-35	-23	-7	-4		



Region legend: 121 - Île-de-France; 131 - Champagne-Ardenne; 132 - Picardie; 133 - Haute-Normandie; 134 - Centre; 135 - Basse Normandie; 136 - Bourgogne; 141 - Nord-Pas-de-Calais; 151 - Lorraine; 152 - Alsace; 153 - Franche-Comté; 162 - Pays de la Loire; 163 - Bretagne; 164 - Poitou-Charentes; 182 - Aquitaine; 183 - Midi-Pyrénées; 184 - Limousin; 192 - Rhône-Alpes; 193 - Auvergne; 201 - Languedoc-Roussillon; 203 - Provence-Alpes-Côte d'Azur

Due to the high demand for future irrigation water (refer to **figure 3**), limiting water withdrawals by imposing taxes could have an impact on the productivity of the agricultural sector. Policy maker will have to consider different options to cope with these effects.

### **Conclusions**

Given the present agricultural withdrawals and the potentially harmful consequences of CC on the resource's availability, the development of appropriate modelling tools is essential for integrated water management. For this purpose, we developed a prospective approach based on AROPAJ-STICS association and focused on the link between climate, crop yields and water inputs. Simulations were performed for three climate projections (SRES A1b, A2 and B1) from 2010 to 2100. The objective is to estimate the requested irrigation quantities in a context of gross margin maximization, independently of a water supply limit. Our results suggest an increase in water demand from 2010 to 2100 particularly marked for the most extreme scenarios A2 and A1b. Nevertheless, irrigation trajectory is irregular due to the inter-annual variability of the rainfall pattern. The realization of cartographic representations at the France scale illustrates the great capacity of the method to grasp the regional diversity of farming systems. This spatial analysis highlights the existence of disparate irrigation practices at the regional level, mainly concentrated in the western and southeastern parts of France. Most irrigated regions such as Aquitaine, Poitou-Charentes or Pays de la Loire would be characterized by the largest increase in demand from the 2011-2020 decade to the 2091-2100 decade. In this paper, scenarios of rising water prices are simulated to illustrate the medium-term importance of pressure on resource in a context of CC. As expected, rising costs would contribute to a decline in demand, highly differentiated by region. The most affected would correspond to the most irrigated in absolute and relative terms. An interesting perspective of this study would be to evaluate the effect of different levers of agriculture practices adaptation such as changes in sowing dates and varietal choices in a CC context. It is also envisaged to extend this approach to all European countries for several RCP scenarios proposed by the IPCC-AR5.

### **References**

- Brisson N., Gary C., Justes E., Roche R., Mary B., Ripoche D., Zimmer D., Sierra J., Bertuzzi P., Burger P., Bussi re F., Cabidoche, Y. M., Cellier P., Debaeke P., Gaudill re J. P., H nault C., Maraux F., Seguin B., Sinoquet, H. (2003). An overview of the crop model stics. *European Journal of Agronomy*, 18(3–4), 309–332.
- Cantelaube, P., Jayet, P. A., Carr , F., Bamps, C., & Zakharov, P. (2012). Geographical downscaling of outputs provided by an economic farm model calibrated at the regional level. *Land Use Policy*, 29(1), 35–44.
- Chakir, R. (2009). Spatial Downscaling of Agricultural Land-Use Data: An Econometric Approach Using Cross Entropy. *Land Economics*, 85(2), 238–251.
- Cortignani, R., & Severini, S. (2009). Modeling farm-level adoption of deficit irrigation using Positive Mathematical Programming. *Agricultural Water Management*, 96(12), 1785–1791.
- Eaufrance – “Les pr l vements en eau en 2009 et leurs  volutions depuis 10 ans”. From <http://www.eaufrance.fr/ressources/documents/chiffres-statistiques-les>

- Godard C., Roger-Estrade J., Jayet P. A., Brisson N., Le Bas C. (2008). Use of available information at a European level to construct crop nitrogen response curves for the regions of the EU. *Agricultural Systems*, 97(1–2), 68–82.
- Graveline, Nina, & Mérel, P. (2014). Intensive and extensive margin adjustments to water scarcity in France’s Cereal Belt. *European Review of Agricultural Economics*, 41(5), 707–743.
- Humblot P. (2016). Impacts du changement climatique sur l’agriculture Européennes : vers une meilleure prise en compte de la ressource en eau dans la modélisation bio-économique. Thèse en Sciences de l’environnement, AgroParis Tech.
- Humblot P., Jayet P.-A., Petsakos A. (2017). Farm-level bio-economic modeling of water and nitrogen use: Calibrating yield response functions with limited data. *Agricultural Systems*, 151, 47–60.
- Kampas, A., Petsakos, A., & Rozakis, S. (2012). Price induced irrigation water saving: Unraveling conflicts and synergies between European agricultural and water policies for a Greek Water District. *Agricultural Systems*, 113, 28–38.
- Leclère D., Jayet P.-A., De Noblet-Ducoudré N. (2013). Farm-level Autonomous Adaptation of European Agricultural Supply to Climate Change. *Ecological Economics*, 87, 1–14
- Observation and Statistics Department – Geography and indicators related to sustainable development. From [http://geoidd.developpement-durable.gouv.fr/geoclip\\_stats\\_o3/](http://geoidd.developpement-durable.gouv.fr/geoclip_stats_o3/)

## **FARMERS' ATTITUDES AND BEHAVIORAL INTENTIONS TOWARDS BIODIVERSITY CONSERVATION: THE CASE OF FARS PROVINCE, IRAN**

Hamideh MALEKSAEIDI<sup>1</sup>, Marzieh KESHAVARZ<sup>2\*</sup>

<sup>1</sup>University of Kurdistan, Department of Agriculture, Iran

<sup>2</sup>Department of Agriculture, Payame Noor University, P.O. Box 19395-3697, Tehran, Iran

\*Corresponding author: keshavarzmarzieh@pnu.ac.ir

### **Abstract**

Biodiversity is globally recognized as a foundation stone of healthy ecosystems, and biodiversity conservation is increasingly becoming one of the important aims of environmental management. In spite of this fact, human-driven land-use changes, especially during the last century, have already caused decline in biodiversity. In this regard, the intensification and expansion of modern agricultural practices in many countries has led to the biological simplification of the farmed environment and has declined farmland biodiversity during the last century. Since attitudes and intentions towards viability of specific conservation practices strongly impact human decisions on adoption of these practices and change, this study aimed to investigate farmers' attitude and intention towards biodiversity conservation. A survey was conducted by questionnaire in Fars province, southwest of Iran, and data was collected from 274 farmers, who were selected using stratified random sampling. The results of the study showed that age, education and knowledge have significant effects on attitude towards biodiversity conservation. Also, attitude towards biodiversity conservation, skill to use strategies for biodiversity conservation and perception of the impacts of agricultural practice on biodiversity had significant and direct effects on the farmers' intention towards biodiversity conservation. The findings of this study could be used by planners and policy-makers to improve farm biodiversity in different parts of the world.

**Keywords:** *Agriculture, Attitude, Biodiversity, Farmers' intention, Iran.*

### **Introduction**

Agricultural landscapes host wild biodiversity of many types, with neutral or even positive effects on ecosystem, agricultural production and livelihoods (Scherr and McNeely, 2008). While agriculture is a dominant land use worldwide with approximately 40% of the land's surface used for production of food and fiber, it has become one of the main drivers reducing wild flora and fauna species in the world since the start of the 20th century (Park, 2015). The expansion and intensification of agriculture activities such as increasing availability of modern hybrid species, extensive usage of pesticides and fertilizers, rapid land use changes and forest clearance for agricultural use and for harvesting timber and wood fuels have generated fundamental changes in plant species composition, vegetation structure, soil chemistry, and consequently the flora and fauna depending on these ecosystem fundamentals (Scherr and McNeely, 2008; Greiner, 2015; Coromaldi et al., 2015). These changes in farming practices and management styles have caused biological simplification of the farmed environment during the last century (Greiner, 2015; Park, 2015; Deng et al., 2016).

In Iran there is about 16.5 million hectares of farm land which currently are being utilized for agricultural production (Statistical Centre of Iran, 2014). Although, many parts of Iran are dry, the complex and varied climates, topography and geological formations have led to a varied and unique biological diversity in this country. Iran's biodiversity contains some of the world's important genetic resources, being the home of the original stocks of plant and animal species of great commercial value (The Fifth National Report to the Convention on Biological Diversity, 2015). In spite of this fact, the level of biodiversity in Iran has faced many different threats, especially in the last decades. Many valuable species have become extinct due to human ambitions; the level of forest coverage has significantly decreased; and more than 70% of protected areas and over 50% of wildlife sanctuaries will need a long time to restore due to excessive exploitation of vegetation (The Forth National Report to the Convention on Biological Diversity, 2010). Threats such as population growth, competition over the exploitation of water resources besides other destructive human activities such as land use changes, especially in the agricultural sector still threat biodiversity in Iran (Cheetah-CHECCO institute, 2016).

While biodiversity conservation on the agricultural landscapes is necessary for the ecological stability and productivity in natural ecosystems, it depends on a set of factors, such as soil condition, water availability, climate, and management aspects, intensity of farming methods, and scale of use (Henle et al., 2008). Farmers as the main farm managers can administrate biodiversity at many scales. Farmers interact with different components of biodiversity at several spatial scales: from local fields and their surroundings; to the layout of agro-ecosystems at the farm level; and across the landscape at larger scales (Jackson et al., 2010). Therefore, management decisions which they apply to their farmlands could potentially affect biodiversity in agricultural landscapes (Guillem et al., 2015).

While farmers are the key players both in agriculture and biodiversity conservation on the farmlands, many studies (Herzon and Mikk, 2007; Ahnström et al., 2008) have shown that farmers behavior and the way that they manage their farms and participate in environmental support schemes depends on their attitudes and intentions towards the environment. Therefore, this research aims to explore farmers' attitude and intention towards biodiversity conservation on the farmlands in Fars province, southwest of Iran.

## **Material and Methods**

This study was conducted in Fars province, southwest of Iran. The target population of the study was all farmers who lived and worked in this area. The sample size ( $n=274$ ) was determined based on the formula suggested by Scheaffer et al. (1979). A multistage stratified random sampling technique was used to select the study sample. Data for this cross-sectional survey study were collected using a questionnaire and face-to face interviews. Face validity of the scale applied for the study was confirmed by a panel of experts. To examine the reliability of the questionnaire, a pilot study was conducted on 30 farmers in a region outside of the study area. Cronbach's alpha for the items of Likert-type scales were 0.61-0.80.

## **Results and Discussion**

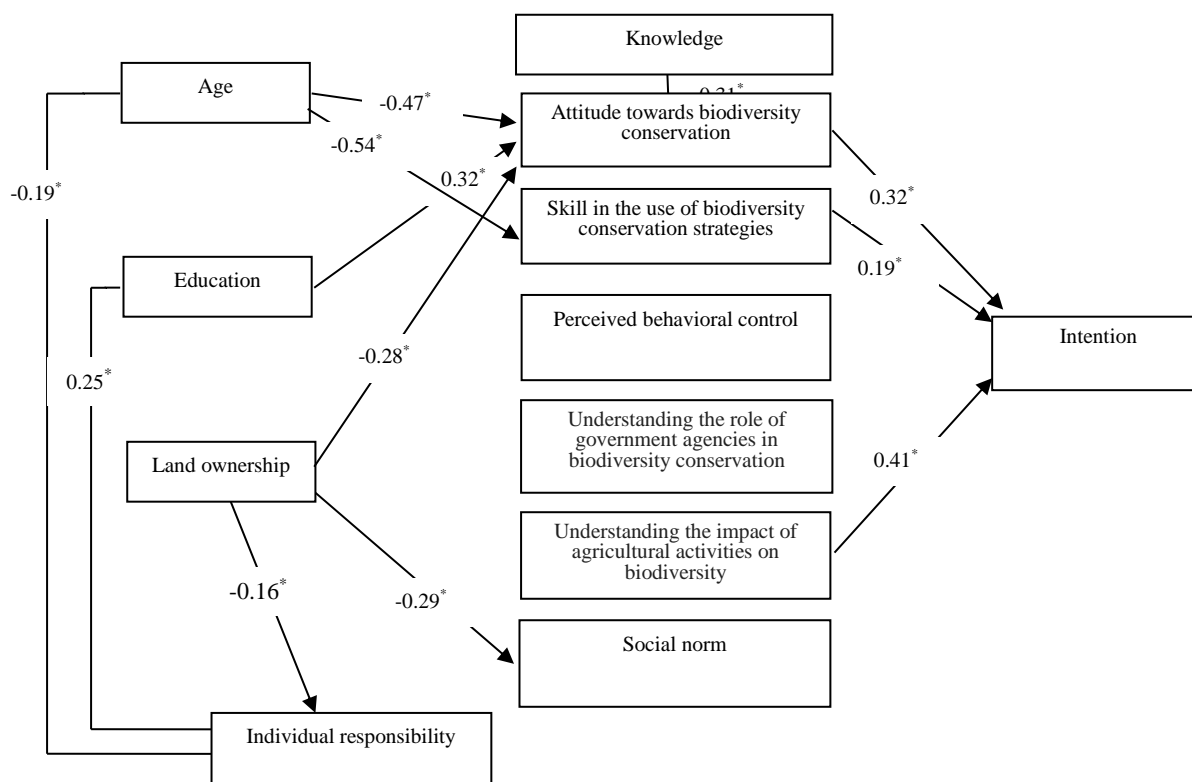
### ***Profile of the participants***

Participants were aged from 25 to 70 and their average age was about 47 years ( $SD=12.37$ ). The mean education level of farmers was 5.53 years of schooling ( $SD=5.18$ ). The average land ownership was 5.50 hectares ( $SD=4.23$ ) which indicated that most farmers were smallholders.



**Farmers' attitude and intention towards biodiversity conservation**

The model for independent variables and intention towards biodiversity conservation (Fig. 1) was used as a cause and effect chain to work out a path analysis. The path coefficients showed that the direct effects of some variables on the others were not significant. So, in the final model (Fig. 1), these paths were deleted for a better understanding of the relations between independent variables with attitude and intention towards biodiversity conservation.



**Figure 1.** Path diagram of variables influencing attitude and intention towards biodiversity conservation. The path coefficients are linear and standardized (B). The significance of test is: \*0.05 ≥ p > 0.01 and \*\*0.01 ≥ p > 0.001.

Fig. 1 shows that age (-0.47) and land ownership (-0.28) have significant negative effects on farmers' attitude at the 0.05 level. The negative impact of age on attitude is consistent with the findings of the study by Abebaw and Virchow (2006). It is likely to be due to the fact that older people have beliefs that are institutionalized within them, and that the change in these beliefs is more difficult and time consuming. The negative impact of land ownership on the attitude is probably due to the fact that large landowners, unlike smallholder farmers, often live in urban areas and do not belong to the village. Therefore, they are seeking their own commercial interests, rather than considering biodiversity conservation in rural areas. According to Fig. 1, education and knowledge are the two other variables that have a significant effect on attitude at the 0.05 level. The positive effect of education (0.32) and knowledge (0.31) on attitude suggests that people with higher knowledge and higher education level are more aware of the value of biodiversity and thus have a more positive attitude toward maintaining this natural capital.

As shown in Fig. 1, the variable understanding the impact of agricultural activities on biodiversity has the most significant positive and significant effect ( $\beta=0.41$ ;  $P= 0.05$ ) on farmers' intention to maintain biodiversity in the farm and outside the farm. This finding shows farmers who believe conventional agriculture is currently unsustainable and produces low quality products have higher positive attitude towards biodiversity conservation. This

finding is consistent with the findings of Alelign et al. (2011). After understanding the impact of agricultural activities on biodiversity, the variables of attitudes toward biodiversity conservation and skills in using biodiversity conservation strategies, respectively, have the most positive and significant effects on farmers' intention to preserve biodiversity. The direct effect of the attitude ( $\beta=0.32$ ,  $P=0.05$ ) is congruent with the findings of the study by Abebaw and Virchow (2006) and Kibert (2000).

### **Conclusions**

In this study we revisited factors affecting attitude and intention towards biodiversity among farmers in Fars Province, Iran. Findings showed that age, land ownership, education and knowledge have significant effects on farmers' attitude towards biodiversity conservation. Also, attitude towards biodiversity conservation, skill to use strategies for biodiversity conservation and perception of the impacts of agricultural practice on biodiversity had significant and direct effects on the farmers' intention towards biodiversity conservation. As the findings of this study indicated various factors, directly or indirectly, interact with each other on the attitude and intention towards biodiversity conservation. Given the importance of the issue, a larger national-level study on farmers can provide more significant evidence of the role of knowledge, attitudes and other variables on biodiversity conservation, and thus provide the framework for accurate planning to improve and to preserve this huge national capital in the country.

### **References**

- Abebaw, D. and V. Detlef. (2006). The microeconomics of household collection of wild coffee in Ethiopia: Some policy implications for in-situ conservation of *coffea arabica* genetic diversity. Center for Development Research (ZEF), Bonn, Germany.
- Ahnström, J., Höckert, J., Bergea°, H.L., Francis, Ch.A., Skelton, P. and Hallgren, L. (2008). Farmers and nature conservation: What is known about attitudes, context factors and actions affecting conservation?. *Renewable Agriculture and Food Systems*, 24(1), 38–47.
- Alelign, A., Y. Yemshaw, D. Teketay and E. Sue. (2011). Socio-economic factors affecting sustainable utilization of woody species in Zegie Peninsula, northwestern Ethiopia. *Tropical Ecology*, 52(1): 13-24.
- Cheetah-CHECCO institute. (2016). Losses of biodiversity in Iran. Available on: <http://cchbio.com/index.php/en/loss-of-biodiversity/104-loss-of-biodiversity-in-iran> (accessed April 19, 2016).
- Coromaldi, M., Pallante, G. and Savastano, S. (2015). Adoption of modern varieties, farmers' welfare and crop biodiversity: Evidence from Uganda. *Ecological Economics*, 119, 346–358.
- Deng, J., Sun, P., Zhao, F., Han, X., Yang, G. and Feng, Y. (2016). Analysis of the ecological conservation behavior of farmers in payment for ecosystem service programs in environmentally fragile areas using social psychology models. *Science of the Total Environment*, 550, 382–390.
- Greiner, R. (2015). Motivations and attitudes influence farmers' willingness to participate in biodiversity conservation contracts. *Agricultural Systems*, 137, 154–165.
- Guillem, E.E., Murray-Rust, D., Robinson, D.T., Barnes, A. and Rounsevell, M.D.A. (2015). Modelling farmer decision-making to anticipate tradeoffs between provisioning ecosystem services and biodiversity. *Agricultural Systems*, 137, 12–23.

- Henle, K., Alard, D., Clitherow, J., Cobb, P., Firbank, L., Kull, T., McCracken, D., Moritz, R.F.A., Niemelä, J., Rebane, M., Wascher, D., Watt, A. and Young, J. (2008). Identifying and managing the conflicts between agriculture and biodiversity conservation in Europe—A review. *Agriculture, Ecosystems and Environment*, 124, 60–71.
- Herzon, I. and Mikk, M. (2007). Farmers' perceptions of biodiversity and their willingness to enhance it through agri-environment schemes: A comparative study from Estonia and Finland. *Journal for Nature Conservation*, 15, 10-25.
- Jackson, L., van Noordwijk, M., Bengtsson, J., Foster, W., Lipper, L., Pulleman, M., Said, M., Snaddon, J. and Vodouhe, R. (2010). Biodiversity and agricultural sustainability: from assessment to adaptive management. *Current Opinion in Environmental Sustainability*, 2, 80–87.
- Kibert, N.C. (2000). An analysis of the correlations between the attitude, behavior, and knowledge components of environmental literacy in undergraduate university students. A thesis presented to the graduate school of the University of Florida in partial fulfillment of the requirements for the degree of master of science, University of Florida.
- Park, K.J. (2015). Mitigating the impacts of agriculture on biodiversity: Bats and their potential role as bio indicators. *Mammalian Biology*, 80, 191–204.
- Scheaffer, R.L., Mendenhall, W. and Ott, L. (1979). *Elementary Survey Sampling*. Duxbury Press, Belmont.
- Scherr, S.J. and McNeely, J.A. (2008). Biodiversity conservation and agricultural sustainability: Towards a new paradigm of 'ecoagriculture' landscapes. *Philos Trans R Soc Lond B Biol Sci.*, 363(1491), 477–494.
- Statistical Center of Iran.(2014). Statistical yearbook 2013-2014. Available on: [http://www.amar.org.ir/Portals/0/Files/fulltext/1393/n\\_tsokkk\\_93-v3.pdf](http://www.amar.org.ir/Portals/0/Files/fulltext/1393/n_tsokkk_93-v3.pdf) (Accessed 29 April 2016)
- The Forth National Report to the convention on Biological Diversity. (2010). Available on: <https://www.cbd.int/doc/world/ir/ir-nr-04-en.pdf>(accessed April 19, 2016).
- The Fifth National Report to the convention on Biological Diversity. (2015). Available on: <https://www.cbd.int/doc/world/ir/ir-nr-05-en.pdf> (accessed April 19, 2016).

## GREEN AREA PERFORMANCE OF SOME COOL SEASON TURFGRASSES PLANTED WITH DIFFERENT SEEDING RATIOS

Ilknur AYAN<sup>1\*</sup>, Asunan SAYGIN<sup>1</sup>, Mehmet CAN<sup>1</sup>, Hanife MUT<sup>2</sup>, Zeki ACAR<sup>1</sup>

<sup>1</sup>OMU Agricultural Faculty Atakum , Samsun , Turkey

<sup>2</sup>BOZOK University Agricultural Faculty , Yozgat , Turkey

\*Corresponding author: ilknuray@omu.edu.tr

### Abstract

This study was conducted to determine different mixture ratios of some cool season grasses with factorial design at randomized blocks with 6 replicates in ecological conditions of Samsun, Northern Turkey in 2016. In this research, *Lolium perenne* (Lp), *Poa pratensis* (Pp), *Festuca arundinacea* (Fa), *Festuca rubra rubra* (Frr), *Festuca ovina* (Fo), *Agrostis tenuis* (At) species and different mixture ratios of these species were used as material. The nursery trial was planned as 4 different mixtures, i) 45%Lp+40%Frr+15%Pp, ii) 30%Lp+35%Frr+15%Fo+10%Pp+10%At, iii) 45%Fa+40%Frr+15%Pp, iv) 30%Fa+15%Fo+35%Frr+10%Pp+ 10%At; 2 solely treatments (Lp and Fa ); 4 seeding rates (30,40,50,60 g<sup>-1</sup>m<sup>2</sup>). While time values to emergence were 43-53 days for Lp and its mixtures, these values were changed between 53-64 days for Fa mixtures. All the plots were moved 5 times and green herbage yield was altered from 13.1 to 934.0 g<sup>-1</sup>m<sup>2</sup> according to the plots. The highest green herbage yield was obtained from 45% Fa + 45% Frr + 15% Pp mixture and 40 g<sup>-1</sup>m<sup>2</sup> sowing rate plots. The least weed ratios were observed in the mixture of Fa. Additionally, as seeding ratios increased, weed ratio was decreased.

**Key words:** *Cool season grasses seeding ratio, weed ratio.*

### Introduction

Green area requirement of people increases day by day for some reasons like as rapid population increase, unplanned and dense settlement, industrialization, decrease of green vegetation cover both in urban and country. But, a green area that is a lateral component of natural environment is very important for physical and psychological health of human (Gül and Avcioglu, 1999). The most important part of outdoor is turfgrass covered areas. These areas are used commonly for improve architectural, scenery and aesthetic quality. Additionally, turfgrass is an indispensable part of recreational areas and it creates a peaceful and relaxing atmosphere for humanity (Avcioglu *et al.*, 1998; Acikgöz, 1994). In order to fulfil their functions, during establishment process most suitable grasses should be chosen in addition to nursing (Avcioglu and Soya, 1996). Heat and drought are the most important factors limited growing of grasses during summer period (Jiang and Huang, 2001). Before choose the grasses, we have to know their usage aim, ecological conditions, sustainability and view of them (Harivandi *et al.*, 1984). An ideal turfgrass area should be homogeny and look like a carpet. To obtain this result, we should determine suitable grass species and cultivars and mixture rates (Avcioglu, 1995; Avcioglu and Soya, 1996; Oral and Acikgoz, 2002). Aim of this study is to determine the performance of some cool season grasses at different mixture rates in Samsun ecological conditions.

## Material and Methods

This study was carried in Çarsamba County of Samsun province in 2016. The experiment was planned as factorial design at randomized blocks with six different mixtures and sowing rates. In this research, *Lolium perenne* (Lp), *Poa pratensis* (Pp), *Festuca arundinacea* (Fa), *Festuca rubra rubra* (Frr), *Festuca ovina* (Fo), *Agrostis tenuis* (At) species and different mixture ratios of these species were used as material. The nursery trial was planned as 4 different mixtures, i) 45%Lp+40%Frr+15%Pp, ii) 30%Lp+35% Frr+15%Fo+10%Pp+10%At, iii) 45%Fa+40%Frr+15%Pp, iv) 30%Fa+15%Fo+35%Frr+ 10%Pp+ 10%At; 2 solely treatments (Lp and Fa ); 4 seeding rates (30,40,50,60 g<sup>-1</sup> m<sup>2</sup>). Average temperature and total precipitation were 15.7°C and 916.1 mm respectively at experiment site in 2016. Soil of experiment site is clay-loam, slightly alkaline (pH=7.67), lime is medium (7.33%), saltless (EC dsm<sup>-1</sup>0.186), organic matter is low (1.71%), phosphorus is high (62.57 kg/da<sup>-1</sup>) and potassium is enough (43.69 kg/da<sup>-1</sup>). Consider the soil analysis, 5 kg N and 6 kg P<sub>2</sub>O<sub>5</sub> was applied at sowing time. Later, regard the growing performance of plants 10 g N m<sup>-2</sup> was given every month. Area was irrigated with sprinkler after every cut, if necessary. The experiment was established at November 11, 2015. The cuts were made when the plants reach to 15-20 cm height. Five cuts were made in the first year. The cutting dates were April 30, June 2, June19, July 30 and October 22, 2016. In spite of irrigation, there were no enough growing during August and September, because of cool season grasses. Resultant data were subjected to statistical analysis with SPSS 17.0 software. Differences in means were tested with Duncan's multiple range tests.

## Results and Discussion

Time values to emergence and green herbage yield of *Lp*, *Pp*, *Fa*, *Frr*, *Fo*, *At* species and different mixture ratios of these species are provided in Table 1. When consider time the emergence differences amongst the mixtures and sowing rates were highly significant. The earliest 50% emergence was observed at *Lp* plots and its mixtures. Time to emergence was 37 days at 40, 50 and 60 g seed m<sup>-2</sup> with perennial ryegrass while it was 41 days for 30 g seed m<sup>2</sup> plots. The latest time to emergence was determined at solely *Fa* plots (64 days). Time to emergence was altered between 43-64 days for the other plots (Table 1). Genetics and soil temperature are the most important factors that affect time to emergence. In general, the earliest time to emergence can be obtained from perennial ryegrass compare to whole cool season grasses (Acikgoz, 1994; Avcioglu, 1997).

In terms of green herbage yield, significant differences were observed in fourth cut, but there was no difference in the other cuts. The highest green herbage yield was obtained from treatment 6 (45% Fa+45%Frr+15%Pp and 40 g m<sup>-2</sup> sowing rate) as 934 g m<sup>-2</sup>. Treatment 6 was followed by treatment 15 with 893 g m<sup>-2</sup> herbage yield. Solely perennial ryegrass sowing 30 g m<sup>-2</sup> sowing rate supplied the lowest herbage yield. Herbage yield of the other treatments were ranged between these values and most of them has been included in the same statistical group. As mean of the treatments, the highest green herbage yields were obtained from the first and third cuts, while the lowest was from the fifth cut (Table1 and Figure 1).

Table1. Time to emergence and green herbage yield values of some cool season turfgrass mixtures.

	Treatments	Amounts of seed (g <sup>-1</sup> /m <sup>2</sup> )	Time values to emergence (day)	Green herbage yield (g <sup>-1</sup> m <sup>2</sup> )				
				1. Cut	2. Cut	3. Cut	4. Cut	5. Cut
1	%45Lp+ %40 Frr+ %15 Pp	30	50 cd	550	375	123	354 de	18
2	%45Lp+ %40 Frr+ %15 Pp	40	45 de	490	472	130	388 c-e	18
3	%45Lp+ %40 Frr+ %15 Pp	50	43 e	670	463	116	361 de	20
4	%45Lp+ %40 Frr+ %15 Pp	60	43 e	680	486	98	624 a-e	19
5	%45 Fa+ %40 Frr+ %15 Pp	30	51 c	420	492	172	684 a-e	27
6	%45 Fa+ %40 Frr+ %15 Pp	40	53 bc	480	438	144	934 a	25
7	%45 Fa+ %40 Frr+ %15 Pp	50	53 bc	397	446	143	911 ab	26
8	%45 Fa+ %40 Frr+ %15 Pp	60	51 c	500	473	147	668 a-e	27
9	%30 Lp+ %35 Frr+ %15 Fo+ %10 Pp+ %10 At	30	55 bc	600	449	118	471 a-e	20
10	%30 Lp+ %35 Frr+ %15 Fo+ %10 Pp+ %10 At	40	55 bc	750	464	125	510 a-e	22
11	%30 Lp+ %35 Frr+ %15 Fo+ %10 Pp+ %10 At	50	51 c	607	483	123	494 a-e	19
12	%30 Lp+ %35 Frr+ %15 Fo+ %10 Pp+ %10 At	60	51 c	567	507	107	458 a-e	14
13	%30 Fa+ %35 Frr+ %15 Fo+ %10 Pp+ %10 At	30	59 ab	657	469	147	853 a-c	28
14	%30 Fa+ %35 Frr+ %15 Fo+ %10 Pp+ %10 At	40	59 ab	667	539	140	587 a-e	30
15	%30 Fa+ %35 Frr+ %15 Fo+ %10 Pp+ %10 At	50	64 a	557	451	134	893 ab	26
16	%30 Fa+ %35 Frr+ %15 Fo+ %10 Pp+ %10 At	60	64 a	617	376	135	847 a-c	26
17	%100Lolium perenne	30	41 ef	843	401	114	301 e	13
18	%100Lolium perenne	40	37 f	630	368	122	460 a-e	20
19	%100Lolium perenne	50	37 f	697	353	119	404 c-e	19
20	%100Lolium perenne	60	37 f	617	394	130	797 a-d	35
21	%100Festuca arundinacea	30	64 a	510	388	138	499 a-e	29
22	%100Festuca arundinacea	40	64 a	520	393	123	615 a-e	23
23	%100Festuca arundinacea	50	64 a	520	414	137	449 b-e	26
24	%100Festuca arundinacea	60	64 a	693	531	155	538 a-e	35
Avarege			52,29	593,19	442,6	130,85	587,50	23,40
Sx			1,90	21,52	10,74	3,31	39,70	1,18

In general there was less weed in mixtures with *Fa* and as the sowing rate increase, weed ratio was decreased. The lowest weed number was observed in third cut. Because, at the third cutting time cool season weeds were disappear and warm season weeds did not start to grow yet. The highest weed number was determined in the first cut. Turfgrass seedlings were very young at this time and probably could not compete with weeds (Figure 2).

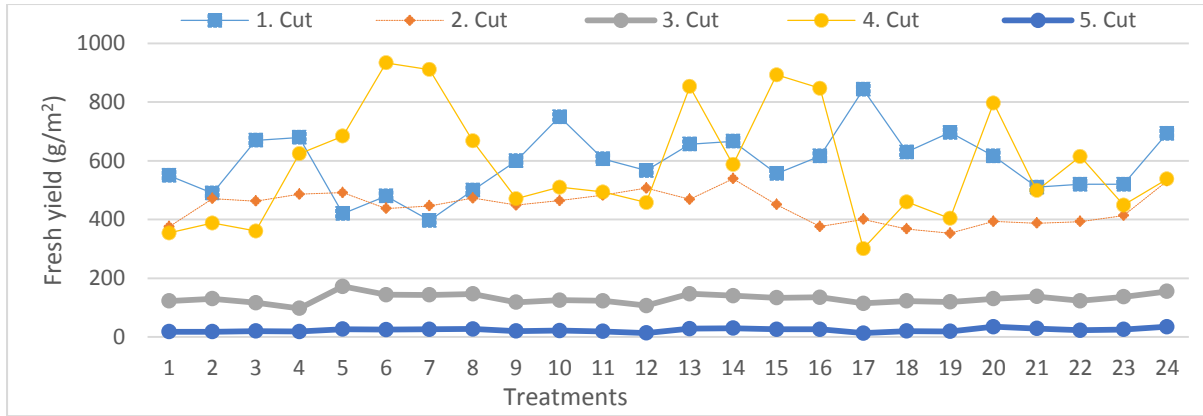


Figure1. Green herbage yield of some cool season turfgrass mixtures ( $\text{g}^{-1}\text{m}^{-2}$ )

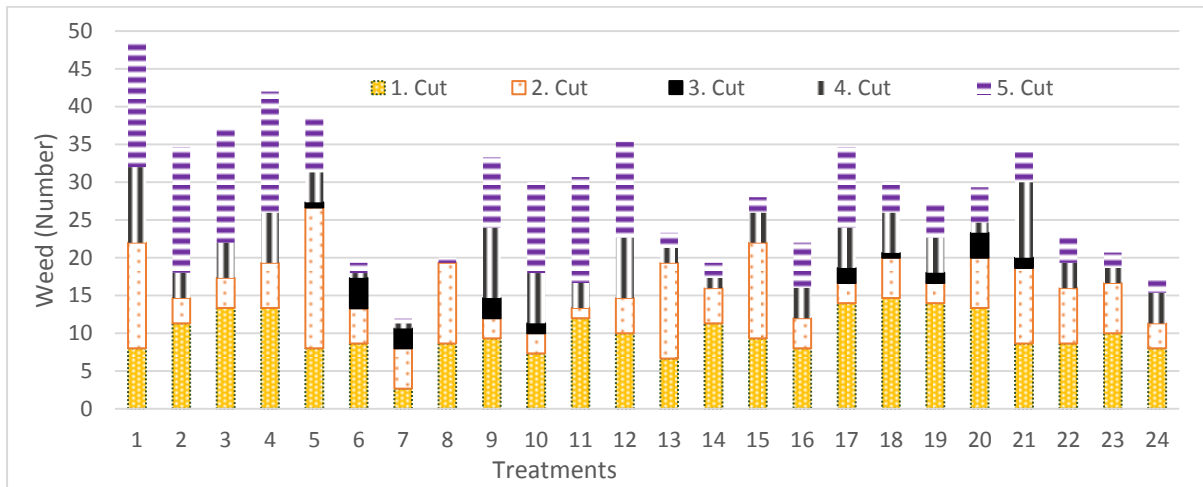


Figure2. Weed numbers in some cool season turfgrass mixtures.

## Conclusions

In this research that was conducted to determine the performance of some cool season turfgrass mixtures with different sowing rates, 5 cuts were made in 2016. The earliest time to emergence was observed in solely perennial ryegrass plots and its mixtures. It was determined that as sowing rate increase, weed number was decreased. Weeds had less chance to grow with in the mixtures consist of *Fa*, compare to the other treatments.

## References

- Açıkgöz, S., 1994. Çim Alanlar Yapım ve Bakım Tekniği. Çevre LTD Şirketi Yayınları, 4. BURSA
- Avcıoğlu, R., 1997. Çim Tekniği, Yeşil Alanların Ekimi, Dikimi ve Bakımı. Ege Üniv.Matbaası, Bornova İZMİR
- Avcıoğlu, R. ve Soya, H., 1996, Akdeniz İklimine Uygun Bazı Yeşil Alan Buğdaygillerinde Vejetatif Tohumluk Üretimi İle Vejetasyon Özellikleri Üzerinde Araştırmalar, TÜBİTAK Proje No: TOAG-879, Bornova-İzmir
- Avcıoğlu, R., Salman, A., Demiroğlu, G., ve Ereku, O. 1998. Ege Bölgesinde Yeşil Alanlara İlişkin Sorunlar ve Çözüm Önerileri. Ege Bölgesi 1.Tarım Kongresi: 265-271, 7-11 Eylül 1998, Aydın.

- Gül, A. Ve Avcıođlu, R., 1999. Ege Bölgesi Sahil Kuşaađında Çim Alan Oluşturmada Bazı Çim Türlerinin Performansının Araştırılması. Türkiye 3. Tarla Bitkileri Kongresi Cilt 3 143-148, 15-18 Kasım 1999, Adana.
- Harivandi, M.A., Dawis, W., Gibeault, V.A., Henry, M., Dam, j.V. And Wu, L., 1984. Selecting The Best Turfgrass. California Turfgrass Culture, 34(4):17-18
- Jiang, Y.W., Huang, B., 2001. Physiological Responses To Heat stress Alone Or In Combination With Drought: A Comparison Between Tall Fescue And Perennial Ryegrass. Hortscience, 36(4):682-686
- Oral, N. Ve Açıkgöz, E., 2002. Çim alanlar İçin Tohum Karışımları, TMMOB Ziraat Mühendisleri Odası, Bursa Şubesi Başkanlığı Yayınları:1, Bursa, 41 ss.



## IMPORTANCE OF IRRIGATION AND SOIL PROCESSING FOR GRAPEWINE CULTIVATION YIELD

Funda DÖKMEN<sup>1\*</sup>, Okan KARAMAN<sup>2</sup>

<sup>1</sup>Kocaeli University, Food and Agricultural Vocational School, Campus of Arslanbey, Arslanbey, Kartepe-Kocaeli, Turkey

<sup>2</sup>Agricultural Technician, Expertise of Horticulture, Farmer, Salihli- Manisa, Turkey

\*Corresponding author: f\_dokmen@hotmail.com; funda.dokmen@kocaeli.edu.tr

### Abstract

Turkey has ecological and extended vineyard areas for agricultural production. Many varieties and types of grapevines have been cultivated in our country. Aegean region is one of the important regions with intensive vineyard cultivation. Generally, without irrigation vineyard cultivation/production is done in Aegean region which has different ecological conditions for grapevine cultivation. Wild irrigation methods are more commonly used for irrigation. Effect of irrigation on yield is more important in relation to drought in winter and summer seasons regarding quality and also quantitative production. According to the researches, amount of irrigation water ranges between 110 mm and 120 mm for one application of irrigation which average amount in Aegean region. Deficit humidity in the root depth of grapevine is completed artificially by means of irrigation and usable humidity capture for more suitable level in the soil. Soil processing after irrigation effect on the yield has been positive. In this study, effects of capacity of soil humidity and soil processing on the grapevine yield and applied irrigation methods were explained for grapevine cultivation in Aegean region, Turkey.

**Keywords:** *Capacity of humidity, Evapotranspiration, Grapevine, Irrigation method, Irrigation period, Soil process.*

### Introduction

Adequate soil water availability, according to the phenological stage of the vines, must be maintained over the growing season in order to obtain good quality grapes (Jackson and Lombard, 1993; Deloire *et al.*, 2004). Deficit irrigation strategies have been successfully adopted as management tools to ensure an adequate balance between vine vegetative and reproductive development while preserving yield and water resources and improving fruit composition (Dry *et al.*, 2001; Intrigliolo and Castel, 2008). However, irrigation must be applied (amount and time) in accordance with the climate and soil characteristics of the region and the type of wine to be produced to avoid potential negative impacts on vine vigour, berry composition and wine quality. Several researchers showed that irrigation effects on the yield of grapevine depend on climatic conditions and soil process in vineyards (Avalos *et al.*, 2016). Stoimenov *et al.* (2012) explained irrigation and irrigation depth for soil and plant water regime relation to grapevine plantations. The goal of this research is to show soil processing on the grapevine yield and applied irrigation methods for grapevine cultivation in Aegean region, Turkey.

## Material and Methods

Grape is among the oldest cultivated fruits on the earth. It dates back to 5000 B.C. Being the gene center of grapevine, Turkey is located on the most favorable viticultural belt of the world. Aegean, Marmara, Mediterranean and Southeast Anatolian regions of Turkey are the territories where grape is cultivated (Fig.1).



Fig.1. Grapevine plantations in Salihli of Aegean region, Turkey.

## Results and Discussion

### *Most important principles for water requirements are to:*

- \*Know the symptoms on the vine of water stress
- \*Know the physiological stages when a lack of water will affect the size and quality of the crop
- \*Know the depth and size of the root system
- \*Know the soil in order to know what the storage capacity of the soil is for water
- \*Know how much water to apply

### *What kind of water in the soil?*

- \*Gravitational water Free drainage after irrigation/rainfall
- \*Drainage water
- \*Available water (between field capacity FC and permanent wilting point PWP)

### *Symptoms of water shortages* (Teubes, 2017)

- \*Irrespective of the previous critical physiological stages; vine will show physical symptoms of water shortages
- \*Important to recognize the symptoms to know when the vine requires irrigation
- \*Growing tip pulls back
- \*Tendrils orientation sags
- \*Leaf orientation away from sun
- \*Leaf petioles start to sag
- \*Yellow leaves in cluster zone
- \*Berries shrink

### ***How long must I irrigate?***

- \*Length of time of flood irrigation depends on Strength of water current from canal
- \*Length of furrow (Fig.2)
- \*Width of furrow (Fig.2)
- \*Rooting depth (depth of water penetration)
- \*Infiltration time to required depth
- \*Water losses through evaporation, drainage, etc.

If the above information is not available it will be very difficult to determine the correct time of an irrigation. Practical answer is to apply irrigation and to make a profile pit to determine the depth of wetting after 2 days (Teubes, 2017).



**Fig.2.** Furrow irrigation in the grapewine plantations

### ***When to irrigate?***

If the precipitation regime is irregular and insufficient, then irrigation is a must in vineyards. In areas where vine is cultivated in Turkey, precipitation is seen in winter or spring. Therefore, the water piling up in the soil meets the water needs of the plant until around mid-June. And after the harvest, vineyards must be irrigated in accordance with need (Fig.3).

Although the amount of irrigated water for maximum efficiency depends on the type of grape, rootstock and soil type, the amount of precipitation received by the plant during the vegetation phase, the yearly distribution of precipitation, the irrigation system and cultural practices. it is stated that the average value is around 150-200 mm.



**Fig.3.** Drip irrigation in the grapewine plantations

### ***Soil Processing***

The roots of grapewine plant go deep. This is why this plant is suitable for soft-textured soil. Since vineyards grow ideally in dry areas or in areas with small amount of precipitation, it is desired that the vineyard soil be deep and of high water retention capacity. Grapewine can grow even in poor soil conditions as long as the soil structure allows the roots to grow.

On locations with high water retention capacity, drainage precautions are taken. The grapewine plant depends on the conditions of wellness under the soil for growing its roots deep down. In loamy sandy soils, the roots go very very deep. Vineyard soil must be plowed at least 40 cm deep (Fig.4)

In viniculture plowing helps with the struggle against weeds, the airing out and warming up of the soil, the facilitation of the receptability of the nutrients within the soil and the prevention of losses, the increasing of soil's water retention capacity, the prevention of water loss as a result of breaking the duff layer caused by irrigation or precipitation and the mixing of fertilizers with soil.



**Fig.4.** Soil processing in the grapewine plantations

### **Conclusion**

For good quality and efficiency, irrigation according to need is a must. Irrigation increases efficiency by 0-40%. In Turkey, irrigation is applied especially in the seedless vineyards located in the Lake District and the Eagean Region. In vineyards with dry or semi-dry climate conditions, irrigation must be applied. Types of irrigation are furrow, overhead sprinkler systems, micro jets and drip systems. Grapevines have good resistance to salinity. Water for

irrigation containing saline salts and/or elements which has direct and indirect effects on the plant.

The main reason of plowing 20-25-cm-deep in autumn is to allow the precipitation water received throughout the winter to be absorbed well by the soil, thus increasing the water retention capacity of the soil. The reason of plowing more shallowly (10-15-cm-deep) in spring and summer is weed-control and letting the soil breathe, thus preventing water loss.

### **Acknowledgement**

This study is supported by Tariş (Raisins Agricultural Sales Cooperatives Union), Gübretaş (Turkish Manure Factories) and Çökelek/Salihli Tarım Kredi Kooperatifi (Agricultural Credit Cooperative) in Turkey. Authors would like to thanks for all of them

### **References**

- Avalos J.M.M., Cordoba E.T., Cid Y.B. and Fernandez I.O., 2016. Irrigation effects on the performance of grapevine (*Vitis Vinifera* L.) CV ‘Albarino’ under the humid climate of Galicia. *OENO One, Vine and Wine Open Access Journal*, 50 (4), 183-194.
- Intrigliolo D.S. and Castel J.R., 2008. Effects of irrigation on the performance of grapevine cv. Tempranillo in Requena, Spain. *Am. J. Enol. Vitic.*, 59, 30-38.
- Deloire A., Carbonneau A., Wang Z.P. and Ojeda H., 2004. Vine and water: a short review. *J. Int. Sci. Vigne Vin*, 38, 1-13.
- Dry P.R., Loveys B.R., McCarthy M.G. and Stoll M., 2001. Strategic irrigation management in Australian vineyards. *J. Int. Sci. Vigne Vin*, 35, 129-139.
- Jackson D.I. and Lombard P.B., 1993. Environmental and management practices affecting grape composition and wine quality. *Am. J. Enol. Vitic.*, 44, 409-430.
- Stoimenov G., Kirkova Y. and Petrova V., 2012. Soil and Plant Water Regimes Evaluation of Grapevine Plantations, BALWOIS 2012, Ohrid, Republic of Macedonia.
- Teubes A., 2017 Water requirements for grape vines, Viticultural consultant.

## WATER HARVESTING TECHNIQUES FOR CONSERVATION OF SOIL AND WATER EROSION

Meryem KUZUCU<sup>1</sup>, Funda DÖKMEN<sup>2\*</sup>, Ayşe GÜNEŞ<sup>3</sup>

<sup>1</sup>Agriculture Provincial Directorate Kilis, Turkey

<sup>2</sup>Kocaeli University, Food & Agricultural Vocational School, Campus of Arslanbey, Kartepe, Kocaeli, Turkey

<sup>3</sup>Harran University, Agricultural Vocational School, Şanlıurfa, Turkey

\*Corresponding author: f\_dokmen@hotmail.com

### Abstract

Water is an important natural resource in arid areas. The rainfall is usually lost from the surface like runoff and evaporation in these regions. Gathered rainwater is used for agricultural production in arid region. Water harvesting is an old tradition in many countries in the world and water harvesting techniques are used for thousand years. It was developed in order to obtain drinking and domestic water for people. Water harvesting systems in semi-arid areas feed from precipitation and it supplies enough water for human life. Water harvesting is the best way to increase the amount of water per unit of cultivated area. It is reduce impact of drought and surface flow. Water harvesting systems help to reduce environmental damage, increase of plant vegetation and prevent to soil and water erosion. Some strong runoff which is caused erosion therefore these must be stored in the soil profile by water harvesting practices. Sloping land is available for water and soil erosion in semi-arid climate. This study explained that on the importance of rainwater harvesting on soil moisture and conservation. Rainwater is one of the natural resources when collecting water in the soil for agricultural cultivation. Water harvesting techniques help to local farmers and also to take advantage in terms of alternative irrigation for pistachio orchards in dry agricultural areas in Souteastern Anatolia Region in Turkey.

**Keywords:** *Dry areas, Soil conservation, Water conservation, Water harvesting.*

### Introduction

Precipitation is generally insufficient to supply basic needs for crop production in semi-arid areas. Usually rain water lost with evaporations and runoff, leaving commonly dry seasons during the rearing period. Total annual rainfall enough to sustainable farm needs in agricultural land, this is often distributed very unevenly so that long dry periods are interspersed with periods of intense rainfall. In many cases, a crop is unable to use a high proportion of this water, as much of its lost through runoff or leaching. This may cause soil erosion and loss of soil nutrients. Even in places with relatively abundant water resources, it is not sufficient to meet the water demand of crop growth all the year round. With increasing acreage of crop growing, unreasonable crop planting structure, high irrigation quota, and low water use efficiency, the shortage of water resources is becoming increasingly serious (Shen *et. al.*, 2013). Transfer of irrigation management responsibilities from government agencies to farmers has been made as an important policy in many countries (Mishra *et. al.*, 2013). As a result, farmers' participation in irrigation management has taken the center stage and the irrigators who were considered as beneficiaries are now considered partners in planning, development, operation and maintenance of irrigation systems (Parthasarathy, 2000). Water harvesting techniques defined in this study aim to maximise the available water through water harvesting and conservation. Water harvesting techniques gather water from an area

termed the 'catchment area' and channel it to the cropping area or wherever it is required. Conservation techniques, conserve water within the biomass and the soil by reducing run-off and keeping the water where it falls, as much as possible. In deciding which techniques to use to make more efficient use of the available water, it is important to consider how crops receive or lose water.

Crops receive water through rainfall, irrigation and stored soil water. Rain-water loses through run off, evaporation and drainage. Soil stores water from rainfall providing a reserve that is available to the crop? How much water is available depends on the soil type and the rooting system of the crop. Sandy soils hold much less water than clay or silt soils, so crops will require watering more often. Run off is where water is not absorbed by the soil but runs across the surface away from where the crop can use it. Structures such as contour schemes, terracing, pits and bunds can reduce run-off. Run off is more likely to occur on silt or clay soils where the surface has been subjected to intense rainfall then baked in the sun to form a crust or cap. Adding mulch to break up the intensity of rainfall, or adding manure, compost or incorporating green manure residues will reduce the tendency of the soil to form a crust (FAO, 1991).

Water that evaporates directly from bare soil is wasteful as it is not being used for productive plant growth. It is desirable to maintain full ground cover for as much of the time as practically possible. Applying mulch to the soil will also reduce evaporation considerably. Use of drip irrigation and irrigating in the evening will also reduce the amount of water lost through evaporation. When water drains out of the soil, not only is it wasted but essential mobile nutrients such as nitrogen are also washed out. This is more of a problem on light sandy soils. Adding organic matter in the form of compost, manures or plant residues will eventually increase the amount of water a soil can retain, but this will only have an effect if it is added over a longer period of years.

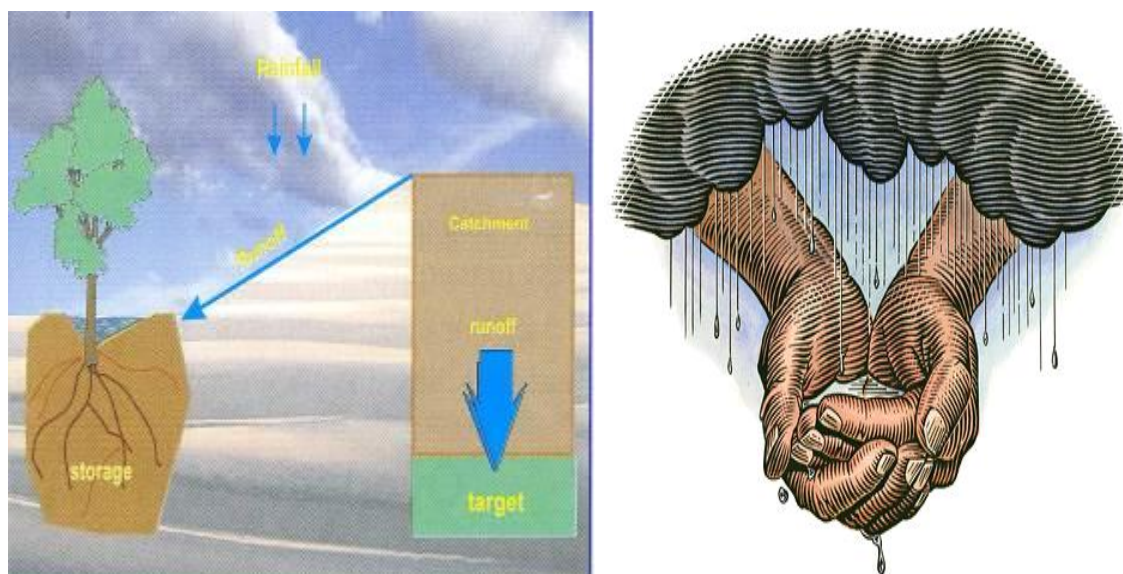
In this study will be investigated the importance of water harvesting practices for the arid cities of Turkey.

### **Materials and Methods**

Some water harvesting techniques cause soil and water erosion in dry areas. They are used successfully in the dry countries, also in south-east of Turkey. Most of the agriculture products like wheat, barley, pistachio and olive are grown using rainwater (non-irrigation), in South-east of Turkey. This region has an arid climate with total 250-450 mm rainfall in the winter season Because of that water harvesting practices are necessary for increase catchment of rainfall per unit area in this region.. These methods that can be used in these arid areas will be described.

### **Results and discussion**

In arid and semi-arid areas over accumulation or runoff of rainwater falling through inadequate storage is called water harvesting. Components of rainwater harvesting are catchment area, storage and target area (Fig. 1 a, b).



(a) (b)  
Fig.1. Water Harvesting Components (Oweis, 2001)

### Contour Tillage Water Harvesting

Water harvesting techniques are based along contours including: contour plugging; contour ridges; stone lines; grass strips and terraces (Fig. 2 a, b). Ideally, any plugging on a slope should be carried out along the contours rather than up and down as this reduces run off and soil erosion and increases moisture retention. Contour ridges are one of the most important techniques for supporting the regeneration and new plantations of forages, grasses and hardy trees on gentle to steep slopes in the steppe (Rocheleau, 1988).



(a) (b)

Fig.2 (a,b) Water Harvesting Contour Tillage

### Negarim Technique

Small runoff basins consist of small diamond shaped structures surrounded by low earth bunds. They are directional to have the maximum land slope parallel to the long diagonal of the diamond. Runoff flows to the lowest corner, where the plants is placed (Fig. 3 a, b).



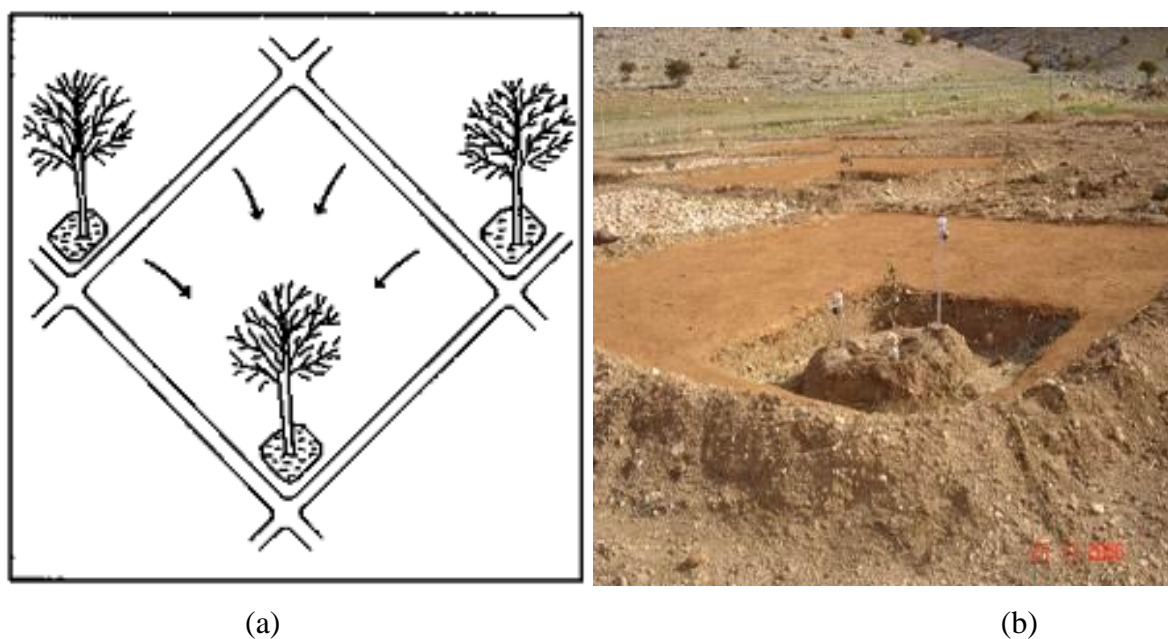


Fig. 3 (a,b). Water Harvesting Negarim Micro-catchment Technique

### Semi-circular and Trapezoidal Bunds

Semi-circular bunds are usually shape of a semi-circle, a crescent or a trapezoid facing directly upslope. They are created at a spacing that allows sufficient catchment to provide the required runoff water, which accumulates in front of the bunds, where plants are grown. Runoff is stopped and stored here in the plant root zone. These bunds are used mainly for the rehabilitation of rangeland or fodder production (Fig. 4 a, b). They provide soil and water erosion control.

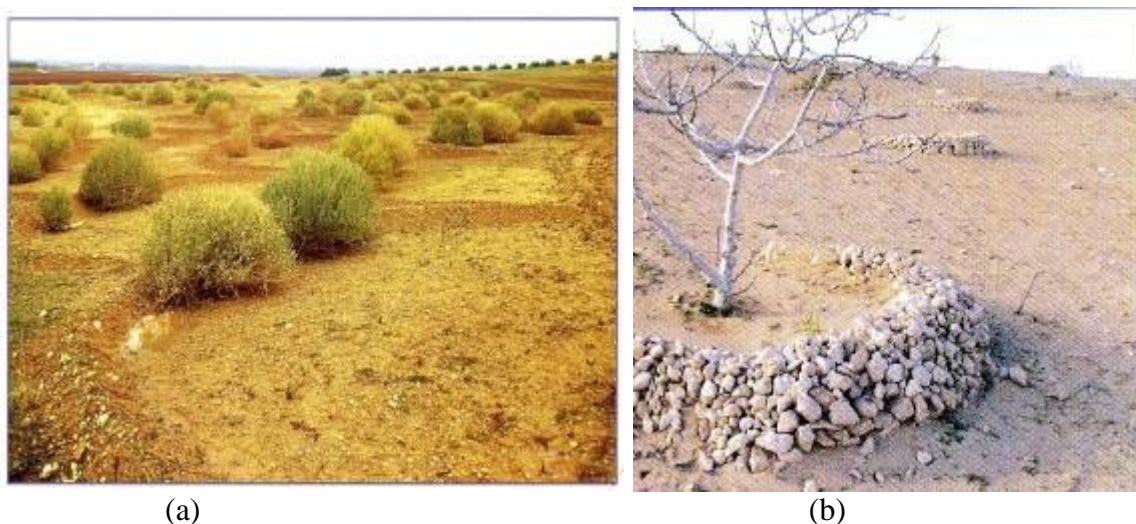


Fig. 4 (a, b). Water Harvesting Technique for Erosion Control

### Contour - Bench Terraces

Water and soil conservation and water harvesting techniques to combine the very steep are built on slopes. Agricultural terraces slow down the flow of water and to control erosion are constructed to be straight and stone walls supported. Mostly they are plants used to form of trees and shrubs (Fig. 5). The historic contour-bench terraces supporting coffee and gat trees in the mountains of Yemen (Oweis 1994 & 2001).

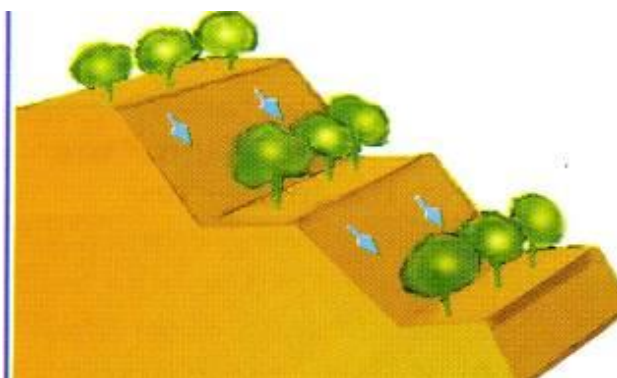


Fig. 5. Contour- bench Terrace for Conserving Erosion

### **Wadi-bed Cultivation**

Stonewalls, if properly constructed across the wadi bed, can help to store and distribute runoff water evenly and to build up soil behind them (Fig. 6). Low-pitched valley floors sediment, valley base precipitates and around good agricultural fields arise (Oweis 1994 & 2001).



Fig. 6. Wadi-bed Cultivation Water Harvesting System for Erosion Control

### **Water Harvesting Paraffin Application**

This application generally used to increase of runoff efficiency to collect rainwater in dry areas. At the same time this application provides to soil and water erosion control in sloping lands (Fig. 7).



Fig. 7. Paraffin Application for Collecting Rain Water

### **Negarim Micro- catchment Straw Mulch Application**

Water harvesting techniques should be followed by some some applications. Plastic, stone, gravel and straw mulching are a few of them. These water harvesting mulching applications collect rain water, as well as conserve soil sediment loss (Fig. 8). This is the best erosion control known for micro-catchment surface covered with plastic sheet (Fig. 9) (Kuzucu 2013).



Fig. 8. Straw Mulch Application for Rainwater Harvesting and Erosion Control



Fig. 9. Plastic Mulch Application to Collect Rainwater and Erosion Control

### **Conclusion**

In semi-arid areas precipitation amount is low and most of the harvested rainwater that gathers at the surface is lost due to evaporation. One of the most important problems is erosion in slopes and arid areas. Water harvesting practices are very important in these areas. Water harvesting is the most important goal of the agricultural production in a sustainable and environmentally friendly water supply system to reveal. Water harvesting, soil erosion control, as well as in rural and arid areas provide enough water for drinking and agricultural production. Therefore, quantifying agricultural irrigation water demand in the agricultural region, are of importance to help improve the water towards sustainable use. Water

harvesting provides the best way to take advantage of rainwater for agricultural activities.

### **References**

- Kuzucu, M. 2013. Effects of Micro-Catchment Water Harvesting Technique on young Pistachio Trees Growth, Soil and Water Conservation in Semi- arid Areas. Unpublished PhD Thesis. Çukurova University Department of Soil Science and Plant Nutrition.
- Mishra, A., Ghosh, S., Mohanty, R.K., Brahamand, P.S. (2013). Performance Evaluation of a Rehabilitated Minor Irrigation Project and Augmentation of Its Water Resources Through Secondary Storage Reservoir. *Agricultural Water Management*, Vol. 128, pp. 32-42. <http://dxdoi.org/10.1016/j.agwat.2013.06.006>
- Oweis, T., Taimah, A. 1994. International Center for Agricultural Research in the Areas (ICARDA), Aleppo, Syria. Overall Evaluation of on-Farm Water Harvesting Systems in the Arid Regions. International Conference on Land and Water Resources Management in the Mediterranean Region, Valenzano, Bari, Italy 4-8 September.
- Oweis, T., Prinz, D., Hachuma., 2001. Water Harvesting Indigenous Knowledge for the Future of the Drier Environments. ICARDA.
- FAO 1991. Water Harvesting. AGL/MISC/17/91, 133 p. ROME.
- Parthasarathy, R, 2000. Participatory Irrigation Management Programme: Institutional and Financial Issues. *Economic and Political Weekly (August-September)*, pp. 3147-3154.
- Rocheleau, D., Weber, F., Field-Juma, A. 1988. Water Harvesting For Afforestation In Dry Areas. *Agroforestry in Dryland Africa*. International Council for Research in Agroforestry, Nairobi .
- Shen, Y., Li, S., Chen, Y., Qi, Y., Zhang, S. 2013. Estimation of regional Irrigation Water Requirement and Water Supply Risk in the Arid Region of Northwestern China 1989-2010. *Agricultural Water Management*, Vol. 128, pp. 55-64. [http://www.gardenorganic.org.uk/international\\_programme/index.php](http://www.gardenorganic.org.uk/international_programme/index.php) 18.02.2016.

## **5. ANIMAL HUSBANDRY**

## ECONOMIC ANALYSIS OF THE IMPACT OF FEEDING FACTORS IN MILK PRODUCED FROM HOLSTEIN DAIRY COWS IN KOSOVO

Fatos KRASNIQI<sup>1,2</sup>, Muhamet KAMBERI<sup>2\*</sup>, Enkelejda EMIRI-SALLAKU<sup>1</sup>, Ragip KASTRATI<sup>2</sup>, Myqerem TAJAJ<sup>1</sup>

<sup>1</sup>Agricultural University of Tirana, Tirana, Albania

<sup>2</sup>University of Prishtina, Faculty of Agriculture and Veterinary, 10000 Prishtina, Republic of Kosovo

\*Corresponding author: muhamet.kamberi@uni-pr.edu

### Abstract

With the aim to evaluate economic impact of feeding factors in milk production, one year study was done (January – December 2015) involving 12 Holstein dairy farms (284 cows) in Kosovo. During the study period the structure of the diet and the amount of feed and the amount of milk produced were measured monthly based. The cost of in-farm produced feed, or the prices of purchased feed and the price of milk were used to do the calculations. Results showed that 74% of the feed is produced in the farm and includes roughages while all concentrates (either ingredients or mixtures) are purchased. Economic analysis showed that prices of feed produced within a farm were lower (30 €/ton for silages and 30 €/ton for hay) compared with feeds bought from local markets (80€/ton for hay and 280€/ton for concentrate mixture). Average cost of the ration was 2.33 €/cow/day, while average milk income was only 4.9 €/d. Total average sold milk price with all subsidies given by the state was 0.34 €/kg. Average production cost for milk was 0.29 €/kg with net profit of 0.05 €/kg of milk. Individual feed groups contributed as follows: silages with 0.04 €/kg, dry roughages with 0.02 €/kg, and concentrates with 0.10 €/kg, while all other factors make 0.13 €/kg of milk price. About 62.5 % of milk produced within these farms was categorized in Extra Class, farmers were additionally rewarded by the state with 0.06 €/kg. The main finding of this study is that feed makes the largest expense in all analysed farms and in average makes 55% of the milk production cost or 68% of all farm costs.

**Key words:** *milk cost, feed cost, farm income.*

### Introduction

Dairy sector in Kosovo is an important sector of sustainable development of the country economy. However, it is still faced with many difficulties, where small farm size (as a consequence of last War) and loss of cattle is of important contributors (Nushi and Selimi, 2009). As estimated by MAFRD (2015a) average farm size is between 1-5 heads, representing 94.2% of all farms. Dairy cows make 55.6% of the cattle population, and though only 5.8% of the farms bred more than five cows, they are main milk suppliers for processing industry (Zeqiri et al., 2015). With existing numbers, locally produced milk covers about 84% of domestic consumption (MAFRD, 2015a). According to Belegu et al., 2010, sustainable development of dairy sector requires not only increased number of animals per farm, but also increase of their economic efficiency. Although cow milk makes 97.8% of all milk produced, with low yields ranging from 2000–5000 kg/cow/lactation (MAFRD, 2015a) which is too far from genetic potential. As reported by Bytyqi et al., (2014), average income from milk is 144.78 €/cow/month. Same authors reported that income over feed cost is 78.04

€/month since average feed costs is 66.74 €/month. After inclusion of all other expenses, net income falls to 67.44 €/month per cow.

Holstein dairy cows which are known for their high production potential are the most present type in Kosovo. However they are still not being exploited at desired extent, since many factors of influence in their performance are not duly respected.

The objective of this paper was to evaluate the economic importance of feeding factors in farm incomes, especially related to milk production.

### **Material and methods**

Economic impact of feeding factors in milk production was measured through one year study (January – December 2015). The study was done in two regions of Kosovo and included 12 Holstein dairy farms breeding 284 cows in total. More than 10 milking cows per farm and contractual agreements with the milk collection centres were the criteria for including of farms in this study. Each month of the study period the structure of the diet, the amount of feed used and the amount of milk produced were measured. All costs and incomes were also recorded during entire study period. The cost of all feeds either produced in the farm or prices of feed ingredients purchased and the price of milk paid were used to do the calculations.

The structure of the ration was estimated by measurement of all ration ingredients used. Production feed parameters were estimated based on energy and protein content of feeds and the amount of these nutrients supplied to animals. This is done by exact weighing of daily feed amount offered and feed rest. Milk production at farm level was measured by farmer in daily basis. The amount produced was then converted to monthly and total production per cow. A 305 day milk production was calculated by division of the amount per year by the factor 1.1967 (365/305). Average milk price paid to farmer was calculated per month. Basically the milk price was dependent on milk fat unit (as a criterion of milk collection centres) but some farmers got additional 0.04-0.06 €/per litre if milk was within standards set by Administrative Instruction nr. 04/2015 (MAFRD, 2015b). Based on the same regulation, farmers were also subsidized based on the area they have cultivated with maize and the number of dairy cows they have. Total farm income was therefore the amount of income from milk, sold calves and heifers, manure plus subsidies. This is a one year investigation and it is based on information generated from the costs farmers made to produce (declared by farmers but not always fully documented) and all forms of incomes (exactly proven by milk collection centres and the government payments). Statistical analysis of results included descriptive analysis using Analysis Tool pack MS Office Excel 2007.

### **Results and discussion**

#### **Feed production and land use**

Feed is known to be a main determinant factor of performance in livestock production and represents the main part of costs in milk production (Singh and Narang 1993). The surface of the land, available mechanisation and farmer's knowledge about fodder production generally affects overall production costs. Providing adequate feed to animals both in quantity and quality is essential to maximize production for dairy farms.

Results on the structure of land (own or rented) are presented in table 1. As shown in the table, farmers owned very small land area and therefore were forced to rent land. They pay rent for land between 200 500€/ha.

Table 1. Average area of land used for fodder production owned or rented (with rent price) by dairy farms.

N=12	Total land area ha/farm	Area owned, /ha	Area rented, ha	Rent price €/ha
$\bar{X}$	11.7	3.5	8.3	318.8
Min	6.5	2.0	4.0	200.0
Max	30.5	6.0	27.0	500.0

According to last agricultural census (KAS, 2015), Kosovo has 512,000 hectares of land considered as agricultural, of which a very large part is utilized land (413,635 ha). Most of the utilized land consists of arable land (180,381 ha) and meadows and pastures (224,411 ha) which is also a good potential for fodder production. But, still the capacity to produce sufficient and cheap (low cost) feed is limited due to varying agronomic and climatic conditions.

### The structure of the ration and feed costs

Prices of purchased feeds were variable and dependent on the production costs (table 2) the yields, prices of fertilizers, costs of machines hired for soil cultivation, prices of irrigation etc. Since there is no official market for feeds, these prices are collected based on interviews in local markets and from information given by farmers included in study. In average 74% of the feed was produced within a farm. Results show that all concentrated feeds (ingredients or compound feed) were purchased. However, some farmers grinded and mixed them to produce own compound feeds. This resulted in savings of about 30 €/ton feed. To balance fibre content of the ration, some farmers used to use wheat straw which was also purchased by all farms. In general, production of feed by farm resulted in differences from 20-60€/ton in feed prices. Of roughages, maize silage generally considered the main feed (Chase et al., 2009) in extensive dairy compounds is produced by all farms.

Table 2. The costs and the structure of feed produced or purchased

Type of feed	Production price, €/kg	Purchase price, €/kg	Difference in price €/kg	The source of feed, %	
				Produced	Purchased
Meadow hay	0.03	0.08	0.05	32	68
Alfalfa hay	0.04	0.10	0.06	86	14
Wheat straw	-	0.04	0.03	0	100
Corn Silage	0.03	0.05	0.02	100	0
Haylage	0.05	0.07	0.02	37	63
Compound feed*	0.25	0.28	0.03	0	100

\* Compound feed made in farm was produced from purchased ingredients

### Nutritional status and dry matter source

An analysis of the structure of dry matter, groups of feed in relation with milk production in two milk production scenarios is presented in table 3. It is observed that total DM intake was not changed with the increase of milk yield from to over 4500 kilograms per lactation. However more efficient use of energy and proteins is seen. Decrease in energy (8.6 to 7.8 MJ ENL/kg of milk) and protein consumption (124.7 to 119.7 g/kg of milk) is observed in farms with more than 4500 litres of milk per lactation (table 3). This finding is comparable with findings of Emiri, (1999) who also reported that protein consumption per unit of milk



produced also reflects the level of fibres and indigestible proteins in the ration. Analysis of DM, energy and protein consumption (table 3) in two milk production levels obtained in this study show that in general, consumption of these nutrients is considered to be high for both levels of milk production. The reason for this is that calculations are done on the basis of the feed given to animal without exact calculation of feed rests which may account 10-15 % (Emiri, 1999). Another interesting result is that the increase of milk yield is associated with consumption of less dry roughages and more concentrated feeds which are used to overcome nutrient deficiencies and lower availability of roughages.

Table 3. Average of DM, NEL and protein consumption for two levels of milk production obtained during the studied period\*.

Number of farms	Milk production, kg/day	Dry Matter Intake, kg/day	NEL, MJ /kg milk	Protein, g/kg milk	Silage (corn and grass) %	Dry roughages, %	Concentrated feeds, %
N=5	Milk yield, under 3500 kg/cow						
$\bar{X}$	11.4	17.47	8.6	128.7	52.3	22.4	25.3
Min	10.9	16.8	7.9	121.3	47.8	14.6	23.6
Max	12.0	18.4	9.5	135.6	59.5	28.1	28.6
N=7	Milk yield, over 4500 kg/cow						
$\bar{X}$	15.3	17.5	7.8	119.7	53.75	18.93	27.33
Min	14.6	16.6	7.5	111.0	48.27	11.37	22.37
Max	16.5	18.5	8.3	128.2	59.11	26.57	31.38

\*Duration of studied period from January to December 2015.

### Analysis of farm incomes

Economic analysis of the contribution of the ration and the feed groups in milk price is presented in table 4. Results show that an average sale price of milk was 0.34€/kg while production cost of one litre of milk was 0.29€. The main contributor of this cost is definitely feed (51.7-65% of the price). The highest portion of this cost is from concentrated feed followed by silages and dry roughages (62.5; 25 and 12.5%, respectively). Income over feed cost ranged from -0.03€/kg to + 0.04€/kg. There is established subsidy direct payment programme in Kosovo since 2014 and farmers who succeeded to reach certain milk quality standards (Extra, First and Second Class) will benefit (0.06; 0.04 and 0.02 €/kg of milk for respective quality class). In this respect, the majority (62.5%) of milk produced in farms involved in this study belonged in Extra Class, 7.69% in first and 29.8% in second class. This type of income represented very important part of the milk income and averaged 0.05 €/kg.

Table 4. Economic analysis of the effects of feed groups in milk production in dairy farms.

Number dairy farms (N=12)	Cost of the ration, €/day	Portion of the feed group, €/kg			The structure of the total milk cost, €/kg		Net income, €/kg milk	
		Silage	Dry roughages	Concentrated feeds	Feed	Other	Without subsidies	With subsidies
$\bar{X}$	2.33	0.04	0.02	0.10	0.16	0.13	0.00	0.05
Min	1.94	0.03	0.01	0.09	0.15	0.10	-0.03	0.00
Max	2.61	0.07	0.03	0.12	0.19	0.17	0.04	0.06

From the costs structure analysis which represents the average of all farms (Figure 1), it can be seen that feed took the main portion with 68% of all costs. Depreciation rate, work force, veterinary expenses and other costs make 32 % of the costs. Under other costs expenses for fuel in feeding operations and manure removal within a farm, electricity, water, cleaning and sanitizing as well as maintenance costs for mechanization were included.

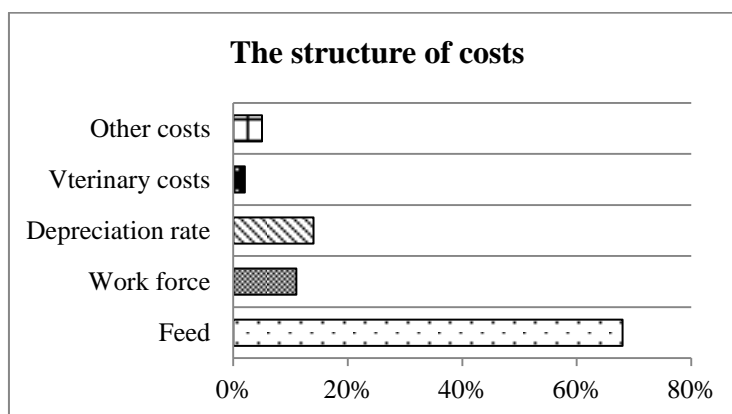


Figure 1. Average contribution of each cost group

Through figures 2, 3 and 4, an analysis of the structure of incomes is given. Analysis of the structure of production incomes (figure 2) unexpectedly show that without subsidies, milk production makes the lowest farm income (only 8%), even lower than manure. Subsidies per hectare of maize (150 €/ha), per cow (70€/head) and per level and quality of produced milk (0.05€/kg) have substantially contributed in total farm income (figure 3). With the average of 64%, subsidies are the main farm income (table 5), with some farms where subsidies are the sole income.

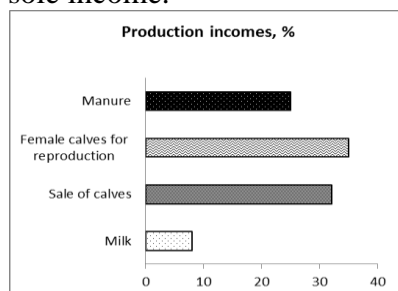


Figure 2. The structure of production farm incomes

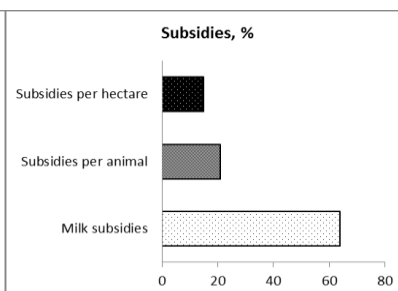


Figure 3. The structure of subsidies

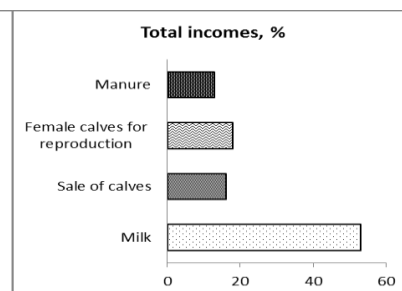


Figure 4. The structure of all incomes

Table 5. Contribution of production and subsidies in dairy farm income in € or in %

Number of dairy farms	Incomes €/year		Incomes, %	
	Production	Subsidies	Production	Subsidies
N=12				
$\bar{X}$	4876	7930	35.99	64.01
MIN	81.40	2967.24	0.77	49.31
MAX	17867.62	18837.12	50.69	99.23

However subsidies have positively affected dairy farm business enabling them to either produce feed at lower cost or purchase required amounts of concentrates. This improved

nutritional status of animals and their overall performance. Farms involved in this study bred between 11-47 dairy cows and used from 6.5-30.5 ha (table 1). This difference resulted in different management practices and effectiveness of the use of resources. The largest farm (47 cows and 30.5 ha of land) produced more in-farm feed and more milk (16.54 kg/day/cow) at lower costs of milk (0.27€/kg) as compared with smaller farms.

### **Conclusions**

Feed is the main expense in all analysed farms and in average makes 55% of the milk production cost or 68% of all farm costs. Of feed groups, concentrates contribute with 34.48% followed by silages and dry roughages with 13.79 and 6.9% respectively.

Results of present study reveal that only one third of farm incomes are generated from animal production (milk, calves and heifers) with the lowest contribution of milk. Economic analysis of this study show that subsidies are main form of income and only 42% of farms managed to have profitable business without them. This profit ranged from 0.01 to 0.04 €/kg of milk. The other 58% of farms were either at subsistent state (no profit- no losses) or the cost of milk produced was higher than sale price for 0.03€, which would generate losses and endanger the sustainability of farm business.

After several farm visits during entire investigation we found that feeding and other management practices are not in full accordance with requirements of animals so the low milk yield and overall cow performance is a logical consequence. Though the amount of subsidies given is considered low by farmers it is more or less comparable with the region, but we think that this is not the best form to overcome low performance and bad farming practices for a longer period.

The only sustainable tool to ensure competitiveness of milk production of Kosovo dairy farmers is to put more efforts and knowledge in order to more efficiently utilise the genetic potential of the animal.

### **References**

- Bytyqi H., Thaqi M., Hoxha F., Misini A., Haxhija B., Cabrera, V, (2014): Economic Assessment of Dairy Farm Production in Kosovo. The 11th European IFSA Symposium, 1-4 April 2014 in Berlin, Germany.
- Chase L.E., R.J. Higgs and M.E. Van Amburgh. 2009. Feeding lower crude protein rations to dairy cows – opportunities and challenges. Proc. Cornell. Nutr. Conf., Syracuse, NY. Pp:235-239.
- Emiri. E, 1999. Evaluation of physiological effect of feeding in milk production and reproduction in black Holstein dairy cows (in Albanian). PhD thesis. Agricultural University of Tirana, Republic of Albania.
- Kosovo Agency of Statistics (KAS), 2015. Agriculture Census in The Republic Of Kosovo 2014 (Final Results). <http://ask.rks-gov.net>.
- MAFRD. 2015a. Analysis of dairy market (in Albanian). Department of economic analysis and agricultural statistics. Ministry of Agriculture Forestry and Rural Development, Kosovo.
- MAFRD. 2015b. Administrative Instruction Nr. 04/2015 for direct payments in Agriculture. Ministry of Agriculture Forestry and Rural Development, Kosovo.
- Majlinda Belegu, Enkelejda Sallaku, Parashqevi Rrapo, Silvana Mustafaj, 2010. The use of mathematical-economic modelling analysis of indicators by factors that influence productive and food in bovine milk farms. Journal of Institute Alb-Shkenca. ISSN 2073 [www.alb-shkenca.org](http://www.alb-shkenca.org)

- Medin Zeqiri, Hysen Bytyqi , Drini Imami , Ylli Biçoku, 2015. Dairy Farmers Awareness about Food Standards - the Case of Kosovo. Agricultural University of Tirana. Albanian J. Agric. Sci.;14 (2):93-101.
- Nushi M., Selimi F, (2009): An assessment of the Competitiveness of the Dairy Food Chain in Kosovo. AgriPolicy Enlargement Network for Agripolicy Analysis. 2009: 4-21.
- Singh B., Narang, M. P. 1993. Indigestible cell wall fractions in relation to lignin content of various forages. Indian J. Anim. Sci., 63 (2): 196-200.

## EFFECTS OF THE INCORPORATION OF BARLEY BREWERS AND LOCAL DEHYDRATED ORANGE PULP INTO THE RATION ON THE GROWTH OF BROILER CHICKENS (ALGERIA)

Rafik ARBOUCHE<sup>1\*</sup>, Yasmine ARBOUCHE<sup>2</sup>, Achour MENNANI<sup>2</sup>

<sup>1</sup>Department of Agronomy, University of Ghardaia, Algeria

<sup>2</sup>Department of Agronomy, University of Setif, Algeria

\*Corresponding author : rafik\_arbouche@yahoo.fr

### Abstract

The rations of monogastrics, especially poultry, are mainly made up of soybean meal and maize, raw materials totally imported by Algeria. Their substitution by local raw materials or their co-products would be able to reduce the cost of production of animal products.

It is within this framework that this study proposes to determine the effects of the incorporation of dehydrated citrus pulps at a fixed rate (5%) and dehydrated local barley grains partially substituting for corn, in the diet on the performance of growth of broiler chickens. A total of 200 one day old F15 broiler chickens was randomly divided into 4 equal groups according to the substitution rate of maize with brewers' grains (0%, 20%, 25% and 30%) for 48 days. No mortality was observed in any groups. The weight to 10 days were significantly greater for lots 20%(+19%) and 30% (+11%), while for the weight to 20 days, only the lot 20% has a weight significantly greater with 578g. In the growth phase, the weight of the control and the 30% batch are similar. In the finishing phase, the control batches, 25 and 30% have similar weights (2600g). The Consumption Index and intake quantities change proportionally to substitution rates, while costs are inversely proportional. The prices of the kilograms of live weight and eviscerated carcass of lots 20 and 25% are promising with less than 8 and 12 DZA respectively. The incorporation of 5% citrus pulp and 30% dehydrated barley grains, in substitution for maize, alters consumption and intake rates but produces significant economic results for their uses in chicken dietary formulas.

**Keywords:** *Weight growth, Brewery drecches, consumption index, Corn, Citrus pulp.*

### Introduction

The rations of the monogastrics, particularly those of the poultry, are mainly composed of cakes of soya and maize, raw materials totally imported by Algeria. Their substitution by local raw materials or their co-products would be able to reduce the cost of livestock production (Arbouche, 2012; Boudouma and Berchiche, 2010). The use of co-products from the processing of citrus and brewery based on local barley varieties in the dietary formulas of broiler chicken will have the advantage of reducing corn imports and upgrading local products.

In Algeria, the raw materials that can be used in brewing are barley from local varieties (*Tichedrett* and *Saida*) whose average chemical composition is different from that of their European counterparts (Arbouche et al., 2008; Arbouche, 2012) And co-products of citrus processing whose cultural aspects do not involve any source of pesticides or phytosanitary products.

The introduction of the latter into the poultry feed has been the subject of several studies which demonstrate a restriction of its incorporation (5%) for broiler chickens (Arbouche

2015 ; Lanza 1982 ; Oluremi et al., 2007 ; ElBoushy et al., 2000). This rate of incorporation is capable of lowering the cost price of the kilogram of food produced, since maize is imported almost entirely. The combination of these two by-products could have an associative effect in the improvement of the weight productivity of broiler chickens. The aim of our study is to determine the optimal incorporation rate of barley brewers into broiler feed with a constant rate (5%) of barley brewers.

## Materials and methods

### Animals, diets and experimental protocol

Our experimentation took place at the level of the cooperative poultry of the wilaya of EL TARF in Algeria, during the months of March and April 2014. This period was characterized by an average temperature of 18 ° C and an average humidity level of 82%. Two hundred one-day chicks; Of Hubbard F15 strain, weighing on average 40 ± 2.8 g, were divided into four homogeneous parquet floors with a surface area of 5 m<sup>2</sup> each and consisting of 50 subjects in a closed building with static ventilation. The litter consisted of sawdust. The barley brewer's brewery came from the beer-making unit in the wilaya of Annaba and the citrus pulp from the juice and canning unit of SIJICO (*Ramdane Djamel* wilaya of *SKIKDA*). The drying was carried out by exposure to the open air and the sun in order to avoid the disadvantages reported by Fritzch and Abadjieff (1977). The chemical composition of brewery grains and citrus pulp was determined by the AOAC method (1990) with a repeatability of 3 (Table 1 and 2).

**Table 1.** Chemical composition of dehydrated

	citrus pulps	barley brewers'
Organic Materials (% of DM)	96,5	96,1
Total Nitrogen Content (% of DM)	9,1	24,1
Crude Fiber (% of DM)	12,5	15,3
Fat (% of DM)	2,1	6,7
Mineral Materials (% of DM)	3,5	3,9
Non-Nitrogenous Extract (% of DM)	72,8	50
Gross energy (kcal/kg of DM)	4064	4500
Metabolizable Energy (kcal/kg of DM) #	3644	3612
Lysine (g/100g of food)	3,6	3,2
Methionine (g/100g of food)	1,2	1,5
Cystine (g/100g of food)	1,1	1,7

DM : Dry mater, # Metabolizable energy: Estimated using the formula of Carpenter and Clegg (1956) with ME (kcal/kg of DM) = 35,3 x RP (%) + 79,5 x EE (%) + 40,6 x NFE (%) + 199 (ME : Metabolizable energy, RP : Raw proteins, EE : Ether extract, NFE : Nitrogen Free Extract)

**Table 3:** (1 to 20 days), growth (21 to 33 days) and finishing (34 to 48 days) distributed to chickens according to the rate of substitution of maize by Brewers' grains and by fixed-rate dehydrated oranges (5%)

Type of food	Substitution %	Start-up				Growth				Finish			
		0	20	25	30	0	20	25	30	0	20	25	30
<b>Ingredients</b>													
Corn	61	45,75	42,70	39,65	64	48	44,8	41,6	70	52,5	49	45,5	
Orange Pulps	0	3,05	3,05	3,05	0	3,2	3,2	3,2	0	3,5	3,5	3,5	
Barley brewers	0	12,2	15,25	18,3	0	12,8	16	19,2	0	14	17,5	21	
Soybean meal	30	30	30	30	27	27	27	27	21	21	21	21	
Issue of milling	6	6	6	6	6	6	6	6	6	6	6	6	
Phosphorus bi	1,2	1,2	1,2	1,2	1,2	1,5	1,5	1,5	1,2	1,2	1,2	1,2	

calcium												
VMS	1,5	1,5	1,5	1,5	1	1	1	1	1	1	1	1
Lysine	0,15	0,15	0,15	0,15	0,5	0,5	0,5	0,5	0,5	0,5	0,5	0,5
D L Methionine	0,15	0,15	0,15	0,15	0,3	0,3	0,3	0,3	0,3	0,3	0,3	0,3
<b>Nutrient Content</b>												
Metabolizable energy (Kcal/Kg)	3095	2983	2957	2931	3095	2978	2951	2924	3097	2969	2939	2910
Crude protein (%)	21	23	24	24	20	22	22	23	21	20	21	21
Fat (%)	3	4	4	4	4	4	4	4	4	4	4	4
Mineral matter(%)	3	4	4	4	3	4	4	4	3	3	3	4
Crude fiber (%)	4	6	7	7	4	6	7	7	4	6	7	7
Lysine (%)	0,6	0,6	0,6	0,6	0,6	0,6	0,6	0,6	0,6	0,6	0,6	0,6
Methionine (%)	0,2	0,2	0,2	0,2	0,2	0,2	0,2	0,2	0,2	0,2	0,2	0,2

VMS ( Mineral-Vitamin Supplement ), which the composition is: Calcium : 16.8%, Magnesium : 0.1%, Sodium : 12.8%, Chlore : 20.5%, Vitamine A : 750 000 UI, Vitamine D3 :160 000 UI, Vitamine E : 1280mg/kg, B1 :100mg/Kg, B2 :300mg/Kg, Pantothenate de calcium : 570mg/Kg, Niacine : 1750mg/Kg, B6 :99mg/Kg, K3 :190mg/Kg, Acide folique : 35mg/Kg, Biotine : 1mg/Kg, Chlorure de choline : 25000mg/Kg, Carbonte de fer : 2500mg/Kg, Cuivre (sulfate):970mg/Kg, Zinc (sulfate) : 6080mg/Kg, Manganese (oxyde) : 7500mg/Kg, Iode (iodate):120mg/Kg, Selenium (selenite): 25mg/Kg, And other additives ; DL-methionine :180g/kg, Antioxydant, Acide citrique, Acide orthophosphorique.

The analyzes included organic matter, total nitrogenous matter, crude fiber, fat and mineral matter. The crude energy was determined by adiabatic calorimetry. Four iso-energetic rations were designed, containing 0% (control food), 20, 25, and 30% brewery dairy and 5% dried citrus pulp in substitution for maize during the various stages of rearing (Table 3).

During the first ten days, continuous lighting was maintained in the chicken coop and then reduced to 18 hours of daytime for 6 pm nocturnal. A temperature between 36 and 38 ° C was maintained during the first ten days thanks to gas brooders. Water and food were distributed ad libitum. Chickens were vaccinated against Newcastle disease and infectious bronchitis on the fifth and twenty-fourth day of rearing and against Gumboro disease at 123 and 128 days of age; An anticoccidial was administered by buccal voice at 15 and 28 days for 3 consecutive days.

The animals were individually weighed at 10 and 20 days of age during the start-up phase, at 33 days and at 48 days of age during the finishing phase. During the entire breeding phase, the food was distributed at will and the refusal weighed daily. The mortality rate was collected daily on the whole experiment.

#### Statistical analysis

The descriptive statistics and the variance analysis of the univariate general linear model were carried out with the SPSS software (version 18, 2008) for the analysis of the live weight (LW), the daily weight gain (ADG), the Food intake and consumption index (CI). The general linear model was used to test the effects of factors on variables, the post hoc test by applying the SNK test (Student-Newman-Keules) and Duncan, to estimate the significance or homogeneity between the different sub Sets (comparison test between averages). The differences were considered significant with a risk of error of 5%.

## Results and discussion

Over the whole of the experimental period, the mortality rate remained zero whatever the diet considered. 10-day weights are significantly higher for lots 20 and 30%, while for 20-day weights, only the 20% lot dominates with a weight of 578.2 g (Table 4). In the growth phase, the weight of the control and the 30% batch are similar. In the finishing phase, the batches, control, 25 and 30% have identical weights.

The average daily gains (ADG) are in the start-up phase, identical for the batches, control, 20 and 30% from 0 to 10 days, whereas for the period from 11 to 20 days, the control batches, 20 and 25% are similar. During the entire start-up phase, the ADG<sub>1-20d</sub> is more expressive for the batch 20% (26.9 g), identical for batches 25 and 30% while remaining below the ADG of the control batch. The ADG of the growth phase remains similar for the control batches, 25 and 30%, the 20% batch being the least expressive. For the finishing phase, the ADG of lots 25 and 30% are similar and more important. During the entire breeding period, the ADG<sub>1-48d</sub> is similar for the control, 25 and 30% (53.5g on average).

**Table 4:** Evolution of weight growth during the start-up, growth and finishing phases in broiler chickens as a function of the percentage of substitution of maize by brewed grains

	% of substitution				ESM	P
	0	20	25	30		
<b>Start-up phase</b>						
Initial Weight (g)	40	40	40	40		
Weight to 10d (g)	144 <sup>a</sup>	172 <sup>b</sup>	113,6 <sup>c</sup>	160 <sup>b</sup>	1,254	0,01
ADG <sub>1-10</sub> (g/d/subject)	14,5 <sup>a</sup>	13,3 <sup>b</sup>	11,4 <sup>c</sup>	13,0 <sup>b</sup>	1,841	0,02
Weight to 20d (g)	550 <sup>a</sup>	578 <sup>b</sup>	509 <sup>c</sup>	524 <sup>d</sup>	1,156	0,001
ADG <sub>11-20</sub> (g/d/subject)	40,6 <sup>a</sup>	40,5 <sup>a</sup>	39,6 <sup>a</sup>	45,4 <sup>b</sup>	1,689	0,001
ADG <sub>1-20</sub> (g/d/subject)	51,0 <sup>a</sup>	53,8 <sup>b</sup>	46,9 <sup>c</sup>	48,4 <sup>c</sup>	2,015	0,001
<b>Growth phase</b>						
Weight to 33 d (g)	1478 <sup>a</sup>	1400 <sup>b</sup>	1440 <sup>c</sup>	1460 <sup>a</sup>	1,965	0,03
ADG <sub>21-33</sub> (g/d/subject)	71,4 <sup>a</sup>	63,2 <sup>b</sup>	71,6 <sup>a</sup>	72,1 <sup>a</sup>	0,894	0,01
<b>Finishing phase</b>						
Weight to 48d (g)	2600 <sup>a</sup>	2450 <sup>b</sup>	2609 <sup>a</sup>	2619 <sup>a</sup>	0,789	0,02
ADG <sub>34-48</sub> (g/d/subject)	80,2 <sup>a</sup>	75,0 <sup>c</sup>	83,5 <sup>b</sup>	82,7 <sup>b</sup>	0,587	0,01
ADG <sub>1-48</sub> (g/d/subject)	53,3 <sup>a</sup>	50,2 <sup>b</sup>	53,5 <sup>a</sup>	53,7 <sup>a</sup>	0,872	0,001

ADG: Average Daily Gain (The indices indicate the period in days on which this parameter was calculated). The presence of different letters on the same row and column indicates a significant difference between diets and strains [P <0.05].

During all periods of breeding, ingested and indices of consumption are significantly different between the batches (Table 5). Live weights and weights of eviscerated carcasses are similar for the control batches, 20 and 30% with an average of 2800 and 2000 g respectively (Table 6). The by-products have significantly different weights between batches.



**Table 5:** Evolution of food intake and consumption index during start-up (1 to 20 days), growth (21 to 33 days) and finishing (34 to 48 days) as a function of the percentage substitution of maize by brewers' grains.

	% of substitution				ESM	P
	0	20	25	30		
<i>Food insecurity (g)</i>						
To 1 to 10 days	162 <sup>a</sup>	167 <sup>b</sup>	156 <sup>c</sup>	161 <sup>a</sup>	5,43	0,01
To 11 to 20 days	766 <sup>a</sup>	797 <sup>b</sup>	780 <sup>c</sup>	788 <sup>d</sup>	1,87	0,02
To 21 to 33 days	1850 <sup>a</sup>	1899 <sup>b</sup>	2038 <sup>c</sup>	2510 <sup>d</sup>	3,85	0,01
To 34 to 48 days	3497 <sup>b</sup>	3943 <sup>c</sup>	3967 <sup>c</sup>	4916 <sup>a</sup>	2,51	
<b>To 1 to 48 days</b>	6275 <sup>a</sup>	6806 <sup>b</sup>	6941 <sup>b</sup>	8375 <sup>c</sup>	4,48	0,02
<i>Consumption Index (g/g)</i>						
To 1 to 10 days	1,12 <sup>a</sup>	0,96 <sup>b</sup>	1,37 <sup>c</sup>	0,94 <sup>b</sup>	0,08	0,01
To 11 to 20 days	1,39 <sup>a</sup>	1,38 <sup>a</sup>	1,53 <sup>b</sup>	1,50 <sup>b</sup>	1,63	0,001
To 21 to 33 days	1,25 <sup>a</sup>	1,35 <sup>b</sup>	1,41 <sup>c</sup>	1,72 <sup>d</sup>	0,85	0,001
To 34 to 48 days	1,34 <sup>a</sup>	1,60 <sup>b</sup>	1,52 <sup>c</sup>	1,88 <sup>d</sup>	1,46	
<b>To 1 to 48 days</b>	2,41 <sup>a</sup>	2,77 <sup>b</sup>	2,66 <sup>c</sup>	3,19 <sup>d</sup>	1,59	0,001

The results are expressed as a function of mean  $\pm$  standard error to mean (SEM). The presence of different letters on the same row and column indicates a significant difference between diets and strains [P < 0.05].

**Table 6:** Evolution of liveweight, weight of carcasses and by-products of slaughter of broiler chicken according to the percentage of substitution of the maize by the dregs of brewery.

	% of substitution				ESM	P
	0	20	25	30		
Live weight (g)	2793 <sup>a</sup>	2815 <sup>b</sup>	2729 <sup>c</sup>	2813 <sup>b</sup>	2,95	0,02
Eviscerated carcass (g)	1993 <sup>b</sup>	2024 <sup>a</sup>	1997 <sup>b</sup>	2019 <sup>a</sup>	2,41	0,01
Paws (g)	105 <sup>a</sup>	106 <sup>a</sup>	99 <sup>b</sup>	109 <sup>c</sup>	4,93	0,02
Heads (g)	70 <sup>a</sup>	81 <sup>b</sup>	67 <sup>c</sup>	72 <sup>a</sup>	0,97	0,01
Feathers (g)	112 <sup>a</sup>	99 <sup>b</sup>	78 <sup>c</sup>	92 <sup>ab</sup>	0,67	0,01
Liver (g)	65 <sup>a</sup>	46 <sup>b</sup>	41 <sup>c</sup>	47 <sup>ab</sup>	0,18	0,001
Gizzard (g)	64 <sup>a</sup>	64 <sup>a</sup>	59 <sup>b</sup>	62 <sup>ab</sup>	0,75	0,001

*The presence of different letters on the same row and column indicates a significant difference between diets and strains [P < 0.05].*

Interestingly, the fixed incorporation of citrus pulps (5%) and brewery grains as a partial replacement of maize induced a delay in weight growth in the broiler chicken only in the 10% lot between 0 and 10 days, whereas Arbouche et al. (2014) reported a marked decrease in starting weights on the same strain for substitution rates of 30 and 40%. At 20 days, the 20% lot is the most expressive (578.2 g / d / subject) compared to the control batch, the same finding was made by Arbouche et al. (2014) for identical substitution and on the same strain. In the growth phase, the control lot and the 30% lot have similar weights (1468 gen mean) whereas Arbouche et al. (2014), Metayer et al. (2009), Branckaert (1967) and Branckaert and Vallerand (1970). Different weights. For the finishing phase, the control batches, 25% and 30% have significantly different weights, while Morrison (1956), Borgioli (1962), Simmons (1965) and Ademosson (1973) find different weights.

For consumption indices and intake quantities, they increase in proportion to the substitution rate, contrary to Metayer et al (2009), who note a decrease in these parameters from a substitution rate of 5%. Skiba et al (2009) note a degradation of the chicken consumption index for an incorporation rate of 15% of grains and 20% for Bouvarel et al (2009). The weights of the eviscerated carcasses are similar for all lots with an average weight of 2010 g.

In conclusion, the incorporation of 5% citrus pulps and 30% dehydrated barley grains, in substitution for corn, gives good results in food formulas for broiler chicken.

### References

- Ademosson AA 1973 Evaluation of brewer's dried grains in diets of growing chickens. *British Poultry Science* 14, 463-468
- Aoac 1990 Official Method of Analysis, 15<sup>th</sup> edition, Association of Analytical Chemists, Inc., Arlington, Virginia, USA. 1230 p
- Arbouche F 2012 Tables de composition et de valeur nutritive des matières premières produites en Algérie pour l'alimentation des ruminants « Tables of composition and nutritive value of raw materials produced in Algeria for the feeding of ruminants ». Editeurs Institut National Recherche Agronomique Alger, Algérie.
- Arbouche H S, Arbouche Y, Arbouche R et Arbouche F 2008 Valeur nutritive de quelques variétés d'orge algériennes pour l'alimentation des ruminants « Nutritional value of some Algerian barley varieties for feeding ruminants ». *Revue Institut National Recherche Agronomique Algérie*, 22 : pp 67-72.  
[http://www.semencespaysannes.org/bdf/docs/orge\\_et\\_alimentation\\_animale.pdf](http://www.semencespaysannes.org/bdf/docs/orge_et_alimentation_animale.pdf)
- Arbouche Y, Arbouche H S, Arbouche F, Arbouche R et Mennani A 2014: Effets de l'incorporation de drèches d'orges locaux dans la ration sur la croissance de poulets de chair (Algérie) « Effects of the incorporation of local barley grains into the ration on the growth of broiler chickens (Algeria) ». *Livestock Research for Rural Development. Volume 26, Article #190*. Retrieved November 26, 2016, from <http://www.lrrd.org/lrrd26/10/arbo26190.html>
- Arbouche Y 2015 Utilisation des sous-produits de la transformation des agrumes et des brasseries dans l'alimentation des animaux domestiques : cas du poulet de chair « Use of by-products in the processing of citrus fruit and breweries in domestic animal feed: case of broiler chicken ». Thèse de « Doctorat es Sciences en Agronomie Université d'EL TARGUJAT Algérie.
- Boudouma D et Berchiche M 2010 Performances du poulet de chair recevant des régimes alimentaires à base de son de blé dur « Performance of broilers receiving diets based on durum wheat bran ». Journée d'étude sur le bon usage des sons cubés. ITMA – Sétif-30 mai.
- Bouvarel I, Chagneau A M, Lescoat P, Lessire M, Vilariño M, Crepon K, Etave G, Margeryal C et Juin H 2009 Utilisation de nouvelles matières premières en alimentation Séquentielle « Use of new raw materials in sequential feeding ». Huitièmes Journées de la Recherche Avicole, St Malo, 25 et 26 mars pp 439-443
- Borgioli E 1962 Alimentacion del Ganado « Livestock Feeding » Ediciones Gea Barcelona.
- Branckaert R 1967 Utilisation des drèches de brasserie desséchées dans l'alimentation du poulet de chair en régions tropicales « Use of dried breweries in the feeding of broiler chickens in tropical regions ». *Revue Elevage Médecine vétérinaire Pays tropicaux*. 20, pp 595-600. [http://remvt.cirad.fr/cd/EMVT67\\_4.PDF](http://remvt.cirad.fr/cd/EMVT67_4.PDF)
- Branckaert R et Vallerand F 1970 Utilisation des drèches de brasserie desséchées dans l'alimentation animale en régions équatoriales et tropicales. II. La poule pondeuse « Use of dried breweries in animal feed in equatorial and tropical regions. II. The laying hen ». *Revue Elevage Médecine vétérinaire Pays tropicaux*. 23 (2) pp 249-255. [http://remvt.cirad.fr/cd/EMVT70\\_2.PDF](http://remvt.cirad.fr/cd/EMVT70_2.PDF)
- Fritzch W and Abadjieff W 1967 .Mykologische untersuchungen an malzkeim proben « Mycological tests on malt germ samples ». *Archiv.Tierernlihr.*, 17, pp 463-474.

- Lanza A (1982). Dried citrus pulp in animal feeding. *Nutrition abstracts and reviews* 9 (56), pp 189-197.
- Metayer J P, Gäuzere J M, Gady C, Skiba F et Vilariño M 2009 Valeur nutritionnelle d'une drêche de blé chez le coq et le poulet et effet du niveau d'incorporation et de l'ajout d'un complexe multi-enzymatique sur les performances de croissance des poulets standards « The nutritional value of a wheat brewers in rooster and chicken and the effect of the level of incorporation and the addition of a multi-enzyme complex on the growth performance of standard chickens ». *Huitièmes Journées de la Recherche Avicole, St- Malo, 25 et 26 mars, pp 167-171*
- Morrison F B 1956 Compendio de alimentacion del Ganado « Compendium of livestock feed ». Union Tipografica editorial hispano American México.
- Oluremi O I A, Ngi J and Andrew I A 2007: Phytonutrients in citrus fruit peelmeal and nutritional implication for livestock production. *LivestockResearch for Rural Development. Volume 19, Article #89*. Retrieved November 26, 2016, From <http://www.lrrd.org/lrrd19/7/olur19089.htm>
- Simmons N O 1965 Tecnologia de la fabricacion de piensos « Technology of the manufacture of animal feed ». Editorial Acriba. Zaragoza.
- Skiba F, Metayer J P, Clave H et Quentin M 2009 Valeur énergétique d'une drêche de maïs et effet sur les performances zootechniques de poulets de chair « Energy value of a corn grass and effect on zootechnical performance of broiler chickens ». *Huitièmes Journées de la Recherche Avicole, St Malo, 25 et 26 mars pp 159-163*.

## NUTRITIVE VALUE OF THE ATRIPLEX (*ATRIPLEX HALIMUS L.*), FOLLOWING THE PHENOLOGICAL MARKERS, IN STEPPE AREA (ALGERIA)

Yasmine ARBOUCHE<sup>1\*</sup>, Rafik ARBOUCHE<sup>2</sup>, Achour MENNANI<sup>2</sup>

<sup>1</sup>Department of Agronomy, University of Setif, Algeria

<sup>2</sup>Department of Agronomy, University of Ghardaia, Algeria

\*Corresponding author: yas.arbouche@yahoo.fr

### Abstract

*Atriplex halimus* L. (Chenopodiaceae), has a large role in the feeding of livestock as a halophyte plant in the arid and semi-arid zones of the Mediterranean regions. Its adaptation to pedoclimatic conditions gives it ecological and economic importance. This species is used as a forage plant, particularly during the summer drought period, and is highly valued by camelids, sheep and goats, particularly during the lean season. The variation of the nutritive value through the different phenological stages reveals maximum values of UF (0,81/kg of DM of UFL and 0,79/kg of DM in UFV) and in PDI (165g/kg of DM in PDIN), at the flowering stage and mature grains respectively. The sodium level is minimal at the vegetative stage (2,06% of DM) and maximum at the mature grain stage (4,36% of DM). The Ca and P contents are related to the halomorphic character of the soil. The alkaline pH of the soil inhibits the assimilation of phosphorus. Since the Ca/P ratios are balanced for all the phenological stages. In order to be able to reconciling the nutritive values of the *Atriplex halimus* and its absorbency in Na, it should be exploited in zero grazing, in the mature grain stage. This will make it possible to provide livestock farmers with packaged fodder that will avoid the practice of transhumance (Achaba).

**Keywords :** *Atriplex*, Food, chemical composition, phenology, halophyte plant.

### Introduction

*Atriplex halimus* L. (Chenopodiaceae), halophyte plant has a great ecological and economic importance in the Mediterranean regions due to its adaptation to the pedoclimatic conditions of the arid and semi-arid zones and its role in the feeding of livestock (McKell 1989 ; Le Houérou 2000 ; Martinez *et al.* 2003 et Haddioui et Baaziz, 2001). This species is used as a forage plant, especially during the summer drought period (Le Houerou 1992, Valderrábano *et al.* 1996 ; Bajji *et al.* 2002 ; Abbad *et al.* 2004a). Kinet *et al.* (1998), have shown that this species is a highly valued fodder for camelids, sheep and goats, particularly during the lean season.

Forage and biomass production studies have shown the value of *Atriplex halimus* in Mediterranean semi-arid regions (Ben Ahmed *et al.* 1996 ; Kinet *et al.* 1998).

Under an annual rainfall of 200 to 400 mm, the *Atriplex Halimus* can produce 2,000 to 4,000 kg of dry matter per year per hectare ((Le Houerou 1992, Ben Ahmed *et al.* 1996). The ecological performance of this species and its adaptation to the soil salinity conditions make this species an important part of the pastoral value of the rangelands. In addition, *Atriplex halimus* is a species used both for erosion and desertification control and for the valorization of marginal and degraded soils (Wills *et al.* 1990).

However, the acceleration of the destruction of the best rangelands to the benefit of cereal crops and fruit trees has led to a progressive narrowing of these rangelands. The eradication

of many timber trees and abusive overgrazing, following the abandonment of certain pastoral traditions (rotation of the trails, maintenance of a suitable load per hectare, etc.), have brought about profound changes in potential and physiognomy routes. The combined effects of these factors has resulted in a decrease in the production of the average biomass, the scarcity of the best populations of pastoral species and the proliferation of species with little palatability (Aidoud et Aidoud, 1991).

Although many actions considered to be priorities (natural seeding trials, search for modalities of herd management, creation of forage reserves and extension of fodder crops) have been undertaken, their efficiency remains limited, however, due to the complexity of socio-economic constraints Specific to each region, as well as the lack of strategies integrating the different components of the environment (humans, animals, plants, physical or edaphic factors, etc.).

While there is unanimous support for the need to conserve and develop local plant genetic resources, the main question to be answered is the definition of the different methods of conservation and valorisation.

## **Materials and methods**

### Presentation of the study area

The El-Outaya region is a halomorphic soil depression composed of clay and silt. It is surrounded by mountains ranging from El-Kantara, at the beginning of the city of Biskra. This course, consisting mainly of Atriplex and Salsola, is located 18 km from the town of Wilaya. The climatic characteristics are: annual rainfall of about 124 mm with a maximum rainfall of 13.1 mm in January and a minimum of 1.7 mm in July. The autumn period (September to November) is the rainiest with 15.2mm. The annual average temperature is 21.9 ° C; the warmest month is August (33 ° C) and the coldest January (11.5 ° C). Emberger's climatogram classifies this region in a Saharan winter. An area of one hectare has been protected for five years, for the purposes of experimentation.

### Samples

They were carried out throughout the year. The samples for the chemical analysis and the determination of the weight by weight were carried out on the basis of the appearance of the various phenological reference stages of the species.

### Analyzes and calculations

Dry matter, crude fiber, total nitrogen and mineral content were carried out on 06 samples according of AOAC (1990). The in vitro digestibility of the organic matter was determined by the method of Aufrère (1982). We used the formulas of Demarquilly and Andrieu (1988) and Sauvart et al. (2004), for methods of calculating nutritional value.

## **Results and discussion**

### Chemical composition and digestibility

The rate of dry matter according to the phenological stages reached its maximum at the mature grain stage (32.6%) (Table 1), which is closely related to the climatic conditions.

The percentage of mineral matter varies according to the development and needs of the plant in minerals. The maximum level is at the mature grain stage (28.0% DM) and that of the minimal (23.8% DM) at the vegetative stage.

The rate of crude cellulose changes with the development of the plant to reach a maximum content of 18.3% of MS at the stage mature grain.

The *Atriplex halimus* is well provided with total nitrogenous matter, particularly at the flowering stage where the content is maximum (28,2 % of DM). This is in line with the findings of El Shatnawi and Mohawesh (2000), which report the raw protein richness. The latter is an important source of nitrogen for livestock.

The digestibility of the organic matter is below 50% for all the phenological stages, with a maximum of 0.75 at the fruiting stage.

Table 1. Chemical composition of *Atriplex halimus* according to the reference phenological stages

Components	Vegetative	buds	Flowering	Fruit	Grain mature
Dry matter	25.9±0,4	18.3±0,3	24.2±0,1	28.8±2,1	32.6±6,6
Mineral matter (% of DM)	23.8±0,2	24.0±0,1	25.9±0,3	26.1±1,2	28.0±1,9
Fat (% of DM)	2.2±0,9	2.5±0,1	3.40±0,09	2.8±0,2	2.1±0,2
Crude fiber (% of DM)	11.7±0,09	12.4.6±0,2	16.0±0,7	16.1±2,2	18.3±3,7
Nitrogenous material (% of DM)	18.5.0±0,1	16.1±0,08	28.2±0,4	27.9±1,4	24.3±4,5
DMO	0.64	0.70	0.71	0.75	0.65

DOM : Digestibility of organic matter .

#### Energetic values

Values MFU and Meat FUF (table 2) are maximal at the flowering stage (0,81 and 0,79/kg of DM, respectively). Essafi *et al.* (2007), have found values fluctuating between 0,71 and 0,75/kg of DM in MFU. Nefzaoui and Chermiti (1989), have advanced values in MFU Between 0,60 and 0,80/kg of DM. On the other hand Le houerou (1971), mentioned results that fall between 0,50 and 0,60FU.

Table 2. Forage values (UFL and meatFU / Kg of DM) of the *Atriplex halimus* according to the reference phenological stages

Components	Vegetative	buds	Flowering	Fruit	Grain mature
UFL	0,60	0,72	<b>0,81</b>	0,78	0,68
UFV	0,58	0,69	<b>0,79</b>	0,77	0,66

FUL : Fodder unit for lactation ; meat FU : Fodder unit for meat

### Protein values

PDI (table 3) have maximum values at the mature grain stage with a predominance of PDIN (165.32g / kg DM). Kessler (1990), Reported that high levels of protein and mineral salts permit the use of Atriplex halimus as a forage reserve in summer and fall to address the deficiency in forage that occurs prior to the spring growth of herbaceous forage species.

Table 3. Protein values in g / kg DM of Atriplex halimus according to the reference phenological stages

Components	Vegetative	buds	Flowering	Fruit	Grain mature
DPIN	94,22	118,62	163,41	128,71	<b>165,32</b>
DPIE	81,63	93,94	116,68	100,02	<b>118,07</b>
DPIA	32,86	28,59	<b>50,08</b>	49,55	43,15

DPIN : Digestible protein in the intestine allowed for nitrogen  
 DPIE : Digestible protein in the intestine allowed for energy  
 DPIA: Digestible protein in the intestine allowed for alimentary

### Contents of macro elements (Ca; P and Na)

The Ca level is higher at the setting stage with 2.71% DM. El hamrouni and Sarson (1974), Reported a maximum level of 1.98% DM for cultured Atriplex. The absorption of this element is closely related to the nature of the soil. For Na, the maximum level was 4.38% DM in the mature grain stage, lower than that observed by these same authors (7.4% DM). For Phosphorus, its assimilation is less (1.06% DM), due to the interaction with Ca. For feeding ruminants, the Ca / P ratio is balanced for all the phenological stages.

Table 4. Ca, P and Na (% DM) content of the Atriplex halimus according to the reference phenological stages

Components	Vegetative	buds	Flowering	Fruit	Grain mature
Ca	1,68	1,62	2,41	<b>2,71</b>	1,82
P	0,43	<b>1,06</b>	0,84	0,60	0,52
Na	2,06	3,21	2,93	3,64	<b>4,38</b>

Ca : Calcium ; P : Phosphore ; Na : Sodium

### Conclusion

The energy values are maximal at the flowering stage and the protein values are at the mature grain stage. In order to be able to reconcile the nutritive values of the Atriplex halimus and its absorbency in Na, it should be exploited in zero grazing, in the mature grain stage. This will make it possible to provide livestock farmers with packaged fodder that will avoid the practice of transhumance (Achaba).

## References

- Abbad A, El Hadrami A, El Hadrami I and Benchaabane A 2004. *Atriplex halimus* (Chenopodiaceae): A *Halophytic* species for restoration and rehabilitation of saline degraded lands. Pakistan Journal of [Biological Sciences](#) 7: 1085-1093.
- Aidoud A et Aidoud F 1991 La végétation steppique des hautes plaines : Principaux indicateurs et facteurs de dégradation et de désertification. « The steppe vegetation of the high plains: Main indicators and factors of degradation and desertification. » Techniques et Sciences (Alger), n°- 5, 26-32.
- AOAC 1990. Official Methods of Analysis of the Association of Official Analytical Chemistry. 15th edition Washington, D.C. U.S.A.
- Aufrère J 1982 Etude de la prévision de la digestibilité des fourrages par une méthode enzymatique. Annales de zootechnie, 31, 111-130
- Bajji, M., Kinet, J.M., Lutts, S., 2002. Osmotic and ionic effects of NaCl on germination, early seedling growth, and ion content of *Atriplex halimus* (Chenopodiaceae). Canadian Journal of Botany 80, 297–304.
- Ben Ahmed H, Zid E , El gazzah M et Grignon C 1996 Croissance et accumulation ionique chez *Atriplex halimus* L. Cahiers Agriculture (5) 367 - 372
- Demarquilly C et Andrieu J 1988 Les fourrages. In: R Jarrige (éditeur), Alimentation des Bovins, Ovins et Caprins. « Forages. In: R Jarrige (publisher), Feeding of Cattle, Sheep and Goats. » 315-336. Institut National Recherche Agronomique. Paris
- El hamrouni A et Sarson M 1974 Valeur alimentaire de certaines plantes spontanées ou introduites en Tunisie « Food value of certain spontaneous or introduced plants in Tunisia » Institut National de Recherches Forestières, Tunisie, Note de Recherche 2.
- El-Shatnawi M K and Mohawesh Y M 2000 Seasonal chemical composition of saltbush in semiarid grassland of Jordan. Journal of Range Management 53:211-214.
- Essafi N ; Mounsif M ; Abousalim A ; Bendaou M and Brhadda N 2007 Effets du stress hydrique sur la valeur nutritive d'*Atriplex halimus* L = Effect of the water stress on the nutritive value of *Atriplex halimus* L Sécheresse vol. 18, no2, pp. 123-128 Editeur Libbey-Eurotext, Montrouge, France <http://www.john-libbey-eurotext.fr/e-docs/00/04/31/20/article.phtml>
- Haddioui A and Baaziz M. 2001. Genetic diversity of natural populations of *Atriplex halimus* L. in Morocco: An isoenzyme-based overview. Euphytica 121:99–106.
- Kessler J.J 1990 *Atriplex* forage as a dry season supplementation feed for sheep in the Montane Plains of the Yemen Arab Republic. Journal Arid Environments, 19: 225-234.
- Kinet J M and Benrebiha F 1998 Biodiversity study on *Atriplex halimus* for in vitro and in vivo detection of plants resistant to harsh environmental conditions and for potential micropropagation. Cahiers Agricultures 7(6): 505-509.
- Le Houérou H.N 2000 Restoration and Rehabilitation of Arid and Semiarid Mediterranean Ecosystems in North Africa and West Asia : A Review. Arid Soil Research and Rehabilitation 14 : 3-14.
- Le Houérou, H. N. 1971 An assessment of primary and secondary production of the arid grazing lands ecosystems of North Africa. In *International Symposium on Ecophysiological Foundations of Ecosystems Productivity in Arid Zones*, pp. 168-172. Nauka, Leningrad.
- Le Houérou H.N 1992 The role of saltbushes (*Atriplex* spp.) in arid land rehabilitation in the Mediterranean Basin: a review. Kluwer Academic Publishers, Holanda *Agroforestry systems*, 18: 107-148



- Martínez JP, Ledent JF, Bajji M, Kinet JM and Lutts S.2003. Effect of water stress on growth, Na<sup>+</sup> and K<sup>+</sup> accumulation and water use efficiency in relation to osmotic adjustment in two populations of *Atriplex halimus* L. Plant Growth Regulation 41, 63–73. McKell CM. 1989. Shrub biology and utilization. Academic Press, New York, USA.
- Nefzaoui A et Chermiti A1991 Place et rôle des arbustes fourragers dans les parcours des zones arides et semi-arides de la Tunisie. « Place and role of fodder shrubs in the rangelands of arid and semi-arid zones of Tunisia. » Option Méditerranéennes Serie A ; 16 : 119-25 <http://ressources.ciheam.org/om/pdf/a16/91605054.pdf>
- Sauvant D, Perez J M et Tran G 2004 Table de composition et de valeur nutritive des matières premières destinées aux animaux d'élevage. « Composition and Nutritional Value Table for Raw Materials for Livestock. » INRA. 2ème édition revue et corrigée p.301
- Valderrabano J, Munoz F and Delgado I1996 Browsing ability and utilization by sheep and goats of *Atriplex halimus* L. shrubs. Small Ruminants Research; 19 : 131-6.
- Wills, B.J, Begg J.S.C and Brosnan M.A 1999. Forage shrubs for the South Island dry hill country: 1. *Atriplex halimus* L. (Mediterranean saltbush). Proceedings New Zealand Grassland Association., 52: 161-165.

## WEIGHT PRODUCTIVITY AND NUTRITIVE VALUE OF GRASSLANDS: CASE OF MARSHY AREAS IN NORTH-EASTERN ALGERIA

Fodil ARBOUCHE<sup>1\*</sup>, Yasmine ARBOUCHE<sup>2</sup>, Achour MENNANI<sup>2</sup>

<sup>1</sup>Department of Agronomy, University of Ghardaia, Algeria

<sup>2</sup>Department of Agronomy, University of Setif, Algeria

\*Corresponding author: arbouchefodil@yahoo.fr

### Abstract

Our work aims to determine the chemical composition, digestibility and forage production capacity of floodplains, in order to determine their quantitative and qualitative potentialities. These data will allow the determination of the optimal time grazing or mowing, related to the nutritional value and dry matter yields per hectare. These data will allow the determination of the optimal date of grazing or mowing, related to the nutritional value and dry matter yields per hectare. Two stations were set up, one at the edge of Lake Tonga and one in the marsh Mekhada. There is a better floristic diversity and a harmonious distribution of grass species (Poaceae) and legumes (Fabaceae), ensuring a good balance of the basic ration (energy / protein) in Lake Tonga. The dry matter (DM) and green (GM) levels were maximal at the heading stage for the two stations with 35.77 t of GM and 26.27 t of DM for Lake Tonga and 1.84 t of GM and 0, 95 t of DM for the marsh. Crude fiber content is less important in the vicinity of Lake Tonga than in the Mekhada marsh with a difference of about 3 percentage points. The level of nitrogenous matter is higher in Lake Tonga (between 21 and 26%). In vitro digestibility remains substantially the same for the same phenological stage and feed values take larger values at the edge of the lake Tonga (0.92 to 1.03 / kg DM). Protein values in Lake Tonga are higher than in the Mekhada Marsh. The floodplains around Lake Tonga offer satisfactory forage potential but remain poor in the Mekhada marsh.

**Keywords:** *biodiversity, biomass, lake Tonga, Mekhada marsh, phenological stage*

### Introduction

In flooded areas, major natural vegetation areas are available for rearing and form the basis of animal production, as is the case of the water meadows of the Far East of the country, characterized by a number of very heavy rain (up to 1100 mm of rainfall a year) and clayey nature of its soils. With 40,000 hectares of grasslands, the region of El Tarf covers over 53% of the agricultural area (DSA 2013). Besides their interest in animal feed, grasslands have many environmental advantages and a significant genetic diversity of the present species (Huyghe and al 2010). It has a plant resource in quantity and quality data (nature of the species, digestibility) at the right time, but the demands on these levels vary considerably in the manner of holding and the periods of the year. It is in this level that the natural reserves require a great care for the role that cannot be replaced for any development and the conservation of the biodiversity (Ramade 2002). The botanic composition of the meadow on a given site at a given time is dependent on complex interactions between environmental factors (climate, soil, topography) and management factors (mowing, grazing, organic or mineral fertilization mode) present or past (Louault et al 2002), causes of abundance and dominance variation among plant species, which can affect the recruitment of new species or

the disappearance of old species if they are not adapted to the new conditions (Loiseau et al 1998).

Our work aims to determine the chemical composition, digestibility and forage production capacity of floodplains, in order to determine their quantitative and qualitative potentialities. These data will allow the determination of the optimal time grazing or mowing, related to the nutritional value and dry matter yields per hectare.

## **Materials and methods**

### **Study area**

Located at the extreme North East of Algeria, the wilaya of El -Tarf with an area of 2908 km<sup>2</sup> consists of 40 000ha grassland located around lakes including the Lake tanga and the Marshes of Mekhada which occupies the central part of the plain of Mafragh, over an area of 8 900 ha.

### **Sampling and samples**

Two stations were set up at the edge of Lake Tonga and in the Mekhada marsh on the principle of Rol (1980). The method used is that developed by (Braun-blanquet et al 1952). Its basic concept of minimum area of (Gounot1961) and the concept of association of (Guinochet1973). The samples for analysis and the determination of the weight mass were made on the basis of phenological periods of the main grass species (Demarquilly 1981), because the phenological periods of grasses are more stable over temperature (Durand 1969).

### **Chemical composition and in vitro digestibility**

They are based on the methods laid down by( AOAC 1990). They relate to the determination of the dry matter (DM), mineral matter (MM), crude fiber (CF) and total crude protein (TCP). Cellulose digestibility of organic matter (CellDOM) of the samples was determined by the method of (Tilley and Terry 1963) and improved by (Van Soest and Robertson 1985). The calculation methods Nutrition Facts are based on the formulas by (Demarquilly and Andrieu 1988).

### **Statistical Analyses**

The chemical composition and in vitro digestibility of the OM were analyzed using analysis of variance (**ANOVA**) followed by the linear analysis procedure of the Statistical Analysis System.

## Results and discussion

### Phytosociological records

Table 2: Abundance and dominance (1 to 5) or presence (+ or ++ ) of the main plant species surveyed in station 1 (lake Tonta) and station 2 (marsh Mekhada)

family	latin name	Station 1	Station 2
Amaranthaceae	<i>Amaranthus helioscopia L</i>		+
Apiaceae	<i>Aethusa cynapium L</i>	+	
(ombellifères)	<i>Daucus carota L</i>	+	
Asteraceae	<i>Bellis sylvestris Cyrillo</i>	+	
(composées)	<i>Carduus defloratus L</i>	+	
"	<i>Galactites tomentosa L Moench</i>		+
"	<i>Hypochaeris radicata L</i>	1-1	
"	<i>Leucanthemum vulgare Lam</i>	1-2	
"	<i>Matricaria recuita L</i>		
"	<i>Picris hieracioides L</i>	1-1	
Brassicaceae	<i>Sinapis arvensis L</i>	3-4	+
Euphorbiaceae	<i>Euphorbia helioscopia L</i>	3-2	
Fabaceae	<i>Hedysarum coronarium L</i>	3-2	+
(légumineuses)	<i>Medicago ciliaris L. Krock.</i>		++
"	<i>Trifolium hybridum L</i>		++
"	<i>Trifolium medium L</i>	2-2	
"	<i>Trifolium pratense L</i>	2-1	
"	<i>Trifolium repens L</i>	2-3	
Lamiaceae	<i>Lamium album L.</i>		+
(labiées)	<i>Mentha pulegium L</i>	+	
"	<i>Stachys arvensis L</i>	+	
Malvaceae	<i>Lavatera cretica L</i>		+
Poaceae	<i>Avena fatua L</i>	2-1	2-2
(graminées)	<i>Dactylis glomerata</i>	++	
"	<i>Hordeum murinum L</i>	++	
"	<i>Lolium hybridum L</i>	5-3	
"	<i>Lolium perenne L</i>	5-4	1-1
"	<i>Phleum pratense L</i>	+	
"	<i>Poa trivialis L</i>	+	
Polygonaceae	<i>Rumex sp</i>		++
Primulaceae	<i>Anagallis foemina Mill</i>	+	
"	<i>Anagallis monelli</i>		+
Rubiaceae	<i>Asperula laevigata L</i>	+	

In station 1, we note the dominance of *Lolium perenne L* (English ryegrass) and station 2, that of *Avena fatua L.* (wild oats).

At Lake Tonga, there is a better floristic diversity and a harmonious distribution of grasses species (Poaceae) and legumes (Fabaceae), ensuring a good balance of the basic ration (energy / protein). The number of species is smaller (between 12 and 26) than in the El Feden grasslands in the same region (48 species) (Arbouche et al 2009).

#### Total production of plant materials

Whatever the phenological stage, flood meadows near Lake Tonga yields of green and dry matter higher than the marsh Mekhada. There is a change of the green matter greater than that of the dry matter (DM) (table 1). The dry and green material rates are highest at heading stage for both stations with 35.77Tde green matter (VM) and DM 26.27T for Lake Tonga and VM and DM 0.95T 1.84T respectively for marshes. Arbouche et al (2009), find a production of maximum dry matter at heading period 2.8 T of DM / Ha at the meadows of El Feden in the

same region but at an altitude of 560m. Similarly to Arbouche et al (2008) on a herbaceous stratum under cork oak, yields of the order of 5.43 t of GM / ha are obtained for a yield of 1.26 t / ha of DM. At the level of the Belezma (Aures), Arbouche (1995), at the level of the lawns found a production of 1.76 t DM / ha at heading stage and 2.38 t DM / ha at the fructification stage for prairies with as dominant species *Dactylis glomerata* (orchard grass).

**Table 1:** Production of green and dry matter (t / ha) according to stations and phenological stages

		Vegetative	Montaison	Heading
<b>Lac Tonga</b>	Green matter	30,9	31,43	35,44
	Dry matter	11,66	24,41	26,27
<b>Marais</b>	Green matter	1,24	1,58	1,84
	Dry matter	0,42	0,67	0,95

### Nutritional value

#### Chemical composition and digestibility

The results of the chemical composition and in vitro digestibility are traced in Table 2. We notice a rate of dry matter more important at the level of Tonga Lake, whatever the phenological period. Arbouche et al 2008 and (2009), found lower rates (about 20%) for the same phenological periods. The crude fiber rate is less important to First Lake Tonga as Mekhada marshes around 3 points. The rate of nitrogenous matter is more important at the Lake Tonga (between 21 and 26%), highlighting the richness of this station legumes. In the low and medium altitudes grasslands in the region of El Tarf, Arbouche and Arbouche (2007) found less significant rates (of the order of 10 to 15%). In vitro digestibility remains substantially the same for the same phenological stage; It tends to decrease with the maturity of plant species. The contents of crude fiber and nitrogenous matter are of great importance since during the growing cycle, the digestibility of a plant is positively related to its nitrogen content and negatively to its crude fiber content (Andrieu and Weiss 1981).

**Table 2** Chemical composition in% DM digestibility and based on phenological stages and stations

	Vegetative		Montaison		Heading		SEM	W
	T	M	T	M	T	M		
Dry matter	55.5 <sup>a</sup>	45.3 <sup>b</sup>	68.9 <sup>c</sup>	58.8 <sup>a</sup>	78.2 <sup>d</sup>	72.8 <sup>d</sup>	12.19	0.002
Mineral matter	7.7 <sup>a</sup>	10.4 <sup>b</sup>	7.0 <sup>c</sup>	10.4 <sup>b</sup>	6.8 <sup>c</sup>	9.4 <sup>d</sup>	4.53	0.005
Fat	1.2 <sup>a</sup>	2.2 <sup>b</sup>	1.4 <sup>c</sup>	1.8 <sup>d</sup>	0.87 <sup>e</sup>	0.78	1.18	0.0001
crude fiber	15.7 <sup>a</sup>	19.7 <sup>b</sup>	19.9 <sup>b</sup>	22.9 <sup>c</sup>	21.4 <sup>d</sup>	23.9 <sup>e</sup>	6.25	0.0004
nitrogenous material	26.3 <sup>a</sup>	20.3 <sup>b</sup>	22.6 <sup>c</sup>	15.5 <sup>d</sup>	21.5 <sup>bc</sup>	14.2 <sup>e</sup>	2.65	0.003
In vitro digestibility of organic matter	0.72 <sup>a</sup>	0.71 <sup>a</sup>	0.65 <sup>b</sup>	0.67 <sup>b</sup>	0.60 <sup>c</sup>	0.58 <sup>c</sup>	1.18	0.0005

T : lacke Tonga ; M : march of Mekhada

On the same line, the values with the same sign are comparable to the threshold of 5%

#### forage values

They take the most important values at the shores of Lake Tonga (0.92 à 1.03/kg of DM) whatever their purpose (milk or meat) (Table 4). Contributions in UF are most important in the vegetative period.

Arbouche and Arbouche (2007) on medium altitude grasslands at the same area, are fluctuating between values from 0.73 to 0.65 / kg DM of UFL and 0.64 to 0.61 / kg DM of UFV. For cork oak pastures, Arbouche et al (2008) have advanced UFL values of 0.86 / kg DM and UFV values of 0.59 to 0.60 / kg DM for the heading stage. For grasslands enclaved

at medium altitude, Arbouche et al (2009) found results fluctuating between 0.86 and 0.95 / kg DM for UFL and 0.76 to 0.85 / kg DM for UFV for the same phenological stages.

Table 4: Forage values (/ kg DM) according to stations and phenological stages

		Vegetative	Montaison	Heading
Tonga lake	UFL	1.03	0.94	0.98
	UFV	1.01	0.92	0.94
Marsh	UFL	0.57	0.54	0.51
	UFV	0.55	0.52	0.49

UFL : Feeding unit for lactation; UFV : Fodding unit for meat

### Proteins values

The protein values at the lake Tonga are more important than the marsh Mekhada (table 4) This is due to the stronger presence of legumes in Lake Tonga. Note that contributions in PDIE are equivalent at both sites. The vegetative period, intakes of PDI are the most important.

Lawn enclosed 560 m altitude, Arbouche et Arbouche (2007), found that the PDI are less important values including ear and ear emergence stage sheathed (respectively 66.8 g / kg DM and 60.2 g / kg DM). The DPIF values are equally weak at the enclosed pasture and under cork oak (Arbouche et al 2008 et 2009).

Table 4 Protein values (g / kg DM) in the stations and phenological stages

		vegetative	upstream	heading
Lake TONGA	DPIF	101	92	90
	PDIN	143	99	91
	PDIE	40	32	31
MARSH	DPIF	12.5	12	12
	PDIN	39.5	37	38
	PDIE	42	29,5	32

DPIF: Digestible protein in the intestine foodborne;

PDIE : digestible protein in the intestine permitted for energy;

PDIN : protein digestible in the intestine permitted for nitrogen

### Conclusion

The floodplains around Lake Tonga and marshes of the Mekhada offer forage potentialities that are good for the first site but poor for the second. The areas of the marsh are important, it is necessary to improve yields by introducing new forage native species and conducting farming techniques to increase productivity weight.

### References

- Aoac (1990) Official Methods of Analysis of the Association of Official Analytical Chemistry. 15<sup>th</sup> edition Washington, D.C. U.S.A.
- Arbouche F (1995) Contribution à l'étude d'un facteur limitant le fonctionnement de la phytocénose : cas du pâturage dans la cédraie du Belzma (Aurès). Thèse Magister, Institut national agronomique, Algérie, 132 p.

- Arbouche F et Arbouche H S (2007) Potentialités fourragères des parcours de basses et moyennes altitudes au niveau de la wilaya d'El-Tarf Algérie. *Rev. Recherche agronomique INRA Algérie* 20: 82-91
- Arbouche F, Arbouche R, Arbouche H S, Arbouche Y et Yakhlef H (2008) Evaluation des pâturages forestiers: Cas de la strate herbacée sous chêne liège du Nord Est Algérien. *Livestock Research for Rural Development. Volume 20, Article #35.* <http://www.lrrd.org/lrrd20/3/arbo20035.htm>
- Arbouche F, Arbouche Y, Arbouche R et Arbouche H S (2009): Effets du stade phénologique des prairies permanentes forestières du Nord Est Algérien sur leur production et leur valeur nutritive. *Livestock Research for Rural Development. Volume 21, Article #115.* <http://www.lrrd.org/lrrd21/7/arbo21115.htm>
- Braun-Blanquet J, Roussine N et Nègre R (1952) Les groupements végétaux de la France méditerranéenne édition Centre National de la recherche scientifique Paris 297 p
- Durand R (1969) Signification et portée des sommes de températures. *Bulletin. Technique Information* 238 : 185-190
- DSA (2013) Statistique agricole *Direction des services agricoles* Ministère de l'agriculture Alger (Algérie) 58p.
- Demarquilly C et Jarrige R (1981) panorama des méthodes de prévision de la digestibilité et de la valeur énergétique des fourrages. In : C. Demarquilly (éditeur), Prévision de la valeur nutritive des aliments des ruminants, 41-59. INRA Paris
- Demarquilly C et Andrieu J (1988) Les fourrages. In: R Jarrige (éditeur), Alimentation des Bovins, Ovins et Caprins. INRA. Paris 315-336
- Huyghe C, Boumoville R et Couteaud Y (2010) Prairies et cultures fourragères en France : Entre logiques de production et enjeux territoriaux. Edition INRA Paris, 205p.
- Louault F, Michalet-doreau B, Petit M et Soussana JF (2002) Potentialités des prairies permanentes de montagne pour la production fourragère et la gestion de l'espace. In Actes du colloque INRA-ENITA, 14 et 15 Novembre 2002, Agriculture et produits alimentaires de montagne, ENITAC, Lempdes, France. Collection Acte 8 : 33-39.
- Loiseau P, Louault F et L'homme G (1998) Gestion des écosystèmes pâturés en situations extensives : apports de l'écologie fonctionnelle et perspectives de recherches appliquées en moyenne montagne humide. *Annales de Zootechnie* 47: 395-406.
- Ramade F (2002) Dictionnaire encyclopédique de l'écologie et des sciences de l'environnement. Ed. Dunod, 1063p.
- Rol R (1980) Flore des arbres, arbustes et arbrisseaux, région méditerranéenne. Édit. La maison rustique, Paris 95p.
- Tilley J M A and Terry R A (1963) A two-stage technique for the *in vitro* digestion of forage crops. *Journal of British. Grassland Society.* 18: 108-112.
- Van Soest P J and J B Robertson (1985) Analysis of Forage and Fibrous Foods. A laboratory manual for Animal science. 613 Cornell University, Ithaca, New York, USA.

## PRODUCTIVITY AND NUTRITIVE VALUE OF FOREST PASTURES IN NORTH-EASTERN ALGERIA

Halima Saâdia ARBOUCHE<sup>1\*</sup>, Yasmine ARBOUCHE<sup>2</sup>, Achour MENNANI<sup>2</sup>

<sup>1</sup>Department of Agronomy, University of Ghardaia, Algeria

<sup>2</sup>Department of Agronomy, University of Setif, Algeria

\*Corresponding author: [arbouchehs@yahoo.fr](mailto:arbouchehs@yahoo.fr)

### Abstract

The region of El Fedden located at the border to Tunisia mountainous areas is forestry-pastoral. The tree species are mainly zeen oak and cork oak. The herbaceous layer present in permanent grassland remains the main source of food in the area existing ruminants. The study of these fields after five years of enclosure; allowed us to determine the yields of green matter, dry and nutritional value through the different phenological periods. The optimum period of operation is the heading period the most representative grass. At this period, the fields at this area develop green matter production 14T / Ha to a dry matter value 2,8T / Ha. At the period of optimal exploitation (heading), the crude protein rate is 13.6%. The evolution of crude fiber rate varies by phenological period of the plant and it is maximum fruit set period with 38.3%. The digestibility of organic matter is the most important period in pasture (0.74%). The protein content is more important at the stage pasture (66.47; 95.03; 20.54 from respectively for PIDA; PDIE and PDIN). The grasslands of El Fedden (municipality of bougous), located north of the Algerian level is at an altitude of 560m, offer opportunities in dry matter production and nutritional value that can be improved. The floristic diversity is a predominantly grass.

**Keywords:** *food value, pasture, production, Algeria*

### Introduction

Plant formations, corresponding to different types of shrubs or herbaceous associations, play an important role in the diet of cattle especially in the dry period. Their operations are carried out through various types of transhumance shorter or longer and often interspersed with many steps conditioned by the appearance of the first grass growth.

This type of pasture that uses the forest management (Sarson and Salmon, 1977) must consider the socio-economic context of rural populations. It must be accompanied by silvicultural treatments to stabilize a forest grazing activity whose aim is to produce these landlocked pasture grass as main production intended generally to be grazed on site.

As such, the meadows at the forest of the municipality of bougous through conton of El Fedden, constitute a ground of privileged pathway, providing a herbaceous diet, where the animal can convert vegetation adapted to this milk box, and especially meat ( Derkaoui 1977). However, the practice of breeding and extensive anarchic way in the forest, can only lead to overgrazing, posing the problem of regeneration and sustainability of the forest (El Hamrouni and Sarson 1975).



## Materials and methods

### Presentation of the study area

The region of El Fedden a forest ecosystem is located in the town of bougous north-eastern Algeria. Relief perspective, this is a woody mountainous together 80% of zeen oak (*Quercus canariensis*) and cork (*Quercus suber*) a with a density of 600 trees / ha on average (Arbouche et al 2008). The average area is 12 hectares, of between 5 and 43 hectares. The remaining rangelands is located under cork oak (Arbouche et al 2008).

### Samplings

They were performed according to the method of Braun-Blanquet et al (1952). The choice of plant was performed according to the principle of minimum area.

The area being grazed on a surface of one hectare was enclosure for five years at the most representative site area grazed. A station 10 x 10 m was carried out.

### Sampling and phytosociological surveys

They were performed throughout the year. The samples for chemical analysis and determination of the weight mass were made based on the occurrence of phenological periods of the case main dominant grass (Demarquilly et Jarrige 1981) and the fact that the phenological periods of grasses are the most stable compared to the sum of cumulative temperatures (Durand 1969).

The phenological periods are selected according with Andrieu et al (1988).

### Temperatures

A maxi-mini thermometer was placed in the station according to the standards recommended by Durand (1969). The temperatures were recorded twice a week at the same hour, Friday and Monday from February.

### Analyzes and calculations

The contents of dry matter, crude fiber, crude protein materials and inorganic materials were determined according to the methods of AOAC (1990). The calculation methods Nutrition Facts are based on the formulas of Demarquilly et Andrieu (1988). Statistical analyzes were performed using Statistica program 6.0.

## Results and discussion

### Temperatures

At the station, the respective values of maximum and minimum temperatures range from 18.2 to 35.6 ° C and ° C from 3 to 9.7, respectively. The average maximum temperature value for this region, a 32-year period is of 19.1 ° C.

### Duration and temperature sum for the arrival of phenological periods

The period from 1 February of the onset of phenological periods at the station shows the predominance of *Bromus mollis* is to rank among early species (Table 1).

**Table 1. Duration in days for the advent of phenological stages.**

Species	Pasture	Ear bowden	Heading	Flowering	Nouaison
<i>Bromus mollis</i>	71	77	85	106	113

### Sum of temperatures

The appearance of the first phenological period (pasture) at the station is 153 ° C (Table 2). The flowering periods and fruit set are made at 266 ° C and 293 ° C respectively. At high altitude grasslands (1800m) located in the mountains of Belezma (Aures), the species *Bromus madritensis* totals from vegetation 51.6 ° C, stadiums heading, flowering are reached respectively sums of temperatures of 70 ° C and 103 ° C (Arbouche 1995).

Table 2. Sum of the weekly average temperatures (> 0 ° C) required for the various phenological stages from 1 February (° C)

Species	Pasture	Ear bowden	Heading	Flowering	Nouaison
<i>Bromus mollis</i>	153	173	193	266	293

### Phytosociological survey

Altitude : 560m.  
 Exposition : multiple.  
 Slope : 0%.  
 Area : 100m<sup>2</sup>.  
 Global recovery: 1  
 Strate : herbacée.  
 Soil : heavy.

Species	Abundance / dominance
<i>Asphodelus microcarpus</i>	4-4
<i>Bromus mollis</i>	3-3
<i>Phalaris bulbosa</i>	2-1
<i>Trifolium rupens</i>	2-1
<i>Bellis sylvestris</i>	1-2
<i>Medicago merecxe</i>	1-1

### Total production of plant materials

The green matter (GM) is evolving exponentially grazing period to heading period (10T (tones) of GM / Ha (hectares) and 14T of GM / ha respectively) and regresses to the period fruit set (7T of GM / Ha). Dry matter production is maximum at heading period (2.8 T of DM / Ha). Grazing period is the least expressive value (2.1 T of DM / Ha). De Montard (1991), estimated at the level of French worked grasslands, dry matter production averages 8 T of DM / Ha. Arbouche (1995), at the lawns of Belezma (Aures) is a production of 1.76 T of DM / Ha at heading period and 2.38 T of DM/ Ha fruiting period for grasslands with the dominant species *Dactylus glomerata*.

### Production of plant material according to the botanical families

At the station, the peak of maximum production of green material is to be given to grass with a contribution of 86.5% and made up 12.7%. The maximum contribution pulses appear at the period spike sheathed (2T of GM / ha) with 14.8%. At the heading period, the production of dry matter (2.8 T) is best represented by grasses (2.5T of DM). At stage spur grazing and under gain, dry matter contribution is dominated by compounds with 1.1T / Ha.

### Nutritional value

#### Chemical composition and digestibility

The solids content of the fruit-set period is higher (34.6 %) (Table 6).

Table 6: Chemical composition per % of DM of fields according to the different phenological periods

Components	Pasture	Ear bowden	Heading	Flowering	Nouaison
Dry matter	21.6±0,4 <sup>a</sup>	20.3±0,3 <sup>a</sup>	19.8±0,1 <sup>a</sup>	28.8±2,1 <sup>b</sup>	34.6±6,6 <sup>c</sup>
Miniral matter	9.6±0,2 <sup>a</sup>	11.0±0,1 <sup>a</sup>	10.6±0,3 <sup>a</sup>	6.6±1,2 <sup>b</sup>	6.0±1,9 <sup>b</sup>
Fat	3.2±0,9 <sup>a</sup>	1.2±0,1 <sup>b</sup>	0.80±0,09 <sup>c</sup>	1.2±0,2 <sup>b</sup>	1.2±0,2 <sup>b</sup>
Crude fiber	21.7±0,09 <sup>a</sup>	24.6±0,2 <sup>b</sup>	26.0±0,7 <sup>c</sup>	28.1±2,2 <sup>d</sup>	38.3±6,7 <sup>e</sup>
Nitrogenous material	15.0±0,1 <sup>a</sup>	15.1±0,08 <sup>a</sup>	13.6±0,4 <sup>b</sup>	8.3±1,4 <sup>c</sup>	10.3±4,5 <sup>d</sup>
Digestibility of organic matter	0.74	0.72	0.71	0.63	0.55

On the same line, the values with the same sign are comparable to the threshold of 5%

In period pasture, sheathed ear and ear emergence, the dry matter content is significantly the same. At these same periods, Andrieu et al (1988), refers to the level grasslands half mountain, DM rate of 16.2% in period pasture, 20.4% in the heading period and 21.7% at flowering period. The percentage of inorganic material is dominant in the ear period gain with 11.0%. At the station, the fat content is lower than in European grasslands (1.5%) (Andrieu et al 1988) except grazing period (3.2%). The fat content at this period is related to the chlorophyll pigments content of plants. The percentage of crude fiber rate varies by phenological period of the plant, which is related to weather conditions. It is maximum fruit set period with 38.3%. On the grasslands of medium altitudes, Andrieu et al (1988) suggests a rate of 33.5% at flowering period. At the period of optimal exploitation (heading), the crude protein rate is 13.6%. A smaller rate (11.1%) is reported by Andrieu et al (1988) on medium altitude meadows in the same phenological period. The digestibility of organic matter is the most important period in pasture (0.74%).

#### Energy values

They are the highest period spike sheathed (0.95 UFL (Fodder unit for milk) / kg DM and 0.85 UFV (Fodder unit for meat) / kg DM). Arbouche and Arbouche (2007) on medium altitude grasslands at the same area, are fluctuating between values from 0.73 to 0.65 UFL / kg DM and 0.64 to 0.61 UFV / kg DM.

#### Protein values

At the station, PDI (Digestible intestinal proteins) files are the maximum cob period sheathed with 63.82 ; 95.50 et 20.65 and minimum at flowering period with 36.70 ; 71.08 et 11.34G/kg of DM for the PDIN, PDIE et PDIA respectively. They remain low compared to the results found by Arbouche et Arbouche (2007) (168.5 to 88.96g/kg de DM) period and those of grazing Andrieu et al (1988) (108 à 39g/kg of DM).

#### Conclusion

The grasslands of El Fedden (municipality of bougous), located north of the Algerian level is at an altitude of 560m, offer opportunities in dry matter production and nutritional value that can be improved. The floristic diversity is a predominantly grass.

## References

- Andrieu J, Demarquilly C et Sauvant D (1988) Tables de la valeur des aliments. Les fourrages. « Tables of food value. Forages. » In: R Jarrige (éditeur), Alimentation des Bovins, Ovins et Caprins, 356-444. INRA, Paris
- Andrieu J et Weiss PH (1981) Prévision de la digestibilité et de la valeur énergétique des fourrages verts de graminées et de légumineuses. « Forecast of digestibility and energy value of green forage of grasses and legumes » In: “XI Journées Grenier de Theix“ Prévision de la valeur nutritive des aliments pour les ruminants”, Demarquilly C (coordinateur). INRA Paris 61-79
- AOAC (1990) Official Methods of Analysis of the Association of Official Analytical Chemistry. 15th edition Washington, D.C. U.S.A.
- Arbouche F (1995) Contribution à l'étude d'un facteur limitant le fonctionnement de la phytocénose: cas du pâturage dans la cédraie du Belzma (Aurès). « Contribution to the study of a factor limiting the functioning of phytocenosis: case of grazing in the Belzma (Aures) cedar. » Thèse Magister, Institut national agronomique Algérie, 132p
- Arbouche F et Arbouche H S (2007) Potentialités fourragères des parcours de basses et moyennes altitudes au niveau de la wilaya d'El-Tarf Algérie. « Fodder potentials of the low and medium altitudes in the wilaya of El-Tarf Algeria. » Revue recherche agronomique Institut national de la recherche agronomique d'Algérie 20: 82-91
- Arbouche F, Arbouche R, Arbouche H S, Arbouche Y et Yakhlef H (2008) Evaluation des pâturages forestiers: Cas de la strate herbacée sous chêne liège du Nord Est Algérien. « Evaluation of forest pastures: Case of the herbaceous stratum under cork oak of the North East Algerian. » Livestock Research for Rural Development. Volume 20, Article #35. <http://www.lrrd.org/lrrd20/3/arbo20035.htm>
- Braun-Blanquet J, Roussine N et Nègre R (1952) Les groupements végétaux de la France Méditerranéenne « Plant groups in Mediterranean France » édition Centre National de la recherche scientifique Paris p 297
- Demarquilly C et Andrieu J (1988) Les fourrages. In: R Jarrige (éditeur), Alimentation des Bovins, Ovins et Caprins, « Forages. In: R Jarrige (publisher), Feeding of Cattle, Sheep and Goats. » 315-336. INRA. Paris
- Demarquilly C et Jarrige R (1981) panorama des méthodes de prévision de la digestibilité et de la valeur énergétique des fourrages. « An overview of methods for forecasting digestibility and forage energy value. » In : C. Demarquilly (éditeur), Prévision de la valeur nutritive des aliments des ruminants, 41-59. INRA Paris
- De Montard F X (1991) Réflexions sur la dynamique de la végétation des prairies en moyenne montagne du Massif Central. « Reflections on the dynamics of grassland vegetation in the middle mountain of the Massif Central » Fourrages 125: 85-103
- Derkaoui M (1977) Comportements alimentaires comparés des ovins et des caprins sur un parcours forestier de montagne (vallée de l'Azzem). « Comparative feeding behavior of sheep and goats in a mountain forest (Azzem valley). » Mémoire. 3e cycle. Rabat, Institut Agronomique et Vétérinaire Hassan II Maroc 62p
- Durand R (1969) Signification et portée des sommes de températures. « Meaning and scope of temperature sums » Bulletin. Technique d'Information 238: 185-190
- El Hamrouni A M et Sarson M (1975) Exploitation de parcours forestiers en Tunisie Centrale. « Logging operations in Central Tunisia » I. Georgofili XXXI, Academia economico Agraria Fidenza 175-184
- Sarson M et Salmon P (1977) Elevage, pâturage et données de base pour un aménagement sylvo-pastoral dans la zone n° 2 Tanghaya (Rif Occidental) « Livestock, pasture and basic data for silvopastoral management in zone 2 Tanghaya (Rif Occidental) » Mimeo. Note technique no.20, MOR 73/016, Rabat FAO/Ministère de l'agriculture.

## EFFECT OF CORTISOL LEVEL AND HAIR CHARACTERISTICS ON FERTILITY OF DAIRY COWS IN ALGERIA

Sara LAMARI<sup>1\*</sup>, Toufik MADANI<sup>1</sup>, Lynda ALLOUCHE<sup>2</sup>

<sup>1</sup>Department of Agronomy Faculty of Nature and Life Sciences, University of Ferhat Abbas (Sétif), Algeria

<sup>2</sup>Département of Biology and Animal Physiology, Faculty of Nature and Life Sciences, University of Ferhat Abbas, (Sétif), Algeria

\* Corresponding author: lamarisara@gmail.com

### Abstract

Understanding responses of dairy cows to the effect of hot climate is essential to select more resilient animals. Our study investigated the relationship between hair cortisol level, hair and coat characteristics and fertility of 28 Fleckvieh and 67 Montbéliarde cows during hot and cold season in a commercial farm. Cows were maintained indoors with summer grazing. The following characteristics of hair and coat have been measured : hair cortisol level (C), Hair Weight (W), hair length (L); number of hairs per unit area (N), total hair diameter (HD), hair medullar diameter (MD) and percentage of white coat color (C%). Fertility parameters were estimated: interval from calving to first service (ICS), insemination per conception (IPC), and interval from calving to conception (IC). Statistical analysis was carried using Pearson correlation and Spearman's correlation rank when variables were not normally distributed with the SPSS package program, version 21. In Montbéliarde breed, hair total diameter was negatively correlated with IPC ( $r = -0.338$ ,  $p=0.01$ ) in winter indicating that Montbéliarde cows, with large total hair diameter, required reduced number of IPC to be pregnant, while in summer hair coat traits were not correlated with all fertility parameters. Positive correlations were observed between cows' hair coat characteristics and fertility parameters during Summer. In Montbéliarde breed, hair coat traits were not correlated with all fertility parameters. In Fleckvieh cows, coat color was significantly correlated with ICS and IC ( $r=0.674$ ,  $p=0.02$ ;  $r=0.596$ ,  $p=0.04$ , respectively) during Summer. No association between hair cortisol level and fertility was observed. Proportion of white color in Fleckvieh cows significantly affected fertility. These results indicate that reproductive efficiency parameters are related to coat characteristics; this association was more expressed in Fluckvieh than in Montbéliarde breed. Also, possibility exists to select more adapted animals to warm climate regions.

**Keywords:** *Fertility; hair coat; cortisol; hot season; cows; Algeria*

### Introduction

Heat stress can reduce fertility in cattle (Ealy et al.,1993; Ryan et al., 1992) . The mechanism by which heat stress causes embryonic mortality is multifactorial, as heat stress can alter several aspects of reproductive physiology, including blood flow to the reproductive tract (Roman-Ponce et al., 1977), ovarian steroid concentrations similarly, increased culture temperatures can compromise fertilization rate .To better clarify the physiological adaptations of dairy cows in the semiarid climate, it seemed interesting to follow the reproduction of cows and changes in the activity of the adrenal glucocorticoid versus the axis during a reproductive cycle Hypophyso gonadic. Body surface traits of cattle are of great importance as for the relationships between the animals and their ambience. In semi arid regions animals must be able to dissipate the heat excess through the skin and from

the respiratory surfaces, at the same time they must avoid thermal energy incoming from the environment. The protective properties depend on the morphological characteristics of the skin (color) and of the hair coat (thickness, number of hairs per unit area, diameter of the hairs, length of the hairs), which allow to exchange heat with the environment (DaSilva, 2000). Therefore, genetic progress towards a hair coat, appropriate for hot and humid environments, could be a strategy to enhance reproductive function of cows in Algeria. The present study the relationship between characteristics of hair coat, hair cortisol level and reproduction of Fleckvieh and Montbéliarde during tow season

### **Materials and methods**

This work was conducted from August 2012 to August 2013 on 95 dairy cows comprising two breeds, 28 Fleckvieh and 67 Montbéliarde cows reared in a commercial dairy farm. Cows were separated into two groups according to month of mating: cows mated in ‘cool’ season, and cows mated in ‘hot’ season. The farmer preferred natural service by sires for detection of oestrus. Individual records included cow identification number, parity, dates of natural inseminations and calving dates for all cows. Three fertility parameters were estimated: interval from calving to first service (ICS), interval form calving to conception (IC) and number of services per conception (IPC). Measurements of percentage of white coat color (C%) were carried out and hair sampling as well. To obtain the percentage of white color relative to the whole body surface area, pictures were taken using a digital camera. Then the pictures were transferred to special software (IPWin32) to estimate, at the same magnification, both sides of each animal, except the tail, head, legs, and belly regions, according to the method of Becerril and Wilcox (1992). Hair samples were taken from the center of the thorax of each animal about 20 cm below dorsal line by means of an electrician’s pliers adapted in such a way that all the hairs in an  $1\text{ cm}^2$  area could be plucked out (DaSilva et al., 1988; Silva, 2000a). Hair samples were stored in plastic envelopes and measurements [Hair Weight (W), hair length (L); number of hairs per unit area (N), hair total diameter (HD), diameter of hair medulla (MD)] were done later in the laboratory. The average hair length (mm) of each sample was calculated from the 20 longest hairs of the sample by using a thin metal ruler, according to the method of Udo (1978); number of hairs (hairs/cm<sup>2</sup>) was obtained by direct counting of all hairs present in the sample; an ocular micrometer scale of microscope (Leica DM1000) was used to measure hair total diameters and medullar hair diameters ( $\mu\text{m}$ ) of the same hairs used for length measurement, to about 10  $\mu\text{m}$  of the hair root. Samples were taken from the scapula (shoulder) in August and February respectively for summer and winter seasons. On the scalp, hair growth rate is between 0.2 mm/day and 1.12 mm/day, or 6 to 33.5 mm/ month (Harkey, 1993). In order to avoid the effect of calving stress on level of cortisol only animals that calved more than one month before hair sampling were included in the study. Hair samples were stored in dry conditions at room temperature in the dark, until analysis. To prepare the hair samples, 250 mg hair samples were weighted and washed twice in 9 ml polypropylene tubes containing 5 ml methanol, as proposed by Davenport et al. (2006), and then the samples were gently mixed on a rotator at room temperature for 3 min per wash. The hair was then allowed to dry for approximately 5 days (Paulsen et al, 2001), then weighed and minced into 3-4 mm pieces with fine scissors. To extract cortisol, 50 mg of hair were placed in a glass vial with 3 ml of methanol for 18h at 37° C. Samples were then centrifuged (15 min/1000 rpm) in a centrifuge (Hettich EBA 20) as suggested by Comin et al (2013), and the supernatant collected and transferred to a glass test tube. The supernatant (0.6 ml) was taken from the top, and aliquot was dried using a dry bath SBH200D / 3 Stuart at 37 ° C (Davenport et al., 2006; Bennett and Hayssen., 2010) and reconstituted with 0.3 ml of phosphate buffer. The samples were

analyzed for cortisol using a commercially available Enzyme-linked immunosorbent assay (ELISA) (Human), in duplicates. The average inter- and intra-assay CV was 4.65% and 9.86%, respectively. The mean and standard deviation were calculated and the test for normality (Kolmogorov-Smirnov) was performed for all parameters. Correlation was used to estimate the relationship between characteristics of hair coat, cortisol concentration and reproduction parameters using Pearson correlation, and Spearman's correlation rank when variables were not normally distributed. All statistical analyses were performed using the SPSS package program, version 21.

### Results and discussion

Changes in hair coat characteristics and cortisol concentration are summarized in Table 1. In summer, Fleckvieh cows showed low density coat (393.76hairs/cm<sup>2</sup>); longer hairs (16.50 mm) ;large hair and medulla hair diameter (88.47; 57.47µm respectively ) and colored coat (32.58%).However, Montbeliarde cows present White coat (42.45%),with short hairs (15.83mm) and Many hairs (414.97 hairs/cm<sup>2</sup>) little hair and medulla hair diameter (83.81; 49,49 µm respectively). The cortisol concentration of the hair of both breeds is comparable during this season (table 1). According to the table2, the phenotype of the cows (montbeliarde and Fleckvieh) of the winter season is characterized by a decrease compared to the warm season, the density of the hairs and the cortisol concentration with a higher concentration in Fleckvieh (16.10±2.96 ng / ml). Bertipaglia et al. (2005) reported Holstein coats having average low thickness (2.64 mm), low density (1050 hairs/cm<sup>2</sup>), with short (12.81 mm), thick hairs (62.98 µ m); these findings were interpreted as indicating successful adaptation to the hot conditions in the State of São Paulo, Brazil.

Table 1: Summer variability of hair coat characteristics and cortisol concentration for Fleckvieh and Montbéliarde

	Montbéliarde (32)		Fleckvieh (17)	
	Mean	SE	Mean	SE
C (%)	42.45	5.39	32.58	8.46
W (mg/cm <sup>2</sup> )	9.19	0.39	9.32	0.94
L (mm)	15.83	0.52	16.50	1.08
N (hairs/cm <sup>2</sup> )	414.97	19.17	393.76	21.12
HD (µm)	83.81	0.18	88.47	0.20
MD (µm)	49.49	0.15	57.47	0.21
Cortisol (ng / ml)	17.43	0.76	18.35	0.10

**W** : Hair Weight (mg/cm<sup>2</sup>) ; **C%** : Coat color; **L (mm)** : hair length ; **N (hairs/cm<sup>2</sup>)** : number of hairs per unit area; **TD(µm)** : hair diameter ; **MD(µm)** : medulla diameter of hair.

Table 2: Winter variability of hair coat characteristics and cortisol concentration for Fleckvieh and Montbéliarde

	Montbéliarde (35)		Fleckvieh (11)	
	Mean	SE	Mean	SE
C (%)	31.23	4.63	31.75	10.14
W (mg/cm <sup>2</sup> )	11.58	0.65	11.39	1.71
L (mm)	25.57	0.99	26.09	2.02
N (hairs/cm <sup>2</sup> )	390.11	20.49	385.00	35.77
HD (μm)	89.23	0.20	89.64	0.40
MD (μm)	52.81	0.14	53.55	0.33
Cortisol (ng/ml)	14.26	0.67	16.10	2.96

*W* : Hair Weight (mg/cm<sup>2</sup>) ; *C%* : Coat color; *L (mm)* : hair length ; *N (hairs/cm<sup>2</sup>)* : number of hairs per unit area; *TD(μm)* : hair diameter ; *MD(μm)* : medulla diameter of hair

Table 3 depicts correlations between hair coat traits in summer and winter seasons of Montbéliarde and Fleckvieh breeds and reproduction efficiency parameters. For Montbéliarde breed, HD was negatively correlated with IPC ( $r = -0.338$ ,  $p=0,01$ ) in winter indicating that Montbéliarde cows, with large total hair diameter, required reduced number of IPC to be pregnant, while in summer hair coat traits were not correlated with all fertility parameters. For Fleckvieh cows, coat color was significantly correlated with ICS and IC ( $r=0.674$ ,  $p=0,02$  ;  $r=0.596$ ,  $p=0,04$  respectively) during summer, while negative association was observed only between C% and IPC( $r = 0.858$ ,  $p=0,01$ ) in winter. These results indicate that reproductive efficiency parameters are related to coat characteristics. Coat cover affects temperature regulation and fertility of temperate climate breeds when transposed to warm climate regions (Turner, 1964). Our results also showed that this association was more expressed for Fluckvieh than for Montbéliarde breed. Fleckvieh cows with light colored coat had significant lower fertility, particularly during hot and dry season. Becerril and al, (1993) observed negative, but no significant regression coefficient, for Holstein cows reared under sub tropical climate, while King et al. (1988) observed, during winter months, that white Holstein cows required fewer services per conception and had fewer open days than black cows. Differences in environmental conditions and management were probably the causes of the differences reported.

Table 3. Correlation between hair coat characteristics and reproduction parameters in summer and winter

<i>Characteristics</i>	Montbéliarde			Fleckvieh		
	IPC	ICS	IC	IPC	ICS	IC
<b>Summer season</b>						
C (%)	0.140	-0.113	0.171	0.277	0.674*	0.596*
W (mg/cm <sup>2</sup> )	0.145	0.071	0.200	0.170	0.031	-0.001
L (mm)	0.057	0.008	0.162	-0.313	-0.195	-0.322
N (hairs/cm <sup>2</sup> )	-0.007	-0.071	-0.212	0.066	0.129	0.038
HD (μm)	0.192	0.081	0.401	-0.105	0.237	0.288
MD (μm)	0.248	0.040	0.355	-0.039	0.186	0.238
Cortisol (ng/ml)	0.060	0.235	0.216	-0.369	-0.464	-0.474
<b>Winter season</b>						
C (%)	-0.029	-0.337	-0.287	0.858**	0.392	0.392



W (mg/cm <sup>2</sup> )	0.079	0.224	0.175	0.022	0.276	0.276
L(mm)	-0.062	0.018	-0.075	0.248	0.599	0.599
N (hairs/cm <sup>2</sup> )	-0.164	-0.004	-0.130	-0.380	0.318	0.318
HD ( $\mu$ m)	-0.338*	-0.103	-0.246	0.286	0.405	0.405
MD ( $\mu$ m)	-0.069	-0.137	-0.101	0.210	0.373	0.373
Cortisol (ng / ml)	0.054	0.277	0.253	0.164	-0.502	-0.502

**IPC:** insemination per conception; **ICS:** interval from calving to first service; **IC:** interval from calving to conception.

### Conclusion

The study of the relationship between hair cortisol level, hair and coat characteristics and fertility of Montbéliardes and fleckvieh in semi- arid area shows that cows with thicker hairs during cold season was associated to improved number of mating per conception for Montbéliarde breed, suggesting that the difference was probably generated by the ability of cows to be more adapted to cold season, although the correlation coefficient was moderate. Fleckvieh cows with light colored coat had significant lower fertility, particularly during hot and dry season. Our results suggest the possibility to incorporate certain characteristics of the hair in the selection animals to facilitate their adaptation to this type of environment.

### References

- Becerril CM, Wilcox CJ, Lawlor TJ, Wiggans GR, Webb DW. 1993. Effects of percentage of white coat color on Holstein's production and reproduction in a subtropical environment. *J Dairy Sci*, 74:2286-2291
- Becerril CM, Wilcox CJ. 1992. Determination of percentage of coat color from registry certificates in Holsteins. *J. Dairy SIC*, 75:3582-3586.
- Bennett A., Hayssen,V. 2010. Measuring cortisol in hair and saliva from dogs: Coat color and pigment differences. *Domest.Anim. Endocrinol.* 39:171–180.
- Bertipaglia, E.C.A., DaSilva, R.G., Maia, A.S.C., 2005. Fertility and hair coat characteristics of Holstein cows in a tropical environment.*Anim. Reprod.* 2, 187 – 194.
- Comin A, Peric T, Corazzin M, Veronesi MCC, Meloni T, Zufferli V, Cornacchia G and Prandi A. 2013. Hair cortisol as a marker of hypothalamic-pituitary-adrenal axis activation in Friesian dairy cows clinically or physiologically compromised. *Livestock SICence* 152, 36–41.
- DaSilva, R.G., 2000. *Introdução à Bioclimatologia Animal*. Nobel,São Paulo.
- DaSilva, R.G., Arantes Neto, J.G., Holtz-Filho, S.V., 1988. Genetic aspects of the variation of the sweating rate and coat characteristics of Jersey cattle. *Braz. J. Genet.* 11, 335 – 347.
- Davenport, M.D., Tiefenbacher, S., Lutz, C.K., Novak, M.A. and Meyer, J.S. 2006. Analysis of endogenous cortisol concentrations in the hair of rhesus macaques', *General and Comparative Endocrinology*, vol. 147, pp. 255-261.
- Ealy D, Drost M, Hansen PJ. 1993. Developmental changes in embryonic resistance to adverse effects of maternal heat stress in cows. *Journal of Dairy Science*; 76:2899-2905.
- Harkey MR., 1993.*Anatomy and physiology of hair. Forensic Sci. Int.*; 63:9–18.
- King VL, Denise SK, Armstrong DV, Torabi M, Wiersma F. 1988. Effects of a hot climate on the performance of first lactation Holstein cows grouped by coat color. *J Dairy Sci*, 71:1093-1096.

- Paulsen, R.B., Wilkins, D.G., Slawson, M.H., Shaw, K. and Rollins, D.E. 2001. Effect of four laboratory decontamination procedures on the quantitative determination of cocaine and metabolites in hair by HPLC-MS', *Journal of Analytical Toxicology*, vol. 25, pp. 490-496.
- Roman-Ponce H, Thatcher WW, Buffington DE, Wilcox CJ, Van Horn HH. 1977. Physiological and production responses of dairy cattle to a shade structure in a subtropical environment. *Journal of Dairy Science*; 66:424-430.
- Ryan PD, Boland MP, Kopel E, Armstrong D, Munyakazi L, Godke RA, Ingraham RH. 1992. Evaluating two different evaporative cooling management systems for dairy cows in a hot, dry climate. *J Dairy Sci*, 75:1052-1059.
- Silva RG. 2000. A model for determination of the thermal equilibrium of cattle in a tropical environment. *Rev. Bras. Zootec.* 29: 1244-1252.
- Turner HG. 1964. Coat characters of cattle in relation to adaptation. *Proceedings of the Australian Society of Animal Production*, 5:181-187.
- Udo HM. 1978. Hair coat characteristics in Friesian heifers in the Netherlands and Kenya. *Meded Landbouwhogeschool*, v.78:1-135.

## INFLUENCE OF DATE REBUS AND APRICOT KERNEL MEAL ON FATTENING PERFORMANCE OF LOCAL STRAIN RABBITS (ALGERIA)

Achour MENNANI<sup>1\*</sup>, Rafik ARBOUCHE<sup>2</sup>, Yasmine ARBOUCHE<sup>1</sup>

<sup>1</sup>Department of Agronomy, University of Setif, Algeria

<sup>2</sup>Department of Agronomy, University of Ghardaia, Algeria

\*Corresponding author: achour\_mennani@yahoo.fr

### Abstract

This article addresses the issue of the valorisation and incorporation of agroindustrial by-products into animal feed. The objective of this study was to determine the effects of incorporation of the complex, apricot kernel cake and date rebus in substitution for imported maize and imported soybean meal, on the fattening performance of rabbits, local "white population". A total of 288 rabbits of both sexes, aged 35 days, were divided into 4 equal lots at a rate of 72 individuals per batch and in packs of 06 rabbits per cage, depending on the rate of maize substitution by date scrap and of soybean meal by the apricot kernel cake (0 %, 10 %, 20 % and 30 %). The change in weight from 35 to 77 days is not significantly different between diets. The average daily gain (<sub>35-77 d</sub>) showed a significant difference for the 20 and 30% diets (+ 6 %), an increase in meat proteins in particular for the 10% (+ 8.8 %) and 30% (+ 5.6 %) batches and a marked reduction in the lipid content of the 20% (-19 %) batch. The financial gain being 17.3 € on the quintal of food produced. Incorporation of rebus of dates and apricot kernel cake at a rate of 30 % in substitution for maize and soybean meal, is promising and its increase could define its optimum threshold in the diet of the local strain "white population".

**Key words :** *Rebus of dates, apricot kernel meal, rabbits, local strain, fattening.*

### Introduction

The rabbit species in East Algeria is mostly represented by the local strain known as the "white population". In farming cycles, food expenditures account for 60-70% of production costs (Nworgu et al., 1999), including those of rabbits (60%) (Guermah et al., 2016). The use of unconventional food is one of the alternatives to reduce production costs [Lounaoui-Ouyed et al., 2012]. Economically, it would make available to the most deprived layers, cheap animal proteins. Feed rations for fattening rabbits are mainly made up of soybean meal and maize, raw materials imported by Algeria. Their reduction in the food intake can be done through the dates scrap for maize and apricot kernel meal for soybean meal. The by-products of the date palm are low protein (5.2% total nitrogenous matter), which are concentrated in the nuclei (Chehema et al., 2002). Their chemical composition is variable and depends on the region, the nature of the cultivar (*Degletnor*, *Mechdeglat*, *Litima*)(Bousdira, 2006) And the proportion of cores in the mixture [Genin and al., 2004]. They represent on average 25% of the annual production of dates (M.A. 2007). The use of apricot kernel meal as a protein source in domestic animal feed has been studied only on broiler chickens (Arbouche et al., 2012) and on fattening sheep (Arbouche et al., 2014) and therefore remains very scarce. However, several studies have examined the levels of hydrocyanic acid in apricot kernels (Arbouche, 2012). This rate depends on the varieties of cultivated apricots (sweet almonds or bitter almonds) (Arbouche et al., 2007) and the percentage of each variety in the aggregate

quota treated by the agro-food industries. The increase in apricot areas in Algeria, thanks to the successive national agricultural development plans (NADP), especially at the Hodna level, resulted in an accumulation of by-products generated by agro-industry as the young orchards, which occupy an average of 31 000 ha (M. A, 2007), Planted with a density of 300 trees per hectare.

### **Material and methods**

#### Animals, food diets and experimental protocol

The trial took place during the period from 12/03/2015 to 23/05/2015 at the level of a hutch of a professional breeder located in the commune Rasfa of the wilaya of Setif in the North East Algerian. The 80 m<sup>2</sup> building is equipped with thermal insulation in polystyrene panels. Fans and a pad-cooling humidifier ensure good ambient conditions.

Two hundred and eighty-eight rabbits (288) of both sexes, weaned at the age of 35 days, from the local strain "white population", were randomly distributed into 4 lots at 72 subjects per diet. The rabbits of each lot were housed in collective metal cages at the rate of 6 rabbits / cages. The date scrap comes from the date processing and processing unit located in Tolga wilaya of Biskra and consists of a significant proportion of cores (45%) and pulps de date (55%). The whole was dried in the sun then crushed. The kernels of apricots (mixture of sweet almonds and amamers) come from the apricot processing unit located in N'gaous wilaya de Batna. They were husked and the shell and almond were separated manually. The almond previously dried in the sun was processed to obtain the cake by a hydraulic press according to the principle recommended by Ferradji et al., [2001] and detoxified by a 1% sodium bicarbonate solution (Arbouche et al.,2007). The chemical composition of dates and almond cake was determined using AOAC methods [1990] with triple repetition. The analyzes were carried out on dry matter, total nitrogenous matter, crude fiber, fat, mineral matter and hydrocyanic acid, and gross energy was determined adiabatic calorimetry.

Four rations were formulated, containing 0% (control food), 10, 20, 30% almond spider substitutes for soybean meal and date rejects in substitution for maize during the fattening phase (Table 1). Granular foods were distributed ad libitum daily at 9 am and 4 pm.

The animals were weighed individually at 35; 49; 63 and 77 days at an interval of 15 days. The food consumption of each cage was checked weekly at a fixed time throughout the experiment.

#### Statistical analysis

The different results were treated using the Microsoft Excel spreadsheet. The statistical analysis and the comparison of the mean values between the various food treatments (control and those based on apricot kernel meal and date rejects) were carried out by the ANOVA at A factor using the Statistical Package for Social Science software (SPSS version 21) and then completed by the SNK test (Student-Newman-Keules) and Duncan, when the ANOVA test showed a significant difference in the risk of 5% error ( $p < 0.05$ ).

### **Results and discussion**

Incorporation of the apricot kernel complex and date scraps into food rations did not result in a significant change in the weight of the local strain (Table 2), although it was to be a function of the evolution of the sulfur-containing amino acids of As suggested by Colin [1978] who proposed a maximum threshold of 0.63%, Cheeke [1971] a minimum threshold of 0.45% and Berchiche and Lebas [1994] for the imported strain a rate of 0.62%. Although the levels of cellulose and lignin produced by the apricot kernel meal and the date scraps in the rations are clearly increasing, the ADG<sub>63-77d</sub> of experimental diets are better valued by the local strain, but according to Gidenne and Perez [1993], fiber digestibility may increase or

decrease between weaning and slaughter age and is a function of the fiber source [De Blas and Carabano 1996] and the nature of the parietal constituents [Gidenne 2003]. Mean daily intake and consumption indices are affected by the incorporation rates of apricot kernel meal and date discards in the diets throughout the rearing phase (35<sup>th</sup> to 77<sup>th</sup> days). These regressions are due to the polysaccharides contained in the date rejects (1996) and to the interactions of the fibers of dates and almond cake as De Blas and Carabano (1996) point out, on various agroindustrial sub-products used in the aquaculture feed. The substitution of maize and soybean meal has no influence on the yield at slaughter (Pcf / Pva) of the local strain (64,50%), and remains in the range advanced by Bouguerra [2012] (64.25 to 69.87%), and is lower than that of the New Zealand strain imported (between 58 and 60%) (Berchiche and Lebas 1994). The other slaughter parameters and carcass characteristics are not influenced by the by-products incorporation rates (Table 3). Incorporation of 30% date rejects increases the fattenability of the local strain by reference to the peri-renal weights of Moulla (2006) (20.06%) and Bouguerra [2012] (18.64%), for the same strain.

TABLE 1: Formula (kg / 100 kg feed) of foods distributed to rabbits based on the substitution rate of soybean meal by apricot kernel meal and corn by date scrap

% of substitution	0%	10%	20%	30%
<b>Ingredients</b>				
Corn	20	18	16	14
Rebuts of dates	0	2	4	6
Soybean meal	12.7	11.43	10.16	8.89
Apricot almond cake	0	1.27	2.54	3.81
Bran	32	32	32	32
Wheat straw	4.7	4.7	4.7	4.7
Dehydrated alfalfa	29	29	29	29
Salt (NaCl)	0.5	0.5	0.5	0.5
Premix rabbit (CMV)	0.5	0.5	0.5	0.5
Calcium carbonate	0.5	0.5	0.5	0.5
L- Lysine	0.081	0.085	0.085	0.085
DL-Méthionine	0.015	0.015	0.015	0.015
<b>Calculated nutrient levels</b>				
Crude fiber %	15.20	15.36	15.52	15.67
NDF%	33.71	34.07	34.44	34.80
ADF%	18.72	18.96	19.20	19.44
ADL%	4.24	4.40	4.57	4.73
Hémicellulose %	14.99	15.11	15.23	15.36
Lysine%	0.82	0.85	0.89	0.92
Méthionine%	0.24	0.28	0.31	0.34
A. Total Sulfur Amines %	0.50	0.52	0.55	0.57
Proteins. Digestible %	11.16	11.05	10.93	10.82
Digestible energy rabbit Kcal/kg	2483	2473	2463	2453
Metabolizable energy rabbit Kcal/kg	2373	2369	2365	2361
Cellulose VS ADF-ADL%	14.48	14.56	14.63	14.71
PD/ED calculated g/1000kcal	44.95	44.67	44.39	44.11

Premix (Rabbit CMV at 1%) provided per kg diet: Se, 0.08; Mg, 2.6; Mn, 2.0; Zn, 6.0; I, 0.08; Fe, 4.0; Cu, 1.10; S, 6.8; Co,0.04; thiamin, 0.20; riboflavin, 0.20; calcium d-pantothenate, 0.8; pyridoxine, 0.10; biotin, 0.004; nicotinicacid, 2; choline chloride, 12; folicacid, 0.20; vitamin K3, 0.1; dl- $\alpha$ -tocopherylacetate, 2.0; biotin, 0.004; folicacid, 0.2; cyanocobalamin,0.002; vitamin A, 950000 IU; vitamin D3, 120000 IU .

Tableau 2 : Evolution de la croissance pondérale et du GMQ durant l'engraissement des lapereaux en fonction du pourcentage de substitution du tourteau de soja par le tourteau d'amande et du maïs par les rebuts de dattes.

	% de substitution				ESM	P
	0%	10%	20%	30%		
Poids (g) (35i)	754±95,49	739±89,14	691±110,78	703 <sup>(b)</sup> ±92,89	8,32	<b>0,02(*)</b>
Poids (g) <sub>(49i)</sub>	1232±114,49	1186±173,90	1141±183,06	1173±133,64	12,97	<b>0,10(NS)</b>
Poids (g) <sub>(63i)</sub>	1750 ±129,51	1662±189,30	1671±147,03	1672±163,02	13,42	<b>0,07(NS)</b>
Poids (g) <sub>(77i)</sub>	2070 ±130,64	2024±167,43	2101±137,79	2098±183,76	13,57	<b>0,15(NS)</b>
GMQ (35-49i)	31,8±8,07	29,8±7,18	30,0±8,29	33,4±17,73	0,62	<b>0,59(NS)</b>
GMQ (49-63i)	34,6 ±8,09	31,7±5,73	35,3±9,46	35,6 ±22,80	0,64	<b>0,21(NS)</b>
GMQ (63-77i)	21,3 <sup>a</sup> ±5,30	23,2 <sup>b</sup> ±5,43	28,5 <sup>c</sup> ±7,95	28,4 <sup>c</sup> ±6,97	0,62	<b>0,001(***)</b>
GMQ (35-77i)	31,4 <sup>a</sup> ±9,80	30,5 <sup>b</sup> ±8,29	33,5 <sup>c</sup> ±8,20	33,2 <sup>c</sup> ±10,55	0,84	<b>0,001(***)</b>

GMQ : gain moyen quotidien en g/j (les indices indiquent la période en jour sur laquelle ce paramètre a été calculé). La présence de différentes lettres sur la même ligne indique une différence significative entre les régimes alimentaires (P < 0,05).

TABLE 3: Evolution of slaughter parameters, carcass characteristics and chemical composition of the rabbit meat for fattening of the local strain as a function of the percentage of substitution of soybean meal by almond and maize meal by date scrap .

% of substitution	0%	10%	20%	30%	ESM	P
<b>Slaughtering parameters</b>						
Liveweight at slaughter (Pva) (g)	1994 <sup>ab</sup>	1957 <sup>a</sup>	1992 <sup>ab</sup>	2088 <sup>b</sup>	18,72	*
Weight of the warm carcass (Pcc)(g)	1414	1473	1469	1488	15,89	NS
Weight of the cold carcass (Pcf)(g)	1266	1242	1255	1347	19,71	NS
Weight of the reference carcass (Pcr)(g)	985	951	967	1039	16,89	NS
Performance Pcc/Pva (%)	70,9	75,3	73,8	71,3	0,87	NS
Performance Pcf/Pva (%)	63,5	63,4	62,9	64,5	0,54	NS
Muscle / bone ratio	8,04	8,09	8,71	9,37	0,34	NS
<b>Carcass characteristics</b>						
Weight of liver (WL)(g)	55,3	54,6	60,6	62,6	1,79	NS
Liver Ratio /Pva (%)	2,77	2,79	3,04	3,00	0,08	NS
Weight of peri-renal fat (Pgpr)(g)	20,0	29,3	22,0	28,0	2,2	NS
Perennial kidney / body weight ratio (Pgpr/Pva (%))	1,00	1,49	1,10	1,33	0,11	NS
Peri-renal fat ratio / warm carcass (%) (Pgpr/Pcc)	1,56	2,32	1,75	2,07	0,15	NS
Weight of the skin (g)	199	190	181	197	6,06	NS
Proportion of skin /Pva (%)	9,9	9,7	9,1	9,40	0,28	NS
Weight of the digestive tract plein(g)	331	320	326	317	9,89	NS
Full digestive tract ratio /Pva (%)	16,6	16,4	16,4	15,2	0,54	NS
Front part weight (g)	345	346	351	382	9,23	NS
Rear part weight (g)	384	380	373	410	7,21	NS
Weight intermediate part "râble"(g)	256	224	242	246	2,84	NS
Ratio of front part to warm carcass (%)	17,3	17,6	17,6	18,3	0,37	NS
Ratio of rear part to warm carcass (%)	19,2	19,4	18,7	19,6	0,24	NS
"Râble" / warm carcass ratio (%)	12,8	11,5	12,2	11,8	0,21	NS
<b>Chemical composition of meat</b>						
pH	6,40 <sup>a</sup>	6,47 <sup>b</sup>	6,53 <sup>d</sup>	6,60 <sup>c</sup>	0,05	***
Water content (%)	65,34 <sup>a</sup>	66,04 <sup>b</sup>	68,88 <sup>d</sup>	67,84 <sup>c</sup>	0,42	***

Proteins (%)	19,31 <sup>b</sup>	21,00 <sup>a</sup>	18,87 <sup>d</sup>	20,39 <sup>c</sup>	0,25	***
Fat (%)	12,95 <sup>b</sup>	11,11 <sup>c</sup>	10,52 <sup>a</sup>	10,87 <sup>d</sup>	0,28	***
Mineral materials (%)	1,10 <sup>a</sup>	1,05 <sup>b</sup>	1,10 <sup>a</sup>	0,90 <sup>d</sup>	0,02	***

SEM : Standard error to mean , NS : no significant, \* significant. \*\*\* Very significant

The results of the pH of the meat remain different from those of other authors (Blasco and Piles 1990, Parigi Bini et al., 1992) and are not influenced by the genetic type as reported by Lambertini et al., [1996]. They evolve proportionally with the rates of incorporation of by-products of dates and apricot kernel for the strains of rabbit and remain high (6,60) because the measurement of an hour post mortem did not Allowed the triggering of the different glycolytic activities in the muscles as reported by Lambertini et al., [1996], which only intervene after 24 h post mortem. This high pH causes the maladjustment at the refrigeration because the proteolytic microorganisms develop bad odors there [Gill and Newton 1981].

Because of its rusticity, the local strain enhances the protein sources of the diets by better protein synthesis, and remains in the standards advanced by Ouhayoun [1992] (20 to 23%).

The lipid contents of the meat of the strains are inversely proportional to the rates of incorporation of the dates scraps and the apricot kernel meal and are higher for the New Zealand strain. According to Dalle Zotte [2002], they depend on age, sex, genotype, diet and type of rearing. They remain in the interval by Salvini et al, [1998] (0.6-14.4%).

The production costs of the two by-products were calculated according to the fixed or variable loads. The apricot kernel meal is obtained after treatment of the apricot kernels in several stages: drying, dehulling, sorting, oil extraction and detoxification. The two raw materials obtained are: meal and almond oil. Taking into account all the expenses and the sale of the oils, the price of the kilogram of almond cake produced is DZD (Algerian dinar) 00.

The date scrap is generated by the processing and packaging units, these by-products are sold at the rate of 10DZD per kilogram. Taking into account the four dietary formulas used in our study; Control diet with 0% substitution (standard diet), experimental diets with 10%, 20% and 30% soybean turnover by apricot kernel meal and maize by date scrap and prices, the financial opportunity of the by-products integration is fairly consistent with - 9% on the price of the quintal of food produced for an incorporation rate of 30%.

### Conclusion

The complex dated / apricot kernel complex can be considered a source rich in total nitrogen (47%) and fiber (32%) and can be used as an alternative to the maize / soybean meal complex. Substitution rates of up to 30%, without adverse effects on growth rate, dietary intake or slaughter yield. It improves the feed conversion rate for both strains of rabbit, as well as the chemical composition of the meat especially of the local strain and lowers the cost price of the quintal of food produced. It would be interesting to increase the substitution rates in order to determine the optimum thresholds.

### Acknowledgement

We would like to thank Cnep Phc Tassili for his contribution to the realization of this study.

### References

AOAC 1990.: Official Method of Analysis, 15th edition. Association of Analytical Chemists, Inc. Arlington, Virginia, USA. 1230 pages

- Arbouche F. 2012: Tables de composition et de valeur nutritive des matières premières produites en Algérie pour l'alimentation des ruminants, 46 pages, Inst. Natio. Rech. Agro. Algérie Editeurs, Alger.
- Arbouche R., Arbouche F., Arbouche H.S., Arbouche Y. 2007: Valeur nutritive d'un oléagineux dans l'alimentation des ruminants: Cas de l'amande d'abricot et de son tourteau. *Livest. Res. Rural Develop.*, 19, Article #189, from <http://www.lrrd.org/lrrd19/12/arbo19189.htm> (Consulté le 30/05/2016).
- Arbouche R., Arbouche F., Arbouche H.S., Arbouche Y. 2012: Effets sur les performances de croissance de l'incorporation du tourteau d'amandes d'abricots dans la ration des poulets de chair *Rev. Méd. Vét.*, 163, 475-479
- Arbouche R., Arbouche F., Arbouche H. S., Arbouche Y. 2014: Effets de la nature du complément azoté (tourteau d'amande d'abricot vs tourteau de soja) sur les performances d'engraissement et la qualité des carcasses des agneaux Ouled Djellal (Algérie) *Revue Méd. Vét.* 165, 338-343  
[http://www.revmedvet.com/2014/RMV165\\_338\\_343.pdf](http://www.revmedvet.com/2014/RMV165_338_343.pdf)
- Berchiche M., Lebas F. 1994: Methionine supplementation of a faba bean-based feed: effects on rabbit growth and carcass characteristics. *World Rabbit Sci.*, 2 [4]:135-140
- Blasco A., Piles M. 1990: Muscular pH of the rabbit. *Ann. Zoot.* 39:133-136.
- Bouguerra A. 2012 : Contribution à l'évaluation des performances zootechniques du lapin de population locale élevé en semi plein air ; Thèse de magister ENSA Alger, 90p
- Cheeke P.R. 1971: Nutritional and physiological implications of saponins. A review *Canadian J. Anim. Sci.*, 51: 621-632.
- Chehma A., Longo H.F., Bada A., Mosbah M. 2002: Valeur alimentaire des sous-produits du palmier dattier, de la paille d'orge et du Drinn chez le dromadaire. *Jr. Alg. Régions Arides.*, 33-44.
- Colin M. 1978: Contribution à l'étude des besoins en acides aminés essentiels du lapin en croissance. Thèse de docteur-ingénieur, Université de Montpellier,
- Dalle Zotte A. 2002: Perception of rabbit meat quality and major factors influencing rabbit carcass and meat quality. "Livestock Production Science", 75/1, pp. 11-32.
- De Blas J.C., Carabano R. 1996: A review on the energy value of sugar beet pulp for rabbits. *World Rabbit Sci.*, 4, 33-36
- Ferradji A., Imerzouken M., Malek N., Boudour N. 2001: Effets de quelques paramètres sur l'extraction d'huile des amandes d'abricot par pressage. *Ann. Instit. Nat. Agro. El-Harrach [Alger]*, 22, 49-59.
- Genin D., Kadri A., Khorchani T., Sakkal K., Belgacem F., Hamadi M. 2004: Valorization of date-palm by-products [DPBP] for livestockfeeding in Southern Tunisia. Potentialities and traditional utilization. *Options Méditerranéennes.*, 221-226
- Gidenne T. 2003: Fibres in rabbitfeeding for digestive troubles prevention: respective role of low-digested and digestible fibre. *Livest. Prod. Sci.*, 81, 105-117
- Gidenne T., Perez J.M. 1993: Effect of dietary starch origin on digestion in the rabbit. 1. Digestibility measurements from weaning to slaughter. *Anim. Feed Sci. Technol.*, , 42, 237-247.
- Gill C.O., Newton K.G. 1981: Microbiology of DFD beef. *Curr. Top. Vet. Med. Anim. Sci.*, ,10, 305-321.
- Guermah H., Maertens L., Berchiche M. 2016: Nutritive value of brewers' grain and Maize silage for fattening rabbits *World Rabbit Sci.*, 24 : 183-189
- Lambertini L., Lalatta Costerbossa G., Petrosina G., Zaghini G., Vignola G., Benassi M.C., Gatta P.P. 1996: Caractéristiques histochimiques du muscle et pH de la viande de lapins hybrides sacrifiés à différents âges. *World Rabbit Sci.*, 4, 171-179.



- Lounaouci-ouyed G., Berchiche M., Lebas F. 2012: Effects of gradual incorporation [40 to 60%] of hard wheat bran, in simplified bran-alfalfa-maizediets, on viability, growth and slaughter traits of rabbits of white population under Algerian context. In Proc. : 10th World RabbitCongress, 3-6 September, Sharm El-Sheikh, Egypt., 903-907.
- Moulla F. 2006: Evaluation des performances zootechniques de l'élevage cunicole de la ferme expérimentale de l'institut technique des élevages. Mémoire de magister en sciences animales ENSA Alger, 92p
- M A. 2007 : Statistiques, ministère de l'agriculture, Algérie.
- Nworgu FC., Adebawale EA., Oredein OA., Oni A. 1999: Prospect and economics of broiler production using two plant protein sources. Trop. J. Anim. Sci. 2(1): 159-166
- Ouhayoun J. 1992 : Quels sont les facteurs qui influencent la qualité de la viande de lapin ? *Cuniculture*, 19, 137-175.
- Parigi bini R., Xiccato G., Cinetto M., Dalle zotte A. 1992: Effect of slaughterage, slaughterweight and sex on carcass and meatquality in rabbit. 2. Chemical composition and meatquality. *ZootNutrAnim*, 18, 173-190.
- Salvini S., Parpinel M., Gnagnarella P., Maisonneuve P., Turrini A. 1998: Bancadati di composizione degli alimenti per studiepidemiologici in Italia. Ed. IstitutoSuperiore di Oncologia.. 958p

## EFFECT OF HERBAL SUPPLEMENTATION TO TMR DIET ON LIPID PROFILE OF BLOOD AND MEAT IN SHEEP

Abdullah Al Sufian SHUVO, Md. Rahat Ahmad REDOY, Mohammad AL-MAMUN\*

Department of Animal Nutrition, Bangladesh Agricultural University, Mymensingh-2202, Bangladesh

\*Corresponding author: mamamun@bau.edu.bd

### Abstract

An experiment was conducted to investigate the effect of a medicinal herb plantain (*Plantago lanceolata* L.) supplementation on growth performance, carcass characteristics in sheep. For this experiment 12 indigenous Garole sheep (*Ovis aries*) of one year of age around  $9\pm 0.7$  kg of live weight (LW) were divided into two groups and each group having randomly selected six sheep using Randomized Block Design. One group was supplied roadside grass, wheat bran, molasses based total mixed ration (TMR) pellet (ME=2240 kcal/kg dry matter, CP=14.21%) which was considered as control diet (TMRP-diet). In another group, the TMRP-diet was supplemented with 5% plantain (*Plantago lanceolata* L.) herb that was termed as TMRPPL-diet. In both the dietary treatments the energy and protein were offered at 1.5 times of the maintenance level for a period of 90 days. The LW was recorded at the onset of, and then every week interval throughout, the experimental period. The LW gain, and total digestible nutrients were higher ( $P < 0.05$ ), and the feed conversion ratio was significantly lower ( $P < 0.05$ ) in TMRPPL-diet compared to TMRP-diet. Plasma glucose and triglycerides concentration, and caul fat and pelvic fat were significantly lower ( $P < 0.05$ ) in sheep fed TMRPPL-diet compared to the sheep fed TMRP-diet. It could be concluded that supplementation of plantain herb might be used as additive in Garole sheep diet for better growth performance and lean meat production.

**Key words:** *Plantain, sheep, TMR pellet, plasma metabolites, meat characteristics.*

### Introduction

The livestock sector globally is highly dynamic. In developing countries, it is evolving in response to rapidly increasing demand for livestock products. In developed countries, demand for livestock products is stagnating, while many production systems are increasing their efficiency and environmental sustainability. Consumption of sheep meat increases from 75000 MT (1990) to 140000 MT (2002) with an annual growth rate of 5.8% which is greater than beef (2%) and poultry (3.4%) (FAO, 2005). In Bangladesh, around 8% of total protein for human consumption comes from livestock. Commercial livestock farming requires huge amount of land for fodder production but intensive stall feeding can overcome this condition and in this situation total mixed ration (TMR) pellet prepared using rice straw, grass, wheat bran, mustard oil cake, molasses would be one of the best solution for boosting up livestock productivity in our country. Different agro industrial by products could be used in pellet preparation and dry grass and straw could be used in pelleting which are normally rejected by sheep when that is offered in loose condition. Antibiotic growth promoter enhances the productivity of livestock but it is reported that the use of antibiotics and synthetic growth promoters create a hazardous long-term effect in the human body. Since January 2006, the European Union (EU) has taken steps towards phasing out the authorization of antimicrobial growth promoters after that scientists started their research to explore new alternative for the

antibiotic growth promoter (Castanon 2007). Now-a-days people are more conscious about their health and most of the people prefer low cholesterol content food. A growing awareness among consumers to consume antioxidant-rich foods has provided opportunities for the livestock industry to focus on production of antioxidant-rich milk and meat or functional foods. In this situation plantain (*Plantago lanceolata L.*) would be one of the best solution to produce animal products of low cholesterol content and safe food for human. Because plantain is one of the perennial herbs contain bioactive components (Al-Mamun *et al.* 2008), anti-bacterial property (Ishiguro *et al.*, 1982), enzyme inhibitory activity, and anti-oxidative activity (Al-Mamun *et al.* 2007a). Plantain also had positive influence on plasma nutrient metabolism in ruminants (Sano *et al.* 2002; Al-Mamun *et al.* 2007b). The plantain showed resistance to exogenous insulin in sheep (Al-Mamun *et al.* 2017). Therefore, it was expected that due to the antioxidant potential, the supplementation of plantain to TMR pellet would enhance the meat quality through reducing body fat, and plasma lipids, and might improve growth performance of sheep.

### **Materials and methods**

This study was ethically approved by the Bangladesh Agricultural University Research System (Approval no. A 39.069.2016-2017). The experiment was conducted at the Department of Animal Nutrition, Bangladesh Agricultural University, Bangladesh during August-December, 2016. Twelve local Garole sheep (*Ovis aries L.*), aged around one year and weighing around  $9\pm 0.7$  kg was used to conduct the experiment. The animals were divided into two groups having randomly selected six sheep in each group. One group was supplied roadside grass, wheat bran, molasses based total mixed ration (TMR) pellet (ME=2240 kcal/kg dry matter, CP=14.21%) which was considered as control diet (TMRP-diet). In another group the TMRP-diet was supplemented with 5% plantain (*Plantago lanceolata L.*) herb that was termed as TMRPPL-diet. The feeding trial was performed for a period of 90 days. Urine and feces samples were collected last 7 days of experimental period. Blood samples (5 ml each) were collected on day 89 of the feeding trial in a heparinized tube and kept in an ice box until centrifugation. On day 90, the animals were slaughtered and meat samples were collected. Weight of caul fat and pelvic fat were also recorded. The hot carcass weight was measured after complete dressing and evisceration. Proximate components of feed feces and meat sample, and nitrogen content of urine was analyzed by Khzeldhal method (AOAC, 1995). Concentration of plasma glucose was enzymatically determined by the method of Huggett and Nixon (1957). Cholesterol was determined by Cholesterol oxidase method or CHOD/POD method (Allain *et al.*, 1974). Triglycerides were estimated using commercial available reagent kit (Atlass Co. Ltd) according to Buccolo and David (1973). Phosphotungstic and magnesium ions specifically precipitate LDL. After centrifugation the cholesterol content of the HDL in supernatant was determined using crescent diagnostics cholesterol test kit (Cat No. CS 603) using the equation developed by Friedewald *et al.* (1972).

### **Results and discussion**

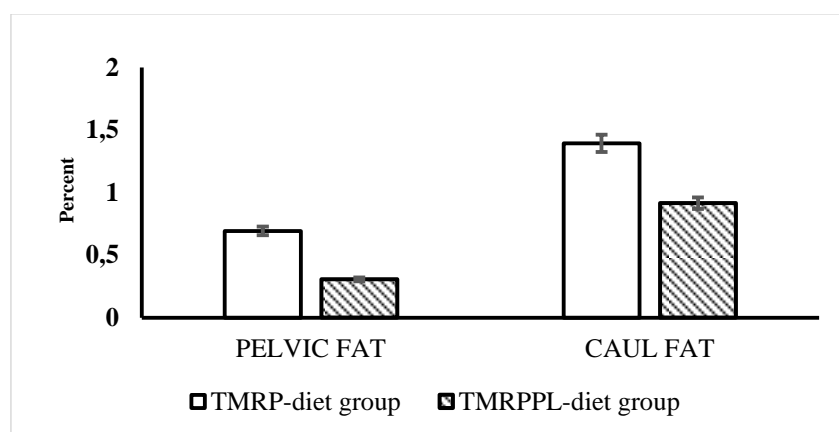
#### **Live weight gain and Feed Conversion Ratio**

Total live weight gain, daily live weight gain was significantly higher ( $P < 0.05$ ) in TMRPPL-diet group and FCR was lower in TMRPPL-diet group than TMRP-diet group which indicates the efficient utilization of feed in TMRPPL-diet group. Rumball (1997) also reported higher growth rates of calves and lambs by supplementing plantain herbs that agreed

with the current finding. Kemp *et al.* (2010), also reported that plantain fed with mixed pasture had better live weight gain in sheep and cattle. Higher body weight gain might be due to the improved metabolism of Fulkerson *et al.* (2008) stated that improvement of lamb's growth rate from grazing plantain might be due to increased metabolizable protein supply and another scientist Al-Mamun *et al.* (2008) reported that plantain helped to increase whole body protein synthesis in Sheep.

### Carcass characteristics and fat deposition

There was no significant difference ( $P < 0.05$ ) in carcass characteristics between TMRPPL-diet group and TMRP-diet group other than caul fat and pelvic fat. Caul fat and pelvic fat have significant difference between the two groups and caul fat and pelvic fat was lower in TMRPPL-diet group than TMRP-diet group. There was also significant difference ( $P < 0.05$ ) in dressing percentage and dressing percentage was higher in TMRPPL-diet group.



**Figure 1:** Graphical presentation shows the effect of plantain (*Plantago lanceolata L.*) supplementation on caul fat and pelvic fat deposition in sheep. TMRP-diet, total mixed ration pellet; TMRPPL-diet, total mixed ration pellet plus 5% plantain (*Plantago lanceolata L.*) herb.

### Plasma metabolites

Supplementation of plantain reduced serum glucose and triglyceride concentration in treatment group. Total cholesterol, HDL-cholesterol and LDL- cholesterol had no significant difference between the treatment groups, but numerically lower in TMRPPL-diet group. Yoshida *et al.*, (2013) reported that supplementation of plantain reduced serum free-fatty acid and glucose levels which also supports the present findings.

**Table 1: Effect of plantain on plasma metabolites of sheep**

Parameters		TMRP-diet	TMRPPL-diet	SEM	p-value
Plasma	Glucose	5.26	4.43	0.21	0.002
	(mmol/dL)				
	Triglycerides (mg/dL)	69.94	55.80	3.23	0.001
	Total Cholesterol (mg/dL)	85.06	75.62	2.15	0.100
	HDL-Cholesterol (mg/dL)	51.04	48.12	1.01	0.558
	LDL-Cholesterol (mg/dL)	20.04	16.34	0.98	0.154

SEM=Standard error of means, TMRP-diet, total mixed ration pellet; TMRPPL-diet, total mixed ration pellet plus 5% plantain (*Plantago lanceolata*) herb.

### Mutton quality and sensory properties

Proximate components of mutton had no significant difference except ether extract. Zhou *et al.*, (1991) stated that plantain acts as a strong superoxide anion scavenger and antioxidant. Antioxidant prevents auto oxidation in the body for which fat is reduced. Launert (1984) was also showed that plantain contains tannins thus they might affect carcass composition. No significant difference was found between two dietary treatment group in term of meat quality like cooking loss, dripped loss but higher rib eye was found in TMRPPL-diet group. There was significant difference in flavor, juiciness, tenderness and overall acceptability between the two dietary groups and overall acceptability was higher in TMRPPL-diet group than TMRP-diet group, which might be due to the presence of antioxidant potential of plantain (Al-Mamun *et al.*, 2007a). According to Aberle *et al.*, (2001) after slaughtering oxidation deteriorate the color and flavor of meat, but if antioxidant rich feed is supplied sufficiently, it will helpful for preserving the quality of meat. For this reason, the meat of TMRPPL-diet group has good color, flavor and juiciness than TMRP-diet group.

**Table 2. Effect of plantain supplementation on proximate composition and quality of sheep meat**

Parameters	TMRP-diet	TMRPPL-diet	SEM	P-value
Moisture (%)	72.68	72.5	0.41	0.857
Crude protein (%)	21.4	21.9	0.39	0.588
Crude fiber (%)	0.71	0.72	0.03	0.872
Ether extract (%)	4.3	4.01	0.07	0.023
Ash (%)	1.15	0.99	0.06	0.217
Nitrogen free extract (%)	72.42	72.38	0.38	0.959
Cooking loss (%)	30.51	32.69	0.77	0.18
Dripped loss (%)	4.15	4.26	0.07	0.549
Rib eye area (%)	5.05	6.15	0.27	0.012

SEM=Standard error of means; TMRP-diet, total mixed ration pellet; TMRPPL-diet, total mixed ration pellet plus 5% plantain (*Plantago lanceolata*) herb.

### Conclusion

Under present experimental condition, it could be concluded that supplementation of plantain (*Plantago lanceolata* L.) to TMR pellet might be practiced to produce lean meat, and to improve production performance of Bangladeshi Garole sheep.

### Acknowledgement

The authors are grateful to Ministry of Science and Technology, Bangladesh for funding (No. BS306).

## References

- Aberle E.D., Forrest J.C., Gerrard D.E., Mills E.W. (2001). Principles of Meat Science vol 4. 3<sup>rd</sup> edn. Kendall/Hunt Publishing Company, USA.
- Allain C.C., Poon L.S., Chan C.S., Richmond W., Fu P.C. (1974). Enzymatic determination of total serum cholesterol, *Clinical Chemistry*, 20, 470-475.
- Al-Mamun M., Yamaki K., Masumizu T., Nakai Y., Saito K., Sano H., Tamura Y. (2007a). Superoxide anion radical scavenging activities of herbs and pastures in northern Japan determined using electron spin resonance spectrometry, *International Journal of Biological Sciences*, 3(6), 349-354.
- Al-Mamun M., Ito C., Sato A., Fujita T., Sano H. (2007b). Phenylalanine model with the leucine method to determine whole body protein synthesis and degradation in sheep fed at two levels, *Asian-Australasian Journal of Animal Science*, 20(10), 1517-1524.
- Al-Mamun M., Hanai Y., Tanaka C., Tamura Y., Sano H. (2008). Responses of whole body protein synthesis and degradation to plantain herb in sheep exposed to heat, *Archives of Animal Nutrition*, 62, 219-229.
- Al-Mamun, M., Abe D., Kofujita H., Tamura Y., Sano H. (2008). Comparison of the bioactive components of the ecotypes and cultivars of plantain (*Plantago lanceolata* L.) herbs, *Journal of Animal Science*, 79, 83–88.
- Al-Mamun M., Shibuya K., Kajita M., Tamura Y., Sano H. (2017). Responses of plasma glucose metabolism to exogenous insulin infusion in sheep-fed forage herb plantain and exposed to heat. *Animal*, 11(8), 1287-1294.
- Association of Official Analytical Chemists (AOAC). (1995). Official Methods of Analysis, 16th edn. AOAC, Arlington, VA.
- Buccolo G., David H. (1973). Quantitative determination of serum triglycerides by the use of enzymes. *Clinical Chemistry*, 19, 476-482.
- Castanon, J.I.R. (2007). History of the use of antibiotic as growth promoters in European poultry feeds. *Poultry Science* 86:2466–2471.
- Friedewald W.T., Levy R.I., Fredrickson D.S. (1972). Estimation of the concentration of low-density lipoprotein cholesterol in plasma, without use of the preparative ultracentrifuge, *Clinical Chemistry*, 18 (6), 499-502.
- Fulkerson W., Horadagoda A., Neal J., Barchia I., Nandra K. (2008). Nutritive value of forage species grown in the warm temperate climate of Australia for dairy cows: herbs and grain crops, *Livestock Science*, 114(1), 75-83.
- Huggett A.S., Nixon D.A. (1957). Use of glucose oxidase, peroxidase, and O-dianisidine in determination of blood and urinary glucose. *Lancet* 273(6991):368–370
- Ishiguro K., Yamada M., Takagi S. (1982). Studies on the Iridoid related compounds. 1. On the antimicrobial activity of aucubigenin and certain iridoid aglycones. *Yakugaku zasshi* 102: 755–759.
- Keilin D., Hartree E.F. (1948). Properties of glucose oxidase (notatin): Addendum. Sedimentation and diffusion of glucose oxidase (notatin), *Biochemical Journal*, 42(2), 221–229.
- Kemp PD, Kenyon PR, Morris ST (2010). The use of legume and herb forage species to create high performance pastures for sheep and cattle grazing systems. *Sociedade Brasileira de Zootecnia* 39, 169-174.
- Launert E. (1984). *The Country Life Guide to Edible and Medicinal plants of Britain and Northern Europe*, Country Life Books, England:
- Livestock Sector Brief, Bangladesh. FAO. 2005.

- Rumball W., Keogh R., Lane G., Miller J., Claydon R. (1997). Grasslands Lancelot' plantain (*Plantago lanceolata* L.), New Zealand Journal of Agricultural Research, 40, 373-378.
- Sano H., Matsunobu S., Abe T., Terashima Y. (1998). Combined effects of diet and cold exposure on insulin responsiveness to glucose and tissue responsiveness to insulin in sheep, Journal of Animal Science, 11, 3514-3520.
- Sano H., Tamura Y., Shiga A. (2002). Metabolism and glucose kinetics in sheep fed plantain and orchardgrass and exposed to heat. N.Z. J. Agric. Res. 45:171-177.
- Yoshida T., Rikimaru K., Sakai M., Nishibe S., Fujikawa T., Tamura Y. (2013). *Plantago lanceolata* L. leaves prevent obesity in C57BL/6 J mice fed a high-fat diet, Natural Product Research, 27(11), 982-987.
- Zhou Y.C., Zheng R.L. (1991). Phenolic compounds and an analog as superoxide anion scavengers and antioxidants, Biochemical pharmacology, 42, 1177-1180.

## HISTOLOGY STUDES OF THE OVARIES OF DUBSKA PRAMENKA DURING GRAVIDITY

Amela KATICA<sup>1</sup>, Nadžida MLAČO<sup>1</sup>, Kenan PODŽO<sup>2</sup>, Jasmin KATICA<sup>3</sup>, Naida ČUSTO<sup>4</sup>, Selma PILIĆ<sup>5</sup>

<sup>1</sup>Veterinary Faculty, University of Sarajevo, Department of Histology and Embriology, Zmaja od Bosne 90, 71000 Sarajevo, Bosnia and Herzegovina.

<sup>2</sup> Veterinary Faculty, University of Sarajevo, Department for Animal Husbandry, Zmaja od Bosne 90, 71000 Sarajevo, Bosnia and Herzegovina.

<sup>3</sup> Veterinary Faculty, University of Sarajevo, Institution for Zoohygiene, Zmaja od Bosne 90, 71000 Sarajevo, Bosnia and Herzegovina.

<sup>4</sup>Faculty of Pharmacy, University of Sarajevo, Zmaja od Bosne 8, 71000 Sarajevo, Bosnia and Herzegovina.

<sup>5</sup>Faculty of Natural Sciences and Mathematics, University of Sarajevo, Zmaja od Bosne 33-35, 71000 Sarajevo, Bosnia and Herzegovina

\*Corresponding author: amela.katica@yahoo.com

### Abstract

In the histological analysis of the ovaries of Dubska pramenka during the gravidity weeks 3, 7, and 16, we tried to establish the intensity of folliculogenesis and highlight their importance in the course of gravidity. Considering that there has been little research on the ovaries of Dubska pramenka during gravidity, and that their unquestionable role in neuroendocrine system has a significant influence on the outcome of gravidity, we analysed the germ-germinal epithelium during different periods of gravidity, and we focused special attention to the representation of various follicular development stages in the cortex of gravid ovaries and blood supply of the medulla. The analyses showed that histology of the ovaries of Dubska pramenka varied considerably, especially in terms of the height of the cells constituting the germ-germinal epithelium, the presence of different forms of the follicles that exist at different stages of gravidity, while the blood supply of the medulla and the presence of connective tissue elements also varied, especially the morph of the connective tissues and their density.

**Key words:** *Dubska pramenka, gravidity, ovaries*

### Introduction

Considering that sheep are seasonally polyestrous animals, i.e. with more investments in the production cycle, oestrus can occur at any time throughout a year, hence they can be impregnated regardless of the period of the year. However, Dubska pramenka in a free-nomadic breeding in Bosnia and Herzegovina, mountain Vlasic, regardless of being polyestrous, mates mainly in autumn, and lambing occurs during early spring months. Autumn period, which is characterised by shorter days and longer nights, is favourable to the activity of the pituitary gland. Hence, decreased daylight stimulates more pituitary activity, and the hypothalamus produces releasing hormones that stimulate the pituitary gland through the portal blood flow and nerve tissues to secrete more gonadotropin that will further stimulate the gonads to instigate folliculogenesis and onset of oestrus, *Nett (1987)*. As we focused our research on the ovaries at different stages of gravidity, we observed the size of the germinal epithelium, the occurrence of different stages of follicular development and the presence of yellow bodies. It is a known fact that following the ovulation of a mature Graaf follicle and under the influence of LH hormone, granulosa cells in the wall of a ruptured



follicle proliferate and transform into lutein cells that fill the cavity of the follicle in the next 5 (five) days. The yellow body is being created and it starts to secrete progesterone – the keeper of gravidity. However, after ovulation the ovary still continues with folliculogenesis even during gravidity, because the histological analyses of the ovaries in gravid ewes indicate the presence of almost all forms of follicular development. Although, independently of estrogen secreted by the mature De Graaf follicle, hormone inhibin, which selectively inhibits the FSH hormone of the pituitary gland, also contributes to the maturation of the follicles. By limiting the secretion of the pituitary FSH hormone, inhibin should prevent the further follicular development and limit the degree of ovulation.

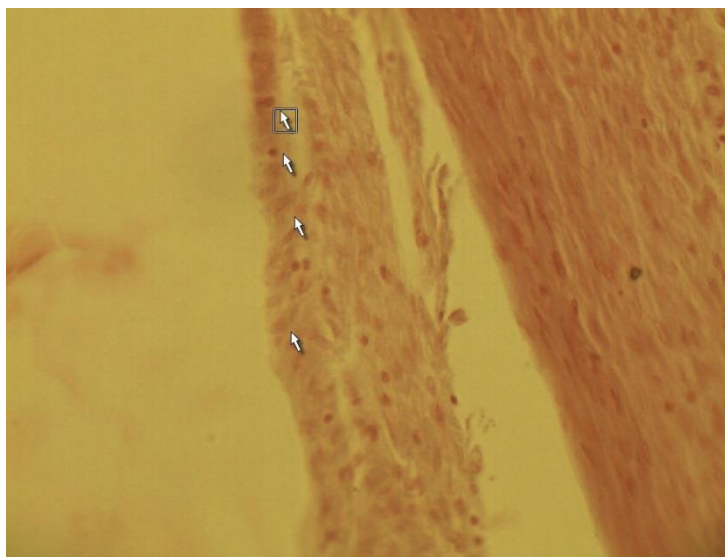
### **Materials and methods**

The research material was collected on the mountain Vlasic during autumn and winter months. The research animals, total of 6 ewes, were euthanized due to various etiology (bone fractures, indigestion, wild animal attacks...). The degree of gravidity was established based on a controlled pairing and breeder's evidence, and based on the development of a foetus following the post-mortem examination. The research animals were in the gravidity weeks three, seven and sixteen. All histological examination have been conducted at the Veterinary Faculty University of Sarajevo, Departement of Histology and embriology. In this research we used comon histological method of making histological slides for light microscopy analysis.. The ovaries and their surrounding tissue were placed in plastic bottles with screw caps, in 10% formalin until the time of transport to the laboratory and the making of histological preparations, i.e. until the moment of their moulding in paraffin blocks. Moulding in paraffin blocks was done in a way that the samples of the ovaries were placed in 70% alcohol for two days, then in 96% alcohol for one day and in the end, in 100% alcohol for one day. From this procedure, the samples were transferred to a solution of 100 % alcohol and toluol for two hours and then to toluol for four hours. The prepared samples were left in paraffin I for five hours and in paraffin II for twelve hours, and the moulding procedure in paraffin blocks was completed. The paraffin blocks with moulded samples of the ovaries were cut by digital microtome in several serial incisions of 0.5 to 1.5 micron depth. The incisions were placed on glass slides, stained with haematoxylin eosin and azan, covered with cover glass, and glued with Canada balsam. Histological examinations were done using light microscope under magnification of 100, 200 and 400 times. Microscopic examination included the entire preparations of the ovaries, in order to get a complete picture of the organs examined during the research period. The hormonal measures we did not analysis because of *post mortem* changes on the blood. The assay results were presented using descriptive interpretation of the histological preparations, taking into account that comparative description of the histological preparations is representative of our research.

### **Results and discussion**

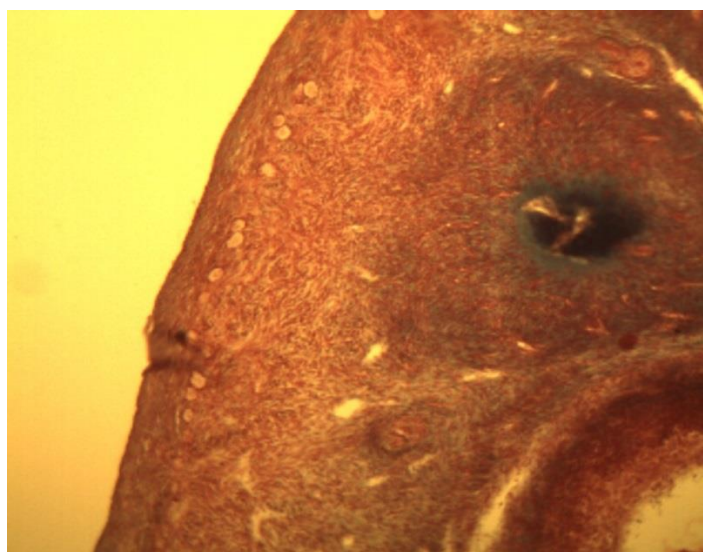
To provide an answer to this important question, which is what causes interruption of the ovulation during seasonal anoestrus in sheep, i.e. during gravidity, taking care that folliculogenesis occurs continually throughout the year, requires a complete understanding of the hormonal picture and mechanisms continually involved in the control of the ovary activity, *Karsch et al. (1983)*. Ovaries in cows, sheep and goats are of oval shape, with a size of a smaller or larger plum. Depending on the stage of the oestrus cycle, there are several antral follicles, follicle(s) preceding the ovulation, hemorrhagic bodies and yellow bodies on the ovaries. In cows, there is usually one preovulatory follicle, or one hemorrhagic, i.e. yellow body, because a cow is monovulatory animal species. In sheep and goats, there can be more of these ovarian structures, depending on the number of ovulations in specific oestrus.

Yellow body in cows, sheep and goats is yellow-brownish, *Stančić et al. (2014)*. Ovaries in mammals, and in sheep are pair organs, with germ or germinal epithelium on their surface. Germinal epithelium is particularly active during foetal period, and it can be active during sexual activity to create follicular cells as well as oogonia, *Katica et al. (2010)*. *Mutevelić et al. (2003)*, emphasize that the height of the germinal epithelium may vary depending on the type of animal; it can vary in the same animal as well, which will depend on the stage of the sexual cycle, way of keeping, diet, climate conditions. Histological assays of the germ epithelium in the course of gravidity week 3 established that it was made of a continual series of high prismatic, densely compressed cells (Image 1. Epithelium of the sheep in the gravidity week 3; haematoxylin eosin; x 400).

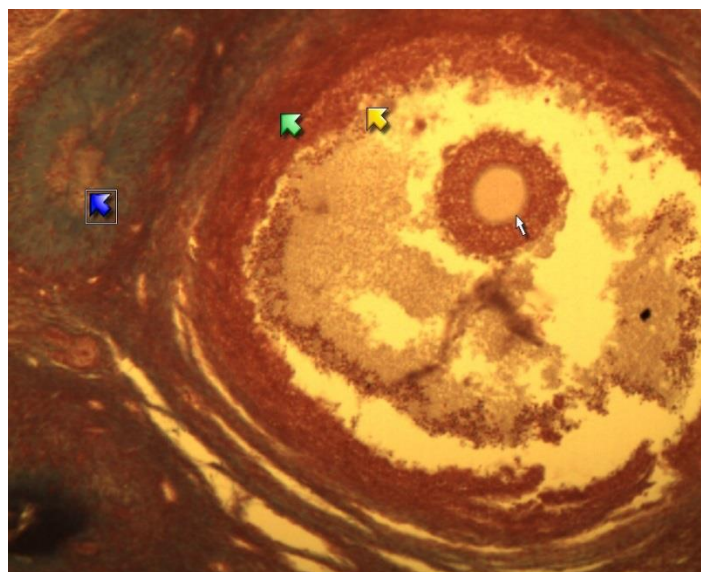


**Image 1. Epithelium of the sheep in the gravidity week 3; HxE x 400**

Under the germinal epithelium, we observed a dense network of parallel collagen tissues and clearly visible primordial follicles with egg cells in the centre, and one layer of laminated follicular cells. These follicles were arranged almost in a regular line under Tunica albuginea (Image 2. The crust of the ovary of the sheep in the gravidity week 3; haematoxylin eosin; x200).



**Image 2. The crust of the ovary of the sheep in the gravidity week 3; HxE x 200**

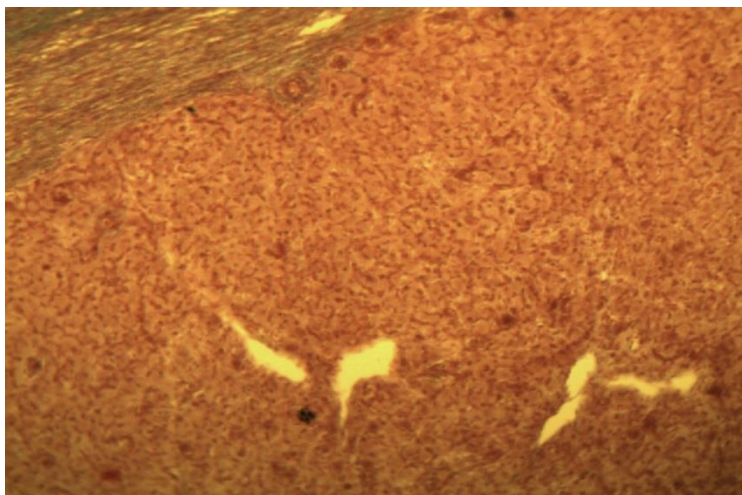


**Image 3. Arrows indicate a mature De Graaf follicle, atretic follicle in the gravidity week 3; Azan x 200**

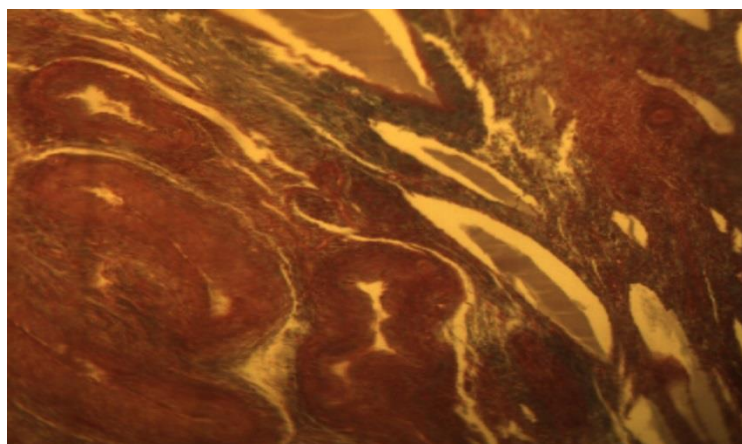
The crust of the ovary in the gravidity week 3 is rich in mature, tertiary follicles surrounded by connective tissue. We observe a looseness of stroma and collagen tissues, preparing the follicle for ovulation under the influence of hormone relaxin produced by the follicle cells, and a large number of atretic follicles that are being formed or have already been formed (Image 3. Arrows indicate a mature De Graaf follicle, atretic follicle in the gravidity week 3; azan x200). The tertiary follicles clearly show *Theca folliculi*, which subsequently differentiate in two layers - internal *Theca folliculi interna* and external *Theca folliculi externa*. Yellow body, which will secrete steroid hormone progesterone during gravidity, is formed of the internal layer made of polygonal cells, *Mohammadpour (2007)*.

On the histological preparations in the gravidity week 3, we also observed several yellow bodies of different size, with theca lutein cells located peripherally, darkly coloured, with flat nuclei and granulosa lutein cells located centrally, quite large, lighter and with clearly noticeable ball-like nuclei (Image 4. Yellow body in the gravidity week 3; haematoxylin eosin; x 200).

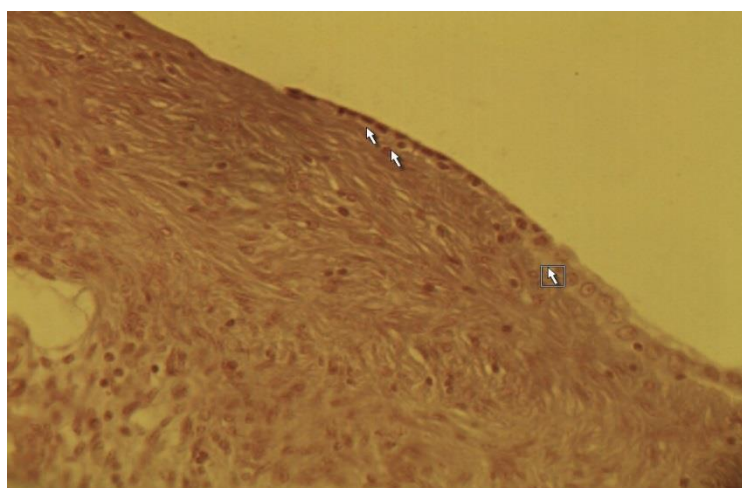
Microscopic examinations of the crust of the ovary in the gravidity week 3 did not show any large number of primary and secondary follicles. The core of the ovary in the gravidity week 3 was rich in blood vessels, with quite thick walls, irregular lumen, with the presence of connective tissue elements (Image 5. The core of the ovary in the gravidity week 3; azan x 200).



**Image 4. Yellow body in the gravidity week 3; HxE x 200**



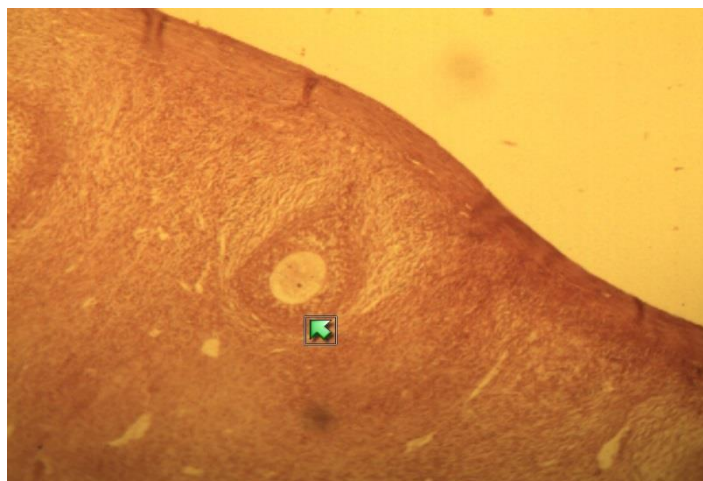
**Image 5. The core of the ovary in the gravidity week 3; Azan x 200**



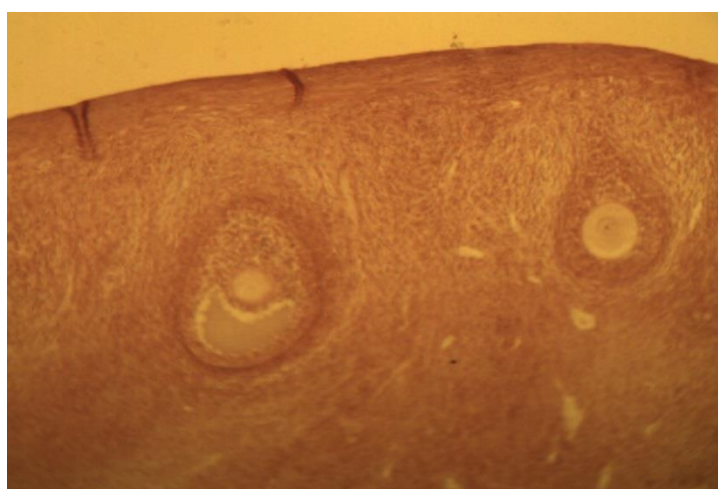
**Image 6. Epithelium in the gravidity week 7; HxE x 400**

The germinal epithelium in the gravidity week 7 varied in the height of the cells, from low to high prismatic cells, with clear oval nuclei, lightly coloured (Image 6. Epithelium in the gravidity week 7; haematoxylin eosin; x 400). At that particular time of gravidity, tunica albuginea is built of shorter, densely compressed collagen and elastic tissues laid parallel.

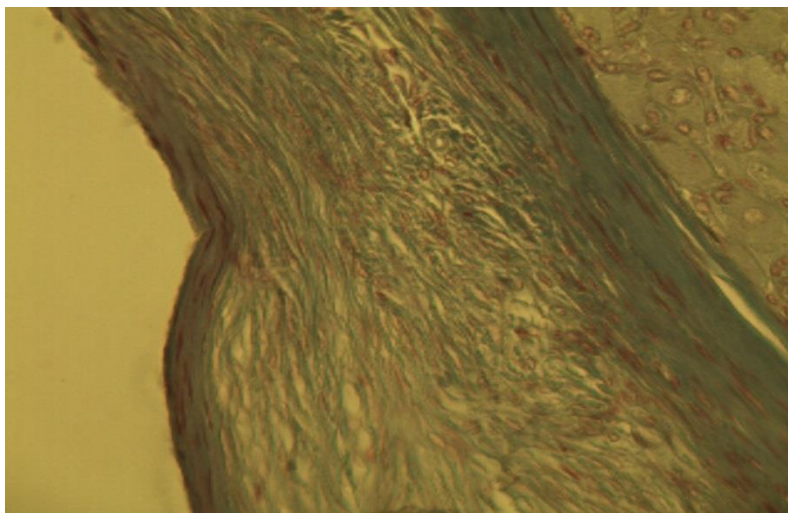
Gravidity week 7 is characterised by the presence of a larger number of secondary follicles, which are either at the stage of being formed or at the stage of transition (Image 7. The crust of the ovary with visible secondary follicles in the gravidity week 7; haematoxylin eosin x 200), (granulosa cells moving apart) and formation of the follicular antrum, i.e. the beginning of the formation of tertiary follicles (Image 8. The crust of the ovary in the gravidity week 7; haematoxylin eosin x 200). Such follicles were the most numerous in week 7. The presence of primordial and primary follicles is scarce. The core is permeated with connective tissues and rich in intersections of blood vessels with thinner irregular walls.



**Image 7. The crust of the ovary with visible secondary follicle in the gravidity week 7; HxE x 200**



**Image 8. The crust of the ovary in the gravidity week 7; HxE x 200**

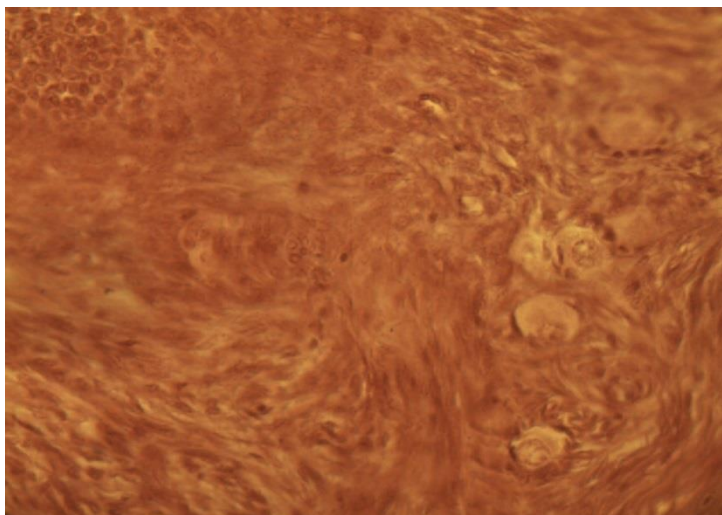


**Image 9. Epithelium of the ovary of the sheep in the gravidity week 16; Azan x 400**

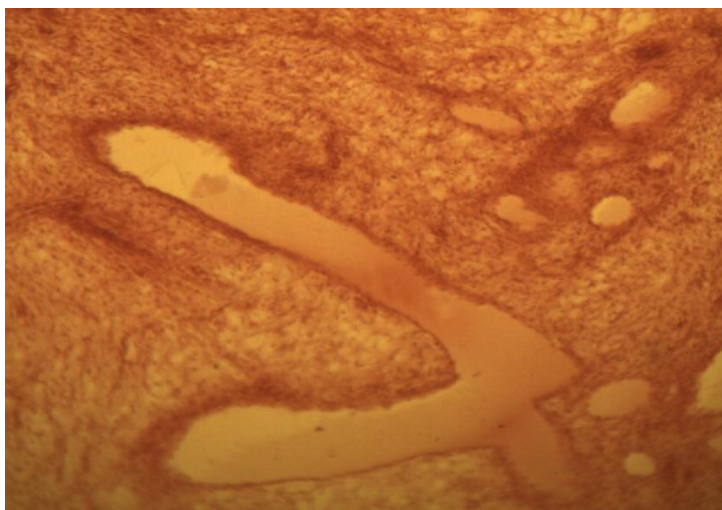
Already in the gravidity week 16, the germinal epithelium makes a series of laminated cells leaning one on another. Underneath, there are noticeable elastic and collagen tissues aiming in one direction, with *prominent density* (Image 9. Epithelium of the ovary of the sheep in the gravidity week 16; azan x 400). The crust of the ovary is rich in primordial follicles of smaller dimensions, with an egg cell and a layer of laminated follicular cells (Image 10. Primordial follicles in the crust of the gravid sheep in the week 16; haematoxylin eosin x400). It is striking at this degree of gravidity that there are visible just ovulated tertiary follicles of quite large dimensions, and that there are yellow bodies at the stage of being formed (Image 12. Ovulated De Graaf follicle of the ovary of the sheep in the gravidity week 16; haematoxylin eosin x 200). It is interesting to highlight that during this research period we did not observe any significant presence of any other forms of follicular development, primary or secondary follicles.

The ovaries in week 16 are characterised by the presence of a larger number of yellow bodies, of various dimensions, however, one is dominant; it has a distinct histological structure and is moved to the very edge of the germ epithelium (Image 13. Yellow body of the ovary of the sheep in the gravidity week 16; azan x 400). Following the ovulation, granulosa cells of mature follicles proliferate and hypertrophy and transform into granulosa lutein cells. Similar also occurs with the cells of theca interna, *Z. Kozarić, (1997)*. Yellow-brownish lutein accumulates in granulosa cells *Stančić, (2014)* and corpus luteum is being created. Lutein cells are round and polygonal, with a noticeable nucleus; during gravidity they secrete progesterone *Keeton, W.T.,J.L.Gould,(1986)*. Peripherally, there are theca lutein cells, which are smaller, darkly coloured and with flat nuclei.

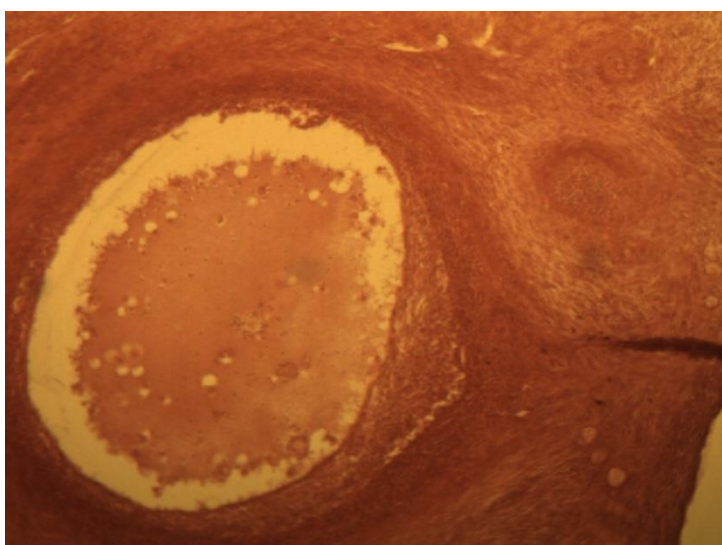
Medulla is well supplied with blood elements; there are numerous blood and lymph vessels and there is also an extremely rich in connective tissue, so called Zona vasculosa, where there are also hilus cells, homologous Leyding cells in males' testicles, *Eurel et al. (2006)*.



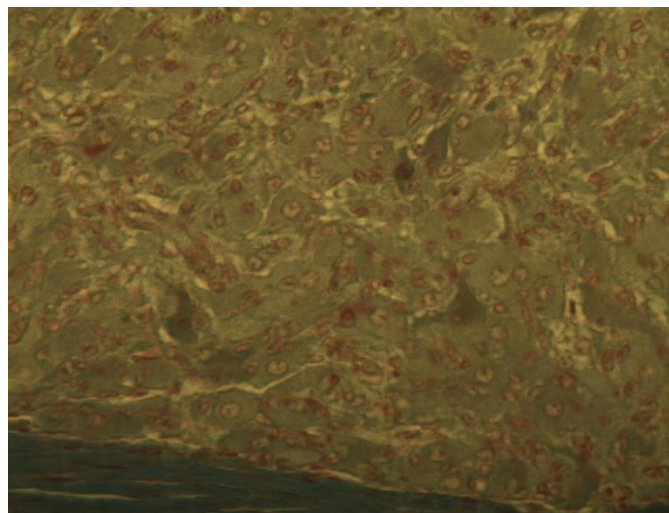
**Image 10. Primordial follicles in the crust of the gravid sheep in the week 16; HxE x 400**



**Image 11. The core of the ovary of gravid sheep in the week 16; HxE x 200**



**Image 12. Ovulated De Graaf follicle of the sheep in the gravidity week 16; HxE x 200**



**Image 13. A yellow body of the ovary in gravid sheep in the week 16; Azan x 400**

### **Conclusions**

Folliculogenesis in sheep occurs in the reproductive chain throughout the year, but the intensity and dynamics of the follicular development vary according to the periods of the year and physiological condition. The height of the germinal epithelium varies, from laminated to highly prismatic. All forms of follicular development are present in the gravidity weeks 3, 7 and 16; in week 3 - less primary and secondary follicles; in week 7 - larger number of secondary follicles, and in week 16 - ovulated tertiary follicles and formed yellow bodies. The core of the ovary is rich in initiated blood vessels, of thicker Tunica media.

### **References**

- DELLMAN, BROWN(1976): Textbook of Veterinary Histology  
EURELL JA, FRAPPIER BL., DELLMANN HD.(2006): Textbook of Veterinary Histology, Sixth ed., Blackwell Publishing Ltd, Ames, Iowa, USA  
JO ANN EURELL, BRIAN L. FRAPPIER (2006): Dellmann's Textbook of Veterinary Histology, Sixth Edition  
KARSCH FJ, FOSTER DL, BITTMAN EL, GOODMAN RR (1983): A role for estradiol in enhancing hormone pulse frequency during the follicular phase of the estrous cycle of the sheep. *Endocrinology*, 113: 1333-1339  
KATICA A., MLAĆO N., HASANBAŠIĆ D., HAMZIĆ E.(2010):Osnove veterinarske histologije, Sarajevo  
KEETON,W.T., J.L.GOULD (1986): Biological Science.W.W.Norton and Comp. New York  
KOZARIĆ Z (1997): Veterinarska Histologija, Naklada Karolina, Zagreb  
LUIZ CARLOS JUNQUEIRA, JOSÉ CARNEIRO(2005): Osnovi Histologije, tekst i atlas, SP PRINT, Novi Sad, Beograd  
MOHAMMADPOUR AA<sup>1</sup>(2007): Comparative histomorphological study of ovary and ovarian follicles in Iranian Lori-Bakhtiari sheep and native goat  
NETT TM (1987):: Function of the hypothalamic-hypophysial axis during postpartum period in ewes and cows, *J. Reprod. Fert.*, 34:201-213 *PakJBiol.Sci* Feb 15;10(4):673-5.  
STANČIĆ I. (2014): Reprodukcijska domaćih životinja, Univerzitet u Novom Sadu, Poljoprivredni fakultet



## RESULTS OF INCUBATION AND QUALITY OF DAY-OLD CHICKS HATCHED FROM EGGS OF DIFFERENT WEIGHT

Marinko VEKIĆ<sup>1\*</sup>, Stoja JOTANOVIĆ<sup>1</sup>, Đorđe SAVIĆ<sup>1</sup>, Mirjana MITRAKOVIĆ<sup>2</sup>

<sup>1</sup>University of Banja Luka, Faculty of Agriculture, Department of Animal Sciences, University City, Bulevar vojvode Petra Bojovica 1A, 78000 Banja Luka, Bosnia and Herzegovina

<sup>2</sup>INSTA, Srbac, Bosnia and Herzegovina

\*Corresponding author: marinko.vekick@agro.unibl.org

### Abstract

The paper presents the results of incubation and the quality of day-old chicks hatched from eggs of different weight. Total of 450 broiler breeder eggs was divided into 3 equal groups of 150 eggs, according to their weight (S group, 50.0±2.5 g; M group, 55.0 ± 2.5 g; L group 65.0 ± 2.5 g). Following parameters were measured: egg weight loss after 18 days of incubation (%); fertility of eggs (%); hatchability of incubated and fertilized eggs (%); total, early and late embryonic mortality (%); weight (g), length (cm) and yield of day-old chicks (%). Descriptive statistics method was used for data processing, and differences between the groups were tested by using of analysis of variance. The average weight of the eggs in groups of S, L and M was 55.02; 59.66 and 64.98 g, respectively, and significantly differed between groups ( $p < 0.01$ ). Average egg weight loss was 10.56; 10.25 and 10.22%, and without significant difference between groups. Hatchability of fertilized eggs was 93.8; 93.1 and 93.2%, respectively, and hatchability of all eggs was 91.3; 90.0 and 92.0%, respectively. Total embryo mortality in groups S, M and L was 6.2; 6.9 and 6.8%, respectively, with 4.1; 2.8 and 4.1% of early and 2.1, 4.1 and 2.7% of late mortality. Hatchability and embryonic mortality were not significantly influenced by eggs weight. The average weight of day-old chicks in S, M and L group was 37.80; 41.02 and 44.65 g, respectively, and the length of chicken was 17.68; 18.01 and 18.06 cm, respectively. The weight and length of chickens were significantly influenced by eggs weight ( $p < 0.01$ ). On the basis of these data it can be concluded that all analyzed groups had satisfactory results of incubation, as well as the weight and length of day-old chicks were significantly influenced by eggs' weight.

**Keywords:** *egg weight, incubation results, day-old chick quality.*

### Introduction

Hatchability and day-old chick quality are main production parameters of hatchery, primarily used as proficiency indicator of hatchery management, but also as indicator of management at broiler breeder farm (Decuyper *et al.*, 2007; Tullet, 2009; Bergoug *et al.*, 2013). Day-old chicks of good quality are starting point for achievement of high productivity standards in broiler meat production (Willemsen *et al.*, 2008). Relationship between hatchability or quality of day-old chicken and weight of hatching eggs was subject of many studies, and obtained results showed presence of strong relationships. Iqbal *et al.* (2016) demonstrated influence of egg weight on fertility, but Ramaphala and Mbajiorgu (2013) and Ulmer-Franco *et al.* (2010) did not confirmed these findings. Hatchability of all and fertilized eggs in study of Iqbal *et al.* (2016) and DeWitt *et al.* (2004) was influenced by egg weight, while it was not confirmed in studies of Gahri *et al.* (2015) and Ramaphala and Mbajiorgu (2013). Egg weight loss, according to Iqbal *et al.* (2016) and Kumpula (2004), depends on egg weight. Increased total embryonic mortality in larger eggs was revealed in several studies (Ramaphala and

Mbajjorgu, 2013; Terčič and Smerdu, 2014; Iqbal *et al.*, 2016). Increased late mortality in large eggs was observed by Ulmer-Franco *et al.* (2010) and Gahri *et al.*, (2015), but Jaiswal *et al.* (2016) observed it in smaller eggs. Day-old chick quality can be estimated by using different methods, including measuring of chick weight and length (İpek and Sözcü, 2013). Influence of egg weight on chick weight and length was confirmed by numerous authors (Kumpula, 2004; Ramaphala and Mbajjorgu, 2013; Iqbal *et al.*, 2016). Chick length, according to Mukhtar *et al.* (2013), is the best indicator of pre-incubation and incubation conditions. Willemsen *et al.* (2008) found that day-old chick weight is the second indicator of fattening performances after seven day old chick weight, while day-old chick length had low predictive value.

The objective of this study was to investigate hatchability and selected quality parameters of day-old chicken hatched from eggs with different weights.

### Materials and Methods

Total of 450 broiler hatching eggs, originated from 34 week old broiler parent flock Cobb 500 exploited in 2015 in commercial farm in north part of Republic of Srpska, was used in this study. All egg was laid on the same day, and after arrival in storage room of hatchery were individually marked and distributed in one of three groups according to weight: small - S ( $55 \pm 2.5$  g), medium - M ( $60 \pm 2.5$  g) or large - L ( $65 \pm 2.5$  g). Eggs were stored four days at adequate conditions (air temperature  $19 \pm 1^\circ\text{C}$ , relative humidity  $60 \pm 5\%$ ) prior incubation. Disinfection, pre-warming and incubation of eggs were identical for all groups. Egg weight was individually measured by technical scale (0.01 g) before incubation and at transferring eggs from setter to hatcher (day 18 of incubation). Egg weight loss was calculated according equations given by Tullet (2009). Analysis of all non-hatched eggs was performed after incubation in order to determine number of fertilized and unfertilized eggs and number of hatched chicken. These data was used for calculation of egg fertility, hatchability of all and fertilized eggs, according to equations given by Hesna Sahin *et al.* (2009). Number of embryos died in the first, second and third week of incubation was used for calculation of total, early, middle, and late embryonic mortality according to equations given by Alasahan and Copur (2016). Measurement of chick length, determined as length from tip of beak to root of middle nail of right foot, was performed according to Willemsen *et al.* (2008). Chick yield was calculated based on day-old chick weight and fresh egg weight according to equation given by Tullet (2009). Statistical analysis of obtained data was performed by ANOVA and mean differences were tested by Tukey test at significance level  $p < 0.05$ .

### Results and Discussion

Results of egg weight loss are showed in table 1.

Table 1. Egg weight loss (mean  $\pm$  SE) after 18 days of incubation

Egg weight group	Fresh egg weight (g)	Egg weight after 18 days of incubation (g)	Egg weight loss	
			(g)	(%)
S	$55.02 \pm 0.11^c$	$49.21 \pm 0.11^c$	$5.81 \pm 0.08^c$	$10.56 \pm 0.15$
M	$59.66 \pm 0.11^b$	$53.55 \pm 0.12^b$	$6.12 \pm 0.07^b$	$10.25 \pm 0.11$
L	$64.98 \pm 0.17^a$	$58.34 \pm 0.18^a$	$6.64 \pm 0.10^a$	$10.22 \pm 0.15$

<sup>abc</sup> – Values indicated with different superscript in the same column are statistically different ( $p < 0.01$ )

Egg weight loss was significantly ( $p < 0.01$ ) different among groups, and the highest egg loss was in group L (6.64 g), and the lowest in group S (5.81 g). This parameter, expressed as relative value, was not significantly different ( $p > 0.05$ ) among groups, but the highest egg loss was recorded in group S (10.56%), and the lowest in group L (10.22%). Optimal egg weight loss is 11.5% (Tullet, 2009), but its value depends on egg surface to volume ratio (Ulmer-Franco *et al.*, 2010). According to results of Iqbal *et al.* (2016) weight loss of Hubbard Classic strain eggs in three weight groups (60.05; 65.03 and 70.03 g in average, respectively) was lower ( $p < 0.05$ ) in large eggs (10.62%) compared with medium (11.12%) and small eggs (11.32%). Egg weight loss of Ross 308 eggs, according to Gahri *et al.* (2015), was lower (11.63%) in large (52.6-55.7 g) compared with egg loss (12.56%) of small eggs (52.6-55.7 g). Also, lower weight loss (11.24%) in large Anak broiler eggs (in average 60 g) has obtained by Abiola *et al.* (2008). Jaiswal *et al.* (2016) divided CARI-BRO Vishal broiler eggs in three weight groups (small <49; medium 50-59 and large 60-69 g) and found higher ( $p < 0.05$ ) weight loss in small eggs (13.09%) in relation on medium (8.34%) and large eggs (10.0%).

Parameters of hatchability according to egg weights are showed in table 2.

Table 2. Apparent fertility and hatchability parameters of egg weight groups

Egg weight group	Apparent egg fertility (%)	Hatchability of fertile eggs (%)	Hatchability of total eggs (%)
S	97.3	93.8	91.3
M	96.7	93.1	90.0
L	98.7	93.2	92.0

Apparent fertility in groups S, M and L was 97.3; 96.7 and 98.7%, respectively; and was not statistically different ( $p > 0.05$ ). Gahri *et al.* (2015) also not conformed difference in fertility of Ross 308 eggs categorized as small (52.6-55.7 g), medium (57.2-60.2 g) and large (61.7-64.7 g), and the following values were determined: 91.5; 93.0 and 94.7%, respectively. Also, fertility of eggs categorized in three groups (small 53.0, medium 57.0 and large 61.0 g in average) in study of Kumpula (2004) was 94.0; 91.5 and 93.6%, respectively, and was not different ( $p > 0.05$ ). Contrary to this, in study of Iqbal *et al.* (2016), three Hubbard Classic eggs weight groups (60.05; 65.03 and 70.03 g in average, respectively) had different ( $p < 0.001$ ) fertility (96.67; 93.33 and 90.33%, respectively).

Hatchability of fertilized eggs in this study was 93.8; 93.1 and 93.2% in S, M i L groups, respectively, while hatchability of all eggs was 91.3; 90.0 and 92.0%, respectively. These values were not influenced by egg weight ( $p > 0.05$ ). Hatchability of all eggs in study of Gahri *et al.* (2015), grouped as small (52.6-55.7 g), medium (57.2-60.2 g) and large (61.7-64.7 g), was also not influenced by egg weight (83.3; 84.0 and 80.7%, respectively), as well as hatchability of fertilized eggs (83.7; 86.4 and 83.8%, respectively). Kumpula (2004) reported insignificant differences in values of hatchability of all (85.5; 82.3 and 82.2%) and fertilized eggs (91.0; 89.9 and 87.9%) in three weight groups (small: 53.0 g; medium: 57.0 and large: 61.0 g in average, respectively). Differences in hatchability of Cobb 500 eggs with different weight (<49; 50-59 and 60-69 g), used in study of Ramaphala and Mbajjorgu (2013), were insignificant (92.43; 90.89 and 90.92%, respectively). Iqbal *et al.* (2016) found that hatchability of all and fertilized eggs in three weight groups (60.05; 65.03 and 70.03 g in average) was different ( $p < 0.001$ ), and had following values: 89.67; 83.67 and 78.33%,

respectively and 92.74; 89.64 and 86.72%, respectively. Terčič and Smerdu (2014) reported lower ( $p<0.05$ ) hatchability (76.72%) in large eggs (>63 g), and highest hatchability (82.4%) in medium eggs (53-63 g). However, hatchability of large (60-69 g) Caribro Vishal broiler eggs (80.2%) was higher ( $p<0.05$ ) in relation on small (<49 g) and medium eggs (50-59 g) with 66.0% and 74.4%, respectively (Jaiswal *et al.*, 2016). Higher ( $p<0.05$ ) hatchability (96.7%) of medium eggs (50 g in average) compared with hatchability (82.8%) of large eggs (60 g in average) was found by Abiola *et al.* (2008).

Parameters of embryonic mortality of egg weight groups are showed in table 3.

Table 3. Parameters of embryonic mortality of egg weight groups

Egg weight group	Total embryonic mortality		Early embryonic mortality		Middle embryonic mortality		Late embryonic mortality	
	n	%	n	%	n	%	n	%
S	9	6.2	6	4.1	0	0	3	2.2
M	10	6.9	4	2.8	0	0	6	4.1
L	10	6.8	6	4.1	0	0	4	2.7

The highest total embryonic mortality was in group M (6.9%), followed by mortality in groups L (6.8%) and S (6.2%). Early embryonic mortality in groups S and L was 4.1%, and it was relatively higher from mortality in group M (2.8%). Late embryonic mortality in group M (4.1%) was relatively higher than mortality in groups L (2.7%) and S (2.2%). Middle embryonic mortality was not found in all groups. Values of all parameters of embryonic mortalities were not statistically different among groups ( $p>0.05$ ). According to Kumpula (2004) values of early and middle mortality were not different in eggs of two commercial broiler strain divided in three weight groups (small - 53.0, medium - 57.0 and large - 61.0 g in average), and had following values: 5.6; 5.0; 5.5%, respectively; and 0.5; 0.6; 0.1%, respectively. However, late mortality was higher ( $p<0.05$ ) in large (6.1%) compared with medium (4.3%) and small eggs (1.8%). Iqbal *et al.* (2016) found that early mortality in three egg weight groups (60.05; 65.03 and 70.03 g in average) was the lowest ( $p<0.01$ ) in small (2.0%) then in medium (2.8%) and large eggs (3.3%), while early (1.33) and late (1.67%) mortality of small eggs was lower ( $p<0.01$ ) then in large eggs (2.3 and 3.0%, respectively). Early mortality, according to Gahri *et al.* (2015), in three groups (small: 52.6-55.7; medium 57.2-60.2 and large 61.7-64.7 g) was 3.95; 2.96 and 4.68%, respectively, and was lower ( $p<0.05$ ) in medium eggs; middle mortality (0.67; 0.69 and 0.67%, respectively) was not different among groups ( $p>0.05$ ), but late mortality was higher ( $p<0.05$ ) in large (6.38%) then in small (2.85%) and medium eggs (3.63%). Terčič and Smerdu (2014), found higher ( $p<0.05$ ) total mortality (19.72%) in large eggs (>63 g), compared with 14.58% in medium (53-63 g) and 8.05% in small eggs (<53 g). However, Jaiswal *et al.* (2016) found higher ( $p<0.05$ ) total embryonic mortality (15.3%) in egg weighted less than 49 g compared with 10.56% of medium (50-59 g) and 6.13% of large eggs (60-69 g).

Parameters of day-old chick quality hatched from eggs with different weight are showed in table 4.

Table 4. Quality parameters of day-old chickens (mean  $\pm$  SE)

Egg weight group	Chick weight (g)	Chick length (cm)	Chick yield (%)
S	37.81 $\pm$ 0.16 <sup>a</sup>	17.68 $\pm$ 0.04 <sup>a</sup>	68.71 $\pm$ 0.12
M	41.02 $\pm$ 0.13 <sup>b</sup>	18.01 $\pm$ 0.05 <sup>b</sup>	68.75 $\pm$ 0.11
L	44.65 $\pm$ 0.19 <sup>c</sup>	18.06 $\pm$ 0.05 <sup>b</sup>	68.71 $\pm$ 0.14

<sup>abc</sup> – Values indicated with different superscript in the same column are statistically different ( $p < 0.01$ )

Average chick weight was significantly different among groups ( $p < 0.01$ ). It was the highest in group L (44.65 g), and followed by groups M (41.02 g) and S (37.81 g). Average chick length had similar trend, and it was higher ( $p < 0.05$ ) in groups L (18.06 cm) and M (18.01 cm) in comparison with group S (17.68 cm). Chick yield in groups S and L was equal (68.71%), while in group M was slightly higher (68.75%), and was not different ( $p > 0.05$ ). Influence of egg weight on chick weight was also confirmed by Ramaphala and Mbajorgu (2013), who incubated Cobb 500 eggs in three weight groups (<49; 50-59 and 60-69 g), and reported consequently different ( $p < 0.05$ ) day-old chick weights (42.33; 44.13 and 49.01 g, respectively). Terčič and Smerdu (2014) found different ( $p < 0.05$ ) values of chick weight (34.69; 40.16 and 45.15 g, respectively) hatched from three weight group eggs (<53; 53-63 and >63 g). Kumpula (2004) categorized eggs as small, medium and large (53.0, 61.0 and 67.0 g in average) and determined different ( $p < 0.05$ ) chick weights (36.9; 40.0 and 43.1 g, respectively). Iqbal *et al.* (2016) confirmed influence ( $p < 0.05$ ) of egg weight (three weight groups with 60.05; 65.03 and 70.03 g in average) on length of male (18.99; 19.60 and 19.72 cm, respectively) and female chicken (18.98; 19.37 and 19.55 cm, respectively). Kumpula (2004) found influence of egg weight on chick length, whereas chicken hatched from small, medium and large egg (53.0, 61.0 and 57.0 g, respectively) had different lengths (18.1; 18.0 and 18.4 cm, respectively). Optimal chick yield in stored eggs is 67.5% (Tullet, 2009). Iqbal *et al.* (2016) did not find influence of egg weight (three groups with 60.05; 65.03 and 70.03 g in average) on chick yield of male (68.59; 68.43 and 67.99%, respectively) and female chicken (66.48; 66.38 and 67.66%, respectively). Kumpula (2004) found difference ( $p < 0.05$ ) in chick yield among chicken hatched from different egg weight groups, so small, medium and large eggs (53.0; 61.0 and 57.0 in average, respectively) had following chick yields 70.4; 71.3 and 71.9%, respectively.

### Conclusion

On the obtained results in this study it can be concluded that hatching eggs in three studied weight categories had relatively similar results in view of fertility and hatchability. Chick weight and length was different among three egg weight groups, i.e. higher parameter values have chicken hatched from larger eggs, while chick yield was not different among analyzed egg weight groups.

### References

- Abiola S.S., Meshioye O.O., Oyerinde B.O., Bamgbose M.A. (2008). Effect of egg size on hatchability of broiler chicks. *Archivos de Zootecnia*, 57 (217): 83-86.
- Alasahan S, Copur, A.G. (2016). Hatching characteristics and growth performance of eggs with different egg shapes. *Revista Brasileira de Ciência Avícola*, 18 (1): 1-8.

- Bergoug H., Burel C., Guinebretiere M., Tong Q., Roulston N., Romanini C., Exadaktylos V., MCGonnell L., Demmers T., Verhelst R., Bahr C., Berckmans D., Etteradossi N. (2013). Effect of pre-incubation and incubation conditions on hatchability, hatch time and hatch window, and effect of post-hatch handling on chick quality at placement. *World's Poultry Science Journal*, 69 (2): 313-334.
- Decuypere E., Tona K., Bruggeman V., Bamelis F. (2007). The day-old chick: A crucial hinge between breeders and broilers. *Hatchery Expertise Online* 12, CEVA Animal Health Asia.
- DeWitt F., Schwalbach L.M.J. (2004). The effect of egg weight on the hatchability and growth performance of New Hampshire and Red Rhode Island chicks. *South African Journal of Animal Science*, 34 (Suppl. 2): 62-64.
- Gahri H., Najafi G., Deldar F. (2015). Effect of egg weight of broiler breeder on egg characteristics and hatchery performance. *International Journal of Biosciences*, 6 (5): 42-48.
- HesnaSahin E., Sengor E., Yardimci M., Cetingul I.S. (2009). Relationship between pre-incubation egg parameters from old breeder hens, egg hatchability and chick weight. *Journal of Animal and Veterinary Advances*, 8 (1): 115-119.
- İpek A., Sözcü A. (2013). Broiler chick quality and scoring methods. *U. Ü. ZiraatFakültesiDergisi*, 27 (2): 131-137.
- Iqbal J., Khan S.H., Mukhtar N., Ahmed T., Pasha R.A. (2016). Effects of egg size (weight) and age on hatching performance and chick quality of broiler breeder. *Journal of Applied Animal Research*, 44 (1): 54-64.
- Jaiswal S.K., Raza M., Dilliwar L., Chaturvedani A. (2016). Effect of egg weight on pre-hatch performance in broiler chickens. *International Journal of Science, Environment and Technology*, 5 (6): 4422-4426.
- Kumpula B.L. (2004). Comparing hatchability, incubation length and chick quality from three egg sizes from two modern broiler strains. *CHEPA Final Report*.
- Mukhtar N., Khan S.H., Anjum M.S. (2013). Hatchling length is a potential chick quality parameter in meat type chickens. *World's Poultry Science Journal*, 69 (4): 889-896.
- Ramaphala N.O., Mbajorgu C.A. (2013). Effect of egg weight on hatchability and chick hatch-weight of Cobb 500 broiler chickens. *Asian Journal of Animal and Veterinary Advances*, 8: 885-892.
- Terčič D., Smerdu T. (2014). Effect of storage period and egg weight on hatchability in Prelux-G chickens. *Acta Agriculturae Slovenica*, 104 (2): 69-74. (In Slovene)
- Tullet S. (2009): Investigating hatchery practice. *Ross Technology*.
- Ulmer-Franco A.M., Fasenko G.M., O'Dea Christopher E.E. (2010). Hatching egg characteristics, chick quality, and broiler performance at 2 breeder flock ages and from 3 egg weights. *Poultry Science*, 89 (12): 2735-2742.
- Willemsen H., Everaert N., Witters A., De Smit L., Debonne M., Verschuere F., Garain P., Berckmans D., Decuypere E., Bruggeman V. (2008). Critical assessment of chick quality measurements as an indicator of post hatch performance. *Poultry Science*, 87: 2358-2366.

## INCUBATION RESULTS OF BROILER HATCHING EGGS STORED IN DIFFERENT POSITIONS

Marinko VEKIĆ\*, Stoja JOTANOVIĆ, Đorđe SAVIĆ, Dragan RAKOVIĆ

University of Banja Luka, Faculty of Agriculture, Department of Animal Sciences,  
University City, Bulevar Vojvode Petra Bojovica 1A, 78000 Banja Luka, Bosnia and Herzegovina

\*Corresponding author: marinko.vekick@agro.unibl.org

### Abstract

The aim of the study was to investigate the influence of two storage lengths and three egg positions during storage on following incubation results of broiler hatching eggs: egg weight loss; hatchability of incubated and fertilized eggs; total, early, medium and late embryonic mortality. Study was performed in commercial hatchery in north part of Republic of Srpska during 2015. A total of 1050 eggs originated from 32 weeks old parent flock Cobb 500 were divided into six equal experimental groups, depending on the length (7 or 10 days) and the egg position during storage (normal - the large end up; horizontal - eggs in horizontal long axis; inverted - the large end down) and one control group (4 days of storage in normal position). Data processing was performed by using the analysis of variance with *post hoc* test at a significance level of  $p < 0.05$ . Hatchability of fertilized eggs, total and early embryonic mortality were significantly influenced by the length of storage ( $p < 0.05$ ). The influence of the egg position on examined parameters of incubation was not significant. Based on these results, it can be concluded that the length of egg storage has a significant influence on the hatchability, while the egg position in the examined storage periods had no influence on the parameters examined in this study.

**Keywords:** *hatching egg, storage length, egg position, incubation*

### Introduction

Storage of hatching eggs are almost necessary segment in production cycle of broiler day-old chicken, and it is used to synchronize capacity of hatcheries with egg production on breeder farm on the one, and demand for day-old chicken on market, on the other side. In commercial conditions of production hatching egg are stored at least two times, primarily at broiler breeder farm, and then at hatchery before incubation. Storage length significantly effects hatchability of broiler hatching eggs in field circumstances (Yassin *et al.*, 2008), therefore it is recommended to storage eggs maximally 3 or 4 days (Meijerhof, 1992). Hatching eggs should be stored in vertical position with blunt end up, and then incubated in the same position (Milošević and Perić, 2011). Deleterious influence of extended storage on hatchability and chick quality could be limited by different procedures, with aim to preserve embryo vitality and albumen quality, as crucial factors for achieving satisfactory incubation results (Reijrink *et al.*, 2008). Alternative egg storage positions, as method of hatchability preservation, were investigated by Proudfoot (1967), who determined that egg storage up to 14 days in inverted position had beneficial effect on hatchability, but that effect was deleterious when storage lasted more than 14 days. Tiwary and Maeda (2005) reported better hatchability of layer hatching eggs stored 14 and 21 days in inverted position compared with normal position, whereas hatchability of eggs stored 7 days was nearly equal in these two

positions. Beneficial effect of inverted egg position on hatchability compared to normal position was confirmed by Elibol and Brake (2008) after 14 days of storage of broiler hatching eggs, as well as Lima *et al.* (2012) and Schulte-Drüggelte (2011) after 14 and 20 days of storage of layer hatching eggs, respectively. Slightly different hatchability of White Rock breed eggs stored in different positions was reported by Oluyemi and George (1972), who found that eggs stored in inverted position had slightly better hatchability compared to eggs stored in horizontal and normal position. On the other side, incubation results of layer hatching eggs stored 5 days in inverted position were lower compared with those stored in normal position (Salahi *et al.*, 2012), primarily due to decreased hatchability and increased late embryonic mortality. According to Kgwatalala *et al.* (2015), Tswana breed eggs stored 10 and 15 days in horizontal position had higher hatchability compared with eggs stored in normal and inverted position, while hatchability of eggs stored up to 5 days was not related to storage positions.

The aim of this study was to investigate the effect of two storage length (7 or 10 days) and three egg position during storage (normal, horizontal or inverted) on incubation results of broiler hatching eggs (egg weight loss; hatchability of all eggs; hatchability of fertilized eggs; total, early, intermediate and late embryonic mortality).

### **Materials and Methods**

Total of 1050 broiler hatching eggs, laid by 33 week old broiler breeder flock Cobb 500 raised in 2015 on commercial farm located in the north part of Republic of Srpska, were used in study. All eggs were laid and collected on the same day, and transferred to hatchery, where eggs were individually marked, placed in carton boards and stored at adequately managed storage room conditions (air temperature  $19\pm 1^{\circ}\text{C}$ ; relative air humidity  $65\pm 5\%$ ) until incubation. Eggs were divided in seven equal groups, six experimental ( $n=150$  eggs each) according to two storage lengths (7 or 10 days) and three egg storage positions (normal egg position – the blunt end up, horizontal egg position – egg laid in horizontal long axis and inverted egg position – the blunt end down) and one control (4 days of storage in normal position). Conditions of fumigation, pre-warming and incubation of eggs followed standard technology in commercial hatchery, thus all groups in study had identical pre-incubation and incubation procedures. Egg weight was individually determined two times, before setting in incubator and at transferring eggs in hatcher (day 18<sup>th</sup> of incubation) by technical scale (0.01 g), and obtained data were used for calculation of egg weight loss according to equation given by Salahi *et al.* (2012). At the end of incubation all vital chicken were counted, and all non-hatched eggs were broken in order to determine number of unfertilized eggs and embryos died in the first (early), second (intermediate) and third week of incubation (late embryonic mortality). On the basis of this data the following parameters were calculated, according to equations given by Alasahan and Copur (2016): egg fertility, hatchability of all and fertilized eggs, total, early, intermediate and late embryonic mortality. Results are presented in tables, and statistical analysis of data was performed using ANOVA with Tukey *post hoc* tests at 5% significance level.

### **Results and Discussion**

Results of egg weight loss and hatchability of examined eggs are presented in table 1.



Table 1. Weight loss and hatchability parameters of eggs stored in three different positions

Egg storage (days)	4	7			10		
Egg position	Nor	Nor	Hor	Inv	Nor	Hor	Inv
Egg weight at set (g)	60,22	60.17	60.31	59.81	59.90	59.70	59.61
Egg weight loss (g)	6.48	6.85	6.84	6.85	6.39	6.31	6.45
Egg weight loss (%)	10.76	11.38	11.35	11.45	10.67	10.57	10.82
Apparent fertility (%)	97.3	98.0	98.0	98.0	98.0	97.3	98.0
Hatchability of fertile eggs (%)	93.8 <sup>a</sup>	96.6 <sup>a</sup>	90.5 <sup>a</sup>	93.2 <sup>a</sup>	83.7 <sup>b</sup>	87.7 <sup>b</sup>	85.0 <sup>b</sup>
Hatchability of set eggs (%)	91.3 <sup>a</sup>	94.7 <sup>a</sup>	88.7 <sup>a</sup>	91.3 <sup>a</sup>	82.0 <sup>b</sup>	85.3 <sup>b</sup>	83.3 <sup>b</sup>

Nor – normal; Hor – horizontal; Inv – inverted egg position

<sup>abc</sup> – means with different superscripts in the same row are significantly different ( $p < 0.05$ )

Average weight loss in normal, horizontal, and inverted position group after 7 day of storage was 6.85 g (11.38%); 6.84 g (11.35%) and 6.85 g (11.45%), respectively. After 10 days of storage average weight loss was 6.39 g (10.67%), 6.31 g (10.57%) and 6.45 g (10.82%), respectively. Egg weight loss, according to egg storage, was relatively higher after 7 days of storage. Salahi *et al.* (2012) didn't find difference in egg weight loss between eggs stored 4-5 days in normal (14.1%) or inverted position (13.4%), while Terčič and Pestotnik (2016) found difference ( $p < 0.05$ ) in weight loss of eggs stored in different intervals from 0 to 15 days in normal (11.03%) or inverted position (11.37%). Egg weight loss in interval between 6.5 and 14.0%, according to Molenaar *et al.* (2010), has no detrimental effect on hatchability, whose value depends on egg shell quality and pressure difference between egg and its surrounding.

Fertility of eggs stored for 7 days was 98.0% in all groups, while its value after 10 days of storage was 98.0% in normal and inverted group and 97.3% in horizontal group. Fertility, as complex trait, is influenced by numerous genetic and non-genetic factors, particularly by flock management, regarding nutrition, environmental conditions and cock: hen ratio, along with breeders age (King'ori, 2011).

Hatchability of fertilized eggs stored for 7 days was the highest in normal position group (96.6%), followed by inverted (93.2%) and horizontal group (90.5%), while storage for 10 days resulted in higher hatchability in horizontal group (87.7%) compared with inverted (85.0%) and normal position group (83.7%). Hatchability of all eggs in stored groups had the same pattern as hatchability of fertilized eggs in normal, horizontal and inverted position groups and was 94.7, 88.7 and 91.3% after 7 days, respectively, and 82.0, 85.3 and 83.3% after 10 days, respectively. Hatchability of all groups stored for 10 days was generally lower ( $p < 0.05$ ) compared with groups stored for 7 days and control group. Hatchability of groups stored in alternative positions had inconsistent respond, as hatchability was relatively lower in groups stored 7 days while it was relatively higher in groups stored 10 days. Elibol and Brake (2008) also found beneficial influence of inverted position on hatchability of fertilized broiler hatching eggs after 14 days of storage (57.8% vs. 49.4%), but also after only 3 day of storage (83.2% vs. 82.5%). Lima *et al.* (2012) reported higher hatchability of in inverted layer breeder eggs (92.3%) compared with normal position (90.3%) after 7 days of storage and confirmed their findings after 14 days of storage (81.54% vs. 67,7%). Relatively higher hatchability of eggs stored up to 15 days in inverted position compared with normal position was found by Terčič and Pestotnik (2016). Similar results were obtained by Tiwary and Maeda (2005), as hatchability of layer hatching eggs stored in inverted position (80.9%) for 7

days was higher compared with eggs stored in normal position (76.5%), and it was also confirmed after 14 days of storage (66.7% vs. 56.1%). Kgwatalala *et al.* (2015) found relatively higher hatchability of eggs stored 6-10 days in both inverted (67.5%) and horizontal position (60.0%) compared to eggs stored in normal position (45.0%), which was also conformed by hatchability of fertilized eggs (84.38; 83.22 and 62.14%, respectively). Contrary to this, Salahi *et al.* (2012) showed that hatchability of layer breeder eggs was lower when they were stored 4-5 days in inverted (67.6%) opposed to normal position (71.9%).

Embryonic mortality of eggs obtained in study is presented in table 2.

Table 2. Embryonic mortality of eggs stored in three different positions

Egg storage (days)	4	7			10		
Egg position	Nor	Nor	Hor	Inv	Nor	Hor	Inv
Total embryonic mortality (%)	6.1 <sup>b</sup>	3.4 <sup>b</sup>	9.5 <sup>b</sup>	6.8 <sup>b</sup>	16.3 <sup>a</sup>	12.3 <sup>a</sup>	15.0 <sup>a</sup>
Early embryonic mortality (%)	3.4 <sup>b</sup>	3.4 <sup>b</sup>	5.4 <sup>b</sup>	3.4 <sup>b</sup>	10.9 <sup>a</sup>	8.9 <sup>a</sup>	9.5 <sup>a</sup>
Intermediate embryonic mortality (%)	0.0	0.0	1.4	2.0	1.4	0.7	0.7
Late embryonic mortality (%)	2.7	0.0	2.7	1.4	4.1	2.7	4.8

Nor – normal; Hor – horizontal; Inv – inverted egg position.

<sup>abc</sup> – means with different superscripts in the same row are significantly different (p<0.05)

Total embryonic mortality after 7 days of storage was the highest in horizontal group (9.5%), and then in inverted group (6.8%) and normal (3.4%), whereas its value after 10 days of storage was the highest in normal group (16.3%), followed by inverted (15.0%) and horizontal group (12.3%). Early embryonic mortality after 7 days of storage was the highest in horizontal group (5.4%) and identical (3.4%) in normal and inverted position group. Increased values of this parameter were detected after storage of 10 days with higher values in normal group (10.9%) compared with inverted (9.5%) and horizontal group (8.9%). Intermediate embryonic mortality after 7 days of storage in normal position was not found, while in inverted and horizontal group was 2.0 and 1.4%, respectively. This parameter after 10 days of storage was 0.7% in horizontal and inverted groups, while in normal group was 1.4%. Late embryonic mortality after 7 days of storage was not found in eggs stored in normal position; in horizontal and inverted group was 2.7% and 1.4%, respectively. Inverted, normal and horizontal groups, regarding this parameter after 10 days of storage, had values 4.8, 4.1 and 2.7%, respectively. Total embryonic mortality in study of Terčič and Pestotnik (2016) was not different between eggs stored up to 15 days in normal (13.6%) and inverted position (11.3%). Tiwary and Maeda (2005) reported that total mortality after 7 days of storage in normal and inverted position was 23.5 vs. 19.0%, and the same parameter after 14 days of storage was 43.8 vs. 33.3%, respectively. Lima *et al.* (2012) found that early mortality was 3.7 vs. 1.7% (p>0.05), and late mortality was 5.3% vs. 3.4% (p<0.05) after 7 days of storage of layer breeder eggs in normal and inverted position. Early and late mortality after 14 days of storage in normal and inverted position was 20.1 vs. 9.1% (p>0.05) and 5.8 vs. 5.4% (p>0.05), respectively. Elibol and Brake (2008) reported that inverted positioned egg compared with normal had lower (p<0.05) early and late mortality after 3 (9.5 vs. 8.9%; 4.3 vs. 3.8%, respectively) and 14 days of storage (30.2 vs. 26.7%; 15.4 vs. 10.9%, respectively). Blastoderm in inverted stored eggs is in position which probably decrease possibility of malposition or adhesion to egg membrane (Proudfoot, 1969), and assures better hydration of embryo, which in total results with higher hatchability percentage after storage

as consequence of reduced early and late embryonic mortality (Reijrink, 2009, 2013), whereas egg quality is comparable with quality of normal stored eggs (Proudfoot, 1973).

### **Conclusion**

According to obtained results it can be concluded that storage of broiler hatching eggs longer than 7 day had deleterious influence on hatchability, mainly as consequence of increased embryonic mortality in the first week of incubation. Influence of egg position during 7 and 10 days of storage was not clearly demonstrated on studied parameters of incubation.

### **References**

- Alasahan S., Copur, A.G. (2016). Hatching characteristics and growth performance of eggs with different egg shapes. *Revista Brasileira de Ciência Avícola*, 18 (1): 1-8.
- Elibol O., Brake J. (2008). Effect of egg position during three and fourteen days of storage and turning frequency during subsequent incubation on hatchability of broiler hatching eggs. *Poultry Science*, 87: 1237-1241.
- Kgwatalala P.M., Phetogo O., Damba C., Nsoso S.J. (2015). Influence of egg orientation during storage and storage period on hatchability of Tswana chicken eggs. *Journal of Animal Production Advances*, 5 (3): 629-635.
- King'ori M.A. (2011). Review of the factors that influence egg fertility and hatchability in poultry. *International Journal of Poultry Science*, 10 (6): 483-492.
- Lima J.C.S. de, Silva P.L., Coelho L.R., Borges M.S., Freitas de A.G., Fonseca B.B. (2012). Effects of inverting the position of layers eggs during storage on hatchery performance parameters. *Brazilian Journal of Poultry Science*, 14 (4): 233-304.
- Meijerhof R. (1992). Pre-incubation holding of hatching eggs. *World's Poultry Science Journal*, 48: 57-68.
- Milošević N., Perić L. (2011). Tehnologija živilarske proizvodnje. Poljoprivredni fakultet, Novi Sad.
- Molenaar R., Reijrink I.A.M., Meijerhof R., Van Den Brand H. (2010). Meeting embryonic requirements of broilers throughout incubation: a review. *Revista Brasileira de Ciência Avícola*, 12 (3): 137-148.
- Oluyemi J.A., George O. (1972). Some factors affecting hatchability of chicken eggs. *Poultry Science*, 51: 1762-1763.
- Proudfoot F.G. (1967). Advance note on the hatchability of chicken eggs stored small end up. *Canadian Journal of Animal Science*, 47 (2): 142-143.
- Proudfoot F.G. (1969). Effect of packing orientation, daily positional change and vibration on the hatchability of chicken eggs stored up to four weeks. *Canadian Journal of Animal Science*, 49 (1): 29-35.
- Proudfoot F.G. (1973). Effects of small-end-up egg orientation on Haugh unit scores after storage for 8 and 15 days. *Canadian Journal of Animal Science*, 53 (3): 415-416.
- Reijrink A.M.I., Meijerhof R., Kemp B., van Den Brand H. (2008). The chicken embryo and its micro environment during egg storage and early incubation. *World's Poultry Science Journal*, 64: 581-598.
- Reijrink V.R.I. (2009). Alternative egg storage methods: Small end up or turning. *Hatchtech Incubation Technology*.
- Reijrink V.R.I. (2013). Alternative egg storage methods: small end up or turning. *International Hatchery Practice*, 27 (4): 25.

- Salahi A., Moosanezhad Khabisi M., Esmailizadeh A.K. (2012). Effects of pre-incubation upside-down positioning of eggs from breeder flocks with different ages on hatchability and chick quality. *Animal Production Science*, 52: 269-275.
- Schulte-Drüggelte R. (2011). Recommendations for hatching egg handling and storage. *Lohmann Information*, 46 (1): 55-58.
- Terčič D., Pestotnik M. (2016). Effects of flock age, prestorage heating of eggs, egg position during storage and storage duration on hatchability parameters in layer parent stock. *Acta Argiculturae Slovenica, Supplement 5*, 138-142.
- Tiwary A.K., Maeda T. (2005). Effects of egg storage position and injection of solutions in stored eggs on hatchability in chickens (*Gallus domesticus*). *The Journal of Poultry Science*, 42 (4): 356-362.
- Yassin H., Velthuis A.G.J., Boerjan M., van Riel J., Huirne R.B.M. (2008). Field study on broiler eggs hatchability. *Poultry Science*, 87: 2408-2417.

## CARCASS QUALITY AND MEAT CHEMICAL COMPOSITION IN TWO LINES OF SLOW GROWING CHICKENS AND THEIR CROSSES

Teodora POPOVA<sup>1\*</sup>, Maya IGNATOVA<sup>1,2</sup>, Evgeni PETKOV<sup>1</sup>

<sup>1</sup>Institute of Animal Science, 2232 Kostinbrod, Bulgaria

<sup>2</sup>Agricultural Academy, 1373 Sofia, Bulgaria

\*Corresponding author: tpopova@yahoo.com

### Abstract

The study was carried out to compare the carcass characteristics and meat chemical composition in two lines of slow growing male chickens - La Belle (LB) and Bresse (BB), and their crosses (♂LB x ♀BB, ♂BB x ♀LB). All the birds were reared indoors in the same conditions and at the age of 12 weeks, 6 chickens of each line were selected for slaughter. One-way ANOVA was performed to assess the differences in the carcass and meat quality among lines. The results showed that crossing of LB and BB lines affected the live weight and the weight of the eviscerated carcass ( $P < 0.001$ ), edible by-products - neck and giblets ( $P < 0.05$ ), and non edible parts ( $P < 0.01$ ). The highest values of these parameters were observed in ♂BB x ♀LB birds. This crossbred line had the highest weight of back and wings, while the lowest weight of thighs was observed in BB chickens. Furthermore, ♂LB x ♀BB birds tended to have higher dressing percentage ( $P = 0.08$ ), but the lowest content of edible by-products among all lines ( $P < 0.05$ ). Crossing also influenced the chemical composition of the breast ( $P < 0.001$ ), leading to higher protein but lower moisture content in both crosses. In thighs the content of lipids and protein differed significantly between the crossbred lines as ♂BB x ♀LB had higher lipid but lower protein when compared to the ♂LB x ♀BB chickens ( $P < 0.05$ ). The ash had the highest content in breast of BB birds and the thighs of LB and ♂LB x ♀BB chickens.

**Keywords:** *Slow growing chickens, Pure lines, Crossbred lines, Carcass traits, Meat quality*

### Introduction

The increasing demands of the consumers for high quality and more variety of poultry meat products draws greater attention to the indigenous lines. They appeared to be more resistant to pathogens and environmental stressors (Rizzi and Chiericato, 2010) and have some distinct features suitable for a niche market serving consumers who prefer chicken meat different from that of the commercial broilers (Zhao et al., 2012). The consumption of meat products from local chickens has increased despite their relatively high prices (Yang and Jiang, 2005). La Belle is an indigenous Bulgarian line, and the old French breed Bresse has been recently imported to the country. While the latter has initiated specific production of famous high quality products in France, few studies about the meat properties of La Belle exist (Popova, 2016 a, b). Both breeds are characterized by slower growth (Baéza et al., 2009; Popova, 2016a). Carcass composition and quality are important from economic point of view since they indicate the efficiency of the meat production. According to Shahin and Abd Elazeem (2005) a superior carcass should have maximum proportion of muscle, minimum proportion of bone and optimum proportion of fat, and also must contain high proportion of most valuable muscles that is, breast and thighs. Crossing of the pure lines is a way to manipulate various productive traits in the poultry (Amin et al., 2013), to improve the carcass

composition and meat quality through expected heterotic effect in the generation (Keambou et al., 2010) which is stronger the more the parent lines are genetically distant (Wilham and Pollak, 1985). Hence, the aim of the study was to compare the carcass characteristics and meat chemical composition in two lines of slow-growing chickens - La Belle and Bresse, and their crosses.

## Materials and methods

### *Experimental animals, slaughtering and sampling*

The trial was carried out in the experimental poultry farm of the Institute of Animal Science – Kostinbrod, Bulgaria with a total of 160 Labelle (LB) and 107 Bresse (BB) obtained from the parent stock of the Institute as well as their crosses ( $\sigma^{\text{LB}} \times \text{BB}$ , n=54;  $\sigma^{\text{BB}} \times \text{LB}$ , n=52). The 1-day-old chickens were placed in a deep litter facility with a stocking density of 14 birds m<sup>2</sup> in separate pens in the same poultry house. All the birds were fed *ad libitum* starter (ME- 3147 kcal/kg; protein content-20.15%) and finisher (ME -3105 kcal/kg, protein content-17.77%). Water was provided *ad libitum* with a nipple waterer. The lighting regime was 15 h of light and 9 h of darkness, and the temperature ranged between 20 and 24°C. At the age of 12 weeks, 6 male birds of each line were selected for slaughter based on the average live weight. After stunning, decapitation and bleeding, the carcasses were plucked, eviscerated, their feet removed, the edible by-products (neck, liver, gizzard, heart and spleen) were weighed and their content was calculated as percentage of the live weight. Hot carcass weight was registered and dressing percentage was calculated. The carcasses were then stored at 4°C for 24 h and weighed again. Further the internal fat was removed from the carcasses and they were separated into breast, thigh, back and wings. The weight of the parts and the internal fat was recorded. The skin and bones from the breast and thighs were removed to obtain the muscles and they were weighed. The content of the separated parts, muscles and internal fat was calculated as percentage of the cold eviscerated carcass weight. The muscles were minced and frozen at -20°C until further analysis of the chemical composition of the meat.

### *Analysis of the chemical composition*

The breast and thigh meat was analysed for lipid, protein, moisture and ash content following the AOAC 2004 Official method of analysis.

### *Statistical analysis*

Data were evaluated through one way ANOVA to determine the differences between the lines in regard to the examined traits. Further, whenever appropriate, Tukey's post hoc test (P<0.05) was applied to compare the means between the different genotypes. Statistical analysis was performed using JMP v. 7 software package (JMP Version 7, SAS Institute Inc. Cary, NC).

## Results and discussion

### *Carcass analysis*

Carcass composition of the pure and crossbred lines is presented on Table 1. Since the experimental birds were all reared under the same conditions and slaughtered at the same age, the discrepancies in the carcass traits among the lines and their crosses could indicate effect of the line.

Table 1. Carcass composition of the pure (LB and BB) and crossbred ( $\sigma$ LB x  $\phi$ BB and  $\sigma$ BB x  $\phi$ LB) lines

Item	Lines				SEM	Sig.
	LB	BB	$\sigma$ LB x $\phi$ BB	$\sigma$ BB x $\phi$ LB		
Live weight, g	1986.67b	1973.83b	2025.83b	2137.50a	14.99	***
Carcass weight, g (hot)	1235.33bc	1201.17c	1290.16ab	1322.16a	12.82	***
Carcass weight, g (cold)	1211.83bc	1172.50c	1267.00ab	1310.00a	13.67	***
Dressing percentage, %	62.18	60.87	63.68	61.85	0.40	0.08
Feet, g	96.66ab	86.00c	90.67bc	102.00a	1.76	**
Intestines, g	145.50	151.17	145.50	163.00	2.83	0.08
Total inedible, g	242.16ab	237.17b	236.17b	265.00a	18.36	**
Total inedible, %	12.19	12.01	11.66	12.41	0.15	NS
Neck, g	40.00	43.00	45.16	46.00	0.94	NS
Liver, g	37.16ab	37.33ab	32.50b	39.00a	0.81	*
Gizzard, g	36.50ab	41.83a	32.00b	41.00a	1.12	**
Heart, g	10.50	10.66	11.00	9.17	0.32	NS
Spleen, g	3.33	3.50	3.33	3.50	0.18	NS
Total edible, g	127.49ab	136.32ab	123.99b	138.67a	2.00	*
Total edible, %	6.41ab	6.91a	6.13b	6.49ab	0.10	*
Internal fat, g	28.83	30.00	38.66	47.33	2.96	0.08
Internal fat, %	2.37	2.58	3.03	3.61	0.23	NS
Breast (skin+bone),g	328.33	340.67	326.33	329.33	7.49	NS
Breast (muscle), g	219.33	230.33	229.33	236.33	4.31	NS
Breast (skin+bone)%	27.09	29.04	25.81	25.08	0.61	NS
Breast (muscle), %	18.10	19.60	18.09	18.01	0.29	NS
Thigh (skin+bone), g	452.16a	423.00b	464.66a	465.16a	4.67	***
Thigh (muscle),g	298.17ab	287.17b	316.50a	312.83a	3.83	*
Thigh (skin+bone),%	37.34a	36.08ab	36.68ab	35.51b	0.24	*
Thigh (muscle),%	24.62	24.49	24.97	23.87	0.19	NS
Back, g	259.67ab	241.17b	260.33ab	280.16a	4.81	*
Back, %	21.41	20.57	20.55	21.38	0.27	NS
Wings, g	172.17ab	166.67b	167.00b	181.83a	2.02	*
Wings, %	14.21	14.22	13.18	13.90	0.16	0.05

Significance of the factor Line: \*P<0.05; \*\*P<0.01; \*\*\*P<0.001; Values connected with different letters are significantly different (P<0.05)

The four groups differed in their live weight (P<0.001) as the highest was recorded in  $\sigma$ BB x  $\phi$ LB. The same was observed for the hot and cold weight of the eviscerated carcass (P<0.001). Significant difference (P<0.01) was found in the weight of unedible parts (feet and intestines), which was determined by the highest content of feet in  $\sigma$ BB x  $\phi$ LB and the tendency for the highest weight of the intestines in this cross. Further, the content of the edible parts (neck and giblets)also varied among the four lines (P<0.05). This was due to the significant differences in the content of liver and gizzard between the groups. When compared to the others,  $\sigma$ BB x  $\phi$ LB chickens had higher weight of the liver, while the other cross exhibited the lowest weight of this internal organ. In regard to the gizzard content, the higher was observed in  $\sigma$ BB x  $\phi$ LB and the pure Bresse birds, while the lowest weight was again recorded in the chickens of  $\sigma$ LBx $\phi$ BB crossbred line. The internal fat tended to be higher in  $\sigma$ BB x  $\phi$ LB birds (P=0.08). This corresponded to the highest weight of the liver and suggests increased rate of lipogenesis. Also the high weight of the liver in the  $\sigma$ BB x  $\phi$ LB corresponded to highest live weight of this birds when compared to the other three lines. Similar relationship has been documented by Iman Rahayu et al. (2008) when comparing two genotypes of birds. Since different growth rates have been registered in the

four groups (unpublished data), it could be suggested that some of the internal organs have undergone modifications in their size to accommodate these discrepancies.

The weight of the breast did not differ between the four lines, however, the thighs both with skin and bones, and pure muscle, were significantly affected by the genotype. The weight of the thighs was the lowest in the BB chickens, while the other three lines showed close values of this parameter. The weight of the back and the wings also differed significantly between the groups ( $P < 0.05$ ). Both parts had the highest values of the weight in the ♂BB x ♀LB birds, while the lowest were recorded in the BB line. Additionally ♂LB x ♀BB also showed low values of the weight of the wings when compared to the other lines.

The birds from ♂LB x ♀BB crossbred line tended to have higher dressing percentage ( $P = 0.08$ ) when compared to the other lines, while the lowest value of this trait was registered in the pure Bresseline. The opposite, however, was found in regard to the percentage of the edible organs and neck ( $P < 0.05$ ). This corresponded to the data about the absolute weight of the giblets, presented above. In addition, the lowest dressing percentage in the Bresse birds coincided with their lowest weight of the eviscerated carcass before and after cooling and storage at 4°C, determined by the low content of thighs, back and wings found in this line, compared to the others. On the other hand, the highest dressing percentage recorded in ♂LB x ♀BB is associated with the lowest weight of the giblets in these birds.

The meat part whose percentage was influenced by the difference in the line were thighs with bone and skin. Its values were the highest in LB birds, while in ♂BB x ♀LB it was the lowest. On the other hand, the percentage of wings also tended to differ between the groups, being the highest in LB and BB, and the lowest in ♂LB x ♀BB ( $P = 0.05$ ). The results for the superiority of the crossbred over the pure lines, mainly over the BB chickens, concerning the content of thighs, back and wings that was observed in this study could suggest certain heterotic effect in regard to these traits, influenced to a stronger extent by the mother lines (Liu et al., 1995).

#### Chemical composition of the meat

The chemical composition of breast and thigh meat is presented in Table 2.

Table 2. Meat chemical composition of the pure (LB and BB) and crossbred (♂LB x ♀BB and ♂BB x ♀LB) lines

Item	Lines				SEM	Sig.
	LB	BB	♂LB x ♀BB	♂BB x ♀LB		
<b>Breast</b>						
Lipids, %	1.85	1.31	1.14	1.61	0.13	NS
Protein, %	22.99b	22.59b	24.85a	24.74a	0.24	***
Moisture, %	72.04b	72.92a	70.89c	70.57c	0.21	***
Ash, %	1.14b	1.20a	1.13b	1.11b	0.01	***
<b>Thigh</b>						
Lipids, %	5.40ab	5.86ab	4.29b	6.82a	0.30	*
Protein, %	19.43ab	19.49ab	20.46a	18.07b	0.31	*
Moisture, %	72.20	71.77	72.29	72.26	0.12	NS
Ash, %	1.07a	0.99b	1.04a	0.96b	0.01	***

Significance of the factor Line \* $P < 0.05$ ; \*\*\* $P < 0.001$ ; Values connected with different letters are significantly different ( $P < 0.05$ )

The line had no significant influence on the content of the intramuscular lipids in breast, while in the thigh it affected this parameter ( $P < 0.05$ ), as the differences existed between the two crosses. When compared to all, the chickens of ♂BB x ♀LB crossbred line had the highest lipid content while the ♂LB x ♀BB birds had the lowest. The intramuscular lipid



content is important since it is closely associated with the sensory perception of meat, but also with its tenderness and juiciness (Van Laak et al., 2001). In a previous study with La Belle and White Plymouth Rock chickens slaughtered at two different ages (Popova et al., 2016a) we did not find effect of the line on the lipid content in breast and thigh meat. Similarly, Yin et al. (2013) did not find any difference in the lipid content in breast in two lines and their hybrids. On the other hand, Jaturasitha et al. (2008) comparing chickens of Bresse, Rhode Island Red and two indigenous Thai breeds reported that the intramuscular lipid content varied significantly between breeds. In the same study, the lipid content in the breast and thigh meat of Bresse chickens was 0.76% and 4.21%, respectively for birds slaughtered at 16 weeks of age. These values are lower than the reported here for the 12 weeks old birds.

Significant differences in protein content were found between the lines in both breast ( $P < 0.001$ ) and thigh meat ( $P < 0.05$ ). The birds from both crossbred lines had higher protein than the pure LB and BB chickens. In thigh, the protein content followed the similar pattern as in the lipids, as significant differences were detected between the two crosses. ♂LB x ♀BB had the higher protein content, while ♂BB x ♀LB displayed lower value of this parameter. The protein content determined in our experiment is within the range found in other studies (Mikulski et al., 2011; Guan et al., 2013). The increase in the protein content in the breast of ♂LB x ♀BB and ♂BB x ♀LB and at the same time the lack of changes in the lipids indicated the positive influence of the crossing between the two pure lines in regards to the dietetic value of the meat. Crossing between two lines (Arbor Acres and WL) affected the protein and lipid content in meat as observed by Liu and Niu (2008). The highest values of protein and lowest of lipid content was achieved in WL, while the opposite was observed in Arbor Acres. F1 was reported to have intermediate characteristics. The higher protein content in breast of the crossbred lines was associated with significantly lower moisture ( $P < 0.001$ ), while in the thighs no effect of the line was observed in regard to this parameter. The moisture content and respectively the dry matter of the meat are important traits since the higher dry matter content is positively related to nutritional quality of the meat. Of both pure lines, the higher moisture content in breast was determined in BB, while no difference was found between the two crosses. In this study, the moisture content was in the range of 70.57-72.92% in breast and 71.77-72.29% in thighs. Sarsenbek et al. (2013) determined moisture content of 72-93-75.16% in indigenous breed and 74.43-76.03 % in commercial broiler chicken. Ash content in breast also differed significantly among the lines ( $P < 0.001$ ), the highest being observed in BB birds, when compared to the others. Although affected by the genotype of the birds ( $P < 0.001$ ), the ash content in thigh did not follow the trend observed in the breast meat. The birds from LB line and the cross ♂LB x ♀BB had higher ash content when compared to the BB and ♂BB x ♀LB chickens.

### **Conclusions**

The crossing of the two lines – LB and BB was associated with significant and positive effect on both carcass traits and chemical composition of the meat. The crossbred line where BB was used as sire line displayed the highest live weight, and weight of the eviscerated carcass, as well as the highest content of edible organs and non edible parts. The same cross had also highest weight of the thighs, back and wings. On the other hands using LB as sire line led to the highest dressing percentage, but the lowest percentage of the edible organs among all lines. The crossing of the pure lines influenced positively the chemical composition of the breast leading to higher protein and lower moisture content in both crosses. In thighs, however, the content of lipids and protein differed significantly between the crossbred lines as ♂BB x ♀LB had higher lipid but lower protein. The ash had the highest content in breast of

BB birds, as well as in the thighs of LB and ♂LB x ♀BB. The findings of the study show the potential benefits of the crossing to improve the carcass traits of indigenous lines and their meat quality.

### References

- Amin E.M., Kosba M.A., Amira El-Dlebhany E., El-ngomy M.A. (2013). Heterosis, maternal and direct additive effects for growth traits in Alexandria chickens. *Egyptian Poultry Science*, 33 (4), 1033-1051.
- AOAC (2004). *Official methods of analysis*, 18th Ed., Association of Official Analytical Chemists, Arlington, VA, USA.
- Baéza E., Chartrin P., La Bihan-Duval E., Lessire M., Besnard J., Berri C. (2009). Does the chicken genotype 'Geline de Touraine' have specific carcass and meat characteristics? *Animal*, 3(5), 764–771.
- Guan R-F., Lyu F., Ghen X-Q., Ma J-Q, Jiang H., Xiao C-G. (2013). Meat quality traits of four Chinese indigenous chicken breeds and one commercial broiler stock. *Journal of Zhejiang University-Science B*, 14(10), 896-902.
- Iman Rahayu H.S., Zulfiki I., Vidyadaran M. K., Alimon A. R., Babjee S.A. (2008). Carcass Variables and Chemical Composition of Commercial Broiler Chickens and the Red Jungle Fowl. *Asian-Australasian Journal of Animal Science*. 21(9), 1376 – 1382.
- Jaturasitha S., Srikanchai T., Kreuzer M., Wicke M. (2008). Differences in carcass and meat characteristics between chicken indigenous to northern Thailand (Black-boned and Thai native) and imported extensive breeds (Bresse and Rhode Island Red). *Poultry Science*, 87 (1), 160–169.
- Keambou T.C., Manjeli Y., Boukila B., Mboumba S., Mezui Mezui T., Hako Touko B.A. (2010). Heterosis and reciprocal effects of growth performances in F1 crosses generations of Local x Hubbard chicken in the Western Highlands of Cameroon. *Livestock Research for Rural Development*, 22, 1.
- Liu G., Dunnington E. A., Siegel P. B. (1995). Growth related traits in body weight selected lines and their crosses reared under different nutritional regimes. *British Poultry Science*, 36, 209-219.
- Liu F., Niu Z. (2008). Carcass quality of different meat - typed chickens when achieve a common physiological body weight. *International Journal of Poultry Science*, 7 (4), 319-322.
- Mikulski D., Celej J., Jankowski J., Majewska T., Mikulska M. (2011). Growth performance, carcass traits and meat quality of slower-growing and fast-growing chickens raised with and without outdoor access. *Asian-Australasian Journal of Animal Science*, 24 (10), 1407 – 1416.
- Popova T., Petkov E., Ignatova M. (2016a). Composition of meat in La Belle and White Plymouth Rock chickens, slaughtered at different age. *Agricultural Science and Technology*, 8 (2), 162-165.
- Popova T., Ignatova M., Petkov E., Stanišić N (2016b). Difference in fatty acid composition and related nutritional indices of meat between two lines of slow-growing chickens slaughtered at different ages. *Archives Animal Breeding*, 59, 319-327.
- Rizzi C., Chiericato G. M. (2010). Chemical composition of meat and egg yolk of hybrid and Italian breed hens reared using an organic production system. *Poultry Science*, 89(6), 1239-1251.
- Sarsenbek A., Wang T., Zhao J. K., Jiang W. (2013). Comparison of dressing percentages and meat quality between Baicheng-You chickens and Arbor Acres broilers. *Poultry Science*, 92 (10), 2776–2782.

- Shahin K.A., Abd Elazeem F. (2005). Effects of breed, sex and diet and their interactions on carcass composition and tissue weight distribution of broiler chickens. *Archiv Tierzucht*, 48, 612-626.
- Van Laack R., Stevens S., Stalder K. (2001). The influence of ultimate pH and intramuscular fat content on pork tenderness and tenderization. *Journal of Animal Science*, 79 (2), 392–397.
- Willham R. L., Pollak E. (1985). Theory of heterosis. *Journal of Dairy Science*, 68(9), 2411-2417.
- Yang N., Jiang R.S. (2005). Recent advances in breeding for quality chickens. *World's Poultry Science Journal*, 61, 373–382.
- Yin H.D., Gilbert E.R., Chen S.Y., Wang Y., Zhang Z. C., Zhao X. L., Zhang Y., Zhu Q. (2013). Effect of hybridization on carcass traits and meat quality of Erlang mountainous chickens. *Asian-Australasian Journal of Animal Sciences*.26(10),1504-1510.
- Zhao J. P., Zhao G. P., Jiang R. R., Zheng M. Q., Chen J. L., Liu R. R., Wen J. (2012). Effects of diet-induced differences in growth rate on metabolic, histological, and meat-quality properties of 2 muscles in male chickens of 2 distinct broiler breeds. *Poultry Science*, 91(1),237-247.

## TWO SIDES OF THE GOLDEN JACKAL: ITS CONTROVERSIAL ROLE IN SOUTHWESTERN HUNGARY

Agnes CSIVINCSIK<sup>1\*</sup>, Zsuzsanna RÓNAI<sup>2</sup>, Szilárd SZABÓ<sup>3</sup>, Tamás BALOG<sup>3</sup>, Gábor NAGY<sup>4</sup>

<sup>1</sup>Institute of Diagnostic Imaging and Radiation Oncology, University of Kaposvár, Kaposvár, Hungary

<sup>2</sup>Veterinary Diagnostic Directorate, National Food-chain Safety Office (NÉBIH), Budapest, Hungary

<sup>3</sup>Department of Game Management, SEFAG Forest Management and Wood Industry Plc., Kaposvár, Hungary

<sup>4</sup>Department of Animal Nutrition, University of Kaposvár, Kaposvár, Hungary

\*Corresponding author: csivincsik.agnes@sic.ke.hu

### Abstract

The golden jackal was autochthonous in Hungary until the 1970s when it became extinct because of extensive persecution and habitat loss. During the 1990s, it appeared again in the southwestern part of the country. Initially, the species was invisible, because of its small population size and hiding lifestyle. Afterwards, the population began to expand and game managers mention the species as a pest, time and again. On the other hand, ecologists welcome the jackals as a new element of ecosystem, which increases the biodiversity and improves the ecosystem services. In our study, we attempted to lighten different ecological aspects of this enigmatic species. In order to attain our objectives, we investigated the effect of jackals on the epidemiology of a micro- and a macroparasite. We hypothesized that the species, through improvement of ecosystem services, favour the trend in tuberculosis epidemic sustained by wild ungulates; on the other hand, as a canid, golden jackal could pose a risk of echinococcosis. Comparing the prevalence of suspect tuberculosis lesions on jackal habitats with adjacent sites, we found a significant difference (11.9% on jackal sites and 32.1% on adjacent area). On the other hand, prevalence of echinococcosis in golden jackal was 15.4%, while mean intensity was 288.83. Summarizing these results, we concluded that the presence of this carnivore is beneficial to the trend of tuberculosis endemic; notwithstanding, the species seemed to be a reservoir of *Echinococcus* spp. on areas, where its population gets dense. Our investigation highlighted the complex effect of a change in an ecosystem.

**Keywords:** *Golden jackal, tuberculosis, Echinococcus spp, biodiversity, multidisciplinary approach.*

### Introduction

The golden jackal (*Canis aureus*) is one of the most widely distributed canid species in Eurasia (Arnold et al., 2012). The species has been residing in Europe since the Holocene, though until the beginning of the last century, its number remained low and its presence was limited to the Mediterranean and Black sea coastal regions (Krofel et al., 2016). The role of the species is controversial. As a predator, it contributes to ecosystem services and improvement of biodiversity (Krofel et al., 2016). Nevertheless, game managers and livestock farmers consider the jackals to be harmful (Arnold et al., 2012; Markov, 2012). Some studies call the attention to the potential risk of disease spread might be caused by these mesopredators (Ćirović et al., 2014; Markov, 2012., Rutkowski et al., 2015). In Hungary, the golden jackal was autochthonous until the 1970s when it became extinct because of extensive persecution and habitat loss. During the 1990s, it appeared again in the southwestern part of

the country (Arnold et al., 2012). Initially, the species was invisible, because of its small population size and hiding lifestyle. Afterwards, the population began to expand and game managers mention the species as a pest, time and again. On the other hand, ecologists welcome the jackals as a new element of ecosystem, which increases the biodiversity and improves the ecosystem services. In our study, we attempted to lighten different ecological-epidemiological aspects of this enigmatic species. This made an opportunity for us to demonstrate the advantage of considering ecological viewpoints during the investigation of an epidemiological problem. In order to attain our objectives, we investigated the effect of jackals on the epidemiology of a micro- and a macroparasite. We hypothesized that the species, through improvement of ecosystem services, favour the trend in tuberculosis epidemic sustained by wild ungulates; on the other hand, as a canid, golden jackal might pose a risk of echinococcosis. For confirmation of our hypothesis, we carried out a complex survey in a special jackal habitat and in its surrounding environment. During the survey, we investigated trends of tuberculosis among wild boars (*Sus scrofa*) and echinococcus infection among golden jackals. The results of the two habitat types were compared to assess the epidemiological effects of jackals.

### Materials and methods

The study area was the south-western part of Hungary, where population of golden jackal has a great expansion. The two types of habitat, we studied, are markedly different. The jackal habitat is an extended sandy lowland with plenty of moors and fishponds: Inner-Somogy with the village Lábod, (GPS 46.204568, 17.463420) in the centre. The adjacent area, where the presence of golden jackals is sporadic, is the Zselic Landscape Protection Area, with the village Bőszénfa (GPS 46.23633, 17.85200) in the centre. This area is mostly hilly, highly forest-covered area with agricultural lands in the peripheral parts. During our study we examined the prevalence of suspect tuberculosis lesions (sTBL) in wild boars' submandibular lymph nodes (smLN) and prevalence and mean intensity of *Echinococcus* spp. infection in the golden jackal. Post-mortem examination of wild boars' smLN was performed in the field, during evisceration of the hunter-harvested bodies. Based on previous experiences that macroscopic evaluation of these organs is a suitable tool for monitoring bTB infection in wild boar populations; we limited our investigation to smLN (Csivincsik et al., 2015). The smLNs were examined *in situ*, by slicing it into 2 mm sections. Every purulent, caseous and calcified process was evaluated as suspect bTB lesions (sTBL). Data were collected during drive hunting events, when wild boars were shot without any special selection for age, gender or health status; therefore, randomness was assured by different skills of the hunters. Findings of post-mortem examination were collected into written notes; nevertheless, characteristic visible lesions were photographed. The apparent prevalence of sTBL was calculated separately for the jackal habitats and the adjacent areas. Data of the two sites were compared by Chi-square test with R Statistics software version 3.3.2 (2016-10-31). During the study, we collected small intestines from golden jackals in order to determine the level of *Echinococcus* spp. infection. Most of the samples derived from the jackal site and the others from the adjacent area. The organs were collected from hunting events in all year round. After necropsy, each organ was placed separately into a plastic bag. For safety reasons, the intestinal tract was frozen at  $-80\text{ }^{\circ}\text{C}$  for 7 days before examination. After melting (at room temperature), the guts were opened and the content and intestinal mucosa was collected (Eckert et al. 2001). The samples were examined by sedimentation method. For morphological identification, we used Sréter's et al. (2003) work. The method was based on the number of proglottids, the length of worms and the terminal proglottid and the uterus morphology. In this survey, the nomenclature we followed was detailed by Bush et al. (1997).

For descriptive statistical analysis we calculated the prevalence and mean intensity using the Quantitative Parasitology 3.0 software (Rózsa et al. 2000) with 95% confidence interval (CI 95%).

### Results

In this study, we examined altogether 49 small intestines. Six of the 42 animals, shot in the jackal site, were infected by *Echinococcus* spp., while none of the seven ones, derived from the adjacent area, proved to be infected. Thus the calculated prevalence and mean intensity proved 15,4 % (CI95% = 6.41–28.36 %) and 288.83 (CI95% = 12.05–1107.67), respectively. The wide range of confidence interval of mean intensity is owing to a heavily infected animal which carried 1648 *Echinococcus* specimen. After the species identification we concluded that all of the worms proved *Echinococcus multilocularis*. The results of the complex survey are summarized in Table 1.

**Table 1** Prevalence of suspect tuberculosis lesions (sTBL) in wild boars and *Echinococcus multilocularis* in golden jackal within the jackal habitat and outside it

	Jackal habitat	Adjacent area	P-value
<b>Prevalence of sTBL in wild boars</b>	10.9% (N=92)	32.1% (N=215)	0.01>
<b>Prevalence of <i>E. multilocularis</i> in golden jackals</b>	14.2% (N=42)	0% (N=7)	0.28

### Discussion

As a result of our survey, a recognizable difference could be confirmed between the prevalence of sTBL on the jackal site and on the adjacent area. On the other hand, the infection of *E. multilocularis* reached a considerable rate within the jackal area; though it did not differ significantly from the adjacent area. These experiences reassure the controversial role of the species. Based on the finding that trends of bTB within an ecosystem with dense jackal population is advantageous, we might conceive that jackal as a scavenger animal eliminates infective materials, like hunting offals from the environment; and as a predator removes the weakest, probably sick, individuals from ungulate populations. With these characteristics, jackals can contribute to ecosystem health. An additional beneficial effect of these mesopredators that they consume a lot of rodents, which are also play a role as vectors of diseases. Nevertheless, our survey raised the question whether golden jackal might be the reservoir of *E. multilocularis* within the Pannonian region. Until our survey just one *E. multilocularis* infected golden jackal was found (Széll et al. 2013) in Hungary. The present prevalence of infection in the jackals proved to be higher, while the mean intensity was lower than in former studies in red fox in Somogy County (Tolnai et al. 2013). The difference in prevalences between the two final hosts might be explained by their population density. In the case of mean intensity, we hypothesize the lower infection level derives from the different host-adequacy of the two carnivore species. Based on the phenomenon that prevalence of *E. multilocularis* infection on the two sites is very similar, we assume that an on-going migration makes a connection between the two sites. Another possible explanation is that outside the jackal area, only vagrant animals were sampled during the study.

Notwithstanding, this small sample size (N=7 versus N=42) is not eligible to form an adequate opinion. Experiences on the trends of bTB in a habitat with very dense jackal population show a good example of improvement of ecosystem services and call the attention on necessity of multidisciplinary approach to epidemiological problems. Nevertheless, the *E. multilocularis* reservoir status of the species and the real epidemiological risk have to be ascertained by further investigations.

### Conclusion

In this study, we attempted to show the possibilities of a new epidemiological investigation method, which considers an epidemiological problem as the part of the ecosystem, in which it occurs. The golden jackal as a characteristic element of the occupied ecosystems has a remarkable influence on the environment. Its sanitary effect as a predator and scavenger is incontestable, as it can eliminate infected materials. On the other hand, predators can harbour infections and spill-back phenomenon can eventuate. The drives of this spill-back and the risk caused by predator populations should be in the focus of investigations on ecosystem health.

### References

- Arnold J., Humer A., Heltai M., Murariu D., Spassov N., Hackländer K. (2012). Current status and distribution of golden jackals *Canis aureus* in Europe. *Mammal Review*, Vol. 42, pp.1–11. doi:10.1111/j.1365-2907.2011.00185.x
- Bush A.O., Lafferty K.D., Lotz J.M., Shostak A.W. (1997). Parasitology meets ecology on its own terms: Margolis et al. revisited. *The Journal of Parasitology*, Vol 83, No. 4, pp. 575-583.
- Ćirović D., Chochlakakis D., Tomanović S., Sukara R., Penezic A., Tselentis Y., Psaroulaki A., (2014). Presence of *Leishmania* and *Brucella* species in the golden jackal *Canis aureus* in Serbia. *BioMed Research International*, Vol. 2014, Article ID 728516, 6 pages, 2014. doi:10.1155/2014/728516.
- Csivincsik Á., Rónai Zs., Nagy G., (2016). Post mortem examination of submandibular lymph node in wild boars (*Sus scrofa*) as beneficial part of bovine tuberculosis surveillance systems. *Acta Agraria Kaposvariensis*, Vol. 19, No. 1, pp. 8-12.
- Eckert J., Gemmell M., Meslin F., Pawlowski Z.S. (2001). WHO/ OIE Manual on Echinococcosis in Humans and Animals: A Public Health Problem of Global Concern. World Health Organization, Paris.
- Krofel M., Giannatos G., Ćirović D., Stoyanov S., Newsome T.M., (2017). Golden jackal expansion in Europe: a case of mesopredator release triggered by continent-wide wolf persecution? *Hystrix, the Italian Journal of Mammalogy*, Vol. 28, No. 1 doi:10.4404/hystrix-28.1-11819
- Markov G. (2012). Golden jackal (*Canis aureus* L.) in Bulgaria: What is Going on? *Acta Zoologica Bulgarica*, Vol. 4, pp. 67-71.
- Rózsa L., Reiczigel J., Majoros G. (2000) Quantifying parasites in samples of hosts. *The Journal of Parasitology*, Vol. 86, pp. 228-232.
- Rutkowski R, Krofel M, Giannatos G, Ćirović D, Männil P, Volokh AM. (2015) A European concern? Genetic structure and expansion of golden jackals (*Canis aureus*) in Europe and the Caucasus. *PLoS ONE*, Vol. 10, No. 11, e0141236. doi:10.1371/journal.pone.0141236
- Sréter T., Széll Z., Egyed Z., Varga I., (2003). *Echinococcus multilocularis*: an emerging pathogen in Hungary and Central Eastern Europe? *Emerging Infectious Diseases*, Vol. 9, pp. 384–386.

- Széll Z., Marucci G., Pozio E., Sréter T., (2013). *Echinococcus multilocularis* and *Trichinella spiralis* in golden jackals (*Canis aureus*) of Hungary. *Veterinary Parasitology*, Vol. 179, No. 1-2, pp. 293-396.
- Tolnai Z., Széll Z., Sréter Z., (2013). Environmental determinants of the spatial distribution of *Echinococcus multilocularis* in Hungary. *Veterinary Parasitology*, Vol. 198, pp. 292-297.



## **SIMULATION OF SUSPENDED SEDIMENT LOAD USING ARTIFICIAL NEURAL NETWORK MODEL, CASE STUDY: HARAZ RIVER, IRAN**

Mehdi VAFAKHAH<sup>1\*</sup>, Shirko EBRAHIMI MOHAMMADI<sup>2</sup>

<sup>1</sup>Faculty of Natural Resources Tarbiat Modares University, Iran.

<sup>2</sup>Faculty of Natural Resources, University of Kurdistan, Iran.

\*Corresponding author: vafakhah@modares.ac.ir

### **Abstract**

Artificial neural network (ANN), multiple linear regression (MLR) and sediment rating curve (SRC) were compared to model the daily suspended sediment load in Karehsang gauging station in Haraz River, Haraz-Gharesoo watershed, Iran. The suspended sediment load was related to the average rainfall and streamflow. In this study, eight input combinations, which fell in two groups, were used. Models in Group I used both climatic (Rainfall) and hydrologic variables (streamflow) as inputs. Models in Group II tried to predict sediment from streamflow only. Root mean square error (RMSE) and correlation coefficient (R) statistics were employed to evaluate the performance of the ANN, MLR and SRC models for forecasting suspended sediment load. It is demonstrated that ANN is capable of modeling the daily suspended sediment load with fairly good accuracy when proper variables and their lag effect on the suspended sediment load are used as inputs. Compared with multiple linear regression and sediment rating curve models, ANN can generate a better fit under the same data requirement. In addition, ANN with previous three days rainfall and streamflow information can provide more reasonable predictions because of the distributed information processing system and the nonlinear transformation involved and also importance of lag-effect in input variables.

**Keywords:** *Artificial neural network, multi linear regression; sediment rating curves; daily suspended sediment load; Haraz river.*

### **Introduction**

Correct estimation of sediment load carried by a river is important with respect to channel navigability, reservoir filling, hydroelectric-equipment longevity, river aesthetics, fish habitat and scientific interests. In environmental engineering, if the particles also transport pollutants, the estimation of river sediment load has an additional significance. McBean and Al-Nassri (1988) investigated the uncertainty in suspended sediment curves and they concluded that the practice of using sediment load versus discharge is misleading because the goodness of fit implied by this relation is spurious. They have instead recommended that the regression can be established between discharge and sediment concentration. Artificial neural network (ANN), a massively parallel distributed information processing system, is based on concepts derived from research on the nature of human brains (Müller et al., 1995). ANN was introduced into hydrological modeling in the 1990s (Singh et al., 2002). In the suspended sediment forecasting context, recent experiments have reported that artificial neural networks (ANNs) may offer a promising alternative (Abrahart and White, 2001; Jain, 2001; Tayfur, 2002; Cigizoglu, 2004; Kisi, 2004; Cigizoglu and Kisi, 2006; Tayfur and Guldal, 2006; Ardicioglu et al., 2007; Zhu et al., 2007).

In this research, we applied ANN to simulate discrete daily suspended sediment load from 1968 to 2005 in the Haraz River of the Haraz-Gharesoo Catchment, Iran. Instead of using water discharge and suspended sediment as inputs, we attempted to relate the suspended sediment load to the original driving force, i.e., climatic variable (rainfall), to establish an ANN model that can be used to explore the relationships between the rainfall, streamflow as inputs and sediment responses. The advantages of ANN were also evaluated by comparing its performance with that of multiple linear regression (MLR) models and Sediment rating curves (SRC) model.

### Material and Methods

The study area along the Haraz river is located at 35°45'N~36°08'N and 51°36'E~52°26'E, North of Iran. The daily rainfall (P), streamflow (Q) and suspended sediment (S) time series data belonging to Karehsang Station (station no: 15-017). The Karehsang gauging station is located at the lower reach of the river, which has a drainage area of 4023 km<sup>2</sup>. The station height is 220 m above sea level.

The daily rainfall, suspended sediment load (ton/day) and water discharge (m<sup>3</sup>/s) data at the Karehsang gauging station from 1968 to 2005 was collected. Iran Ministry of Power measures rainfall and water discharge every day and suspended sediment concentration (SSC) manually some days plus more samples during floods. The suspended sediment load data are not continuous in both gauging stations, since the observations just for some days are measured. But we have all the rainfall, suspended sediment load and streamflow discharge data simultaneously in sampling days. The statistical parameters of the streamflow, sediment and rainfall data for the Karehsang station is given in Table 1.

In this table, the  $X_{mean}$ , S.D.,  $C_v$ ,  $C_{sx}$ ,  $X_{max}$  and  $X_{min}$  denote the mean, standard deviation, coefficient of variation, skewness, maximum and minimum, respectively. As can be seen from the Table 1, the sediment and flow data show a significantly high skewed distribution. This is confirmed by the high ratio between standard deviation, mean and  $C_v$ . This creates additional difficulties for the models in prediction. The maximum– mean ratio ( $X_{max}/X_{mean}$ ) for sediment series in the training period is also quite high (12.41). All these statistics indicate the complexity of the discharge–sediment phenomenon.

Table 1. The statistical parameters of data set

Data set	Data type	Mean	S.D.	$C_v$	$C_{sx}$	$X_{max}$	$X_{min}$
Training	Flow(m <sup>3</sup> /s)	52.13	43.17	1.21	2.23	263.62	2.08
	Sediment(ton)	5963.17	10731	0.56	3.20	73975.2	14.14
	Rainfall(mm)	2.38	7.54	0.32	8.72	105.60	0
Testing	Flow(m <sup>3</sup> /s)	28.56	15.74	1.81	0.92	83.66	1.71
	Sediment(ton)	2773.3	5139.2	0.54	3.15	29205.9	13.69
	Rainfall(mm)	2.23	5.91	0.38	6.73	66	0
Validation	Flow(m <sup>3</sup> /s)	30.41	18.74	1.62	1.5	96.61	1.87
	Sediment(ton)	15.29	2560	0.60	3.33	15700.9	28.44
	Rainfall(mm)	2.26	5.72	0.39	5.54	56.50	0

For developing an artificial neural network (ANN) model the original data must be processed through two steps: data standardization and data set partition. The original input and output data consist of different parameters with different physical meaning and units, and thus their ranges are highly variable. The input and output variables for the present study were standardized into the interval [0.1, 0.9]. Of the many ANN paradigms, the backpropagation network is by far the most popular (Lippman, 1987). The networks were trained with a Back-Propagation (BP) algorithm. The most common transfer function implemented in the literature is the sigmoid function. In this study both Log-Sigmoid and Tan-Sigmoid transfer functions were examined for hidden neurons but the Tan-Sigmoid function gave the better results compared with Log-Sigmoid. Therefore, the Tan-Sigmoid function was preferred for hidden neurons and linear activation function for output neurons. The Levenberg-Marquardt algorithm (LM) is employed during the training of the ANN models since the incorporation of LM into ANN speeds up the convergence (Hagan and Menhaj, 1994; Kisi, 2007). The hidden layer node numbers of each model were determined using trial-error method. Multiple linear regression (MLR) was employed to simulate the relationship between the input variables and the suspended sediment load. Two MLR models with the same input combinations as the best performing networks from ANN Group I, Group II, respectively, were established. Sediment rating curve consists of a graph or equation, relating suspended sediment load to streamflow, which can be used to estimate sediment load from the streamflow records. The performances of the MLR and SRC models were also evaluated using RMSE and R, and were compared with those of ANNs which have the same inputs.

### **Results and Discussion**

In this study, eight input combinations, which fell in two groups, were used (Table 2). The networks in different groups were designed to compare the performances of different sets of causal variables; while those in the same group were designed to examine the degree of lag-effect between the inputs and the outputs. Networks in Group I used both climatic (Rainfall) and hydrologic variables (streamflow) as inputs. Networks in Group II tried to predict sediment from streamflow only. The RMSE and R statistics of ANN, MLR and SRC models is given in Tables 2. It can be seen from Table 2 that the networks in Group I based on the streamflow and rainfall show relatively good performances. The R of ANN1, ANN2, ANN3 and ANN4 during the validation period are 0.875, 0.803, 0.865 and 0.911, respectively and the RMSE of them are 1725.214, 1869.65, 1892.65 and 1684.61 ton day<sup>-1</sup> respectively. ANN4, with the lowest RMSE and highest R, is identified as the best performing network of this group which is in bold type in the Table 2. The networks in Group II are based only on the streamflow. In this group, the RMSE and R of ANN5 during the validation period are 1685.6 ton day<sup>-1</sup> and 0.791, respectively but ANN8 shows a significant improvement, due to the inclusion of more information for the previous days, with an RMSE of 1653.73 ton day<sup>-1</sup> and an R of 0.895. ANN8 is selected as the best performing network of Group II which has been shown in bold type in the Table 2. It shows that in group I, ANN1 are close to ANN4. In Group II, as more previous information is used, the performances of the networks tend to increase during the calibration, testing and validation periods. It can be observed that the performance of both models is very close to each other, this means that the water discharge cover the effect of rainfall in suspended sediment yield process so it has not improved the performances of the models effectively. The MLR1 and MLR2 with RMSE values in the validation period 2280.95 and 2270.831 ton day<sup>-1</sup>, respectively overestimates the peaks. The SRC1 model with R value of 0.818 and RMSE of 1758.415 ton day<sup>-1</sup> in the validation period underestimates the suspended sediment load. When the performance of each neural network group was compared with the corresponding the MLR and SRC models, the best performing

network in each group was considered. The ANN4 models perform better than others because it has been established based on the major driving forces of suspended sediment load. When the suspended sediment load is very low, the MLR models predict negative values. Whereas the neural networks can generate reasonable estimation due to the nonlinear transformation process involved.

Table 2. Performances of ANN, MLR and SRC models for the Karehsang station

Model	Group: Inputs	Structure	Training		Testing		Validation	
			RMSE	R	RMSE	R	RMSE	R
ANN1	I: (P,Q) <sub>t</sub>	2-1-1	5743.507	0.82	4602.116	0.80	1725.214	0.87
ANN2	I: (P,Q) <sub>t</sub> , (P,Q) <sub>t-1</sub>	4-2-1	5501.64	0.84	4477.942	0.88	1869.650	0.80
ANN3	I: (P,Q) <sub>t</sub> , (P,Q) <sub>t-1</sub> , (P,Q) <sub>t-2</sub>	6-4-1	5008.75	0.86	4442.241	0.86	1892.243	0.86
<b>ANN4</b>	<b>I: (P,Q)<sub>t</sub>, (P,Q)<sub>t-1</sub>, (P,Q)<sub>t-2</sub>, (P,Q)<sub>t-3</sub></b>	<b>8-5-1</b>	<b>5331.544</b>	<b>0.84</b>	<b>4480.12</b>	<b>0.80</b>	<b>1684.610</b>	<b>0.91</b>
ANN5	II: Q <sub>t</sub>	1-1-1	5787.801	0.84	4589.476	0.82	1658.600	0.79
ANN6	II: Q <sub>t</sub> , Q <sub>t-1</sub>	2-3-1	5070.301	0.874	4455.832	0.88	1759.212	0.81
ANN7	II: Q <sub>t</sub> , Q <sub>t-1</sub> , Q <sub>t-2</sub>	3-2-1	4929.702	0.872	4553.424	0.88	1678.496	0.84
<b>ANN8</b>	<b>II: Q<sub>t</sub>, Q<sub>t-1</sub>, Q<sub>t-2</sub>, Q<sub>t-3</sub></b>	<b>4-3-1</b>	<b>4935.543</b>	<b>0.88</b>	<b>4544.253</b>	<b>0.88</b>	<b>1653.729</b>	<b>0.89</b>
MLR1	(P,Q) <sub>t</sub> , (P,Q) <sub>t-1</sub> , (P,Q) <sub>t-2</sub> , (P,Q) <sub>t-3</sub>		5399.345	0.83			2282.950	0.75
MLR2	Q <sub>t</sub> , Q <sub>t-1</sub> , Q <sub>t-2</sub> , Q <sub>t-3</sub>		5402.085	0.83			2270.831	0.75
SRC1	Q <sub>t</sub>		6034.808	0.79			1758.415	0.81

To summarize, the ANN models seem to be more adequate than the MLR and SRC in modelling suspended sediment. Suspended sediment estimation requires nonlinear mapping. The MLR and SRC models are not adequate in view of the complexity of the problem since it assumes linear relationship between logQ<sub>s</sub> and logQ<sub>w</sub> values. Such models require that the variables are normally distributed. It is evident from Table 1 that the streamflow and sediment data have scattered distribution (see C<sub>sx</sub> values in Table 1). The main advantages of using ANNs are their flexibility and ability to model nonlinear relationships. In general, the ANN model can be considered relatively superior to the MLR and SRC models. This observation can play a vital role in hydrological modelling studies where estimates of sediment values are not available. The performances of ANN4 and ANN8 models are very close to each other, this means that the water discharge cover the effect of rainfall in suspended sediment yield process so since the ANN4 is the best models to estimate the suspended sediment load. The best performing network is those with the information of the previous three days, suggesting that three days lag-effect exists between the climate inputs and sediment load which seems logical for the studied area.

### Conclusions

The performances of the ANN, MLR and SRC models for estimation of daily suspended sediment load by relating it to average rainfall and water discharge in Karehsang station were evaluated in terms of goodness-of-fit. The goodness-of-fit was examined by comparing the statistics of the results (RMSE and R). Based on the comparison results, the ANN model was found to perform better than the MLR and SRC models. It is demonstrated that ANN is capable of modeling the daily suspended sediment load with fairly good accuracy when

proper input variables and their lag effect on suspended sediment load are included. ANN can generate a better fit to the observed suspended sediment load than the multi linear regression models and the sediment rating curve model under the same data requirement. The most prominent feature of ANN is that it can provide more reasonable predictions for extremely high or low values, because of the distributed information processing system and the nonlinear transformation involved. It leads to the conclusion that we can use other techniques such as neuro-fuzzy to reach more accurate results.

### **References**

- Abrahart R.J., White S.M. (2001). Modelling sediment transfer in Malawe: comparing backpropagation neural network solution against a multiple linear regression benchmark using small data sets. *Physics and Chemistry of the Earth (B)*, 26:19–24.
- Ardiclioglu M., Kisi O., Haktanir T. (2007). Suspended sediment prediction by using two different feed-forward backpropagation algorithms. *Can J Civil Eng*, 34(1):1–6.
- Cigizoglu H.K. (2004). Estimation and forecasting of daily suspended sediment data by multi layer perceptrons. *Adv Water Resour*, 27:185–95.
- Cigizoglu H.K., Kisi O. (2006). Methods to improve the neural network performance in suspended sediment estimation. *J Hydro*, 317:221–38.
- Hagan M.T., Menhaj M.B. (1994). Training feed forward networks with the Marquardt algorithm. *IEEE Trans Neural Networks*, 6:861–867.
- Jain S.K. (2001). Development of integrated sediment rating curves using ANNs. *J Hydraul Eng ASCE*, 127(1):30–7.
- Kisi O. (2004). Multi-layer perceptrons with Levenberg–Marquardt optimization algorithm for suspended sediment concentration prediction and estimation. *Hydrol Sci J*, 49(6):1025–40.
- Kisi O. (2007). Streamflow forecasting using different artificial neural network algorithms. *J Hydraul Eng ASCE*, 133(5):532–9.
- Lippman R. (1987). An introduction to computing with neural nets. *IEEE ASSP Mag*, 4:4–22.
- McBean E.A., Al-Nassri S. (1988). Uncertainty in suspended sediment transport curves. *J Hydraul Eng ASCE*, 114(1):63–74.
- Müller B., Reinhardt J., Strickland M.T. (1995). *Neural Networks: an Introduction*. Springer-Verlag, New York.
- Singh V.P., Woolhiser D.A. (2002). Mathematical modeling of watershed hydrology. *J Hydraul Eng ASCE*, 128(7):270–292.
- Tayfur G. (2002). Artificial neural networks for sheet sediment transport. *Hydrol Sci J*, 47(6):879–92.
- Tayfur G., Guldal V. (2006). Artificial neural networks for estimating daily total suspended sediment in natural streams. *Nordic Hydrol*, 37:69–79.
- Zhu Y.-M., Lu X.X., Zhou Y. (2007). Suspended sediment flux modeling with artificial neural network: An example of the Longchuanjiang River in the Upper Yangtze Catchment, China. *Geomorphology*, 84:111–125.

## EFFECT OF NSP DEGRADING ENZYMES AND PREBIOTICS ON QUALITY AND TEXTURE PROFILE OF LAYING HEN'S EGGS

Saulius ALIJOSIUS<sup>1\*</sup>, Romas GRUZAUSKAS<sup>1</sup>, Vilma SASYTE<sup>1</sup>, Asta RACEVICIUTE-STUPELIENE<sup>1</sup>, Vilma VILIENE<sup>1</sup>, Agila DAUKSIENE<sup>1</sup>, Aldona MIEZELIENE<sup>2</sup>, Gitana ALENCIKIENE<sup>2</sup>, Guoda STANYTE<sup>1</sup>

<sup>1</sup>Institute of Animal Rearing Technologies, Lithuanian University of Health Sciences, Lithuania

<sup>2</sup>Laboratory of Sensory Science, Food institute of Kaunas University of Technology, Lithuania

\*Corresponding author: Saulius.Alijosius@lsmuni.lt

### Abstract

The trial was conducted to investigate the supplementation of NSP degrading enzymes, prebiotics and its combination on the laying hens' performance and quality of eggs. *Lohman Brown* laying hens aged 38 weeks were assigned to 4 dietary treatments for 8 weeks. The dietary treatments were: 1) control (C), 2) compound feed supplemented with enzymes (endo-1,4- $\beta$ -xylanase 22000 VU/g, endo-1,3(4)- $\beta$ -glucanase 30000 VU/g and endo-1,4 - $\beta$ -glucanase (cellulase) 6400 DNS units/g of feed) (E), 3) compound feed with prebiotics (mannanooligosaccharides (MOS) 1.0 kg/t of feed) (P), 4) compound feed with NSP degrading enzymes (endo-1,4- $\beta$ -xylanase 22000 VU/g, endo-1,3(4)- $\beta$ -glucanase 30000 VU/g, endo-1,4 - $\beta$ -glucanase (cellulase) 6400 DNS units/g of feed) and prebiotics (MOS 1.0 kg/t of feed) (EP). All laying hens were kept under the same conditions. Egg's quality was determined using automatic egg quality analyzer and thickness of eggshell was evaluated with electronic micrometer. The texture characteristics were determined with the universal texture analyzer Instron 3343. Instrumental colour measurements of eggs were performed using a spectrophotometer Konica Minolta. Egg weight of E group was increased by 6%, but feed conversion ratio to produce 1 kg of eggs was decreased by 11%, compared to C group ( $P < 0.05$ ). Enzymes and MOS did not significantly effect egg quality parameters, but in E group shell weight increased by 9% ( $P < 0.05$ ). In addition of enzymes, the hens had produced eggs with higher albumen L\* scores ( $P < 0.05$ ). Diet supplementation with enzymes had no significant effects on the yolk colour. In E group of laying hens, the egg mass and egg shell thickness were improved. The addition of enzymes and MOS mixture had highest positive effect on egg quality parameters, but had no statistically significant influence of egg's texture and colour.

**Keywords:** *mannanooligosaccharides, enzymes, laying hens, texture analysis.*

### Introduction

Egg shell quality and egg internal quality are of major importance to the egg industry worldwide. Egg internal quality is measured as yolk colour, the integrity of the perivitelline membrane, and albumen quality. Egg internal quality may be affected by storage; hen strain and age; induced moulting, nutrition, and disease. An understanding of the range of factors that affect egg internal quality is essential for the production of eggs of high quality (Roberts, 2004). Xylans are the principal NSP of grain, and high levels of wheat in poultry diets can increase the viscosity of the gut contents, which impedes the circulation and absorption of nutrients, causing reduced feed intake, body weight (BW) gain, and feed efficiency (Annison and Choct, 1991). Xylanases used extensively in grain-based diets to counteract the effects of

NSP in broiler (Bedford and Schulze, 1998). Prebiotics, non-digestible feed ingredients, have selective effects on the intestinal microflora. In the last decade, the use of mannanoligosaccharides (MOS) in poultry production has received increased attention due to its beneficial effects on poultry productivity. The MOS, derived from the cell wall of *Saccharomyces cerevisiae*, is neither hydrolysed by endogenous digestive enzymes nor absorbed by host, and it is considered as a prebiotic agent. It has been claimed that the benefits of MOS based on its specific properties, these properties have the potential to enhance growth rate, feed efficiency and liveability in commercial broiler and turkeys, and egg production in layers (Shane, 2001). Therefore, this study was performed to investigate the effects of probiotic and enzymes supplementation on hen's productivity (feed conversion ratio), egg quality and egg's texture profile.

### Materials and Methods

The feeding trial was performed on 40 laying hens of breed *Lohman Brown* the age of 38 weeks. During the feeding trial, laying hens were kept in individual cages (40 × 50 cm) in a four tiers battery with stationary drinking-bowl and feed box under the same feeding and keeping conditions. The hens were divided into 4 groups, 10 hens in each group. The laying hens were fed with 125 g compound feed per day. Laying hens of all groups were fed with standard compound feed (basal diet). Basal diet formulated to meet the nutrient and energy requirement for poultry (NRC, 1994). Hens in control group were fed with basal diet only (C group), E group was fed with basal diet + enzyme (endo-1,4-β-xylanase 22000 VU/g, endo-1,3(4)-β-glucanase 30000 VU/g and endo-1,4 -β-glucanase (cellulase) 6400 DNS units/g of feed), P group was fed with basal diet + prebiotic at a level of 1.0 g/kg and EP group was fed with basal diet + enzymes (endo-1,4-β-xylanase 22000 VU/g, endo-1,3(4)-β-glucanase 30000 VU/g and endo-1,4 -β-glucanase (cellulase) 6400 DNS units/g of feed) + prebiotic at a level of 1.0 g/kg. *Rovabio*<sup>®</sup> *Excel AP* enzyme mixture (containing mainly endo-1.4-β-xylanase, endo-1.3/1.4-β-glucanase and endo-1,4 -β-glucanase (cellulase)) used in this study was provided by Adisseo (France) and produced from *Penicillium cerevisiae*. *Agrimos*<sup>®</sup> (Lalleman Inc., France) is a specific combination of mannanoligosaccharides and glucose (β-glucans) extracted from the yeast cell walls of *Saccharomyces cerevisiae*. Housing and feeding conditions were the same for all groups and met the requirements of laying hens. Duration of the experiment was 8 weeks. During the feeding trial all the eggs were calculated and weighted every day, every 14 days was determined egg production capacity of laying hens, feed conversion ratio (FCR) to produce 1 kg of eggs. Egg weight, albumen high and Haugh unit were determined by multifunctional automatic egg characteristics analyzer „Robotmation (Japan) Egg Multi-Tester EMT-5200“, hardness of eggshell – by „Egg Shell Force Gauge MODEL-II“ device, and thickness of egg shell – by electronic micrometer „MITUTOYO Digimatic Micrometer“ (sharp and blunt ends, and equator). The egg shell index was calculated according Ahmed *et al.* (2005) as: SI (shell index) = (SW/S) × 100, where: SW = shell weight; S = shell surface (cm<sup>2</sup>) calculated as S = 4.68 × egg weight (EW)<sup>2/3</sup>. The eggs were stored at 4°C for 28 days before texture evaluation (10 eggs from each group). For preparation of the egg sample the modified Woodward and Cotterrill (1987) method was applied taking into account the remarks of Shafer *et al.* (1998) adjusted to the present conditions. The egg albumen was separated carefully from the yolk. The acquired samples of albumen and yolk were put into plastic cylindrical boxes designed for boiling. The contents were mixed lightly in order to eliminate air bubbles and after putting into special holding form it was boiled in water-bath for 12 minutes. Samples were removed from the water bath and allowed to cool to room temperature. Thereafter, they were refrigerated at 6°C for 40 min. The texture characteristics were determined with the universal texture analyzer

Instron 3343 (Instron Engineering Group, High Wycombe, UK) equipped with a 1kN load cell and Bluehill software. The samples, measuring  $2.0 \times 2.0 \times 2.0$  cm, were compressed perpendicularly using a 50 mm diameter cylindrical probe. The testing conditions were two consecutive cycles at 50% compression, cross-head movement at a constant speed of 1 mm/s. Texture variables (rigidity in Newtons, N), cohesiveness (ratio of positive area during second compression to that during the first compression), springiness and resilience (the energy required to mastificate a solid food product to prepare for swallowing) were calculated as described by Bourne *et al.* (1978). Instrumental colour measurements were performed using a spectrophotometer Konica Minolta, calibrated throughout the study using the reference illuminate C which is close to the average radiation daylight. The measurements were averaged and colour for each sample was expressed in terms of CIE  $L^*a^*b^*$  values for lightness ( $L^*$ ), redness ( $a^*$ ) and yellowness ( $b^*$ ).  $h^* = \arctan(b^*/a^*)$ ;  $C^* = ((a^*)^2 + (b^*)^2)^{1/2}$ . Statistical significance was established using one – way analysis of variance (ANOVA), and data were reported as a mean of standard deviation. Mean comparison and separation were done using Duncan's *t*-test ( $P < 0.05$ ). ANOVA were conducted using the statistical package SPSS 22.

### Results and Discussion

The effects of dietary treatments on laying performance parameters as egg weight, feed intake, feed conversion ratio (FCR) to produce 1 kg of eggs are shown in Table 1.

Table 1. The effect of feed supplementation of NSP degrading enzymes, prebiotics and its combination on the laying hens' (38-46 week) performance parameters

Studied character	Groups			
	C	E	P	EP
Average feed intake (g/hen/14 day)	1714.05±64.99 <sup>a</sup>	1694.61±68.34 <sup>a</sup>	1702.03±55.71 <sup>a</sup>	1698.40±75.11 <sup>a</sup>
Feed intake (g/egg)	147.05±21.76 <sup>a</sup>	138.92±22.18 <sup>a</sup>	140.35±20.42 <sup>a</sup>	137.75±15.45 <sup>a</sup>
Average egg-mass	63.68±5.22 <sup>a</sup>	67.71±4.60 <sup>b</sup>	64.78±4.26 <sup>ab</sup>	65.58±3.88 <sup>ab</sup>
Laying intensity (%)	84.8±10.76 <sup>a</sup>	88.9±12.17 <sup>a</sup>	88.2±11.39 <sup>a</sup>	89.1±9.85 <sup>a</sup>
Egg production (eggs/14 day/group)	11.88±1.51 <sup>a</sup>	12.45±1.70 <sup>a</sup>	12.35±1.59 <sup>a</sup>	12.48±1.38 <sup>a</sup>
Feed conversion ratio kg/kg	2.32±0.36 <sup>a</sup>	2.07±0.39 <sup>b</sup>	2.17±0.29 <sup>ab</sup>	2.10±0.21 <sup>ab</sup>

a, b For each row, mean values with the same subscripts are not significantly different,  $P < 0.05$

The addition of enzymes and mannanoligosaccharides hadn't effect on feed intake, egg production and laying intensity of laying hens in comparison to the group C. During 38–46 weeks of age in E group egg mass increased by 6%, but FCR to produce 1 kg of eggs decreased by 11% compared to C group ( $P < 0.05$ ). Shalaei *et al.* (2014) found, that MOS supplementation to the laying hens' diet significantly increased egg weight. Mirzaie *et al.* (2012) studies found that multi-enzymes and xylanase supplementation of laying hens improved egg production, egg mass and decreased the FCR. The results of egg quality are shown in Table 2. Enzymes and MOS did not significantly affect of egg quality parameters, but in E group increased shell weight 9% ( $P < 0.05$ ).



Table 2. The effect of feed supplementation of NSP degrading enzymes, prebiotics and its combination on the egg quality of laying hens (38-46 week)

Studied character	Groups			
	C	E	P	EP
Egg weight (g)	63.91±6.66 <sup>a</sup>	67.31±4.60 <sup>a</sup>	64.84±5.37 <sup>a</sup>	64.40±4.96 <sup>a</sup>
Shell breaking strength, kg/m <sup>2</sup>	3.30±0.74 <sup>a</sup>	3.34±0.96 <sup>a</sup>	3.41±0.62 <sup>a</sup>	3.49±0.65 <sup>a</sup>
Albumen height (mm)	6.75±1.47 <sup>a</sup>	6.95±1.47 <sup>a</sup>	6.51±1.36 <sup>a</sup>	7.09±0.98 <sup>a</sup>
Haugh units	79.58±12.34 <sup>a</sup>	79.28±11.97 <sup>a</sup>	77.67±10.60 <sup>a</sup>	81.47±8.33 <sup>a</sup>
Shell weight (g)	5.61±0.54 <sup>a</sup>	6.10±0.66 <sup>b</sup>	5.77±0.51 <sup>ab</sup>	5.73±0.52 <sup>ab</sup>
Shell thickness, mm	sharp end	0.35±0.04 <sup>a</sup>	0.36±0.03 <sup>a</sup>	0.35±0.02 <sup>a</sup>
	equator	0.35±0.04 <sup>a</sup>	0.37±0.03 <sup>a</sup>	0.35±0.03 <sup>a</sup>
	blunt end	0.34±0.04 <sup>a</sup>	0.36±0.03 <sup>a</sup>	0.35±0.03 <sup>a</sup>
Shell index (g/100 cm <sup>2</sup> )	7.74±0.80 <sup>a</sup>	8.10±0.73 <sup>a</sup>	7.87±0.66 <sup>a</sup>	7.84±0.55 <sup>a</sup>

a, b For each row, mean values with the same subscripts are not significantly different, P<0.05

These results are in agreement with Mirzaie *et al.* (2012) xylanase diet did not affect egg quality, Shahbazi (2012) studies found that diet enzyme supplementation decreased yolk index and egg shell thickness. Shalaei *et al.* (2014) found that egg quality parameters were higher of the laying hens that received the feed with MOS and MOS supplementation to the laying hen's diet significantly increased egg weight.

Table 3. Effect of enzymes and MOS supplementation to the diet on texture properties of fresh and stored eggs

Characteristic	Groups			
	C	E	P	EP
<b>0 Days</b>				
<b>Albumen</b>				
Rigidity	5.77±2.21 <sup>a</sup>	7.35±0.22 <sup>a</sup>	5.07±1.06 <sup>a</sup>	7.30±0.29 <sup>a</sup>
Cohesiveness	0.62±0.06 <sup>a</sup>	0.48±0.09 <sup>a</sup>	0.61±0.03 <sup>a</sup>	0.55±0.04 <sup>a</sup>
Springiness	7.43±1.02 <sup>a</sup>	7.73±0.02 <sup>a</sup>	6.78±0.20 <sup>a</sup>	7.55±0.26 <sup>a</sup>
Resilience	26.5±11.26 <sup>a</sup>	27.52±5.79 <sup>a</sup>	21.08±5.99 <sup>a</sup>	30.32±0.18 <sup>a</sup>
<b>Yolk</b>				
Rigidity	28.54±2.95 <sup>c</sup>	16.08±2.92 <sup>a</sup>	22.72±3.61 <sup>ab</sup>	25.36±1.36 <sup>b</sup>
Cohesiveness	0.51±0.02 <sup>a</sup>	0.45±0.00 <sup>a</sup>	0.49±0.01 <sup>a</sup>	0.48±0.01 <sup>a</sup>
Springiness	6.49±0.64 <sup>a</sup>	6.73±0.78 <sup>a</sup>	6.94±0.02 <sup>a</sup>	7.02±0.12 <sup>a</sup>
Resilience	93.26±4.43 <sup>a</sup>	49.48±15.04 <sup>a</sup>	77.83±10.69 <sup>a</sup>	86.00±1.95 <sup>a</sup>
<b>28 Days</b>				
<b>Albumen</b>				
Rigidity	5.91±0.72 <sup>a</sup>	10.6±0.71 <sup>d</sup>	10.53±0.08 <sup>c</sup>	7.74±0.05 <sup>b</sup>
Cohesiveness	0.48±0.05 <sup>a</sup>	0.43±0.08 <sup>a</sup>	0.49±0.00 <sup>a</sup>	0.51±0.10 <sup>a</sup>
Springiness	8.16±0.18 <sup>a</sup>	7.46±0.78 <sup>a</sup>	7.94±0.16 <sup>a</sup>	7.77±0.04 <sup>a</sup>
Resilience	23.42±4.57 <sup>a</sup>	34.6±12.29 <sup>a</sup>	40.74±1.18 <sup>a</sup>	30.85±5.79 <sup>a</sup>
<b>Yolk</b>				
Rigidity	22.8±8.50 <sup>a</sup>	18.57±3.00 <sup>a</sup>	16.98±4.55 <sup>a</sup>	16.30±2.11 <sup>a</sup>
Cohesiveness	0.52±0.06 <sup>a</sup>	0.49±0.07 <sup>a</sup>	0.56±0.02 <sup>a</sup>	0.54±0.01 <sup>a</sup>
Springiness	7.27±0.41 <sup>c</sup>	6.88±0.02 <sup>b</sup>	6.30±0.91 <sup>a</sup>	6.34±0.73 <sup>a</sup>
Resilience	83.95±17.37 <sup>a</sup>	63.49±19.24 <sup>a</sup>	61.84±26.87 <sup>a</sup>	56.46±14.52 <sup>a</sup>

a, b, c For each row, mean values with the same subscripts are not significantly different, P<0.05

The instrumental analysis of albumen texture of 28 days storage eggs showed (Table 3), that analysed samples according to the albumen rigidity can be divided into three statistically

different groups ( $P < 0.05$ ). After 28 days of storage yolk springiness was lower in experimental groups with enzymes and MOS in comparison to the C group ( $P < 0.05$ ). Yolk cohesiveness and resilience of all groups did not differ, and springiness depended on the feed composition. Albumen and yolk colour results of the colorimetric evaluation of the CIELAB values of  $L^*$ ,  $a^*$ , and  $b^*$  are shown in Table 4. Laying hens fed diets containing enzymes to produce eggs with higher  $L^*$  scores and the differences were significant. Enzyme supplementation had no significant effects on yolk colour. These results are in agreement with those of Mourão *et al.* (2006) who found that supplemental enzyme culture had no effect on egg yolk colour. These results were less evident than those observed by Çiftci *et al.* (2003), who reported a significant improvement in egg yolk colour in response to enzyme supplementation on triticale and wheat–triticale-based diets.

Table 4. Effect of enzyme and MOS supplementation on egg albumen and yolk colour of fresh and stored eggs

Characteristic	Groups			
	C	E	P	EP
<b>0 days</b>				
<b>Albumen</b>				
$L^*$	93.01±2.29 <sup>a</sup>	93.96±0.81 <sup>a</sup>	94.91±0.67 <sup>a</sup>	94.61±1.11 <sup>a</sup>
$a^*$	-5.36±0.43 <sup>a</sup>	-5.40±0.57 <sup>a</sup>	-1.80±1.89 <sup>a</sup>	-1.30±1.63 <sup>a</sup>
$b^*$	8.68±1.06 <sup>a</sup>	8.90±1.90 <sup>a</sup>	9.76±0.66 <sup>a</sup>	9.00±2.65 <sup>a</sup>
$h^*$	-1.01±0.07 <sup>a</sup>	-1.02±0.07 <sup>a</sup>	-0.38±1.25 <sup>a</sup>	-0.30±1.26 <sup>a</sup>
$C^*$	10.22±0.92 <sup>a</sup>	10.43±1.83 <sup>a</sup>	11.03±0.64 <sup>a</sup>	10.21±2.55 <sup>a</sup>
<b>Yolk</b>				
$L^*$	90.26±1.09 <sup>a</sup>	90.82±0.66 <sup>ab</sup>	91.92±0.23 <sup>bc</sup>	91.69±0.18 <sup>c</sup>
$a^*$	-6.87±0.92 <sup>a</sup>	-6.52±0.37 <sup>ab</sup>	-6.15±0.04 <sup>ab</sup>	-5.75±0.12 <sup>b</sup>
$b^*$	36.92±1.66 <sup>b</sup>	32.13±1.46 <sup>a</sup>	38.10±1.11 <sup>b</sup>	36.60±1.01 <sup>b</sup>
$h^*$	-1.39±0.03 <sup>ab</sup>	-1.37±0.02 <sup>b</sup>	-1.41±0.00 <sup>a</sup>	-1.42±0.00 <sup>a</sup>
$C^*$	37.56±1.60 <sup>b</sup>	32.79±1.36 <sup>a</sup>	38.60±1.09 <sup>b</sup>	37.05±1.01 <sup>b</sup>
<b>28 days</b>				
<b>Albumen</b>				
$L^*$	92.35±0.92 <sup>a</sup>	93.57±0.35 <sup>b</sup>	92.23±0.90 <sup>a</sup>	92.28±0.26 <sup>a</sup>
$a^*$	-5.75±0.15 <sup>b</sup>	-5.90±0.21 <sup>b</sup>	-5.80±0.25 <sup>b</sup>	-6.94±0.39 <sup>a</sup>
$b^*$	9.33±1.72 <sup>a</sup>	9.07±0.81 <sup>a</sup>	8.80±0.83 <sup>a</sup>	10.48±0.90 <sup>a</sup>
$h^*$	-1.01±0.10 <sup>a</sup>	-0.99±0.05 <sup>a</sup>	-0.99±0.04 <sup>a</sup>	-0.98±0.06 <sup>a</sup>
$C^*$	11.00±1.37 <sup>a</sup>	10.83±0.65 <sup>a</sup>	10.54±0.77 <sup>a</sup>	12.58±0.66 <sup>b</sup>
<b>Yolk</b>				
$L^*$	92.54±0.70 <sup>a</sup>	92.06±0.55 <sup>a</sup>	92.18±0.77 <sup>a</sup>	91.40±1.19 <sup>a</sup>
$a^*$	-6.26±0.42 <sup>a</sup>	-6.79±0.47 <sup>a</sup>	-2.42±7.33 <sup>a</sup>	-6.99±0.44 <sup>a</sup>
$b^*$	33.22±1.56 <sup>a</sup>	34.40±1.46 <sup>a</sup>	35.30±2.18 <sup>a</sup>	35.93±2.11 <sup>a</sup>
$h^*$	-1.38±0.01 <sup>a</sup>	-1.38±0.02 <sup>a</sup>	-0.46±1.61 <sup>a</sup>	-1.38±0.02 <sup>a</sup>
$C^*$	33.80±1.61 <sup>a</sup>	35.06±1.39 <sup>a</sup>	35.88±2.16 <sup>a</sup>	36.61±2.08 <sup>a</sup>

a, b, c For each row, mean values with the same subscripts are not significantly different,  $P < 0.05$

### Conclusions

Supplementation of enzymes and prebiotics to the diet of laying hens improved egg intensity as well as egg shell thickness and positive effect on egg's quality and no significant influence on egg's texture and colour. Supplementation of enzymes significant ( $P < 0.05$ ) reduced feed conversion ratio 11 % compared to control group.

## References

- Ahmed A.M.H., Rodriguez-Navarro A.B., Vidal M.L., Gautron J., Garcia-Ruiz J.M., Nys Y. (2005) Changes in eggshell mechanical properties, crystallographic texture and in matrix proteins induced by moult in hens. *British Poultry Science*. 46(3). p. 268-279.
- Annison G., Choct M. (1991) Anti-nutritive activities of cereal non-starch polysaccharides in broiler diets and strategies minimizing their effects. *World's Poultry Science Journal*. 47(3). p. 232-242.
- Bedford, M.R., Schulze H. (1998) Exogenous enzymes for pigs and poultry. *Nutrition Research Reviews* 11(1). p. 91-114.
- Bourne M.C., Kenny F.J., Barnard J. (1978) Computer-assisted readout of data from texture profile analysis curves. *Journal of Texture Studies*. 9(4). p. 481-494.
- Çiftçi I., Yenice E., Eleroglu H. (2003) Use of triticale alone and in combination with wheat or maize: Effects of diet type and enzyme supplementation on hen performance, egg quality, organ weights, intestinal viscosity and digestive system characteristics. *Animal Feed Science and Technology*. 105(1-4). p. 149-161.
- Mirzaie S., Zaghari M., Aminzadeh S., Shivazad M., Mateos G.G. (2012) Effects of wheat inclusion and xylanase supplementation of the diet on productive performance, nutrient retention, and endogenous intestinal enzyme activity of laying hens. *Poultry Science*. 91(2). p. 413-425.
- Mourão J.L., Ponte P.I.P., Prates J.A.M., Centeno M.S.J., Ferreira L.M.A., Soares M.A.C., Fontes C.M.G.A. (2006) Use of  $\beta$ -Glucanases and  $\beta$ -1,4-Xylanases to Supplement Diets Containing Alfalfa and Rye for Laying Hens: Effects on Bird Performance and Egg Quality. *Journal of Applied Poultry Research*. 15(2). p. 256-265.
- NRC. Nutrient Requirements of Poultry. 9<sup>th</sup> Rev. 1994. National Research Council, National Academy Press. Washington, DC, USA.
- Roberts J.R. (2004) Factors Affecting Egg Internal Quality and Egg Shell Quality in Laying Hens. *Journal of Poultry Science*. 41(3). p. 161-177
- Shafer D.J., Carey J.B., Prochaska J.F., Sams A.R. (1998) Dietary methionine intake effects on egg component yield, composition, functionality and texture profile analysis. *Poultry Science*. 1998. Vol. 77. p. 1056-1062.
- Shahbazi H.R. (2012) Dietary Inclusion of Guar Meal Supplemented by B-Mannanase II Evaluation Egg Quality Characteristics and Blood Parameters of Laying Hens. *Global Veterinaria*. 9(1). p. 67-72.
- Shalaei M., Hosseini S.M., Zergani E. (2014) Effect of different supplements on eggshell quality, some characteristics of gastrointestinal tract and performance of laying hens. *Veterinary Research Forum*. 5(4). p. 277-286.
- Shane S.M. (2001): Mannan oligosaccharides in poultry nutrition: mechanism and benefits. In: *Science and Technology in the Feed Industry*. Lyons T.P and Jacques K.A. (eds) Proceeding of Alltech's 17<sup>th</sup> Annual Symposium. Nottingham University Press, Nottingham, NG110AX, United Kingdom. p. 65-77.
- Woodward S.A., Cottrell O.J. (1987) Texture and Microstructure of cooked whole egg yolks and heat -formed gels of stirred egg yolk. *Journal of Food Science*. 52(1). p. 63-67

## CHEMICAL CHANGES IN LIPID AFTER HEAT TREATMENT FROM DIFFERENT MEAT TYPES

Mitre STOJANOVSKI\*, Anita ČAKAROVA, Dzulijana TOMOVSKA, Elena JOSHEVSKA, Gordana DIMITROVSKA

Faculty of Biotechnical Science, University St. "Kliment Ohridski", Bitola, Macedonia

\*Corresponding author: mitre.stojanovski@yahoo.com

### Abstract

The aim of this paper is to examine the fatty acid composition of the fat from pork and poultry meat before and after heat treatment. For the examination of chemical changes in fat lard, palm and sunflower oils have been used. The changes in weight of the meat before and after heat treatment are followed by measuring with an electronic scale. The contents of total and free fatty acids were assessed before and after heat treatment by gas chromatography. The average quality loss of pork meat after heat treatment was 39.16%, while in the poultry meat was 45.68%. After the heat treatment fatty acid composition from the pork and poultry meat fried in lard showed decreasing of the content of C18: 2n6s and increasing of C16: 0 and C18: 0. Regarding the fatty acid composition from the pork meat fried in sunflower oil, the content of C14:0, C16: 1, C17: 0, C18: 3n6 were decreasing while the content of C16:0, C18:0, C18: 1n9s, C18: 2n6s increased. C21:0 and C22:0 occurred at the fatty acid composition of the poultry meat fried in sunflower oil. When the pork meat was frying with the palm fat, the content of C14: 0 and C16: 0 decreased, while the content of C18:0, C18:1n9s and C18:2n6s increased. In poultry meat, it reduced C16: 0, C18: 3n3 and C18: 3n6, and increased C14: 0 and C18: 0.

**Keywords:** *pork, poultry, meat, fatty acid, heat treatment.*

### Introduction

Thermal processing of meat is regular action in cuisine and in the meat industry. The objective of thermal processing of meat is to prepare the meat for consuming and to increase its sustainability. One of the most applied and fastest ways of thermal processing of meat for consuming in households is frying. Soft, boneless pieces of meat from the shoulder part, the thigh, the loin and the neck, and from which the visible fat tissue was removed, are usually used for frying. Sunflower oil and lard are used in the households to fry meat, and lately the palm oil became very popular. During frying with less or more oil, sensory characteristics which are very alike to those formed during grilling or roasting, are formed in the meat. During frying of the meat with less or more oil, attractive chestnut brown color is being formed on its surface, while golden yellow to chestnut color is formed on the surface of the fat tissue. The chestnut brown color of the meat surface is consequence of Maillard reaction, which occurs during thermal processing.

During thermal processing – frying of meat, the temperature on the meat surface reaches 180-150°C (Rahelic *et al.*, 1980) and numerous physical and chemical reaction happen within the meat. As a result of the heat, the water evaporates from the meat, the fats are extruded and they leak into the frying pan.

Changes that occur in the oils, in which meat is fried in, are primarily a result of heat denaturation of fats, as well as a result of reaction between fats in the meat and soluble proteins.

### Materials and methods

Pork loin and poultry are used as material for work. The pork and poultry that are used for examination are purchased from trade network wherein they were cut down to size and shape as for frying. Thermal processing – frying of the meat is performed in laboratory, and lard, sunflower oil and palm oil are used for frying. The changes in meat weight were monitored by measuring meat before and after thermal processing with electronic weighing scale accurate to 0.1 g. Examination of changes in fatty acid composition of the fats is conducted before and after thermal processing. The analyses of changes in fatty acid composition of the fats are examined on a gas chromatograph in the laboratory of the Food Institute at the Faculty of Veterinary Medicine in Skopje. The obtained results from conducted examinations for changes that occur in meat and fats after thermal processing are processed according to SAS software and procedures (SAS, 2005).

### Results and discussion

Significant physical changes, which contribute to change of basic characteristics of meat and forming new sensory characteristics important to his quality, occur during thermal processing of meat. One of the basic changes which occur during thermal processing is weight loss – meat shrinkage. The weight loss of the meat which occurs after thermal processing could be seen best from data given in (Table 1).

Table 1 Changes in the weight loss of pork during thermal processing

Thermal process of fried	Weight loss of the meat	x	SD	CV	min.	max.
<b>Sunflower oil</b>	Before heat treatment (g)	92.40	6.62	7.16	82.00	102.00
	After heat treatment (g)	62.40	5.98	9.59	52.00	70.00
	Shrinkage (%)	32.60	2.33	7.15	31.00	37.00
<b>Lard</b>	Before heat treatment (g)	89.20	21.85	24.50	64.00	130.00
	After heat treatment (g)	52.80	13.06	24.73	36.00	76.00
	Shrinkage (%)	40.08	3.70	9.09	34.00	44.00
<b>Palm oil</b>	Before heat treatment (g)	93.60	9.99	10.67	82.00	106.00
	After heat treatment (g)	53.40	7.73	14.48	46.00	60.00
	Shrinkage (%)	44.80	1.72	3.84	43.00	48.00

As seen from the given data in Table 1, the average shrinkage after thermal processing of pork fried in sunflower oil is 32.62% the average shrinkage of pork fried in lard is 40.08% and of pork fried in palm oil is 44.80%. The meat shrinkage depends largely on physical composition of meat, age of the animal before slaughtering and the way of thermal processing. The weight losses of pork which occur after thermal processing are in relation to literature data indicated by a number of authors (Rahelic *et al.*, 1980). The results from performed examinations of changes in weight of animal meat which occur after frying in sunflower oil, lard and palm oil are presented in (Table 2).

Table 2 Changes in the weight loss of poultry during thermal processing

Thermal process of fried	Weight loss of the meat	x	SD	CV	min.	max.
<b>Sunflower oil</b>	Before heat treatment (g)	85.60	5.42	6.33	82.00	94.00
	After heat treatment (g)	55.20	5.74	10.40	48.00	64.00
	Shrinkage (%)	35.66	2.49	6.99	32.00	39.00
<b>Lard</b>	Before heat treatment (g)	84.80	8.06	9.50	70.00	94.00
	After heat treatment (g)	46.80	5.74	12.26	42.00	56.00
	Shrinkage (%)	44.00	8.36	19.01	34.00	55.00
<b>Palm oil</b>	Before heat treatment (g)	92.40	13.52	14.64	76.00	106.00
	After heat treatment (g)	57.40	10.15	17.68	44.00	66.00
	Shrinkage (%)	38.20	2.31	6.06	35.00	42.00

As seen from data presented in Table 2, the average waste during thermal processing of poultry by frying with sunflower oil is 35.667 %, by frying with lard is 44.00 % and by frying with palm oil is 38.20%. The obtained results in our examinations are in relation to the results stated by other authors. The meat shrinkage during thermal processing depends on the reached temperature in the centre of the product. The weight loss of meat will be as bigger as the temperature of oils in which the meat is thermally processed gets higher (Rohman, A. and Che Man, Y. B. 2009a ; Naz Shanina, *et al.*, 2005; Gunston, F.D. 2004). Significant changes of fatty acid composition occur after thermal processing of meat, which is caused by the temperature during thermal processing, as well as the interaction of fats and soluble proteins and the interaction of other meat substances and oils used for thermal processing – frying of meat, (Rashood, *et al.*, 1996; Marina, *et al.*, 2010; Marikkar *et al.*, 2011; Indrasti, *et al.*, 2010). The changes that occur during thermal processing of meat – frying with sunflower oil could be seen best from Table 3.

Table 3 Changes in the fatty acid content before and after heat treatment of pork and poultry meat - fried with sunflower oil

Fatty acid composition	Pork meat		Poultry meat	
	Before frying	After frying	Before frying	After frying
<b>C16:0</b>	11.08	12.34	10.58	11.57
<b>C16:1</b>		0.15	-	-
<b>C18:0</b>	3.33	3.91	3.49	3.58
<b>C18:1n9c</b>	45.43	46.08	45.42	45.51
<b>C18:2n6c</b>	40.16	37.52	40.06	38.80

Four fatty acids are identified in the sunflower oil before thermal processing, of which the following are most prevalent: C18:1n9c with 45.43 %, C18:2n6c with 40.16 %, C16:0 with 11.08 % and C18:0 with 3.33 %. After thermal processing of pork – frying, there are insignificant changes of the fatty acid composition of the sunflower oil; the amount of C18:2n6c has been decreased to 37.52%, and at the expense of it new fatty acid – C16:1, which accounts for 0.15% total fatty acids has been formed. The changes that occurred during frying of poultry in sunflower oil are identical to those changes that occur during frying of pork.

The changes that occurred during thermal processing – frying of pork and poultry with sunflower oil are not statistically significant. As seen from data presented in Table 4, a total of 10 fatty acids is identified in the lard, of which C18:1n9c is most prevalent with 40.04%,

followed by C16:0 with 34.59 %, C18:0 with 13.73%, C18:2n6c with 5.21 and other fatty acids which account for significantly smaller amount. After performed thermal processing of pork fried in lard there are no changes in the fatty acid composition, but however, there are insignificant changes in their content, which are not statistically significant.

Table 4 Changes in the fatty acid content before and after the heat treatment of pork and poultry meat - fried with lard

Fatty acid composition	Pork meat		Poultry meat	
	Before frying	After frying	Before frying	After frying
C14:0	1.63	1.31	1.22	1.43
C16:0	34.59	35.15	29.55	27.45
C16:1	3.13	2.35	2.36	2.79
C17:0	0.58	0.32	0.23	0.28
C17:1	0.34	0.17	0.15	0.23
C18:0	13.73	14.10	10.18	7.45
C18:1n9c	40.04	41.03	45.84	49.05
C18:2n6c	5.21	5.38	9.00	9.31
C18:3n6	0.30	0.19	0.39	0.45
C21:0	-	-	-	0.45
C18:3n3	0.50	-	0.45	0.86
C22:0	-	-	-	0.25

It is ascertained that two fatty acids are formed in poultry fried with lard, such as C21:0 in an amount of 0.45% and C22:0 in an amount of 0.25 %. During the thermal processing of the poultry, the content of C18:1n9c has increased from 45.84% to 49.05%, while C18:0 has decreased from 10.18% to 7.45%, C16:0 has also decreased from 29.55% to 27.45%. These changes are statistically significant at the level of ( $p < 0.5$ ).

The changes in the rest of the fatty acids are minimal and do not show statistically significant differences.

From data presented in Table 5 it could be noticed that the palm oil contains 5 fatty acids of which C16:0 is most prevalent, followed by C18:1n9c with 40.17 %, C18:2n6c with 4.90% , C18:0 with 3.22 % and C14:0 with 0.83 %.

Changes in the fatty acid content before and after the heat treatment of pork and poultry meat - fried in palm fat

Fatty acid composition	Pork meat		Poultry meat	
	Before frying	After frying	Before frying	After frying
C14:0	0.83	0.86	0.65	0.75
C16:0	50.88	47.27	46.15	44.43
C16:1		0.34	-	0.36
C18:0	3.22	3.99	3.21	3.25
C18:1n9c	40.17	41.64	44.40	44.77
C18:2n6c	4.90	5.90	4.06	6.21
C18:3n3	-	-	-	0.23
C18:3n6	-	-	-	0.21

After the performed thermal processing of pork fried with palm oil there are changes in the content of fatty acids. Thus, the content of C16:0 has been decreased from 50.88% to 47.27 %, while there is insignificant increase in other fatty acids. Total changes in the fatty acid

composition of palm oil before and after thermal processing of the pork do not show statistically significant differences.

During frying of poultry with palm oil there is minimal decrease of the content of C16:0 from 46.15 % to 44.43 %, and at the expense of it new fatty acids appear, such as C18:3n3 and C18:3n6, which are either result of denaturation changes which occurred in the palm oil during thermal processing of the meat, or extracted from poultry.

The changes which occur in fatty acid composition of fats after thermal processing of the meat are minimal and do not show statistical significance.

Most probably, the new fatty acids which appear in fats after thermal processing of the meat are either extracted from the meat or newly created fat acids from the existing ones, under influence of high temperature during thermal processing of the meat.

### **Conclusion**

Based on the investigations carried out on chemical changes that occur in fats after the heat treatment, the following conclusions can be made:

- The average shrinkage of the pork fried in lard is 32.60%, sunflower oil 40.08% and palm fat 44.80%;
- The average shrinkage during heat treatment of poultry meat in sunflower oil is 35.667%, lard 44.00% and palm fat 38.20%;
- After frying of the pork in sunflower oil, there is a new fatty acid C16:1 which is present in the total fatty acids with 0.15%;
- After frying of poultry in lard, there is an occurrence of C18:3n3 with a representation of 0.45% and C22:0 of 0.25%;
- After frying of pork in palm fat there is a new fatty acid C16:1 where its presence is 0.34% and in poultry meat 0.36%. In palm tree fat after heat treatment, in addition to C16:1, there is a C18:3n3 representation of 0.23% and C18:3n6 of 0.21%.

### **References**

- Gunston, F.D. 2004. *The Chemistry of Oils and Fats: Sources, Composition, Properties and Uses*. UK: Blackwell Publishing Ltd.
- Hauff, S. and Vetter, W. 2010. Creation and evaluation of a two-dimensional contour plot of fatty acid methyl esters after off-line coupling of reversed-phase HPLC and GC/EI-MS. *Analytical and Bioanalytical Chemistry* 396: 2695–2707.
- Indrasti, D., Che Man, Y.B., Mustafa, S. and Hashim, D.M. 2010. Lard detection based on fatty acids profile using comprehensive gas chromatography hyphenated with time-of-flight mass spectrometry. *Food Chemistry* 122: 1273 - 1277.
- Marikkar, J. M. N., Ng, S. L. and Che Man, Y. B. 2011. Composition and thermal analysis of lipids from prefried chicken nuggets. *Journal of the American Oil Chemists' Society* 88: 749–754.
- Marina, A.M., Che Man, Y.B. and Ismail, A. 2010. Use of the SAW sensor electronic nose for detecting the adulteration of virgin coconut oil with RBD palm kernel olein. *Journal of the American Oil Chemists' Society* 87: 263–270.
- Naz Shanina, R. Siddiqi, Rina Sheikh, S. Asad Sa Yeed, 2005. Deterioration of olive, corn and soybean oils due to air, light, heat and deepfrying, In: *Food Research International* 38, 127-134,
- Olsen, E., G. Vogt, D. Ekeberg, M. Sandbakk, J. Pettersen, A. Ntlsson, 2005. Analysis of the early stages of lipid oxidation in freeze-stored pork back fat and mechanically poultry



- meat, In: Journal Agricultural Food Chemistry, 53:2, 338- 348, <http://www.ncbi.nlm.nih.gov>
- Rashood, K. A., Shaaban, R. R. A., Moety, E. M. A. and Rauf, A. 1996. Triacylglycerols-profiling by high performance liquid chromatography: a tool for detection of pork fat in processed foods. *Journal of Liquid Chromatography* 18: 2661- 2661-2672.
- Rohman, A. and Che Man, Y. B. 2009a . Analysis of codliver oil adulteration using Fourier Transform Infrared (FTIR) spectroscopy. *Journal of the American Oil Chemists' Society* 86: 1149-1153.
- Rahelic, S. and Puac, S. 1980–1981. Fibre types in Longissimus dorsi from wild and highly selected pig breeds. *Meat Sci.* 5: 439–450
- Ramírez MR, Estévez M, Morcuende D, Cava R. 2004 Effect of the type of frying culinary fat on volatile compounds isolated in fried pork loin chops by using SPME-GC-MS. *J Agric Food Chem.* 15;52(25):7637-43

## THE APPLICABILITY OF SELECTED DIAGNOSTIC DEVICES FOR ENHANCING THE WELFARE OF FARMED FALLOW DEER DOES DURING THE REPRODUCTIVE PERIOD

Paweł JANISZEWSKI,<sup>1\*</sup> Justyna CILULKO-DOŁĘGA<sup>1</sup>, Katarzyna TAJCHMAN<sup>2</sup>, Marek BOGDASZEWSKI<sup>3</sup>

<sup>1</sup> Department of Fur-bearing Animal Breeding and Game Management, University of Warmia and Mazury in Olsztyn, Poland

<sup>2</sup> Department of Companion and Wildlife Animals, University of Life Sciences in Lublin, Poland

<sup>3</sup> Institute of Parasitology of the Polish Academy of Sciences, Research Station in Kosewo Górne, Poland

\*Corresponding author: janisz@uwm.edu.pl

### Abstract

In farmed fallow deer (*Dama dama*) behavioural changes associated with reproductive period are much more difficult to identify than in other domesticated animals. The aim of the study was to determine the applicability of selected devices and diagnostic and laboratory methods for oestrus and pregnancy detection in fallow deer does reared in farm conditions. The tested instruments were an electronic oestrus detector, a pregnancy detector and an ultrasound scanner. Blood progesterone levels were determined in the evaluated animals. Not all of the analysed methods of pregnancy detection were equally applicable in a fallow deer farm. The electronic oestrus detector was easy to use, however, animals had to be chased and captured for the tests, therefore, the device is not highly practical in commercial deer farms. The electronic pregnancy detector was the most useful tool for early detection of pregnancy in fallow deer. Its greatest advantages include considerable ease of use, instant results and relatively low cost. Ultrasonography was 100% effective in diagnosing late pregnancies. Pregnancy in fallow deer was most effectively confirmed by an ultrasound examination between day 50 and day 80 after fertilization when bones and cartilage were visible. The determination of progesterone levels in blood samples also delivered highly reliable results, but blood tests have to be performed after the spring equinox.

**Keywords:** *Deer farming, Dama dama, welfare, diagnostic devices*

### Introduction

The number of farms rearing selected cervid species, in particular red deer (*Cervus elaphus*) and fallow deer (*Dama dama*), has increased in the 20<sup>th</sup> century. The provision of high welfare standards in deer farms can be a challenging task due to cervids' specific biological needs, absence of behavioural patterns and low levels of domestication in comparison with livestock animals (Janiszewski *et al.*, 2016). In cervids, behavioural changes associated with oestrus are much more difficult to identify than in other domesticated animals, and they may be difficult to detect based on observation alone. Breeders may not be able to identify the symptoms of oestrus in farm enclosures occupied by female deer without bucks (Asher *et al.*, 2005; Cilulko *et al.* 2013; Mulley, 2007). The oestrus cycle does lasts 24-26 days and can be repeated up to 7 times, but the fertilization usually occurs during the first cycle. It is so important to detect it at the beginning of its duration. Fertilization success and parturition dates are also very important considerations in deer farms (Pollard and Stevens, 2003). In farms characterized by small (pens) enclosures, high stocking density and an insufficient number of hiding sites, many females are forced to give birth in a small common area. The

above can prevent the formation of health bonds between the mother and its offspring, and it can lead to the abandonment of calves (Asher et al. 1996). Breeders need the above information to prepare adequate facilities for fawning and offspring rearing and to maximize the animals' wellbeing. The objective of this study was to determine the applicability of selected diagnostic methods and devices for enhancing the welfare of farmed does during the reproductive period.

### Materials and methods

The study was conducted in a cervid farm at the Research Station of the Institute of Parasitology of the Polish Academy of Sciences in Kosewo Górne (north-east Poland). Around 300 fallow deer (*Dama dama*), 120 red deer (*Cervus elaphus*) and 90 sika deer (*Cervus nippon*) are raised in the farm each year. The farm has the required facilities and equipment (buildings, devices, etc.) for handling the stock and mechanically immobilizing individual animals.

The following diagnostic methods and devices were used in the study:

- Oestrus detector. Oestrus was detected in fallow deer does with the use of an electronic oestrus detector (Dramiński®, 2014) which measures the electrical resistance of vaginal mucus. Resistance is measured on a scale of 0 to 1990 units. The test was conducted twice on 8 November 2011 and 17 November 2011 on 6 does. The animals were immobilized in a mechanical crush during mucus collection. The procedure was performed based on the method described by Zink and Diehl (1984).

- Ultrasound pregnancy detector. Pregnancy was diagnosed with the use of an ultrasound pregnancy detector (Dramiński®, 2014). Fourteen does were tested on 20 March 2013, and 8 does were subjected to the test on 16 January 2013. Before the exam, the udder region was covered with vegetable oil to promote better contact between the ultrasonic probe and the skin and to facilitate the transmission of ultrasound waves.

- Ultrasound scanner. The ultrasound examination was performed with the use of the ANIMALprofil portable ultrasound scanner with a mechanical abdominal probe operating at 5.0 MHz frequency. During the exam, does were immobilized in a mechanical crush in a position which allowed access to the abdomen, according to the method described by Mulley *et al.* (1987). Ultrasound exams were performed three times on 30 March 2011, 21 December 2011 and 20 March 2012.

- Determination of blood progesterone levels. Blood was sampled from does on three dates: 18 April 2012 (25 does), 16 January 2013 (27 does) and 20 March 2013 (24 does). Blood samples were transported to the Analytical Laboratory of the Municipal Hospital in Olsztyn, and progesterone concentrations were determined by the ECLIA method in Roche Diagnostics COBAS e411 and COBAS 6000 analysers.

The measured data were analysed and presented in table format. They were compared with the results of previous studies conducted in cervid farms and the parameters determined in other farm animals.

### Results and discussion

#### Oestrus detector

Electrical resistance of vaginal mucus was measured twice with the use of an oestrus detector. The results are presented in Table 1.

Table 1. Electrical resistance of vaginal mucus measured with an oestrus detector

Doe No.	Electrical resistance of vaginal mucus (in units of resistance – 10 units = 1 ohm)	
	8 November 2011	17 November 2011
2	420	490
25A	370	380
27A	440	340
198	440	410
287	500	440
785	450	340

The results in Table 1 indicate that during the second test, electrical resistance of vaginal mucus increased in 2 does (2 and 25A) and decreased in 4 animals. A decrease in mucus resistance in the reproductive tract of fertile females could be indicative of the follicular phase of the oestrous cycle which directly precedes oestrus and ovulation (Rorie *et al.*, 2002). The tests performed in fallow deer does suggest that an electronic oestrus detector is not a highly practical solution for large cervid farms. To obtain reliable results that accurately predict the onset of ovulation, the test has to be performed at least twice a day during the reproductive period which lasts from several to more than 10 days (Bartlewski *et al.*, 1999; Dramiński, 2014; Dusza *et al.*, 1996). Before oestrus, the stress associated with immobilization can disrupt and delay ovulation by 2-3 weeks and, consequently, delay insemination (Asher and Wilson, 2011). Fallow deer does which were placed in smaller pens 8-12 hours before artificial insemination (24-48 hours before ovulation) were characterised by significantly lower fertilization rates. The above can be attributed to a stress-related increase in progesterone levels (Asher *et al.*, 1996). Animals kept in small and densely populated pens can also develop antagonistic behaviours (Blanc and Thériez, 1998; Matiello, 2009; Pollard and Littlejohn, 1996; Pollard and Stevens, 2003; Ceacero *et al.*, 2012). In this study, only several measurements were performed with the use of the electronic oestrus detector, and the resulting data do not support the formulation of far-reaching conclusions. Nevertheless, our experience has demonstrated that the applied device can be used to detect oestrus in fallow deer does. Tests which rely on measurements of electrical resistance of vaginal mucus to determine the optimal mating dates could be useful in small farms or zoos where animals are more accustomed to humans and when the timing of ovulation has to be accurately determined, including in protected species or conservation herds.

#### Pregnancy detector

Pregnancy detection is important in animal breeding because the resulting information is vital for the operations of a deer farm. Breeders rely on the results of pregnancy tests to manipulate the animals and change their distribution in pens to enhance the welfare of pregnant does and their offspring. None of the 14 does examined on 20 March 2012 (first exam) were diagnosed as pregnant with the ultrasound detector, although pregnancy was confirmed with the use of other diagnostic methods. During the second exam (16 January 2013), the ultrasound detector diagnosed pregnancy in all 8 does (Table 2). The first test produced negative results in all animals probably because it was conducted too late at a stage when the foetus occupied most of the uterus with very small amounts of amniotic fluid. Other possible reasons were the tester's insufficient experience and weak contact between the probe and the animals' skin. Blood progesterone levels were analysed on 20 March 2013 to confirm the diagnostic efficiency of the previous testing methods. Based on the results, pregnancy was ruled out in two females in the group that had been tested with the pregnancy detector. Those females could have been pregnant during the pregnancy detection test, however,

pregnancies could have been lost due to embryonic resorption or miscarriage by the time blood progesterone test was conducted. The false positive results of the pregnancy detection test could also be attributed to a measurement error where the ultrasound beam was directed towards a full bladder rather than the uterus with amniotic fluid (the ultrasound beam crossed a fluid-filled cavity). The diagnostic efficiency of the pregnancy detector can be estimated at 70% on the assumption that false positive results were due to a measurement error. However, loss of pregnancy cannot be ruled out in females with low progesterone levels at a later date, in particular in doe 40 C13 whose progesterone levels were determined at 1.94 ng/ml. If doe 40 C13 was still pregnant during the pregnancy detector test, the diagnostic effectiveness of this device in early stages of pregnancy can be estimated at 87.5%.

The results of this study indicate that the pregnancy detector is a useful tool for diagnosing early pregnancy in fallow deer does. Its greatest advantages include considerable ease of use, instant results and relatively low cost.

### Ultrasound scan

Ultrasound scans were performed three times. The first exam (30 March 2011) produced low-quality images which did not support reliable diagnosis of pregnancy. The second exam (21 December 2012) was performed on 7 does, and pregnancy was diagnosed in 3 animals. The obtained ultrasound scans (Fig. 1 a, b) were compared with published data (Scott and Asher, 2014) to determine that the examined animals were 30-35 days pregnant. The third exam (20 March 2012) was performed on 22 does, and pregnancy was ruled out in 5 females. Based on the results of blood progesterone tests performed on the same day, pregnancy was ruled out in 4 animals in the above group of 5 does (Table 2), which indicates that 80% of the animals were correctly diagnosed based on the results of the blood test. Pregnancy was confirmed in the remaining does, and foetal development was estimated at 90 days (Fig. 2a, b). The results of blood progesterone tests confirmed pregnancy in all does that were diagnosed as pregnant in the ultrasound exam. The diagnostic effectiveness of the ultrasound exam was 100% (Table 2).

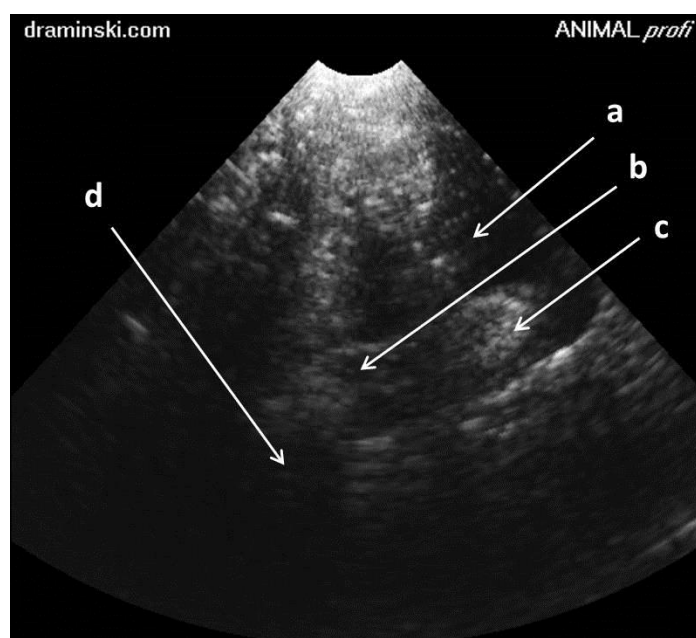


Figure 1 a. Ultrasound scan of a fallow deer doe at around 35 days of pregnancy: a - yolk sac; b - endometrial fold; c - placenta; d - embryo (phot. J. Cilulko-Dołęga)

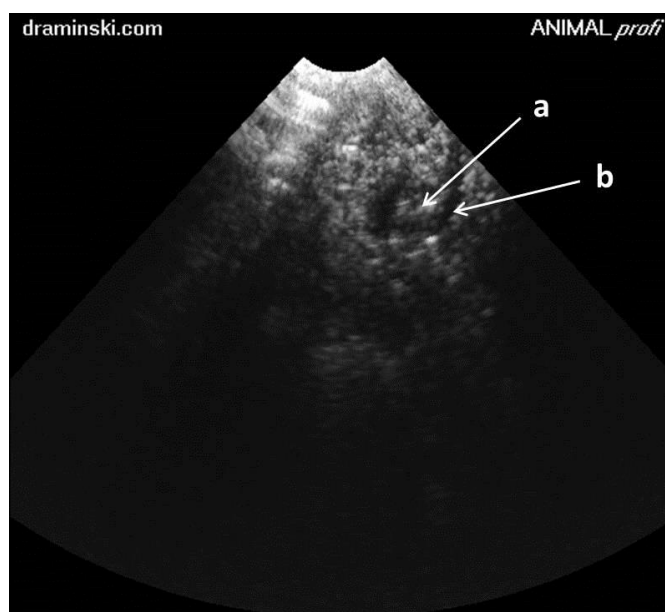


Figure 1 b. Ultrasound scan of a fallow deer doe at around 35 days of pregnancy: a – embryo; b - amniotic membrane (phot. J. Cilulko-Dołęga)

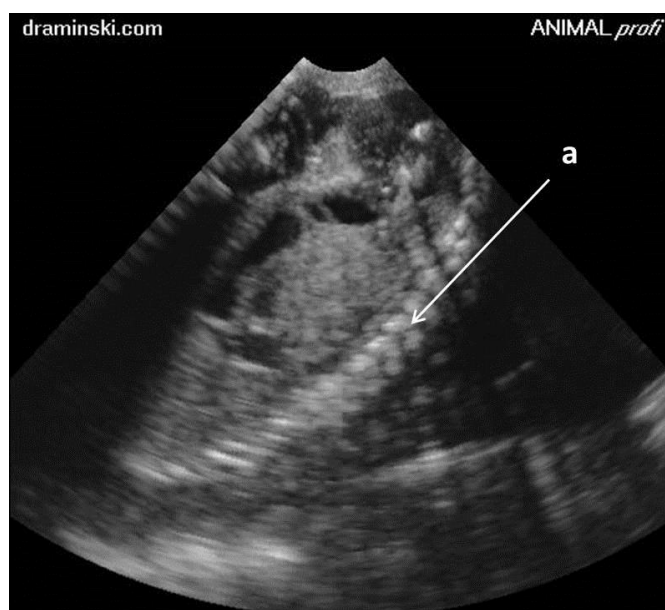


Figure 2a. Ultrasound scan of a fallow deer foetus at around 90 days with a visible spinal cord (a) (phot. J. Cilulko-Dołęga)

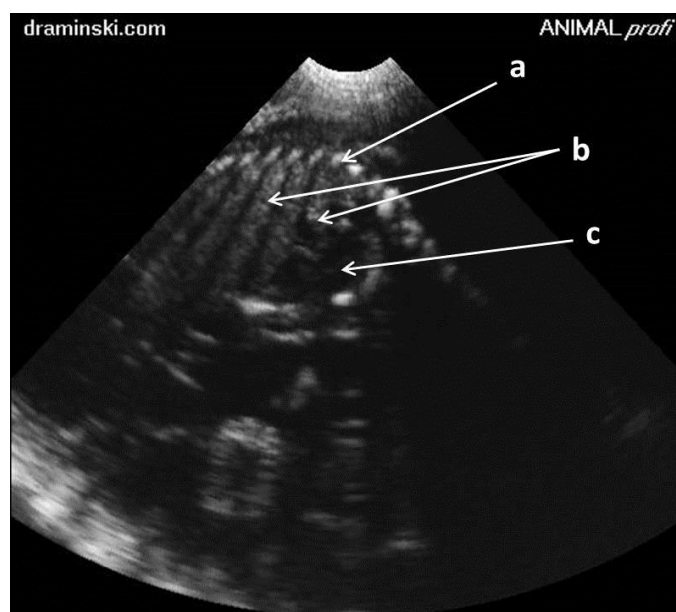


Figure 2b. Ultrasound scan of a fallow deer foetus at around 90 days: a - spinal cord; b – ribs; c - heart (phot. J. Cilulko-Dołęga)

The results of the study indicate that in fallow deer, pregnancy can be diagnosed by abdominal ultrasonography already 30-35 days after mating (Willard *et al.*, 1999). However, the diagnostic effectiveness of ultrasound scans is relatively low in very early stages of pregnancy. An ultrasound exam conducted around 90 days after fertilization was much more accurate, and a false negative result was noted in only one pregnant female. Our results and published findings suggest that pregnancy is most effectively confirmed by an ultrasound examination between day 50 and day 80 after fertilization when bones and cartilage are visible (Scott and Asher, 2014, Mulley, 2007; Revol and Wilson, 1991; Wilson and Haigh, 2007b). A pregnancy may be difficult to confirm or rule out in early stages of embryonic development (Scott and Asher, 2014; Savela *et al.*, 2009).

#### Progesterone levels

Blood samples for the determination of progesterone levels were collected three times. The first samples were collected (18 April 2014) to verify the results of the ultrasound exam. Four of the 25 examined does were diagnosed as non-pregnant based on their plasma progesterone levels which ranged from 0.03 to 0.69 ng/ml (Table 2).

In 2013, progesterone levels were determined on 16 January and 20 March. The results were used to validate the diagnosis of pregnancy made with the use of the pregnancy detector. On 16 January, progesterone concentration in 27 does ranged from 3.66 to 11.01 ng/ml and were determined at around 6 ng/ml in most animals (Table 2).

Progesterone levels higher than 6 ng/ml are indicative of pregnancy (Plotka *et al.*, 1977; Willard *et al.*, 1998; Shipka *et al.*, 2007). In view of the above, only 13 of the evaluated females could be diagnosed as pregnant. In does with lower progesterone levels, pregnancy could not be diagnosed or ruled out due to the possibility of repeated oestrus, a period during which progesterone concentrations increase.

On 20 March 2013, progesterone levels were measured in 24 fallow deer does and were determined in the range of 0.29 to 13.18 ng/ml (Table 2). The above results were clearly indicative of pregnancy because oestrus is not repeated in female fallow deer in March, therefore, elevated progesterone levels can be solely attributed to pregnancy (Wilson and Haigh, 2007b). Pregnancy was ruled out in 4 does with progesterone concentrations in the range of 0.29 to 1.94 ng/ml. Doe 40 C13 with progesterone level of 1.94 ng/ml probably lost

the pregnancy before the test, and high (in comparison with other non-pregnant females) progesterone levels could have been maintained for several weeks after embryonic death (Willard *et al.*, 1998). The above hypothesis was validated by the results of the pregnancy detector test also which also confirmed early pregnancy (16 January 2013). Females diagnosed as pregnant had progesterone levels in the range of 5.96 to 13.18 ng/ml.

In fallow deer does, progesterone concentrations increase from 6 ng/ml on pregnancy day 19 to around 15 ng/ml on pregnancy day 86. Unfertilized does which repeat the oestrous cycle have progesterone levels of 0 to around 6 ng/ml (Plotka *et al.*, 1977; Wilard *et al.*, 1998; Shipka *et al.*, 2007). After the spring equinox, which takes place on 20/21 March in Poland, the oestrous cycle ceases in cervids, and non-pregnant females have very low blood progesterone levels. During that period, pregnancy can be reliably confirmed or ruled out based on the results of a single blood test without the need for other diagnostic procedures (Wilson and Haigh, 2007b). Progesterone concentrations in the remaining does diagnosed as pregnant ranged from 6.62 to 13.32 ng/ml.

In cervid farms, the losses generated by non-productive animals can be minimized by diagnosing pregnancy at an early stage and identifying and eliminating non-pregnant females from the herd. According to Bazer *et al.* (2007), the annual upkeep cost per one non-pregnant ewe is equivalent to the profit generated by 6-7 females that had offspring. In cervid farms, early detection of pregnancy also delivers non-financial benefits. Pregnant does can be grouped in separated facilities and fed appropriate diets (Asher, 2003). Optimal nutrition, stocking density, organization of pens and optimal herd management practices enhance animal welfare and increase fertility rates, birth rates and fawn survival rates (Asher *et al.*, 2005; Audigé *et al.*, 1998; Audigé *et al.*, 1999a; Audigé *et al.*, 1999b; Audigé *et al.*, 2000; Birgersson and Ekvall, 1997; Carrión *et al.*, 2008; Mulley, 2007; Pollard and Stevens, 2003; Tuckwell, 2003; Wilson and Haigh, 2007a). By monitoring foetal development, breeders can estimate parturition dates and group does with similar calving dates. Calves born later in the same season have greater chances of healthy development and survival. In farms with a rotational grazing system, the division into groups ensures that animals can be safely grazed and moved to another paddock (after the postpartum period) without the risk of leaving fawns hidden in grass (Scott and Asher, 2014).

Table 2. The results of ultrasound scans, pregnancy detection tests and blood progesterone tests on different days of the experiment

No.	Doe number	USG (+/-) 20 March 2012	Progesterone (+/-) 18 April 2012	Pregnancy detection (+/-) 16 January 2013	Progesterone (ng/ml) 16 January 2013	Progesterone (ng/ml) 20 March 2013
1	123	(-)	8.76 (+)	N/A	3.66 (-)	N/A
2	11 202	(+)	9.08 (+)	(+)	5.38 (-)	9.89 (+)
3	9 293	(-)	10.74 (+)	N/A	9.29 (+)	7.06 (+)
4	287	(+)	N/A	N/A	6.74 (+)	N/A
5	785 BB	(+)	6.62 (+)	N/A	7.92 (+)	10.07 (+)
6	1 V10	(+)	10.61 (+)	N/A	5.84 (-)	0.51 (-)
7	6 587	(+)	11.69 (+)	N/A	4.92 (-)	8.37 (+)
8	33 U45	(+)	8.99 (+)	(+)	8.49 (+)	8.51 (+)
9	2	(-)	11.30 (+)	N/A	4.61 (-)	N/A
10	4 01A	(+)	9.23 (+)	N/A	7.90 (+)	N/A
11	10 279	(+)	11.80 (+)	N/A	11.01 (+)	11.90 (+)
12	31 F30	(+)	11.47 (+)	N/A	5.18 (-)	9.62 (+)



13	25A BB	(+)	9.52 (+)	(+)	6.39 (+)	13.18 (+)
14	40 C13	(-)	N/A	(+)	5.13 (-)	1.94 (-)
15	20 786	(+)	9.25 (+)	N/A	6.55 (+)	6.77 (+)
16	14 282	(+)	7.93 (+)	(+)	5.61 (-)	11.68 (+)
17	21 273	(+)	11.51 (+)	N/A	4.72 (-)	10.14 (+)
18	3 605	(+)	12.03 (+)	(+)	6.29 (+)	10.70 (+)
19	27A BB	(+)	13.32 (+)	N/A	7.56 (+)	11.23 (+)
20	42 C25	(+)	N/A	N/A	6.37 (+)	0.46 (-)
21	22 T06	(+)	10.64 (+)	(+)	5.93 (-)	5.99 (+)
22	19 V21	(+)	0.23 (-)	N/A	6.12 (+)	8.38 (+)
23	15 200	(+)	9.46 (+)	N/A	6.82 (+)	8.27 (+)
24	198 BB	(+)	7.78 (+)	N/A	4.89 (-)	6.84 (+)
25	5 600	(-)	0.69 (-)	N/A	5.53 (-)	7.36 (+)
26	18 28A	N/A	0.03 (-)	N/A	6.92 (+)	5.96 (+)
27	17 23A	N/A	9.58 (+)	N/A	3.94 (-)	8.28 (+)
28	30 H07	N/A	0.54 (-)	(+)	N/A	0.29 (-)

(+/-) – positive result or negative result in a given test

N/A - data not available

### Conclusions

The results of this study indicate that the tested diagnostic methods and devices enhance the welfare of farmed fallow deer during the reproductive season, pregnancy, parturition and offspring rearing. In the study, oestrus and pregnancy were diagnosed with the use of an electronic oestrus detector, a pregnancy detector, an ultrasound scanner and blood progesterone tests. The pregnancy detector seems to be the most convenient device for fallow deer farms. The oestrus detector is suitable for determining ovulation dates in small herds. Ultrasound scans of the abdominal region effectively detect pregnancy in fallow deer does already 30-35 days after mating.

### References

- Asher G. (2003). Scanning a valuable tool, but use a reputable operator. *Popular Deer Industry News*, vol. 4, pp. 16-17.
- Asher G.W., Fisher M.W., Fennessy P.F. (1996). Environmental constraints on reproductive performance of farmed red deer. *Animal Reproduction Science*, vol. 42, pp.35-44.
- Asher G.W., Mulley R.C., O'Neill K.T., Scott I.C., Jopson N.B., Littlejohn R.P. (2005). Influence of level nutrition during late pregnancy on reproductive productivity of red deer. I. Adult and primiparus hinds gestating red deer calves. *Animal Reproduction Science*, vol. 86, pp. 261-283.
- Asher G.W., Wilson P.R. (2011). Reproductive productivity of farmed red deer: a review. *Proceedings of the Deer Branch of the New Zealand Veterinary Association*, vol. 28, pp. 23-29.
- Audigé L., Wilson P.R., Morris R.S. (1998). A body condition score system and its use for farmed red deer hinds. *New Zealand Journal of Agricultural Research*, vol. 41, pp. 545-553.
- Audigé L.J.M, Wilson P.R., Pfeiffer D.U., Morris R.S. (1999a). Reproductive performance of farmed red deer (*Cervus elaphus*) in New Zeland: II. Risk factors for adult hind conception. *Preventive Veterinary Medicine*, vol. 40, pp. 33-51.

- Audigé L.J.M., Wilson P.R., Morris R.S. (1999b). Reproductive performance of farmed red deer (*Cervus elaphus*) in New Zealand: III. Risk factors for yearling hind conception. *Preventive Veterinary Medicine*, vol. 40, pp. 53-65.
- Audigé L.J.M., Wilson P.R., Morris R.S. (2000). Reproductive performance of farmed red deer (*Cervus elaphus*) in New Zealand: V. Mob and individual-hind risk factors associated with calf rearing to weaning. *Preventive Veterinary Medicine*, vol. 44, pp. 189-204.
- Bartlewski P.M., Beard A.P., Rawlings N.C. (1999). The relationship between vaginal mucous impedance and serum concentrations of estradiol and progesterone throughout the sheep estrous cycle. *Theriogenology*, vol. 51, pp. 813–827.
- Bazer F., Cunningham W., Marsh D. (2007). *Pregnancy Diagnosis in: Current Therapy in Large Animal Theriogenology* 2 ed. Saunders Elsevier. St. Louis, pp. 661-666.
- Birgersson B. i Ekvall K. (1997). Early growth in male and female fallow deer fawns. *Behavioral Ecology*, vol. 8 (5), pp. 493-499.
- Blanc F., Thériez M. (1998). Effects of stocking density on the behavior and growth of farmed red deer hinds. *Applied Animal Behaviour Science*, vol. 56, pp. 297-307.
- Cilulko J., Janiszewski P., Bogdaszewski M., Szczygielska E. (2013). Infrared thermal imaging in studies of wild animals. *European Journal of Wildlife Research*, vol. 59, pp. 17–23.
- Ceacero F, García AJ, Landete-Castillejos T, Bartošová J, Bartoš L, Gallego L. (2012). Benefits for dominant red deer hinds under a competitive feeding system: food access behavior, diet and nutrient selection. *PLoS ONE*, vol. 7(3), e32780.
- Carrión D., García A.J., Gaspar-López E., Landete-Castillejos T., Gallego L. (2008). Development of body condition in hinds of Iberian red deer during gestation and its effects on calf birth weight and milk production. *Journal of Experimental Zoology*, vol. 309A, pp. 1–10.
- Dramiński® (2014). The manufacturer of medical and veterinary ultrasounds, and other electronic devices for agriculture (web page: [www.draminski.pl](http://www.draminski.pl)).
- Dusza L., Opalka M., Kamińska B., Kamiński T., Ciereszko R. E. (1996). The relationship between electrical resistance of vaginal mucus and plasma hormonal parameters during periestrus in sows. *Theriogenology*, vol. 45, pp.1491-1503.
- Janiszewski P., Bogdaszewski M., Murawska D., Tajchman K. 2016. Welfare of Farmed Deer – practical aspects. *Polish Journal of Natural Sciences*, vol. 31(3), pp. 345-361.
- Mattiello S. (2009). Welfare issues of modern deer farming. *Italian Journal of Animal Science*, vol. 8 (Suppl.1), pp. 205-217.
- Mulley R.C. (2007). Reproductive Management of Fallow Deer, in: *Current Therapy in Large Animal Theriogenology* 2 ed. Saunders Elsevier. St. Louis, pp. 952-965.
- Mulley R., English A.W., Rawlinson R.J., Chapple R.S. (1987). Pregnancy diagnosis of fallow deer by ultrasonography. *Australian Veterinary Journal Aug.*, vol. 64(8), pp. 257-258.
- Plotka E.D., Seal U.S., Verme L.J., Ozoga J.J. (1977). Reproductive Steroids in the White-Tailed Deer (*Odocoileus virginianus borealis*). II. Progesterone and estrogen levels in Peripheral Plasma During Pregnancy. *Biology of Reproduction*, vol. 17, pp. 78-83.
- Pollard J.C., Littlejohn R.P. (1996). The effects of pen size on the behavior of farmed red deer stags confined in yards. *Applied Animal Behaviour Science*, vol. 47, pp. 247-253.
- Pollard J.C., Stevens D.R. (2003). Some production outcomes when management practices and deer behaviour interact. *Deer Nutrition Symposium: The nutrition and management of deer on grazing systems Proceedings of a New Zealand Grassland Association Inc Symposium held at Lincoln University, New Zealand, 8-9 November 2002*, pp. 73-77.

- Revol B., Wilson P.R. (1991). Foetal ageing in farmed red deer using real-time ultrasonography. *Animal Reproduction Science*, vol. 25(3), pp. 241-253
- Rorie R.W., Bilby T.R., Lester T.D. (2002). Application of electronic estrus detection technologies to reproductive management of cattle. *Theriology*, vol. 57, pp. 137–148.
- Savela H., Vahtiala S., Lindeberg H., Dahl E., Ropstad E., Beckers J.F., Saarela S. (2009). Comparison of accuracy of ultrasonography, progesterone, and pregnancy-associated glycoprotein tests for pregnancy diagnosis in semidomesticated reindeer. *Theriology*, vol. 72, pp. 1229-1236.
- Scott I. i Asher G. (2014). *Foetal Ageing of Farmed Red Deer: A Manual for Scanning Operators*. DEEResearch, pp. 1-30.
- Shipka M.P., Rowell J.E., Sousa M.C. (2007). Steroid hormone secretion during the ovulatory cycle and pregnancy in farmed Alaskan reindeer. *Journal of Animal Science*, vol. 85, pp. 944-951.
- Tuckwell C. (2003). *The Deer Farming Handbook of Rural Industries Research and Development Corporation*. Gawler, South Australia
- Willard S.T., Sasser R.G., Jaques J.T., White D.R., Neuendorff D.A., Randel R.D. (1998). Early pregnancy detection and the hormonal characterization of embryonic-fetal mortality in fallow deer (*Dama dama*). *Theriology*, vol. 49, pp. 861-869.
- Willard S.T., Petty S.J., Sasser R.G., White D.L., Randel R.D. (1999). Pregnancy detection and the effects of age, body weight, and previous reproductive performance on pregnancy status and weaning rates of farmed fallow deer (*Dama dama*). *Journal of Animal Science*, vol. 77, pp. 32–38.
- Wilson P.R., Haigh J.C. (2007a). Reproductive Management of Farmed Red Deer and Wapiti in: *Current Therapy in Large Animal Theriology* 2 ed. Sanders Elsevier. St. Louis, pp. 943-952.
- Wilson P.R., Haigh J.C. (2007b). Pregnancy Determination and Fetal Aging of Farmed Red Deer, Wapiti, and Bison in: *Current Therapy in Large Animal Theriology* 2 ed. Sanders Elsevier. St. Louis, pp. 1012-1014.
- Zink M.F., Diehl J.R. (1984). Efficacy of Using Vaginal Conductivity as an Indicator of the Optimum Time to Breed in Swine. *Journal of Animal Science*, vol. 59, pp. 869-874.

## **THE EFFECT OF ESTRUS SYNCHRONIZATION ON SHEEP FERTILITY AND FATTENING**

Biljana ANĐELIĆ<sup>1\*</sup>, Dejan GAVRILOVIĆ<sup>2</sup>, Marijana GAVRILOVIĆ<sup>3</sup>, Aleksandra JEVTIĆ<sup>4</sup>, Aleksandar JEVTIĆ<sup>5</sup>

<sup>1</sup>Faculty of Agriculture Čačak, University of Kragujevac, Serbia

<sup>2</sup>Faculty of biofarming Bačka Topola, University of Belgrade, Serbia

<sup>3</sup>High school of chemistry and technology in Kruševac, Serbia

<sup>4</sup>High agricultural food school Prokuplje, Serbia

<sup>5</sup>Public utility company Vrnjačka Banja, Serbia

\*Corresponding author: biljana.nedeljkovic83@gmail.com

### **Abstract**

The main goal of this paper was to experimentally determine the effect of estrus synchronization on the percentage of fertility and fattening performance of lambs in a specific period. The percentage of fertility in sheep synchronization was 74% and 100% in the control group. 53.83% of male and 46.15% of female lambs were obtained. The average body weight of all lambs at birth was 3.48 kg, and the differences between the groups were not statistically significant ( $P > 0.05$ ), it was 11.29 kg in 30 days of age and 20.64 kg for 90 days old lambs. Differences in lambs weight between gender and type of birth are very significant ( $P < 0.001$ ), while among the groups they are not statistically significant ( $P < 0.01$ ). The average daily growth of lambs in fattening 6 to 8 months old was 180g, and the estrus synchronization did not have any effect on the production traits.

**Key words:** sheep, estrus synchronization, fertility, fattening.

### **Introduction**

Compared to other branches of animal husbandry, sheep husbandry is considered highly important, although it does not hold great significance from the economical perspective.

The main characteristic of sheep is their capability to live in harsh climatic conditions, on poor natural pastures, at hilly terrains and salty soils. Sheep utilize very well wealthy pasturages on cultivated, high yield pastures in plans, as well as secondary production crops and processing industries (raw and dried loaf noodles, molasses, beer by products, etc.). Cabbage nutrients in sheep nutrition are represented by about 90%, which distinguishes them from other species of domestic animals. With the aim of intensifying sheep production and organizing technological processes, scientific attempts have been made to manage the sheep breeding process more efficiently. In many countries, methods of synchronization of sheep estrus are used to control the reproductive properties of sheep. This process achieves a full drive during and after the mating season in order to carry out fertilization and year as many sheep in a short period of time. This method allows sheep to year twice or more in two years. The main goal of this paper was to experimentally determine the effect of estrus synchronization on the percentage of fertility and fattening performance of the lamb in specific period. The results of these surveys could represent the significant contribution to zoo-technical theory, given the very scarce literature in the field of sheep farming. The results obtained will enable a more complete overview of the production and reproductive possibilities of sheep breeding, which would make a significant contribution to further breeding selection work.

## **Materials and Methods**

The study of the effect of estrus synchronization on fertility and fattening performance of sheep was carried out at a private farm in Krusevac. The farm's capacity was 100 sheep with offspring. The tests were carried out in cooperation with the Veterinary Specialist Institute in Kraljevo.

Sixty healthy, normally nourished, tended sheep of Pirot breed were selected for the study. Before introducing the sheep to the experiment, they were subjected to a detailed veterinary examination. It was noted that sheep were in good health and physical condition. Two groups of sheep were formed, the experimental group (n = 30) and the control group (n = 30). In the experimental group, the estrus synchronization method was applied, and the control group was kept according to the standard farming method where the seasonal character of the fertilization was applied. With controlled fertilization, which is done through the synchronization of estrus, there is the possibility of sheep yeanning three times in two years period, or every eight months.

Synthesis of estrus was done in 2014. For the synchronization and induction of estrus, the technique of intra vaginal sponges with gestagens (*Veramix, Pharmacia & Upjohn, Belgium*) was applied. Natural mating was carried out in the period November-December 2014. The mating was conducted between Pirot breed sheep and Virtemberg breed rams.

Determination of production results, body weight and daily increment, was performed separately and collectively for both groups. The body weight of newly born lambs, body weight of 30 days old lambs, body weight of lambs 90 days of age, frequency of occurrence of body weight of 180 days of age and daily increase of 90 days and 6-8 months old lambs were measured. The average body weight was determined by individual measurement of lambs and the total weight distribution divided by number of lambs. The average daily lamb increment was calculated by dividing the total increase with the number of feeding days with deducted birth weights. Services of the Agronomy Faculty in Cacak were used for the procession of these data. Statistical and variation parameters for the analysis of the obtained data were calculated.

The analysis of the obtained data from the test in this study was carried out using the usual methods of variation statistics.

In the first part of the statistical analysis, the parameters of descriptive statistics for all product characteristics were calculated. Significance of differences in the distribution of production characteristics by yeanning were calculated using the analysis of variance. Individual tests were performed by the LSD test. The parameters of descriptive statistics compute: arithmetic mean, standard deviation, standard error of arithmetic mean, variation coefficient, variation interval, and variance analysis.

## **Results and Discussion**

The results of the study, in accordance with the applied method of work, have been presented and considered in four parts: sheep fertility, production characteristics, and daily lamb growth.

Sheep fertility is a breed feature that can be improved through selection and selection of twins, provided that improved nutrition and care conditions are given.

Lamb weight is defined by genetic and para-genetic factors, among which the most important are the breed, gender, type of birth, mother's age, and lamb's nutrition.

Table 1. shows the weight of lambs at birth and their variability depending on the group, gender, and type of lamb birth.

In Table 1., the absolute, relative, cumulative and relative-cumulative frequency of appearance of lambs' body weight at birth of the experimental group are shown. Border classes ranged from 2.4 to 3.8 kg, with a variation range of 1.4 kg. The largest number of samples (20.00%) had a percentage of body weight of lambs at birth ranging from 3.5 to 3.6 kg, with a mean value of 3.55 kg and a relative cumulative frequency of 49.99%. Eight heads or 26.66%, were concentrated at the mean value (= 3.48), indicating that the values of body weight of the lambs at the birth significantly varied. It should be emphasized that 6.66% of the samples had a mass range of 2.4 to 3.0 kg, 13.33% of the samples had a weight of 3.0 to 3.4 kg, and 80.00% of the samples from 3.4 to 3.8 kg.

Table 1. Frequency of appearance of weight of lambs at birth (for experimental group)

Class borders	Class mean value	Frequency of appearance			
		Absolute	Cumulative	Relative %	Relative-cumulative %
2.4-2.5	2.45	1	1	3.333	3.333
2.5-2.6	2.55	1	2	3.333	6.666
2.6-2.7	2.65	-	-	-	-
2.7-2.8	2.75	-	-	-	-
2.8-2.9	2.85	-	-	-	-
2.9-3.0	2.95	-	-	-	-
3.0-3.1	3.05	1	3	3.333	9.999
3.1-3.2	3.15	-	-	-	-
3.2-3.3	3.25	3	6	10.000	19.999
3.3-3.4	3.35	-	-	-	-
3.4-3.5	3.45	3	9	10.000	29.999
3.5-3.6	3.55	6	15	20.000	49.999
3.6-3.7	3.65	5	20	16.660	66.665
3.7-3.8	3.75	5	25	16.666	83.331
3.8-3.9	3.85	5	30	16.666	100.000

### Weight of 30 days old lambs

Table 2. gives the body weight of lambs 30 days old and their variability depending on group, gender and type of lamb birth.

The average body weight of 30 days old lambs of the experimental and control group is 11.29 kg. The lowest average weight of female lambs of the experimental group is 10.73 kg, with variations from 9.5 to 12 kg. The highest body weight is in the male lambs of the control group (11.88 kg), with variations from 11 to 12.5 kg. Differences in body weight of lambs 30 days old in groups are statistically insignificant ( $P > 0.05$ ).

Weight of lambs 30 days old were higher in males than in female lambs, and in single born larger than in twins and triplets. Experimental group female lambs weighed 11.03 kg and were heavier than twins (by 0.53 kg). These differences are statistically significant ( $P < 0.05$ ). Differences in body weight between the single born and triplets of 1.28 kg were statistically significant ( $P < 0.01$ ). In male lambs, the single born were heavier than twins and triplets (by 0.52 and 0.85 kg). These differences are statistically significant ( $P < 0.05$ ). The body weight of female lambs of the control group, was 10.74 kg (in single born 11.10, twins 10.00 and triplets 9.75 kg), and male lambs weighed 11.88 kg (12.07, 11.33 and 11.00 kg). The difference between genders and the type of birth is statistically significant ( $P < 0.01$ ).

Table 2. Average weight of 30 days old lambs

Group	Gender	Type of birth	N	$\bar{x}$ (kg)	$\bar{Sx}$ (kg)	$\bar{Sd}$	$C_{V\%}$	variations	
								Min	Max
Experimental	♀	singles	9	11.033	0.156	0.469	4.251	10.550	12.500
		twins	3	10.500	0.289	0.500	4.762	10.500	11.500
		triplets	1	9.750	0.250	0.354	3.631	9.550	10.500
		Average	1	10.736	0.171	0.638	5.943	9.550	12.500
	♂	singles	1	11.858	0.125	0.432	3.643	11.500	12.550
		twins	3	11.333	0.167	0.289	2.550	11.500	11.550
triplets		2	11.550	-	-	-	11.500	11.500	
Average	1	11.706	0.119	0.477	4.075	11.500	12.550		
Average		3	11.253	0.134	0.737	6.549	9.500	12.550	
Control	♀	singles	1	11.100	0.071	0.245	2.207	10.550	11.550
		twins	3	10.500	0.000	0.000	-	10.500	10.500
		triplets	2	9.750	0.250	0.354	3.631	9.550	10.500
		Average	1	10.747	0.148	0.609	5.667	9.550	11.550
	♂	singles	1	12.071	0.115	0.432	3.579	11.500	12.550
		twins	3	11.333	0.167	0.289	2.550	11.500	11.550
triplets		1	11.550	-	-	-	11.500	11.500	
Average	1	11.889	0.125	0.530	4.458	11.500	12.550		
Average		3	11.334	0.136	0.807	7.120	9.550	12.550	

### Body weight of 90 days old lambs

Table 3. presents the body weight of 90 days old lambs and their variability depending on the group, gender, and type of lamb birth.

The average weight of lambs 90 days of age was 20.64 kg, with variations from 19.00 to 22.50 kg, a 4.37 kg variation coefficient and a standard deviation of 0.90 kg. Differences in body weight of lambs of 90 days per groups are statistically not significant ( $P > 0.05$ ). The influence of the type of birth and gender on the body weight of 90 days old lambs is statistically significant ( $P < 0.01$ ). The single born were heavier than twins and triplets of female gender in the experimental group (by 0.61 and 0.86 kg). This difference is statistically significant ( $P < 0.01$ ).

The interaction between the type of birth and gender of lambs ( $P < 0.01$ ) significantly influenced the body weight of 90 days old lambs. Based on the results obtained by the statistical test, it is noted that the differences between genders and between the type of birth are statistically significant, in favor of male lambs and single born ( $P < 0.01$ ). Tested differences within the same genders and between the body weights of the lambs 90 days of age are statistically insignificant ( $P > 0.05$ ).

Table 3. Mean values of body weight of 90 days old lambs

Group	Type of birth	Gender	N	$\bar{x}$ (kg)	$\bar{Sx}$ (kg)	$\bar{Sd}$	$C_{V\%}$	variations	
								Min	Max
Experimental	♀	singles	9	20.111	0.182	0.546	2.715	19.550	21.550
		twins	3	19.550	0.000	0.000	0.000	19.550	19.550
		triplets	1	19.250	0.250	0.354	1.839	19.500	19.550
		Average	1	19.857	0.152	0.569	2.865	19.500	21.550
	♂	singles	1	21.458	0.179	0.620	2.890	20.550	22.550
		twins	3	21.500	0.577	1.000	4.762	20.500	22.500
		triplets	2	20.500	-	-	-	20.500	20.500
Average	1	21.281	0.188	0.752	3.534	20.500	22.550		
Average		3	20.617	0.179	0.980	4.753	19.500	22.550	
Control	♀	singles	1	20.150	0.098	0.340	1.687	19.850	21.500
		twins	3	19.833	0.1670	0.289	1.457	19.550	20.500
		triplets	2	19.250	250	0.354	1.839	19.500	19.550
		Average	1	19.988	0.106	0.436	2.181	19.500	21.500
	♂	singles	1	21.393	0.140	0.525	2.454	20.550	22.500
		twins	3	21.333	0.330	0.577	2.705	21.500	22.500
		triplets	1	20.500	-	-	-	20.500	20.500
Average	1	21.306	0.141	0.598	2.807	20.500	22.500		
Average		3	20.666	0.143	0.845	4.088	19.500	22.500	

**Body weight of lambs in fattening 180 days old**

Table 4. shows the body weight of 180 days old lambs in fattening and their variability depending on the group, gender, and type of birth of the lamb.

The average body weight of lambs in fattening 180 days of age, in the third phase of the fattening in experimental and control group was 37.50 kg, with variations of 30 to 42 kg and a coefficient of variation of 8.60%. Differences in body weight of lambs in fattening of 180 days for both groups are statistically insignificant ( $P > 0.05$ ).

Table 4 shows the absolute, relative, cumulative and relative-cumulative incidence of body weight of experimental group lambs in fattening 180 days of age. Border classes ranged from 30 to 42 kg with a range of variations of 12 kg. The largest number of samples (23.33%) had a body weight of lambs in fattening from 40 to 41 kg, a mean value of 40.5 kg and a relative cumulative frequency of 76.66%. Approximately 6 heads or 20.00% were concentrated around the average value (= 37.50) indicating a significant variation of the body weight of 180 days old lamb in the fattening.



Table 4. Frequency of body weight of lambs in fattening 180 days old (experimental group)

Class borders	Class mean value	Frequency of appearance			
		Absolute			Absolute
30-31	30.5	1	1	3.333	3.333
31-32	31.5	-	-	-	-
32-33	32.5	2	3	6.666	9.999
33-34	33.5	2	5	6.666	16.665
34-35	34.5	1	6	3.333	19.998
35-36	35.5	2	8	6.666	26.664
36-37	36.5	5	14	16.666	43.333
37-38	37.5	-	-	-	-
38-39	38.5	1	15	3.333	46.663
39-40	39.5	2	17	6.666	53.329
40-41	40.5	7	23	23.333	76.662
41-42	41.5	5	28	16.666	93.329
42-43	42.5	2	30	6.666	100.000

### Daily increase in lambs 90 days of age

Table 5 shows the mean and absolute values of daily growth of 90 days old lambs, between groups and genders.

Table 5. Mean value of daily lamb growth 90 days of age

Group	Gender	N	$\bar{x}$ (kg)	$\bar{Sx}$ (kg)	$\bar{Sd}$	$C_{V\%}$	Inter. variations	
							Min	Max
Experimental	♀	13	0.219	0.002	0.008	3.652	0.200	0.238
	♂	17	0.236	0.002	0.008	3.390	0.222	0.250
	<i>Average</i>	30	0.228	0.002	0.011	4.825	0.200	0.250
Control	♀	17	0.221	0.001	0.005	2.262	0.211	0.233
	♂	18	0.238	0.002	0.007	2.966	0.222	0.244
	<i>Average</i>	35	0.230	0.002	0.009	3.947	0.211	0.244

The average daily growth of 90 days old lambs was 229 g. The lowest daily gain in the female lamb of the experimental group was 219 g, with variations from 200 to 238 g, coefficient of variation 3.65% and standard deviation of 0.008 g. The highest daily increase was found in the male lamb of the control group, which was 238 g, with variations from 222 to 244 g, with a variation coefficient of 2.96%. The differences in daily lamb growth between the experimental and control group were statistically not significant ( $P > 0.05$ ). The daily increase in male lambs in both groups was higher than the increase in female lambs. Interactions between female and male lambs are statistically highly significant ( $P < 0.01$ ).

### Daily increase in lambs 6-8 months old

Table 6 shows indicators of average and absolute value of daily growth of lambs in fattening 6-8 months old, between groups (experimental and control), gender (female and male).

Table 6. Average value of daily growth of 6-8 months old lambs in fattening

Group	Gender	N	$\bar{x}$ (kg)	$\bar{Sx}$ (kg)	$\bar{Sd}$	$C_{V\%}$	variations	
							Min	Max
Experimental	♀	13	0.164	0.003	0.001	7.317	0.142	0.190
	♂	17	0.190	0.002	0.007	3.684	0.171	0.200
	<i>Average</i>	30	0.177	0.003	0.001	8.989	0.142	0.200
Control	♀	17	0.170	0.002	0.008	4.848	0.152	0.180
	♂	18	0.195	0.001	0.006	3.141	0.176	0.205
	<i>Average</i>	35	0.183	0.002	0.015	8.427	0.152	0.205

Within each group, male lambs were found to have a higher daily gain than female lambs. Differences between groups are statistically insignificant ( $P > 0.05$ ). The highest daily increase was in male lambs of the control group of 195 g, with variations from 176 to 200 g, the variation coefficient 3.14%, and the standard deviation of 0.006 g. Gender differences were statistically very significant ( $P < 0.001$ ). The largest daily gain of 190 g in the experimental group was in male lambs. The difference in relation to female (0.026) lambs was statistically very significant ( $P < 0.001$ ). The results of individual tests of daily growth of lambs in fattening, 6-8 months old, per groups and gender, LSD indicates that gender differences were very statistically significant in favor of male lambs ( $P < 0.001$ ). Differences between the same gender and between daily increase of lambs in fattening 6-8 months of age of experimental and control group were statistically not significant ( $P > 0.05$ ).

### **Conclusion**

Based on the study on the effect of estrus synchronization on fertility and sheep fattening, by descriptive statistical analysis of reproductive and production properties, it can be concluded: The average body weight of all lambs at birth was 3.48 kg. In the experimental group, female lambs had an average weight of 3.27 kg and male 3.66 kg. In the female lamb of the control group, the average body weight was 3.31 kg, and for male 3.67 kg. Differences between groups were not statistically significant ( $P > 0.05$ ). The weight of the female lambs of the experimental group was 3.47 kg, twins 3.20 kg, triplets 2.45 kg, and male lambs (depending on the type of birth) 3.71, 3.50 and 3.50 kg. The average weight of the female lamb of the control group was 3.47 kg (single born), 3.20 kg (twins) and 2.50 kg (for triplets). In single born male lambs, the average body weight was 3.74 kg, for twins 3.43 kg and triplets 3.40 kg. The differences between gender and type of birth among the lambs' weight at birth were statistically very significant ( $P < 0.001$ ). The average weight of all 30 days old lambs was 11.29 kg. In the experimental group, the weight of male lambs was 11.70 kg and the female 10.73 kg. In the control group, the weight of male lambs was 11.88 kg and the female 10.74 kg.

The influence of gender and type of birth on 30 days old lambs' weight was statistically significant ( $P < 0.01$ ), while it did not have significant influence ( $P > 0.05$ ) among groups. The average lamb weight, 90 days old, was 20.64 kg, in experimental group lambs was 20.61 kg and in the control group, it was 20.66 kg. The average weight of the female lambs of the experimental group was 20.11 kg for the single born, the twins were 19.50 kg and the triplets were 19.25 kg of weight. In male lambs, depending on the type of birth, the average body weight was 24.45, 21.00 and 20.00 kg. The weight of the single born male lambs of the control group was 21.39 kg, the twins were 21.33 kg and the triplets 20.00 kg, while the female lambs (by type of birth) were 20.15, 19.83 and 19.25 kg of weight. The average daily increase in lambs on the 90th day of life was 229 g. The average daily growth of experimental group lambs was 228 g and for the control group 229 g. The differences between the groups in the daily lamb increment did not have any significant effect. Gender impact was statistically very significant ( $P < 0.01$ ). The average daily growth of lambs in fattening 6-8 months old was 180 g. In the experimental group, female lambs had an increase of 164 g and a male of 190 g. The average daily gain of female lambs of the control group was 170 g and in male 195 g.

Since the organization of raising was adequate for both groups, the estrus synchronization had no effect on the production characteristics.

## References

- Jevtić-Vukmirović A., (2007). The influence of genotype and condition in a different breeding system on the reproductive and production characteristics of sheep. Kosovska Mitrovica.
- Jevtić S., Radović V., Jevtić-Vukmirović A. (2009). Reproduction of domestic animals. Faculty of Agriculture, monograph, CIP 636.082; COBTSS. SR-ID 155480588, ISBN 978-86-82107-91-0. Čačak-Prokuplje.
- Jevtić S., Jevtić-Vukmirović A. (2010). Basics of veterinary and animal husbandry. Faculty of Agriculture, monograph, Čačak-Prokuplje.
- Jevtić S., Radović V., Milenković M., Jevtić-Vukmirović A., Ilić Z. (2007). Hygiene in animal husbandry, Faculty of Agriculture, monograph, CIP 636.09: 613 (075.8) ISBN 978-86-82107-86-6. COBISS. SR -Id 141654796 Čačak-Prokuplje.
- Petrović, M. (1989). Influence of weight at birth on the increase and mortality of lambs of Pirot-enriched population to rejection. Archives for Agriculture. Science.
- Petrović, M., Nenadović M., Skalički.Z.(1991). Influence of the manner of education on the growth of lambs, milking and the condition of sheep. Proceedings of the institute for livestock breeding. Belgrade.
- Petrović, M. (1992). Examination of the reproductive and production characteristics of the Witberian sheep breed. Doctoral dissertation, University of Belgrade. Donji Miholjac.
- Petrović, P., Josipović M., (2000). Impact on yield and quality of lamb meat, Monograph, Belgrade.
- Radović V., Jevtić S., Ilić Z., Jevtić-Vukmirović A. (2007). Cultivation of sheep and goats. Faculty of Agriculture, monograph, CIP 636.3.08 (075.8) ISBN 978-86-82107-90-3. COBISS. SR -ID 141655564, Čačak - Prokuplje.

## HOUSING FACILITIES FOR DAIRY COWS ON THE TERRITORY OF THE MUNICIPALITY OF VRNJAČKA BANJA

Dejan GAVRILOVIĆ<sup>1</sup>, Biljana ANĐELIĆ<sup>2</sup>, Aleksandar JEVTIĆ<sup>3</sup>, Aleksandra JEVTIĆ<sup>4</sup>, Slobodan JEVTIĆ<sup>5</sup>, Marijana GAVRILOVIĆ<sup>6</sup>, Boban KOSTIĆ<sup>7</sup>

<sup>1</sup>John Naisbitt University of Belgrade, Faculty of biofarming Bačka Topola, Serbia

<sup>2</sup>University of Kragujevac, Faculty of agronomy Čačak, Serbia

<sup>3</sup>Public utility enterprise of Vrnjačka Banja, Serbia

<sup>4</sup>High school of agriculture and food of Prokuplje, Serbia

<sup>5</sup>Municipality of Vrnjačka Banja, Serbia

<sup>6</sup>High technical technology school of Kruševac, Serbia

<sup>7</sup>Public utility enterprise of Kruševac, Serbia

\*Corresponding author:dejangavrilovic037@gmail.com

### Abstract

During the production cycle of dairy cows, all necessary conditions, with care and nutrition above all, must be provided. Housing must have good beds that are spacious and comfortable with a good and dry mat, a sufficient quantity of drinking water and adequate mangers. Ventilation, lighting, and humidity in the housing must comply with animal hygiene standards. In this sense, the objective of this paper was to obtain data i.e. parameters speaking of the condition of facilities and quality of dairy cows breeding in the municipality of Vrnjačka Banja and Kraljevo. The paper presents tabular data on the condition of facilities for housing dairy cows, construction characteristics of facilities, accommodation capacities, ventilation method, facilities lighting and relative humidity in facilities for animals. On the other hand, animal nutrition must meet both physiological and productive needs with enough proteins, carbohydrates, macro- and microelements and to vary by the physiological process and season. For this reason, during a visit, the authors gave farmers appropriate professional recommendations for feeding dairy cows according to the method of cultivation or depending on whether livestock breeding is of indoor type or combined with grazing.

**Keywords:** *housing facilities, cow nourishment, feeding dairy cows*

### Introduction

The production of dairy cows is based to the greatest extend to the connected type of housing. In order to have a comfortable staying of animals during the production process, all necessary conditions must be provided for the animal: proper housing, care and nutrition (Jevtić *et al.*, 2016). The beds need to be spacious and comfortable with enough mats, they need to fulfill the basic conditions of hygiene, i.e. to absorb the moist and unpleasant gases well, not to irritate the animal skin and not to cause changes in it and not to be sticky (Jevtić, 1990; Jevtić, 2007; Pešev, 2004). During 24 hours a cow leaks from the organism about 6 to 20 liters of urine so it is necessary to provide 3 to 3.5 kg of mat per animal on a daily basis. It is determined that the replacement of the mat is done in a satisfactory manner, i.e. once per day. In that respect, the aim of this paper was to obtain the data, i.e. parameters which evidence the condition of the facilities and quality of dairy cow breeding. The recommendations for nourishment of these domestic animals are given, too (Jevtić *et al.*, 2016). In the conditions of individual agricultural production, at the territories of municipalities of Vrnjacka Banja and Kraljevo, the manner of housing the livestock is stable and in the summer months it is

combined, with pasture nutrition. At the surveyed households enough appropriate mats were provided: straw, corn stalks, sawdust, fern, leaves, etc.

### Material and Methods

The authors of this paper visited the cow housing facilities at the territories of Vrnjacka Banja and Kraljevo municipalities (Serbia) during 2015. The presented data have been evidenced on five cow farms where have been housed a total of 21 cows of the native colourful breed of Simmental type. These farms are located in the villages eastbound from the municipality Vrnjačka Banja (Rudinci, Stulac), northbound (Vrnjci, Novo Selo) and westbound (Gracac). The obtained results of measuring and the found state are presented in Tables 1-5 in the following chapter. The measuring of relative humidity (%) in the facilities for housing animals (Table 5) was performed using special measuring equipment (Dukić, 2006). UNI-T Higrometer was used and it represents mini digital temperature and air humidity measuring device of high accuracy. The device is user-friendly, which makes it an excellent tool for monitoring internal “climate” in agriculture, livestock farming, public facilities and many other fields.

### Results and discussion

Tables 1 –5 present the equipment of the facilities for housing dairy cows, construction characteristics of facilities with the biggest number of livestock, mangers in the facilities for housing cows, the ventilation in the facilities for housing cows, lighting of the facilities for housing cows and relative humidity in the facilities for housing animals at the territories of Vrnjacka Banja and Kraljevo municipalities during 2015. All these factors influence in the corresponding manner the status of these animals’ organisms. (Jevtić *et al.*, 2016). The facilities are equipped with water troughs, all provided with water for filling, with mangers for nourishment and suitable mat (Table 1).

Table 1 –The equipment of the facilities for housing dairy cows

Equipment %	Location				
	Vrnjci	Rudjinci	Stulac	Novo Selo	Gracac
Water trough	19.96	14.19	52.38	7.20	13.00
Water in the facility	39.70	36.92	68.50	18.00	22.30
Manger	96.02	92.04	98.88	86.82	86.80
Met	82.00	92.20	96.00	82.88	82.86

Mangers are most frequently made of wood of various origins and in percentage they are expressed as 78.00%. Less frequently mangers were made of concrete, which is in percentage expressed as 9.70% at the surveyed locations. The length of mangers depend on the volume of livestock in the facility and their depth was about 60cm with 45cm width (Table 2).

Table 2 –The construction characteristics of facilities with the biggest number of livestock

Number of livestock units	Cubage m <sup>3</sup>	The length of stable m	The width of stable m	The height of stable m	Floor surface m <sup>2</sup>
5.00	73.60	8.00	4.00	2.30	32.00
4.00	56.96	7.50	3.50	2.17	26.25
3.00	8.84	10.00	4.20	2.10	42.00
4.00	148.80	10.60	5.20	2.70	55.12
5.00	96.76	9.60	4.20	2.40	40.32

The facilities are most frequently placed along the longer axis in East-West direction due to the wind strength. On average, they are 20-40m distanced from other facilities, as individual facilities, they have adequate cubage with suitable lengths and widths of stables and appropriate floor surface (Jevtić et al., 2016).

Table 3 –The form of mangers (%) in the facilities for housing cows and the type of ventilation (%) in the facilities for housing cows

Form of manger (%)	Location at the territories of the stated municipalities				
	Vrnjci	Rudjinci	Stulac	Novo Selo	Gracac
Concrete	28.02	19.00	17.00	9.90	9.70
Wooden	68.00	72.20	82.00	69.10	78.00
Other	3.98	8.80	1.00	21.00	12.30
Ventilation %					
Natural	81	88	97	99	99
Artificial	19	12	3	1	1

The ventilation in most of the facilities is natural, which according to the facility size enables proper coefficient of ventilation, i.e. the necessary number of air changes (Table 3).

There are three types of lighting in the facilities, most frequently artificial, then combined and in the smallest portion of surveyed stables it is natural (Table 4).

Table 4 –The type of lighting (%) of the facilities for housing cows

Lighting (%)	Location at the territories of the stated municipalities				
	Vrnjci	Rudjinci	Stulac	Novo Selo	Gracac
Combined	20	19	16	16	4
Natural	18	13	18	4	6
Artificial	62	68	66	80	90

The humidity at the surveyed stables was 61 to 84% at the first stable and in the second from 70 to 87%, which had a corresponding positive impact on animals (Table 5). Desinfection, desinsection and deratization is occasionally done at stables, most frequently without the

control and supervision of competent persons. The cooperation of agricultural households and veterinary service is satisfactory.

Table 5 –The relative humidity (%) in the facilities for housing animals at stables A and B

Month	A	B	Month	A	B	Month	A	B
I	81	78	V	63	70	IX	61	79
II	79	85	VI	60	75	X	64	80
III	74	87	VII	62	68	XI	79	76
IV	61	70	VIII	61	74	XII	84	81

Cattle breeding is developed exclusive at private properties and the most important branch is cow breeding for the production of milk and calves. Steers are bred for reproduction and slaughtering. The most widespread is the domestic versatile cattle of Simmental breed. There are no farms of milking cows but there are small mini-farms whose owners are individual agricultural producers. The manner of cattle breeding is stable, combined and during the summer, autumn and spring the animals go to pastures. The purchase of milk is organized (Dairy plant of Kraljevo and two private entrepreneurs, owners of dairy plans at the territories of mentioned municipalities).

### Recommendations for cow nutrition

The determination of the nourishment level depends on the body weight of the cow, quantity and quality of milk produced during the day and pregnancy stage. During the determination of the needs, the size of the meal, possibility of consumption based on the raw substance, energy value of the meal (in nutritive units), the quantity of digestible raw proteins, and quantity of calcium, phosphor and salt are standardized (Rajić, I. et al. 1999). The estimated needs in proteins for dairy cows are 60g SSP per 100g of body weight and 60g SSP/kg 4% milk. In new recommendations, depending on the percentage of fat in milk and quantity SSP is changed to 53 g/kg of the produced milk. Bulky food should be given, by the rule, in fresh and green condition because it is quality and tasty food then and animals are willing to eat it. During the summer the cows eat at pastures (Jevtić *et al.*, 2009). Apart from grazing, cows use concentrate which is given in the quantity of 5kg per day with 12% of digestible proteins. As a supplement to the pasture nutrition, bran in the quantity of 1.5kg, 0.5kg of sunflower pellets and 1.5kg to 2kg of beet noodles are given. One daily meal of dairy cows must include the supplement of cattle chalk and salt in the summer period. For a dairy cow of 500-600kg body weight, 16kg of straw can be given per day. For a bigger milk production the cow should be fed on concentrates as following: for 1kg of milk 0.45kg - 0.50kg and for 2kg 0.9kg – 1.0kg of concentrate.

### Conclusion

It is possible to conclude, on the basis of presented data, that livestock breeding in Vrnjačka Banja is developed on the private estates exclusively. Big farms of milk cows are not represented here, but there is certain shift and certain farms have begun to be built. Contribution to this is given by provided purchase of milk.

Small individual farms are the most represented and the method of breeding cattle is not so profitable; but with the advancement of nutrition and with the help of subsidized by the state it has a perspective for gradual recovery.

### **References**

- Dukić, D. (2006). Climatology, The Faculty of Geography, Belgrade.
- Jevtić, S., Jevtić A., (2016). Hygiene in livestock breeding, Monograph, Technical Faculty of the European University, Brčko district, The Republic of Srpska.
- Jevtić, S. (1990). Zoo hygiene, The Faculty of Agronomy, Čačak.
- Jevtić, S. (2007). Hygiene in livestock breeding, Monograph, The Faculty of Agronomy, Čačak.
- Jevtić, S., Jevtić–Vukmirović A., Radović, V. (2009). Reproduction of domestic animals, Monograph, The Faculty of Agronomy, Čačak.
- Pešev, S. (2004). Magister paper, The Faculty of Agronomy, Čačak.
- Rajić, I., Ševković, N., Pribičević, S., (1999). Nourishment of domestic animals, The Faculty of Veterinary medicine, Belgrade.



## CARBOHYDRATE FRACTIONS OF ENSILED PEA : OAT MIXTURES

Jordan MARKOVIĆ\*, Tanja VASIĆ, Mirjana PETROVIĆ, Snežana ANĐELKOVIĆ, Ivica KOSTIĆ, Dragan TERZIĆ, Vladimir ZORNIĆ

Institute for Forage Crops d.o.o. Globoder, Kruševac, Serbia

\*Corresponding author: jordan.markovic@ikbks.com

### Abstract

The pea and oat were tested at five different mixture rates: A<sub>1</sub>-100% pea + 0% oat; A<sub>2</sub>-0% pea + 100% oat; A<sub>3</sub>- 25% pea + 75% oat; A<sub>4</sub>-50% pea + 50% oat and A<sub>5</sub>- 75% pea + 25% oat. The pea:oat mixtures were ensiled without (B<sub>1</sub>) and with bacterial inoculant (B<sub>2</sub>). The objective of this experiment was to assess the effects of pea proportion and bacterial additives on carbohydrate fractions of ensiled pea:oat mixtures. Silage samples were assayed for DM (Dry Matter), CP (Crude Protein), CHO (Total Carbohydrates), NSC (Non-Structural Carbohydrates), Starch, NFC (Non-Fiber Carbohydrates), aNDF (Neutral Detergent Fiber), ADF (Acid Detergent Fiber), HCL (Hemicellulose), Lignin and DMD (Dry Matter Digestibility) and carbohydrate fractions by CNCPS (Cornell Net Carbohydrates and Protein System). It was realized that pea and oat can be planted successfully for herbage production, and these mixtures can be successfully ensiled and obtained high quality silages. The addition of bacteria slightly decreased ( $P < 0.05$ ) the CP and NSC contents of silages but increased ( $P < 0.05$ ) the aNDF, ADF and DMD. Ensiled 100% pea had the highest CP and NFC content and the highest DMD. The pea: oat (75 : 25) silage had the lowest aNDF (560.3 g kg<sup>-1</sup> DM), ADF (425.8 g kg<sup>-1</sup> DM) and lignin (79.0 g kg<sup>-1</sup> DM), but had the highest DMD (612.0 g kg<sup>-1</sup> DM). CB<sub>3</sub> fraction of carbohydrates was the highest fraction in the pea: oat silage.

**Keywords:** *bacterial inoculant, pea:oat mixtures, silage, carbohydrate fractions*

### Introduction

Forage pea (*Pisum sativum subsp. arvense* L.) is an annual plant which is grown in many parts of the world. It is highly valued for its high crude protein content. Cultivation of field pea is also beneficial to improve soil fertility by the root-nodule bacteria (*Rhizobia sp.*) that are able to introduce atmospheric nitrogen into soil (Kwabiah, 2004). Although it is mainly used for seed production in Serbia, the whole plant can be processed into silage. Oat is commonly used for greenfeed (hay). However, it also presents some less desirable characteristics such as low protein content (6.45-7.84%) compared to other cereals used for other forms of livestock feeding systems such as grazing and silage (Omokanye, 2014). Combining annual crop species for improved forage productivity should clearly have nutritional and financial benefits in the overall livestock production (Kwabiah, 2004). Bi-crops of various grain legumes and cereals have received much attention because of their high yields (Salawu et al., 2001). In particular, bi-crops with pea varieties or mixtures with high grain to straw ratios are considered to have a good balance of energy and protein contents (Anil et al., 1998). One anticipated advantage of feeding bi-crop silages of cereal and legumes is an improvement in the efficiency of nutrient utilization due to the possible synchronous supply of readily fermentable energy and protein in the rumen (Adesogan et al., 2002).

Forage pea have higher CP (Crude Protein) and *in vitro* digestible organic matter, and lower neutral detergent fiber (NDF) and acid detergent fiber (ADF) than wheat (Salawu et al., 2001), and higher CP contents than oats (Faulkner, 1985). However, adding pea to wheat, oat or barley increases forage CP concentration and decreases NDF and ADF (Salawu et al., 2001). Mustafa and Seguin (2004) found that whole-crop pea silage has similar yields, but higher CP and lower NDF contents than pea-cereal silages and that the *in vitro* DM digestibility of pea silage is higher than that of pea-cereal mixtures. The objective of this experiment was to assess the effect of pea proportion and bacterial additives on carbohydrate fractions of ensiled pea:oat mixtures.

### Materials and methods

The experiment was designed with three replications according to a randomized complete block. Experiment was established in autumn in 2012, on October the 20<sup>th</sup> and the samples were taken in spring in 2013. Pea and oat were grown in binary mixtures at the experimental field of Institute for forage crops, Kruševac – Serbia (21°19'35'' E, 43°34'58'' N). The pea and oat were tested at five different mixture rates: A<sub>1</sub>-100% pea + 0% oat; A<sub>2</sub>-0% pea + 100% oat; A<sub>3</sub>- 25% pea + 75% oat; A<sub>4</sub>-50% pea + 50% oat and A<sub>5</sub>- 75% pea + 25% oat. All mixtures were sown on plots of 20 m<sup>2</sup>. Initial soil test from 0-30 cm soil depth before the trial commenced showed 0.16% N, 4.9 mg P<sub>2</sub>O<sub>5</sub> / 100 g of soil, 23.1 mg K<sub>2</sub>O / 100 g of soil, 3.5% organic matter and a pH of 5.7 in N KCl. One level of fertilizer was applied, 300 kg ha<sup>-1</sup> NPK (15:15:15) before the seeding. Plant samples were taken in spring 2013, at forming the first pods on 2/3 plants of pea. The pea:oat mixtures were ensiled in the experimental containers holding 130 dm<sup>3</sup>, with three replications. After compaction, silos was covered with plastic wrap, and covered with a layer of sand thickness of about 10 cm as the main load. Bacterial inoculant *BioStabil Plus* which contained homo-fermentative lactic acid bacteria (*Enterococcus faecium* and *Bacillus plantarum*) and hetero-fermentative lactic acid bacteria (*Bacillus brevis*) with a concentration of 5×10<sup>10</sup> cfu per gram was added, and ensiled in anaerobic jars for 45 days. Silage samples were assayed for DM (Dry Matter) by oven drying at 60° C for 48 h. Standard procedures described by the AOAC (1990) were used to determine ash (AOAC, 942.05), Crude Protein (CP; AOAC 984.13) and ether extract (EE, AOAC 954.02), but ash and EE were not presented in this paper. Total carbohydrates [CHO = 1000 – (CP + Ash + EE)] and Non-Fiber carbohydrates [NFC = 1000 – (aNDF + CP + Ash + EE)] were calculated according to NRC (2001). NDF assayed with heat stable  $\alpha$ -amylase (aNDF), acid detergent fiber (ADF), hemicellulose (HCL) and lignin content were determined according to Van Soest et al. (1991). NSC (Non-Structural Carbohydrates – monosaccharides and disaccharides) were determined as total ethanol soluble carbohydrates according procedures described by Hall et al. (1999), and starch content was determined according enzymatic method by Hall (2000). Two stage pepsin-cellulase method was used for *in vitro* DM digestibility (De Boevar et al., 1986). Total CHO are divided into five fractions: instantaneously solubilizable CHO (CA, *i.e.* NSC); rapidly degradable CHO (CB<sub>1</sub>, *i.e.* starch); intermediately degradable CHO (CB<sub>2</sub>, *i.e.* NFC – NSC – starch); slowly degradable CHO (CB<sub>3</sub>, *i.e.* ANDF – CC) and undegradable CHO (CC, *i.e.* aNDF × (Lignin / aNDF) × 2.4) composed of completely undegradable NDF (Lanzas et al., 2007). The experimental data were analyzed by a two-way analysis of variance for silage samples using a model that accounted for the main effects of pea:oat mixtures and addition of inoculant. Effects were considered different based on significant (p< 0.05) F ratio. The significance of differences between arithmetic means was tested by LSD test (STATISTICA 6, Stat. Soft. 2006).

### Results and discussion

The chemical composition of pea:oat silages are presented in Table 1. DM content in silages ranged from 270.6 g kg<sup>-1</sup> in pea silage to 276.6 g kg<sup>-1</sup> in oat silage. The main effect of pea proportion in the mixtures was significant (p< 0.05) for several variables. The CP and NFC content was the highest in pea silage, whereas content of CP and NSC increased with increasing pea proportion in pea:oat mixtures.

Table 1. Primary carbohydrate fractions of ensiled pea:oat mixture

		A <sub>1</sub>	A <sub>2</sub>	A <sub>3</sub>	A <sub>4</sub>	A <sub>5</sub>	$\bar{X}_B$
DM, g kg <sup>-1</sup>	B <sub>1</sub>	271,0 <sup>ns</sup>	274,3 <sup>ns</sup>	269,3 <sup>ns</sup>	272,0 <sup>ns</sup>	277,0 <sup>ns</sup>	<b>272,7<sup>ns</sup></b>
	B <sub>2</sub>	270,3 <sup>ns</sup>	279,0 <sup>ns</sup>	276,6 <sup>ns</sup>	273,6 <sup>ns</sup>	274,6 <sup>ns</sup>	<b>274,8<sup>ns</sup></b>
	$\bar{X}_A$	<b>270,6<sup>b</sup></b>	<b>276,6<sup>a</sup></b>	<b>273,0<sup>ab</sup></b>	<b>272,8<sup>ab</sup></b>	<b>275,8<sup>ab</sup></b>	
CP, g kg <sup>-1</sup> DM	B <sub>1</sub>	230,1 <sup>a</sup>	96,3 <sup>fg</sup>	113,0 <sup>e</sup>	159,3 <sup>c</sup>	195,3 <sup>b</sup>	<b>158,8<sup>a</sup></b>
	B <sub>2</sub>	223,9 <sup>a</sup>	87,5 <sup>g</sup>	102,1 <sup>f</sup>	147,1 <sup>d</sup>	188,6 <sup>b</sup>	<b>149,8<sup>b</sup></b>
	$\bar{X}_A$	<b>227,0<sup>a</sup></b>	<b>91,8<sup>e</sup></b>	<b>107,5<sup>d</sup></b>	<b>153,2<sup>c</sup></b>	<b>192,0<sup>b</sup></b>	
CHO, g kg <sup>-1</sup> DM	B <sub>1</sub>	620,8 <sup>e</sup>	757,3 <sup>b</sup>	747,6 <sup>b</sup>	719,6 <sup>c</sup>	687,9 <sup>d</sup>	<b>706,6<sup>ns</sup></b>
	B <sub>2</sub>	623,2 <sup>e</sup>	773,3 <sup>a</sup>	752,2 <sup>b</sup>	687,0 <sup>d</sup>	683,2 <sup>d</sup>	<b>703,8<sup>ns</sup></b>
	$\bar{X}_A$	<b>622,0<sup>e</sup></b>	<b>765,3<sup>a</sup></b>	<b>749,9<sup>b</sup></b>	<b>703,3<sup>c</sup></b>	<b>685,5<sup>d</sup></b>	
NSC, g kg <sup>-1</sup> DM	B <sub>1</sub>	23,9 <sup>c</sup>	30,6 <sup>c</sup>	17,5 <sup>c</sup>	73,2 <sup>b</sup>	266,0 <sup>a</sup>	<b>82,2<sup>a</sup></b>
	B <sub>2</sub>	17,8 <sup>c</sup>	28,8 <sup>c</sup>	20,2 <sup>c</sup>	19,7 <sup>c</sup>	88,7 <sup>b</sup>	<b>35,0<sup>b</sup></b>
	$\bar{X}_A$	<b>20,8<sup>b</sup></b>	<b>29,7<sup>b</sup></b>	<b>18,8<sup>b</sup></b>	<b>46,5<sup>b</sup></b>	<b>177,4<sup>a</sup></b>	
Starch, g kg <sup>-1</sup> DM	B <sub>1</sub>	38,3 <sup>cd</sup>	37,5 <sup>d</sup>	44,0 <sup>b</sup>	40,6 <sup>c</sup>	46,1 <sup>b</sup>	<b>41,3<sup>ns</sup></b>
	B <sub>2</sub>	37,4 <sup>d</sup>	37,4 <sup>d</sup>	44,8 <sup>b</sup>	37,5 <sup>d</sup>	50,1 <sup>a</sup>	<b>41,5<sup>ns</sup></b>
	$\bar{X}_A$	<b>37,9<sup>c</sup></b>	<b>37,5<sup>c</sup></b>	<b>44,4<sup>b</sup></b>	<b>39,0<sup>c</sup></b>	<b>48,1<sup>a</sup></b>	
NFC, g kg <sup>-1</sup> DM	B <sub>1</sub>	278,0 <sup>a</sup>	159,8 <sup>e</sup>	184,6 <sup>d</sup>	190,1 <sup>c</sup>	211,0 <sup>b</sup>	<b>204,7<sup>ns</sup></b>
	B <sub>2</sub>	285,9 <sup>a</sup>	163,0 <sup>d</sup>	157,0 <sup>d</sup>	235,1 <sup>b</sup>	200,0 <sup>c</sup>	<b>208,2<sup>ns</sup></b>
	$\bar{X}_A$	<b>281,9<sup>a</sup></b>	<b>161,4<sup>d</sup></b>	<b>170,9<sup>d</sup></b>	<b>213,2<sup>b</sup></b>	<b>205,5<sup>c</sup></b>	
aNDF, g kg <sup>-1</sup> DM	B <sub>1</sub>	480,8 <sup>f</sup>	718,0 <sup>b</sup>	693,2 <sup>c</sup>	611,9 <sup>d</sup>	553,9 <sup>e</sup>	<b>611,6<sup>b</sup></b>
	B <sub>2</sub>	478,9 <sup>f</sup>	724,5 <sup>ab</sup>	734,7 <sup>a</sup>	609,4 <sup>d</sup>	566,7 <sup>e</sup>	<b>622,8<sup>a</sup></b>
	$\bar{X}_A$	<b>479,9<sup>d</sup></b>	<b>721,2<sup>a</sup></b>	<b>713,9<sup>a</sup></b>	<b>610,6<sup>b</sup></b>	<b>560,3<sup>c</sup></b>	
ADF, g kg <sup>-1</sup> DM	B <sub>1</sub>	387,6 <sup>d</sup>	513,1 <sup>ab</sup>	507,2 <sup>b</sup>	465,1 <sup>c</sup>	402,7 <sup>d</sup>	<b>455,2<sup>b</sup></b>
	B <sub>2</sub>	395,7 <sup>d</sup>	534,2 <sup>a</sup>	526,0 <sup>ab</sup>	462,4 <sup>c</sup>	448,9 <sup>c</sup>	<b>473,4<sup>a</sup></b>
	$\bar{X}_A$	<b>391,6<sup>d</sup></b>	<b>523,7<sup>a</sup></b>	<b>516,6<sup>a</sup></b>	<b>463,8<sup>b</sup></b>	<b>425,8<sup>c</sup></b>	
HCL, g kg <sup>-1</sup> DM	B <sub>1</sub>	93,2 <sup>cd</sup>	204,8 <sup>a</sup>	185,9 <sup>a</sup>	146,7 <sup>b</sup>	151,2 <sup>b</sup>	<b>149,4<sup>ns</sup></b>
	B <sub>2</sub>	83,2 <sup>d</sup>	190,3 <sup>a</sup>	208,7 <sup>a</sup>	146,9 <sup>b</sup>	117,8 <sup>c</sup>	<b>156,4<sup>ns</sup></b>
	$\bar{X}_A$	<b>88,2<sup>d</sup></b>	<b>197,6<sup>a</sup></b>	<b>197,3<sup>a</sup></b>	<b>146,8<sup>b</sup></b>	<b>134,5<sup>c</sup></b>	
Lignin, g kg <sup>-1</sup> DM	B <sub>1</sub>	84,6 <sup>bc</sup>	95,0 <sup>ab</sup>	97,9 <sup>ab</sup>	86,5 <sup>bc</sup>	74,7 <sup>cd</sup>	<b>87,8<sup>ns</sup></b>
	B <sub>2</sub>	70,2 <sup>d</sup>	96,7 <sup>ab</sup>	107,3 <sup>a</sup>	94,7 <sup>ab</sup>	83,3 <sup>bc</sup>	<b>90,4<sup>ns</sup></b>
	$\bar{X}_A$	<b>77,4<sup>c</sup></b>	<b>95,8<sup>ab</sup></b>	<b>102,6<sup>a</sup></b>	<b>90,6<sup>b</sup></b>	<b>79,0<sup>c</sup></b>	
DMD, g kg <sup>-1</sup> DM	B <sub>1</sub>	695,6 <sup>a</sup>	423,3 <sup>c</sup>	461,7 <sup>f</sup>	525,7 <sup>d</sup>	666,9 <sup>b</sup>	<b>526,8<sup>b</sup></b>
	B <sub>2</sub>	661,3 <sup>b</sup>	442,7 <sup>ef</sup>	457,1 <sup>f</sup>	515,7 <sup>d</sup>	557,2 <sup>c</sup>	<b>554,7<sup>a</sup></b>
	$\bar{X}_A$	<b>678,4<sup>a</sup></b>	<b>433,0<sup>e</sup></b>	<b>459,4<sup>d</sup></b>	<b>520,7<sup>c</sup></b>	<b>612,0<sup>b</sup></b>	

A<sub>1</sub>-100% pea + 0% oat; A<sub>2</sub>-0% pea + 100% oat; A<sub>3</sub>-25% pea + 75% oat; A<sub>4</sub>-50% pea + 50% oat; A<sub>5</sub>-75% pea + 25% oat. B<sub>1</sub>-control, treatment without bacterial inoculant; B<sub>2</sub>-treatment with bacterial inoculant. DM-Dry Matter; CP-Crude Protein; CHO-Total Carbohydrates; NSC-Non-Structural Carbohydrates; NFC-Non-Fiber Carbohydrates; aNDF-Neutral Detergent Fiber; ADF-Acid Detergent Fiber; HCL-Hemicellulose; DMD-Dry Matter Digestibility. Different letters denote significantly different means (P< 0.05)

The highest content of starch was recorded in silage with 75% pea proportion in pea:oat mixture, whereas starch content in pea silage and oat silage was similar and there was no significant difference ( $p > 0.05$ ). Despite the CP and nonstructural carbohydrates, content of structural carbohydrates and lignin was higher in oat silage (Table 1). aNDF, ADF, hemicellulose and lignin content was the highest in oat silage, and decreased with increasing pea proportion in pea:oat mixtures ( $p < 0.05$ ). With increasing structural carbohydrates and lignin content dry matter digestibility decreased. Results obtained in this study indicate that the highest DMD was recorded in pea silage ( $678.4 \text{ g kg}^{-1}$ ) and the lowest in oat silage ( $433.0 \text{ g kg}^{-1}$ ). With increasing pea proportion in the mixtures, DMD of ensiled pea:oat mixtures increased from  $459.4 \text{ g kg}^{-1}$  to  $612.0 \text{ g kg}^{-1}$  (Table 1).

The addition of bacterial inoculant decreased ( $p < 0.05$ ) CP and NSC content, but increased ( $p < 0.05$ ) aNDF and ADF content in pea:oat silages. The addition of bacterial inoculant was not significant for pea:oat silages DM, CHO, starch, NFC, hemicellulose and lignin content. The bacterial inoculant increased DMD of pea:oat silages. The results of this investigation indicate that NSC and starch content was lower in pea and oat silages than in pea:oat silages, which is result of nonstructural carbohydrates fermentation to lactic acid and acetic acid. The digestibility values of the pea:oat silages were generally lower than those found for the pea silage. The lower digestibility may be partly attributable to their higher indigestible cell wall contents and unavailable CC fraction of CHO. Mustafa et al. (2000) reported that whole pea silages, harvested at full pod stage, can successfully replace barley or alfalfa silage as a forage source for high yielding dairy cows in early lactation, whereas Børsting and Weisbjerg (2002) found that feeding pea silage harvested with undeveloped seeds to dairy cows led to a lower dry matter intake, milk yield and milk protein yield in comparison to perennial ryegrass silage made with a comparable crude protein content.

Table 2. Carbohydrate fractions by CNCPS of ensiled pea:oat mixture

		A <sub>1</sub>	A <sub>2</sub>	A <sub>3</sub>	A <sub>4</sub>	A <sub>5</sub>	$\bar{X}_B$
CA, g kg <sup>-1</sup> CHO	B <sub>1</sub>	29,2 <sup>bc</sup>	37,7 <sup>b</sup>	20,1 <sup>c</sup>	86,2 <sup>a</sup>	90,3 <sup>a</sup>	<b>52,7<sup>a</sup></b>
	B <sub>2</sub>	22,3 <sup>c</sup>	36,8 <sup>b</sup>	22,6 <sup>c</sup>	19,9 <sup>c</sup>	88,2 <sup>a</sup>	<b>38,0<sup>b</sup></b>
	$\bar{X}_A$	<b>25,7<sup>d</sup></b>	<b>37,2<sup>c</sup></b>	<b>21,4<sup>d</sup></b>	<b>53,1<sup>b</sup></b>	<b>89,2<sup>a</sup></b>	
CB <sub>1</sub> , g kg <sup>-1</sup> CHO	B <sub>1</sub>	61,8 <sup>c</sup>	49,5 <sup>f</sup>	58,9 <sup>cd</sup>	56,4 <sup>de</sup>	67,1 <sup>b</sup>	<b>58,7<sup>ns</sup></b>
	B <sub>2</sub>	60,0 <sup>cd</sup>	48,4 <sup>f</sup>	59,6 <sup>cd</sup>	54,7 <sup>e</sup>	73,3 <sup>a</sup>	<b>59,2<sup>ns</sup></b>
	$\bar{X}_A$	<b>60,9<sup>b</sup></b>	<b>48,9<sup>d</sup></b>	<b>59,3<sup>b</sup></b>	<b>55,5<sup>c</sup></b>	<b>70,2<sup>a</sup></b>	
CB <sub>2</sub> , g kg <sup>-1</sup> CHO	B <sub>1</sub>	447,8 <sup>a</sup>	211,0 <sup>e</sup>	247,0 <sup>d</sup>	264,2 <sup>d</sup>	306,8 <sup>c</sup>	<b>295,3<sup>b</sup></b>
	B <sub>2</sub>	458,9 <sup>a</sup>	210,8 <sup>e</sup>	208,8 <sup>e</sup>	342,2 <sup>b</sup>	292,8 <sup>c</sup>	<b>302,7<sup>a</sup></b>
	$\bar{X}_A$	<b>453,3<sup>a</sup></b>	<b>210,9<sup>d</sup></b>	<b>227,9<sup>c</sup></b>	<b>303,2<sup>b</sup></b>	<b>299,8<sup>b</sup></b>	
CB <sub>3</sub> , g kg <sup>-1</sup> CHO	B <sub>1</sub>	303,0 <sup>c</sup>	473,6 <sup>a</sup>	439,0 <sup>b</sup>	385,5 <sup>c</sup>	356,3 <sup>d</sup>	<b>391,5<sup>a</sup></b>
	B <sub>2</sub>	290,2 <sup>e</sup>	471,9 <sup>a</sup>	451,5 <sup>b</sup>	355,7 <sup>d</sup>	345,7 <sup>d</sup>	<b>383,0<sup>b</sup></b>
	$\bar{X}_A$	<b>296,6<sup>e</sup></b>	<b>472,8<sup>a</sup></b>	<b>445,2<sup>b</sup></b>	<b>370,6<sup>c</sup></b>	<b>351,0<sup>d</sup></b>	
CC, g kg <sup>-1</sup> CHO	B <sub>1</sub>	158,1 <sup>e</sup>	228,1 <sup>b</sup>	235,0 <sup>b</sup>	207,6 <sup>c</sup>	179,5 <sup>d</sup>	<b>201,7<sup>b</sup></b>
	B <sub>2</sub>	168,6 <sup>de</sup>	232,0 <sup>b</sup>	257,4 <sup>a</sup>	227,4 <sup>b</sup>	199,9 <sup>c</sup>	<b>217,0<sup>a</sup></b>
	$\bar{X}_A$	<b>163,3<sup>e</sup></b>	<b>230,1<sup>b</sup></b>	<b>246,2<sup>a</sup></b>	<b>217,5<sup>c</sup></b>	<b>189,7<sup>d</sup></b>	

A<sub>1</sub>-100% pea + 0% oat; A<sub>2</sub>-0% pea + 100% oat; A<sub>3</sub>-25% pea + 75% oat; A<sub>4</sub>-50% pea + 50% oat; A<sub>5</sub>-75% pea + 25% oat; B<sub>1</sub>-control, treatment without bacterial inoculant; B<sub>2</sub>-treatment with bacterial inoculant; CA-Instantaneously solubilizable CHO; CB<sub>1</sub>-Rapidly degradable CHO; CB<sub>2</sub>-Intermediately degradable CHO; CB<sub>3</sub>- Slowly degradable CHO; CC-Undegradable CHO; Different letters denote significantly different means ( $P < 0.05$ )

When CNCPS CHO fractions of pea:oat silages (Table 2) were interpreted, it was observed that silages with higher pea proportion contained higher CA fraction indicating that these

silages were better sources of fermentable CHO to ruminants. Among pea:oat silages, silage with the highest pea proportion contained the highest CB<sub>1</sub> fraction. CB<sub>2</sub> fraction was the lowest in oat silage, and its content increased with increasing pea proportion in pea:oat silages. The amount of fraction CB<sub>3</sub> is very important as this fraction represents the available cell wall portion of ruminant feeds (Das et al., 2015). Pea silage contained the lowest CB<sub>3</sub> fraction as pea is high in protein content and low in aNDF and ADF content. Among other silages the highest CB<sub>3</sub> fraction was detected in oat silage, and content of this fraction decreased with increasing pea proportion in pea:oat mixtures. Fraction CC is the lignin bound cell wall content of a feed and this fraction is indigestible both by ruminal microbes and the animal itself. Feeds with low CC fraction will be of superior quality in terms of CHO supply to ruminants and vice-versa (Das et al., 2015). On this aspect, silages like pea and ensiled pea:oat mixtures with higher proportion of pea were found to be better feeds. Bacterial inoculant addition increased CB<sub>2</sub> and CC fraction, but decreased CA and CB<sub>3</sub> fraction of investigated ensiled pea:oat mixtures. Most studies performed with pea-based silages in the diets of dairy cows have used cows of low or intermediate yield, i. e. about 20 kg day<sup>-1</sup> (Salawu et al., 2002, Adesogan et al., 2004) and few published studies have described the effects of using pea-based silages in diets of intermediate or high-yielding dairy cows (Mustafa et al., 2000; Pursiainen and Tuori, 2006; Rondahl et al., 2006).

### **Conclusions**

According to the data obtained from this research work, it was realized that pea and oat can be planted successfully for herbage and hay production. Moreover, pea and oat mixtures can be successfully ensiled and obtained high quality silages. The highest CHO fraction of ensiled pea : oat mixtures was CB<sub>3</sub>. Pea silage had the highest CB<sub>2</sub> fraction of carbohydrates. Application of bacterial inoculant affected higher CB<sub>2</sub> and CC fraction, but lower CA and CB<sub>3</sub> carbohydrate fraction of ensiled pea:oat mixtures. Increasing pea proportion in the mixtures affected increasing CA and CB<sub>2</sub> fractions, whereas CB<sub>3</sub> and CC carbohydrate fractions decreased.

### **Acknowledgments**

The authors thank the Ministry of Education, Science and Technological Development of Republic of Serbia who funded this research as part of the project TR-31057.

### **References**

- AOAC- Association of Official Analytical Chemists (1990). Official methods of analysis. 15th ed. AOAC, Arlington, VA.
- Adesogan, A. T. and Salawu, M. B. (2002). The effect of different additives on the fermentation quality , aerobic stability and in vitro digestibility of pea/wheat bi-crop silages containing contrasting pea to wheat ratios. *Grass and Forage Science*, Vol. 57, 25-32.
- Adesogan, A. T., Salawu, M. B., Williams, S. P., Fisher, W. J., Dewhurst, R. J. (2004). Reducing concentrate supplementation in dairy cow diets while maintaining milk production with pea-wheat intercrops. *Journal of dairy science*, 87, 3398-3406.
- Anil, L., Park, J., Phips, R. H., Miller, F. A. (1998). Temperate intercropping of cereals for forage: a review of the potential for growth and utilization with particular reference to the UK. *Grass and Forage Science*, Vol. 53, 301-317.

- Børsting, C. & Weisbjerg, M. (2002). Effects of whole crop pea silage and grass silage on performance of dairy cows. Proceedings of the 19<sup>th</sup> General Meeting of the European Grassland Federation, La Rachele, France, 184-185.
- Das, K. I., Kundu, S. S., Kuwar, D., Datt, C. (2015). Fractionation of carbohydrate and protein content of some forage feeds of ruminants for nutritive evaluation. *Veterinary World*, 8, 197-202.
- De Boever, J. L., Cottyn, B. G., Buysse, F. X., Wainman, F. W., Vanacker, J. M. (1986). The use of enzymatic technique to predict digestibility, metabolizable and net energy of compound feedstuffs for ruminants. *Animal Feed Science and Technology*, Vol. 14, 203-214.
- Faulkner, J. S. (1985). A comparison of faba beans and peas as whole-crop forages. *Grass and Forage Science*, Vol. 40, 161-169.
- Hall, M. B., Hoover, W. H., Jennings, J. P., Webster, T. K. M. (1999). A method for partitioning neutral detergent soluble carbohydrates. *Journal of the Science of Food and Agriculture*, Vol. 79, 2079-2086.
- Hall, M. B. (2000). Neutral detergent-soluble carbohydrates. Nutritional relevance and analysis. Ed. University of Florida. Bulletin 339. US.
- Kwabiah, A. B. (2004). Biological efficiency and economic benefits of pea-barley and pea-oat intercrops. *Journal of Sustainable Agriculture*, Vol. 25 (1), 117-128.
- Lanzas, C., Sniffen, C. J., Seo, S., Tedeschi, L. O., Fox, D. G. (2007). A revised CNCPS feed carbohydrate fractionation scheme for formulating rations for ruminants. *Animal feed and science technology*, 136, 167-190.
- Mustafa, A. F., Christensen, D. A., McKinnon, J. J. (2000). Effects of pea, barley and alfalfa silage on ruminal nutrient degradability and performance of dairy cows. *Journal of Dairy Science*, Vol. 83, 2859-2865.
- Mustafa, A. F. and Seguin, P. (2004). Chemical composition and in vitro digestibility of whole-crop pea and pea-cereal mixture silages grown in south-western Quebec. *Journal of Agronomy and Crop Science*, Vol. 190, 416-421.
- NRC-National Research Council (2001). Nutrient requirements of dairy cattle. 7<sup>th</sup> revised ed. National Academic Science, Washington, DC, USA.
- Omokanye, T. A. (2014). On farm testing of strip intercropping of annual crops for forage yield and quality. *International Journal of Agronomy and Agricultural Resereach*, Vol. 4 (4), 65-76.
- Pursiainen, P. and Tuari, M. (2006). Replacing grass silage with pea-barley intercrop silage in the feeding of the dairy cow. *Agricultural and Food science*, Vol. 15, 235-251.
- Rondahl, T., Bertlsson, J., Lindgren, E., Martinsson, K. (2006). Effects of stage of maturity and conservation strategy on fermentation, feed intake and digestibility of whole-crop pea-oat silage used in dairy production. *Acta Agriculturae Scandinavica, Section A, Animal Science*, Vol. 56, 137-147.
- Salawu, M. B., Adesogan, A. T., Weston, C. N., Williams, S. P. (2001). Dry matter yield and nutritive value of pea / wheat bi-crops differing in maturity at harvest, pea to wheat ratio and pea variety. *Animal Feed Science and Technology*, Vol. 94, 77-87.
- Salawu, M. B., Adesogan, A. T., Dewhurst, R. J. (2002). Forage intake, meal patterns and milk production of lactating dairy cows fed grass silage or pea-wheat bi-crop silages. *Journal of dairy science*, Vol. 85, 3035-3044.
- Van Soest, P. J., Robertson, J. B., Lewis, B. A. (1991). Methods for dietary fiber, NDF and nonstarch polyaccharides in relation to animal nutrition. *Journal of Dairy Science*, Vol. 74, 3583-3597.

## INFLUENCE OF THE SEASON AND STAGE OF LACTATION ON THE MILK PARAMETERS AND UREA CONCENTRATION IN COW MILK

Ksenija ČOBANOVIĆ<sup>1\*</sup>; Denis KUČEVIĆ<sup>1</sup>, Miroslav PLAVŠIĆ<sup>1</sup>, Vladan BOGDANOVIĆ<sup>2</sup>

<sup>1</sup>University of Novi Sad, Faculty of Agriculture, Novi Sad, Serbia

<sup>2</sup>University of Belgrade, Faculty of Agriculture, Zemun, Serbia

\*Corresponding author: ksenija.cobanovic@stocarstvo.edu.rs

### Abstract

Urea is a metabolic product in cow's milk and affected by nutritional and some non-nutritional factors. The study was conducted in order to determine the effect of seasons and stage of lactation on milk urea (MU) and other milk production traits (fat, protein and daily milk yield) in Holstein breed cow's milk, from 11 dairy cattle farms in Province of Vojvodina (Republic of Serbia). This research included 35,467 milk samples, from 3223 cows, which were analyzed as a part of Dairy Herd Improvement (DHI) program, from June 2013 to January 2016. Statistical data processing was carried out by applying General Linear Model procedure, Statistics 13. Significant differences in MU concentrations and milk parameters were observed between seasons ( $P < 0.01$ ) and stage of lactation ( $P < 0.01$ ). The seasonal observation shows the lowest MU concentration (20.61 mg/dl) in autumn period and the highest in spring period (26.89 mg/dl). The highest milk fat and protein content was in autumn, when the daily milk production was the lowest. The lowest concentration of MU was at the beginning of lactation (21.91 mg/dl) and the highest (26.11 mg/dl) was from 121 to 180 days of lactation. The maximum daily milk yield (32.42 kg) was between 61 and 120 days of lactation. It was concluded that milk urea concentration should be evaluated in association with season and stage of lactation and also in association with daily milk yield, fat and protein content in the milk. It could contribute to improving feeding on dairy farms and lead to reduction of feeding costs too.

**Keywords:** *milk urea, Holstein breed, season, stage of lactation*

### Introduction

Milk is a complex food which composition includes fats, proteins, lactose, mineral, vitamins and other micelle constituents dispersed in water. Urea as a part of non-protein fraction of nitrogen in the milk represents the final product of protein metabolism in the rumen of ruminants. MU concentration can be used as a practical tool to monitor dietary crude protein and energy intake, relative to requirements. Improving the efficiency of dairy production by the proper nutrition balancing can contribute of less nitrogen losses, environmental pollution and more profitable milk production. The aim is to improve efficiency, reduce cost of production and reduce nitrogen excretion into the environment (Stoop et al., 2007). The main components of milk are influenced by several factors such as genetics, age, stage of lactation, udder health, diet, season (Festila et al., 2012). Milk urea content can be influenced by: herd (Rajala-Schultz and Saville, 2003), season (Hojman et al., 2004; Fatehi et al., 2012), milk yield (Arunvipas et al., 2003; Hojman et al., 2005), stage of lactation (Godden et al., 2001; Rajala-Schultz and Saville, 2003; Fatehi et al., 2012), parity (Arunvipas et al., 2003; Wood et al., 2003; Hojman et al., 2004;), breed (Rodriguez et al., 1997; Wattiaux et al., 2005), body weight (Jonker et al., 2002; Hojman et al., 2005), etc.

The objective of this study was to determine how seasons and stage of lactation have an effect on the milk parameters and urea concentration in Holstein breed cow's milk in Province of Vojvodina.

### Material and Methods

The study included 3223 Holstein cows, from 11 Vojvodina dairy farms. 35,467 individual cow milk samples were collected by monthly DHI milk test from June 2013 to January 2016. Milk urea and milk chemical composition were determined by the infrared test method (ISO 9622:2013) by MilcoScan FT. To convert MU to MUN (milk urea nitrogen), the following conversion formula was used  $MUN \text{ (mg/dl)} = MU \text{ (mg/dl)} \times 0.4667$  (Oudah, 2009). Dataset included: farm code, date of test (season), days in milk – DIM (interval between date of calving and milk test day), daily milk yield, milk fat and milk protein content and MU concentration (mg/dl). According to the season of sampling, milk samples were divided into four groups. Lactation was divided into 6 DIM intervals of 60 days each (first 60 days, 61 to 120 days, 121 to 180 days, 181 to 240 days, 240 to 300 and greater than 300 days). The average values and variability of examined traits as well as the effect of factors on mentioned traits were studied by means of the PROC UNIVARIATE and PROC GLM procedures within the Statistic software package (ver. 13 Stat-Soft Company, 2016). Post-hoc analysis (Duncan test) was used to determine the statistically significant differences between the mean values of different classes, with a significance level at  $P < 0.05$  and  $P < 0.01$ . The model equation used for the evaluation was as follows:

$$Y_{ij} = \mu + S_i + DIM_j + e_{ij}$$

where:

$Y_{ij}$  = MU, MF, P and DMY (dependent variable)

$\mu$  - mean value of dependent variable;

$S_i$  - fixed effect the Season  $i$  ( $i = 1$  - winter, 2- spring, 3-summer, 4-autumn),

$DIM_j$  - fixed effect the days in milk – stage of lactation,  $j = 1, 2, \dots, 6$

$e_{ij}$  - other random effects.

### Results and Discussion

The mean MU value in these data was 24.78 mg/dl (with standard deviation of 8.80 mg/dl) (Table 1) and within the optimal values from 15 to 30 mg/dl (Carlson and Pehrson, 1993; Moore and Varga, 1996). Average cow – level MU concentration was higher than values reported in the study of Kohn et al. (2004), but lower than values reported by Wattiaux and Karg (2004), Zadeh-Hossein and Ardalán (2011) and Fatehi et al. (2012) for Holstein dairy cows. The coefficient of variation for the milk urea content (35.50%) was higher than the coefficient of variation for the other milk components. Stoop et al. (2007), Bastin et al. (2009), Bouwman et al. (2010), Zadeh-Hossein and Ardalán (2011) and Čobanović et al. (2015) also found higher CV for MU then other milk ingredients.

Table 1. Means, standard deviation (SD) and coefficient of variation (CV) of analyzed variables

Trait	N	Mean	SD	CV (%)
MU (mg/dl)	35467	24.78	8.80	35.50
MUN (mg/dl)	35467	11.57	4.11	35.50
Fat (%)	35467	3.78	0.87	23.11
Protein (%)	35467	3.31	0.42	12.55
DMY (kg)	35467	26.70	10.05	37.66

MU – milk urea; MUN – milk urea nitrogen; DMY – Daily milk yield (kg) on the test day



According to the data in Table 2, season had significant effect on MU concentration in Holstein cows and other examined traits (the values of F-test in all cases are highly significant). Konjačić et al. (2015) and Kučević et al. (2016) found that season statistical significant influenced on milk parameters. Fat (3.88%) and protein (3.44%) content of milk were significantly higher in autumn and the lowest in the summer season (milk fat 3.66%, protein 3.19%). Bendelja et al (2011) and Zlatković (2014) also reported higher milk fat and protein content in autumn-winter season and lowest in spring-summer season. Milk urea concentration (20.61 mg/dl) and also DMY (24.56 kg) were lower in autumn. During the spring MU concentration was the highest (26.89 mg/dl). Similar results have been reported by: Hojman et al. (2004), Abdouli et al. (2008), Bastin et al., (2009) and Fatehi et al. (2012). Higher MUN concentration in the winter period was reported by Jilek et al. (2006). DMY was the highest in the winter (27.90 kg). Zlatković (2014) found the lowest DMY in the August and the highest in the March.

Table 2. Effect of the season on milk fat and protein content, daily milk yield and milk urea concentration

Season of sampling	N	Trait			
		Fat (%)	Protein (%)	DMY (kg)	MU (mg/dl)
1	8764	3.83 <sup>a</sup>	3.38 <sup>a</sup>	27.90 <sup>a</sup>	24.96 <sup>a</sup>
2	8448	3.76 <sup>b</sup>	3.24 <sup>b</sup>	27.83 <sup>a</sup>	26.89 <sup>b</sup>
3	9216	3.66 <sup>c</sup>	3.19 <sup>c</sup>	26.61 <sup>b</sup>	26.79 <sup>b</sup>
4	9057	3.88 <sup>d</sup>	3.44 <sup>d</sup>	24.56 <sup>c</sup>	20.61 <sup>c</sup>
F		<b>126.0**</b>	<b>944**</b>	<b>170.2**</b>	<b>954.21**</b>

- <sup>a,b,c,d</sup> Means within the same column with different superscripts differ statistical significantly (P<0.01)
- Statistical significant differences: \* P<0.05; \*\* P<0.01;

The content of milk fat, protein, MU and daily milk yield, were significantly influenced by the stage of lactation (Table 3). The high values of the F- ratios are the proof of the important influence of the stage of lactation on the examined variables.

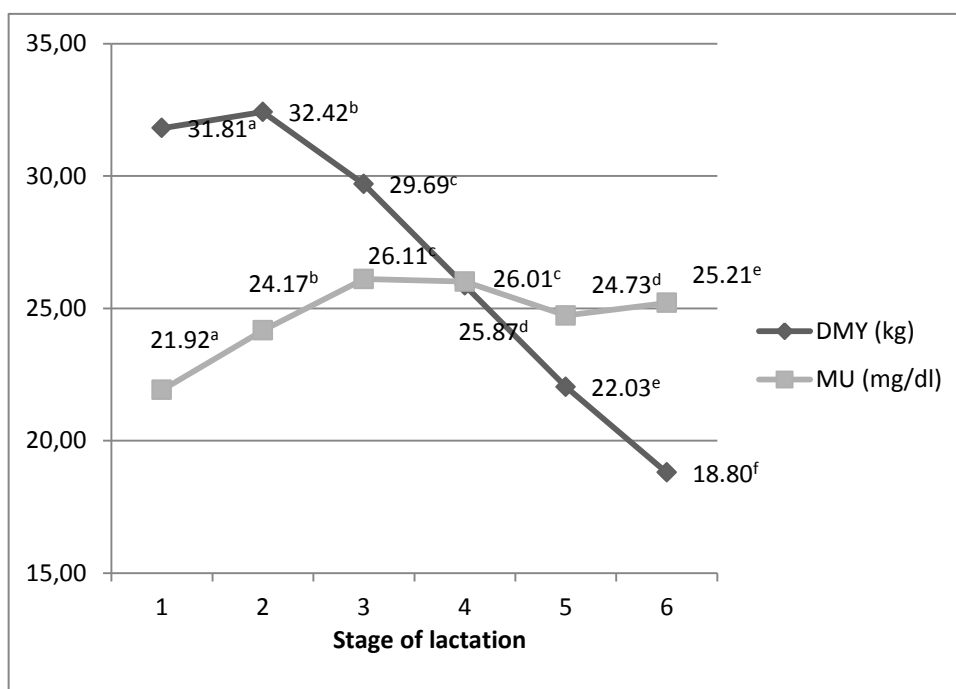
Table 3. Effect of the stage of lactation on milk fat and protein content, daily milk yield and milk urea concentration

Stage of lactation	N	Trait			
		Fat (%)	Protein (%)	DMY (kg)	MU (mg/dl)
1	4948	3.85 <sup>a</sup>	3.03 <sup>a</sup>	31.81 <sup>a</sup>	21.92 <sup>a</sup>
2	6265	3.56 <sup>b</sup>	3.06 <sup>b</sup>	32.42 <sup>b</sup>	24.17 <sup>b</sup>
3	6284	3.61 <sup>c</sup>	3.21 <sup>c</sup>	29.69 <sup>c</sup>	26.11 <sup>c</sup>
4	6125	3.75 <sup>d</sup>	3.34 <sup>d</sup>	25.87 <sup>d</sup>	26.01 <sup>c</sup>
5	5773	3.89 <sup>e</sup>	3.52 <sup>e</sup>	22.03 <sup>e</sup>	24.73 <sup>d</sup>
6	6072	4.06 <sup>f</sup>	3.69 <sup>f</sup>	18.80 <sup>f</sup>	25.21 <sup>e</sup>
F		<b>296.6**</b>	<b>3437**</b>	<b>2374.9**</b>	<b>170.6**</b>

- <sup>a,b,c,d, e, f</sup> Means within the same column with different superscripts differ statistical significantly (P<0.01)
- Statistical significant differences: \* P<0.05; \*\* P<0.01;

The concentration of MU was significantly (P<0.01) lower in the first 60 DIM (21.92 mg/dl). Carlsson et al. (1995) explained the lower MUN content in the first month of lactation as the inability of cows to digest a sufficient amount of feed at the beginning of lactation which resulted in a relatively lower intake of proteins. On the Graf 1. it can be seen that the peak

of lactation was between 60 and 120 days. Some authors found out that peak of lactation is between 4 and 8 weeks (Čobić and Antov, 1996; Park and Lindberg, 2004), but Piccardi et al. (2014) reported that peak of lactation about 122 days. Maximum MU level was between 121 and 180 DIM (26.11 mg/dl), this was a signal of the excess protein in diet of cows in period after the peak of lactation. Similar results were reported in other studies (Hojman et al., 2004; Fatehi et al., 2012).



Different letters of superscript mean statistical significant difference at the level of  $P < 0.01$

Graf 1. Daily milk yield and milk urea concentration in milk by stage of lactation

### Conclusion

The obtained results indicate that the season and stage of lactation had a highly significant effects ( $P < 0.01$ ) on milk urea concentration, milk fat and protein content and daily milk yield. The results suggest that MU should be evaluated in the association with the season and stage of lactation when determining the efficiency of N utilization.

Maintaining and monitoring MU in dairy herds provide an opportunity to formulate the dietary protein constituency that optimizes nitrogen utilization for milk production and to have more profitable milk production and less environmental pollution.

### References

- Abdouli, H., Rekik, B., Haddad-Boubaker, A. (2008). Non-nutritional factors associated with milk urea concentrations under Mediterranean conditions. *World Journal of Agricultural Sciences* 4 (2) 183-188.
- Arunvipas, P., van Leeuwen, J.A., Dohoo, I.R., Keefe, G.P. (2003). Evaluation of the reliability and repeatability of automated milk urea nitrogen testing. *The Canadian Journal of Veterinary Research* 67 (1) 60-63.
- Bastin, C., Laloux, L., Gillon, A., Miglior, F., Soyeurt, H., Hammami, H., Bertozzi, C., Gengler, N. (2009). Modeling milk urea of Walloon dairy cows in management perspectives. *Journal of Dairy Science* 92(7) 3529-3540.

- Bendelja, D., Prpić, Z., Mikulec, N., Ivkić, Z., Havranek, J., Antunac, N. (2011). Milk urea concentration in Holstein and Simmental cows. *Mljekarstvo* 61 (1) 45-55.
- Bouwman, A. C., Schopen, G. C. B., Bovenhuis, H., Visker, M. H. P. W., van Arendonk, J. A. M. (2010). Genome-wide scan to detect quantitative trait loci for milk urea nitrogen in Dutch Holstein-Friesian cows. *Journal of Dairy Science* 93 (7) 3310-3319.
- Carlson, J., Bergstrom, J., Pehrson, B. (1995). Variations with breed, age, season, yield, stage of lactation, and herd in the concentration of urea in bulk milk and individual cow milk. *Acta Vet. Scand.* 36 (2) 245-254.
- Carlson, J., Pehrson, B. (1993). The relationship between seasonal variations in the concentration of urea in bulk milk and the production and fertility of dairy herds. *Journal of American Vet. Med. Assoc.* 40, 205-212.
- Čobanović, K., Kučević, D., Trivunović, S., Plavšić, M. (2015). Variability of milk urea on Vojvodina's dairy farms. VI International Scientific Agricultural Symposium "Agrosym 2015" Jahorina. 16 – 18 October 2015. Bosnia and Herzegovina. 1665-1671.
- Čobić, T., Antov, G. (1996). Cattle breeding, milk production. Faculty of agriculture. Novi Sad.
- Fatehi, F., Zali, A., Honarvar, M., Dehghan – Banadaky, M., Young, A.J., Ghiasvand, M., Eftekhari, M. (2012). Review of the relationship between milk urea nitrogen and days in milk, parity, and monthly temperature mean in Iranian Holstein cows. *Journal of Dairy Science* 95 (9) 5156-5163.
- Festila, I., Miresan, V., Raducu, C., Cocan, D., Constantinescu, R., Coroian, A. (2012). Study on season influence on milk quality for dairy cow population of Romanian spotted breed. *Bulletin UASVM Animal Science and Biotechnologies* 69 (1-2) 313-314.
- Godden, S.M., Kelton, D.F., Lissemore, K.D., Walton, J.S., Leslie, K.E., Lumsden, J.H. (2001). Milk urea testing as a tool to monitor reproductive performance in Ontario dairy herds. *Journal of Dairy Science* 84 (1) 1397-1426.
- Hojman, D., Kroll O., Adin, G., Gips, M., Hanocchi, B., Ezra E. (2004). Relationships between milk urea and production, nutrition, and fertility traits in Israeli dairy herds. *Journal of Dairy Science* 87 (4) 1001-1011.
- Hojman, D., Gips, M., Ezra, E. (2005). Association between live body weight and milk urea concentration in Holstein cows. *Journal of Dairy Science* 88 (2) 580-584.
- ISO 9622 (2013). Milk and liquid milk products -- Guidelines for the application of mid-infrared spectrometry.
- Jilek, F., Rehak, D., Volek, J., Štipkova, M., Nemecova, E., Fiedlerov, M., Rajmon, R., Švestkova, D. (2006). Effect of herd, parity, stage of lactation and milk yield on urea concentration in milk. *Czech J. Anim. Sci.* 51 (12) 510-517.
- Jonker, J.S., Kohn, R.A., High, J. (2002). Use of milk urea nitrogen to improve dairy cow diets. *Journal of Dairy Science* 85 (4) 939-946.
- Kohn, R. A., French, K. R., Russek – Cohen, E. (2004). A comparison of instruments and laboratories used to measure milk urea nitrogen in bulk-tank milk samples. *Journal of Dairy Science* 87 (6) 1848-1853.
- Konjačić, M., Marković, T., Ivanković, A., Stručić, D. (2015). Utjecaj godine i sezone na kemijski sastav i higijensku kvalitetu ekološki proizvedenog kravljeg mlijeka. *Stočarstvo* 69 (3-4) 45-53.
- Kučević, D., Trivunović, S., Bogdanović, V., Čobanović, K., Janković, D., Stanojević, D. (2016). Composition of raw milk from conventional and organic dairy farming. *Biotechnology in Animal Husbandry* 32 (2) 133-143.
- Moore, D.A., Varga, G. (1996). BUN and MUN: urea nitrogen testing in dairy cattle. *Comped. Cont. Educ. Pract. Vet.* 18 (12) 712-720.

- Oudah, E.Z.M. (2009). Non-genetic factors affecting somatic cell count, milk urea content, test-day milk yield and milk protein percent in dairy cattle of the Czech Republic using individual test-day records. *Livestock research for Rural Development* 21(5) 1-15.
- Park, C., Lindberg, G. L. (2004). The mammary gland and lactation. In *Dukes physiology of domestic animals*. 12<sup>th</sup> ed. Cornell University Press, Ithaca, London.
- Piccardi, M., Pipino, D., Bo, G. A., Balzarini, M. (2014) Productive and reproductive performance of first lactation purebred Holstein versus Swedish red & white X Holstein in central Argentina. *Livestock Science*, 165, 37-41.
- Rajala-Schultz, P.J., Saville, W.J.A. 2003. Sources of variation in milk urea nitrogen in Ohio dairy herds. *Journal of Dairy Science* 86. 1653-1661.
- Rodriguez, L.A., Stallings, C.C., Herbein, J.H., McGilliard, M.L. (1997). Effect of degradability of dietary protein and fat on ruminant blood and milk components of Jersey and Holstein cows. *Journal of Dairy Science* 80 (2) 353-363.
- StatSoft. 2016. *Statistica* – version 13.
- Stoop, W.M., Bovenhuis, H., van Arendonk, J.A.M. (2007). Genetic parameters for milk urea nitrogen in relation to milk production traits. *Journal of Dairy Science* 90 (4) 1981-1986.
- Wattiaux, M.A., Karg, K.L. (2004). Protein level for alfalfa and corn silage – based diets: I. Lactation response and milk urea nitrogen. *Journal of Dairy Science* 87 (10) 3480-3491.
- Wattiaux, M.A., Nordheim, E.V., Crump, P. (2005). Statistical Evaluation of factors and interactions affecting dairy herd improvement milk urea nitrogen in commercial Midwest dairy herds. *Journal of Dairy Science* 88 (8) 3020-3035.
- Wood, G.M., Boettcher, P.J., Jamrozik, J., Jansen, G.B., Kelton, D.F. (2003). Estimation of genetic parameters for concentrations of milk urea nitrogen. *Journal of Dairy Science* 86 (7) 2462-2469.
- Zadeh-Hosseini, N.G., Ardalan, M. (2011). Estimation of genetic parameters for milk urea nitrogen and its relationship with milk constituents in Iranian Holsteins. *Livestock Science* 135 (2-3) 274-281.
- Zlatković, N. (2014). Uticaj ambijetalnih uslova na konzumiranje hrane i rad mlečne žlezde kod krava. PhD, Megatrend Univerzitet – Beograd, Fakultet za biofarming – Bačka Topola.

## EFFECT OF AGE OF YOUNG SIMMENTAL BULLS ON THE CLASS CARCASS AND DEGREE OF FAT TISSUE CARCASS COVERING

Miloš Ž. PETROVIĆ<sup>1\*</sup>, Radojica D. ĐOKOVIĆ<sup>1</sup>, Milun D. PETROVIĆ<sup>1</sup>, Marko R. CINCOVIĆ<sup>2</sup>, Zoran Ž. ILIĆ<sup>3</sup>, Simeon Ž. RAKONJAC<sup>1</sup>, Neđeljko R. KARABASIL<sup>4</sup>

<sup>1</sup>University of Kragujevac, Faculty of Agronomy Čačak, Cara Dušana 34, Čačak, Republic of Serbia

<sup>2</sup>University of Novi Sad, Faculty of Agriculture, Trg Dositeja Obradovića 8, 21000 Novi Sad, Republic of Serbia

<sup>3</sup>University of Priština, Faculty of Agriculture Lešak, 38219 Lešak, Republic of Serbia

<sup>4</sup>University of Belgrade, Faculty of Veterinary Medicine, Bulevar oslobođenja 18, 11000 Beograd, Serbia

\*Corresponding author: petrovic.milos87@kg.ac.rs

### Abstract

The quality of slaughtered animals is a subject of interest, of both primary production and the meat industry. The aim of the study was to analyze the effect of age of Simmental young beef cattle (bulls) on the class and degree of fat tissue carcass covering in a slaughterhouse in Raska district, according to the standard applied in the European Union (Council Regulation (EC) N 1234/2007, Commission Regulation (EC) N 1249/2008; European Commission, Directorate-General for Agriculture and Rural Development). The rules defining the quality of meat have been partially applied in Serbia (Official Gazette of the SFRJ 34/74, 26/75, 13/78). The quality assessment, classification and determining the degree of the carcass fat tissue covering is performed immediately after a veterinary examination and measurement of the carcasses weight. The study was conducted on 116 young cattle (young bulls) carcasses of domestic Simmental breed from redemption, which are divided into two age groups. The first group were cattle of age from 269 to 350 days ( $n = 78$ ) and the second 351- 450 days of age ( $n = 38$ ). The results showed that the tested groups differed significantly ( $P < 0.05$ ) in the values of animals weight prior to slaughter and carcasses weight after primary processing. The average weight of cattle in the first group was 508.89 kg and 531.2 kg in the second, while the average slaughter weight of the hull in the first group was 268.83 kg and 279.97 kg in the second. Both observed age groups had identical average class 4.66. Fat tissue coverage degree of carcass in the first group was estimated an average score of 3.09, while the average rating of fat tissue coverage degree of carcass in the second group was somewhat higher (3.21), but this difference was not statistically confirmed ( $P > 0.05$ ). The given results show that it is necessary to intensify the upgrading of primary production in order to achieve better quality of meat.

**Key words:** Age, Simmental cattle, Class, Fat tissue coverage.

### Introduction

Global population growth in last few decades increases the livestock products demand, therefore in 2016, according to FAO data (*Food Outlook, Biannual Report on Global Food Markets, 2016*) 320.7 million tons of meat were produced worldwide which is by 0.3% more compared to production in 2015. Beef world production in its scope is in third place, behind pork and poultry meat. In total production, poultry participates with 36.23% (116.2 tons), 36.3% pork (116.4 million tons), beef 21.32% (68.4 million tons) and mutton 4.4% (14.1 million tons) according to FAO 2016. On the other hand, the US (19%), Brazil (15%) and the European Union, (13%) produce approximately 47% of global beef production, i.e. less than one-half of the beef in the world. Globally observed, since 1960 the entire meat production

tripled, milk production nearly doubled, and egg production increased four times (Speedy, 2003). The world's average annual meat consumption per capita in 2016 amounted 43.4 kg. In the EU countries there are significant differences in the beef consumption between the individual member states. Thus, in 2011 per capita consumption in France was 25.4 kg, 19.7 kg in Slovenia, 17.3 kg in Austria, in Romania it was 6.5 kg while in Bulgaria it was only 4.5 kg (Grgić and Rakić, 2015). In the last decade, in Serbia is present continuously negative trend of total number of cattle with an average annual decline by 2-3% (Petrović et al., 2011). Number of cattle in 2013 was only 913. 000 and it is the smallest in the period since 1995 to 2013 and a slight increase was recorded in 2014 (920.000). In registered slaughterhouses 302.000 bovines were slaughtered in 2015, which is by 45.9% less than in 1995 (658.000 slaughtered animals). According to official statistics in Serbia 70.000 tons of beef have been produced in 2013, 73.000 tons in 2014 and 77.000 tons in 2015. The low production of beef in Serbia has also resulted in low consumption - the annual consumption in 2003 was 6.1 kg, 3.6 kg in 2005, 4.5 kg in 2007, and only 3.5 kg in 2010 (Zlatanović, 2012). However considering current situation, production and consumption of beef in the Republic of Serbia is very low despite natural resources and Simmental breed of cattle with a predisposition for fattening. In last 20 years, the selection was enacted for the purpose of milk production, but it can be said as well that the production of meat was developed through selection work. This is best indicated by the fact that young bulls were first tested for growth traits and physical development, and tested to progeny test for milk traits and conformation. Maternal characteristics, feed conversion ratio, as well as the quantitative and qualitative characteristics of carcass and meat are substantial for meat production (Bogdanović et al., 2005). Having in mind that the beef production in Serbia is based on Simmental race, selection must be meant to improve fattening and slaughter characteristics and to ensure retention of already achieved level of milk production. It is necessary to breed the domestic cow with lower production traits with bulls of breeding races such as the French, Italian and English. The aim of this crossing is the usage of heterosis effect in creating the genotype, which will result in the final body weight in the F1 generation of 550 kg, the average daily weight gain of 1500 g, carcass yield of above 60% and the content of the muscle tissue in the body of more than 60% (Petrovic et al., 2007). On the other hand, the Republic of Serbia is currently in the process of joining the EU and it is necessary to make certain amendments to the existing regulations and adopt new ones in order to make meat originating from Serbia competitive on the European market. This will mean that payments to farmers-owners of animals will be conducted according to the achieved quality, not live weight.

### **Material and Methods**

According to the Rulebook on the quality of animals for slaughter, poultry and game (Official Gazette of SFRY 34/74, 26/75, 13/78) carcasses or half-carcasses in Serbia are classified into categories according to age (three age groups): (1) veal (age in both sexes up to 6 months); (2) beef (bull the age of 6 to 18 months; female and castrated males between the ages of six to 30 months); (3) of cattle (bull the age over 18 months; female and castrated males over the age of 30 months). Within each of these age groups, grading of carcasses is provided according to certain criteria such as: (1) carcass weight (or mass of the two halves); (2) conformation of the carcass; (3) fat tissue covering and meat marbling of carcass; (4) color of muscle and fat, and (5) texture and consistency of muscle and fat tissue.

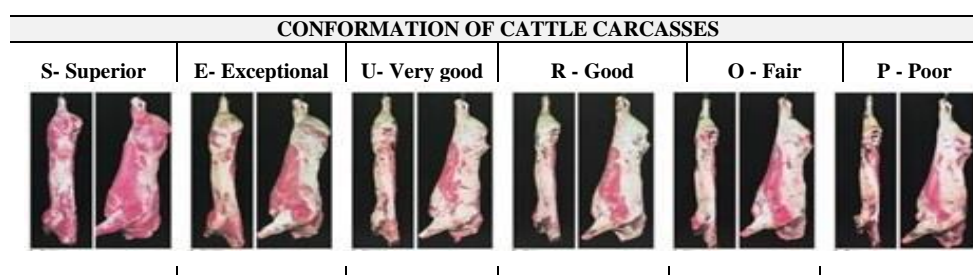
Weight of the carcass implies carcass with removed skin, head, lower legs (separated in the compartment and the carpal joint), tail and all the viscera thoracic, abdominal and pelvic cavities have been removed, with the exception of kidney and renal adipose tissue. Half represents the slit carcass along the line of separation, through the center of the vertebrae, pelvic and thorax. A favorable conformation (excellent) of carcass implies that all profiles are extremely well developed and convex. Butch fleshy carcasses have a convex profile, the back are

well developed and wide, and the blades are filled and well-formed. Poor or unfavorable torso / hemisphere conformation is characterized by concave, but poorly developed, back are narrow, the blade is straight and noticeable are convex bones (Regulations of quality of beef carcass and half, Official Gazette of R. of Croatia no. 2/09).

Fat tissue coverage refers to the amount and allocation of subcutaneous, kidney and pelvic fat tissue and residues on the inside surfaces of the chest and abdominal cavity. From a quality point of view, it is considered a favorable overlap when the carcasses or hemispheres have a uniform and well-distributed, continuous, but not too thick layer of fatty tissue.

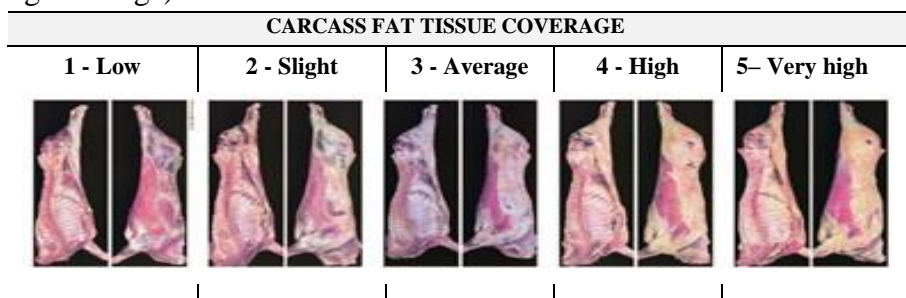
Following parameters are used for classification of cattle carcasses in the EU countries: carcass weight, category of slaughtered animal according to age and physiological condition, class based on conformation, muscular development of the carcass or half as well as the development of the basic parts (but, the back and shoulders), the degree of coverage of fat tissue, etc. Carcasses or half-carcasses are classified into categories based on the age and physiological status of the animal on: calves (up to eight months old), elderly calves (from eight to 12 months old), heifers (female animals that have not calved), young bulls (up to 24 Month olds), bulls (older than 24 months), castrated male animals and cows (female animals that have calved) (Council Regulation (EC) N° 1234/2007, Commission Regulation (EC) N° 1249/2008; Commission European, Directorate-General for Agriculture and Rural Development).

Based on the development of the carcass, the carcasses are classified into one of six classes according to the system represented in the EU: S (superior), E (excellent), U (very good), R (good), O (fair), and P (poor), image 1.



**Image 1.** Carcass of adult cattle and grading (SEUROP) in EU countries (Council Regulation (EC) N° 1234/2007, Commission Regulation (EC) N° 1249/2008; Commission European, Directorate-General for Agriculture and Rural Development)

Fat tissue coverage (Image 2) is assessed by numerical grades from 1 (very low coverage) to 5 (very strong coverage).



**Image 2.** Adult cattle carcass fat tissue coverage and evaluation in the EU countries (Council Regulation (EC) N° 1234/2007, Commission Regulation (EC) N° 1249/2008; Commission European, Directorate-General for Agriculture and Rural Development)

The study was conducted in the period from 10.07.2014 to 04.08.2014, in one slaughterhouse in the Raska district. The study was included 116 carcasses of young cattle (young bulls) of domestic Simmental breed, which were divided into two groups according to age. The first group were cattle age from 269 to 350 days (n = 78) and the second 351- 450 days (n = 38). The aim of this study was to examine the effect of age of young Simmental cattle (young bulls) to class and fat tissue

coverage degree in slaughterhouse by following appropriate criteria. In order to accomplish this objective, tasks were set to test the quality of beef cattle (bulls) by monitoring the following parameters: live animals mass, slaughtered weight of the carcass, carcass class on the basis of conformation, fat tissue coverage, the accuracy of the slaughter of carcass.

Measuring the weight of the animal prior to slaughter was carried out on the scale with accuracy of  $\pm 0.5$  kg, immediately after animals were brought to the slaughterhouse. Measuring the mass of the carcass after slaughter was carried out on the scale with accuracy of  $\pm 0.5$  kg, at least 45 minutes after the slaughter. Carcass weight includes processed carcass without internal organs (with the exception of the kidneys), skin, head, lower parts of legs (separated in the lower part of the carpal, tarsal joints is measured respectively), large blood vessels, spinal cord and the genital organs.

At the end of the processing line, assessment of slaughter processing of carcass was performed by the classifier (veterinary or agronomist staff): carcass without internal organs (except kidneys), skin, head, lower parts of the legs (separate in the lower carpal or tarsal joint), large blood vessels, spinal cord and the genitals. After data have been collected, ANOVA procedure was applied for the statistical analysis. Statistical analysis was performed in a statistical package StatsSoft INC (1995).

## Results and Discussion

Sampling covered 116 cattle (young bulls). All of the carcasses have been processed adequately. Table 1 shows the average values per groups that include several parameters: live weight, slaughter weight, carcass class and fat coverage degree for all 116 carcasses of cattle that have been tested.

**Table 1.** Phenotypic manifestation and variability of slaughtering characteristics of young bulls of the Simental race, depending on age at slaughter

Age groups (days)	Characteristics	N	$\bar{x}$	S $\bar{x}$	SD	CV (%)	Variation interval		F <sub>exp</sub>
							Min.	Max.	
269-350	Weight before slaughter	78	508.89	5.05	44.60	8.76	388.00	613.00	F <sub>MBS</sub> =* F <sub>CM</sub> =* F <sub>COH</sub> =ns F <sub>DOTFC</sub> =ns
	Carcass weight	78	268.83	2.76	24.42	9.08	205.00	325.00	
	Class of carcass (1-5)	78	4.66	0.05	0.47	10.08	4.00	5.00	
	DOTFC(1-5)	78	3.09	0.03	0.28	9.06	4.00	5.00	
351-450	Weight before slaughter	38	531.32	11.01	67.85	12.77	417.00	713.00	F <sub>MBS</sub> =* F <sub>CM</sub> =* F <sub>COH</sub> =ns F <sub>DOTFC</sub> =ns
	Carcass weight	38	279.97	5.29	32.60	11.64	206.00	342.00	
	Class of carcass	38	4.66	0.07	0.48	10.30	4.00	5.00	
	DOTFC	38	3.21	0.07	0.41	12.77	3.00	4.00	

Weight before slaughter – WBS; Carcass weight – CW ; Class of carcass – COC; Degree of total fat cover (1-5) – DOTFC; ns - P>0.05; \* - P<0.05; \*\* - P<0.01; \*\*\* - P<0.001;

Results from Table 1 indicate that examined groups differed statistically significant (P<0.05) in the weight values of the animals before slaughter and the carcass mass after primary treatment. The average weight of cattle prior to slaughter in the first group was 508.89 kg and 531.2 kg in the second, while the average slaughter weight of the carcass in the first group was 268.83 and 279.97 kg in the second.

Both age groups tested, had identical average class rating - 4.66. Fat tissue coverage degree of carcasses in the first group was assessed with the average score of 3.09, while the average estimated fat tissue coverage degree of the carcasses in the second group was somewhat higher (3.21), but this difference was not statistically confirmed (P>0.05).

Petrović et al. (2017) came to similar results by analyzing the fat tissue coverage degree. The analysis included 123 young bulls. Three categories were stated (2, 3, 4). Only one carcasses was of the category 2. The category 3 was found at 107 carcasses, which is significantly more (p<0.01)



than in the category 2 and in category 4 (15 trunks.) Aleksić et al. (2002) state the following production results of male beef of domestic Simmental breed (weight of animals before slaughter 592.7 kg, weight of warm halter with basil 329.9 kg, yield 55.66%. In their experiment, Ostojić et al. (2011) found statistically significant differences ( $p < 0.01$ ) between crossbreeds and domestic Simmental breeds in terms of trophic conformation. Crossbreed Charolais achieved best assessment of conformation of carcasses (3.94), however slightly less than in our experiment. Also, significantly more fatt tissue on the outer part of the carcass was found in the domestic Simmental breed (3.44) compared to the Charolais crossbreed (3.27). Ostojic et al. (2007) came to similar results in their researches. In 477 days a final weight of Simmental bulls of 579 kg was achieved. In the same study, crossbreed of Charolais and Limousine at a younger age (446 and 443 days) achieved higher body weight at the end of the fattening (621 kg and 590 kg).

Results matching this were also published by Kögel et al. (1995), who found that crossbreed of Simmental with French flesh-colored races, Limousine and Blonde Aquitaine had better slaughter values than the Simmental breed: a higher randman, a better conformation of the hull, a larger proportion of muscle, and a smaller proportion of fatt tissue and bones in carcass.

### **Conclusions**

Based on the results and their critical consideration, following can be concluded:

- Average weight of live animals and slaughter weight in the first group (508.89 kg, 268.83 kg) were significantly lower ( $P < 0.05$ ) compared to the second group (531.2 kg and 279.97 kg);
- Both examined groups had identical average class rating grades - 4.66;
- There was no significant difference ( $P > 0.05$ ) in the fat tissue coverage degree (3.09: 3.21).

Consequently, the obtained results indicate that the age of the bulls does not affect the carcass class and the degree of fat cover.

### **References**

- ALEKSIĆ S., Miščević B., Petrović M. M., Pavlovski Zlatica, Josipović S., Tomašević Dušica. (2002). Investigation of factors affecting the results regarding the dressing percentage value of male young cattle of domestic Simmental breed and crossbreed of the Simmental and Limousine breed. *Biotechnology in Animal Husbandry* 18 (3-4), p 1-14.
- ALEKSIĆ S., Petrović M. M., Sretenović LJ., Pantelić V., Tomašević D., Ostojić-Andrić D. (2007): Cattle production: Current situation and future directions of development in Republic of Serbia. 2<sup>nd</sup>. International Congress on Animal Husbandry: New Perspectives and Challenges of Sustainable Livestock Farming, Belgrade-Zemun-Serbia, October 03th-05th. *Biotechnology in Animal Husbandry*, vol. 23 (5-6-1), p.1-10
- Bogdanović V., Đedović R., Petrović M. M. (2005). Selection of Simmental cattle on beef and meatiness traits in Serbia. *Biotechnology in Animal Husbandry*, 21 (3-4), 25-34.
- Food Outlook biannual report on global food markets October 2016 Food and Agriculture Organization of the United Nations
- Grgić I., Zrakić M. (2015). Samodostatnost Republike Hrvatske u proizvodnji govedeg mesa. *Meso*. 1, 51-56.
- Kögel J., Pickl M., Spann B., Obermaier A., Duda J. (1995). Cross-breeding experiment French meat breeds x Simmental. *INFO* 2/95 (1-53). BLT, Poing.
- Petrović Miloš, Radojica Đoković, Milun D. Petrović, Marko Cincović, Zoran Ž. Ilić, Nikola Čobanović, Nedeljko Karabasil (2017). Analysis of the degree covering of young bull carcass with fat tissue according to eu standard. 6th International Symposium on Agricultural Sciences "AgroReS 2017" February 27 – March 2, 2017; Banja Luka, Bosnia and

- Herzegovina. Page 46. CIP - 631(048.3)(0.034.2). ISBN 978-99938-93-41-7. COBISS.RS-ID 6355992
- OSTOJIĆ D., Bogdanović V., Petrović M. M., Aleksić S., Mišćević B., Pantelić V. (2006): Criteria of Consumers When Purchasing Beef in Retail Stores, Part B: Position of beef compared to other meat types, reasons and frequency of its use in everyday nutrition and preparation methods. *Biotechnology in animal husbandry* 22, 3-4, p.45-54.
- OSTOJIĆ D., Bogdanović V., Petrović M. M., Aleksić S., Mišćević B., Pantelić V. (2005): Criteria of consumers when purchasing beef in retail stores, A. Consumer attitude towards beef quality preferences and habits in selection of the category of retail meat parts and giblets, 8th International Symposium »Modern Trends in Livestock Production«, Belgrade, October 5th–8th, *Biotechnology in Animal Husbandry*, 21, 5-6, p.263-268.
- Ostojic – Andrić D., Aleksić S., Hristov S., Novaković Z., Petrović M. M., Nikšić D., Stanišić N. (2012). Serbia in the implementation of SEUROP standard for beef carcass classification legislation, parameters and evaluation criteria. *Biotechnology and Animal Husbandry* 28 (1), p 47-58.
- D. Ostojic Andrić, S. Aleksić, M.M. Petrović, S. Hristov, V. Pantelić, Ž. Novaković, D. Nikšić (2011). The effect of crossing of domestic simmental breed and french fattening breeds on conformation and fat cover of beef carcasses. *Biotechnology in Animal Husbandry* 27 (2), p 137-145.
- D. Ostojic Andrić, V. Bogdanović, S. Aleksić, M.M. Petrović, B. Mišćević, V. Pantelić, S. Josipović (2007). The effect of genotype on fattening and body development traits of young cattle. *Biotechnology in Animal Husbandry* 23 (3-4), p 31 – 39.
- Petrović M. M., Petrović M. P., Petrović M., Aleksić S., Ostojic-Andrić D., Pantelić V., Novaković Ž. (2011). How to increase production of beef, lamb and pork in Serbian domestic market and export.
- Petrović M. M., Aleksić S., Sretenović LJ., Marinkov G., Stojanović LJ., Tomašević D. (2007). The effect of genotype on quality of beef. *Animal Science, British International Journal of fundamental and applied research*, vol 1. 3. International Conference, Quality and safety in meat for consumer: from stable to table, Caunas, Lithuania, 06-07 June, 102-104.
- Rulebook on the quality of animals for slaughter, poultry and game (Official Gazette of SFRY 34/74, 26/75, 13/78)
- Regulations of quality of beef carcass and half, Official Gazette R. of Croatia, no. 2/09
- Commission Regulation (EC) No 1249/2008 laying down detailed rules on the implementation of the Community scales for the classification of the beef, pig and sheep carcasses and the reporting of prices thereof, Official Journal of the European Parliament.
- Speedy A.W. (2003). Global production and consumption of animal source foods. *The Journal of Nutrition*, 133, 11, 4048-4053.
- SRETENOVIĆ Lj, Pantelić V, Novaković M, Novaković Ž, Ostojic-Andrić D. (2011). Production of beef meat with functional food properties. 3<sup>rd</sup>. International Congress “New perspectives and challenges of sustainable livestock production” Belgrade, Republic of Serbia, 5-7th October 2011. *Biotechnology in Animal Husbandry* vol 27, 3, book 1, p.366-373.
- Zlatanović V. (2012). Living conditions of households in the Republic of Serbia 2003-2010. Republički zavod za statistiku.

## EFFECT OF USING TRITICALE IN FEED ON PERFORMANCE OF BROILER CHICKS

Aleksandar JEVTIĆ<sup>1</sup>, Vera ĐEKIĆ<sup>2\*</sup>, Sreten MITROVIĆ<sup>3</sup>, Dragan TERZIĆ<sup>4</sup>, Aleksandra JEVTIĆ<sup>5</sup>, Boban KOSTIĆ<sup>6</sup>

<sup>1</sup>P. C. Borjak, Zike Valjarevica 1, 36210 Vrnjacka Banja, Serbia

<sup>2</sup>Small Grains Research Center, Save Kovacevic 31, 34000 Kragujevac, Serbia

<sup>3</sup>University of Belgrade, Faculty of Agriculture, Institute of Zootechny, Belgrade, Serbia

<sup>4</sup>Institute for Forage Crops, Globoder, 37000 Krusevac, Serbia

<sup>5</sup>High School of Professional Studies on Agricultural Food, Cirila and Metodija 1, 18400 Prokuplje, Serbia

<sup>6</sup>Public Communal Company Krusevac, 37000 Krusevac, Serbia

\*Corresponding author: verarajic@yahoo.com

### Abstract

Grains of triticale cultivars from Kragujevac Kg 20, Favorit and Trijumf, produced on the field of Small Grains Research Center in Kragujevac, has been used for fodder mixture preparing. In that moment there are formed four groups of chicken: A group: classical mixture for broiler fattening, B group: mixture with genotype Kg 20, C group: mixture with genotype Favorit and D group: mixture with genotype Trijumf. The feeding experiment lasted 42 days. Based on the recorded productive traits of the examined groups of chicks the researches came to a conclusion that the best results for mortality, feed conversion, production index, average body weight before butchery, handled and cooled carcass weight after 42 days of age are achieved by the group C. The average live body weight on the 42<sup>nd</sup> day of fattening was the highest in the experimental groups C and D (2054.50 g and 1984.00 g), which is by 5.09% and 1.71% higher than the body weight of the broiler chicks in the group A. Insignificantly higher values for all three dressing yields ("conventional processing", "ready to roast" and "ready to grill") were found in the group C, with the addition of the triticale Favorit (83.18%, 77.73% and 71.20%).

**Key words:** *broiler chickens, growth, feeding, triticale*

### Introduction

Triticale is the very suitable nutrient for all animal variety. Nutritive value of grain depends on protein content in the grain, and therefore the product. Some studies demonstrated that triticale grains are a good source of protein and energy. For example, Emam (2010) and Djekic et al. (2011.a) reported that triticale grains contain 9.5% and 13.20-13.61% for moisture crude protein, respectively.

Triticale is already widely used for poultry worldwide. The quality of poultry products may be modified or enriched by the addition of triticale as a nutrient for animal feed rations, and in recent years there has been considerable scientific interest for the use of triticale in animal feed (Djekic, 2010), but data in the published research in the field of livestock productivity and quality of meat and eggs is scarce in relation to the one of the positive impact of this plant type on ruminants and pigs (Barneveld and Cooper, 2002).

In broiler production studies include the determination of the effect of nutrition using mixtures with different participation/share of triticale, on the performance and both quantitative and qualitative traits of broiler meat. The impact of nutritional value of triticale

on the production traits of heavy line hybrids in the world was studied by numerous international researchers (Emam, 2010), but no domestic studies were ever performed.

The obtained results (Boros, 2002; Djekic et al., 2011.b; Vohra et al., 1991) indicate that triticale has great potential as a feed for feeding chickens and that it could replace wheat, in mixtures for fattening, and that, in fact, there is no significant change in their production and slaughterhouses characteristics. Numerous literature data indicate that the body weight of chickens fed with triticale did not differ significantly from body weight of chickens fed wheat (Djekic, 2010; Korver et al., 2004; Savage et al., 1987). The research results of Hermes and Johanson (2004) showed that triticale in feed for chickens did not have negative effects on production traits of investigated chickens.

The an objective of this research was to determine the effects of the introduction of triticale on the production characteristics of broiler chickens in feeding.

### Materials and methods

Winter triticale cultivars Kg 20, Favorit and Trijumf were produced in the 2009 year at the Small Grains Research Centre at Kragujevac location in Serbia (44° 22' N, 20° 56' E, 173-220 m a. s. l.) on the smonitza soil in degradation (Vertisol), has been used for fodder mixture preparing. Chickens were assigned in four groups, of 100 birds each. On that occasion, formed four groups of broiler chickens, or treatment, of 100 each in group. Namely, the control group-A (was fed standard mixture), while the experimental groups B, C and D were fed diet containing triticale (mixture with triticale genotypes Kg 20, Favorit and Trijumf). Trial groups received in the same mixture addition of 7.5%, 12%, 15% and 18% triticale. Chickens were fed four basal diets: starter, grower I, grower II and finisher. Ross 308 hybrids were used for the investigations. The research was carried out in 2009, on farm in Kragujevac, central Serbia.

**Table 1.** *Ingredient composition of the mixtures for feeding broiler chickens*

Diet (%)	Starter		Grower I		Grower II		Finisher	
	C	E	C	E	C	E	C	E
Wheat	40.00	40.00	42.00	35.30	43.10	35.10	48.30	35.10
Corn	19.80	12.20	19.00	13.50	19.10	12.00	18.30	13.50
Triticale		7.50		12.00		15.00		18.00
Soybean oil meal	30.90	30.90	28.10	28.10	25.40	25.40	22.00	22.00
Sunflower oil meal	2.50	2.50	3.00	3.00	4.00	4.00	4.00	4.00
Soybean oil	3.15	3.25	4.55	4.70	5.25	5.25	4.70	4.70
Salt	1.20	1.20	1.00	1.10	1.00	1.10	0.80	0.80
Monocalcium phosphate	1.20	1.20	1.10	1.05	0.90	0.90	0.65	0.65
Vitamin-mineral premix	1.25	1.25	1.25	1.25	1.25	1.25	1.25	1.25
Total:	100	100	100	100	100	100	100	100

\*C-control group, E-experimental group

\*\*To provide the following per kg of feed: Vit. A-9000 IU; Vit. D<sub>3</sub>-3300 IU; Vit. E-30,0 IU; Vit. K-2,2 mg; Vit. B<sub>1</sub>-2,2 mg; Vit. B<sub>2</sub>-8,0 mg; Ca pantothenate-12 mg; Niacin-66,0 mg; Vit. B<sub>6</sub>-4,4 mg; Folic acid 1,0 mg; holin-550 mg; Vit. B<sub>12</sub>-0,022 mg; Biotin-0,20 mg; Salt-0,30-0,45%; Managanese-100 mg; Zinc-75 mg; Iodine-0,45 mg; Copper-8 mg; Selenium-0,10 mg; Iron-100 mg.

Diets compositions are presented in Table 1 and chemical composition in Table 2. Fattening of chickens lasted 42 days. During whole chickens growing period water and feed were fed *ad libitum*. During feeding the following parameters were followed health state and mortality. Basic chemical composition (moisture, crude proteins, crude fat and mineral matters) of chicken feed was determined according to official A.O.A.C. (1984).

**Table 2.** Chemical composition of the of the mixtures for feeding broiler chickens

The chemical composition:	Starter				Grower I			
	A	B	C	D	A	B	C	D
Crude protein, %	22.37	22.38	22.40	22.40	20.17	20.20	20.25	20.27
Fat, %	6.36	6.37	6.38	6.38	9.51	9.67	9.46	9.54
Metabolic energy, MJ/kg	12.59	12.63	12.63	12.68	13.39	13.39	13.39	13.39
Ca, %	1.29	1.20	1.23	1.16	0.79	0.77	0.85	0.85
P (available), %	0.53	0.47	0.37	0.34	0.42	0.42	0.42	0.42
The chemical composition:	Grower II				Finisher			
	A	B	C	D	A	B	C	D
Crude protein, %	19.70	19.64	19.76	19.82	18.42	18.44	18.50	18.49
Fat, %	9.90	9.78	9.72	9.79	8.47	8.68	8.46	8.54
Metabolic energy, MJ/kg	12.86	12.85	12.87	12.87	13.39	13.39	13.40	13.40
Ca, %	0.79	0.77	0.85	0.85	0.88	0.89	0.90	0.90
P (available), %	0.42	0.42	0.42	0.42	0.64	0.64	0.66	0.66

The results were processed statistically by analysis of variance (ANOVA); all calculations were performed in the module Analyst Program SAS/STAT (SAS Institute, 2000). Mean values were compared by Duncan's test at a significance level of 0.05.

### Results and discussion

Average body mass of broilers breeds Ross 308 in groups are shown in Table 3.

**Table 3.** General performance of broilers given triticale

Parameters	A	B	C	D
Live weight, g/bird	1950.00 <sup>b</sup>	1935.50 <sup>b</sup>	2054.50 <sup>a</sup>	1984.00 <sup>b</sup>
Feed intake, g/bird	4.222 <sup>b</sup>	4.155 <sup>c</sup>	4.239 <sup>a</sup>	4.177 <sup>b</sup>
Feed conversion ratio	2.414 <sup>b</sup>	2.450 <sup>a</sup>	2.370 <sup>c</sup>	2.406 <sup>b</sup>
Production index	186.56 <sup>b</sup>	184.33 <sup>b</sup>	204.33 <sup>a</sup>	186.52 <sup>b</sup>
Mortality, %	3.0 <sup>c</sup>	2.0 <sup>b</sup>	1.0 <sup>d</sup>	5.0 <sup>a</sup>

\*Means in the same row with different superscript are significantly different (p<0.05)

As it could be seen from the presented results, after the six weeks, higher live weight achieved C-group (2054.50 g), had slightly lower body weight than while the A-, B- and D-groups. During the 42<sup>th</sup> day, live weight of chickens from the experimental C-group which were fed triticale cultivar Favorit in mixture, was higher by 5.09%, respectively, compared to A-group, and live weight of chickens from the D-group which were fed triticale cultivar Trijumpf, was higher by 1.71%, of chickens fed mixtures without triticale. At the days 42 of fattening, the body weight of chickens from control A-group, was by 0.74% higher, respectively, compared to the B-group, which were fed triticale in mixtures. Our results are consistent with the results of Djekic et al., (2011.b). Similarly, with broiler chickens, live body weight feed with triticale is not significantly different from the same trait of chicks feed with wheat (Hermes and Johnson, 2004 and Korver et al., 2004). During the entire trial, triticale in the experimental B-group and D-group reduced feed intake by 1.59% and 1.07% compared to the A-group of chickens. Average daily food consumption of chickens in trial C-group during initial and the fattening period was higher by 0.40% compared to A-group. However, the research results of Korver et al. (2004) showed that feed intake with broiler chickens did not differ significantly from the wheat/triticale or corn/triticale based diets. During the finishing period, feed conversion ratios values for chicks fed dry fat B-group (2.450) were significantly lower compared with the

C-group fed triticale cultivar Favorit, but did not differ when compared with the control (A-group) and D-group. The performance index of broiler chickens fed triticale the C-group (204.33) were significantly higher during these periods when compared with those fed the control (186.56) and B (184.33) and D-groups (186.52). Hermes and Johnson (2004) found that feeding broiler chickens triticale up to 15% with corn did not affect their performance. In chickens growing, the most evident positive results of the diet with triticale, low mortality should be emphasized (Table 3). In control and experimental groups (B, C and D) the total number of dead chickens was 3 and 2, 1 and 5 respectively.

**Table 4.** Yield of processed carcasses

Group	Trait	Body mass	Conventional		Ready to roast		Ready to grill	
		prior to slaughter, g	Mass, g	%	Mass, g	%	Mass, g	%
A	x	1950.00	1695.33	82.82	1531.67	77.51	1416.25	70.54
	Sd	194.665	154.78	3.766	204.654	3.646	195.240	3.507
B	x	1935.50	1634.27	82.09	1495.00	76.33	1385.00	69.92
	Sd	207.892	161.25	2.361	182.685	2.195	173.581	2.026
C	x	2054.50	1773.19	83.18	1615.42	77.73	1453.75	71.20
	Sd	228.466	179.84	1.978	194.158	1.873	169.855	1.785
D	x	1984.00	1665.78	81.06	1522.92	75.68	1369.58	67.70
	Sd	179.224	184.25	3.006	160.262	2.984	135.805	2.986

By analysis of values of slaughter yields "conventional processing" it was established that there were significant differences between investigated groups, whereas the slaughter yield "ready to roast" and "ready to grill" in statistically significant differences (Table 4). Insignificantly higher values for all three dressing yields were established in C-group, with the addition of triticale Favorit (83.18%, 77.73% and 71.20%), followed by group A with the addition of control (82.82%, 77.51% and 70.54%, respectively), followed by group B with the addition of triticale Kg 20 (82.09%, 76.33% and 69.92) and group D (81.06%, 75.68% and 67.70%). The data obtained from the average values of slaughter yield ready to roast slightly higher than results achieved with chickens fed triticale in tests conducted by Rao et al., (1976) and most are in agreement data quoted by Camiruaga et al., (2001). The results presented in this paper are in accordance with those reported by Barneveld and Cooper, (2002), as well as Djekic et al., (2011b; 2012).

### Conclusion

The best results on recorded productive traits achieved are of broiler chickens in C group. In regard to slaughter yield (ordinary processing, ready to roast and ready for the grill), the best results are achieved chickens from C group and A group. According to exposed, the conclusion can be that broiler chickens from examined groups are achieved satisfied results of productive and abattoir traits after 42 days. During the finishing period, feed conversion ratios values for chicks fed dry fat B-group were significantly lower compared with the C-group fed triticale cultivar Favorit, but did not different when compared with the control (A-group) and D-group. Performance index of quails fed triticale the C-group were significantly higher during these periods when compared with those fed the control (A-group) and B- and D-groups. Recorded data are showing that triticale had a great potential as fodder in broiler diet because it could be a successful replacement for wheat in broiler diet mixture. It does not affect significant changes in productive and abattoir traits of chicken, in other words broiler

chickens body weight feed with triticale is not significantly different from the same trait of broiler chicken feed with wheat.

### **Acknowledgements:**

Investigations necessary for this paper are part of the project TP 31054, financed by the Ministry of Education and Science of the Republic of Serbia.

### **References**

- Association of official analytical chemistry (A.O.A.C.) (1984): Official methods of Analysis, 14<sup>th</sup> ed., Washington, D.C.
- Barneveld R.J. and Cooper K.V. (2002): Nutritional quality of triticale for pigs and poultry. Proceedings of the 5<sup>th</sup> International Triticale Symposium, Poland, vol. 1, 277-282.
- Boros D. (2002): Physico-chemical quality indicators suitable in selection of triticale for high nutritive value. In Proceedings of the 5th International Triticale Symposium, E. Arseniuk and R. Osiski, Eds., Radzikow, Poland, 1: 239-244.
- Camiruaga M., Garcia F., Elera R., Simonetti C. (2001): Respuesta Productiva de Pollos Broilers a la Adición de Enzimas Exógenas a Dietas Basadas en Maiz o Triticale. Enero-Marzo, 28, (1), 1-59.
- Djekic V. (2010): Effect of triticale production modality on efficiency of feeding mixtures nutrition in broiler chickens. Ph.D. Thesis, University of Belgrade, Faculty of Agriculture Zemun, Serbia, 43-49.
- Djekic V., Mitrovic S., Milovanovic M., Djuric N., Kresovic B., Tapanarova A., Djermanovic V., Mitrovic M. (2011.a): Implementation of triticale in nutrition of non-ruminant animals. African Journal of Biotechnology. 27 June, ISSN 1684-5315, 10, (30), 5697-5704.
- Djekic V., Mitrovic S., Radovic V., Djordjevic N., Pandurevic T. (2011.b): The effect of different triticale on the body weight and weight gain in fattening chickens. International Scientific Symposium of Agriculture "Agrosym Jahorina 2011", AGROSYM, 10-12. November, Jahorina, 356-362.
- Djekic V., Mitrovic S., Staletic M., Obradovic S. (2012): The effect of different triticale on the production data in fattening chickens. Abstract book of 6th Central European Congress on Food. 23rd-26th May 2012, Novi Sad, Serbia, 558.
- Emam R.M.S. (2010): A study of substituting yellow corn by triticale grains on productive performance of two broiler strains. Ph.D. Thesis, Fac. Agric., Fayoum University, Egypt.
- Hermes J.C., Johanson R.C. (2004): Effects of Feeding Various Levels of Triticale var. Bogo in the Diet of Broiler and Layer Chickens. Journal of Applied Poultry Research, 13, (4), 667-672.
- Korver D.R., Zuidhof M.J., Lawes K.R. (2004): Performance Characteristics and Economic Comparison of Broiler Chickens Fed Wheat and Triticale-Based Diets. Poultry Science 83, (5), 716-725.
- Rao D. R., Johnson W. M., Sunki G. R. (1976): Replacement of maize by triticale in broiler diets. British Poultry Science, 17, (3), 269-274.
- SAS Institute (2000): SAS (Statistical Analysis System). User's guide: Statistics. SAS Institute Inc. Cary, NC.
- Savage T.F., Holmes Z.A., Nilipour A.H., H.S. Nakaue (1987): Evaluation of cooked breast meat from male breeder turkeys fed diets containing varying amounts of triticale, variety Flora. Poultry Sci. 66, 450-452.
- Vohra P., Bersch C., Qualset Q., Baker R. (1991): Triticale: Alternative cereal grain in broiler starter diets. Calif. Agric. 45, 34-37.

## GENETIC PARAMETERS OF CLAW CONFORMATION IN SLOVAK HOLSTEIN COWS

Michal VLČEK\*, Radovan KASARDA

Department of Animal Genetics and Breeding Biology, Slovak University of Agriculture in Nitra, Slovakia

\* Corresponding author: xvlcekm@uniag.sk

### Abstract

The estimation of heritability of claw measures is needed for implementation of selection indexes, which are used in many European countries in breeding for better claw health and conformation traits. The aim of this study was to estimate the heritability of claw parameters (claw angle, claw length, heel index, claw height, diagonal and claw width were taken after functional claw trimming on lateral side of right hind leg) in Holstein cows in Slovakia. The analysis was based on 482 observations taken from 439 Holstein cows measured between 2012 and 2014 on three farms. On transformed measurements we used animal model with fixed effects as number of lactation, stage of lactation, year of calving, season of calving, year of trimming, season of trimming and sire. Heritability of claw parameters ranged from 0.01 to 0.26. Highest heritability estimate were observed in claw length and claw height. In case of claw angle the heritability was 0.14 and claw width was 0.13. Heritability of heel depth was not estimable. One of possible causes could be small number of observations. Our results are preliminary and further research with higher number of observations and animals is required to obtain more reliable estimates.

**Key words:** *Holstein, cow, heritability, claw measure, animal model*

### Introduction

During the last decade functional traits became more important in all dairy cattle breeding programs as reported Reinhardt et al. (2005). Correct claw conformation and good locomotion of dairy cows are important. Fast increase in dairy herd size over the last decades, and a change from tie stalls to free stalls it is imperative from an economic and welfare point of view to have a good claw health reducing the risk for lameness as reported Uggla et al. (2008). Choi and McDaniel (1993) reported that is necessary to use claw traits in selection index for genetic improvement for economic efficiency and Miglior et al. (2005) reported that traits associated with feet and legs are included by most countries in their national selection index. Boelling et al. (2001) reported that objectively measured traits has high correlation to body conformation traits in the following generation and offer the possibility of improving feet and legs in dairy cattle and Strapák et al. (2011) reported that feet had significant effect to length of productive live. One of possible selection ways for improving of claw health can be indirect selection on correlated conformation traits that are currently recorded as reported van der Waaij et al. (2005). The aim of this study was to estimate the heritability of claw parameters and correlations between them in Holstein cows in Slovakia.

### Materials and methods

The parameters of hind lateral claw were observed on 439 Holstein cows kept on 3 farms in west part of Slovakia. The observations were made between 2012 and 2014. Claw measures



as claw angle, claw length, heel depth, claw height, diagonal and claw width according to Vermunt and Greenough (1995) were observed. Totally 482 records were included into the study. On transformed measurements the animal model with fixed effects as number of lactation, stage of lactation, year of calving, season of calving, year of trimming, season of trimming and sire was used for the estimation of claw parameters heritability. Statistical analysis, correlations and animal model were in SAS (version 9.2, SAS Institute Inc., Cary, NC) performed.

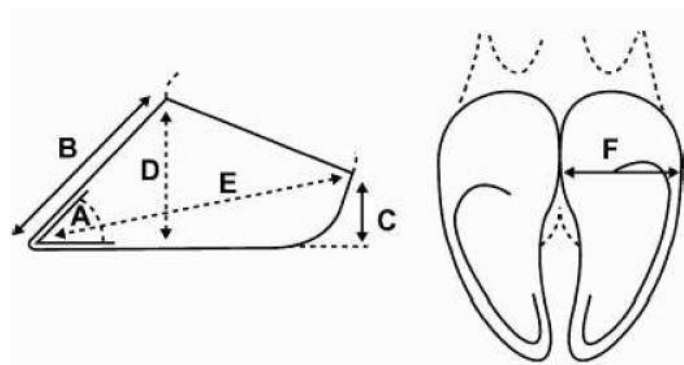


Figure 1 Claw measurements (Vermunt and Greenough, 1995)

A – claw angle, B – claw length, C – heel depth, D – claw height, E – diagonal, F – claw width

### Results and discussion

In dataset of 482 observations were found the average values as  $49.46 \pm 5.73^\circ$  for claw angle,  $78.44 \pm 9.87$  mm for claw length,  $34.21 \pm 8.83$  mm for heel depth,  $69.98 \pm 6.16$  mm for claw height,  $133.18 \pm 8.60$  mm for diagonal and  $56.30 \pm 4.60$  mm for claw width.

Table 1 Estimated heritabilities on diagonal and phenotypic correlations under diagonal between claw measurements

	A	B	C	D	E	F
A	0.14					
B	0.19399 <b>&lt;0.0001</b>	0.26				
C	-0.04947 0.2784	-0.38109 <b>&lt;0.0001</b>	-			
D	0.15079 <b>0.0009</b>	0.15451 <b>0.0007</b>	0.13438 <b>0.0031</b>	0.26		
E	-0.0601 0.1877	0.06575 0.1495	0.29789 <b>&lt;0.0001</b>	0.22137 <b>&lt;0.0001</b>	0.01	
F	0.13935 <b>0.0022</b>	0.16111 <b>0.0004</b>	0.00187 0.9673	0.27388 <b>&lt;0.0001</b>	0.14196 <b>0.0018</b>	0.13

A – claw angle, B – claw length, C – heel depth, D – claw height, E – diagonal, F – claw width

The estimated heritability of claw parameters ranged from 0.01 to 0.26. The lowest was estimated for diagonal and the highest for claw length and for claw height (Table 1).

Heritability of heel index was not estimable. One of possible causes could be small number of observations.

In studies of Choi and McDaniel (1993) and Smith et al. (1986) estimated the heritability by using the claw measures. Choi and McDaniel (1993) found the heritabilities for claw angle 0.18, claw length 0.25 and heel depth 0.07. Smit et al. (1986) found the heritabilities 0.16 for angle, 0.26 for length and 0.16 for heel depth. Choi and McDaniel (1993) found higher heritabilities of claw traits for later lactations than for earlier lactations. In present study the heritabilities were not estimated separately for each number of lactation so it was not possible to compare them. Estimated heritability by Smit et al. (1986) and Choi and McDaniel (1993) were very similar to results obtain in present study except the heritability of heel depth, which was not estimable. Similar heritability of claw angle also found Boelling et al. (2001), Onyiro and Brotherstone (2008) and Laursen et al. (2009). Boelling et al. (2001) reported 0.11 for Jersey, 0.13 for Danish Friesian and 0.15 for Danish red dairy cows. Onyiro and Brotherstone (2008) reported 0.11 and Laursen et al. (2009) reported 0.13 for heritability of claw angle. Uggla et al. (2008) fund the heritability of claw angle 0.16 for Swedish Holstein and 0.23 for Swedish Red.. Van der Waaij et al. (2005) reported 0.18. Häggman et al. (2013) estimated the heritability 0.7 and Ødegård et al. (2015) found 0.9 for claw angle. The heritabilities estimated in studies of Boelling et al. (2001), Uggla et al. (2008), Laursen et al. (2009), Häggman et al. (2013) and Ødegård et al. (2015) were estimated by using the conformation traits with linear scale from 1 to 9. Van der Waaij et al. (2005) used the same evaluation but for trait feet and legs they used points from 70 (poor) to 89 (very good) and also Onyiro and Brotherstone (2008), but for trait leg and feet composite they used points from 65 (poor) to 95 (excellent). On the other hand, in present study the heritabilities were estimated with using the claw measures. In general the heritabilities estimated in present study are similar to heritabilities found in previous studies. Riecka et al. (2008) found the highest positive correlations between claw length and claw height. In this study the highest positive correlations were found between heel depth to diagonal and claw height and claw width. The highest negative correlations were found in claw length and heel depth. Riecka et al. (2008) reported the highest negative correlations in claw angle to claw width. Haggman and Juga (2013) found small negative correlations of foot angle to side and rear view of rear leg as conformation trait. Associations of higher claw angle and shorter claw length with longer lives of individual cows reported Choi and McDaniel (1993). Also Onyiro and Brotherstone (2008) found that steeper foot angle and well-fitted mammary systems are associated with better locomotion.

### **Conclusion**

Correct claw conformation is important for better locomotion and longevity. It is necessary to use claw parameters in selection indexes for genetic improvement. This can lead to longer productive life and finally to lower number of culled cows per year and better economic efficiency of dairy industry. Our results are preliminary and further research with higher number of observations and animals is required to obtain more reliable estimates.

### **Acknowledgement**

This study was supported by the Slovak Research and Development Agency under the Contract No. APVV-14-0054.

## References

- Boelling D., Madsen P., Jensen J. (2001). Genetic parameters of foot and leg traits in future AI bulls II. Correlation to body conformation traits in daughters. *Acta Agriculturae Scandinavica, Section A – Animal Science*, vol. 51, pp. 122-128.
- Caption N., Thamsborg S.M., Enevoldsen C. (2008). Conformation of hind legs and lameness in Danish Holstein heifers. *Journal of Dairy Science*, vol. 91, pp. 2089-2097.
- Choi Y.S., McDaniel B.T. (1993). Heritabilities of measures of hooves and their relation to other traits of Holsteins. *Journal of Dairy Science*, vol. 76, pp. 1989-1993.
- Fatehi J., Stella A., Shannon J.J., Boettcher P.J. (2003). Genetic parameters for feet and leg traits evaluated in different environments. *Journal of Dairy Science*, vol. 86, pp. 661-666.
- Häggman J., Juga J., Sillanpää M.J., Thompson R. (2013). Genetic parameters for claw health and feet and leg conformation traits in Finnish Ayrshire cows. *Journal of Animal Breeding and Genetics*, vol. 130, pp. 89-97.
- Laursen M.V., Boelling D., Mark T. (2009). Genetic parameters for claw and leg health, foot and leg conformation, and locomotion in Danish Holsteins. *Journal of Dairy Science*, vol. 92, pp. 1770-1777.
- Miglior F., Muir B.L., Van Doormaal B.J. (2005). Selection indices in Holstein cattle of various countries. *Journal of Dairy Science*, vol. 88, pp. 1255-1263.
- Onyiro O.M., Brotherstone S. (2008). Genetic analysis of locomotion and associated conformation traits of Holstein-Friesian dairy cows managed in different housing systems. *Journal of Dairy Science*, vol. 91, pp. 322-328.
- Ødegård C., Svendsen M., Heringstad B. (2015). Foot and leg conformation traits have a small effect on genomic predictions of claw disorders in Norwegian Red cows. *Journal of Dairy Science*, vol. 98, pp. 4139-4147.
- Ødegård C., Svendsen M., Heringstad B. (2014). Genetic correlations between claw health and feet and leg conformation in Norwegian Red cows. *Journal of Dairy Science*, vol. 97, pp. 4522-4529.
- Reinhardt F., Ruten W., Rensing S. (2005). Genetic evaluation for feet traits collected from young German Holstein bulls. *Interbull Bulletin*, vol. 33, pp. 167-170.
- Riecka Z., Kasarda R., Candrák J. (2008). Analysis of relationships between claw formation and production and reproduction traits. *Acta fytotechnica et zootechnica*, vol. 11(3), pp. 73-77.
- Smit H., Verbeek B., Peterse D.J., Jansen J., McDaniel B.T., Politiek R.D. (1986). Genetic aspects of claw disorders, claw measurements and 'type' scores for feet in Friesian cattle. *Livestock Production Science*, vol. 15, pp. 205-217.
- Strapák P., Juhás P., Strapáková E. (2011). The relationship between the length of productive life and the body conformation traits in cows. *Journal of Central European Agriculture*, vol. 12, pp. 239-254.
- Uggla E., Jakobsen J.H., Bergsten C., Eriksson J.Å., Strandberg E. (2008). Genetic correlations between claw health and feet and leg conformation traits in Swedish dairy cows. *Interbull Bulletin*, vol. 38, pp. 91-95.
- van der Waaij E.H., Holzhauer M., Ellen E., Kamphuis C., de Jong G. (2005). Genetic parameters for claw disorders in Dutch dairy cattle and correlations with conformation traits. *Journal of Dairy Science*, vol. 88, pp. 3672-3678.
- Vermunt J.J., Greenough P.R. (1995). Structural characteristics of the bovine claw: Horn growth and wear, horn hardness and claw conformation. *British veterinary journal*, vol. 151, pp. 157-180.
- Zavadilová L., Štípková M. (2012). Genetic correlations between longevity and conformation traits in the Czech Holstein population. *Czech Journal of Animal Science*, vol. 61, pp. 75-81.

## GENETIC IMPROVEMENT OF CATTLE THROUGH LOW DENSITY SNP PANELS

Nina MORAVČÍKOVÁ\*, Radovan KASARDA, Ondrej KADLEČÍK

Department of Animal Genetics and Breeding Biology, Slovak University of Agriculture in Nitra, Slovakia

\*Corresponding author: nina.moravcikova@uniag.sk

### Abstract

The aim of this study was to prepare a low cost custom genotyping array to service all of requirements for dairy cattle breeders. Our study presents the panel of SNPs mainly with respect to the needs of Pinzgau cattle breeders in Slovakia. Overall 152 animals, representing the genepool of active Slovak Pinzgau population, were genotyped with Illumina bovine SNP50 BeadChip. The quality control of data was carried out to remove any markers assigned to unmapped regions, SNPs with unknown chromosomal position and loci positioned to sex chromosomes. The following control of genotyping data were performed to exclude any autosomal loci with call rate lower than 90%, minor allele frequency lower than 0.05 and HWE limit of 0.0001. The final dataset was composed of 41,720 autosomal loci covering overall length 2,500,315 kb of the genome. To produce the low-density array only SNPs located in the regions near genes significantly associated with dairy production according to the previously published studies were selected. Subsequently, the genetic potential of analysed animals was evaluated in order to fulfil farmers' requirements and also in broader sense to achieve the genetic improvement of breed. Despite the fact that the high density SNP arrays are currently utilized for many purposes, the challenge for the cattle industry still remains to successfully present and incorporate this technology to the common practice on farms. One of the ways how to do this is to prepare low cost custom genotyping panel in view of farmers' requirements.

**Keywords:** *breeding program, bovine SNP panel, dual-purpose breeds, Pinzgau cattle.*

### Introduction

Currently, development and advancement in the area of genomic technologies provide new opportunities for genetic improvement of livestock production as well as fitness traits. Genomic tools are used for various purposes, including genetic evaluation (Kasarda et al., 2015; Kukučková et al., 2017), parentage verification (McClure et al., 2013; Lyons et al., 2015), screening for recessive disorders (Sonstegard et al., 2013; Agerholm et al., 2016) and other mutations with large effect on production and reproduction traits in different cattle breeds (Nayeri et al., 2016; Magalhães et al., 2016). Many of these studies are routinely performed independently of each other and based on different genotyping arrays (Khatkar et al., 2012; Mullen et al., 2013). However, the relatively high cost of animals' genotyping, even by using commercially available low-density Illumina arrays, prevents its widespread use and application to common practice on farms. One of the ways how to reduce the cost of genotyping for an animal is to use of arrays with even lower SNPs density that can be if necessary imputed up to higher number of markers (Dassonneville et al., 2012; Piccoli et al., 2014; Judge et al., 2016).

A number of SNP genotyping platforms are available for cattle, including 3K (Wiggans et al., 2012), 7K (Boichard et al., 2012), 15K (Khatkar et al., 2007), 25K (Raadsma et al., 2009),

50K (Matukumalli et al., 2009) and more recently 700K from Illumina, and 650K and 3 million SNP panels from Affymetrix. In addition, the NGS technology (next generation sequencing) with decreased cost and increased sequencing speed is currently available also for livestock species (Bai et al., 2012). Although the use of genotyping data from those high-throughput SNP arrays can improve the accuracy of genomic selection, it also may increase the total genotyping or sequencing costs. Therefore for some application, low-density SNP array e.g. 3-7K can be cost effective alternative in comparison to application of high density arrays (for example selection of heifers to be kept in dairy or beef production system) (Khatkar et al., 2012). On the other hand the utilization of low-density SNP arrays and subsequent imputation of genotyping data can be also promising way how to reduce costs of genotyping and increase the number of genotyped animals (Mulder et al., 2012). Selection of markers for low-density arrays can be based on several possible strategies (Moser et al., 2010; Mullen et al., 2013; Szyda et al., 2013; Judge et al., 2016).

The aim of this study was to prepare a low-density genotyping array to service all of requirements for breeders of Pinzgau cattle in order to obtain extensively information of animal's genetic potential based on SNPs located in the QTL genomic regions affecting milk production and mastitis resistance.

### **Materials and Methods**

The sampled population of Slovak Pinzgau cattle covered living animals: 37 sires representing active breeding bulls (19 animals) and AI doses deposited in reproduction centres (18 animals), 35 dams (mother of breeding bulls) and 80 cows. All of animals have been genotyped in commercial lab for 54,906 SNPs using Illumina BovineSNP50 BeadChip V2 (Illumina Inc., San Diego, CA). The quality control of genotyping data was performed by PLINK (Purcell et al., 2007). In first step, all of markers assigned to unmapped regions or with unknown chromosomal position according to the latest bovine genome assembly (Btau 4.0) and SNPs positioned to sex chromosomes were removed (1723). In the subsequent quality control of genotyping data only autosomal SNPs with a call rate higher than 90%, minor allele frequency (MAF) higher than 0.01 that adhered to mendelian inheritance patterns, and did not deviate from Hardy-Weinberg equilibrium (HWE limit of  $1 \times 10^{-5}$ ) were retained.

The selection of genetic markers in order to prepare low cost custom genotyping SNP panel was based on the quantitative trait locus (QTL) database containing candidate genes for mammary gland development, milk production, and mastitis resistance. The database of QTL genomic regions with appropriate candidate loci was created based on the information stored in the Cattle Quantitative Trait Locus Database (Cattle QTLdb) (<http://www.animalgenome.org>). After selection of specific QTL genomic regions corresponding map file was generated to retain only loci of interest in resulting low-density SNP array. The final dataset based on reduced low-density SNP panel, containing 4133 candidate loci, was prepared by using PLINK (Purcell et al., 2007).

### **Results and discussion**

All samples have been genotyped successfully (99.23% of SNPs) with average call rate 99.77%. Obtained level of call rate was comparable with previously reported results for various dairy or beef cattle breeds (Cooper et al., 2013; Mullen et al., 2013). After quality control of genotyping data in total of 41,720 autosomal loci were identified as polymorphic and covered overall length 2,500,315 kb of the genome. The total number of detected polymorphic loci in the present study was higher compared to results of Mai et al. (2010) or

Hulsegge et al. (2013). The minor allele frequency, referring to distribution of the least common SNP allele, reached the level  $0.28 \pm 0.11$ .

Despite the fact that the high density SNP arrays are currently utilized for many purposes, the challenge still remains how to successfully present and integrate this technology to the common practice on farms. As presented many studies (Miller, 2010; Pryce and Hayes, 2012; Saatchi and Garrick, 2014; Judge et al., 2016) one of the ways may be the utilization of low-density arrays. In present study the low-density SNP panel was prepared firstly to decrease cost of genotyping and secondly to increase number of genotyped animals with respect to the current requirements of Pinzgau cattle breeders. The SNPs were selected to obtain comprehensive information of QTL genomic regions important for milk production and mastitis related traits. In the future, selection of animals with core genotypes can increase not only genetic potential of an individual but also the economic value of traits of interest in a genetic improvement program of a breed.

In order to prepare a low cost custom genotyping panel overall 4133 markers were selected from 50K genotyping array. The database of usable loci was prepared by using information stored in the Cattle Quantitative Trait Locus Database that contains cattle QTL and association data resulting from current published studies. Generally, the Cattle QTLdb database is designed to facilitate the process for users to compare, confirm, and locate the most likely location of the genes responsible for the quantitative traits relevant to cattle production. With regard to obtain extensively information of animal's genetic potential based on SNPs located in the QTL regions for milk production and resistance to mastitis totally 16 genomic regions was selected. Figure 1 shows the distribution of selected SNPs across bovine autosomes obtained in our study. Most of SNPs were located on the BTA5 (1062), whereas the lowest proportion of SNPs was found for BTA11 (6). Across selected genomic regions in reduced SNP panel 4583 genes have been identified using the NCBI database (<https://www.ncbi.nlm.nih.gov>). Description of selected genomic regions and identified genes linked to milk production and occurrence of mastitis is listed in Table 1. We found 39 candidate genes of which 29 were significantly associated with production of milk, 5 with resistance to mastitis and 5 with both traits.

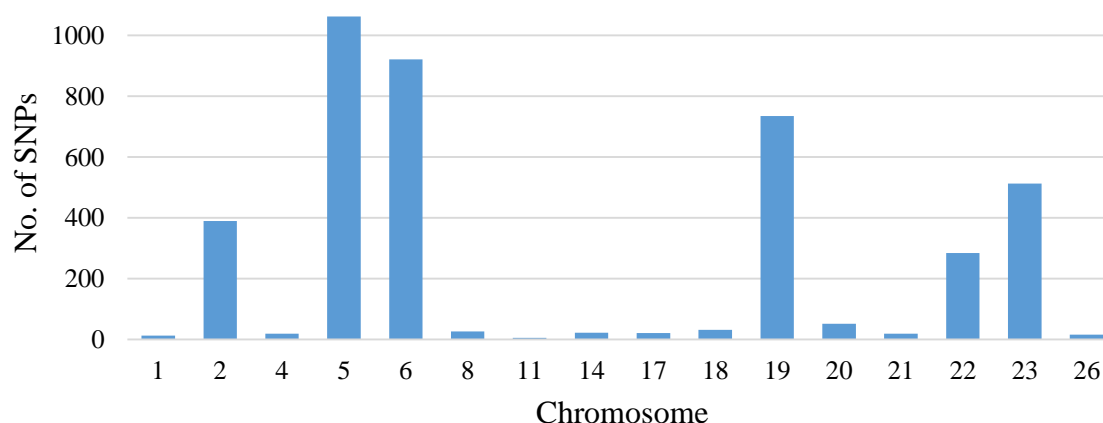


Figure 1. Distribution of selected SNPs across chromosome in low-density SNP panel

The highest number of genes linked to dairy performance was found on the BTA6. One of the most important gene family located on the BTA6 is casein family. The casein family consists of genes (*CSN1S1*, *CSN1S2*, *CSN2*, *CSN3*, *LALBA*, *LGB*) that exist in different genetic variants. Each of these variant encode chemically different protein. In addition, each of the genetic variant of milk proteins affects milk composition and cheese make ability in a

different way (Ogorevc et al., 2009). Until now, many studies reported significant impact of casein genes on milk yield as well as its composition (Miciński et al., 2007; Hristov et al., 2012; Deb et al., 2014). Among the other genes identified in the same area on BTA6 belong *PPARGC1*, *SPP1*, and *ABCG* genes. Each of these genes have been previously significantly associated with milk production (Weikard et al., 2005; Leonard et al., 2005; Olsen et al., 2007). For mastitis overall 10 genes were identified within reduced SNP panel (*IL8RA*, *IL8RB*, *TLR4*, *CYP11B1*, *FGF2*, *NOD2*, *CCR2*, *FEZF2*, *LTF*, and *BoLA-DRB3*). The significance of their impact on mastitis related traits has been studied mainly through expression experiments (e.g. Pant et al., 2007; Wang et al., 2007; Kaupe et al. 2007; Leyva-Bacca et al. 2008).

Table 1. Description of genomic regions included in low-density SNP panel and corresponding candidate genes involved in control of milk production and mastitis resistance (Author s' elaboration based on the obtained results)

Chr.	Start position (Mb)	End position (Mb)	No. of genes in region	Genes for milk production and mastitis related traits	Gene name
1	35.01	36.04	10	POU1F1	POU class 1 homeobox 1
				IL8RA	Interleukin 8 receptor, alpha
				IL8RB	Interleukin 8 receptor, beta
2	83.35	110.79	289	CYP27A1	Cytochrome P450 Family 27 Subfamily A Member 1
				STAT1	Signal transducer and activator of transcription 1
4	93.04	96.03	19	LEP	Leptin
				IGF1	Insulin-like growth factor 1
				LALBA	Lactalbumin, alpha
5	34.00	107.34	1072	OLR1	Oxidized low density lipoprotein (lectin-like) receptor 1
				PPARGC1A	Peroxisome proliferative activated receptor, gamma, coactivator 1 alpha
				ABCG2	ATP-binding cassette, sub-family G (WHITE), member 2
6	37.02	88.59	411	SPP1	Secreted phosphoprotein 1
				CSN1S1	Casein alpha s1
				SCN1S2	Casein alpha s2
				CSN2	Casein beta
				CSN3	Casein kappa
8	112.02	112.97	26	TLR4	Toll-like receptor 4
				IL1A	Interleukin 1 alpha
11	107.02	107.25	17	IL1B	Interleukin 1 beta
				POMC	Pro-opiomelanocortin
14	1.70	2.83	80	DGAT1	Diacylglycerol O-acyltransferase 1
				FGF2	Fibroblast growth factor 2
17	35.05	37.15	30	IL2	Interleukin 2
				IL21	Interleukin 21
18	18.05	19.26	16	NOD2	Nucleotide-binding oligomerization domain containing 2
				FASN	Fatty acid synthase
19	15.00	52.20	1229	STAT5A	Signal transducer and activator of transcription 5A
				GH1	Growth hormone

				CCL2	Chemokine (C-C motif) ligand 2
20	31.09	34.26	39	GHR	Growth hormone receptor
				SERPI1A1	Serine protease inhibitor
				IGHG1	Immunoglobulin Heavy Constant Gamma 1
21	33.09	34.24	32	IGHG2	Immunoglobulin Heavy Constant Gamma 2
				IGHG3	Immunoglobulin Heavy Constant Gamma 3
				FEZF2	Fez family zinc finger 2
22	39.03	54.40	320	LTF	Lactoferrin
				CCR2	Chemokine (C-C motif) receptor 2
				PRL	Prolactin
23	7.00	35.57	967	MHC complex	Major histocompatibility complex
26	21.06	21.98	26	SCD	Stearoyl-CoA desaturase

### Conclusions

Despite the fact that the high density SNP arrays are currently utilized for many purposes, the challenge for the cattle industry still remains to successfully present and realize this technology to the common practice on farms. One of the ways how to do this is to prepare low cost custom genotyping array in view of farmers' requirements. The use of low-density SNP arrays can be promising way how to reduce costs of genotyping and increase the number of genotyped animals. We prepared the low density SNP panel in order to provide farmers extensively information of animal's genetic potential with respect to increase of milk production and animals' resistance to mastitis occurrence. With respect to genetic improvement programs, the selection of animals with favourable genotype can increase not only genetic potential of an individual but also the economic value of traits of interest.

### Acknowledgement

This study was supported by the Slovak Research and Development Agency (APVV-14-0054). The biological samples were provided by the Breeding Services of the Slovak Republic (PSSR) and Breeders Association of Pinzgau cattle in Slovakia. With this we would like to acknowledge all those who have provided support for the collection of biological material.

### References

- Agerholm, J.S., Menzi, F., McEvoy, F.J., Jagannathan, V., Drögemüller, C. (2016). Lethal chondrodysplasia in a family of Holstein cattle is associated with a *de novo* splice site variant of *COL2A1*. BMC Veterinary Research, 12, 100.
- Albuquerque, L.G. (2016). Genome-Wide Association Study of Meat Quality Traits in Nellore Cattle. PLoS One, 11, e0157845.
- Bai, Y., Sartor, M., Cavalcoli, J. (2012). Current status and future perspectives for sequencing livestock genomes. Journal of Animal Science and Biotechnology, 3, 8.
- Boichard, D., Chung, H., Dasonneville, R., David, X., Eggen, A., Fritz, S., Gietzen, K.J., Hayes, B.J., Lawley, C.T., Sonstegard, T.S., Van Tassell, C.P., VanRaden, P.M., Viaud-Martinez, K.A., Wiggans, G.R., Bovine LD Consortium (2012). Design of a Bovine Low-Density SNP Array Optimized for Imputation. PLoS One, 7, e34130-10.



- Cooper, T.A., Wiggans, G.R., VanRaden, P.M. (2013). Short communication: relationship of call rate and accuracy of single nucleotide polymorphism genotypes in dairy cattle. *Journal of Dairy Science*, 96, 3336 - 3339.
- Dassonneville, R., Fritz, S., Ducrocq, V., Boichard, D. (2012). Short communication: Imputation performances of 3 low-density marker panels in beef and dairy cattle. *Journal of Dairy Science*, 95, 4136 - 4140.
- Deb, R., Singh, U., Kumar, S., Singh, R., Sengar, G., Sharma, A. (2014). Genetic polymorphism and association with milk production traits among Frieswal HF x Sahiwal) cross breed of India origin. *Iranian Journal of Veterinary Research*, 15, 406 - 408.
- Hristov, P.D., Teofanova, I. Mehandzhiyski, L. Zagorchev, R.G. (2012). Application of Milk Proteins Genetic Polymorphism for Selection and Breeding of Dairy Cows in Bulgaria. In: Chaiyabutr N. (editor). *Milk Production - Advanced Genetic Traits, Cellular Mechanism, Animal Management and Health*, InTech, 31 - 52.
- Hulsegge, B., Calus, M.P., Windig, J.J., Hoving-Bolink, A.H., Maurice-Van Eijndhoven, M.H., Hiemstra, S.J. (2013). Selection of SNP from 50K and 777K arrays to predict breed of origin in cattle. *Journal of Animal Science*, 91, 5128 - 5134.
- Judge, M.M., Kearney, J.F., McClure, M.C., Sleator, R.D., Berry, D.P. (2016). Evaluation of developed low-density genotype panels for imputation to higher density in independent dairy and beef cattle populations. *Journal of Animal Science*, 94, 949-962.
- Kasarda, R., Moravčíková, N., Trakovická, A., Mészáros, G., Kadlečík, O. (2015). Genome-wide selection signatures in Pinzgau cattle. In *Slovak Journal of Food Science*, 9, 268 - 274.
- Kaupe, B., Brandt, H., Prinzenberg, E.M., Erhardt, G. (2007). Joint analysis of the influence of CYP11B1 and DGAT1 genetic variation on milk production, somatic cell score, conformation, reproduction, and productive lifespan in German Holstein cattle. *Journal of Animal Science*, 85, 11 - 21.
- Khatkar, M.S., Moser, G., Hayes, B.J., Raadsma, H.W. (2012). Strategies and utility of imputed SNP genotypes for genomic analysis in dairy cattle. *BMC Genomics*, 13, 538.
- Khatkar, M.S., Zenger, K.R., Hobbs, M., Hawken, R.J., Cavanagh, J.A., Barris, W., McClintock, A.E., McClintock, S., Thomson, P.C., Tier, B., Nicholas, W.F., Raadsma, H.W. (2007). A primary assembly of a bovine haplotype block map based on a 15,036-single-nucleotide polymorphism panel genotyped in Holstein-Friesian cattle. *Genetics*, 176, 763 - 772.
- Kukučková, V., Moravčíková, N., Ferenčaković, M., Simčič, M., Mészáros, G., Sölkner, J., Trakovická, A., Kadlečík, O., Curik, I., Kasarda, R. (2017). Genomic characterization of Pinzgau cattle: genetic conservation and breeding perspectives. *Conservation Genetics*, 18, 893 - 910.
- Leonard, S., Khatib, H., Schutzkus, V., Chang, Y.M., Maltecca, C. (2005). Effects of the osteopontin gene variants on milk production traits in dairy cattle. *Journal of Dairy Science*, 88, 4083 - 4086.
- Leyva-Baca, I., Schenkel, F., Sharma, B.S., Jansen, G.B., Karrow, N.A. (2007). Identification of single nucleotide polymorphisms in the bovine CCL2, IL8, CCR2 and IL8RA genes and their association with health and production in Canadian Holsteins. *Animal Genetics*, 38, 198 - 202.
- Lyons, R.E., Buttsworth, S., Waine, D., Kelly, M. (2015). SNP-based parentage in an australian cattle industries context: does one size fit all? *Proc. Assoc. Advmt. Breed. Genet.* 21, 249 - 252.

- Magalhães, A.F.B., de Camargo, G.M.F, Fernandes, G.A.J., Gordo, D.G.M, Tonussi, R.L., Costa, R.B., Espigolan, R., de O. Silva, R.M., Bresolin, T., de Andrade, W.B.F., Takada, L., Feitosa, F.L.B., Baldi, F., Carvalheiro, R., Chardulo, L.A.L., de Mai, M.D., Sahana, G., Christiansen, F.B., Guldbrandtsen, B. (2010). A genome-wide association study for milk production traits in Danish Jersey cattle using a 50K single nucleotide polymorphism chip. *Journal of Animal Science*, 88, 3522 - 3528.
- Matukumalli, L.K., Lawley, C.T., Schnabel, R.D., Taylor, J.F., Allan, M.F., Heaton, M.P., O'Connell, J., Moore, S.S., Smith, T.P., Sonstegard, T.S., Van Tassell, C.P. (2009). Development and characterization of a high density SNP genotyping assay for cattle. *PLoS One*, 4, e5350.
- McClure, M.C., Sonstegard, T.S., Wiggans, G.R., Van Eenennaam, A.L., Weber, K.L., Penedo, C.T., Berry, D.P., Flynn, J., Garcia, J.F., Carmo, A.S., Regitano, L.C.A., Albuquerque, M., Silva, M.V.G.B, Machado, M.A., Coffey, M., Moore, K., Boscher, M.Y., Genestout, L., Mazza, L., Taylor, J.F., Schnabel, R.D., Simpson, B., Marques, E., McEwan, J.C., Cromie, A., Coutinho, L.L., Kuehn, L.A., Keele, J.W., Piper, E.K., Cook, J., Williams, R., Bovine HapMap Consortium, Van Tassell, C.P. (2013). Imputation of microsatellite alleles from dense SNP genotypes for parentage verification across multiple *Bos taurus* and *Bos indicus* breeds. *Frontiers in Genetics*, 4, 176.
- Miciński, J., Klupczyński, J., Mordas, W., Zablotna, R. (2007). Yield and composition of milk from Jersey cows as dependent on the genetic variants of milk proteins. *Polish Journal of Food and Nutrition Sciences*, 57, 95 - 99.
- Miller, S. (2010). Genetic improvement of beef cattle through opportunities in genomics. *Revista Brasileira de Zootecnia*, 39, 247 - 255.
- Moser, G., Khatkar, M., Hayes, B., Raadsma, H. (2010). Accuracy of direct genomic values in Holstein bulls and cows using subsets of SNP markers. *Genetic Selection Evolution*, 42, 37.
- Mulder, H.A., Calus, M.P., Druet, T., Schrooten, C. (2012). Imputation of genotypes with low-density chips and its effect on reliability of direct genomic values in Dutch Holstein cattle. *Journal of Dairy Science*, 95, 876 - 889.
- Mullen, M.P., McClure, M.C., Kearney, J.F., Waters, S.M., Weld, R., Flynn, P., Creevey, C.J., Cromie, A.R., Berry, D.P. (2013). Development of a Custom SNP Chip for Dairy and Beef Cattle Breeding, Parentage and Research. *Interbull Bulletin*, 47.
- Nayeri, S., Sargolzaei, M., Abo-Ismael, M.K., May, N., Miller, S.P., Schenkel, F., Moore, S.S., Stothard, P. (2016). Genome-wide association for milk production and female fertility traits in Canadian dairy Holstein cattle. *BMC Genetics*, 17, 75.
- Ogorevc, J., Kunej, T., Razpet, A., Dovc, P. (2009). Database of cattle candidate genes and genetic markers for milk production and mastitis. *Animal Genetics*, 40, 832 - 851.
- Olsen, H.G., Nilsen, H., Hayes, B., Berg, P.R., Svendsen, M., Lien, S., Meuwissen, T. (2007). Genetic support for a quantitative trait nucleotide in the ABCG2 gene affecting milk composition of dairy cattle. *BMC Genetics*, 8, 32.
- Pant, S.D., Schenkel, F.S., Leyva-Baca, I., Sharma, B.S., Karrow, N.A. (2007). Identification of single nucleotide polymorphisms in bovine CARD15 and their associations with health and production traits in Canadian Holsteins. *BMC Genomics*, 8, 421.
- Piccoli, M.L., Braccini, J., Cardoso, F.F., Sargolzaei, M., Larmer, S.G., Schenkel, F.S. (2014). Accuracy of genome-wide imputation in Braford and Hereford beef cattle. *BMC Genetics*, 15, 157.
- Pryce, J., Hayes, B. (2012). A review of how dairy farmers can use and profit from genomic technologies. *Animal Production Science*, 52, 180 - 184.

- Purcell, S., Neale, B., Todd-Brown, K., Thomas, L., Ferreira, M.A., Bender, D., Maller, J., Sklar, P., De Bakker, P.I.W., Daly, M.J., Sham, P.C. (2007). PLINK: a tool set for whole-genome association and population-based linkage analyses. *American Journal of Human Genetics*, 81, 559 - 575.
- Raadsma, H.W., Khatkar, M.S., Moser, G., Hobbs, M., Crump, R.E., Cavanagh, J.A., Tier, B. (2009). Genome wide association studies in dairy cattle using high density SNP scans. *Association for the Advancement of Animal Breeding and Genetics*, 18, 151 - 154.
- Saatchi, M., Garrick, D.J. (2014). Developing a Reduced SNP Panel for Low-cost Genotyping in Beef Cattle. *Animal Industry Report: AS 660, ASL R2854*.
- Sonstegard, T.S., Cole, J.B., VanRaden, P.M., Van Tassell, C.P., Null, D.J., Schroeder, S.G., Bickhart, D., McClure, M.C. (2013). Identification of a Nonsense Mutation in CWC15 Associated with Decreased Reproductive Efficiency in Jersey Cattle. *PLoS One*, 8, e54872.
- Szyda, J., Zukowski, K., Kaminski, S., Zarnecki, A. (2013). Testing different single nucleotide polymorphism selection strategies for prediction of genomic breeding values in dairy cattle based on low density panels. *Czech Journal of Animal Science*, 58, 136 - 145.
- Wang, X., Xu, S., Gao, X., Ren, H., Chen, J. (2007). Genetic polymorphism of TLR4 gene and correlation with mastitis in cattle. *Journal of Genetics and Genomics*, 34, 406 - 412.
- Weikard, R., Kuhn, C., Goldammer, T., Freyer, G., Schwerin, M. (2005). The bovine PPARGC1A gene: molecular characterization and association of a SNP with variation of milk fat synthesis. *Physiological Genomics*, 21, 1 - 13.
- Wiggans, G.R., Vanraden, P.M., Cooper, T.A. (2011). The genomic evaluation system in the United States: Past, present, future. *Journal of Dairy Science*, 94, 3202 - 3211.

## THE INFLUENCE OF SPRAYING LAYING HENS WITH TASTE DETERRENTS ON THE PLUMAGE CONDITION AND PRODUCTION TRAITS

Mojca PANČUR<sup>1\*</sup>, Dušan TERČIČ<sup>1</sup>, Uroš ŠRAJ<sup>2</sup>, Manja ZUPAN<sup>1</sup>

<sup>1</sup>University of Ljubljana, Biotechnical Faculty, Department of Animal Science, Slovenia

<sup>2</sup>University of Maribor, Faculty of Agriculture and Life Sciences, Slovenia

\*Corresponding author: mojca.pancur@bf.uni-lj.si

### Abstract

This is the first on-farm study looking at the influence of spraying laying hens with two non-toxic bird repellents on feather coverage on six body regions, egg quality and laying performance of the Slovenian Prelux-R layer strain. A total of 180 18-wk-old non trimmed cage hens were randomly assigned into 3 treatment groups (P, T, C) with 6 replicates of 10 birds each (60 hens per group) and for 20 weeks at two week intervals sprayed with two dimethyl anthranilate-based repellents (P and T), each being used on one group of the birds. Group C served as a control group, sprayed with distilled water only. Mean body weights of laying hens at the start of first experimental period, at 26 weeks of age were  $2083.42 \pm 156.69$ ,  $2107.08 \pm 194.76$  and  $2078.75 \pm 183.96$  g for the P, T and C groups, respectively. We found that hens sprayed with repellents T and P had greater ( $P < 0.05$ ) feed intake than group C. The dispersion of repellent T significantly ( $P < 0.05$ ) increased the albumen pH and yolk diameter and decreased the egg shape index compared with group P. The egg shell strength and yolk pH were significantly ( $P < 0.05$ ) lowered with T treatment in comparison with C group. The administration of the repellents resulted in poorer feather condition compared with group C. The yolk from group P was more intensively ( $P < 0.05$ ) coloured than the yolk in other groups. There were no other differences between the treatments. Based on these results, we can conclude that physical egg quality, plumage condition and especially feed intake in commercial flocks of laying hens can be significantly influenced by feather spraying with bird repellents.

**Keywords:** *Egg quality, Feather coverage, Laying hens, Repellents*

### Introduction

In laying hens, feather cover condition during the laying period is known to be affected by moulting, abrasion and feather pecking. Bad feather cover may lead to a greater skin exposure, which results in greater heat loss due to deteriorated heat insulation and as a consequence to a greater feed intake in cold seasons (Glatz, 2001). Feather pecking is a well-known behavioural disorder in all domestic poultry species (hens, turkeys, ducks, etc.). It is characterized as a painful feather removal (with bleeding) that can consequently lead to cannibalism (Harlander-Matauschek and Rodenburg, 2011). The poultry industry is often criticized for using beak trimming to solve the problem of feather pecking and cannibalism. Beak trimming, both by hot-blade and infra-red techniques, has significant adverse consequences for laying hens' welfare and should be avoided. Recognising that the requirement to stop routine beak trimming represents a major technical challenge to the poultry industry the goal of the study was to develop an animal-friendly method for preventing feather pecking and cannibalism and eliminating beak trimming by using non-harmful repellents. Many studies (e.g. Hile et al., 2004; Lourdes et al., 2016; Linz and

Homan, 2013; Ahmad et al., 2016) have been conducted where different aversive tastants were used for preventing crop damage caused by pest birds by treating the birds edibles. Research evidence of using repellents for preventing feather pecking under commercial farm conditions is scarce. There are only few studies (e.g. Harlander-Matauschek et al., 2009, 2010) that report repellency effects of substances applied on the laying hens which lead to a reduction in feather pecking among them. The main objective of our study was to find out if the application of different non-toxic bird repellents would have a significant improvement in feather coverage. Additionally, we were interested to look at the impact of the dimethyl anthranilate-based taste repellents on the production traits.

## Material and methods

### Animals and housing system

A total of 180 non-trimmed Prelux-R brown strain hens, hybrids from Slovenian silver-gold cross (silver female × gold male) were used. The chicks were first raised on floor pen on litter until the age of 18 weeks. At the age of 18 weeks, the pullets were randomly assigned to 3 experimental groups and transferred to enriched battery cages (Facco, Italy). Each experimental group consisted of 6 replicated cages comprising 10 layers. The cages were in 3 tiers. Hens in each group were put into cages in upper, middle and bottom levels. Cage was considered the experimental unit, giving 6 replicates per treatment. All birds were marked individually by metal leg rings. Layer chicks got chick starter feed up to ten weeks of age (11,9 MJ ME kg<sup>-1</sup>; 20% crude protein), at ten weeks they were changed over to grower feed (11,4 MJ ME kg<sup>-1</sup>, 15% crude protein) and at eighteen weeks they were changed over to layer ration (11,3 MJ ME kg<sup>-1</sup>; 16,2% crude protein). Feed in crumble form and water were supplied *ad libitum* throughout the experimental period. All feeding mixtures were purchased from Jata Emona Ltd. animal feed manufacturer (Ljubljana, Slovenia). The light regimen consisted of 15 h of red light and 9 h of dark. The average light intensity measured at the feeding trough level varied from 0.3 to 3.3 lux. The study was conducted with birds from 20 weeks of age until 40 weeks of age and comprised 2 periods (Period I = 26 to 28 weeks; Period II = 38 to 40 weeks).

### Repellent application

Control birds (group C) were sprayed with distilled water only. Hens in the group P were sprayed with a repellent P containing in terms of percent by weight 0.78 dimethyl anthranilate, 12.5 methyl phenyl acetate and 86.7 propylene glycol and hens in the group T with a repellent T containing in terms of parts by weight 4.5 dimethyl anthranilate, 0.5 geraniol, 5.0 Tween 80 and 90.0 distilled water. Compressed air spray paint guns were used for repellent and distilled water dispersion. During the pilot study, we experimentally determined that 300 ml of liquid sprayed over one group of birds (60 hens in 6 cages) is sufficient to ensure good coverage of plumage areas needing protection. Each experimental group of birds was subjected to a spray treatment at 14 day intervals from 20 weeks of age onwards.

### Data collection

Four classes of variables were measured: variables concerning feather cover; those related to egg production, egg and shell quality; those related to body weight and those concerning feed intake. For feather condition evaluation the scoring system of Tauson et. al (2005) was used. Scores, varying from 1 to 4 were given for each of the following body parts: back, wings, tail, cloaca area, neck and breast. Higher scores represented better feather condition. Feather condition was scored individually, at the age of 20, 26 and 38 weeks. Over the two periods of

14 successive days between the ages of 26-28 and 38-40 weeks feed intake was measured. Daily feed intake was calculated for each cage by subtracting the left over feed in the feeder from the total weight of feed given during that day. Egg production was recorded daily. Hen-day egg production for a particular day and cage was calculated by dividing the total number of eggs produced on a day in a cage by the total number of hens present on that day in a cage and multiplying by 100 to convert to a percentage. Hen-housed egg production for a particular day was reached by dividing the total number of eggs laid on a day in a cage by the total number of hens housed at the beginning of the experiment in a cage and multiplying the resulting quotient by 100 to convert it to a percentage. Egg quality parameters were determined at the end of each experimental period. A total of 272 eggs were randomly collected from 3 groups and analyzed for the following physical characteristics: egg width, length and weight, colour and strength of egg shell, yolk diameter and colour, height of albumen. Based on egg weight and albumen height, the Haugh units were calculated. Shape index was calculated using the formula: shape index = (egg width, cm/egg length, cm) × 100. Yolk diameter, egg length and width were measured with digital caliper, egg shell strength with Instron 3342 device (Instron, USA). All other characteristics were measured with a set of electronic apparatus developed at the University of York, Great Britain (Technical Services and Supplies, York). Albumen and yolk pH were measured with S47-K Seven Multi dual meter pH/conductivity (Mettler-Toledo, Switzerland) device.

#### Statistical analysis

Data obtained were subjected to statistical analysis using the GLM (feather condition scores) and MIXED (feed intake, egg production, egg quality) procedures of SAS Institute (2008). The sum of the scores of the six body parts and the sum of the scores for back and vent/cloaca were used for analysis. Data of feed intake, egg production and egg quality were untransformed. Experimental period and treatment group were the fixed effects and cage was random effect. When the main effects were significant at  $P < 0.05$ , differences between means were tested using Tukey's test.

### Results and discussion

The usage of repellents affected the cumulative plumage variable back+vent/cloaca as well as the variable total feather score ( $P < 0.05$ ). For the variable back+vent/cloaca, hens from treatment C ( $7.81 \pm 0.05$ ) had the highest feather score compared to hens from P ( $7.66 \pm 0.05$ ) and T ( $7.57 \pm 0.05$ ). Looking at the variable total feather score, hens from treatment C ( $23.4 \pm 0.08$ ) had the highest feather score compared to hens from P and T ( $22.9 \pm 0.08$ ). Hence it is evident from this comparative study that the use of two repellents didn't improve feather cover when compared with hens in the control group. This result is not in accordance with study results of Harlander-Matauschek and Rodenburg (2011) who reported that soaking feathers in eleven chemical substances reduced feather plucking and consumption. However, results from our study are not directly comparable with those from the Harlander-Matauschek and Rodenburg (2011) for several reasons but mainly because of different experimental conditions and different repellents used. Different distasteful substances have different active repellent ingredients and probably have different lasting effect on different bird senses. The results will most likely become clearer by the end of this on-going study.

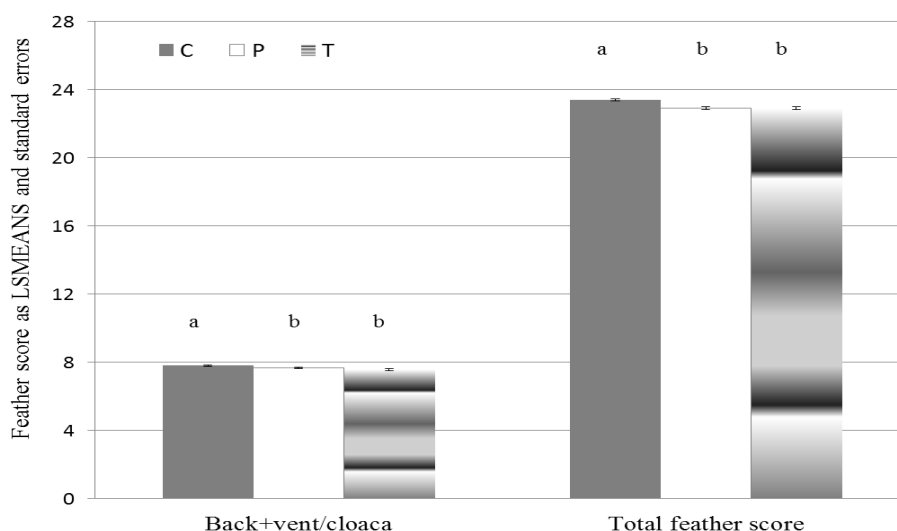


Fig. 1: The feather condition by treatment (C - control, P - repellent P, T - repellent T).  
<sup>a,b</sup> Means followed by the different letters are significantly different ( $P < 0.05$ )

A non-significant ( $P > 0.05$ ) difference was found when compared the effect of repellent application on the body weight of hens at the start of the second experimental period. Thus, it can be concluded, that repellents did not affect the weight of laying hens during the experimental period. At 38 weeks of age the body weights of the three experimental groups were in terms of  $LSM \pm SE$   $2124.41 \pm 26.60$ ,  $2173.77 \pm 27.29$  and  $2119.03 \pm 27.29$  g for the P, T and C groups, respectively. The peak hen-day egg production was at 84,97%, for the hens from C group, 83,71 % for the hens from T group and 82,68% for the hens from P. During the experimental period (20-40 weeks of age), the overall percentage of hen-day egg production was not significantly different between the three treatments. At the 40 weeks of age, differences in egg production were also insignificant between the groups ( $P > 0.05$ ). Our results differ from Yamak and Sarica (2012) who found the positive correlation between the better plumage condition and the increased egg production. The feed consumption in T (average  $138.24 \pm 1.16$  g/hen/day) and P groups (average  $135.21 \pm 1.16$  g/hen/day) were significantly ( $P < 0.05$ ) higher in compared to C group (average  $130.20 \pm 1.16$  g/hen/day). This could be explained by the better feather cover of hens in C group. These hens may as a consequence have better heat insulation and a lower feed intake request. Similarly, Glatz (2001) reported that naked hens compared to fully feathered birds consume 31 g/bird (18 °C) to 41 g/bird (15 °C) more feed. A significant difference ( $P < 0.05$ ) was also found in the feed consumption between the two experimental periods (Table 1). Hens in the second experimental period consumed significantly more feed than the hens in the first period. This was expected in regards to a higher body weight of older laying hens in the second period. In agreement with the present results, Leeson and Summers (1987), Harms et al. (1982) and Lacin et al. (2008) reported that feed consumption increased as the body weight of hens increased.

Table 1: Feed intake (g) by experimental period and treatment group

Trait	Experimental period	Treatment group	LSM ± SE
Feed intake (g/hen/day)	Period I		132.35 ± 0.949 <sup>a</sup>
	Period II		136.75 ± 0.949 <sup>b</sup>
		C	130.20 ± 1.163
		P	135.21 ± 1.163 <sup>a</sup>
		T	138.24 ± 1.163 <sup>a</sup>

LSM – estimated mean value of trait, calculated using the least squares method, SE – standard error of estimation; <sup>a,b,c</sup> Means followed by the different letters in the same column are significantly different (P < 0.05)

Table 2 shows the egg quality parameters of experimental periods and treatment groups. Egg shape index, yolk diameter, albumen pH, yolk pH, shell colour and strength were affected by the particular experimental period (I, II). There were significant differences among C and T groups for shape index, yolk diameter, albumen pH, yolk pH and egg shell strength. P group had lower yolk pH value, shell colour and yolk colour than hens placed in C group (Table 2). Walker and Hughes (1998) reported that hens who have experienced stress retain eggs in their oviduct for prolonged periods of time leading to deposition of calcium carbonate and consequently whiter eggs. The darker egg shell colour in the repellent groups as well as nonsignificant differences in egg production indicate that the welfare status of hens was similar in both treatments and was not worse in comparison to control group. The yolk diameter of eggs from the 2<sup>nd</sup> experimental period was greater due to a larger egg weight. It is a general consensus that older hens lay heavier eggs than younger hens (Perić et al., 2017) and this was further supported in this study. On the other hand, the egg shell strength decreases with increasing hen age (Perić et al., 2017), that was the reason for lower shell strength of eggs from 2<sup>nd</sup> experimental period.

Table 2: Egg quality traits by experimental period and treatment group

Trait	Experimental period	Treatment group	LSM ± SE
Egg shape index	Period I		76.66 ± 0.192 <sup>a</sup>
	Period II		75.73 ± 0.269 <sup>b</sup>
		C	76.63 ± 0.287 <sup>a</sup>
		P	76.62 ± 0.283 <sup>a</sup>
		T	75.35 ± 0.289
Yolk diameter (mm)	Period I		39.46 ± 0.121 <sup>a</sup>
	Period II		43.32 ± 0.171 <sup>b</sup>
		C	41.23 ± 0.179 <sup>a</sup>
		P	41.16 ± 0.181 <sup>a</sup>
Albumen pH	Period I		8.47 ± 0.015 <sup>a</sup>
	Period II		8.39 ± 0.021 <sup>b</sup>
		C	8.42 ± 0.023 <sup>a</sup>
		P	8.38 ± 0.022 <sup>a</sup>
Yolk pH	Period I		6.19 ± 0.012 <sup>a</sup>
	Period II		6.13 ± 0.017 <sup>b</sup>
		C	6.21 ± 0.018
		P	6.13 ± 0.018 <sup>a</sup>
Shell colour (%)	Period I		34.86 ± 0.414 <sup>a</sup>
	Period II		39.65 ± 0.580 <sup>b</sup>
		C	38.35 ± 0.619 <sup>a</sup>



		P	36.20 ± 0.610 <sup>b</sup>
		T	37.22 ± 0.622 <sup>ab</sup>
Egg weight (g)	Period I		63.15 ± 0.354
	Period II		66.35 ± 0.498
Egg weight (g)		C	64.23 ± 0.531
		P	65.19 ± 0.524
		T	64.82 ± 0.533
Albumen height (mm)	Period I		7.53 ± 0.093
	Period II		6.28 ± 0.132
Albumen height (mm)		C	6.88 ± 0.140
		P	7.12 ± 0.139
		T	6.71 ± 0.140
Haugh units	Period I		85.17 ± 0.648
	Period II		75.27 ± 0.924
Haugh units		C	80.19 ± 0.983
		P	81.15 ± 0.967
		T	79.31 ± 0.983
Yolk colour (Roche)	Period I		11.08 ± 0.043
	Period II		11.04 ± 0.060
Yolk colour (Roche)		C	10.96 ± 0.064 <sup>a</sup>
		P	11.22 ± 0.063
		T	10.99 ± 0.064 <sup>a</sup>
Egg shell strength (N)	Period I		44.30 ± 0.539 <sup>a</sup>
	Period II		41.18 ± 0.746 <sup>b</sup>
Egg shell strength (N)		C	44.08 ± 0.798 <sup>a</sup>
		P	43.04 ± 0.789 <sup>ab</sup>
		T	41.11 ± 0.803 <sup>b</sup>

### Conclusions

In conclusion, this study shows that the use of two repellent compounds influenced some important parameters of laying performance and egg quality in commercially reared laying hens. Daily feed consumption was found to be higher in repellent treated groups than in the control group. Body weight, egg production and egg weight variables were similar in all experimental groups. However, some measures of egg quality, e.g., egg shell strength and yolk diameter were significantly worse in T group in comparison to C group. Feather condition was better in C hens than in P and T hens. Since feather scores provide information about the welfare status of the hens we can conclude that spraying repellents in our study did not improve feather cover (welfare status) but the final results will be seen at the end of our one year lasting study.

### References

- Ahmad S., Saleem Z., Jabeen F., Ahmad Khan H., Yaqub S., Samiullah K., Mubarik S., Irfan M., Shaheen T. (2016). Effectiveness of Methylantranilate and Anthraquinone as repellent against House Crows (*Corvus splendens*) on wheat seeds and seedlings in captivity. *Pakistan Journal of Zoology*, 48 (5), pp. 1591-1594.
- Glatz P. C. (2001). Effect of poor feather cover on feed intake and production of aged laying hens. *Asian-Australasian Journal of Animal Sciences*, 14(4), pp. 553-558.
- Harlander-Matauschek A., Beck P., Piepho H. P. (2009). Taste aversion learning to eliminate feather pecking in laying hens, *Gallus gallus domesticus*. *Animal Behaviour*, 78, pp. 485-490.

- Harlander-Matauschek A., Beck P., Rodenburg T.B. (2010). Effect of an early bitter taste experience on subsequent feather-pecking behaviour in laying hens. *Applied Animal Behaviour Science*, 127, pp. 108–114.
- Harlander-Matauschek A., Rodenburg T.B. (2011). Applying chemical stimuli on feathers to reduce feather pecking in laying hens. *Applied Animal Behaviour Science*, 123, pp.146-151.
- Harms R.H., Costa P.T., Miles R.D. (1982). Daily feed intake and performance of laying hens grouped according to their body weight. *Poultry Science*, 61 (6), pp. 1021–1024.
- Hile A.G., Shan Z., Zhang S.Z., Block E. (2004). Aversion of European starlings (*Sturnus vulgaris*) to garlic oil treated granules: garlic oil as an avian repellent. Garlic oil analysis by nuclear magnetic resonance spectroscopy. *Journal of Agricultural and Food Chemistry*, 52, pp. 2192–2196.
- Lacin E., Yildiz A., Esenbuga N., Macit M. (2008). Effects of differences in the initial body weight of groups on laying performance and egg quality parameters of Lohmann laying hens. *Czech Journal of Animal Science*, 53, pp. 466–471.
- Leeson S., Summers J.D. (1987). Effect of immature body weight on laying performance. *Poultry Science*, 66, pp. 1924–1928.
- Linz G. M., Homan H. J. (2013). Demonstration of Avian Control ® bird repellent (a.i., methyl anthranilate) for managing blackbird damage to ripening sunflower. USDA national wildlife research center-Staff publications, pp.1-8
- Lourdes O., Rodriguez E., Ceretta S., Beyhaut E. (2016). Repelentes de aves aplicados a la semilla de soja: compatibilidad con el inoculante y residualidad en cotiledones. *Agrociencia Uruguay*, 20 (2), pp. 51-61.
- Perić L., Đukić Stojčić M., Bjedov S. (2017) The effect of storage and age of hens on the quality of table eggs. *Advanced Research in Life Sciences* 1(1), pp. 64-67
- SAS Institute. (2008). The SAS System for Windows, Release 9.4. Cary, NC, SAS Institute.
- Tauson R., Kjaer J., Maria G. A., Cepero R., Holm K.-E. (2005). Applied scoring of integument and health in laying hens. *Animal Science Papers and Reports*, 23 (Suppl. 1), pp. 153-159.
- Yamak U. S., Sarica M. (2012). Relationships between feather score and egg production and feed consumption of different layer hybrids kept in conventional cages. *European poultry science, Archiv für Geflügelkunde*, 76 (1), pp. 31-37.
- Walker, A. W.; Hughes, B.O. (1998). Egg shell colour is affected by laying cage design. *British Poultry Science*, 39, pp. 696-699.

## USING HERBAL MIXTURES IN DAIRY MILK PRODUCTION AND THEIR EFFECTIVENESS DURING APPLICATION ON GROUP FED DAIRY CATTLE

Hulusi AKÇAY<sup>1\*</sup>, Orçun ELBIRLIK<sup>2</sup>

<sup>1\*</sup>Adnan Menderes University, Faculty of Agriculture, Department of Animal Science, 09100 Aydin, Turkey

<sup>2</sup>Tecnofirm, Feed Additives, Food and Animal Drugs Company, Agricultural Engineer, Çiğli-Izmir, Turkey

\*Corresponding author:hakcay@adu.edu.tr

### Abstract

Natural additives, particularly essential oils, phenolic and aromatic compounds and some secondary metabolites originated from herbal sources became popular at last decades in ruminant nutrition by limiting or banning the use of antibiotics, performance enhancers and other growth promoters. In brief, these products help in providing better ruminal ecosystem, preventing excess degradation of soluble protein in rumen and maintaining ruminal ammonia and decreasing energy losses. Consequently, this leads not only to enhancing protein and energy utilization but also to elevating milk production and herd health status of dairy cattle. The objective of this work is to determine the duration of the effect of herbal mixtures on group fed dairy cattle at initial and post-trial period practically and, to determine the reflections of group milk yield. In this study, 98 days-data of high milk producing group (average N, 165) was evaluated for yield, protein, fat, lactose and dry matter contents of milk. Herbal mixture commercially formulated containing aromatic compounds with tannin was added to diet as “on top” 20 g day<sup>-1</sup> per head. Observation period is described as three session before test (BT-without supplement), test (T), after test (AT- without supplement) and, 18 days, 43 days and 37 days respectively. It was observed that milk yield increased and continued to rise until supplement removing date. While milk protein increasing, milk fat is decreased in (T) test period. There was no decrease in milk yield during the 17 days of the AT. It may be concluded that herbal mixtures can help in sustaining milk production.

**Keywords:** *Herbal mixtures, additive, dairy cow, nutrition.*

### Introduction

A healthy rumen should produce volatile fatty acids, supply microbial protein and support energy and protein metabolism by helping rumen microorganisms during fermentation process. To ensure ruminal fermentation many feed additives such as ionophore antibiotics are widely used to maintain better ruminal ecosystem and to increase feed efficiency since January 1st, 2006 in EU and also in Turkey. Afterwards, by the end of 2005, EU Commission announced to ban ionophore antibiotics already used as growth promoters like Monensin, Salinomycin, Avilamycin and Flavophospholipol (EC, 2005). Meanwhile, natural additives, particularly essential oils, phenolic and aromatic compounds and some secondary metabolites originated from herbal sources became popular at last decades in ruminant nutrition by limiting or banning the use of antibiotics, performance enhancers and other growth promoters (Wallace et al, 2002; Benchaar et al, 2009; Patra and Yu, 2012; Matloup et al, 2017). Actually, herbal sources are well known products since ancient times and the dates back to Mesopotamia (Greathead, 2003; Benchaar. and Greathead, 2011). A great variety of them used for human health and Benchaar et al, 2011 are stated it briefly in their respectable review. In addition to these studies, in recent years, there have also been some essential oil

studies for the preservation of foods with their antimicrobial properties (Calo et al, 2015). In brief, these products help in providing better ruminal ecosystem, preventing excess degradation of soluble protein in rumen and maintaining ruminal ammonia and decreasing energy losses (Anantasook, 2016). Consequently, this leads not only to enhancing protein and energy utilization but also to elevating milk production and herd health status of dairy cattle. The objective of this work is to determine the duration of the effect of herbal mixtures on group fed dairy cattle at initial and post-trial period practically and, to determine the reflections of group milk yield.

### Material and Methods

In this field case study, 98 days of test day milk records and milk analysis data obtained from a private farm, dates from October, 1st 2016 to February, 6th 2017 is evaluated. Subjected to research group size of dairy cattle is continuously changed during the test period between minimum 151 and maximum 175 heads and averagely 165.75 heads. Lactation statuses of cattle are changed between 111 and 144 days in milk (DIM), averagely 123.58 and all of test group is accepted homogenous. Similarly, dairy cattle are fed in one group and consumed the same diet during the observation period. Diet is consisted of corn silage, alfalfa hay, wheat straw, compound feed and by-pass fat. Diet composition is given below in Table 1. All cattle consumed same diet. Tested aromatic mixture containing tannin (58800 mg/kg), Valopro is given “on top” 20 g daily per head. Valopro is provided by Tecnofirm Yem Katkı Maddeleri Gıda Hayvancılık İlaç Sanayi ve Ticaret Ltd Şti., İzmir, Turkey. Observation period is described as three session before test (BT-without supplement), test (T), after test (AT-without supplement) and, 18 days, 43 days and 37 days respectively. Dairy cattle are milked three times in a day with 2 x 8 milking system and daily milk production is recorded. Protein, fat, lactose and dry matter contents of milk samples are analysed daily by Bentley 150 Infrared Milk Analyzer. Descriptive statistics of collected data is analysed by SPSS Statistical software.

Table 1. Diet ingredients\*

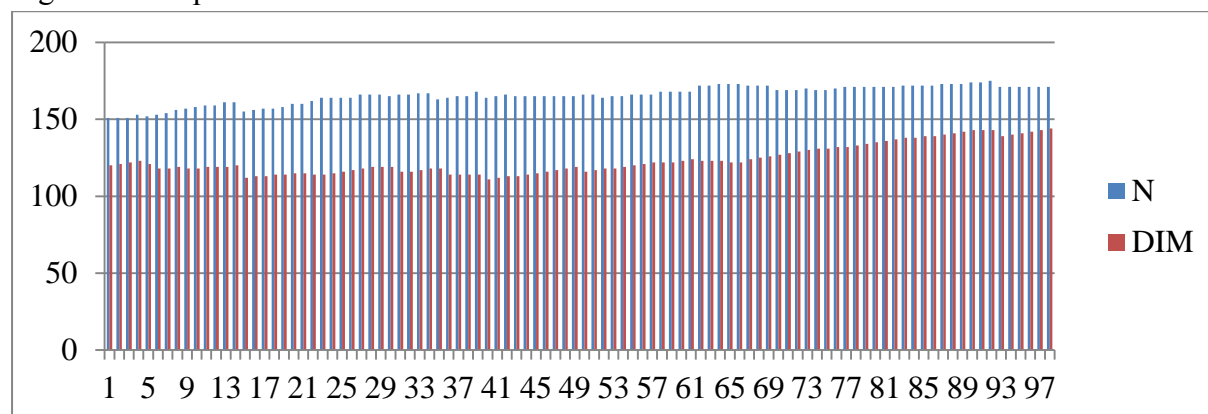
Ingredients	As fed, kg	As fed, %	Dry Matter, kg
Corn silage 32.2% DM, 29.8% Starch, 810 Kcal/kg ME	22,5	52,02	7,25
Wheat straw	0,5	1,16	0,44
Alfalfa 18% CP	4,75	10,98	4,13
Compound feed 23% CP, 3000 kcal/kg ME	15	34,68	13,35
By-pass fat	0,5	1,16	0,45

\*Due to the preliminary private farm study, only available analysed results given in the table. All cows are consumed same diet.

## Results and Discussion

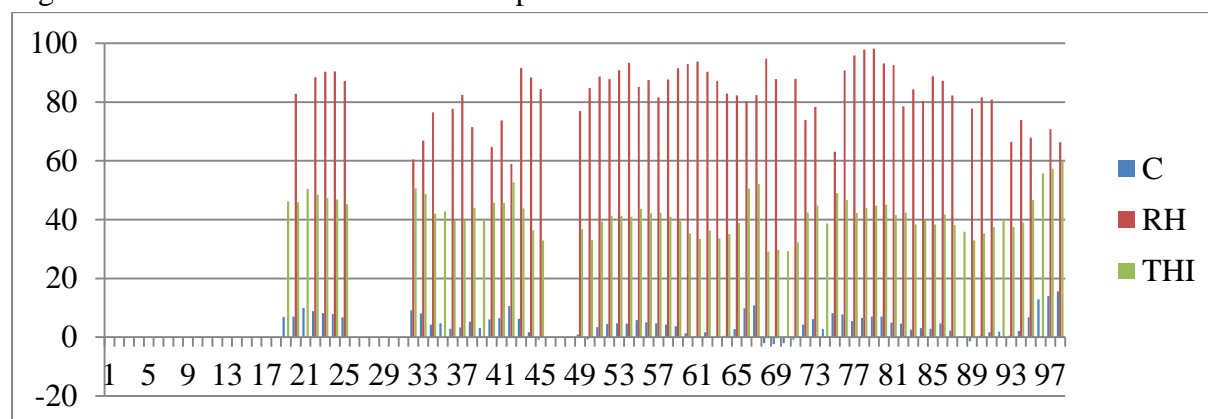
Number of dairy cattle and their days in milk status is given in Figure 1. As described above in material chapter, the group is accepted homogenous.

Figure 1. Group size and cattle's DIM status



During the 98 days of study, observed climatic conditions and calculated temperature humidity index (THI) is given in Figure 2 below. Average, minimum and maximum temperatures are observed 4.5 °C, -2.4 °C and 15.6 °C, respectively. Whole period relative humidity (RH) and THI values are observed 82.6% (min. 58.9%, max.98.2%) and, 41.8% (min.29.1%, max. 59.7%), respectively. According to available data, during the experiment time, climatic conditions is accepted similar.

Figure 2. Climatic conditions of whole period

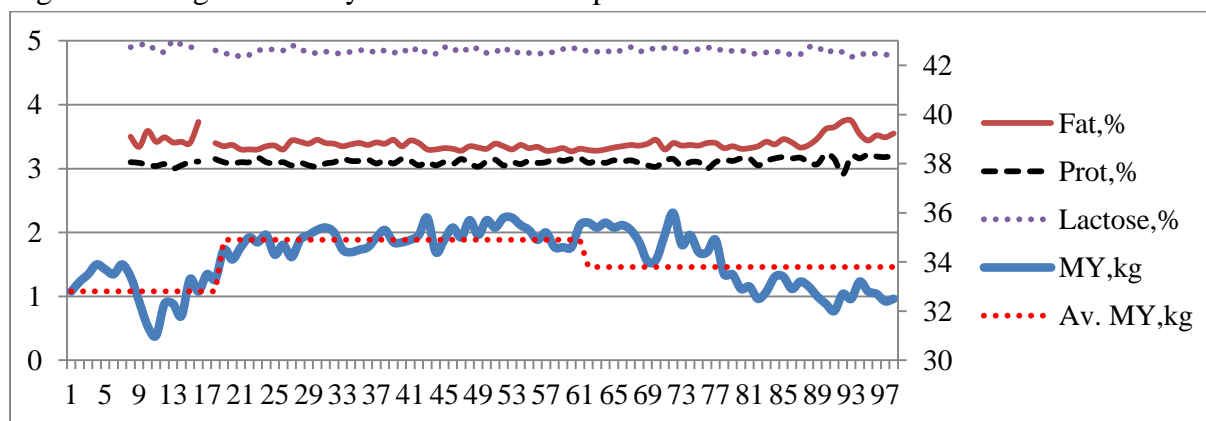


As described above, whole experimental period evaluated three sessions. In Table 2 and Figure1, whole period, before test, test and after test descriptive statistics of milk yield (MY), milk fat, milk protein, milk lactose and milk dry matter contents are given detailed.

Table 2. Descriptive statistics of measured parameters

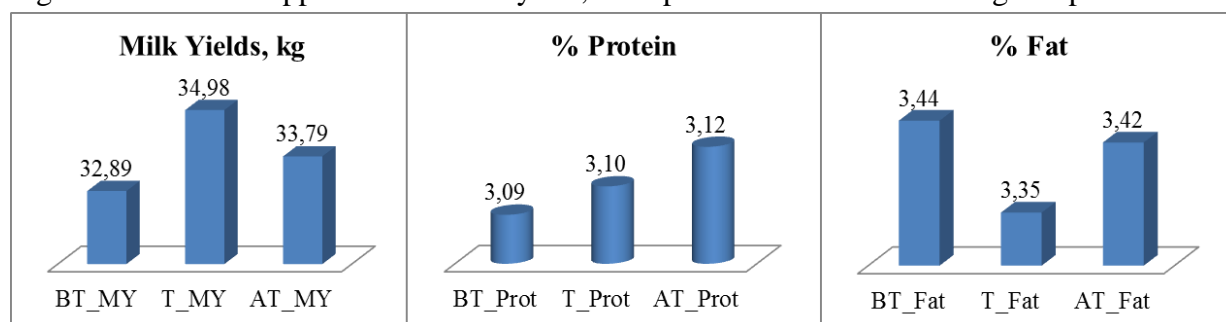
		N	Minimum	Maximum	Mean	Std. Err.
Whole Period	MY	98	31,0	36,0	34,15	,1196
	Fat	91	3,1	3,8	3,39	,0108
	Protein	91	2,9	3,2	3,11	,0054
	Lactose	91	4,8	5,0	4,84	,0048
	DM	91	11,5	12,6	11,88	,0264
Before Test	BT_MY	18	31,0	33,9	32,89	,2016
	BT_Fat	11	3,1	3,7	3,44	,0445
	BT_Protein	11	3,0	3,2	3,09	,0147
	BT_Lactose	11	4,8	5,0	4,90	,0173
	BT_DM	11	11,6	12,2	11,86	,0457
Test	T_MY	43	34,1	35,8	34,98	,0695
	T_Fat	43	3,3	3,5	3,35	,0077
	T_Protein	43	3,0	3,2	3,10	,0055
	T_Lactose	43	4,8	4,9	4,84	,0060
	T_DM	43	11,5	11,9	11,75	,0123
After Test	AT_MY	37	32,0	36,0	33,79	,1963
	AT_Fat	37	3,3	3,8	3,42	,0195
	AT_Protein	37	2,9	3,2	3,12	,0105
	AT_Lactose	37	4,8	4,9	4,84	,0067
	AT_DM	37	11,6	12,6	12,02	,0528

Figure1. Changes of milk yield and milk components



According to the collected data, it is observed that Valopro aromatic herbal mixture increased milk yield and milk protein. First 18 days, without supplement, milk yields and other milk components of group were recorded. Then, from day 19 to 61, 43 days long, supplement was added. When supplement is cut off on 61<sup>st</sup> day (last day of 43 days test period), an ongoing effect of aromatic compound for 17 days until 78<sup>th</sup> day of experiment without supplement was observed.

Figure 3. Effect of supplement on milk yield, milk protein and milk fat during test period.



With supplementation of aromatic compound, milk yield of group is increased to 2.09 kg and it can be concluded that the supplement established convenient rumen conditions. Milk increase is agreed with many studies results Benchaar et al, 2007; Matloup et al, 2017. The essential oils prevent deamination of protein and N sources in rumen and support microbial protein production while decreasing ammonia production. That means more efficient protein and energy utilization in the digestive system (McIntosh, 2003; Castillejos et al, 2006; Calsamiglia et al, 2007; Canbolat et al, 2011; Flores et al, 2013). Similarly, milk protein percentage increased particularly “after test period” and the remarkable increase is observed at 0.03% level. Probably, additional tannin in the aromatic mixture ensured this effect (Decruyenaere, 1996; González et al, 2002; Wanapat et al, 2013; Lui et al, 2016). But, on the other hand, milk fat content is decreased. This result can be attributed to the adverse effect of essential oils on milk fat percentage (Benchaar et al, 2006; Calsamiglia et al, 2007). (Figure 3).

### Conclusions

As a result of this study, it can be concluded from current observations, supplementation of Valopro aromatic mixture seemed to have positive effect on milk yield not only during supplementation period but also without supplemented post 17 days long at group fed dairy cattle. After supplement added to TMR, the effect was observed in one week. Although milk production and protein content affected positively, milk fat percentage decreased. Further studies will be helpful.

### References

- Anantasook, N., M. Wanapat, et al. (2016). Reducing methane production by supplementation of Terminalia chebula RETZ. containing tannins and saponins. *Animal Science Journal* 87(6): 783-790.
- Benchaar C., H.V. Petit, R. Berthiaume, D.R. Ouellet, J. Chiquette, P.Y. Chouinard, (2007). Effects of essential oils on digestion, ruminal fermentation, rumen microbial populations, milk production, and milk composition in dairy cows fed alfalfa silage or corn silage, *Journal of Dairy Science*, 90 (2), 886-897.
- Benchaar C., H.V. Petit, R. Berthiaume, T.D. Whyte, P.Y. Chouinard, (2006). Effects of addition of essential oils and monensin premix on digestion, ruminal fermentation, milk production, and milk composition in dairy cows, *Journal of Dairy Science*, 89 (11),4352-4364.
- Benchaar, C. and H. Greathead (2011). Essential oils and opportunities to mitigate enteric methane emissions from ruminants. *Animal Feed Science and Technology* 166: 338-355.

- Benchaar, C., Hristov, A.N., Greathead, H., (2009). Essential oils as feed additives in ruminant nutrition. In: Steiner, T. (Ed.), *Phytogenics in Animal Nutrition. Natural Concepts to Optimize Gut Health and Performance*. Nottingham University Press, Nottingham, UK, pp. 111–146.
- Calo, J. R., Crandall, P. G., O'Bryan, C. A., Ricke, S. C. (2015). Essential oils as antimicrobials in food systems—A review. *Food Control*, 54, 111-119.
- Calsamiglia, S., M. Busquet, et al. (2007). Invited Review: Essential oils as modifiers of rumen microbial fermentation. *Journal of Dairy Science* 90(6): 2580-2595.
- Canbolat O, Kalkan H, Karaman S. Filya I., (2011). The effect of essential oils on the digestibility, rumen fermentation and microbial protein production. *J Fac Vet Med Kafkas Univ.*; 17 (4): 557-565.
- Castillejos, L., S. Calsamiglia, et al. (2006). Effect of essential oil active compounds on rumen microbial fermentation and nutrient flow in in vitro systems. *Journal of Dairy Science* 89(7): 2649-2658.
- Decruyenaere V., D. Remond , N. Zimmer , C. Poncet, A. Jebri , A. Thewis, (1996). Effet des tanins de chataignier sur la digestion in sacco et in vivo des matieres azotees chez les ruminants. *Renc. Rech. Ruminants*. 3, 93- 96.
- EC (2005), Ban on antibiotics as growth promoters in animal feed enters into effect, IP/05/1687, Brussels, 22 December 2005.
- Flores, A. J., Garcarena, A. D., Vieyra, J. M. H., Beauchemin, K. A., Colombatto, D. (2013). Effects of specific essential oil compounds on the ruminal environment, milk production and milk composition of lactating dairy cows at pasture. *Animal feed science and technology*, 186(1), 20-26.
- González S., M. L. Pabón and J. Carulla, (2002). Effects of tannins on in vitro ammonia release and dry matter degradation of soybean meal. *Arch. Latinoam. Prod. Anim.* 10(2): 97-101.
- Greathead, H, (2003). Plant and plant extract for improving animal productivity. *Proc Nutr Soc* 62, 279–290.
- Liu, H., K. Li, et al. (2016). Effects of chestnut tannins on the meat quality, welfare, and antioxidant status of heat-stressed lambs. *Meat Science* 116: 236-242.
- Matloup, O. H., El Tawab, A. A., Hassan, A. A., Hadhoud, F. I., Khattab, M. S. A., Khalel, M. S., Kholif, A. E. (2017). Performance of lactating Friesian cows fed a diet supplemented with coriander oil: Feed intake, nutrient digestibility, ruminal fermentation, blood chemistry, and milk production. *Animal Feed Science and Technology*, 226, 88-97.
- McIntosh F.M., P. Williams, R. Losa, R.J. Wallace, D.A. Beever, C.J. Newbold, (2003). Effects of essential oils on ruminal microorganisms and their protein metabolism. *Appl. Environ. Microbiol.*, 69, pp. 5011-5014.
- Patra, A. K., Yu, Z. (2012). Effects of essential oils on methane production and fermentation by, and abundance and diversity of, rumen microbial populations. *Applied and Environmental Microbiology*, 78(12), 4271-4280.
- Wallace R. J, N. R. McEwan, F.M. McIntosh, B. Teferedegne, C.J. Newbold, (2002). Natural products as manipulators of rumen fermentation. *Asian-Aust. J. Anim. Sci.* 15 (10) : 1458-1468.
- Wanapat, M., Kang, S., Polyorach, S. (2013). Development of feeding systems and strategies of supplementation to enhance rumen fermentation and ruminant production in the tropics. *Journal of Animal Science and Biotechnology*, 4(1), 32.



## **INVESTIGATION OF RELATIONSHIPS BETWEEN SOME CHARACTERISTICS OF HAIR GOATS**

Funda E. ATAÇ\*, Çiğdem TAKMA, Yakut GEVREKÇİ, Muzaffer ÇEVİK

Department of Animal Science, Faculty of Agriculture, University of Ege, İzmir, Turkey

\*Corresponding author: funda.erdogan.atac@ege.edu.tr

### **Abstract**

In goat breeding, several traits can be explained not by the single variable, but by the possible connection of the common several dependent or independent variables. For this purpose, the mentioned variables must be taken together and defined multi-dimensionally. In this study; the relationships of herd, year of birth, birth type, sex, weight at birth, weight at thirty day of age and weight at weaning age effects of Turkish Hair Goats were investigated by canonic correlation analysis. The data were utilized from 1020 male and 1011 female Hair goat kids which were born in the period 2013 until 2016. The herd, year of birth, birth type and sex are analyzed as first set of variables (X); weight at birth, weight at thirty day of age and weight at weaning age effects are analyzed as second set of variables (Y). By performing canonical correlation analysis, canonical correlations between the first, second and third pair of canonical variates were estimated and three canonical correlation were found significant ( $P < 0.01$ ). The biggest correlations between year of birth, sex, birth type variables and v1, v2 and v3 canonical variates were found -0.77%, 0.87% and -0.82%, respectively. The biggest correlations between weight at birth, weight at thirty day of age and weight at weaning age and w1, w2 and w3 canonical variates were found 0.84%, -0.97% and -0.78%, respectively. As a result it has been determined that sex and birth type plays an important role in the formation of the goat kid's body weights.

**Keywords:** *Hair Goat, Canonic correlation, Body weight*

### **Introduction**

Turkey is taking a very important position with geographic location and livestock production of Europe. In the last 15 years, goat is one of the two species that has significantly increased in population of the World. This increase could be due to the scarce conditions created by global warming or the better understanding of the importance of goat products. In terms of goat population Turkey is ranked 23th in the world, seventh in Europe. Also Turkey 9.2 million goats which is represent 63% of the European Union goat population. 23.3% of the small ruminants in Turkey are goats and 98% of this consists of hair goats (Ataç and Burcu, 2014; TUIK, 2013). Milk often comes to mind when goat or goat farming is mentioned. However, the goats are mostly used for their meat. This is primarily due to the fact that most goat farmers are mainly from villages in mountainous and forested areas where they implement traditional farming, and the farmers do not have the courage, strength or reason to change these traditional methods. Additionally they do not have any financial or moral support, they are unaware or ignorant of any support available to them, and generally there is inadequate support given to agriculture, especially in small ruminant farming in Turkey. Often the farmers would add some of the born and surviving kids to the rest of the herd. The remaining goats are sold around 3-4 months old in Turkey's western regions and as adults towards the eastern regions (Ataç and Burcu, 2014).

Most studies on hair goats have been on the cross breeding of the goats out of their natural habitats and at intensive enterprises. As hair goats are the dominant goat breed in Turkey, great variations can be observed in its outer features even in the same herd (Ataç and Burcu, 2014). The technical specifications of businesses in Turkey raising goats are summarized as follows (Kaymakçı and Engindeniz, 2012; Ataç and Burcu, 2014). Canonical correlation analysis is a multivariate technique that generalization of multiple regression analysis. This analysis describes the relationship between two variable sets by calculating the linear combinations which are maximally correlated (Tabachnick and Fidel, 2001). It was used to identify the combination of variables that best separate the two genetic groups. This technique has gained acceptance in various scientific fields such as psychology, social science, animal science, ecology, education etc. In goat breeding however, there are a few studies (Keskin *et al.*, 2005; Çankaya and Kayaalp, 2007) that canonical correlation analysis was applied. Keskin *et al.* (2005) were studied the relationships between some characters of Akkeçi kids. They investigated the pre-slaughtering and post-slaughtering by using canonical correlation analysis. Seven pre-slaughtering characters (slaughter weight, body length, wither height, heart girth depth, heart girth width, heart girth circumference, leg circumference) constituted the X variable set while eight post-slaughtering characters (head weight, feet weight, skin weight, omental and mesenteric fat weight, weights of heart, lung, and liver, spleen weight, hot carcass weight, and cold carcass weight) constituted the Y variable set. The correlation between the first canonical variable pair was found as 0.962. Çankaya and Kayaalp (2007) were applied to canonical correlation analysis to estimate the relationship between eight different morphologic characters (X set – height at withers, body length, chest width, chest girth, chest depth, front, middle and hind rump width and the live weights at three different periods (Y set – birth weight, weaning weight and weight at sixth month) from 86 kids of German Fawn x Hair Crossbred at Çukurova University. They estimated significant canonical correlation coefficient as 0.931 between the first pair of canonical variables. In this study, relationships among the herd, year of birth, birth type, sex, weight at birth, weight at thirty day of age and weight at weaning age effects of Turkish Hair Goats were investigated by canonical correlation analysis. For this purpose, the data obtained from the farms cultivated under the few semi-intensive and most extensive conditions, without intervention in growing conditions, were evaluated by canonical correlation analysis.

## Material and Methods

### Material

The material of this study consist of 1020 male and 1011 female Hair goat kids which were born in the period 2013 until 2016 in Aegean region of Turkey, Izmir-Karaburun. The herd, year of birth, birth type and sex are analyzed as first set of variables (X); weight at birth, weight at thirty day of age and weight at weaning age effects are analyzed as second set of variables (Y) which are illustrated as shown:  $Y_1$  is weight at birth,  $Y_2$  is weight at thirty day of age,  $Y_3$  is weight at weaning age,  $X_1$  is herd,  $X_2$  is year of birth,  $X_3$  is birth type and  $X_4$  is sex.

### Method

Canonical correlation analysis linear combinations of the variables in two sets of variables. Therefore, useful for predictive or comparative purposes the canonical variates representing the optimal linear combinations of dependent and independent variables and the canonical correlation showing the relationship between them are results of interest (Hair *et al.*, 1998).  $W_m$  and  $V_m$  are canonical variates are defined as below:

$$W_m = a_{m1}X_1 + a_{m2}X_2 + \dots + a_{mp}X_p$$

$$V_m = b_{m1}Y_1 + b_{m2}Y_2 + \dots + b_{mq}Y_q$$

The canonical correlation ( $C_m$ ) is the correlation between  $W_m$  and  $V_m$ . Canonical roots or eigenvalues represents the amount of variance in one canonical variate accounted for by the other canonical variate (Hair *et al.*, 1998). When the canonical correlation is maximum the canonical coefficients ( $a_{m1}, a_{m2}, \dots, a_{mp}$  and  $b_{m1}, b_{m2}, \dots, b_{mq}$ ) were estimated. The maximization technique as follows: Let the first group of  $p$  variables is represented by the random vector,  $X_{(p \times 1)}$ , and the second group of  $q$  variables is represented by the random vector,  $Y_{(q \times 1)}$ . For the random vectors  $X$  and  $Y$ , population mean and (co)variances would be as:

$$E(X) = \mu \quad E(Y) = \mu \quad Cov(X) = \Sigma_{11} \quad Cov(Y) = \Sigma_{22} \quad Cov(X, Y) = \Sigma_{12} = \Sigma'_{21}$$

Furthermore,  $X$  and  $Y$  random vectors and (co)variance matrices can be written as follows:

$$\begin{bmatrix} X_{p \times 1} \\ Y_{q \times 1} \end{bmatrix} = \begin{bmatrix} X_1 \\ X_2 \\ \vdots \\ X_p \\ Y_1 \\ Y_2 \\ \vdots \\ Y_q \end{bmatrix}; \quad \Sigma = \begin{bmatrix} \Sigma_{11_{p \times p}} & \Sigma_{12_{p \times q}} \\ \Sigma_{21_{q \times p}} & \Sigma_{22_{q \times q}} \end{bmatrix}$$

So that, a linear combination of the components of  $X$  and the components of  $Y$  would be  $W = a'X$  and  $V = b'Y$ , respectively. Then,  $W$  and  $V$  have expectation of zero and (co)variances as:

$$\begin{aligned} \text{var}(W) &= a' Cov(X) a = a' \Sigma_{11} a & \text{var}(V) &= b' Cov(Y) b = b' \Sigma_{22} b \\ \text{cov}(W, V) &= a' Cov(X, Y) b = a' \Sigma_{12} b \end{aligned}$$

For testing the statistical significance of the canonical correlations used the Wilks' lambda test statistic is used.

Large canonical correlation always does not mean that there is a powerful relationship between the two sets of the traits. Because canonical correlation maximizes the correlation between linear combination of variables in two groups and not maximizes the amount of variances accounted for in one set of variables by the other set of variables. Therefore, it is suggested to calculate the redundancy measure for each canonical correlation to determine how much of the variance in one set of variables is accounted for by the other set of variables (Sharma, 1996).

The canonical correlation analysis was performed by means of PROC CANCORR procedure of SAS 9.0 software (2002).

### Results and Discussion

The correlations between the variables were analyzed by canonical correlation analysis. These correlations give us the chance to estimate the correlation between two sets of variables including more than one trait in each at the same time. Because, the number of canonical correlations that needs to be interpreted is minimum number of traits within  $X$  or  $Y$  set. Estimated canonical correlations between the pairs of canonical variates were found 0.33, 0.27 and 0.088 and to be significant ( $P < 0.01$ ) from likelihood ratio test given in Table 1. Significance of likelihood ratio test is also equal to the significance of Wilks'  $\Lambda$ .

Table 1. Canonical correlations between two sets of variables, eigen values, likelihood ratios and their probabilities

	Canonical correlation	Squared canonical correlation	Degrees of freedom	Eigen values	Likelihood ratio	Probability Pr>F
1	0.33	0.11	12	0.12	0.82	<0.0001
2	0.27	0.07	6	0.08	0.92	<0.0001
3	0.088	0.008	2	0.008	0.99	0.0004

In present study, the canonical correlations between all pair of canonical variates were found to be significant from the likelihood ratio test in table 1. On the other hand, Tatar and Elçin (2002) and Çankaya and Kayaalp (2007) found only the first coefficient significant among all estimated cononical correlation coefficients ( $P < 0.001$ ). Estimated canonical correlation was the highest (0.33) for the first pair of canonical variates ( $W_1$  and  $V_1$ ) but the smallest (0.088) for the third pair of variates ( $W_3$  and  $V_3$ ). It seems that herd, year of birth, birth type and sex are correlated with weight at birth, weight at thirty day and weight at weaning age.

The coefficients of canonical variates obtained from the raw data are given in Table 2. Magnitudes of these weights represent their relative contributions to the related variate.

Table 2. Canonical coefficients of variates

	W1	W2	W3		V1	V2	V3
Herd	0.418	0.384	0.409	Weight at birth	-0.00005	-0.0004	-0.00011
Year of birth	-0.949	-0.370	-0.061	Weight at thirty day	0.00009	0.00004	0.00017
Birth type	-0.794	0.478	2.564	Weight at weaning age	0.0011	0.00002	-0.0008
Sex	-0.723	1.720	-0.716				

Because of the coefficients of canonical equations are not unique, they should be scaled that the resulting canonical variates have a mean of zero and variance of one. Standardized canonical coefficients or canonical weights for the  $X$  and  $Y$  variables are given in Table 3. Magnitude of these weights represents their relative contribution to the related variate

Table 3. Standardized canonical coefficients of variates

	W <sub>1</sub>	W <sub>2</sub>	W <sub>3</sub>		V <sub>1</sub>	V <sub>2</sub>	V <sub>3</sub>
Herd	0.465	0.427	0.456	Weight at birth	-0.0120	-1.0641	-0.2920
Year of birth	-0.893	-0.348	-0.0580	Weight at thirty day	0.5350	0.2192	0.9426
Birth type	-0.259	0.156	0.8372	Weight at weaning age	0.8112	0.1489	-0.5700
Sex	-0.361	0.860	-0.3583				

There is high positive standardized canonical coefficients for weight at thirty day at  $V_3$  (0.9426). It follows by weight at weaning age (0.8112) and weight at thirty day at  $V_1$ .

Table 4. Correlations between the variables and related canonical variates (canonical loadings)

	W1	W2	W3		V1	V2	V3
Herd	0.2120	0.3284	0.4475	Weight at birth	0.2398	-0.9668	0.0887
Year of birth	-0.7702	-0.2334	0.1249	Weight at thirty day	0.5876	-0.2203	0.7786
Birth type	-0.3224	0.1781	0.8216	Weight at weaning age	0.8488	0.1310	-0.5122
Sex	-0.3587	0.8722	-0.3213				

Table 5. Correlations between the variables and the other set of canonical variates (canonical cross loadings)

	W <sub>1</sub>	W <sub>2</sub>	W <sub>3</sub>		V <sub>1</sub>	V <sub>2</sub>	V <sub>3</sub>
Herd	0.0700	0.0891	0.0396	Weight at birth	0.0791	-0.2624	0.0078
Year of birth	-0.2542	-0.0633	0.0111	Weight at thirty day	0.1939	-0.0598	0.0689
Birth type	-0.1064	0.0483	0.0727	Weight at weaning age	0.2801	0.0356	-0.0453
Sex	-0.1184	0.2367	-0.0284				

The loadings are shown in Table 5. The loadings for the weight at birth, weight at thirty day and weight at weaning age suggest that weight at weaning age is the most influential variable in forming V<sub>1</sub> compared to weight at birth and weight at thirty day. On the other hand, for the second pair of canonical variate V<sub>2</sub>, weight at birth and weight at thirty day are about equally negatively influential in forming V<sub>2</sub>. For the last canonical variate V<sub>3</sub>, weight at weaning age has negatively impact in forming V<sub>3</sub>. When the investigate he loadings for herd, year of birth, birth type and sex, it seems that only herd has positively and the others have about equally influential in forming W<sub>1</sub> (Table 5). While the loadings ignore the presence of the other variables, canonical coefficients give the contribution of each variable in the presence of all the other variables. Therefore, canonical coefficients are important to determine the importance of each variable in canonical variates. However, loadings provide substantive meaning for the canonical variates (Akbaş and Takma, 2005).

### Conclusions

It can be concluded that canonical correlation analysis has been able to determine the relationships between the variable sets and it is an appropriate method to obtained the correlated patterns of traits in Hair goats.

### References

- Akbaş Y., Takma Ç. (2005). Canonical correlation analysis for studying the relationship between egg production traits and body weight, egg weight and age at sexual maturity in layers. *Czech Journal of Animal Science*. 5074: 163–168.
- Atac F.E., Burcu H. (2014). The importance of Hair Goats in Turkey, *Journal of Agricultural Science and Technology A* 4: 364-369 doi:10.17265/1939-1250/2014.04A.01.
- Çankaya S., Kayaalp G.T. (2007). Estimation of relationship between live weights and some body measurements in german farm x hair crossbred by canonical correlation analysis. *Hayvansal Üretim* 48/2 : 27-32.
- Hair J.F.Jr., Anderson R.E., Tatham R.L., Black W.C. (1998). *Multivariate data analysis*, (5th Edition). Upper Saddle River, NJ: Prentice Hall.
- Kaymakçı M., Engindeniz S. (2012). Turkey and world goat breeding, in: M. Kaymakci (Ed.), *Goat Breeding*, Izmir, pp. 3-15.
- Keskin M., Kurtoglu S., Kendirci M., Atabek M.E., Yazici C. (2005). Homeostasis model assessment is more reliable than the fasting glucose/insulin ratio and quantitative insulin sensitivity check index for assessing insulin resistance among obese children and adolescents. *Pediatrics*. 115 / 4 : 500–503.
- SAS Institute. (2002). *SAS User's Guide: Statistics*. Version 9.0. SAS Inst. Inc., Cary, NC..
- Sharma S. (1996). *Applied multivariate techniques*. United States: John Wiley & Sons.
- Tabachnick B.G., Fidell L.S. (2001). *Using multivariate statistics*. Boston: Allyn and Bacon.

- Tatar A.M., Elçin A. (2002). Ile de France x Akkaraman (G1) crossbred male lambs, feeding period of dairy intake and live weight and body size of the relationship between canonical correlation method investigation. *Journal of Agricultural Sciences*, 8: 67-72.
- TUIK, Turkey Statistics Association (2013). <http://rapor.tuik.gov.tr/> (accessed Sep. 13, 2013).

## EFFECTS OF DIFFERENT GROWING PARAMETERS ON THE GROWTH PARAMETERS OF THE YOUNG GILTHEAD SEA BREAM (*SPARUS AURATA*)

Sema ÖZTÜRK<sup>1\*</sup>, Deniz ÇOBAN<sup>1</sup>, Birsen KIRIM<sup>1</sup>, Mehmet GÜLER<sup>1</sup>, Ebru YILMAZ<sup>1</sup>, Cengiz ÖNDER<sup>2</sup>, Serkan İLGAZ<sup>2</sup>

<sup>1</sup>Department of Aquaculture Engineering, Adnan Menderes University, Faculty of Agriculture, Turkey

<sup>2</sup>Kilic Seafood Company, Mugla, Turkey

\*Corresponding author: sema.ozturk@adu.edu.tr

### Abstract

The gilthead sea bream is a large demanding marine fish which is popular in Turkey and other Mediterranean countries. After the European sea bass, it is the second most cultured species in Turkey with a well-designed protocol of growing. Nevertheless, as a result of high product necessities, high stock density and feeding with high energy dense diets, fish liver accumulates lipid droplets that can cause fatty liver. On the other hand skeleton deformations are very significant biological problem in finfish hatcheries affected by various biotic and abiotic factors and affect 5-20% on average of the young fish. In this sense, in this study, the researchers compared the effects of different tank shapes (38 tons raceway and 130 tons cylindrical) and two differently formulated diets on the liver histology and external morphology of the gilthead sea bream with two repetitions. At the beginning, the fish were separated into two groups; the Group A (38 t raceway and 130 t cylindrical) was lasted for 27 days and comprised 2.149,487 fish and the Group B (38 t raceway and 130 t cylindrical) lasted for 29 days and comprised 2.193,689 fish. At the end of the study, there was no statistically difference of biomass between the two groups ( $p>0.05$ ). The Group A was weighed 3,474 kg and the Group B weighed 3,511 kg. Survival rates were 93% for the both groups. The last weight of the Group A was 1,733 gr and the Group B was 1,709 ( $p>0.05$ ). FCR were calculated 1.13 and 1.05; SGR were 3.47 and 3.91, skeleton deformations were 0.19% and 0.18% at the beginning of the study, 0.14% and 0.13% at the end of the study, respectively. The deformations were mostly found on the vertebrae, less on head, jaw and mouth. In histological results, during the study in the Group A all fish showed moderately fatty liver and in the Group B 50% of the livers were moderately fatty and rest 50% were fatty.

**Key words:** *Gilthead sea bream, Sparus aurata, Histology, Liver, Growth.*

### Introduction

Gilthead sea bream is one of the major cultured finfish in the Mediterranean area and second most cultured fish after European sea bass in Turkey. However still there are some problems such as fatty internal organs and skeletal deformities in commercially are run gilthead sea bream farms. For satisfying animal protein demand with increasing human population, producers feed their fish with high energy dense diets (Dalay *et al.*, 2013; Shrivastava *et al.*, 2013). High energy demanding feeding with high stock density have been resulted with accumulations of fat in the internal organs and symptoms generally occur at the fish liver (Storch and Juario, 1983; Caballero *et al.*, 1999; 2004), which shows fatty sendrom has been explained with nutritional imbalance, increasing dietary lipid content (Caballero *et al.*, 1999), high protein sources (Shrivastava *et al.*, 2013), an essential fatty acid deficiency (Montero *et*

*al.*, 2001) and the inclusion of vegetable oils (Alexis, 1997; Caballero *et al.*, 2002) in gilthead sea bream. This abnormal accumulation of lipid (triglycerides) in hepatocytes can also affect fish survival (Dalay *et al.*, 2013; Shrivastava *et al.*, 2013). On the other hand, skeleton deformations affect seriously production costs by external morphology, growth and survival rate of fish (Koumoundouros *et al.*, 2002; Fernandez *et al.*, 2008). Beside broodstock and egg quality, some biotic (air bladder formation, some parasites *et.*) and abiotic factors (light, temperature, salinity *et.*) (Koumoundouros *et al.*, 1997; Cobcroft and Battaglione, 2009), also nutritional conditions are very important in bone development especially in larval also young fish period (Mazurais *et al.*, 2009; Tocher, 2010; Boglione *et al.*, 2013). The objectives of this study were effects of different type tank shapes and different formulated diets on deformation and liver fatty syndrom in young gilthead sea bream.

### Material and Methods

Study was conducted in a commercial marine fish farm Muğla/Turkey. It was lasted in 29 days from September to October in 2015 and samples were evaluated in laboratory of Department of Aquaculture Engineering, Adnan Menderes University. Two different shaped tanks were used and two different formulated commercial diets were applied and results were evaluated regarding to effects on fish growth. At the beginning, randomly 100 juvenils put into either 38 tons rectangular raceway or 130 tons cylindrical tanks. Fish was feed with 4-6% of their biomass during the study. Biomass was calculated at the beginning 0,5 kg/m<sup>3</sup> and planned as 4,5 kg/m<sup>3</sup> at the end of the study. Study design was showed in Table 1 and diet contents was in Table 2. Water temperature was stabilized at 24,68±0,41 °C during the study. Other parameters oxygen and pH were calculated as 11,70±1,04 mg/L and pH 7,82±0,15 respectively. At the beginning, every sampling days (every 10 days) and end of the study 50 samples were obtained from tanks randomly. Samples was measured for total length, total weight, dry weight, visceral organs weight, FCR and specific growth rate (SGR).

Table 1. Study design

Diet A	Diet B
38 tons raceway (2 tanks)	38 tons raceway (2 tanks)
130 tons cylindrical (2 tanks)	130 tons cylindrical (2 tanks)

\*Source: Author s' elaboration based on the obtained results

Table 2. Chemical composition of the experimental diets (g/100g dry matter)

Extruder Granule Diet	Diet A	Diet B
Crude protein	58	62
Lipid	9	14
Ash	10	9
Cellulose	1,4	0,5
Phosphor	1,7	1,5

\*Source: Author s' elaboration based on the obtained results

For observation skeleton deformations, fish were sampled at the beginning and at the end of study. Samples were anaesthetised (Ethylene Glycol Monophyl Ether, Merck, 0.2-0.5 ml/lt) and taken photos (Nikon Coolpix 5000, Japan) on the left side, then observed under light microscope. Total length was calculated from these photos by computer programme (TpsDig/Ver. 1.37) (Çoban *et al.*, 2007).

For the histologic sampling, at the beginning, every sampling days (every 10 days) and end of the study 50 samples were obtained and put into 10% formalin solution. As represent visceral



organs, liver and spleen were cut with cryostat (Leica CM 1100) at 5-6  $\mu$ . After Hematoxylin and Eosin staining slides were examined by light microscope (Novex Cmax DC 5000). Degree of fatty liver was evaluated visually under light microscope and took micro photos with micro camera (Culling *et al.*, 1985; Timur, 2013).

### Results and Discussion

For optimal growth and minimum costs on final fish, fish meal percent, lipid content in diet and their quality are critically important in marine fish culture (Andrades *et al.*, 1996; Caballero *et al.*, 1999; Boglione *et al.*, 2001; Caballero *et al.*, 2002). Also, liver is an important indicator in fish feeding studies regarding to histological structure (Caballero *et al.*, 1999; 2004). These feeding studies showed effects of different lipid sources (vegetable and fish oils) (Tucker *et al.*, 1997, Benedito-Pallos *et al.*, 2008, Caballero *et al.*, 2002, Wassef *et al.*, 2007), different lipid percent and different quality fish meal (Caballero *et al.*, 1999) on fish growth and liver histology. Different vegetable oils (soybean, menhaden, rapeseed, palm and olive) and fish oils (capelin and anchovy) can be used as an alternative lipid sources (Tucker *et al.*, 1997, (Caballero *et al.*, 2002). When vegetable oils were used partially 33, 66% (Benedito-Pallos *et al.*, 2008) and 60% (Wassef *et al.*, 2007), fish showed accumulation of lipid droplets in cytoplasm of hepatocytes in different amount which shifted cytoplasmic organelles and nuclei to cell wall by lipid droplets (Wassef *et al.*, 2007). When studied different fish lipid content (15, 22, 27%), liver showed same nuclei displacement in 22 and 27% lipid content (Caballero *et al.*, 1999). Also, when 50% of total oil was switched with soybean oil results showed that SGR became lower from  $1,81 \pm 0,05$  to  $1,72 \pm 0,13$ , FCR changed from  $0,726 \pm 0,03$  to  $0,723 \pm 0,02$  (Caballero *et al.*, 2002).

In present study, fish was in Group A and B, liver similar to prior studies (Benedito-Pallos *et al.*, 2008; Caballero *et al.*, 1999, 2002; Wassef *et al.*, 2007) nuclei was shifted to cell wall by lipid droplets, but also in Group B 50% of the livers were similar Group A, others had bigger lipid droplets than Group A for both cylindrical and raceway tanks. Spleens had no any inflammation findings. In spleens, major cells lymphocytes and erythrocytes showed normal morphology. According to histological results, there was more fatty livers in Group B.

Table 3. Growth parameters during experiment

Parameters	Group A	Group B
<i>Beginning of Experiment</i>		
Total Fish (number)	2.149,487	2.193,689
Biomass (kg)	594	612
Weight (g.fish-1)	0,276	0,278
Length (mm. fish-1)	3,094	5,185
<i>End of the Experiment</i>		
Total Fish (number)	2.004,572	2.053,530
Biomass (kg)	3,474	3,511
Weight (g.fish-1)	1,733	1,709
Length (mm. fish-1)	3,094	6,503
Survive (%)	93	93
FCR	1,13	1,05
SGR (%)	3,47	3,91

\*Source: Author's elaboration based on the obtained results

In culture systems, there are plenty of tank types depend on voice hydrodynamic, water quality and other biological, economic and ergonomic principles (Cripps and Poxton, 1992;

Planas and Cunha, 1999; Bařaran et al., 2004). In some studies, for turbot, tanks were shallow, circular and had light gradient (Cripps and Poxton, 1992), while for gilthead sea bream larvae, tanks were 5-15 tons circular tanks (Bařaran et al., 2004) were used successfully. Depend on results of present study both circular and raceway tanks worked with similar performance.

Morphometrically growth is effected by culture type, water parameters, feeding diversity, growth performance and specific morphometry in commercial fish farms (Wiegand et al., 1989; Andrades et al., 1996; Boglione et al., 2001). Morphometric deformities may depend on high stock density, insufficient feeding (Kanazawa, 1985) and some genetical factors (Aulstand and Kittelsen, 1971). Morpho anatomical anomalies responsible for 5% of total product of fish farms and final product were affected badly (Marino et al., 1993; oban et al., 2007). According to Boglione et al., (2001), gilthead sea bream showed hemal and caudal region deformations particularly and Andrades et al., (1996) showed that adult gilthead sea bream mostly showed vertebral deformities. Similar to prior studies, our results showed deformations mostly found on the vertebrae, less on head, jaw and mouth. In this study, according to deformations results at the beginning and at the end of the study (Table 4), different tank shapes and diets had no effect differently for young gilthead sea bream in culture conditions.

Based on Table 3 there was no statistically difference of biomass and last weight between the two groups ( $p>0.05$ ) at the end of the study. Survival rates were 93% for the both groups. According to these results, there was no important difference between different tank shapes and diets with regard to biomass, weight and survival parameters.

At 78 DAH, visseral organs weight was  $0,098\pm 0,029$  mgr and dry weight was  $0,085\pm 0,043$  mgr for both groups. End of the study at 105 DAH for Group A, visseral organs weight  $0,351\pm 0,098$  mg, dry weight  $0,505\pm 0,156$  mgr, while at 107 DAH for Group B, visseral organs weight  $0,575\pm 0,156$  mgr and dry weight  $1,083\pm 0,403$  mgr. According to these results in Group B both visseral organ and dry weight were more higher. When compared two groups according to SGR and FCR (Table 3), Group B had more efficiently results for both different tank shapes and different diets.

Table 4. Skeleton deformations

		Fish number	Vertebral deformities		Head, jaw, mouth		Total deformation rate (%)
			Number	Rate (%)	Number	Rate (%)	
Diet A	Beginnig	1348	205	0,15	48	0,04	0,19
	Final	617	43	0,07	43	0,07	0,14
Diet B	Beginning	1017	160	0,16	22	0,02	0,18
	Final	620	59	0,10	23	0,04	0,13

\*Source: Author s' elaboration based on the obtained results

### Conclusions

Mediterranean aquaculture is a enormous productive sector depends on European sea bass and gilthead sea bream. While this sector works high productively with well designed culture protocols still there is some bottlenecks like skeleton deformations, some illness, fatty visceral organs et. Thus, scientific researches are valuable to better fish culture management. For this reasons, in this study different tank shapes and different formulated diets were researched to see their effects on fish development. Depend on the results, SGR, FCR and dry

weight were better in Group B and in histological results there was bigger lipid droplets in liver hepatocytes in Group B for both different tank shapes and different diets. Also there was no mortality by fatty liver syndrome. According to all these results we concluded that raceway or cylindrical tank shapes had no different effects importantly on young gilthead sea bream with respect to biomass, weight, survival parameters and deformations. Also according to different formulated diets, there was no difference between different crude protein (58 and 62%) and different lipid (9 and 14%) content on fish growth. There was only Group B had a better SGR and FCR may these results come from more qualified egg and larvae were used at the beginning in Group B. It can be suggested that these results will be helpful in the future in commercial gilthead sea bream farms.

### Acknowledgement

This study was supported by the Scientific Research Project Department of Adnan Menderes University, Project Code: ZRF 15038 (2016), Animal Testing Local Ethic Council Number: 64583101/2014/110 (2014/ VII. Session)

### References

- Alexis MN. (1997). Fish meal and fish oil replacers in mediterranean marine fish diets. *Cahiers Options Mediterraneennes* Vol. 22, pp. 183-204.
- Andrades J.A., Becerra J., Ferrhdez-Llebrez P. (1996). Skeletal deformities in larval, juvenile and adult stages of cultured gilthead sea bream (*Sparus aurata* L.) *Aquaculture*, vol. 141, pp. 1-11.
- Aulstad D., Kittelsen A. (1971). Abnormal body curvatures of rainbow trout *Salmo gairdneri* inbred fry. *J. Fish. Res. Board Canada*, vol. 28 (12), pp. 1918–1920.
- Başaran F., Muhtaroglu G., Ilgaz S., Boyacıoğlu H. (2004). The effect of tank volumes on survival of gilthead seabream (*Sparus aurata* L., 1758) from hatching to the first grading in intensive culture systems E.U. *Journal of Fisheries & Aquatic Sciences*, vol. 21 (1-2), pp. 69 – 72.
- Benedito-Palos L., Navarro J.C., Sitja `Bobadilla A., Bell J.G., Kaushik S., Pe ´rez-Sa ´nchez J. (2008). High levels of vegetable oils in plant protein-rich diets fed to gilthead sea bream (*Sparus aurata* L.): growth performance, muscle fatty acid profiles and histological alterations of target tissues *British Journal of Nutrition*, vol, 100, pp. 992–1003.
- Boglione C., Gagliardi F., Scardi M., Cataudella S. (2001). Skeletal descriptors and quality assessment in larvae and post-larvae of wild-cought and hatchery-reared gilthead sea bream (*Sparus aurata* L. 1758). *Aquaculture*, vol. 192, pp. 1–22.
- Boglione C., Gisbert E., Gavaia P., Witten P.E., Moren M., Fontagne S., Koumoundouros G. (2013). Skeletal anomalies in reared European fish larvae and juveniles. Part 2: main typologies, occurrences and causative factors. *Aquaculture*, vol. 5 (1), pp. 121–167.
- Caballero M.J., Lo´pez-Calero G., Socorro J., Roo F.J., Izquierdo M.S., Fernandez A.J. (1999). Combined effect of lipid level and fish meal quality on liver histology of gilthead sea bream (*Sparus aurata*). *Aquaculture*. Vol. 179, pp. 277–290.
- Caballero M.J., Obach A., Rosenlund G., Montero D., Gisvold M., Izquierdo M.S. (2002). Impact of different dietary lipid sources on growth, lipid digestibility, tissue fatty acid composition and histology of rainbow trout, *Oncorhynchus mykiss*, *Aquaculture*, vol. 214, pp. 253–271.
- Caballero M.J., Izquierdo M.S., Kjrsvik E., Fernandez A.J., Rosenlund G. (2004). Histological alterations in the liver of sea bream, *Sparus aurata* L., caused by short- or

- long-term feeding with vegetable oils. Recovery of normal morphology after feeding fish oil as the sole lipid source. *Journal of Fish Diseases*, vol. 27, pp. 531–541.
- Cobcroft J.M., Battaglione S.C. (2009). Jaw malformation in striped trumpeter *Latris lineata* larvae linked to walling behavior and tank colour. *Aquaculture*, vol. 289, pp. 274-282.
- Cripps J.S., Poxton M.G. (1992). A review of the design and performance of tanks relevant to flatfish culture. *Aquacultural Engineering*, vol. 11, pp. 71-91.
- Culling A.F., Allison T.R., Barr T.W. (1985). *Cellular pathology technique*. 4th Ed. London: Mid-County Press; pp. 1-5.
- Çoban D., Saka Ş., Fırat K., Kamacı H.O., Suzer C. (2007). Yetiştiricilik ortamında çipura (*Sparus aurata*) larvalarında meydana gelen iskelet deformasyonları. *Fırat Üniv. Fen ve Müh. Bil. Dergisi Science and Eng. J of Fırat Univ.* Vol. 19 (3), pp. 309-316.
- Fernandez I., Hontoria F., Ortiz-Delgado J.B., Kotzamanis Y., Estévez A., Zambonino-Infante J.L., Gisbert E. (2008). Larval performance and skeletal deformities in farmed gilthead sea bream (*Sparus aurata*) fed with graded levels of Vitamin A enriched rotifers (*Brachionus plicatilis*). *Aquaculture*, vol. 283 (1-4), pp. 102-115.
- Kanazawa A. (1985). Essential fatty acid and lipid requirement of fish. *Nutrition and Feeding in Fish*. Academic Press, Fondon, pp. 281-298.
- Koumoundouros G., Gagliardi F., Divanach P., Boglione C., Cataudella S., Kentouri M. (1997). Normal and abnormal osteological development of caudal fin in *Sparus aurata* L fry. *Aquaculture*, vol. 149, pp. 215–226.
- Koumoundouros G., Sfakianakis D.G., Divanach P., Kentouri M. (2002). Effect of temperature on swimming performance of sea bass juveniles. *Journal of Fish Biology*, vol. 60, pp. 923–932.
- Mazurais D., Glynatsi N., Darias M.J., Christodouloupoulou S., Cahu C.L., Zambonino-Infante J.L., Koumoundouros G. (2009). Optimal levels of dietary vitamin A for reduced deformity incidence during development of European sea bass larvae (*Dicentrarchus labrax*) depend on malformation type. *Aquaculture*, vol. 294, pp. 262–270.
- Marino G., Boglione C., Bertolini B., Rossi A., Ferreri F., Cataudella S. (1993). Observations on the development and anomalies in the appendicular skeleton of sea bass, *D. labrax* L. 1758, larvae and juveniles. *Aquacult. Fish. Manage.* Vol. 24, pp. 445-456.
- Montero D., Robaina L.E., Socorro J., Vergara J.M., Tort L., Izquierdo M.S. (2001). Alteration of liver and muscle fatty acid composition in gilthead sea bream (*Sparus aurata*) juveniles held at high stocking density and fed an essential fatty acid deficient diet. *Fish Physiology and Biochemistry*, vol. 24, pp. 63–72
- Shrivastava P., Yadav A.K., Lakra W.S., Chowdhary S., Dayal R., Raizada S., Srivastava P.P. (2013). Histological alterations in the hepatic tissue of Asian catfish, fed with different dietary fats *Clarias batrachus*, *Asian J. Exp. Biol. Sci.*, vol. 4(4), pp. 575-580.
- Storch V., Stahlin W., Juario J.V. (1983). Effect of different diets on the ultrastructure of hepatocytes of *Chanos chanos* fry, Chanidae: Teleostei: An electron microscopic and morphometric analysis. *Mar. Biol.* Vol, 74, pp. 101–104.
- Timur G. (2013). *Balık histolojisi ve embriyolojisi*. İstanbul Üniversitesi, pp. 6-8.
- Tucker J.W., Llellis W.A., Vermeer G.K., Roberts D.E., Woodward P.N. (1997). The effects of experimental started diets with different levels of soybean or menhaden oil on red drum (*Sciaenops ocellatus*). *Aquaculture*, vol. 149, pp. 323–339.
- Tocher D.R. (2010). Fatty acid requirements in ontogeny of marine and freshwater fish. *Aquaculture Research*, vol, 41, pp. 717–732.

- Wassef E.A., Wahby O.M., Sakr E.M. (2007). Effect of dietary vegetable oils on health and liver histology of gilthead sea bream (*Sparus aurata*) growers Aquaculture Research. Vol. 38, pp. 852-861.
- Wiegand M.D., Hataley J.M., Kitchen C., Buchanan F. (1989). Induction of developmental abnormalities in larval goldfish (*Carassius auratus*) under cool incubation condition. J. Fish Biol. Vol, 35, pp. 85-95.

## BIOCHEMICAL PROFILE OF OULED DJELLAL EWES WITH SUBCLINICAL PREGNANCY TOXEMIA

Kahramen DEGHTOUCHE<sup>1\*</sup>, Maroua AISSAOUI<sup>1</sup>, Majid TLIDJANE<sup>2</sup>, MEZIANE<sup>2</sup>

<sup>1</sup>DEDSPAZA laboratory. Department of Agronomic Sciences. Biskra university. Algeria

<sup>2</sup>ESPA laboratory. Department of veterinary Sciences. Batna university. Algeria

\*Corresponding author: dkahramen@yahoo.com.ph

### Abstract

Sheep farming in arid and semi-arid regions of Algeria faces large fluctuations in the availability of fodder. This deficiency is particularly burdensome for pregnant ewes whose needs are the maximum. This situation will lead to the appearance of metabolic disorders such as subclinical pregnancy toxemia. The present study was conducted to determine the biochemical profile of ewes in late pregnancy with this metabolic disorder. Blood samples were obtained from eighty ewes in late pregnancy (2 to 4 weeks of lambing), aged 3 to 5 years, clinically healthy, multiparous, from eight farms located in an arid area of South Eastern Algeria. Serum concentrations of glucose, cholesterol, triglycerides, and beta-hydroxybutyrate, were determined using specific commercial kits. Ewes were classified as having subclinical pregnancy toxemia or as controls on the basis of BHB results. Biochemical results were compared between the 2 groups using the statistical software Epi Info (version 3.4.3. November 8, 2007), Differences were considered significant when  $p < 0.05$ . The metabolic profile of sick animals was characterized by significantly lower ( $p < 0.01$ ) serum glucose and triglycerides, and significantly elevated ( $p < 0.05$ ) rates of cholesterol, and beta-hydroxybutyrate. Pregnancy Toxemia is a major problem in the sheep industry and early dosage of ketone bodies B-hydroxybutyrate in the six weeks before lambing prevent and reduce economic losses caused by this disease.

**Key words:** *biochemical profile, Ouled Djellal sheep, subclinical pregnancy toxemia, late gestation*

### Introduction

The sheep is a gregarious and rustic animal. It adapts to many climatic conditions. It is found in almost all the latitudes of the globe. It makes it possible to develop pastures that are difficult to access for other species or for agricultural machines. Due to the current economic imperatives, the breeder demands more and more performance from his herd. The sheep has therefore not escaped the modernization and the intensification of its breeding. This search for maximum profitability in the sheep sector has led to new diseases linked directly to the breeding conditions. As a result, we are confronted with diseases whose origin is no longer an infectious agent but a disorder of the metabolism such as the pregnancy toxemia. Pregnancy toxemia is a metabolic disease of ewes, occurring during late pregnancy and with a high mortality rate (Caldeira and al., 2007). It occurs independently of age or breed of animals, but ewes carrying twin or triplet fetuses are more prone to develop the disorder (Firat and Ozpinar, 2002; Sargison, 2007). Poor nutrition of ewes, especially during late pregnancy, also predisposes to the disease (Liamadis and Mills, 2007). This study was performed to evaluate serum biochemical findings in Ouled Djellal ewes in late pregnancy with subclinical pregnancy toxemia.

## Materials and methods

### Animals

This study concerned Ouled Djellal ewes, an excellent meat breed adapted to arid area, which is dominant in the region. Pastoralists practice extensive and semi-extensive breeding. Animals are left outdoors during the day during most of the year. In winter, they are kept completely in the sheepfold only for a limited period, depending on the weather conditions. Group antiparasitic treatments, without distinction between young and adult, are generally carried out in early spring and autumn. The Ouled Djellal breed is seasoned; the rams are permanently in the herds and the fight is free. The lambing takes place mostly in the autumn but begin in September. Young animals and adults use the same pasture.

The livestock concerned by the present study is composed of 80 clinically healthy Ouled Djellal ewes, in the last trimester of pregnancy from 08 herds in an arid area of South Eastern Algeria, multiparous and primiparous, aged between 3 and 5 years.

The ewes were divided into two groups according to the results achieved in the serum BHB.

### Blood samples

Blood samples were taken by puncturing the jugular vein at 7 am before feeding in sterile heparinized tubes and then centrifuged at 1500 g for 10 minutes at 4 ° C. The corresponding plasmas were stored at -20 ° C. until analyzed. The assays were based on biological constants (glucose, cholesterol, triglycerides, and BHB). The serum BHB concentration is determined by the enzymatic method with a commercial kit, following the manufacturer's instructions. The serum concentration of  $\beta$ -hydroxybutyrate is used as a reference method for determining subclinical ketosis (Schultz and Myers, 1959, Herdt and al., 1981, Andersson and Lundstrom, 1984).

## Results and discussion

Table 01: Blood metabolites concentrations in ewes having subclinical pregnancy toxemia and controls group

	<b>Ketotic ewes</b> n=30	<b>Control group</b> n=50
<b>BHB (mmol/l)</b>	0.91±0.25*	0.49±0.15
<b>Glucose (g/l)</b>	0.30±0.21*	0.45±0.32**
<b>Cholesterol (g/l)</b>	0.70±0.23*	0.48 ±0.19*
<b>Triglycerid (g/l)</b>	0.33±0.23	0.40±0.29

\*p<0.05    \*\*p<0.01

The results show that thirty sheep were suffering from subclinical pregnancy toxemia (BHB > 0.86 mmol / L), and fifty ewes constituted the control group (BHB ≤ 0.86 mmol / L).

The determination of blood glucose and serum level of B-hydroxybutyrate is very important for the early diagnosis of pregnancy toxemia as reported by Bickhardt and König (1985), because hypoglycemia and hypercetonemia are the biochemical symptoms characteristic of the disease (Firat and Özpınar, 2002). Furthermore, it has been suggested that blood ketone body levels in ruminants can be considered as an indicator of their energy status (Bowden, 1971). During the final 6 weeks of pregnancy, plasma concentrations of BHB less than 0.8, 0.8–1.6 and greater than 1.6 mmol/l represent adequately nourished, moderately undernourished and severely undernourished ewes, respectively .

In late pregnancy, fetal growth is rapid and the demands for energy are markedly increased. Although glucose is the primary metabolic fuel and is absolutely essential for vital organ function, fetal growth and milk production, it is an insensitive measure of energy status, as it is subject to tight homeostatic regulation.

From the results mentioned in Table 01 we note that glucose and triglyceride levels in ketotic pregnant ewes are significantly ( $p < 0.05$ ) lower than those obtained in the controls at the same physiological stage, however for cholesterol levels the positive subjects have the highest values.

Several researchers reported higher blood cholesterol and triglyceride concentrations during late pregnancy in sheep. (Singh and al., 1996). This increase during the last weeks of pregnancy appears to be related to the energy demands of the fetal-placental unit in pregnant ewes. Another explanation for an increase in the serum cholesterol concentration recorded in the late pregnancy compared to day seven post-partum may be due to insulin. Its response is significantly reduced in ewes during late pregnancy. The diminished response of the target tissue to insulin during late pregnancy predisposes the ewes to an increase in blood cholesterol and lipoprotein concentrations (Schlumbohm and al., 1997; Burtis and Ashwood, 1999).

Our results are in agreement with those of El-Din and El-Sangery (2005), who noted low blood glucose values and corroborated those reported by (Sigurdsson, 1988, Singh et al., 1992, Bickhardt and al., 1993, Scott et al 1995, Van Saun 2000 and Mavrogianni and Brozos 2008), which reported low triglyceride levels in affected ewes compared to controls but were in partial agreement with those found by Kabakci and al . (2003), who noted that triglyceride levels were higher in ewes with pregnancy toxemia, while the blood glucose and cholesterol levels observed by these researchers are still low.

Everts (1990) pointed out that the lowest plasma glucose levels were observed in sheep with ketosis. The same researcher also indicated that severe energy deficiency is not the only cause of ketosis, and that the weak control of glucose homeostasis is a predisposing factor in the onset of this pathology.

In addition, Schlumbohm and Harmeyer (2008) have reported that hypoglycaemia is a symptom that characterizes this metabolic disorder, in fact the hyper ketonemia seen in subjects depresses the serum glucose concentration as described by several authors (Bergman et al., 1963, Kammula, 1976, Radcliffe et al., 1983).

In goat with pregnancy toxemia, very low blood glucose values (Bani Ismail et al., 2008) and cholesterol levels (El-Bealawy, 2000) have been reported.

On the other hand, in sheep and goats, the severity of toxemia gestation is linked to hypoglycemia. Indeed, the plasma concentration of glucose is closely related to its concentration in the cerebrospinal fluid.

Van Saun (2000) reported that ewes at the end of gestation are in negative energy balance, implying excessive lipomobilization as well as fat overload of the liver, and food analysis has shown a deficit in rations distributed to these females in fermentable carbohydrates capable of supplying the glucose necessary to satisfy the additional needs of the ewe during this period. However, it is also interesting to note that the supply of glucose to the pregnant uterus at the end of pregnancy does not increase as dramatically as for the mammary gland in early lactation. These observations lead to the question of whether reduced maternal glucose production contributes to the onset of hypoglycemia and the development of pregnancy toxemia rather than an increased demand for glucose by the pregnant uterus. This hypothesis implies that the main cause of pregnancy toxemia is not due to a high fetal consumption of glucose but rather a lack of glucose production by the mother possibly caused by a failure of the maternal system of glucose homeostasis (Schlumbohm and Harmeyer, 2008). On the other hand, the high values of the cholesterol levels may be due to a mobilization of the lipids to



compensate the hypoglycemia observed in the positive pregnant ewes. Ozpinar and Firat (2003) reported a plasma cholesterol level of 82.0 mg / dl on the 100th day of gestation and 84.0 mg / dl on day 120. These levels were higher than those of Hallford and Galyean (1982), and Shetaewi and Ross (1991) as well as those recorded in this study. This could be explained by the multiple lambing of the ewes.

### **Conclusion**

Results of this study indicate that the biochemical profile of ewes with subclinical pregnancy toxemia differs from that of other pregnant ewes. BHB should be measured in pregnant ewes in late stages of gestation with hypoglycemia to prevent and reduce economic losses caused by this disease.

### **References**

- Andersson, L., Lundstrom. K. (1984). Milk and blood ketone bodies, blood isopropanol and plasma glucose in dairy cows; methodological studies and diurnal variations. *Zentralbl Veterinarmed [A]* 1984; 31: 340-349.
- Bani Ismail, Z.A., Al-Majali, A.M., Amireh, F., Al-Rawashdeh, O.F. (2008). Metabolic profiles in goat does in late pregnancy with and without subclinical pregnancy toxemia. *Vet Clin Pathol* 37/4 (2008) 434–437.
- Bergman, E.N., Konk, K., Katz, M.L. (1963). Quantitative measurements of acetoacetate metabolism and oxidation in sheep. *Am. J. Physiol.* 205, 658–662.
- Bickhardt, K., Konig, G. (1985). Blood readings from healthy mothers of the merino and blackheads at the time of birth. *Dtsch. Tierärztl. Wochenschr.* 92, 319–322.
- Bickhardt, K., Henze, P., Sallmann, H.P. (1993). Glucose metabolic disorders in adult sheep and their treatments. *DVG Conference " Diseases of Small Ruminant*, pp. 92-100.
- Bowden, D.M. (1971). Non-esterified fatty acids and ketone bodies in blood as indicators of nutritional status in ruminants: A review. *Can J Anim Sci* 1971;51:1–13.
- Burtis, C. A., Ashwood, E. R. (1999). *Tietz Textbook of Clinical Chemistry*, 3rd edn. W.B. Saunders Co., Philadelphia, PA.
- Caldeira, R.M., BELO, A.T., Santos, C.C.,VAZQUES, M.I., PORTUGAL, A.V. (2007). The effect of body condition score on blood metabolites and hormonal profiles in ewes. *Small Rumin. Res.* 68, 233–241.
- El-Belawy, M.A. (2000). Some studies on pregnancy toxemia in goats. *Egyptian Journal of Agricultural research.* 2000.78:1, special issue, 207-215.26.
- El-Din, I.M.G., El-Sangery, F.H. (2005). Clinical and biochemical studies of pregnancy toxemia in sheep in sharkia Governorate. *Assiut Veterinary Medical Journal.* 2005 51:105,141-151, 46.
- Firat, A., Ozpinar, A. (2002). Metabolic profile of pre-pregnancy, pregnancy and early lactation in multiple lambing Sakýz ewes. 1.Changes in plasma glucose, 3-hydroxybutyrate and cortisol levels. *Ann. Nutr. Metab.* 46, 57–61.
- Hallford, D.M., Galyean, M.L. (1982). Serum profiles in fine-wool sheep. *Bovine Pract* 1982;3:26–32.
- Herdt, T.H., Stevens, J.B., Olson, W.G., Larson, V. (1981). Blood concentrations of B hydroxybutyrate in clinically normal Holstein-Friesian herds and in those with a high prevalence of clinical ketosis. *Am J Vet Res* 1981; 42: 503-506.
- Kabakci, N., Yarim, G., Yarim, M., Duru, O., Yagci, B.B. Kisa, U. (2003). Pathologica, clinical and biochemical investigation of naturally occurring pregnancy toxemia of sheep. *Acta Veterinaria (Belgrade).* 53.(2-3).2003.161-169.

- Kammula, R.G. (1976). Effect of experimentally induced hyperketonemia on glucose metabolism of ovine brain in vivo. *Am. J. Vet. Res.* 37, 935–938.
- Liamadis, D., Mills, Ch. (2007). Significance of quality of truly digestible protein on performance of ewes at late pregnancy and early lactation. *Small Rumin. Res.* 71, 67–74.
- Mavrogianni, V.S., Brozos, C. (2008). Reflections on the causes and the diagnosis of periparturient losses in sheep. *Small Rumin. Res.* 76, 77–82.
- Ozpinar, A., Firat, A. (2003). Metabolic profile of pre-pregnancy, pregnancy and early lactation in multiple lambing Sakýz ewes. 2. Changes in plasma progesterone, estradiol-17B and cholesterol levels. *Ann. Nutr. Metab.* 47, 139–143.
- Radcliffe, A.G., Wolfe, R.R., Colpoys, M.F., MuñHlbacher, F., Wilmore, D.W. (1983). Ketone- glucose interaction in fed, fasted, and fasted infected sheep. *Am. J. Physiol.* 244, R667–R675.
- Sargison, N.D. (2007). Pregnancy toxemia. In: Aitken, I.D. (Ed.), *Diseases of Sheep*, 4th edn. Blackwell, Oxford, pp. 359–363.
- Schlumbohm, C., Sporleder, H.P., Gurtler, H., Harmeyer, J. (1997). The influence of insulin on metabolism of glucose, free fatty acids and glycerol in normo- and hypocalcaemic ewes during different reproductive states. *Deutsch. Tierärztl. Wochenschr.* 104, 359–365.
- Schlumbohm, C., Harmeyer, J. (2008). Twin-pregnancy increases susceptibility of ewes to hypoglycaemic stress and pregnancy toxemia. *Research in Veterinary Science* 84, (2008) 286–299.
- Schultz, L. H., Myers, M. (1959). Milk test for ketosis in dairy cows. *J Dairy Sci* 1959; 42: 705–710.
- Scott, P.R., Sargison, N.D., Penny, C.D., Pirie, R.S., Kelly, J.M. (1995). Cerebrospinal fluid and plasma glucose concentrations of ovine pregnancy toxemia cases, inappetent ewes and normal ewes during late gestation. *Brit. Vet. J.* 151, 39–44.
- Shetaewi, M.M., Ross, T.T. (1991). Effects of concentrate supplementation and lasalocid on serum chemistry and hormone profiles in Rambouillet ewes. *Small Rumin. Res.* 4, 365–377.
- Sigurdsson, H. (1988). Susceptibility to pregnancy disease in ewes and its relation to gestational diabetes. *Acta Vet Scand*, 1988, 29, 404–414.
- Singh, S.K., Prasad, M.C., Nem, S., Ramakrishna, C., Singh, N. (1992). Clinicobiochemical studies on induced pregnancy toxemia in sheep. *Indian. J Vet Path* 1992; 16:85–90.
- Singh, S.K., Prasad, M.C., Singh, N. (1996). Hepatopathy associated with induced pregnancy toxemia in ewes. *Indian J Vet Path* 1996; 20:31–35.
- Van Saun, R.J. (2000). Pregnancy toxemia in a flock of sheep. *J Am Vet Med Assoc.* 2000; 217:1536–1539.

## PREVALENCE OF DANGEROUS ZONOSSES AMONG WILD CARNIVORES AND FUR ANIMALS OF CAGE MANAGEMENT IN SOME REGIONS OF THE RUSSIAN FEDERATION

Amina THAKAHOVA<sup>1\*</sup>, Vera BEREZHKO<sup>1</sup>, Anatoli BITTIROV<sup>2</sup>, Liudmila NAPISANOVA<sup>1</sup>, Olga ZHDANOVA<sup>3</sup>, Iraida OKULOVA<sup>3</sup>

<sup>1</sup>All-Russian scientific research institute of fundamental and applied parasitology of animals and plants of name K.I. Scriabin, Russia, Moscow

<sup>2</sup>Kabardino-Balkarian State Agricultural University named after V.M. Kokova, Russia, Nalchik  
Kirov State Medical Academy, Russia, Kirov

\*Corresponding author: amina7161@yandex.ru

### Abstract

The rates of infection among wild carnivores in the Kabardino-Balkarian Republic and fur animals of cage management in the Kirov Region were investigated. *Echinococcus granulosus* and *Toxocara canis* infections appeared to be the most common helminthoses among wild carnivores. In Kabardino-Balkaria the number of wolves infected by *E. granulosus* and *T. canis* increased from 28.6 to 78.6% (on average 54%), jackals – from 26.9 to 88.5% (58.5%), raccoon dogs – from 18.2 to 81.8% (51.0%), foxes – from 13.3 to 73.3% (45.3%). The comparative analysis of the infection rates with *E. granulosus* and *T. canis* in different age groups of wild carnivores was carried out. The highest level of infection was revealed in adult animals. Though for the trial period the values of infection extensity in wolves increased from 7.1 to 21.4% (on average 7.1%); in jackals – from 7.7 to 27.0% (4.7%); in raccoon dogs – from 9.1 to 18.2% (10.9%) and in foxes – from 6.7 to 20.0% (18.7%). The obtained data evidenced about existence of *E. granulosus* and *T. canis* infection stable natural foci supported by high levels of infection in wild carnivores. It caused a dangerous epizootic situation on these helminthoses. The investigation of caged fur animals was carried out in the Kirov Region before planned dehelminthizations. It was found that helminthoses caused by *Toxocara canis* and *Toxascaris leonine* were the most common ones. At fur farms of the region during the study period the number of polar foxes infected by *T. canis* increased from 53.34% to 74.0%; of raccoon dogs – from 65.0 to 87.5%. The level of *T. leonina* infection among polar foxes increased from 43.34 to 52.0% and in raccoon dogs reached 75.0% during the same period. On basis of the obtained results we can conclude that dehelminthizations are necessary for fur animals of cage management.

**Keywords:** *Canids, wolf, echinococcosis, toxocarosis, toxascaridosis.*

### Introduction

*Echinococcus granulosus* and *Toxocara canis* infections appear to be the most dangerous helminthozoonoses (in epidemiological terms) among wild carnivores. According to Sokolov (1998), Bilankin (2004) and Davletova (2002) the extensity of infection (EI) with *E. granulosus* in wolves, jackals, foxes and raccoon dogs ranges from 60 to 100%. With the help experimental studies it is possible to reveal significant rate of soil contamination by eggs of different helminth species: *T. canis*, cestodes of Taeniidae family including *E. granulosus*. As a rule mixed infections with *E. granulosus* and *T. canis* are registered on the territory of the Russian Federation (Osipov, 2000). So according to Esaulova and coauthors (2012) helminth fauna of wolves in the reservation «Kaluzhskie zaseki» consists of trematodes, cestodes and

nematodes and EI reaches 82.5%. *E. granulosus* and *Taenia hydatigena* are found in natural ecosystems of the Voronezh region; wolves and foxes are their definitive hosts (Romashov and coauthors, 2013). On the territory of the Volgograd region helminth fauna of wolves consists of 15 helminth species, *E. granulosus* (EI 23.5%) and *T. canis* (EI 35.2%) are the most common ones among them (Shinkarenko, Kolesnikov, 2011). Considering that the both helminth species are dangerous to humans investigations on their prevalence in nature among wild carnivores can be of great scientific and practical interest. And results of these studies can be taken into account for planning preventive measures. Based on this we carried out research of prevalence of *E.g.* and *T.c.* infections among wild carnivores (wolf, jackal, raccoon dog, fox) in Kabardino-Balkaria as well as *T. canis* and *T. leonine* in fur animals of cage management in the Kirov Region (Russia).

### **Materials and methods**

Prevalence of *Echinococcus* and *Toxocara* infections among wild canids was studied in 2011-2015. The study was conducted in animals of different age groups. 14 wolves, 26 jackals, 11 raccoon dogs and 15 foxes were examined by the method of helminthological autopsy according to K.I. Skryabin at the periods of sanitary shooting. Extensity and intensity of infection of each animal species were evaluated according to the results of collected helminth material. Processing of the data was carried out according to the computer program “Biometry”. Coproovoscopy according to the method of Fulleborn was used for examination of fur animals of cage management. Data of autopsy during slaughter were also used. Serological tests served as auxiliary methods.

### **Results and discussion**

Analysis of epizootic situation on *Echinococcus* and *Toxocara* infections among abovementioned wild canids showed a significant deterioration (Table 1). From 2012 to 2015 one observed an increase of the number of *E. granulosus* and *T. canis* infections in all animal species of tested canids. In wolves EI increased 2.8 times (from 28.6 to 78.6%), in jackals – 3.3 times (from 26.9 to 88.5%), in raccoon dogs – 4.5 times (from 18.2 to 81.8%), in foxes – 5.5 times (from 13.3 to 73.3%). However the given values of infection level among wild canids were not objective enough and did not demonstrate real epizootic situation in the region. One could observe a similar tendency during analysis of age dynamics of the infection by these helminth species (Table 2). From 2011 to 2015 the rate of infection in young wolves (from 6 months to 1.5 years old) by *Echinococcus* increased 3 times (from 7.1 to 21.4%), in jackals – 3.5 times (from 7.7 to 27.0%), in raccoon dogs – 2 times (from 9.1 to 18.2%), in foxes – 2.98 times (from 6.7 to 20.0%).

Table 1. The rate of infection by Echinococcus and Toxocara among wild canids in the Kabardino-Balkarian Republic

Species	The number of examined animals in average during a year	The number of animals infected by Echinococcus and Toxocara				
		2011	2012	2013	2014	2015
wolf	14	4 (28,6%)	6 (42,8%)	8 (57,1%)	9 (64,3%)	11 (78,6%)
jackal	26	7 (26,9%)	10 (38,5%)	15 (57,7%)	18 (69,2%)	23 (88,5%)
fox	15	2 (13,3%)	5 (33,3%)	7 (46,7%)	9 (60,0%)	11 (73,3%)
raccoon dog	11	2 (18,2%)	4 (36,4 %)	6 (54,6%)	7 (63,6%)	9 (81,8%)

Table 2. The rate of infection by Echinococcus and Toxocara spp. in young wild canids depending on their age

Year	The rate of infection by Echinococcus and Toxocara in wild carnivores, %		
	The number of animals examend during a year	The number of young animals at the age from 6 monthes to 1.5 year	EI,%
Wolf			
2011	14	1	7,1
2012	14	2	14,3
2013	14	2	14,3
2014	14	3	21,4
2015	14	3	21,4
Jackal			
2011	26	2	7,7
2012	26	3	11,5
2013	26	4	15,4
2014	26	5	19,2
2015	26	7	27,0
Raccoon dog			
2011	11	-	-
2012	11	1	9,1
2013	11	2	18,2
2014	11	1	9,1
2015	11	2	18,2
Fox			
2011	15	-	-
2012	15	1	6,7
2013	15	2	13,3
2014	15	2	13,3
2015	15	3	20,0

The obtained data indicate that the situation for these helminthozoonoses in Kabardino-Balkaria is unfavourable and requires proper (due) attention of the competent authorities as this may be the cause of deterioration of epidemiological situation.

Investigations of caged fur animals carried out in the Kirov region in 2013-2016 at fur farms before planned dehelminthizations revealed that *T.canis* and *T.leonina* infections were the most common ones. Animals could become infected with *T.canis* intrauterine as well as during contact with food, dishes, care items, etc. (Zhdanova and others, 2016; Napisanova and others, 2016). It should be noted that infection caused by *T.canis* is dangerous for people too. The results of our work for these years are given in Table 3.

The highest extensity of *Toxocara canis* infection in polar foxes was registered in nine-month-old animals (Table 3). The obtained results showed that for the trial period the values of infection extensity in polar foxes increased. In 2015-2016 the rate of *T. canis* infection reached 74%. The highest level of infection with *Toxascaris leonine* was revealed mainly in adult animals. One could observe a tendency to increase of this infection too: to 2015-2016 EI in polar foxes reached 70%.

Table 3. The rate of infection by helminths among fur animals of cage management in the Kirov region.

Species and age of animals; species of helminths	The number of tested animals		The number of infected animals, heads, (%)	
	2013-2014	2015-2016	2013-2014	2015-2016
Polar fox:				
1) 9 months	30	50		
<i>T. canis</i>			16 (53,34%)	37 (74,0%)
<i>T. leonina</i>			8 (26,67%)	17(34,0%)
2) Adults	30	30		
<i>T. leonina</i>			18(60,0%)	21 (70,0%)
Raccoon dog:				
1) 9 months	20	40		
<i>T. canis</i>			13 (65,0%)	35 (87,5%)
<i>T. leonina</i>			18 (90,0%)	0 (0%)
2) Adults	20	20		
<i>T. leonina</i>			12(60,0%)	13 (65,0%)

The highest level of infection with these helminths in raccoon dogs was revealed in very young animals and in nine-month-old ones. Since 2013-2014 the extensity of infection with *Toxocara* increased by 22.5% and reached 87.5% in 2015-2016. The same tendency was noted in toxascaridosis in nine-month-old raccoon dogs, their extensity of infection was 90% in 2013-2014. For this reason unplanned dehelminthizations were carried out in 2015 and in 2016 which affected the results of the study (Table 3). The rate of infection with *T. leonine* in adult raccoon dogs during the study period increased slightly (by 5%) and in 2015-2016 was 65%. Coproovoscopy showed low and moderate intensity of infection (67-282 eggs per 1 g of feces) which was confirmed at autopsy (1-4 helminths per an animal) as well as by serological studies.

## **Conclusion**

The obtained results of our study allow to conclude that *Echinococcus granulosus* and *Toxocara canis* infections in wild canids are widely spread in Kabardino-Balkaria and represent a serious social problem. So we consider it expedient to draw the attention of competent authorities to the problem. As for helminthozoonoses in fur animals it is necessary to carry out planned dehelminthizations. If the rate of infection in animals is very high unplanned treatments also should be conducted.

## **References**

- Bilankin O.V. Epizootology of echinococcus infection in wolves, jackals and foxes in the southern region of the Russian Federation // *Vestnik Veterinary*. – Stavropol. – 2004. – pp. 23-25.
- Davletova I.M. Distribution of echinococcus infection in wild dogs in Tatarstan // *Izv. Kazan. GAVM and B*. – Kazan. – 2002. – vol. 48. – pp. 40-43.
- Esaulova N.V., Litvinova E.M., Drozdova A.V., Ernandes-Blanco H.A. Results of the study of helminthofauna of wolves in the reserve "Kaluga Zaseki". // *Materials reports of the scientific conference all-Russian Society of Helminthologists RAS "Theory and practice of struggle against parasitic diseases"*. – 2012. – issul 13. – pp. 166-168.
- Zhdanova O.B., Okulova I.I., Chasovskikh O.V., Napisanova L.A. Peculiarities of *Toxocara* infection diagnostics in caged polar foxes // *International Journal of Applied and Fundamental Research*. – 2016. – № 10-1. – p. 162.
- Napisanova L.A., Zhdanova O.B., Ashikhmin S.P., Okulova I.I. To the question of improvement of control measures of *Toxocara canis* infection // *Materials reports of the scientific conference all-Russian Society of Helminthologists RAS "Theory and practice of struggle against parasitic diseases"*. – 2016. – pp. 283-286.
- Osipov R.N. Population structure of helminth fauna of wild canids with mixed infections // *Veterinary pathology*. – 2000. – № 4. – pp. 58-50.
- Romashov B.V., Rogom M.V., Nikulin, P.I., Fononova E.N., Romashova N.B., Galudina N.A. Helminth fauna of wild carnivores in the Voronezh region // *Materials reports of the scientific conference all-Russian Society of Helminthologists RAS "Theory and practice of struggle against parasitic diseases"*. – 2013. – Issul 14. – pp. 322-326.
- Sokolov L.F. The main helminthoses of wild canids in the Krasnodar region // *Materials reports of the scientific conference all-Russian Society of Helminthologists RAS "Theory and practice of struggle against parasitic diseases"*. – 1998 – pp. 243-245.
- Shinkarenko AN, Kolesnikov P.V. Helminth fauna of a wolfe at the the territory of the Volgograd Region // *Materials reports of the scientific conference all-Russian Society of Helminthologists RAS "Theory and practice of struggle against parasitic diseases"*. – 2011. – issul 12. – pp. 565-566.

## EFFECT OF SOME EXOGENOUS ENZYMES ON ANIMAL PERFORMANCE OF BROILER IN ALGERIA

Naima SAHRAOUI<sup>1</sup>, Mohamed HIDER<sup>1</sup>, Mohammed DOUDAH<sup>1</sup>, Jean LUC HORNICK<sup>2</sup>

Veterinary Institute, Blida University- 9400 Blida, Algeria

<sup>2</sup>Nutrition unit, Liège, Belgium

\*Corresponding author: nasahraoui@gmail.com

### Abstract

The aim of this study is to evaluate various zootechnical and biochemical parameters at a poultry farm following the use of dietary exogenous enzymes. This study was conducted on a total of 7,400 chicks from Arbor Acres strain. They were divided into two groups, one received a basic diet (standard) not supplemented with enzymes as control throughout the rearing period and the other a diet supplemented with enzymes. Growth performance, feed efficiency and mortality were recorded at the end of each week. From our results it was observed that the addition of the enzymes does not significantly improve body weight of feed conversion ratio during the breeding period. However, the mortality rate was higher in the control group compared to that supplemented with the enzymes. The diet based on exogenous enzymes decreased the level of serum glucose ( $2.16 \pm 0.07$  vs  $2.60 \pm 0.18$ ), respectively for the control and experimental group). It increased not significantly, the levels of triglycerides ( $0.87 \pm 0.18$  vs  $0.53 \pm 0.06$ ), HDL ( $0.79 \pm 0.14$  vs  $0.75 \pm 0.06$ ), LDL ( $0.28 \pm 0.10$  vs  $0.16 \pm 0.05$ ). Exogenous enzymes proved a positive effect on zootechnical parameters and serum glucose in Algerian broiler chicks.

**Key words:** *Broiler, enzymes, performances.*

### Introduction

Since the 1940's antibiotic growth promoters (AGPs) are an integral part of livestock production. However, the excessive use of antibiotics led to the development of antibiotic resistance, a serious risk for animal and human health. Resistance is developed as a reaction of the bacteria to defend itself and offer resistance to antibiotics through mutation, but there has been a lot of research activity looking at possible alternative compounds. Public pressure and concerns about food and environmental safety (antibiotic residues, antibiotic-resistant pathogens) have driven researchers to actively look for alternatives to antibiotics. Some of the alternatives include pre- and probiotics, organic acids and essential oils (Diarra and Malouin, 2014). Feed additives based on plant extracts aim at improving the animal health and the qualities of its feed: added in small quantities to the raw materials, they preserve the animal health, improve the rations efficiency, reduce the production costs, enhance the product features.

Many alternatives to AGP, such as pre- and probiotics, symbiotics, hormones, organic and inorganic acids, ionophores, herbs and ethereal oils, methane inhibitors and other additives including enzymes in animal diets, have been explored for a decade. These practices not only impose an extra financial burden on animal producers but they also leave residues in animal products, which may cause health concerns (Sharma et al., 2008). Among these products, enzymes have a great interest. They act as catalysts, improve the digestibility of food components and reduce wet droppings and odors.



It is in this context that it is proposed in this study to evaluate the nutritional enzymes efficiency in broiler chickens as well as its impact on some biochemical parameters.

## **Materials and methods**

### **Place and duration of the study**

This study was carried out on 7400 arbor-acre stalk chicks, distributed in two groups, but under identical ambient conditions, a control group (n = 3700) and an experimental group (n = 3700).

The birds were placed in the battery cages, and the temperature was controlled and gradually reduced from 30°C to 20°C on day 42.

The birds were vaccinated against New castle and Gumboro's diseases. A fresh feed and water were provided daily ad libitum.

The birds in the control group were given a diet without additives (T<sub>1</sub>). The ingredient and chemical composition of the control diet (maize, soya bean meal, salt, vitamin and trace element mixture). The experimental group was given the same diet as fed to the control group but was supplemented with 350g / tonne enzymatic complex (cellulase, xylanase, alpha-amylase, beta-glucanase, phytase, protease).

### **Statistical analysis**

The evolution of the zootechnical parameters was compared with the "separate-slopes model" of the Statistica General Linear Model (GLM) test.

After verifying the homogeneity of the variances of the biochemical parameters, the means of the control and experimental groups were compared by Student tests and the differences considered significant for  $p < 0.05$ .

### **Parameters**

The body weight of birds was recorded on the individual basis at weekly intervals. The cumulative feed consumption was also recorded on the weekly basis. Feed conversion ratio was worked out at weekly intervals by taking into consideration the weekly body weight gain and the feed consumption.

This experiment has a biochemical and a zootechnic component. From zootechnical parameters, the growth, the consumption index and the mortality rate of the two groups were compared.

Blood samples were collected from the slaughtered birds in nonheparinised tubes. The samples were centrifuged at 3000 rpm for 15 minutes, and the serum obtained was stored at -20°C until analysis. serum glucose, and cholesterol, triglycerides, creatinine, urea, HDL, LDL were determined by the auto analyzer using commercially available kits. Blood samples were taken at the age of 56 days.

## **Results and discussion**

### **Zootechnical parameters**

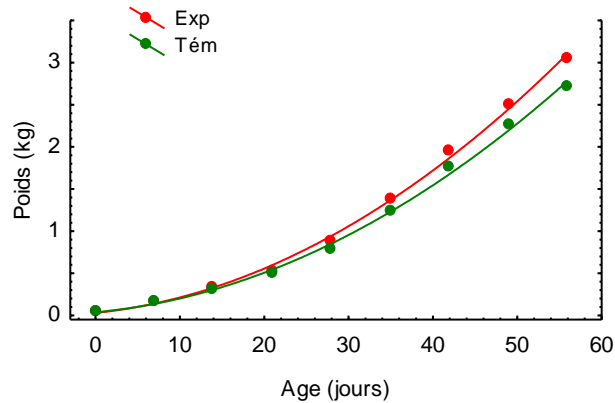
#### Weight gain

The chickens in the experimental group showed a higher growth than the control group. The mean weights at the end of the experiment, after 56 days, are 3040 g for the experimental group and 2713 g for the control group. Nevertheless, this difference is not significant ( $p = 0.83$ , figure 1).

Our results are close to those reported by Mathlouthi et al. (2011), performing at 52-day (1953 vs 2017 g).

Khan et al. (2006) and Abudabos et al. (2010) found significant improvements in growth and feed conversion when broiler chickens were fed with corn based diets supplemented with enzymes

Figure 1. Evolution of mean weight according to age



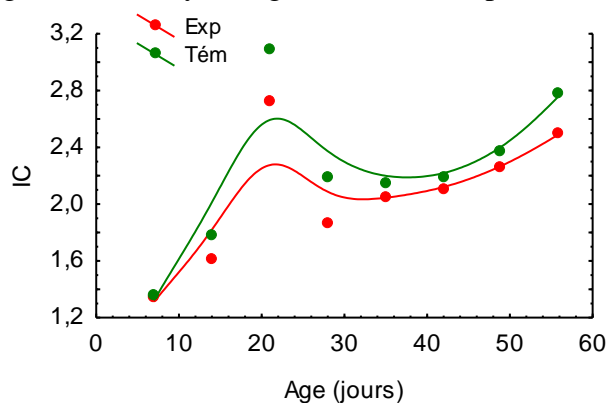
### Consumption Index

The statistical analysis revealed no significant difference between the values of the consumption indices in the various steps of breeding ( $p = 0.75$ ). Nevertheless, the chickens of the experimental group have an improved consumption index compared to the control group (FIG. 2). The control group always had a higher consumption index than the experimental group but remained statistically insignificant.

According to Abudabos et al. (2011), a diet based on exogenous enzymes results in a decrease in the consumption index compared to controls in experimental chicks.

Similarly, administration to broilers of exogenous enzymes improves the growth of animals at day 42, and reduces the consumption index in comparison with a control group.

Figure 2. Weekly change in the consumption index



### Mortality rate

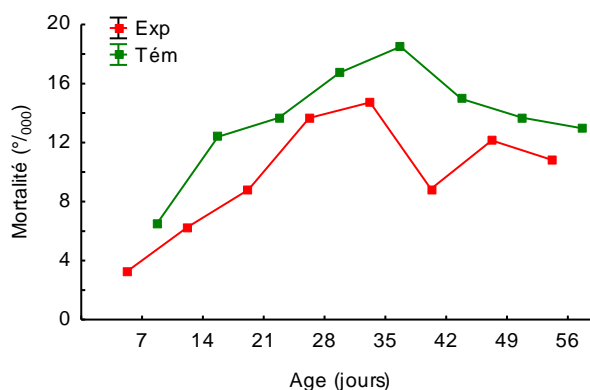
Our results show that the mortality rates recorded in the chickens of the control group are higher than those observed in the chickens of the experimental group throughout the trial period (Figure 3).

The GLM test shows that there is a slight effect of age ( $p = 0.03$ ) and a slight effect of the group ( $p = 0.03$ ). Mortality increases slightly with age and remains slightly higher for the control group, which is consistent with the two pathological episodes of coccidiosis and colibacillosis during the experiment.

A low mortality rate in the experimental group can be explained by the effectiveness of the enzymes in reducing the mortality rate in chickens.

According to Bedford (2000), the use of exogenous enzymes affects populations of intestinal microbial flora in the small intestines and caeca. Rosen (2001) reported a positive effect of enzymes on chick survival.

Figure 3. Evolution Weekly mortality rate



### Biochemical Parameters

The biochemical parameters of the control and supplemented groups of broiler chicken enzymes are presented in Table 1.

Table 1. Biochemical parameters of broiler of two groups

Parameters (g.L <sup>-1</sup> )	Group		p
	Exp	control	
<b>Glycemia</b>	2,60	1,75	0,11
<b>Triglycerides</b>	0,53	0,87	0,11
<b>Cholesterol</b>	1,01	0,91	0,50
<b>HDL</b>	0,75	0,79	0,81
<b>LDL</b>	0,16	0,28	0,31
<b>Creatinine</b>	3,40	3,00	0,35
<b>Urea</b>	0,02	0,03	0,38

The glucose concentration was higher in the experimental batch than in the control batch (2.6 vs 1.75) without being significant ( $p = 0.11$ ). This result is higher than that obtained by Fontaine (1.50 to 1.80 g.L<sup>-1</sup>), and which is similar to our control group (1.75 g.L<sup>-1</sup>). This can be explained by the effect of enzymes that improve digestibility, which induces an increase in blood glucose after ingestion of a significant amount of carbohydrates.

The results obtained show a reduction in triglyceridemia values for the experimental compared to the control group (0.53 vs 0.87 g L<sup>-1</sup>), but this difference is not significant ( $p = 0.11$ ).

This result does not exclude the role of exogenous enzymes in reducing cholesterol. Thus, a low value of cholesterol in the control group can be explained by the intestinal or hepatic impairment resulting from diseases (coccidiosis and colibacillosis) or intense metabolism at the administration of treatments, thus leading to a decrease of the anabolism of cholesterols.

This hypothesis could be confirmed by the remarks made in 2004 by Koolman et al. (2005), Which state that the external dietary intake of cholesterol has very little influence on the blood cholesterol level, The endogenous biosynthesis which takes place, inter alia, at the hepatic and intestinal level.

The statistical tests to which the test results were subjected did not show any significant difference in HDL during the last step between the experimental and control groups (0.75 vs 0.79 gL<sup>-1</sup>).

In light of our results, we can say that exogenous enzymes do not affect serum creatinine in broiler chickens. This resulted in a non-significant difference ( $p = 0.35$ ) between the experimental and the control group (3.40 vs 3.00 g / l). The difference was not significant between the mean urea level of experimental group and the control group (0.02 vs 0.03 g / l).

### **Conclusion**

Our experiment made it possible to specify, in our local conditions, the impact of the enzyme food supplementation on the zootechnical performances and the biochemical parameters of the broiler chicken.

It appears that the use of exogenous enzymes in diets allows an improvement in zootechnical performance, but also seems to have effects on biochemical parameters even if they are still not really significant. The results of this study appear to be interesting.

### **References**

- Diarra, M.S., Malouin, F. (2014). Antibiotics in Canadian poultry productions and anticipated alternatives. p. 282.
- Sharma, R.K., Maini, S., Ravikanth, K. (2008). Beneficial Effects of Superliv DS and Xlivpro on growth promotion and carcass quality traits in broilers. *Veterinary World*, pp. 363-365.
- Mathlouthi, N., Ballet, N., Larbier M. (2011). Influence of Beta-glucanase Supplementation on Growth Performances and Digestive Organs Weights of Broiler Chickens Fed Corn, Wheat and Barley-based Diet. *International Journal of Poultry Science*, pp. 157-159.
- Khan, S.H., Sardar, R., Siddique, B. (2006). Influence of enzymes on performance of broilers fed sunflower-corn based diets. *Pakistan Vet J.* pp. 109-114.
- Abudabos, A. (2010). Enzymes supplementation of corn-soybean meal diets improves performance in broiler chicken. *International Journal on Poultry Science*, pp. 9: 292-297.
- Bedford. M. (2000). Removal of antibiotic growth promoters from poultry diets: implications and strategies to minimise subsequent problems. *World's Poultry Science Journal*; 56: 347-365.
- Rosen, G.D. (2001). BSAS Meeting, York, UK.
- Koolman, J. Rochm, K.H. (2005). *Color atlas of biochemistry*, 2nd edition 2005, edition flexibook 2014; pp.46-56, 162-172.

## INFLUENCE OF ORGANIC AND INORGANIC IRON ON LAYING HENS PRODUCTIVITY AND BLOODS MORPHOLOGICAL COMPOSITION AND PARAMETERS IN BLOOD

Vilija BUCKIUNIENE\*, Romas GRUZAUSKAS, Guoda STANYTE

Institute of Animal Rearing Technologies, Faculty of Animal Husbandry Technology, Veterinary Academy, Lithuanian University of Health Sciences. Kaunas, Lithuania

\*Corresponding author: vilija.buckiuniene@ismuni.lt

### Abstract

In the past, poultry nutritionists were interested in establishing nutrient requirements of poultry to support maximum performance of laying hens. The aim of this study was to investigate the effects of diets supplemented with organic and inorganic iron in different amounts on the productivity and blood parameters of laying hens at 28-36 weeks of age. A total of 36 *Lohmann Brown* laying hens at 28 weeks of age were assigned to three treatment groups (12 hens per each treatment group) and fed experimental diets for 8 weeks. The diets comprised 70 mg FeSO<sub>4</sub> (Control group I), 150 mg iron sulphate (Group II), 70 mg FeSO<sub>4</sub>+72 mg of iron glycinate (Group III) and birds were keeping in the same conditions. Organic and inorganic iron in different amounts did not have statistically significant effect on the productivity of the laying hens. When analyzed the data on laying hens' blood parameters, the results were statistically significant when it comes to the concentration of iron (in Group II it increased 29%,  $P<0.05$ ) and concentration of ALAT (in Group III –it increased 36%  $P<0.05$ ). Alkaline phosphatase, however, had a tendency to decrease in all experimental groups, from 1.45 to 6.71 times ( $P<0.05$ ) compared to the control group. When analyzed the morphological composition of blood, statistically significant results were obtained in Group III on platelets; it decreased 25 % compared to the control group. To conclude, it could be said that different origin and amount of iron did not have any effect on laying hens' productivity, but had a positive effect on some blood parameters.

**Key words:** *Iron, laying hens' productivity, blood parameters.*

### Introduction

Poultry nutrition is focused on the major dietary components (protein and energy) and vitamin and mineral supplements, from both organic and inorganic sources, that are normally incorporated into the diets to meet the bird's requirements (Zhao et al., 2010, Yuan et al., 2011). Trace minerals (TM) are essential in the diets of poultry because they participate in the metabolic processes required for optimum growth and development (Soetan et al., 2010). Traditionally, supplementation of TM to the commercial poultry diets has been achieved through the use of inorganic salt forms, such as sulfate, oxides, and carbonate. However, because of low TM availability from this source, substantial efforts have been devoted to improve its utilization by animals. Organic/chelated TM (CTM) have been considered as an alternative to inorganic TM (Yuan et al., 2011; Mondal et al., 2007; Dobrzanski et al., 2008; Salim et al., 2012; Ivanišinova et al., 2016). Thus, the aim of the trial was to investigate how organic forms of iron influence the laying hens productivity and blood morphological composition and parameters.

## Materials and methods

A total of 36 *Lohman Brown* laying hens which were 28 weeks old were assigned to three treatment groups (12 hens per each treatment group) and fed with the experimental diets for 8 weeks, which containing 70 mg FeSO<sub>4</sub> (I control group), 150 mg iron sulphate (II group), 70 mg FeSO<sub>4</sub>+72 mg of iron glycinate (III group) and keeping in the same conditions. All diets were formulated to meet or exceed the nutritional requirements of birds as suggested by NRC (1994) with the exception of Fe concentration (Table 1). The hens were fed with 125 g compound feed per day. The main ingredients of compound feed have been wheat, wheat flour, sunflower cake, soybean cake, NaCl, methionine and lysine (Table 1). Source of Fe glycinate (25 percent of glycine, 18 percent of Fe), Glystar® Forte Fe, ARKOP, Poland.

During the feeding trial, these parameters were analyzed: daily calculated and weighed all the eggs, the calculated of the group of egg weight; every 14 days weighed on feed remain and calculated feed conversion ratio of 1 kg of egg mass produced; every 14 days are calculated eggs number dynamics and egg production intensity. At the end of the trial of each group were selected after 5 laying hens, were killed by experimental animal euthanasia guidelines (Close *et al.*, 1997) and perform the following research - in the blood serum were identified the following indices: blood morphological composition, triglycerides, total cholesterol, HDL- and LDL-cholesterol, globulins  $\alpha_1$ ,  $\alpha_2$ ,  $\beta$ ,  $\gamma$ , GGT, GOT, alkaline phosphatase, total protein, bilirubin levels were determined blood analyzer INTEGRA 400/700/800.

Statistical Analysis. The results of the experiment were analyzed using the 1-way ANOVA test, and significant differences between groups were determined by Duncan's multiple range test. Statistica 8.0. for Windows™ software was used. Differences were considered significant at  $P < 0.05$ .

Table 1. Composition and nutrient content of the basic feed

Parameter	Amount
Wheat	60.38
Soybean meal	12.89
Wheat flour	10.00
Sunflower meal	5.00
Limestone	0.98
Metabolizable energy, MJ/kg	11.40
Crude protein	17.00
Crude fat*	3.12
Crude fibre*	3.28
Crude ash	12.16
Ca*	3.45
P (total) *	0.67
P (available)	0.42
Lysine	0.71
Metionine	0.39
Metionine+cystine	0.70
Tryptophane	0.22
Threonine	0.55

\* Analyzed value

**Composition of premix:** Ca – 3.45 %, P – 0.67 %, Na – 0.13 %, lysine – 0.71 %, metionine – 0.39 %, metionine+cistine – 0.70 %, triptophane – 0.22 %, treonine – 0.55 %, vit. E – 40.00mg/kg, vit. A – 11.000 TV, vit. D3 – 2.500 TV, vit. K3 – 2.50 mg/kg, vit. B1 – 2.50 mg/kg, vit. B2 – 7.00 mg/kg, vit. B6 – 4.00 mg/kg, vit. B12 – 25 µg/ kg, nicotinic acid – 55.00 mg/kg, pantothenic acid – 15.00 mg/kg, folic acid – 1.75 mg/kg, biotin -

100.00 µg/kg, choline chloride – 399.00 mg/kg, Fe – 70.00 mg/kg, Mn – 100.00 mg/kg, Zn – 60.00 mg/kg, Cu – 6.00 mg/kg, I – 0.50 mg/kg, Se – 0.20 mg/kg, Co – 0.10 mg/kg. Content of iron in all experimental groups were different. I group -70 mg of FeSO<sub>4</sub>, II group-150 mg of FeSO<sub>4</sub>, III group – 70mg of FeSO<sub>4</sub> + 72mg of Fe glycinate

### Results and discussions

As a feed additive, iron is usually used in the form of an inorganic salt, such as sulfates, oxides and carbonates. Current nutrition standards for poultry assume 80 mg Fe/kg of dry matter in broiler feed, while a dose above 2000 ppm is considered toxic (Theil, 2004; Vieira, 2008).

Similarly, the use of compound poultry feed enriched with iron chelates, alone or in combination with methionine, affects the content of this component in hen eggs and poultry meat (Park et al., 2004; Bao et al., 2007; Seo et al., 2008). In searching for new solutions to achieve measurable benefits such as improved health and production performance, scientists became interested in glycine chelates (Bovell-Benjamin et al., 2000; Kegley et al., 2002; Feng et al., 2007, 2009). Recent studies (Pineda and Ashmead, 2001; Etle et al., 2008) suggest that glycine-chelated iron (Fe–Gly) is more easily absorbed and utilized than iron from other amino acid chelates. Männer et al. (2006) determined that the stability and availability of intestinal chelates based on the smallest amino acid, that is glycine, is 25% higher than in older generation chelates based on lysine or methionine. In studies by Petrovič et al. (2010), when Fe was used in the form of proteinates covering 20% of the requirement, no reduction in the final body weight of chickens nor in the intake and utilization of feed was observed compared to groups where recommended doses of inorganic Fe were used. In turn, Abdallah et al. (2009) showed that chickens whose diet contained 100% of organic Fe were heavier compared to those receiving inorganic iron. Also, Ao et al. (2009) observed improved production performance when using organic Fe. In contrast, studies by Nollet et al. (2005) showed that when 40 ppm of Fe was added, both from inorganic sources (sulphates) and from bioplexes, no statistically significant differences were found in the body weight of chickens. The laying hens' productivity is presented in Table 2. There have not been any significant treatment effects on egg production, feed consumption and feed conversion ratio. In tendency, egg production was highest and FCR was best in Group II.

Table 2. Influence of organic and inorganic iron on laying hens productivity

Parameter	Groups		
	I (control)	II (experimental)	III (experimental)
Total feed consumption, g	1687.50±30.62	1697.75±18.28	1655.25±31.60
Laying rate, %	89.30±2.63	92.80±1.95	90.30±2.78
The average of egg weight, g	67.80±1.41	66.70±1.46	67.20±2.20
Feed conversion ratio, kg	2.02±0.07	2.00±0.06	2.07±0.07

A positive effect of chelates on certain immunological indicators has been noted as well, for example as increased activity of anti-oxidation enzymes (Pineda and Ashmead, 2001). In experiment, the highest concentration of iron was determined in group II, it increased 29 percent ( $P<0.05$ ) compared to control group. The highest concentration of aminotransferase was determined in group III, it increased 36 percent ( $P<0.05$ ), when analysed data of alkaline phosphatase in the laying hens blood, we determined that using 150mg of FeSO<sub>4</sub> this parameter decreased by 6,7 times ( $P<0.05$ ) and when compound feed was supplemented with 70mg of FeSO<sub>4</sub>+72mg of Fe glycinate – it also decreased 31 percent ( $P<0,05$ ) compared to

the control group. For other laying hens blood parameters it did not had statistically significant effect, the data was insignificant.

Table 3. Influence of organic and inorganic iron on laying hens blood parameters

Parameter	Groups		
	I (control)	II (experimental)	III (experimental)
Iron	66.76±1.09	86.42±1.22*	73.47±6.47
Ferritin	0.50±0.01	0.50±0.01	0.50±0.01
GGT (γ glutamyltranspherase)	18.27±5.66	22.10±2.69	15.37±3.96
ASAT (aminotranspherase)	174.64±21.68	169.28±18.36	161.78±13.42
ALAT (aminotranspherase)	1.60±0.49	1.43±0.87	2.17±0.95*
Alkaline phosphotase	4104.97±232.09	611.95±369.41*	2825.89±170.86*
Total bilirubin	1.70±0.01	1.70±0.01	1.70±0.01
Direct bilirubin	0.81±0.01	0.81±0.01	0.81±0.01

\*-data statistically significant at P<0.05

In evaluating the effectiveness of inorganic and organic sources of microelements, the course of metabolic processes may be significant; this is reflected, among other things, by variable values of biochemical and haematological indicators of blood (Ganong, 2005; Kaneko et al., 2008). In the studies, the values of the above-mentioned parameters were within the reference range for chickens (Thrall, 2004; Kaneko et al., 2008). Selected haematological indicators were also determined in the experiment to evaluate the iron metabolism of the birds. When analyzed laying hens morphological blood composition, statistically significant results were get just in platelets (PLT), in group III it decreased 20 percent (P<0.05) and platelet distribution width (PDW) – in group II it increased 18 percent (P<0.05), but in group III it decreased by 24 percent (P<0.05) compared to the control group.

Table 4. Influence of organic and inorganic iron on laying hens morphological blood composition

Parameter	Groups		
	I (control)	II (experimental)	III (experimental)
Leukocytes (WBC)	675.14±47.65	693.90±44.45	667.36±36.19
Erythrocytes (RBC)	2.53±0.13	2.71±0.06	2.45±0.26
Hemoglobin (HGB)	81.38±2.38	84.50±0.50	81.00±8.00
Hematocrit (HCT)	30.73±1.00	32.20±0.20	30.30±2.60
Mean cell volume (MCV)	121.66±2.46	119.10±2.10	124.25±2.85
Mean cell hemoglobin (MCH)	32.20±0.78	31.25±0.55	33.15±0.35
Mean Cell Hemoglobin Concentration (MCHC)	265.00±2.75	262.50±5.65	267.50±3.50
Platelets (PLT)	1.88±0.38	2.00±0.61	1.50±0.50*
Platelet Distribution Width (PDW)	7.39±0.79	8.70±0.98*	5.65±1.15*
Mean platelet volume (MPV)	8.79±0.35	8.05±0.25	8.90±0.30
Basophils (BASO)	0.24±0.10	0.20±0.09	0.35±0.12

\*- data statistically significant at P<0.05



## **Conclusions**

So in concluded it could be said that different origin and amount of iron did not had effect on laying hens productivity, but had positive effect on some bloods parameters.

## **References**

- Abdallah A.G., El-Husseiny O.M., Abdel-Latif K.O. (2009). Influence of some dietary organic mineral supplementations on broiler performance. *The Journal of Poultry Science*. Vol. 8, pp. 291–298.
- Ao T., Pierce J.L., Power R., Pescatore A. J., Cantor A.H., Dawson K.A., Ford M.J. (2009). Effects of feeding different forms of zinc and copper on the performance and tissue mineral content of chicks. *Poultry Science*. Vol. 88, pp.2171–2175.
- Bao Y.M., Choct M., Iji P.A., Bruerton K. (2007). Effect of organically complexed copper, iron, manganese and zinc on broiler performance, mineral excretion and accumulation in tissues. *J. Appl. Poult. Res.* Vol.16, pp. 448-455.
- Bovell-Benjamin A.C., Viteri F.E., Allen L.H. (2000). Iron absorption from ferrous bisglycinate and ferric trisglycinate in whole maize is regulated by iron status. *The American Journal of Clinical Nutrition*. Vol. 71, pp.1563–1569.
- Dobrzanski Z., Korczynsk M., Chojnacka K., Gorecki H., Opalinski S. (2008). Influence of organic forms of copper, manganese and iron on bioaccumulation of these metals and zinc in laying hens. *J. Elem.* Vol. 13, pp. 309–319.
- Ettle T., Schlegel P., Roth X. (2008). Investigations on iron bioavailability of different sources and supply levels in piglets. *Journal of Animal Physiology and Animal Nutrition*. Vol. 92, pp. 30–45.
- Feng J., Ma W.Q., Xu Z.R., He J.X., Wang Y.Z., Liu J.X. (2009). The effect of iron glycine chelate on tissue mineral levels, fecal mineral concentration, and liver antioxidant enzyme activity in weanling pigs. *Animal Feed Science and Technology*. Vol. 150, pp. 106–113.
- Feng J., Ma W.Q., Xu Z.R., Wang Y.Z., Liu J.X. (2007). Effects of iron glycine chelate on growth, haematological and immunological characteristics in weaning pigs. *Animal Feed Science and Technology*. Vol. 134, pp. 261–272.
- Ganong W.F. (2005). *Review of Medical Physiology*, 12th edn. McGraw-Hill Medical, New York, NY.
- Yuan J., Xu Z., Huang C., Zhou S., Guo Y. (2011). Effect of dietary Mintrex-Zn/Mn on performance, gene expression of Zn transfer proteins, activities of Zn/Mn related enzymes and fecal mineral excretion in broiler chickens. *Anim. Feed Sci. Technol.* Vol. 168, pp. 72–79.
- Kaneko J.J., Harvey J.W. Bruss M.L. (2008). *Clinical Biochemistry of Domestic Animals*, 6th edn. Elsevier, Academic Press, Burlington, VT, USA.
- Kegley E.B., Spears J.W., Flowers W.L., Schoenherr W.D. (2002). Iron methionine as a source of iron for the neonatal pig. *Nutrition Research*. Vol. 22, pp. 1209–1217.
- Männer K., Simon O., Schlegel P. (2006). Effects of different iron, manganese, zinc and copper sources (sulfates, chelates, glycinates) on their bioavailability in early weaned piglets. In: M. Rodehutsord (ed.) *Tagung Schweine- und Geflügelernährung*. Martin Luther Universität Halle-Wittenberg, Halle, Germany, pp. 25–27.
- Mondal M.K., Das T.K., Biswas P., Samanta C.C., Bairagi B. (2007). Influence of dietary inorganic and organic copper salt and level of soybean oil on plasma lipids, metabolites and mineral balance of broiler chickens. *Anim. Feed Sci. Technol.* Vol. 139, pp. 212–233.

- Nollet L., van der Klis J.D., Lensing M., Spring P. (2007). The effect of replacing inorganic with organic trace minerals in broiler diets on productive performance and mineral excretion. *The Journal of Applied Poultry Research*. Vol. 16, pp. 592–597.
- Park S.W., Namkung H., Ahn H.J., Paik I.K. (2004). Production of iron enriched eggs of laying hens *Asian-Aust. J. Anim. Sci.* Vol. 17, pp. 1725-1728.
- Petrovič V., Nollet L., Kováč G. (2010). Effect of dietary supplementation of trace elements on the growth performance and their distribution in the breast and thigh muscles depending on the age of broiler chickens. *Acta Veterinaria Brno*. Vol. 79, pp. 203–209.
- Pineda O., Ashmead H.D. (2001). Effectiveness of treatment of iron-deficiency anemia in infants and young children with ferrous bis-glycinate chelate. *Nutrition*. Vol. 17, pp. 381-38.
- Salim H., Lee H., Jo C., Lee S., Lee B. (2012). Effect of dietary zinc proteinate supplementation on growth performance, and skin and meat quality of male and female broiler chicks. *Br. Poult. Sci.* Vol. 53, pp.116–124.
- Seo S.H., Lee H.K., Ahn H.J., Paik I.K. (2008). The effect of dietary supplementation of Fe-methionine chelate and FeSO<sub>4</sub> on the iron content of broiler meat *Asian-Aust. J. Anim. Sci.* Vol. 21, pp. 103-106.
- Soetan K.O., Olaiya C.O., Oyewole O.E. (2010). The importance of mineral elements for humans, domestic animals, and plants: a review. *Afr. J. Food Sci.* Vol. 4, pp. 200–222.
- Theil E.C. (2004). Iron, ferritin, and nutrition. *Annu. Rev. Nutr.* Vol. 24, pp. 327-343.
- Thrall M.A. (2004). *Veterinary Haematology and Clinical Chemistry*. Lippincott Williams and Wilkins, Philadelphia, PA, USA.
- Vieira S.L. (2008). Chelated minerals for poultry. *Rev. Bras. Ciênc. Avíc.*, Vol. 10, pp. 73-79.
- Zhao J., Shirley R.B., Vazquez-anon M., Dibner J.J., Richards J.D., Fisher P., Hampton T., Christensen K.D., Allard J.P., Giesen A.F. (2010). Effects of chelated trace minerals on growth performance, breast meat yield, and footpad health in commercial meat broilers. *J Appl. Poult. Res.* Vol. 19, pp. 365–372.

## **IMPACT OF A PLANT EXTRACT "ORIGANUM MAJORANA" ON THE ZOOTECHNICAL PARAMETERS AND THE STATE OF HEALTH OF BROILER IN ALGERIA**

Naima SAHRAOUI<sup>1</sup>, R. LARBI<sup>1</sup>, M. LAKHDARI<sup>1</sup>, M. BRAHIM ERRAHMAN<sup>1</sup>, D. GUETARNI<sup>1</sup>, Jean Luc HORNICK<sup>2</sup>

<sup>1</sup>Veterinary Institute, Blida University- 9400 Blida, Algeria

<sup>2</sup>Nutrition unit, Liège, Belgium

\*Corresponding author: nasahraoui@gmail.com

### **Abstract**

In the search for alternatives to antibiotics, several non-therapeutic Extracts of plants, are increasingly being proposed and studied for increasing performance and control of Coccidiosis of chickens. The aim of this study was to evaluate the efficacy of plant extract supplementation For *Origanum majorana* to improve zootechnical performance and control broiler chicken coccidiosis. For 54 days, an experimental group A (1200 chicks) receiving water supplemented with an anticoccidial based on plant extract (OREGO-STIM, 150 ml per 1000 L) was compared with a control group C (1200 chicks) receiving in the drinking water a chemical anticoccidial, As well as a group B (1200 chicks) receiving the two anticoccidians in the drinking water. Zootechnics performance results showed a difference in weight in favor of lot A (lot: A 3182 g, lot B: 2610 g, lot C: 3050) at the end of the period breeding. Consumption indices were similar. Subsequently, lot A showed significant difference compared to lots B and C. The cumulative mortality rate recorded at the end of the rearing period was similar (5-6%) in the three lots. The lesion scores obtained in the animals of group B at autopsy showed more important signs than those of group A and C revealing clinical and subclinical forms of coccidiosis. Under the present experimental conditions, the addition of an extract of *Origanum majorana* in drinking water improved the zootechnical performance of chickens. Nevertheless, the impact of this supplementation requires further studies to confirm or Control of coccidiosis.

**Key words:** *Influence, plant extract, zootechnical parameters, broiler, Algeria.*

### **Introduction**

The abusive use of anticoccidials in the production of has promoted the emergence and dissemination of antibiotic resistance and a significant increase of the cost of the medication (Yvone, 1992). In order to reduce the exorbitant costs and propose a alternative to resistance phenomena of coccidia, it is necessary to find other solutions, apart from the Pharmaceuticals, for the control of coccidiosis avian.

We tested the effect of oregano (OREGOSTIM) incorporated into the drinking water in this work which aims to evaluate, under local conditions, its Coccidiostatic effect to improve performance and control of coccidiosis in chickens of flesh.

### **Material and methods**

The study was carried out in three broiler farms of Bejaia in Algeria from 1 August to 30 October 2015.

**Animals:** The animals were divided into 2 lots:

A / Lot A: composed of 1200 chicks on a specific day *Gallus gallus domesticus*, of strain Cobb500.

B / Lots B and C: each of 1200 chicks of one day of species *Gallus gallus domesticus*, of strain Arbor Acres.

**Food:** A farinaceous food is consumed. The food is consisting of corn, soybean meal, wheat bran, phosphates Bicalcium, limestone and mineral-vitamin concentrates.

L A "start-up" food distributed from the 1st to the 15th day.

L A "growth" food from the 16th to the 40th day.

L A "finishing" food from the 41st day until slaughter.

### **Drinking water**

The drinking water distributed to the three lots came from water from where many families get their supplies. This source is registered by the hydraulic services and controlled by the municipal hygiene office.

### **ORIGO-STIM**

It is a natural product extracted by distillation of a plant called *Origanum majorana*, in liquid form. Animals of lots A and B, receiving water with a Coccidiosis based on plant extract (OREGO-STIM), 150 ml per 1000 L were compared with those of a control C.

### **Plan of prophylaxis**

A vaccination schedule was established as follows:

L 7th day against Newcastle with a reminder to the 28th day,

The 14th day against the Gumboro.

Experimental protocol

Lot A: receiving a food adapted to each age and source water supplemented with Origo-stim.

Lot B: receiving a food to each age and source water supplemented with Origo-stim. After Resistances, we have used chemical antimicrobial agents (Algicox and Joprox).

Lot C: receiving a food at each age and supplemented water of chemical anticoccidiens (Algicox).

## **Results and discussion**

### **Zootechnical parameters**

#### Weight gain

The results obtained showed weight gain Slightly higher on the 52nd day in experiments group A  $\approx$  3042 g with respect to control group C  $\approx$  2847 g and B  $\approx$  2466 g.

The good growth achieved in group A is undoubtedly attributable to the efficacy of the anticoccidial drug used in The OREGO-STIM and the absence of clinical coccidiosis because it depresses the zootechnics by reducing the rate of growth and by increasing the consumption index (Yvove, 1992).

Consumption indices (IC) : Our results show that the consumption index at the end of each rearing phase:

L Lot A: 1.93

L Lot B: 2.1

L Lot C: 1.93

The results on the consumption index show that groups A and C (1.93) were better than B group.

B (2.1). There is a better consumption index for lots A and C in relation to the group B. The increase in the latter follows on from the of pathological episodes during breeding (coccidiosis and other complications such as respiratory diseases) and which contributed to these poor performances.

Mortality rate

The results obtained show mortality rates of 5; 45; 5.83 and 6.50% respectively for groups A, B and C. It should be noted that the mortality rates recorded in groups A and B are comparable to the reported standard by Villate (2001) and which is 5%. One can explain these results by the good husbandry conditions in which took place our experimentation. Though These are not strictly observed on the Algerian ground (thermal insulation of the building, Ventilation, density, respect of the sanitary barrier, Equipment and type of power supply).

The slightly higher mortality rate for Lot C (From the 6th to the 7th week) could be due to embrittlement the immune system of the individuals by coccidiosis and the appearance of respiratory diseases (colibacillosis).

### **Conclusion**

The results obtained in this study show that the incorporation of anticoccidial extracts Plants "OREGO-STIM" extract of oregano (*Origanum Vulgare*) in drinking water allows:

- Improved weight.
- An improvement in the consumption index.
- A reduction in the mortality rate while preserving
- Good animal health status

Therefore, and on the basis of the foregoing, the addition plant extracts is a better alternative to Chemical antibiotics and other antibiotics as they to address the problems of resistance to coccidiosis. In addition, Oregano and marjoram do not Development of resistance to coccidia following use. They can be used in poultry (flesh, Laying hens, turkeys), and should be tested in ruminants.

### **References**

- Fortineau O., Troncy P.M. (1985). Coccidiose, maladies animales majeures: Les coccidioses du poulet. *Rev. Elev. Méd. Vét. Nouvelle Calédonie*, 917.
- Johnson J., Reid W.M. (1970). 1Anticoccidial Drugs: Lesion scoring techniques in battery and flfloor-pen experiments with chicken. *Exp. Parasitol.* 28:30-36.
- Messai A. (2015). Utilisation de l'armoise et de l'eau de riz en traitement adjuvant de la coccidiose chez le poulet de chair. Thèse de Doctorat. Université de Constantine, p100.
- Sahraoui N., Brahim Errahmani M., Ammi-Baaziz D., Hezil N., Bennadji M.A., Boulariah H., Chaouadi D., Hornick J.L., Guetarni D. (2015). Effet de l'extrait végétal de *Yucca Schidigera* sur l'excrétion oocystale chez le poulet de chair. *Rev. Mar. Sci. Agron. Vét.* 3:53-57.
- Villate D. (2001). *Maladies des volailles*. Édition France Agricole. 2ème édition. 2001.
- Yvoré, P. (1992). Les coccidioses en aviculture. Manuel de Pathologie aviaire. J. Brugère-Picoux and A. e. Silim, eds. École Nationale Vétérinaire d'Alfort, MaisonAlfort, France, 312-317.

## DETERMINATION OF COLLAGEN CONTENT IN ALGERIAN CAMEL MEAT

Naima SAHRAOUI<sup>1</sup>, Guy DEGAND<sup>2</sup>, Mohamed Brahim ERRAHMANI<sup>3</sup>, Babelhadj BAAISSA<sup>4</sup>, Djamel GUETARNI<sup>5</sup>, Antoine CLINQUART<sup>2</sup>, Jean Luc HORNICK<sup>6</sup>

<sup>1</sup>Veterinary Institute, University of Blida 1, Blida, Algeria

<sup>2</sup>Department of Food Sciences, University of Liège, Belgium

<sup>3</sup>Department de Chemistry, University of Blida 1, Blida, Algeria

<sup>4</sup>Laboratory for the Protection of Ecosystems in Arid and Semi-Arid Zones, University of Kasdi Merbah, Ouargla, 30000, Algeria

<sup>5</sup>Department of Biology, University of Blida 1, Blida, Algeria

<sup>6</sup>Nutrition Unit, Tropical Veterinary Institute, University of Liège, Belgium

\*Corresponding author: nasahraoui@gmail.com

### Abstract

A total of twenty-three camels (age range: 4 months-15 years) from both sexes and belonging to Sahraoui and Targui breeds were slaughtered following the normal abattoir procedures in Ouargla (Algeria). Samples of *Longissimus dorsi* were collected and the collagen content was determined. Mean value was  $2.20 \pm 0.27$  % on fresh material. Higher collagen content was recorded in animals more than 8 years old when compared to animals from 0 to 4 years old ( $p=0.024$ ). The difference between the breeds was not significant ( $2.13$  vs  $2.39\%$  in Sahraoui and Targui breeds, respectively). Meat from the females had significantly higher values than that of the males ( $4.77$  vs  $1.82\%$ ).

**Key words:** camel- collagen- sex- breed.

### Introduction

Dromedary camel is one of the most important domestic animals in arid and semi-arid regions as it is equipped to produce high quality food at low costs under extremely harsh environments compared to other animals (Yagil, 1982; Yousif and Babiker, 1989). It is a good source of meat in areas where climate adversely affects the efficiency of production of other animals (Kadim and al., 2006). Moreover, camel meat has low fat content and is rich in some healthy nutrients (Sahraoui and al., 2014). Few studies performed on camel meat (Babiker and Yousif, 1990; Kadim et al., 2008) suggested that the quality of camel meat is comparable to beef if animals are slaughtered at comparable ages, whereas, physicochemical and textural characteristics of camel meat have not been fully exploited.

Basically, meat can be considered in its simplest form as a myofibrillar structure, a collection of parallel fibers, bound together by a connective network tissue composed of collagen and elastin (Icier and al., 2009). The texture of meat mainly depends on zootechnical parameters such as breed, age and sex (Huff-Lonergan and Lonergan, 2005), and on anatomical characteristics such as type of muscle (Zamora, 1997). Structure of collagen and elastin is a significant factor that affects meat texture (Takagi and al., 1992). Hydroxyproline is a major component of the [protein collagen](#), comprising roughly 13.5% of mammalian collagen. Hydroxyproline and proline play key roles for collagen stability. They permit the sharp twisting of the collagen helix (Szpak, 2011). To our knowledge, the connective tissue composition of meat is unknown in Algeria. The aim of this study was thus to measure the levels of collagen in the meat from camels belonging to Algerian population.

## Materials and methods

### Animals and muscle sampling

Twenty-three Algerian camels, aged between 4 months and 15 years, fattened by local camel herders in Ouargla (Algeria), were selected and slaughtered following the normal abattoir procedures. The samples of *Longissimus dorsi* muscle were removed from each carcass within 1 h post-slaughter. Muscle samples were cut cylindrically (5 cm diameter and 10 cm length). Samples were sealed in plastic bags and transported to the Faculty of Veterinary Medicine, University of Liege, in an insulated box filled with ice, where samples were packed and stored at  $-18^{\circ}\text{C}$  until analysis in the Laboratory of Food Science.

### Chemical analysis

#### Hydroxyproline estimation

The hydroxyproline (OH proline) content in meat was determined according to ISO 3496 method performed by [ISO 3496 \(1994\)](#). Briefly, 6-7 grams of fresh meat sample was hydrolysed with 8, 4 N sulfuric acid for 16 h at  $105^{\circ}\text{C}$ . Hydrolysate was filtered, and solution was diluted to volume with distilled water. One millilitre of hydrolysate was pipetted into a 100 ml volumetric flask and filled to mark with  $\text{H}_2\text{O}$ . Two milliliters of colour reagent was added and mixed. Tube was then placed in a water bath at  $60^{\circ}\text{C}$  for 20 min, then cooled to room temperature and absorbance measured.

A standard calibration curve was carried out from OH proline proanalyzer at concentrations ranging from 0.25 to 3.2  $\mu\text{g} / \text{mL}$ . The calibration line related optical density to concentration of OH proline expressed in  $\mu\text{g} / \text{mL}$ . The OH proline content in the collagen is being considered as 12.5%. The collagen content was calculated from hydroxyproline content using the coefficient 8

### Statistical analysis

The analysis was performed on Statistica 10, Statsoft, USA. The collagen concentrations were compared by age groups, gender and breed using the Student t-test or ANOVA procedure. Differences were considered significant at  $p < 0.05$  level. The data were expressed as % in fresh meat.

## Results and discussion

Results showed that the mean collagen content in meat was  $2.20 \pm 0.27$  %, with maxima value of 6.27% and minima value of 1.26%.

Regarding to age, the results showed that higher collagen content was recorded in animals over than 8 years, when compared to animals between the age of 0-4 and 4-8 years age groups ( $p = 0.024$ ; Table 1). A strong gender effect was observed on collagen content. Significantly higher collagen content was measured in females compared to males (Table 2). By contrast, no significant difference in total collagen content in meat was observed between Sahraoui and Tergui breeds (Table 3).

Collagen is the most abundant mammalian and avian protein and is found in all tissues, particularly skin, tendon, and bone (Piez, 1966; McCormick, 1999) but there is little data on camel's collagen content as reported by Kadim and al. (2013) and very few studies have explored the collagen content in camel meat (Babiker and Yousif, [1990](#); Siddiqi and al., [2000](#)).

Our results showed that the mean collagen content in meat camel was  $2.20 \pm 1.26$ %. Hadi Eskandari and al. (2012) reported largely lower total collagen content in camel meat, with

values ranging from 1.67 to 2.03 mg/g of meat for *Longissimus dorsi* and *Psoas major* muscles from one-humped male camels. Kamoun and al. (1995) indicated that the total collagen content was 3.3 to 7.5 mg/g in six major muscles. Nevertheless, Babiker and Yousif (1990) indicated that the total collagen content is greater in camel *Longissimus dorsi* than in *Semitendinosus* or *Triceps brachii*, possibly due to the morphological requirement for stabilizing the hump attached to the *Longissimus dorsi*.

Numerous investigations have determined total and insoluble collagen contents in bovine meat (Torrescano and al. 2003). However, Torrescano and al. (2003) reported that total collagen content of bovine muscles showed a wide range of values (0.31 to 1.15%). Mamani-Linares and Gallo (2013) indicated that soluble collagen was only 1.28 mg/g (20.28% of total collagen content) in llama *Longissimus lumborum* muscle. Other studies have reported that texture of meat fibers, aggregation and gel formation in bovine meat mainly depend on myofibrillar and sarcoplasmic proteins, on characteristics of animal such as breed, age and sex (Huff-Lonergan and Lonergan, 2005), on anatomical characteristics such as type of muscle, and on collagen solubility (Zamora, 1997).

Tenderness of meat is rated as the most important quality attributed by the average consumer and appears to be sought at the expense of flavor or color (Lawrie, 1979). The most marked difference in meat quality characteristics between camel and other livestock is believed to be tenderness. Camels are usually slaughtered at the end of their productive life (>10years) which is the reason that camel meat is classified as a low quality meat. In Kenya, the average age for camels slaughtered was 14.5 years (Mukasa-Mugerwa, 1981).

General consumers' view is that camel meat is unacceptably tough, but in fact meat from young camels has been reported to be comparable in taste and texture to beef (Kurtu, 2004).

For age, we observed that higher collagen content was recorded in animals over than 8 years, when compared to animals aged between 0-4 and 4-8 years. The same observation was made by Kadim and al. (2006) who suggested that male camels should be slaughtered between one to three years of age. Kadim and al. (2008) reported that Warner-Bartzler shear force (WBSF) values in 5–8 years old camels were significantly higher than 1–5 years old ones. Increase in toughness due to age may be related to changes in muscle structure and nature and quantity of connective tissue in the meat (Kadim and al., 2014). The collagen content of muscle increased from 18 to 20% between 9 and 13 months of age; above 13 months, muscles had lower variations in content. The gradual decrease in solubility of collagen would explain the decrease in meat tenderness with age of animal. However, Duarte and al. (2011), reported that total collagen content in muscle does not increase significantly with physiological maturity in cattle; however, collagen solubility is correlated with dental maturity since meat from animals with 2 and 4 permanent incisors has greater collagen solubility compared to that of animals with 8 permanent incisors. Intermolecular cross-links present in collagen found in muscle of young animals are unstable to heat but these links are converted into complex structures as the animal ages, becoming thermostable (Robins and al., 1973), tending to make the meat less tender.

Nevertheless, the total collagen level was found to be higher in females (Table 2). Abdelhadi et al. (2015) indicated that OH proline contents did not differ between male and female camel. Total collagen values decreased in the strong male lambs, while soluble collagen did not vary significantly.

The influence of gender on connective tissue is reported and refers to content and solubility of collagen. Collagen content is observed to be higher among males than in females. The collagen content of females is close to that of castrated males. Collagen solubility is similar in castrated males and females; It was low in all males (Monin, 1991). These differences are corresponding with the animal's age, since they are relatively poor in young animals and then increase with age (Kopp, 1982).



Collagen content also decreases with muscle development, it is linked with physiological period among genotypes, which can also contribute to differences in tenderness (Boccard and Bordes 1986; Renand, 1988). When reported to the breeds, no significant difference was observed between total collagen content in meat. Al-Owaimer et al. (2014) reported that cross sectional area of muscle fibers did not differ between the animal's breeds. Though, in the literature, many authors have reported the effect of breeds on beef tenderness. In semi-tropical region of Argentina, breeds effect on tenderness was observed between Criollo Argentino and Brasford steers raised on forage (Orellana and al., 2009). Breeds specialized for meat production (Limousin and blonde of Aquitaine) have a lower value of shear force than other breeds (Holstein and Old Brown Swis) (Monsón and al., 2004). In indigenous African cattle breeds, meat of Santa Gertrudis is less tender than those of Sanga, Afrikaner, Nguni, Brown Swiss, Pinzgauer and Bonsmara (Strydom et al., 2000). According to this author, in the arid subtropics of South Africa, breeds effect on tenderness and shear force were not significant, and as a rule, meat quality characteristics from young camels are comparable with those of beef.

### **Conclusion**

This study evaluated the content of collagen in Algerian camel meat. Results showed low mean levels but higher collagen content was recorded in the elderly. In addition, female camel meat had significantly higher collagen values but probably owing to an age effect. The values remained similar for Sahraoui and Tergui breed.

### **References**

- Abdelhadi OMA, Babiker SA, Bauchart D, Listrat A, Remond D, Hocquette JF, Faye B (2015). Effect of gender on quality and nutritive value of dromedary camel (*Camelus dromedarius*) longissimus lumborum muscle. *Journal of the Saudi Society of Agricultural Sciences*. King Saud University.
- Al-Owaimer AN, Suliman GM, Sami AS, Picard B, Hocquette JF, (2014). Chemical composition and structural characteristics of Arabian camel (*Camelus dromedarius*) m. longissimus thoracis. *Meat Sci.*;96(3):1233-41.
- Babiker SA, Yousif OK (1990). Chemical composition and quality of camel meat. *Meat Sci.*,(27): 283–287.
- Boccard R, Bordes P, (1986). Caractéristiques qualitatives et technologiques des viandes bovines: influence des facteurs de production. In *Production de viande bovine*. Ed D. Micol, INRA Publ, Paris, pp 61-84.
- Duarte MS, Paulino PVR, Fonseca MA, Diniz LL, Cavali J, Serão NVL, Gomide LAM, Reis SF, Cox RB (2011). Influence of dental carcass maturity on carcass traits and meat quality of Nelore bulls. *Meat Sci.*, 88( 3): 441–446.
- Hadi Eskandari M, Majlesi M, Gheisari MR, Farahnaky A, Khakzar Z (2013). Comparison of some physicochemical properties and toughness of camel meat and beef. *J. Appl. Ani. Res.*, 41(4): 442-447.
- Huff-Lonergan E, Lonergan SM (2005). Mechanisms of water holding capacity of meat: The role of post mortem biochemical and structural change. *Meat Sci.*, 71: 194-204.
- Icier F, Engin M, Bozkurt H (2009). Investigation of Applications of Ohmic Thawing and Ohmic, Cooking in Meat Processing. Project Report. TUBITAK TOVAG 107O898, pp: 171 (in Turkish). *J. Cam. Pract. Res.* 22(1): 27-32.
- ISO 3496:1994(E) Meat and meat products – determination of hydroxyproline content <http://www.iso.org/ISO/catalogue>

- Kadim IT, Al-Karousi A, Mahgoub O, Al-Marzooqi W, Khalaf SK, Al-Maqbali RS, Al-Sinani SSH, Raiymbek G (2013). Chemical composition, quality and histochemical characteristics of individual dromedary camel (*Camelus dromedarius*) muscles. *Meat Science*, 93( 3) : 564–571
- Kadim IT, Mahgoub O, Al-Marzooqi W (2008). Meat Quality and Composition of *Longissimus thoracis* from Arabian Camel (*Camelus dromedaries*) and Omani Beef: A Comparative Study. *J. Camelid Sci.*, 1: 37-47.
- Kadim IT, Mahgoub O, Al-Marzooqi W, Al-Zadgali S, Annamali K, Mansour MH (2006). Effects of age on composition and quality of muscle *Longissimus thoracis* of the Omani Arabian camel (*Camelus dromedaries*). *Meat Sci.*, (73) : 619–625.
- Kadim IT, Mahgoub O, Mbaga M (2014). Potential of camel meat as a non-traditional high quality source of protein for human consumption. 4 (4) :13-17
- Kamoun M (1995). Evolution de la qualite de la carcasse et de la viande des dromadaires En fonction de la conduit zootechnique des animaux. Rapport final relative à la bourse de recherché FIS no. 1372-2.
- Kopp J, (1982). Qualité des viandes de taurillons: évolution avec l'âge des caractéristiques physicochimiques des muscles. *Bull. Techn. CRZV Theix INRA*, (48): 27-46.
- Kurtu MY (2004). An assessment of the productivity for meat and carcass yield of camel (*Camelus dromedarius*) and the consumption of camel meat in the eastern region of Ethiopia. *Trop. Anim. Health Prod.*,(36):65–76.
- Lawrie RA (1979). *Meat science* (3rd ed.). Pergamon Press.
- Mamani Linares W, Gallo C (2013). Meat quality attributes of the *Longissimus lumborum* muscle of the Kh'ara genotype of llama (*Lama glama*) reared extensively in northern Chile. *Meat Science* 94(1):89-94
- McCormick RJ (1999). Extracellular modifications to muscle collagen: Implications for meat quality. *Poult. Sci.* 78:785.
- Monin G (1991). Facteurs biologiques des qualités de la viande bovine. *INRA Prod. Anim.*, 4 (2): 151-160.
- Monsón FC, Sañudo Sierra I (2004). Influence of cattle breed and ageing time on textural meat quality. *Meat Sci.*, 68(4): 595-602.
- Mukasa-Mugerwa, E. 1981. The camel (*Camelus dromedaries*): A biographical review (pp. 147). Addis Ababa, Ethiopia: International Livestock Centre for Africa.
- Orellana C, Peña F, García A, Perea J, Martos J, Domenech V, Acero R (2009). Carcass characteristics, fatty acid composition and meat quality of Criollo Argentino and Braford steers raised on forage in a semi-tropical region of Argentina. *Meat Sci.*, 81: 57-64.
- Piez KA (1966). Collagen. In *The Physiology and Biochemistry of Muscle as a Food*. P 315. Univ. Wisconsin Press, Madison, WI.
- Prost E, Pelczynska A, Kotula AW (1975). Quality characteristics of Bovine meat. I. content of connective tissue in relation to individual muscles, age and sex of animals and carcass quality grade. *J Anim Sci.* 41:534–540.
- Renand G (1988). Genetic determinism of carcass and meat quality in cattle. *Proceedings of 3rd World Congress on sheep and beef cattle breeding*. 19-23 June 1988, Paris. Volume 1, INRA Publ., Paris, 381- 395.
- Robins SP, Shimokomaki M, Bailey AJ (1973). The chemistry of the collagen cross-links. Age-related changes in the reducible components of intact bovine collagen fibres. *Biochemistry journal*, 131 (4) : 771–780
- Sahraoui , Dotreppe O, Brahim Errahmani M, Boudjenah S, Babelhadj B, Guetarni D. Hornick JL (2014). Caractérisation des acides gras de la viande cameline en Algérie. *Cahiers de Nutrition et de Dietitique*

- Siddiqi NJ, Al-jafari AA, Alhomida AS (2000). Investigation of total, free, peptide-bound, protein-bound, soluble and insoluble collagen hydroxyproline content in tissues from the Arabian camel (*Camelus dromedarius*). *Cell Biochem Funct.* 18:243–248.
- Strydom PE, Naede RT, Smith MF, Scholtz MM, van Wyk JB (2000). Characterization of indigenous African cattle breeds in relation to meat quality traits. *Meat Sci.*, 55: 79-88.
- Szpak P (2011). "Fish bone chemistry and ultrastructure: implications for taphonomy and stable isotope analysis". *Journal of Archaeological Science.* 38 (12): 3358–3372.
- Takagi H, Kondou M, Tomoaki H, Nakamori S, Tsai YCH, Yamasaki M (1992). Effects of an alkaline elastase from an alkalophilic *Bacillus* strain on the tenderization of beef meat.
- Torrescano G, Sanchez-Escalante A, Gimenez B, Roncales P, Beltran JA (2003). Shear values of raw samples of 14 bovine muscles and their relation to muscle collagen characteristics. *Meat Sci.* 64:85–91
- Yagil R (1985). *The desert camel comparative physiological adaptation* (vol. 5). Munchen, London: Verlag Karger Basal.
- Yousif OK, Babiker SA (1989). The desert camel as a meat animal. *Meat Sci.* 26, (4): 245-254
- Zamora F (1997). Variabilité biologique de l'attendrissage de laviande bovine. - Prédiction en fonction du facteur animal et du facteur type de muscle [Biological variation of bovine meat tenderisation. Prediction depending on animal or muscle-type factors].

## EFFECT OF A MIXTURE OF VEGETABLE EXTRACT ON THE YIELD OF BROILER CHICKENS IN ALGERIA

Naima SAHRAOUI<sup>1\*</sup>, Djahida ACHOUR<sup>1</sup>, Houria SAIFI<sup>1</sup>, Karima MEKADEMI<sup>1</sup>, Jean Luc HORNICK<sup>2</sup>

<sup>1</sup>Veterinary Institute, University of Blida 1, Blida, Algeria

<sup>2</sup>Department of Food Sciences, University of Liège, Belgium

\*Corresponding author : nasahraoui@gmail.com

### Abstract

In the context of the search for alternatives to antibiotics, several non-therapeutic substitution methods can be envisaged; including the use of plant extracts, The objective of this study was to evaluate the efficacy of natural plant extract supplementation (Volarom) to improve zootechnical performance and the health status of broiler for 50 days: an experimental group (1200 chicks) receiving a vegetable extract (volarom) in the added water was compared to a control group 'A' (3000 chicks). Results on zootechnical performance showed a difference in weight and mortality between the two groups. Under experimental conditions, the addition of a natural plant extract to drinking water showed significant performances, namely zootechnical performance and an improvement in the state of health of broiler.

**Key words:** *broiler chicken, homogeneity, zootechnical performance.*

### Introduction

The use of medicinal plants all over the world predates the introduction of antibiotics and other modern drugs into Africa continent. Herbal medicine has been widely used and formed an integral part of primary health care in China, Ethiopia, Argentina and Papua New Guinea. Traditional medical practitioners in Southwest, Nigeria, use a variety of herbal preparations to treat different kinds of microbial diseases including MRSA-associated diseases.

### Material and methods

#### I.1. Material

##### I.1.1. Place of study:

This study was carried out during a period running from October 15 to December 4, 2016. It was carried out in a broiler farm, the building of which is located in the BLIDA Wilaya.

##### VOLAROM:

It is a natural product by distillation of the following natural plants (turmeric, olive leaf, grape fruit seeds, thyme, Rosemary). This product is in liquid form.

##### Animals:

The animals were divided into two groups:

- Lot A (control group) consisting of 3000 day-old chicks *Gallus gallus domesticus*, of strain al Bouraque.
- Lot D (experimental group) comprising 1,200 one-day *Gallus gallus domesticus* chicks of the Bourca strain were used during this experiment.

#### Food:

A plug-type food is consumed. The food is composed of maize, soybean meal, wheat bran, calcium phosphate, salt, table oil, limestone, and mineral vitamin concentrates.

- A "start" food: distributed from the 1st day to the 15th day.
- A "growth" food: from the 16th day to the 40th day.
- A "finishing" food: from the 41st day until the slaughter.

#### **Parameters studied**

We have determined:

- 1) zootechnical performance: live weight, consumption index and mortality rate.
- 2) Biochemical parameters: triglycerides, cholesterol weight of viscera

##### I.2.3.1. Evaluation of zootechnical performance:

Determination of average weight:

In each group, an animal sample randomly selected from 10 subjects was weighed at 1, 15, 30, 45 days using an electronic scale. The means shall be determined by the following ratio:  
Mean weight (gr) = overall weight of subjects / number of animals weighed.

Determination of the consumption index: with the zootechnical parameters

The consumption index was determined on the 1st, 15th, 33rd, 50th day after having recovered the feed in the feeders to have the quantity consumed, it is calculated according to the following formula:

IC = amount of food consumed / sum of weight gains

Determination of the weight of the digestive organs and of the heart:

During the study period, five subjects were randomly taken in the morning of each group, which animals were sacrificed for the determination of organ weights, intestinal size and blood sampling for biochemical parameters.

#### **Biochemical parameters**

30 blood samples from 30 randomly selected subjects at the end of each rearing period at the rate of 5 chicks from each batch and at the end of each rearing period. These animals were sacrificed at the alar vein.

#### **Zootechnical parameters:**

Weight gain:

The mean weight of the animals during the rearing period is given in the following table:

Table 1: Weight of chicks.

Days	A	D
1	186± 81.9	204 ± 93.1
15	895± 286.6	1035± 282.5
30	1678.5± 468.1	2105.5± 468
50	2327± 321	2733.5 ± 111

The chicks in the experimental batch showed a significant weight compared to the control groups. It is established that the weight gain is closely related to the quality of the feed and to the respect of the conditions of rearing the type of feed used for the three phases of the breeding is of the cap type (meal) And better homogenized keeps its nutritive values as well as possible.

The good growth obtained in batch D is undoubtedly attributable to the efficacy of the plants used in this case VOLAROM resulting in the absence of clinical colibacillosis because colibacillosis affect zootechnical performance by decreasing the growth rate and increasing the consumption index

**Mortality Rate (MR):**

The observed mortality of the animals in the first three days is mainly due to stress, transport, manipulation during the installation of the chicks, the results of the mortality rates recorded for each phase are reported in the following table.

Table 2. mean and standard deviation of the mortality rate

Phase	Start up	Growth	Finsh
Age (days)	1 – 20 D	35 D	47 D
M R (%)	1.6 ± 1.6	0.9± 0.9	0
M RD (%)	0.4 ± 0.4	0.6± 0.9	0

Our results showed that:

Lot A: the average of the total percentage of mortality is 2.5%

Lot D: the average of the total mortality percentage is 1%  
 The high mortality rate observed for batch A could be due to the embrittlement of the immune system of the subjects by the presence of respiratory diseases (colibacillosis).

Consumption Index (CI): The consumption of food is reported in the following table.

Table 3. Amount of consumption

Age (Day)	A	D
20	0.86	1.16
40	1.50	1.59
47	1.16	1.22

It is established that the weight gain is closely related to the quality of the feed and to the respect of the conditions of rearing the type of feed used for the three phases of the breeding is of the cap type (granulated) And better homogenized keeps its nutritive values as well as possible.

The good growth obtained in batch D is undoubtedly attributable to the efficacy of the plants used in this case VOLAROM resulting in the absence of clinical colibacillosis because colibacillosis affect zootechnical performance by decreasing the growth rate and increasing.

The consumption index

Weight of the viscera of the chicks during the periods of rearing (heart, liver, proventricule) and intestinal morphometry.

The weight of the viscera (viscera yield) and the size of the intestines are reported in the following tables.

Table 4. Viscera and intestinal morphometry

	Start up A	Start up D	Growth A	Growth D	Finish A	Finish D
<b>Heart</b>	6.2 ±2.2	7.2±1.8	7.8± 1.3	10.8± 3.4	8.2± 2.2	11.4± 1.5
<b>Liver</b>	22± 6.8	24±6.4	37.2± 6.7	56.8± 6.8	34.6± 6.1	56.8± 7
<b>Gizzar</b>	11.8± 2.9	13.2±4	22± 4.7	42.4± 4.4	33.6± 2.3	43.2± 10
<b>Proventriculus</b>	2±0.7	2.6±0.9	3.2± 0.8	5.2± 0.8	6± 1.2	6.4± 0.9
<b>Fat mass</b>	5.6±1.7	5.8±1.1	16.2± 6.4	21± 7.7	15.6± 3.7	27.2± 13.1
<b>Intestines</b>	1.516±0.2	1.626±0.2	2.376± 0.5	2.720± 0.2	2.948± 0.1	3.008±0.3

The results relating to the weighings carried out show that group D is better than batch A. In numerical terms, a better weight of the organs for batch D is compared with batch A, taking account of what confirms the advantage of our product as a growth promoter with homogeneity, and it improves the weight gain. Lipid balance during different periods: The results of the lipid balance are reported in Table 5.

Table 5. Lipid balance results

Parameters	Start up Lot A	Start up lot D	Growth lot A	Growth lot D	Finish lot A	Finish lot D
<b>Cholesterol M mol/l</b>	2.164± 0.3	2.355± 0.3	2.02± 0.3	2.657± 0.4	1.722± 0.4	2.220± 0.2
<b>Triglyceride M mol/l</b>	1.542± 0.3	1.146± 0.7	0.653± 0.1	1.177± 0.3	1.069± 0.4	1.604± 0.5
<b>HDL M mol/l</b>	1.439± 0.2	1.594± 0.2	1.480± 0.2	1.712± 0.1	1.146± 0.2	1.506± 0.1
<b>LDL M mol/l</b>	0.416± 0.2	0.531± 0.2	0.409± 0.2	0.71± 0.2	0.362± 0.2	0.464± 0.2

There is a somewhat high result for lot D, which confirms the advantages of VOLAROM, concerning the batch A, this observed decrease may be due to hepatic or intestinal disease, consequent diseases (colibacillosis) or intensive metabolism following The administration of the treatments, thus inducing a decrease in the anabolism of cholesterol. This hypothesis could be confirmed by the remarks made in (2004) by Koolman et al, which state that the external dietary intake of cholesterol influences very little on the blood cholesterol level, because the majority comes from the Endogenous biosynthesis, which takes place, among other things, at the hepatic and intestinal level.

This hypothesis is also based on the remarks made by Leveille et al (1975), which states that the liver is the main organ responsible for lipid neosynthesis and that any damage leads to metabolic disorders.

### **Conclusion**

The results obtained in the present study show that the incorporation of natural plant extracts VOLAROM in drinking water allows a better improvement of the weight performances, an improvement in the consumption index, a decrease in the mortality rate while maintaining good animal health status, maintaining a satisfactory level of production.

### **References**

- Fontaine M., (1995). vade Mecum du vétérinaire /Vade Mecum of the veterinarian/. XVI édition
- Sahraoui N., Jugurtha, T., Thilleli, S. (2015). Détermination des valeurs usuelles de certains paramètres biochimiques en fonction de l'alimentation chez le poulet de chair dans la wilaya /Determination of the usual values of certain biochemical parameters according to the diet of the broiler in the Wilaya/ de TIZI-OUZOU
- Koolman et al , (2004) Color atlas of biochemistry , 2ndedition flexibook , page 46-56, 162-172.



## **6. RURAL DEVELOPMENT AND AGRO- ECONOMY**

## **THE CONTRIBUTION OF GEOGRAPHICAL INDICATIONS IN SUSTAINABLE RURAL DEVELOPMENT (EVIDENCE FROM NORTHERN ALBANIA)**

Roland BARDHI<sup>1\*</sup>, Ilir KAPAJ<sup>2</sup>

<sup>1</sup>Mountain Areas Development Agency (MADA), Tirana, Albania

<sup>2</sup>Department of Agribusiness, Faculty of Economy&Agribusiness, Agricultural University of Tirana, Tirana, Albania

\*Corresponding author: lbardhi@mail.com

### **Abstract**

Geographical indications (GIs) are a form of protective labeling used to indicate the origin of food and agricultural products. The role of protected geographical indicators as a promising sustainable rural development tool is the basis for this paper. The protection of geographical indications is a new practice and much research is still required for both sides of the debate. The focus of this debate is: Can a Geographical Indication (GI) which indicates that a certain product originates from a certain region with a given quality being attributable to its place of origin, become a tool to promote socio-economic livelihoods of rural communities? The research method employed for this study is a qualitative research approach. Two potential GI products are used to investigate the benefits brought to rural areas through the protection of GIs. The case studies include the GIs Chestnut and chestnut honey in two geographical Albanian areas, Tropoja and Reç of M. Madhe areas. Twenty-five in-depth interviews were conducted in 2016 for this study. The study identifies predominantly indirect links between GIs and sustainable rural development (SRD), through economic and social benefits brought to rural areas by the GIs investigated. This finding suggests that GIs are worthwhile for implementation in Albania as a rural development tool. The initiative for development of GI products was undertaken by BiodivBalkan Project, implemented in the North Albania, aiming to link biodiversity with development of quality signs (GIs) in order to support rural development and poverty reduction in the poorest areas of Albania.

**Keywords:** *Geographical Indications, Agrobiodiversity, Rural development, BiodivBalkan Project.*

### **Introduction**

There are two decades or so that the biodiversity issue was enriched by a new dimension called “Agrobiodiversity”. Geographical indications have been developed for primary and processed products of biodiversity.

A geographical indication (GI) is a form of protection highlighted in the Trade Related Aspects of Intellectual Property Rights (TRIPS) Agreement of the World Trade Organization (WTO). It protects intangible economic assets such as the quality and reputation of a product through market differentiation (Vandecandelaere, E., F. Arfini, G. Belletti and A. Marescotti (eds.) (2010).

It is considered a promising tool at the international level to maintain multi functionality in rural landscapes and involve local populations in biodiversity management and conservation. Using the examples of creating GI for “Chestnuts” and “Chestnut Honey”, we discuss how a GI can be successfully used by local producers and what conditions are needed for it to have a positive impact on the rural development and its associated biodiversity.

GIs, in a general sense, are signs placed on products that have a clearly established origin and poses qualities and reputation derived from its place of origin. GI provides a relevant tool to

protect and promote or enhance biodiversity (Larson Guerra, 2004). It is important therefore not to only consider the biological characteristics of a geographical area, but also the local knowledge and practices involved (Bérard and Marchenay, 2006) in order to achieve biodiversity benefits.

It is generally agreed that GIs promote sustainable rural development because they:

- Help producers obtain premium prices for their products whilst guaranteeing safety and quality to consumers;
- Improve redistribution of the added value to the actors (producers, processors etc) throughout the production chain;
- Bring added value to the region of origin;
- Increase production, create local jobs and prevent rural exodus;
- Preserve landscapes, traditional knowledge and biodiversity;

Giovanucci et al., (2009) emphasizes that even with originality of a potential GI product, the benefits will not accrue to the actors without the support of the legal and institutional frameworks. Other factors that support GIs registration of products include; collective action, prices and market for the product, specificity and reputation of product, support from other actors along the value chain, production methods and link of a product characteristics to history or tradition of the geographical area (Bramley and Biénabe, 2013).

There is much reference in economic and agrofood literature to the contribution of geographical indications to rural development. This reference is predominantly theoretical, signifying that there is a need for more empirical evidence demonstrating that geographical indications promote rural development. Furthermore, there are many forms of geographical indications each possibly impacting rural development differently (Barham, 2003). There is far less literature specifically concentrating on the influence of GIs on sustainable rural development than there is on origin labeled products in general. However from the many researches done it is generally believed (Babcock & Clemens, 2004; Barham, 2002; O'Connor and company, 2005; Rangnekar, 2004) that GIs do promote sustainable rural development.

GIs serve also as a marketing tool that can add economic value to agricultural products by conveying a cultural identity using the region of origin, acknowledging the value of specific human skills and natural resources in the production process, and creating a unique identity for the products (Babcock and Clemens, 2004).

### **GIs as promoters of rural development**

Studies have shown that when the name of a product obtains a protection as a geographical indication, there is a positive socio-economic impact on local communities. This is because GIs:

- increase production, create local jobs and prevent rural exodus;
- help producers to obtain a premium price for their products in exchange for guarantees offered to consumers on production methods and quality;
- allow for a better redistribution of the added value in the production chain;
- bring value to the land of origin;
- have other indirect positive effects, such as on tourism (O'Connor and Company, 2005).

Chestnut and chestnut honeys in northern area of Albania are two potential GI products. *Chestnut*. The chestnut (*Castanea sativa* Miller.) production in northern Albania (Tropoja and Reçi regions) is one of the most important economic activities, providing good incomes for the local population, which is considered as the poorest areas in Albanian. On the other hand

many stories aspects are related with this specie and could be considered as a logo for both Reçi and Tropoja regions. There are a lot of traditional foods prepared by the chestnuts.

The forest stands are managed traditionally by the local population for timber production, fruit production, shelter and recreate properties (MADA). Chestnut stands are an important component of the Balkan Alps, which together with Spruce forests (*Picea excelsa* (Lam) Link.), Beech forests (*Fagus sylvatica* L.), Oaks and Hornbeam forests (traditionally managed mostly assilvo-pastoral systems), Mediterranean evergreen shrubs (dominated by Pomegranate-*Punicagranatum* L.) as well as alpine grass and dwarf vegetation, where Blueberry (*Vaccinium myrtillus* L.) takes place, but not only; represent a beautiful diversified landscape, much preferred for the tourists and high potential for the economic development and poverty eradication. Biological points of view, all the chestnut stands are natural or naturally regenerated, which locally isolated, represent, we think, a specific genetic patrimony. *Chestnut honey* is one of the most a favorite honey varieties. It is not just unique flavor, not very sweet and with an almost bitter aftertaste, that stimulates the taste bud that makes it so special. Chestnut honey is also one of the healthiest honeys. It is rich in, mineral salts and tannin, with a high proportion of fructose that resists crystallization and a relatively low acidity, dark in color, ranging from yellowish brown to almost black. Of all the varieties of honey, he has the most pronounced antimicrobial, antibacterial and antiseptic properties, and therefore applies not only inside but also outside in the treatment of wounds, ulcers and sore throat (MARDWA, 2012). Due to this characteristics chestnut honey is much requested and its price is higher than most of the other honey varieties. The chestnut honey produced in both regions (Tropoja and Reçi) is well known. Perceptions on chestnut and chestnut honey reputation and quality by the producers and consumers of these products have identified as potential for GI registration in Albania, which have been attributed to the geographical area where the products are produced and the initiatives by the stakeholders.

The honey has a unique taste and a white color which is attributed to specific floral plants where bees obtain their nectar (Blakeney et al., 2012). Apart from increasing monetary value and employment creation, this honey has promoted forest and biodiversity conservation through a number of programs that include reforestation degraded areas (Bainkong, 2014) for sustainable production.

### **Materials and Methods**

The study was conducted in northern area of Albania aiming to assess how production of the potential GI chestnut and chestnut honey can contribute to rural development of these areas (MADA, 2012).

In the framework of BiodivBalkan Project–Sustainable Rural Development, a comprehensive inventory of the various local traditional products suitable for GIs development scheme has been drawn up in 2013, through focused interviews with expert, farmers and other stakeholders related to the traditional products. Based on this inventory, a typology of stakeholders was prepared, comprising production practices and unique and typical characteristics associated to the local production. This typology has been used in gathering quantitative and qualitative data through structured interviews. Two questionnaires were designed and prepared.

A questionnaire was prepared with different sections aiming at identifying the characteristics of chestnut farms and production, chestnuts distribution and sale, technology used for production; problems faced by chestnut and chestnuts honey producing farms. The areas included in the study are Tropoja region and Malesia e Madhe region (Reç County). Face to face interview with representatives of two chestnut and chestnut honey producers association was conducted.

These areas have already seen the development of two GIs products (chestnut and chestnut honey), which are official registered at Patents and Marks Office in Albania in 2016 and their brand names are in use by their associations established in each areas.

The other questionnaire was used to assess the changes and implications of geographical indications in rural development of respective areas (MADA, 2016). Twenty-five interviews were conducted in both areas in late 2016, 11 stakeholders for each case study and a further 3 large retailers who were questioned about both products. The interviews for both case studies were chosen from almost the same list of stakeholders directly involved in producing and/or marketing of products.

The research method employed for this study was a qualitative research approach. The interviews were conducted to the primary producers, collectors, processors and enterprises. Than a comparison analysis of data between two periods, the inventory and data collected in 2013 and the data and results from interviews of 2016 was done.

The study identifies also predominantly indirect links between GIs and sustainable rural development (SRD), through economic and social benefits brought to rural areas by the GIs. This finding suggests that GIs are worthwhile for implementation in Albania as a rural development tool. In this paper are described main results on the chestnut and chestnut honey products, after their development as GIs product and their implications on economic, social and environment aspects.

### **Results and discussion**

Results from both questionnaires indicate that the GIs products (chestnut and chestnut honey) are considered as very important contributors to the yearly income of farming family. In general, all families interviewed admitted they are in better economic conditions after their chestnut and chesnut honey production was launched in market with a brand new name and with quality signs (GI indications).

The table below gives some information about the surface, number of trees, number of beehives and total production for both products, in two regions in two periods.

**Table 1: General situation of Chestnut and honey in Tropoja and Reçi.**

No	Description of products	Unit	2013		2016	
			Reçi Area	Tropoja Area	Reçi Area	Tropoja Area
<b>Chestnut</b>						
1	Total surface	ha	600	2000-2400	600	2000-2400
2	Total number of trees	no	33 000	188600	33 000	188600
3	Total chestnut production	tons	350	1500	500	1680
<b>Chestnut Honey</b>						
1	Number of Beekeepers	no	125	400	130	420
2	Number of Beehives	no	2500	6550	2650	7100
3	Total of Chestnut honey produced	tons	24	60	27	70

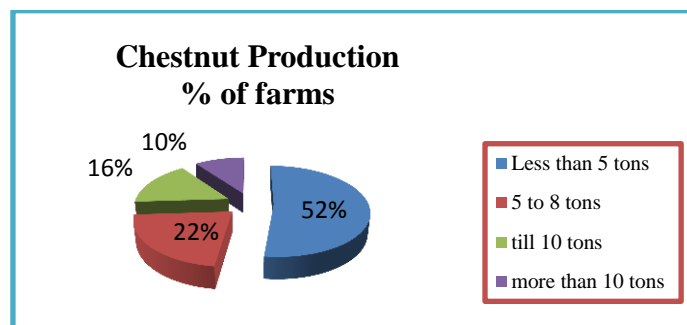
#### **Changes on productivity**

Compared with the productivity of 2013 the productivity of chestnut and chestnut honey is increased. The total chestnut production in Reçi area was increased by 150 tons, while in Tropoja area by 180 tons. The increase in production was due to more people were involved in harvesting of chestnuts.

The same increase was noticed in the productivity of chestnut honey. The quantity of chestnut honey produced in Tropoja area in 2016 was 10 tons higher than in 2013, while in Reçi was 3 tons higher 2016 compared with 2013.

Taking in account the total of chestnut production of two regions, the majority of farmers (52 %) produce less than 5 tons, about 22 % of farmers produce 5-8 tons, 16 % produce about 10 tons and 10 % of farmers produce more than 10 tons.

**Chart1. Structure of Chestnut production by farms**



### Prices

The chestnut prices have been increasing every year despite the production increase. Actually the price of fresh chestnut in both areas is almost the same. It varies from 100 ALL/kg to 130 ALL/kg and depends on the season. Compared to the 2013, the price of chestnut was increased by 20-30 ALL/kg.

The superior quality chestnut was sold in Reçi with 280 ALL/kg. From the data gathered, the price of Tropoja and Reçi chestnut is 20% higher than the chestnut coming from other regions of Albania, although the origin of the product sold in the market is not always clear.

Regarding chestnut honey, due to its higher antiseptic and antioxidant properties, it is considered as a natural medicament. These characteristics increase the price of chestnut honey which actually is almost 30% higher than the price of mixed flower honey.

Actually the price of 1 kg of chestnut honey is 1500-2000 ALL, which is triple higher compared to 2013. There is a high demand in the internal and international market for chestnut honey, which is promising for high prices even in the situation of a possible increase of the production. Since the price of the chestnut honey is very much related to its chemical and organo-leptical characteristics, an improvement in logo and labeling, where these characteristics are easily noticed by customers, has contributed in increasing the prices.

### Marketing channels

In 2013 the chestnut commercialization was not everywhere well organized. In most prominent chestnut production areas in Albania (Reç and Tropoja areas) there were collectors and wholesale traders that deal exclusively and continuously with fresh chestnuts, while in other areas commercialization was performed sporadically by traders that deal mainly with other agricultural products.

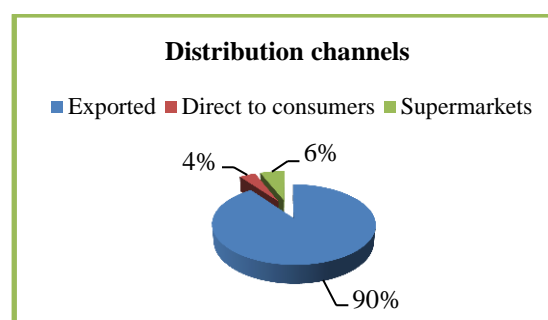
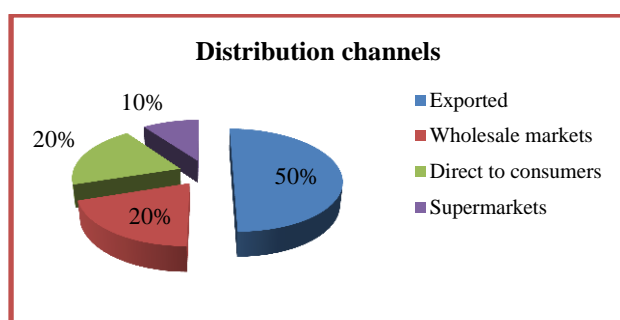
Based on the data of 2013, the most important chestnut collector and trader entity in Tropoja was “AMLA Company”. In 2013 “AMLA” has collected, processed and traded almost 500-600 tons of chestnut which was almost 45% of the total amount traded in the Tropoja area. The other chestnut percentage (65 %) was sold direct by producers to local shops or consumers.

Based on the data of 2016 the structure of marketing has changes. A high quantity of chestnut was exported in Kosovo. The price was decided through negotiations between the farmers and traders. The price of the chestnut was around 100-120 ALL/ kg. Since there is no selecting process, the price is unique for whole production quantity. It changes only according to the season. At the beginning of the harvestin period it is higher and it falls to 100 ALL/kg in November-December.

During the last year, 50% of chestnut produced in Tropoja has been exported to Kosovo. Due to the short distance many farmers invented themselves as traders and started to export chestnuts. These traders sell the collected product also in the local market, mainly in Tirana and Shkodra. Based on the assessment made by the Project, small traders collected last year almost 1500 tons, half of it was sold in Kosovo and half in the internal market.

The main chestnut trader's entity is the Cooperative “**Reçi Prodhimtar**”. They sold last year more than 500 tons of chestnut. Almost 90% of the product was exported. The largest quantity is exported in Italy, where the cooperative has established good business linkages. Smaller volumes of the product are sold to Kosovo traders. The main Albanian market is the area between Tirana and Durrës, but part of the product is sold also in Shkodra and other Albanian important cities.

**Chart2. Main distribution channels -Tropoja**    **Chart3. Distribution channels -Reçi region**



Compared to some other fruits and agriculture products, producers of chestnut do not have problems with the chestnut sale. Since there is no selecting process and standardization of the product, the price is unique for whole production quantity. It changes only according to the season.

The marketing of chestnut honey in general and in particular in Tropoja and Reçi village is moderately organized. Each beekeeper sells its own honey to occasional buyers or different mediators. No defined marketing channels exist or are used for honey. Since the chestnut honey product has a logo and label the price increased and no market problems were faced. In fact the demand for this product is high. For this reason the producers have not yet face any difficulties in marketing it.

### Incomes

Most of the chestnut and chestnut honey producers confirmed that their incomes by both products have been increased during 3 last years. Based on their responses their incomes have been increase by about 30-35 %.

They admitted that the biggest incremental income share is dedicated to the increase in chestnut production, considering two reasons, productivity and prices increase.

### Conclusions

Literature indicates many positive effects of GIs on sustainable rural development, very simply these can be categorized into ecological, economic and social effects. The two products investigated do not have profound direct links to all of these elements, however many indirect links were found. The Geographical Indications evaluated were least strongly tied to ecological benefits, with stronger ties to economic and social values.

The rural development of the Northern Albania can be improved through the creation of value added marketing channels for typical products, and GIs are a possible means towards that and where products have particularities and a preferential position in markets.

Both products have: (i) better price in the market compared with similar production produced in the other areas of the country; (ii) their specificities and characteristics have strong links with their geographical area (territory); (iii) there is a high demand for these products in the domestic and regional markets; (v) these products have a strong link with biodiversity.

In both areas the local stakeholders (farmers, processors and traders) have a satisfactory level of organization, which should be strengthened. “Reçi Prodhimtar” and “AMLA Company” are two structures that can keep around them most of the farmers engaged in this sector. On the other hand there is willingness for collaboration between the local actors.

There is enough evidence to show that the GIs investigated in this study are linked to more than just economic benefits and are therefore trending toward Sustainable Rural Development; however these links alone are not strong enough to say that GIs promote sustainable rural development. A promising finding of the study was that although many of the links between the GIs investigated and Sustainable Rural Development were indirect all stakeholders agreed that GIs promote Sustainable Rural Development.

Protection of GIs could help to sustain economic activities and settlement in rural areas and increase the life standards of the residents. Rural population is the prime beneficiaries of these kinds of products in terms of income and employment generation. Moreover, under an effective protection and marketing process, the economic activities in rural areas could increase further not only by the growth of GI production but also by developments in the other sector as well. While it is hard to obtain a competitive advantage based on technology in rural areas and that advertisement costs are high for the local producers, GIs provide important alternative advantages for the rural development by sending direct signal to the consumer that the product is originated from a specific region with a certain quality not requiring big investments on technology and advertisement.

### **Acknowledgements**

This study was prepared under the BiodivBalkan Project – sustainable rural development of Balkan Mountain areas.

The idea was to produce an inventory of the products arising from the biodiversity of the Northern Albanian Mountains and study the commodity chains for these products. The chestnut and chestnut honey products were pre-selected as two potential products, whose characteristics and their quality is so linked with their territory. An additional objective was to have the analysis of changes and improvements after the development of two GIs products, focusing on their economic, social and ecological effects.

### **References**

- Babcock, B. (2003): Geographical Indications, Property Rights, and Value-Added Agriculture. (IAR 9:4:1-3).
- Babcock, B. and Clements, R. (2004): Geographical indications and property rights: protecting value-added agricultural products, MATRIC Briefing Paper 04-MBP 7.
- Barham, E. (2002): Towards a Theory of Value-Based Labeling. Agriculture and Human Values. 19(4): 349-360.
- Barham, E. (2003): Translating Terroir: The Global Challenge of French AOC Labeling. Journal of Rural Studies. 19: 127-138
- Bérard, L., Marchenay, P., (2006). Local products and geographical indications: taking account of local knowledge and biodiversity. Int. Soc. Sci. J. 187, 109–116, 58.



- Bramley, C. and E. Biénabe. (2013). Guidelines for Selecting Successful GI Products. p. 123-136.
- Giovannucci, D., Josling, T., Kerr, W., O'Connor, B. and Yeung, M.T. (2009). Guide to geographical Indications. Linking products and their origins. International Trade Centre. Geneva
- Larson Guerra, J. (2004). Geographical indications and biodiversity: bridges joining distant territories. *Bridges* 8(2), 17–18.
- Ministry of Agriculture Rural Development and Water Administration (MARDWA). Agriculture statistics for the year 2012. ([http://www.bujqesia.gov.al/files/pages\\_files/14-02-25-01-33-30Statistikat\\_e\\_Vitit\\_2012.pdf](http://www.bujqesia.gov.al/files/pages_files/14-02-25-01-33-30Statistikat_e_Vitit_2012.pdf)).
- Mountain Areas Development Agency (MADA): National Study on Actual Situation and perspective of nut trees (walnut, chestnut, hazelnut, almond) and pomegranate development in Albania (2012), p.38-39.
- O'Connor and Company (2005): Geographical Indications and the challenges for ACP countries, A discussion paper, Agritrade, April 2005.
- Rangnekar, D. (2004): The Socio-Economics of Geographical Indications, UNCTADICTSD Project on IPRs and Sustainable Development, Issue Paper No. 8
- Vandecandelaere, E., F. Arfini, G. Belletti and A. Marescotti (eds.) (2010). Linking people, places and products: A guide for promoting quality linked to geographical origin and sustainable geographical indications. 2nd ed. FAO and SINER-GI, Rome.

## **GREEN INTERNET OF THINGS AND GREEN NANOTECHNOLOGY ROLE IN REALIZING SMART AND SUSTAINABLE AGRICULTURE**

Mirjana MAKSIMOVIĆ<sup>1\*</sup>, Enisa OMANOVIĆ-MIKLIČANIN<sup>2</sup>

<sup>1</sup>Faculty of Electrical Engineering, University of East Sarajevo, East Sarajevo, Bosnia and Herzegovina

<sup>2</sup>Faculty of Agriculture and Food Sciences, University of Sarajevo, Sarajevo, Bosnia and Herzegovina

\*Corresponding author: mirjana@etf.unssa.rs.ba

### **Abstract**

The application of Information and Communication Technology (ICT) advances in agriculture has completely revolutionized this sector. Unfortunately, alongside numerous advantages such as increased agriculture productivity and profit, the ICT has many disadvantages. ICT can harm the land, biodiversity and water sources and it can generate significant amounts of greenhouse gas (GHG) emissions. Therefore, the current research is being focused on finding novel approaches which will increase productivity in the agriculture sector with no or minimum impact on the environment and human health. Novel technological approaches, Green Internet of Things (G-IoT) and Green nanotechnology appear as the adequate solutions to create smart and sustainable agriculture and food industry. Production automation, precision farming, remote monitoring, traceability, decision making and forecasting, promise to completely transform agriculture and the food supply chain. Green nanotechnology brings more efficient use of agrochemicals and more advanced food production processes. More productive, sustainable and precise agriculture practices and enhanced food production will lead to increased productivity and profit while at the same time the usage of raw and non-renewable resources will be reduced. This will be accompanied by decreased pollution and emissions what will lead to the realization of smart and sustainable agriculture. Hence, this paper represents an analysis of G-IoT and Green nanotechnology concepts and their role in revolutionizing agriculture sector accompanied with eliminated or minimized negative influence on human health and environment. The realization of smart and sustainable agriculture will substantially provide significant economic and social benefits.

**Keywords:** *G-IoT, Green nanotechnology, Sustainable agriculture, Food, Environment.*

### **Introduction**

Technological achievements in recent years have significant influence to every facet of peoples' lives. Numerous sectors have been dramatically transformed and like many other sectors, agriculture didn't remain immune to novel technological advances and results. Only revolutionizing agriculture can satisfy an increase in agriculture demands followed by continuous population growth. Opara (2004) has identified a technology triad (biotechnology, ICT (Information and Communication Technology), and nanotechnology) that has the potential to revolutionize agriculture in the 21<sup>st</sup> Century.

Since its appearance, the Internet of Things (IoT) as the global network of interconnected smart things/devices, has been implemented in agriculture for monitoring soil, plants, animals, food supply chain, greenhouse gasses (GHG), etc. (Patil et al., 2012). The automation of production, cultivation factors, and inputs, precision farming, logistics, traceability, remote monitoring, decision making, forecasts, etc., are the main benefits that

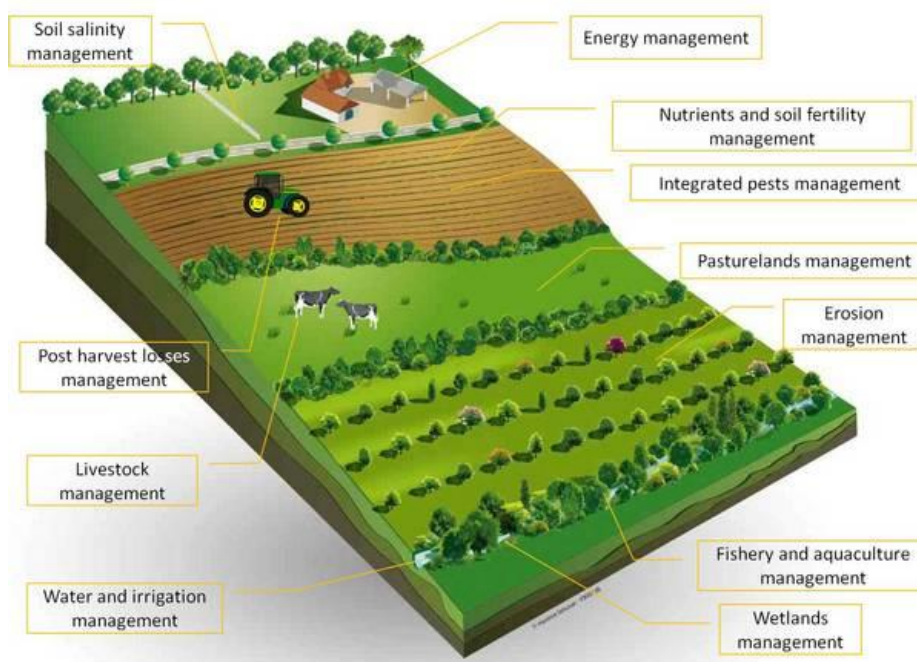
IoT brings in agriculture towards achieving sustainable agriculture (Fig. 1) (Maksimovic, 2018; FAO, n.d.). At the same time, nanotechnology, as a research area that covers a wide scope of technologies carried out on the nanometer scale, is becoming increasingly important for the agricultural sector (Manjunatha, 2016). It has already shown its huge potential in crop production, soil improvements, diagnostic, plant breeding, etc.

Despite the numerous benefits technological innovations bring, the consequences of their utilization are more waste, increased GHG emissions and/or the consumption of natural and non-renewable raw materials what may have negative effects on human health and the environment (Maksimovic, 2018). Therefore, to move towards sustainable development and sustainable place for living, it is demanded to reduce the technology's negative influences. The solution is seen in green technologies, Green IoT and Green nanotechnology particularly. The implementation of

- green design (designing energy efficient and environmentally aware products/devices),
- green manufacturing (products/devices production with minimal or no impact on the environment),
- green use (reducing energy and other resources utilization and products/devices applications in an eco-friendly way),
- green communication (reasonably priced, low-power, long-range communications), and
- green disposal (reliable, low cost, reusing, recycling),

will significantly contribute to achieving the full potential of technological progress in revolutionizing agriculture alongside reduced negative impact on the environment and human health (Nandyala and Kim, 2016).

Therefore, this paper represents a study of G-IoT and Green nanotechnology's role in achieving smart and sustainable agriculture.



**Figure 1.** Sustainable agriculture platform (FAO, n.d.)

### **G-IoT supported agriculture**

Recognizing that the agriculture is fundamental to economic development and environmental sustainability, the research interest to improve the agriculture sector is more than justified. The result of technology involved in agriculture is the development of smart, efficient and sustainable agriculture, where the balance between increased agricultural productivity and environmental impacts is mandatory. The IoT implementation in agriculture is based on utilization of a large number of diverse sensors and Wireless Sensor Networks (WSN) that are able to measure the parameters of interests (e.g. temperature, humidity, pressure, gas concentrations, etc.). With the help of RFID (Radio Frequency Identification) tags and GPS (Global Positioning System), food products can be located and tracked from farm to fork. After the measuring and collecting data on a real-time basis at the sensing layer of IoT, the information is being transmitted further for analysis and storage. The implementation of Cloud or Fog computing enables easier handling and processing diverse and voluminous data. The data procession is essential for obtaining valuable insights and knowledge demanded to make appropriate decisions, forecasting, performing adequate actions and developing an extraordinary predictive business model on different agriculture sectors (Balamurugan et al., 2016). As can be seen, the IoT utilization in agriculture enables remote and real-time monitoring of various elements (soil, plant, food products, etc.) and making appropriate actions regarding soil improvements, plant breeding, pesticide control, diagnostic, food packaging, traceability and safety, animal feeding, and so on. In other words, technologies like sensor-based, satellite remote sensing, WSN, RFID, GPS, GIS (Geographical Information Systems), advanced data analytics and smart information platforms significantly contribute to more efficient and effective farming practices and therefore contribute to associated environmental and social benefits (Sarni et al., 2016). According to Beecham Research (2015), the IoT with new techniques holds the potential to increase agricultural productivity of 70% by 2050. The inclusion of G-IoT will significantly contribute to these anticipated achievements, by revolutionizing whole agriculture sector and the food supply chain through more productive, sustainable and precise agriculture practices. The benefits of G-IoT application in agriculture are better management of soil fertility, more effective utilization of water and fertilizers, pesticides, and herbicides, crop and livestock diversification as well as appropriate farm automated machinery (Maksimovic, 2018). In this way, the G-IoT significantly reduces the negative influence on the environment successfully dealing with the climate change that represents the biggest issue in agricultural paradigm (Nida et al., 2015).

The main benefits of G-IoT inclusion in agriculture can be summarized into (Patil et al., 2012; Nida et al., 2015):

- The remote and real-time monitoring and enhanced utilization of inputs (soil, water, fertilizers, pesticides, etc.) as well as monitoring of animal health,
- Decreased production costs,
- Increased profitability, new financial opportunities, and development,
- Sustainability,
- Improved food safety,
- Environmental protection.

Evidently, G-IoT inclusion in agriculture enhances productivity, energy and resource efficiency while at the same time reduces waste and contamination. As agriculture covers a range of sources (and some sinks) of GHG, it is forecasted that through the implementation of smart agriculture, 2 Gt CO<sub>2</sub> (carbon dioxide) equivalent emissions per year could be averted by 2030 alongside 16% of global hazardous emissions reduction. Smart agriculture also provides substantial economic and social benefits, and G-IoT represents an important support for the realization of high-quality, high-efficiency, intensive, safe, and environmentally aware agriculture (Bo and Wang, 2011). It is anticipated that through intelligent detection,

cultivation control and precise irrigation in agriculture, by 2030 1 billion MW of energy will be saved, 897 average kg/Ha of land yield will increase, while cost-savings through reduced water use could amount up to \$110 billion. Additional revenues to companies across the sector are expected to reach \$2 billion (GeSi, 2015).

### **Green nanotechnology role in agriculture**

Nanotechnology and nanomaterials in agriculture aim to reduce the amount of sprayed chemicals by smart delivery of active ingredients, minimize nutrient losses in fertilization and increase yields through optimized water and nutrient management. Devices based on nanotechnology are being explored in the field of plant breeding and genetic transformation. Based on traditionally harvested materials (e.g. wheat straw and soy hulls) bio-nanocomposites with enhanced physical-mechanical properties can be produced for bio-industrial purposes (Parisi et al., 2015).

The most relevant agricultural nanotechnology applications are (Parisi et al., 2015):

- Crop production: Plant protection products and fertilizers belong to this group. Nanocapsules, nanoparticles, nanoemulsions and viral capsids are main plant production products and fertilizers based on nanotechnology. They are used as smart delivery systems of active ingredients for disease and pest control in plants or for the delivery of nutrients to plants. Nanofertilizers have broad application today. The main representatives are nitrogen fertilizers, potash fertilizers, nanoporous zeolite, zinc nanofertilizer, nanoherbicide, nanopesticide (Rameshaiah et al., 2015).
- Soil improvement: Nanomaterials can be applied in water/liquid retention. Some examples of the application are zeolites and nanoclays used for water or liquid agrochemicals retention in the soil for their slow release to the plants; nanoclays can be used as filters for removal of variety of toxic substances from the environment.
- Water purification and pollutant remediation: Nanomaterials, nanoclays can be used as filters for removal of variety of toxic substances from the environment.
- Diagnostic: Nanosensors as highly sensitive bio-chemical sensors can be implemented for monitoring environmental conditions, plant health and growth (e.g. nanofibers, fullerenes, electrochemically active carbon, nanoaptamers, wireless sensors, smart dust technology) (Rameshaiah et al., 2015).
- Plant breeding: Nanomaterials can be used as carriers of DNA (deoxyribonucleic acid) or RNA (ribonucleic acid) for their delivery to plant cells, for their genetic transformation or to trigger defence responses, activated by pathogens.
- Nanomaterials from a plant: Nanomaterials can be produced from engineered plants or microbes and through the processing of agricultural products waste.

The main goal of the application of green nanomaterials in modern agriculture is to decrease usage of environmentally harmful inputs, reduce losses of costly fertilization, increase inputs use efficiency and yields through need-based management. Green nanomaterials are materials synthesized based on environment-friendly principles. These materials play a key role to minimize GHG emission to the atmosphere, a particularly significant decrease in releases amounts of CO<sub>2</sub>, N<sub>2</sub>O (nitrous oxide), and CH<sub>4</sub> (methane) from the agriculture field. Furthermore, green nanomaterials minimize the troubles in agricultural practices concern to the human health and environment under a changing climate, increase food and nutritional security, and agricultural productivity as required to rapidly increasing global population (Ashoka et al., 2017).

In summary, the main features of Green nanotechnology concept are safe and energy efficient products and processes, reduced waste, lessen GHG emissions and usages of renewable materials (Maksimović and Omanović-Miklićanin, 2017). A symbiotic approach of G-IoT

and Green nanotechnology refers to Green Internet of Nano Things (G-IoNT), which holds a potential to make a whole world of remarkable improvements in the agriculture sector. Green nanoparticles, nanosensors, nanorobots and other green nanodevices connected in green nanonetworks via G-IoNT, create a completely new environment for the revolutionizing agriculture and food industry in 21<sup>st</sup> Century.

### **Conclusions**

Agriculture sector and food industry are facing today the great challenges due to a growing global population and climate change. Thus, application of nanotechnologies and IoT in this sector can greatly contribute to address the issue of sustainability. However, as with the application of all new technologies, there is the need to perform a reliable risk-benefit assessment, as well as a full cost accounting evaluation.

Application of nanotechnologies and IoT in agriculture and food industry has disadvantages such as potential harmful influence on the land, biodiversity and water sources and increased amounts of GHG emissions. Therefore, novel technological approaches, G-IoT and Green nanotechnology were developed as the adequate solutions for smart and sustainable agriculture and food industry. The benefits of G-IoT application in agriculture are better management of soil fertility, more effective utilization of water and fertilizers, pesticides, and herbicides, crop and livestock diversification as well as appropriate farm automated machinery which at the end leads to significant reduction of the negative influence of IoT on the environment successfully dealing with the climate change that represents the biggest issue in agricultural paradigm. On the other side, Green nanotechnology plays a key role to minimize GHG emission to the atmosphere, to minimize the troubles in agricultural practices concern to the human health and environment under a changing climate and increase food and nutritional security. G-IoT and Green nanotechnology together create G-IoNT that will significantly contribute to the revolutionizing agriculture practices and techniques, making agriculture sector and food industry more efficient, safe and sustainable as never before.

### **References**

- Ashoka P., Meena R. S., Gogoi N., and Kumar S. (2017). Green Nanotechnology is a Key for Eco-friendly Agriculture, *Journal of Cleaner Production*, Vol. 142, Part 4.
- Balamurugan S. et al. (2016). Internet of Agriculture: Applying IoT to Improve Food and Farming Technology. *International Research Journal of Engineering and Technology*, Vol. 03, Issue: 10.
- Beecham Research (2015). Towards smart farming: Agriculture embracing the IoT vision, [Online]: [www.beechamresearch.com/download.aspx?id=40](http://www.beechamresearch.com/download.aspx?id=40) Accessed: 1.6.2017.
- Bo Y. and Wang H. (2011). The Application of Cloud Computing and the Internet of Things in Agriculture and Forestry. *International Joint Conference on Service Sciences*. pp. 168-172.
- FAO (n.d.) Towards a sustainable agriculture platform in partnership with farmers' cooperatives and organizations. Food and Agriculture Organization of the United Nations. [Online]: <http://www.fao.org/tc/exact/sustainable-agriculture-platform-pilot-website/en/> Accessed on 10.5.2017.
- GeSi (2015). #SMARTer2030-ICT Solutions for 21<sup>st</sup> Century Challenges. Global e-Sustainability Initiative (GeSI), Brussels, Belgium. [Online]: [http://smarter2030.gesi.org/downloads/Full\\_report.pdf](http://smarter2030.gesi.org/downloads/Full_report.pdf) Accessed on 20.5.2017.

- Maksimović M. and Omanović-Miklićanin O. (2017). Towards green nanotechnology: maximizing benefits and minimizing harm. In: Badnjevic A. (eds) CMBEBIH 2017. IFMBE Proceedings, vol 62. Springer, Singapore, pp.164-170.
- Maksimovic M. (2018). Greening the future: Green Internet of Things (G-IoT) as a key technological enabler of sustainable development. In: Dey N., Hassanien A., Bhatt C., Ashour A., Satapathy S. (eds) Internet of Things and Big Data Analytics Toward Next-Generation Intelligence. Studies in Big Data, vol 30. Springer, Cham, pp. 283-313.
- Manjunatha S.B., Biradar D.P. and Aladakatti Y.R. (2016). Nanotechnology and its applications in agriculture: A review. *J. Farm Sci.*, 29(1): (1-13).
- Nandyala C.S. and Kim H.-K. (2016). Green IoT Agriculture and Healthcare Application (GAHA). *International Journal of Smart Home*, Vol. 10, No. 4, pp. 289-300.
- Nida M., Khan I.U. and Alam S, M. K. (2015). Towards Smart Agriculture: An Introduction. In: ur Rehman A. (eds.) *Smart Agriculture: An Approach towards Better Agriculture Management*. OMICS Group eBooks, USA.
- Opara L. (2004). Emerging Technological Innovation Triad for Smart Agriculture in the 21<sup>st</sup> Century. Part I. Prospects and Impacts of Nanotechnology in Agriculture. *Agricultural Engineering International: the CIGR Journal of Scientific Research and Development*. Invited Overview Paper. Vol. VI.
- Parisi C., Vigani M. and Rodríguez-Cerezo M. (2015). Agricultural Nanotechnologies: What are the current possibilities? *Nano Today* (2015)10, pp. 124-127.
- Patil V.C., Al-Gaadi K.A., Biradar D.P. and Rangaswamy N. (2012). Internet of Things (IoT) and Cloud Computing for agriculture: An Overview. *Agriculture 2012 (AIPA 2012)*, pp. 292-297.
- Rameshaiah G.N., Pallavi J. and Shabnam S. (2015). Nano Fertilizers and Nano Sensors – an Attempt for developing Smart Agriculture, *J. S. International Journal of Engineering Research and General Science*, 3(1).
- Sarni W., Mariani J. and Kaji J. (2016). From Dirt to Data - The second green revolution and the Internet of Things. *Deloitte Review*.

## **CURRENT FUNDING SOURCES FOR AGRICULTURE IN THE ENTITY OF REPUBLIC OF SRPSKA (BOSNIA AND HERZEGOVINA)**

Radomir BODIROGA<sup>\*</sup>, Grujica VICO, Goran PERKOVIC

Faculty of Agriculture, University of East Sarajevo, Republic of Srpska, Bosnia and Herzegovina

<sup>\*</sup>Corresponding author: radomir.bodiroga@gmail.com

### **Abstract**

Fulfilling the needs of business entities with the basic activities in the field of agriculture certainly implies securing a sufficient amount of funds in both quantitative and qualitative terms. For the agrarian sector financing is one of the limiting factors and for this reason in the paper we analysed the current funding modalities of agriculture in the Entity of Republic of Srpska (Bosnia and Herzegovina) and pointed to their specificities, advantages and disadvantages. The results indicate that there are four most important modalities that are present individually or in combination with a different participation in the total financial system (self-financing, state-supported financing, financing by the loans from the commercial banks and financing through donations) as well as the importance of development of potential modalities and those which still do not have a significant share in the financing (foreign direct investments (FDI), securities, and concessions).

**Keywords:** *Financing of agriculture, sources of funding agriculture*

### **Introduction**

In the literature it has often been emphasized the importance of the agrarian sector as the sector of high priority for the development of the national economy. One of the basic constraining factors of its development is a lack of effective funding sources, which is essential both for the procurement of the necessary equipment and machinery, and purchase of the land, as well as the construction of transport and communal infrastructure, and also the creation of other necessary conditions for unimpeded manufacture in rural areas. For the economical and profitable business operations of commercial entities, with agriculture as its primary occupation, it is necessary to provide the financial resources to match their needs both in quantitative and qualitative terms. Accordingly, an adequate funding source is a source that places assets to a longer repayment period without demanding collaterals. Financing of agriculture should take into account biological specificities and socio-economic conditions for the development of agriculture in certain countries (Radovic, 2015). Due to the specificity of agricultural production and the low level of reproductive capacity, external sources of financing are often necessary for investments in agriculture (Ramic and Vasiljevic, 2009). In this paper, current modalities for funding of the agriculture of the Republic of Srpska have been analysed and its specifics, advantages and disadvantages have been indicated.

### **Material and methods**

The data on which the study on current funding modalities of the agriculture of the Republic of Srpska is based were collected from the secondary sources published by the relevant public and private institutions. To the study of the aforementioned documents and databases as well



as other used literature the analytical method was applied, along with the method of synthesis and the historical and comparative method. The analytical method was intended to parse the complex terms to easier whereas the method of synthesis led to the conclusion about certain modalities by connecting up the elements into the logical whole. Historical method was used to perceive the changes in the level of the agrarian budget and in its share in the total budget of the Republic of Srpska. In order to achieve the simplicity and neatness, the results are shown graphically.

### **Current modalities for funding of the agriculture**

During the present period in the Republic of Srpska, the following modalities for funding of the agriculture with different contributions, either individually or in combination, were present:

- Self-financing
- State-supported financing
- Financing by the loans from the commercial banks
- Financing through donations

Certainly, self-financing is one of the most common modalities used by the business entities of the Republic of Srpska who have agriculture as their main activity. It is a stable, easily accessible and safe method of financing which implies the use of manufacturers' own funds (Vasiljevic and Sevarlic, 2005). The reasons for high representation of this model lie in low costs of capital usage, poor access to other available modalities, the manufacturer's distrust, or the low level of information about other available modalities, etc. However, in the literature this mode of funding is not considered to be free of charge, and its costs are expressed as the loss of profit which could have been achieved by investing in more profitable project. The advantage of the use of one's own funding sources is in the financial stability of the commercial entity (Radovic, 2015).

The loans from the commercial banks are often to be used as one of many possible funding sources of agriculture. Both the interest to be paid for the use of the loan as well as the means used as the collaterals are different depending on whether the borrowed funds are to be used in the short, medium, or long term. Immovable property on the estate, movable property, various forms of guarantees, etc can be used as collaterals. This is also the main concern of agricultural manufacturers in the Republic of Srpska who use this model of funding: How to solve the problem of adequate collateral? In this case, the land wins the position of the best collateral because it is an indestructible and fixed asset owned by majority of agricultural manufacturers. However, commercial banks are rarely interested in accepting this form of collateral mostly because of unresolved ownership relations and the absence of an adequate register of land plots. When it comes to the issue of collaterals one of the possible solutions may be in the use of guarantees from the Guarantee Fund of the Republic of Srpska.

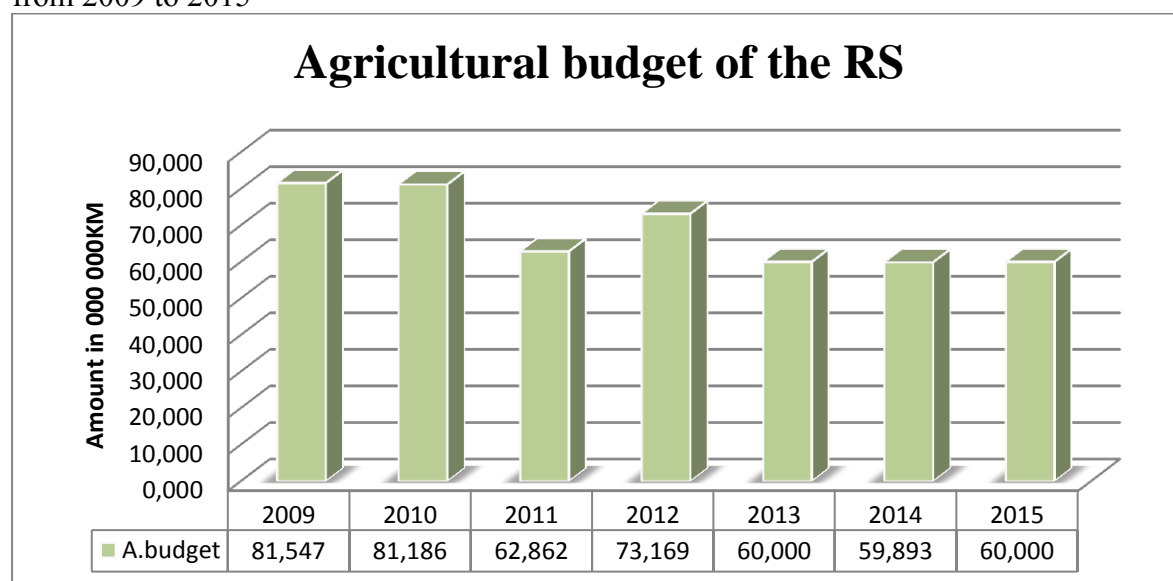
Guarantee Fund of the Republic of Srpska is an institution which has for its main objective supporting entrepreneurship through issuance of various types of guarantees for ensuring liabilities or other financial obligations between entrepreneurs on the one side, and bank or other financial institution on the other. The users of guarantees can be any individual or legal entities headquartered in the Republic of Srpska, and from the agrarian field in APIF (IT and Financial Sources' Brokerage Agency) registered agricultural estates, and legal entities dealing with the production and refining in the fields of agriculture and fishery.

State support is considered to be one of the most important modalities of financing of agriculture and rural development of the Republic of Srpska. Thanks to this funding source,

projects of construction of transport and communal infrastructure, telephone lines, and the like, as well as the different types of granted support (premiums, allowances, subsidies, compensations, etc) that participate in co-financing of agricultural production of the registered agricultural estates are funded, either partially or completely.

The agricultural budget is the main source of support by the Republic of Srpska for the development of agricultural production through various forms of incentives. The agricultural budget is managed by the Ministry of Agriculture, Forestry and Water Management of the Republic of Srpska through the Agency of Agricultural Payments of the Republic of Srpska. Level of the agricultural budget in the period from 2009 to 2015 is given in the following chart:

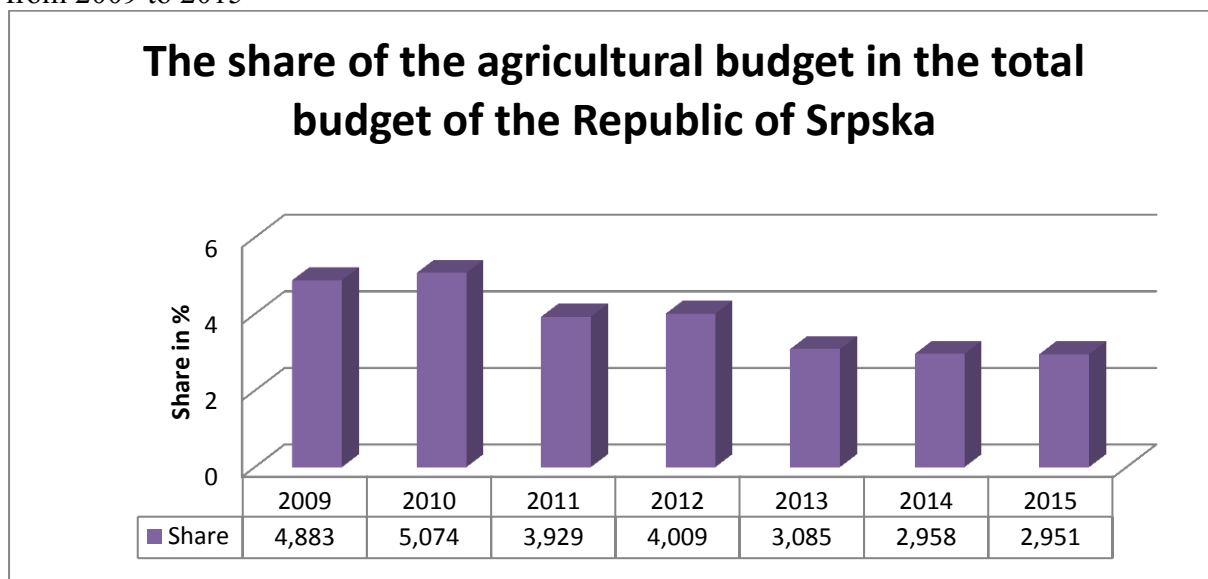
Chart 1: The level of the agricultural budget of the Republic of Srpska (RS) in the period from 2009 to 2015



Source: The annual report from the agriculture, food and rural development of Bosnia and Herzegovina in 2015

From the chart it can be seen that the Republic of Srpska has a modest agricultural budget to support agriculture and rural development. In addition to the modest budget, there is an evident decline in allocation of funds compared to that in 2009. The height of the agricultural budget accompanied by occasional oscillations gradually declined in the period from 2009 to 2013, and has remained at that level until the year of 2015. During the period, the maximum height of the agricultural budget was achieved in 2009 in the amount of 81.547.000 KM while at the end of the reporting period the budget was reduced by about 20 million KM. The share of the agricultural budget in the total budget of the Republic of Srpska has varied during the period from 2,951% to 5,074%, as can be seen in the following chart.

Chart 2: The share of the agricultural budget in the total budget of the Republic of Srpska from 2009 to 2015



*Data source: The annual report from the agriculture food and rural development of Bosnia and Herzegovina in 2015, author's calculation*

The maximum share was achieved in 2010 while the minimum value was recorded at the end of the period, ie in 2015. Recommendation of the Agricultural Development Strategy 2009-2015 was that the share of agricultural in total budget of the Republic of Srpska increases and stabilizes at 6% share during the first three years, and then increases to 8% and to remain thus by the end of the 2015. Also, by the changes of the Law of Provision and Allocation of Funds for Agricultural and Rural Development in 2009, the share of the agrarian in the total budget was planned to be of at least 6%. According to the chart, however, it is evident that the proposed recommendations were not implemented. It is also important to mention that the specific provisions suggested by the Agricultural Development Strategy were entirely omitted. The Government suggests that the results of this decision and implemented support are the problems with the funding of the budget that affected the total amount of funds allocated for the agriculture.

The Investment and Development Bank is in the 100% ownership by the Republic of Srpska from 2006 and its primary purpose is to support the development and encourage investments in the Republic of Srpska. The IDB supports financially various forms of projects of which the agricultural loans, loans for micro-business in agriculture, and grants for primary development projects in the municipalities of the Republic of Srpska are of great importance. Agricultural loans are intended for legal entities and entrepreneurs for the acquisition of fixed assets and working capital, refinancing, or paying taxes in the field of production and refining in agriculture and fishery.

Loans for micro-business in agriculture are intended for agricultural estates that are registered as legal entities or individuals for the purpose of acquisition of fixed assets and working capital.

Grants for primary development projects in the municipalities of the Republic of Srpska support projects which contribute to the realization of the third and fifth objective of the Agricultural Development Strategy of the Republic of Srpska for the period from 2016 – 2020 (Increase of the level of marketability and finalization of agricultural products and

integrated rural development).

The IDB loans in the Republic of Srpska are characterized by significantly more favourable interest rate in comparison with commercial loans, and the existence of privileged groups with the additional reduction of the rate (for projects implemented in less developed or extremely underdeveloped municipalities, for cluster members, short-term loans for processors, etc). All IDB loans are invested through financial intermediaries, ie commercial banks and microcredit organizations.

According to the reports from the IDB database of the Republic of Srpska, total amount of loans implemented by the end of 2016 for legal entities and individuals in the field of agricultural production and processing of the agricultural products reached 201.083.018,46 KM. Financing through donations involves the use of funds without the obligation to return them to the donor or to pay the costs of the use of the capital and interest rates. Funding source of this type usually comes from the state or other native or foreign donors (international organizations, non-government organizations, etc) in order to assist the recipient of the grant in specific areas of its activities. The Directorate for European Integration (for donors from the EU) and the Ministry of Finance and Treasury of Bosnia and Herzegovina (for other donors and international financial institutions) are in charge of the coordination with donors in the field of agriculture in the territory of Bosnia and Herzegovina.

According to the *Report of international support for agriculture, nutrition and rural development in 2015*, the group of active donors to agricultural sector of Bosnia and Herzegovina include: the European Union, Japan, the Netherlands, Sweden, Czech Republic, Germany, USA, Italy, Switzerland and the UN organizations (UNDP and FAO). The aforementioned donors actively participate in strengthening the competitiveness of the agricultural sector, convergence of legal regulations with the EU, improving economic integration with the EU, etc.

It is important to add that a significant number of EU member states provide individual assistance to given agricultural sectors. However, despite the large number of donors, it is evident that this modality of financing has a potential for significantly higher utilization rate. Bosnia and Herzegovina, and therefore the Republic of Srpska, has no access to pre-accession programs offered by the European Union. Ever since 2008, the criteria were to be fulfilled in order to be able to use pre-accession funds of the European Union, and for the implementation of these all the necessary technical support was provided. The criteria were primarily concerned to establish adequate operational structures, and since they were not completed, the IPA2008, IPA2010 and further assistance for their implementation were suspended. In 2014, a IPAAII Strategy document for Bosnia and Herzegovina have been adopted by which support for agriculture and rural development was not provided. Currently, Bosnia and Herzegovina can use two types of assistance, ie assistance in transition and institutional development and cross border cooperation. These programs are intended to assist in cross-border cooperation between EU members and current and potential candidates (eg. Croatia – Bosnia and Herzegovina), as well as in cooperation between countries of current and potential candidates (eg. Bosnia and Herzegovina – Serbia).

Other modalities of financing of the agriculture that were present with a minimal participation in total financing involve foreign direct investments (FDI), securities, and concessions.

The importance of FDI is particularly evident in situations of insufficient national investments when they can have a positive impact on development in all sectors of economy. Therefore, this modality can play an important role in financing of agriculture of the Republic of Srpska.

When it comes to agriculture, the Republic of Srpska issues the concession to unexploited

agricultural land in the state ownership. Up to the 2015, concessions on agricultural land and water resources have been active in a total of 55 companies in the Republic of Srpska. The area of 17,164.155 ha was coneded to aforementioned customers to use<sup>10</sup>.

By the emission of securities it would also be possible to collect additional funds in priority sectors including agriculture, and use them to cover temporary budget deficites. The collected funds can be used for a variety of activities in order to improve the stability and the competitiveness of the agricultural sector.

### **Conclusion**

For cost-effective and profitable operations of economic entities, agriculture being their main economic activity, it is necessary to provide in time the financial resources to meet their needs both quantitatively and qualitatively. Resources of quality will take into account the biological and socio-economic specificities which make the agrarian sector more demanding for funding. In the recent period, self-financing was one of the most frequently used modalities, characterized by its insufficiency to meet the needs of modern agriculture. Additional funding sources included the use of loans from commercial banks, state support for agriculture, and international donations, while others sources were insufficiently represented. Among these sources, the lowest share was recorded by the commercial banks due to a number of characteristics which made this source of financing less competitive in comparison to other available modalities. In the following period, it is necessary to intensify efforts towards the elimination of all obstacles and strengthening the potential modalities that can play a key role in solving the problem of financing of the agriculture.

### **References**

- Radovic, G. (2015): Funding of rural tourism in the Republic of Serbia. PhD thesis, faculty of agriculture, Department of Agricultural Economics, Novi Sad.
- Ramic, E., Vasiljevic, Z. (2009): Financing of rural development and economic performances in rural areas of Bosnia and Herzegovina. *Economics of Agriculture*, Vol 56, no 1, pp 111-132
- Report of the Commission for concessions for 2015 (agricultural land - existing contracts). Available at <http://koncesije-rs.org>
- The Agricultural Development Strategy of the Republic of Srpska until 2015. Available at [www.vladars.net](http://www.vladars.net).
- The annual report from the agriculture nutrition and rural development of Bosnia and Herzegovina in 2015. Available at [www.mvteo.gov.ba](http://www.mvteo.gov.ba).
- The reports datebase of disbursed loans IRBRS. Available at <http://www.irbrs.net>.
- The report of international support for agriculture, nutrition and rural development in 2015 in BiH. Available at [www.mvteo.gov.ba](http://www.mvteo.gov.ba)
- Vasiljevic, Z., Sevarlic, M. (2005): New Modalities of Financing in Serbian Agrarian Economy. *Economics of Agriculture*, no 1, pp 25-42.

---

<sup>10</sup>Author's calculation based on the *Report of the Commission for concessions for 2015 (agricultural land - existing contracts)*

## **POTENTIAL AND INSUFFICIENTLY REPRESENTED MODALITIES FOR FINANCING OF AGRICULTURE IN THE ENTITY OF THE REPUBLIC OF SRPSKA (BOSNIA AND HERZEGOVINA)**

Radomir BODIROGA<sup>1\*</sup>, Grujica VICO<sup>1</sup>, Goran PERKOVIC<sup>1</sup>, Vladimir Vu. YUSHKOV<sup>2</sup>,  
Andrija TOMIC<sup>1</sup>

<sup>1</sup>Faculty of Agriculture, University of East Sarajevo, Republic of Srpska, Bosnia and Herzegovina

<sup>2</sup>Perm State Agricultural Academy, Russia

\*Corresponding author: radomir.bodiroga@gmail.com

### **Abstract**

In order to achieve an adequate business results in agricultural production, the primary task is to provide financial resources on time. This task is achieved through the development of various forms of financing agriculture. Current funding modalities that have a significant share in total financing are not sufficient to meet the needs of an agricultural producer. Accordingly, in the paper the potential and insufficiently represented modalities were analysed, the establishment and development of which would significantly improve the financing of the agrarian sector. The results of the survey indicate that the Agrarian Bank have not been established yet on the territory of the Republic of Srpska, and agriculture as a branch of economy is not an attractive sector for foreign direct investments, since their share in total foreign direct investments is only 1.60%. The securities market is not sufficiently developed, and only the Banja Luka Stock Exchange operates with them. A similar situation is with other analyzed modalities that exist but with insufficient participation in total financing of agricultural production.

**Keywords:** financing of agriculture, funding sources, Republic of Srpska, Bosnia and Herezgovina.

### **Introduction**

Agricultural production occupies a significant place in the economic structure of one country. The reason for this is in securing the employment of the population, significant share in gross domestic product (GDP), the main source of raw materials for industrial processing, and the like. The analysis of the state of agriculture of the Republic of Srpska (RS) indicates the necessity of replacing obsolete technology and equipment, improving the existing infrastructure of the agricultural sector, and modernizing all segments of agricultural production, which requires additional sources of its financing.

The importance of financing of agriculture and rural tourism is in timely provision of the necessary and adequate sources of financing for the purpose of realization of agricultural production, as well as the realization of economic and profitable business of economic entities (Radovic, 2015). When choosing adequate funding modalities, it is necessary to give priority to those who respect the biological and socio-economic specificities of this economic branch. Such a source will take into account the seasonal character of agricultural production, increased costs due to the impossibility of high specialization and high production risk, the influence that the size of the plots, the market situation, the state, the various associations and the like can have on financing.

In the recent period, on the territory of the RS, the most important sources in financing agriculture were the use of their own funds (self-financing), funds from state support, funds from international donations, and loans from commercial banks.

While drafting the paper attention is focused on potential modalities whose existence would significantly improve the financing of the agrarian sector, as well as the modalities with still insufficient participation in the financial structure. Financing of agricultural production is at this moment the most important problem of agricultural policy, starting from the fact that no economic activity can have good performance if the issue of its financing is not adequately solved (Curkovic, 2013).

### **Material and Methods**

In order to get to the basic conclusions on the problems of financing agriculture, a detailed and comprehensive analysis of relevant public and private publications on a given topic was carried out. The information obtained were synthesized into logical units that were used to make concrete conclusions. The graphic presentation sought to achieve the simplicity and transparency of research results. In order to gain insight into the dynamics and the amount of foreign direct investments, the historical method was applied, while the comparative method was used when comparing foreign direct investments in different sectors of the economy.

### **Results and Discussions**

The modalities that agricultural producers from the territory of the RS use to the fullest extent are important but not the only sources of financing the agriculture. The attention should certainly be focused on strengthening the modalities already present in the RS, but without significant participation, as well as the modalities that could be used to finance the agriculture in the coming period. Consequently, significant resources in the financing of the agrarian sector could be provided by using the following sources:

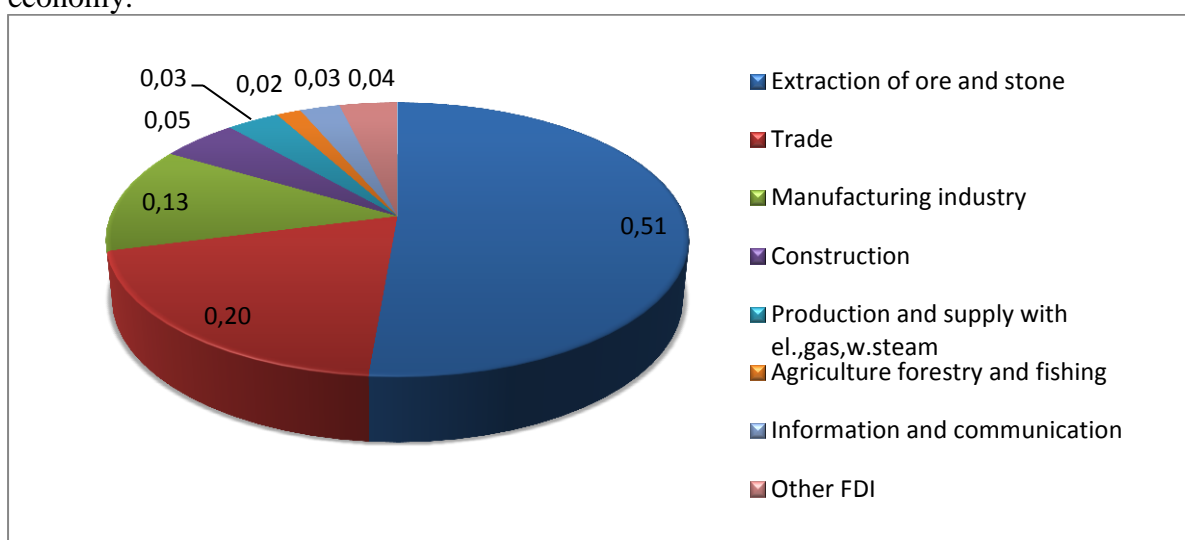
- Agrarian bank
- Foreign direct investments
- Joint ventures
- Leasing
- Securities
- Concessions
- Business angels

The establishment of a specialized **Agrarian Bank** would enable the concentration of funds for this purpose from various sources and their rational and efficient use for various purposes in primary agricultural production, processing of agricultural products, and multifunctional agriculture. The existence of a specialized agrarian bank would positively influence the development of the agrarian economy, and the development of the agrarian economy plays a key role in the overall economic development of the RS. The establishment of such a financial institution should be regulated by an adequate law that would specify the objectives of its business, the conditions under which loans, start-up capital and the like can be realized. The initial capital for the establishment of agrarian bank could be provided from different sources. (Radovic, 2015)

- Part of the funds of agrarian budget
- Funds of state financial institutions for agricultural loans
- Funds from the local self-government budget
- Funds from the lease of state agricultural land, etc.

In the previous period, there were initiatives by agricultural associations to establish an institution of this kind, which has not yet yielded results. The Ministry of Agriculture, Forestry and Water Management of the RS has reasons for failing to establish an agrarian bank in an insufficient amount of capital and the necessity of involvement of international institutions in the implementation of such a project.

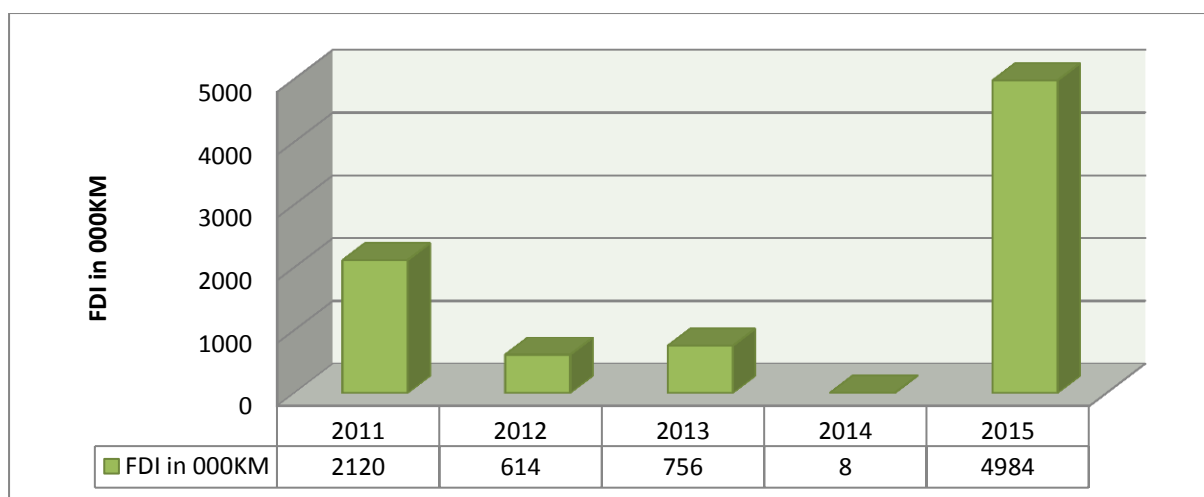
**Foreign direct investments (FDI)** differ from other foreign investments in the fact that they include only investments of foreign investors in the establishment or construction of a new company, or the purchase of shares i.e. ownership shares in already existing enterprises. FDI are a key developing factor in the modern economy, and with the trade, the most important means of business of the company, organization of production, supplying of goods and services on a global scale. (Velagic, 2011) In the period from 2006 to 2014, according to the data of the Central Bank of Bosnia and Herzegovina (BiH), the total FDI in the RS amounted to KM 4,158.1 million. Agriculture, however, as a branch of the economy is not an attractive sector for FDI. This is supported by data from commercial courts and Intermediary Agency for IT and financial services (APIF) on the participation of FDI in certain sectors of the economy.



Graph 3. Structure of FDI by sectors in the Republic of Srpska in the period 2011-2015  
 Source: Strategy for the Promotion of Foreign Investments in the RS from 2016 to 2020. Data from the Commercial Courts of RS and APIF

It is evident from the chart that the largest share in the total realized FDI have FDI from the field of mining and stone extraction, then from the field of trade, while the FDI realized in agriculture, fisheries and forestry in the total FDI in the RS is only 1.60%. The amount of total foreign investments in agriculture during the period from 2011 to 2015 is given in the following chart.





Graph 4. FDI in the period from 2011 to 2015 for agriculture, fisheries and forestry

Source: Strategy for the promotion of foreign investments in the RS from 2016 to 2020. Data from the Commercial Courts of RS and APIF.

The highest amount of FDI was realized during the observed period in 2015 in the amount of 4.984.000 KM, while in 2014 the minimum amount was 8.000 KM, which was certainly contributed by the weather in May of that year. Although the level of FDI in agriculture is low in comparison to other sectors, this sector of the economy has a number of comparative advantages that can stimulate potential foreign investors.

**Joint ventures** involve a time-limited form of association for the realization of a common project, after which the distribution of profits proportional to invested funds is made. It is realized through the cooperation of two partners on the principle of distribution of profits and coverage of losses proportional to invested capital. The main reason for such a form of cooperation between companies is the inability to finance independently a particular business venture.

Also, one of the priority objectives of the joint venture is to achieve a positive financial result that the partners would allocate in proportion to invested capital. The negative aspect of this form of cooperation can occur when partners have the same ownership over a joint project but cannot agree on important issues, while in the case of unequal participation in the project, a significantly higher risk is taken by a partner with a smaller share.

Recently, the Government of the RS has intensified efforts to find various foreign partners that would be interested in this kind of cooperation and investments in the agricultural sector.

**Leasing** represents a newer model of financing of investments that is widely used in developed market economies, but which has been expanding in developing countries in recent years (Vasiljevic and Sevarlic, 2005). Financing of agriculture through leasing allows agricultural producers to have for a subject to leasing a means of securing debt collection under a financial leasing agreement, i.e. that the costs of financing do not burden the costs of bank guarantees. (Radovic, 2015). This modality of financing is particularly suitable for agricultural enterprises that are unable to extract the necessary funds for the purchase of the necessary equipment, and do not have an adequate loan history or required collateral for the realization of a bank loan. Leasing as a form of financing can be found in the offer of commercial banks active in the territory of BiH (Raiffeisen, Unicredit, Sparkasse, etc.), among other things, for the purchase of agricultural machinery and equipment, but it is still an underdeveloped modality. For the sake of its significant representation, it is necessary to eliminate legal restrictions and to improve the system of forced collection, which would certainly lead to a faster development of leasing operations.

According to the Law on **Concessions** of the RS, published in the Official Gazette of the RS No. 59/13 under this term it is understood that the concessionaire's right is to perform economic activities by using public goods, natural resources and other goods of general interest, as well as the right to perform activities of general interest, for a limited period of time, under the conditions defined by the law and by paying appropriate compensation. The objective of granting concessions is to achieve foreign investment that will improve the economic development of the RS, thus providing the necessary funds, and focusing the budget resources for other needs. By the end of 2015, the concession on agricultural land and water resources was active with a total of 55 companies from the RS. The mentioned land users have been allocated an area of 17,164,155 ha<sup>11</sup> of agricultural land. Since the concessionaire is obliged to pay compensation for the granted right, as well as the compensation for use, the funds for this purpose become the revenue of the budget of the RS and the units of local self-governments, depending on the competence to award the concession. In order to make this modality more important in the financing of RS agriculture, its revenues could be directly included in the financing of the agricultural budget of the RS and the local agricultural budget.

In the coming period, the RS should pay considerable attention to the financing of agriculture in the **securities** market. With the adequate development of the capital market, improving the financing of this branch of industry can contribute to the use of different forms of securities (shares, bonds, commodity bills, commodity-commercial bills, as well as derivative securities, futures and options).

In the RS, currently there is a stock exchange called "Banja Luka Securities Exchange, j.s.c. Banja Luka".

The process of trade in the capital market of the RS is carried out through relations: the issuer of securities from which the whole market process originates and which in the capital market also has a role that the commodity producer also plays on the commodity market; trader of securities as a person who professionally deals with the resale of securities; the market organizer, the person performing the activity of organizing trade in securities; capital investors, persons who in this market have the role of consumers in the commodity market (*Drljaca, 2016*). By issuing securities, the RS could collect additional funds in priority sectors, as well as in the agricultural sector, in order to cover temporary budget deficits. The collected funds can be used for various activities in order to improve the competitiveness and stability of the agricultural sector.

The **business angels** are also one of the potential modes of financing agriculture. This method involves the use of informal individual investors who have money, skills and business contacts during the initial stages of business development. Funds which investors invest in the company most often do not have to be repaid, but are replaced by participation in ownership over the same. Business angels invest in sectors and regions they know and can be organized in the form of networks and associations in order to increase their investments and joint management with the companies they invested in. In newly-formed companies that do not have a loan history or the necessary funds, this modality can be taken as a favorable solution. One of the characteristics of business angels as a modality of financing is investing in projects that can quickly make money. Therefore, this source is not suitable for all agricultural activities, but only those more profitable and more innovative than the current offer on the market. For this function it is necessary to animate successful individuals from

---

<sup>11</sup>Calculation by the author on the basis of the *Report on the Work of the Concession Commission for 2015 (agricultural land - valid contracts)*.

these areas who live and work abroad, and have the necessary free capital, skills and contacts whose engagement in this field will actively contribute to the development of agriculture. On the BiH market there is a network of business angels called “Bizoo Angel Network”, formed by national entrepreneurs, for the purpose of discovering and investing in small and medium enterprises and innovative companies from all sectors of the economy.

### **Conclusion**

Timely provision of financial resources is the primary task of an agricultural producer for the purpose of achieving adequate business results. In order to make this task easier, it is necessary to intensify efforts to develop additional modalities for financing of agricultural production. Among the analyzed modalities, the agrarian bank has not yet been established in the RS, and the presence of the same would allow the concentration of funds for this purpose from different sources, and their rational and efficient use for various purposes in primary agricultural production, processing of agricultural products, and multifunctional agriculture. The other analyzed modalities were present in the territory of the RS in the minimum and insufficient scope as well as the participation in the structure of the total sources of financing of agriculture. In the forthcoming period, efforts should be intensified to eliminate all obstacles and strengthen these potential modalities that can play a key role in resolving the problem of agrarian financing.

### **References**

- Commission for concessions of the Republic of Srpska, report on the work for 2015 (Agricultural land- valid contracts). Available at <http://koncesije-rs.org>
- Drljaca Z. (2016): Infrastructure of the Capital Market in the Republic of Srpska. Annual of the Faculty of Law, Vol. 6, pp 209-225.
- Radovic G. (2015): Funding of rural tourism in the Republic of Serbia. PHD thesis, Faculty of Agriculture, Department of Agricultural Economics and Rural Sociology, Novi Sad.
- Republic of Srpska, Foreign investment encouragement strategy 2016-2020. Available at [www.vladars.net](http://www.vladars.net)
- Vasiljevic Z., Sevarlic M. (2005): New modalities financing in Serbia agrarian economy. Economics of Agriculture, No 1, pp 25-42.
- Velagic I. (2011): Effects of foreign direct investments on the economy of the host country. Journal of economic and politics of Transition, No 27.
- Curkovic V. (2013): Financial support of the state in the production of organic food - a major development opportunity for Serbia. PHD thesis, University Singidunum Belgrade.

## **TRANSFORMATIONS IN THE GOVERNANCE STRUCTURE OF BULGARIAN AGRICULTURAL COOPERATIVES**

Angel SAROV<sup>1\*</sup>, Diana KOPEVA<sup>2</sup>

<sup>1</sup>Institute of Agricultural Economics, Sofia, Bulgaria

<sup>2</sup>University of National and World Economy, Sofia, Bulgaria

\*Corresponding author: angelsarov@abv.bg

### **Abstract**

For more than 25 years, agricultural cooperatives in Bulgaria have been operating in conditions of a rapidly changing socio-economic and political environment. The Institutional changes, blurring property rights, the separation of between ownership and management and change of the decision-making process, all required from agricultural cooperatives to undertake changes in the governance structure in order to answer the challenges of the dynamic environment. This means changing the direction of governance according the resources' empowerment by the management bodies. Cooperative management leads the decision-making process and fully accepts the management from the owners, changing its behavior model, in relation to the situation on the market. The increased competition and a rapidly changing market environment lead to convergence between the governance structure of the agricultural cooperative and the corporation. In that very long lasting and still ongoing transition period in Bulgaria, there is almost no sustainable cooperative model. In addition to the above, the cooperative management is transient, changing goals and values. Simultaneously, the cooperative governance structure is in the process of change, often deviating significantly from the formal and adopting the characteristics of the corporate one. The paper aims to explore changes and transitions in the governance structure of the Bulgarian agricultural cooperatives that lead to a balance between the interests of owners and managers, and guarantee the sustainability and efficiency of the structure.

**Keywords:** *Governance structure, Transformation, Agricultural Co-operatives, Bulgaria*

### **Introduction**

The cooperative and in particular the agricultural cooperative, as a specific form of doing business, is part of the world economy. In the global world in which it operates, market conditions and increasing competition have a significant impact on it: its vision, strategy, governance, and governance structure are changing. Governance is the systems and processes concerned with ensuring the direction, effectiveness supervision of an organization. In this paper, the concept of the governance structure in the agricultural cooperatives should be understood as the interrelationships between governing bodies and members, as well as the influence of the external environment (institutional environment, market mechanisms, etc.). Over the last decades, the changes in the governance structure of agricultural cooperatives have focused the attention of a considerable number of researchers, practitioners and policymakers in Europe and North America. Part of the researches support the thesis of radical deviations from the traditional (classic) governance where property rights belong not only to members of the cooperative (Chaddad and Cook, 2003). Typologies have been developed, with a different ownership structure (investing members and accumulation of votes), focusing on the investors of the capital investors (Nilsson, 1999). Other researchers

(Van Der Sangen, Jos Bijman, Markus Hanisch, 2012) discuss the decision-making process, the changes in the formal rights of the governing bodies (General Assembly, the Board of Directors, the Supervisory Board, the Chairman), and the introduction of innovations in the governance structure (inclusion of non-members and external experts in the governing bodies, appointment of a professional manager, introduction of a proportional vote, depending on the amount of the capital invested, etc.). These concepts respond to the understanding of the adaptation of agricultural cooperatives to the external environment. They explain the deviations between the principles of traditional cooperatives and the requirements of the modern governance.

In Bulgaria the issues related to the governance and the governance structure of the agricultural cooperatives generated wide interest among the scientific community (Bachev, H. (2009), Boevsky, I. (2012), etc. Over the past decade, as a result of increased competition from the corporate structures, the agricultural cooperative is forced to focus on its survival and adequate behavior. During this period, a continuous decrease in their number is reported. The cooperatives are not overrun by markets forces, and they have proactive positions in the design of the governance model. We are witnessing the introduction of innovative approaches to the governance of cooperatives borrowed from the conventional business units. To achieve the objectives, the governance of the agricultural cooperative needs new knowledge related to improving the organizational relationships. The cooperative has been gained its important place and role in the country's economic activity. It contributes to improving the quality of life of members and the employment in rural areas.

After the democratic changes in Bulgaria, the difficulties of cooperatives' functioning have been related to the ongoing demographic changes in the Bulgarian society. The deepening of migration processes, the low payment levels, the reduction of the workforce, the aging population, the shortage of young and educated people lead to significant social and economic difficulties in rural areas. They have been associated with poorly trained and qualified staff. Managers are experiencing a shortage of knowledge and work skills. The agricultural cooperatives must undertake changes in the governance structure to meet the challenges of the dynamic environment.

The aim of the paper is to study the changes and transformations of the governance structure of the Bulgarian agricultural cooperatives, which balance the interests of the owners and the managers and guarantee the structure sustainability and efficiency. *The governance structure of the co-operative units should be understood such as a system of relationships between managers and owners. It is formed under the influence of formal internal and external rights and obligations, informal rules, and external environment. The cooperative governance structure reflects the decision-making processes, protects owners' interests and guarantees the property rights and the fulfillment of the goals* (Sarov, 2017).

## **Materials and Methods**

The paper is based on a qualitative analysis. It allows deep reflection of the changes in the governance structure, the natural behavioral processes in the organization, the tracking of relationships dynamics between the governing bodies and the interested parties (cooperative members and owners of agricultural land), the decision-making processes, the property rights, the control over management rights, etc. Changes in the external environment (social, cultural, political, legal, market, competition and distribution network) are analyzed. This method is a kind of descriptive: in-depth study, gathering data for participants through: analytical narratives, poll, interview, combining different techniques in interviewing, interactive approaches, community cohabitation, direct observations, trust, protocols, record reviews . The use of the case allows the interaction of all the variables and processes taking

place in the cooperative governance structure, the circumstances, the behavior and the characteristics of the members in the cooperative and the community. The application of a depth study, for its part, includes an analysis of demographic characteristics, values, attitudes and motivation. Holistic and integrated case study have been combined. The case studies present the vision, the state and the main changes of the governance structure in the Bulgarian agricultural cooperatives. The focus is on changes in the decision-making process, the dilution of property rights, the right to control, the distribution of benefits, the change of objectives. Basic information has been gathered through the implementation of an embedded case that proved to be a successful strategy for the researcher to get into the depth of the problems.

The survey scope of the survey is the agricultural cooperatives operating on the territory of the Republic of Bulgaria located in the following planning regions: North-West, North-East, South-West and South Central Region. The analysis is based on empirical evidences - case studies of 32 agricultural cooperatives carried out during the period 2013-2016.

### **Results and discussion**

The agricultural cooperatives in Bulgaria operate under conditions of continuous market influence. In addition, increased competition requires transformation of the governance structure, resulting in unbalanced interests between owners and managers. As a result, the cooperative model is not sustainable. This means that in time, cooperatives will likely continue to decline and change in the direction of getting closer to corporations.

The cooperatives, examined as a governance structure, actively interact with the external environment: Institutions - define the rules of the game and regulate formal rights (legal norms) and informal rules; Political parties - related to the activities of agricultural cooperatives, both of which, to one degree or another, derive economic and lobbying benefits from such interaction; The market environment, which includes all the interaction partners - suppliers, buyers, consultants, competitors.

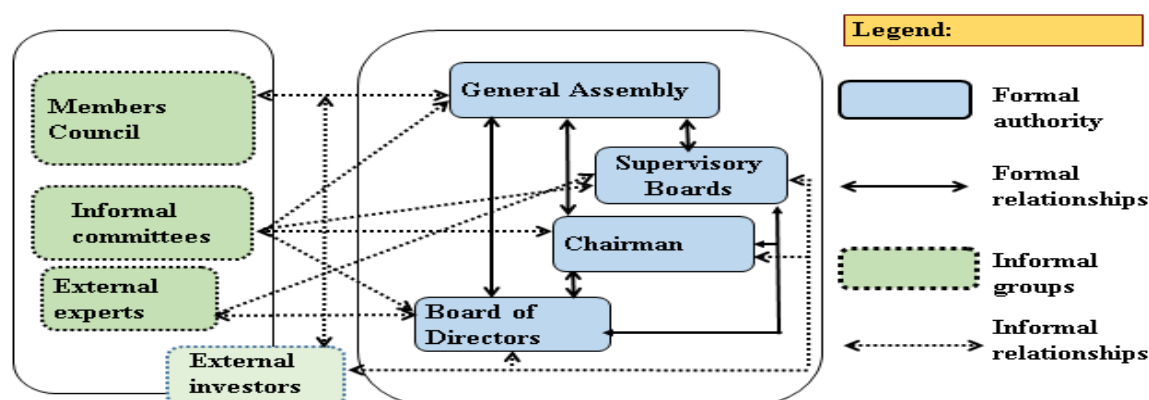
The integration of the majority of the functions of governing bodies in the person of the Chairman of the cooperative violates democratic character in the governance structure. He accepts the assignment to carry out the operational management of the cooperative. In order to establish market sustainability, management needs to be professionalized. The participation of the members in the management is limited to the need of their votes in the election of governing bodies: Chairman, Board of Directors and Supervisory Board. The commonality of these governance mechanisms, the limited efficiency and the manipulation of the formal framework is a challenge for cooperatives. Such informal relationships with members do not identify with co-operative essence. The Chairman imposes an authoritarian decision-making process and this transforms the formal governance structure. The explanation for this action is in his strong desire and striving to centralize the distribution of information channels and to exercise sole power resources seized by the Board of Directors and Supervisory Board. Members increasingly lose confidence in the democratic government. Evidence of this is that the Chairman is the one who imposes his own opinion in front of other members in the decision-making process. He controls the distribution of the benefits of members' property rights. For some of them, it is pointless to continue their membership in such a structure. Such a governance structure means that the Chairman as the main operating and management body is in a situation in which he controls himself. The identification of such actions further put a lot of research questions.

The transformations in the governance structure of agricultural cooperatives in Bulgaria show a "reversal" of the model. If an attempt is made to visualize the change, the figure would look like this: At the top of the structure, instead of the General Assembly in the person of the

members, the Chairman adopts a dominant position. Conversely, members are positioned in the "periphery" and their participation in the cooperative's activities does not have any influence. Members are increasingly not perceived as part of this structure and are not involved in its governance mechanism. The relationship and interaction between the formal bodies in the governance structure are broken. In the corporate firms, those who invest capital (investors), like the owners of capital (members) in the agricultural cooperative, often do not receive timely operational information about the organization's activities. The agent (Chairman or Executive Director) has access to all the information and limits the flow of information channels to principals (members or investors). The Board of Directors and the Supervisory Boards in the examined cases do not fulfill the statutory obligations in the governance structure. In such a situation where the Chairman seizes their functions, there is a problem. There are doubts about the correctness of these governing bodies. Their lack of interest and the failure to perform the assigned tasks are usually the result of personal benefit interests. In the corporate firms, as already noted, investors are traditionally members of the General Assembly and members of the Supervisory Board which elects the Board of Directors. This reconciliation of these two governing bodies by investors predisposes for such opportunistic behavior by the agent (the Board of Directors) to the principal.

*The case studies prove that informal relationships (deviations from the legal framework) in the management structure of cooperatives are "formalized" (Figure 1).*

Figure 1. Informal and formal governance structure of Bulgarian agricultural cooperatives



Source: Own figure

In some of the investigated cooperatives, non-formal governing bodies have been identified. First, it is the one who accepts the functions of the General Assembly, defined as the Members Council. The principle is based on reducing the number of members who are empowered to represent the rest and to participate in the management of the cooperative. The proximity of these members to the land and their small number helps them to gather quickly when important management decisions are needed. The reason for this action is that the General Assembly fails increasingly to fulfill its role as a supreme governing body in the governance structure. This is because the collection of all members is a slow process and often accumulates high transaction costs, which usually do not cover their potential membership benefits.

Secondly, informal interest groups have been identified. Cooperative members living near the land are united in informal committees and exercise effective control and monitoring in the cooperative. This innovation prevails in practice in most cooperatives and shows good results but is often associated with a lot of time and costs for the participants. By their very nature, they seize the functions of the Supervisory Boards in the governance structure. Under certain

circumstances, this transformation may lead to some conflicting situations among the rest of the members.

The case studies show a positive attitude of the agricultural cooperatives members to implement organizational innovations. When it comes to "outside" non-participating members of the cooperative, opinions are bipolar. On the one hand, members accept similar experts or investors to help with management and funding. On the other hand, it is the unanimous opinion that such „inflows" in the cooperatives are possible, but without the right to vote in the General Assembly. This behavior of members can be assumed to be the result of their desire to preserve (protect) the cooperative community and to prevent external interests from influencing the organization.

The case studies confirm the idea that agricultural cooperatives in Bulgaria are active participants in local initiatives, social support and preservation of Bulgarian identity, culture and faith. However, the cooperative governance is transformed and shifted to the focus of the cooperative. The direction is changed - by a member-supporting organization (social group), it is increasingly directed towards end-users (economic goals). In this way, the members of the cooperative lose confidence in its principles and terminate their membership. As a result, the agricultural cooperatives in Bulgaria are not sustainable models and in the last decade their number has been sharply decreasing.

The competition has a significant impact on the vision and strategy of the agricultural cooperatives. The governance structure in the Bulgarian agricultural cooperatives functions in a kind of innovative model. Changes that lead to changes in governance of co-operatives are the most controversial points in this discussion. Many politicians, economists, scientists and practitioners of agriculture who know and recognize the potential dangers are afraid that cooperatives will lose their typical (traditional) characteristics. They arise where there is a free market niche or a market. At the same time, the cooperatives are under the influence of market conditions. Proof of this is their hybrid form - cooperatives are increasingly growing vertically. Examples include not only consumer and credit cooperatives, but also the agricultural cooperatives that adopt features and elements of the corporate firms. This means that in the future, the distinction between the cooperatives and the corporations will be increasingly difficult. The basis for such an assertion consists of the following elements: professionalization of the management, lack of cooperative identity (values and principles), increased profit orientation, economic goal. There is a change in the cooperative strategy aimed at building trust with the distribution network (suppliers, buyers and consultants). Their interaction is based on the respect of ethical norms, in compliance with the legal framework in the country.

### **Conclusion**

Over the last decade Bulgarian agricultural cooperatives have been faced with challenges from the external environment (political, institutional, market), forcing them to increasingly turn to external users and change their goals.

The agricultural cooperatives focus primarily on: reducing production costs and introducing innovative technologies; purchase of own land; capital increase through the admission of new members; policies aimed at stimulating the increase of additional capital from members. A tendency is observed in reducing the number of cooperatives and diminution of arable agricultural land, which affects their sustainability. The dynamic market environment (increasing competition, changes in market structure, changing preferences and customer demand) alters some of the functional and organizational features in the governance structure. They are caused by transformation in the decision-making process. This leads to distortions in the governance structure model and thence to the following results: blurring of property rights, increase the powers of the governing bodies (seizing power resources, reducing the



channels for disseminating information), weak motivation of the members to participate in the decision-making process, lack of clear vision and strategy (goals, production structure, distribution networks), insufficient managerial skills (investment and innovation activity) and trust. As a result of in-depth interviews, deviations from the legal framework have been recorded. Informal supporting bodies of the governance structure in the Bulgarian agricultural cooperatives – Members Council, informal interest groups, attracting external experts were identified. The lost a trust from the part of members to the management leads to their leaving from the cooperative and redirecting to corporate structures.

Under the influence of increased competition, the orientation and objectives of the cooperative have changed, and they are already connected with the realization of higher profits and transactions with non-members (as in the corporation), in other words: market-oriented. This means that the relationships of management with members is loosened. As a result of this trend, the management is "professionalized" and there is a process of "economizing" the objectives. The traditional cooperative is changed and transformed as an entrepreneurial corporate structure. The transformations in the governance structure increase the competitiveness and sustainability of the agricultural cooperatives.

Under condition of transition, prerequisites for the development and emergence of modern hybrid cooperatives are created. They occupy a key position in the country's economy, which further increases their role and importance. Consequently, the functioning of cooperatives and their sustainable development should be improved. The presence of discussion points indicates that is necessary informal changes to be regulated of the legislative framework in a way that equally protects the interests of the stakeholders.

### **References**

- Bachev, H. (2009). Mechanisms of Governance of Sustainable Development, *Journal of Applied Economic Science*, Vol. IV, 2, 169-184.
- Boevsky, I. (2012). Agricultural Production Cooperatives in Bulgaria: Case Study, Workshop “Cooperatives in Central and Eastern Europe” 07.06.2012, Humboldt-University, Berlin, Germany.
- Bijman, J.; Van der Slangen, G.; Hanisch, M. (2012): Exploring Innovations in Internal Governance in European Agricultural Cooperatives. Paper presented at the Colloque International Diversité et Durabilité des Modèles Agricoles Coopératifs dans un Contexte de Crises de la Mondialisation, November 6-7, 2012, Paris, France.
- Chaddad, F. R., Cook M. L., (2003). Understanding New Cooperative Models: An Ownership- Control Right Typology-Review of *Agricultural Economics*, 26 (3), 348-360.
- Hilb, Martin (2010). *New Corporate Governance, Successful Board Management Tools*, Springer Berlin – Heidelberg.
- Kopeva, D. Land Market in Bulgaria. In “Land Institutions and Land Markets”, ed. Klaus Deininger, The World Bank Group. Washington, 2004. p. 89-128.
- Nilsson (1999). Co-operative Organisational Models as Reflections of the Business Environments. *The Finnish Journal of Business Economics* 4 (Special Issue: The Role of Cooperative Entrepreneurship in the Modern Market Environment), 449–470.
- Sarov, A. (2017). Governance in the agricultural cooperatives – Challenges and Opportunities, 4-26.

## PRODUCTION OF BIOACTIVE CONJUGATED LINOLEIC ACID BY LACTIC ACID BACTERIA FROM TRADITIONAL BULGARIAN FERMENTED PRODUCTS

Galya BLAGOEVA<sup>1</sup>, Angel ANGELOV<sup>2</sup>, Velitchka GOTCHEVA<sup>2\*</sup>

<sup>1</sup>Primoris Bulgaria, 134 Bratia Bakston Str., Plovdiv 4004, Bulgaria

<sup>2</sup>Department of Biotechnology, University of Food Technologies, 26 Maritza Blvd., 4002 Plovdiv, Bulgaria

\*Corresponding author: gotcheva\_v@uft-bio.com

### Abstract

Conjugated linoleic acid (CLA) is a group of positional and geometric isomers of linoleic acid (LA; c9c12-C18:2). Two of the most biologically active forms of CLA - *cis-9*, *trans-11* and *trans-10*, *cis-12* have beneficial effects on consumers related to anticarcinogenic, immune modulation, antiatherosclerotic, and antiobesity activities. Some lactic acid bacteria (LAB) are found to produce CLA in synthetic media or milk. However, most screening methodologies for CLA-producing LAB are laborious, complex and time-consuming. The aim of the present study was to assess the ability of 35 LAB strains isolated from traditional Bulgarian dairy and cereal-based fermented products to convert free LA to CLA isomers (*cis-9*, *trans-11* and *trans-10*, *cis-12*) by using a rapid spectrophotometric method. Thirty-five LAB strains were tested, and the applied rapid and sensitive screening approach showed that all except for one strain were able to produce CLA at different levels. Most of the strains belonged to *Lb. plantarum* and *P. acidilactici*. Nine of the tested strains converted more than 22% of the LA to CLA in the culture supernatant. The highest conversion capacity of LA to CLA isomers was shown by *Streptococcus bovis* 1.1 (29%) and *Lb. plantarum* 5.2 (28%). The maximum concentration of CLA isomers reached 0.145 mg/ml. However, the spectrophotometric method could not differentiate between CLA isomers since it is based on measurement of the conjugated double bond in the fatty acid. In conclusion, the present study revealed the capacity of LAB strains isolated from traditional Bulgarian fermented foods to convert free LA to CLA. The applied analytical method proved to be highly time- and labour-efficient for screening a large number of bacterial isolates for the ability to produce conjugated fatty acids.

**Keywords:** *Bioactive conjugated linoleic acid, Lactic acid bacteria, Bulgarian fermented products*

### Introduction

Conjugated linoleic acid (CLA) is a naturally occurring *trans* fat commonly found in a variety of foods, such as meat, poultry, seafood, dairy products, vegetable oils, and some other food sources, being most abundant in foods from ruminants (beef, lamb and dairy products) (Chin *et al.*, 1992; Lehnen *et al.*, 2015; National Cattlemen's Beef Association, 2008).

CLA is a collective term used to describe a mixture of positional and geometric isomers of linoleic acid, an essential fatty acid. Conjugation of the double bond is generally in positions 9 and 11 or 10 and 12, and may be a *cis* or *trans* configuration (Lehnen *et al.*, 2015). The isomerization and biohydrogenation of linoleic and linolenic acid to CLA in rumen are performed by some ruminal bacteria and through conversion of vaccenic acid in the mammary gland (National Cattlemen's Beef Association, 2008; Sieber *et al.*, 2004). So far,

28 different CLA isomers have been identified and it is possible that a number of them have beneficial biological activity. However, all of the known physiological effects of CLA to date are attributed to two isomers, on which most research is focused. These are the *cis*-9, *trans*-11 isomer (*c*9, *t*11 CLA (9-CLA), also called rumenic acid), which accounts for 72 to 94% of total CLA in foods from ruminant animals, and the *trans*-10, *cis*-12 isomer (*t*10, *c*12 CLA (10-CLA)) is found mainly in vegetable oils and partially hydrogenated oils (Liu *et al.*, 2011; National Cattlemen's Beef Association, 2008; Wall *et al.*, 2008).

Starting in the 1980s, there has been considerable interest in these biogenic isomers due to their potential health-promoting properties and the potential health benefits of CLA, including anticarcinogenic effect, immune modulation, antiatherosclerotic effect, ability to reduce body fat while enhancing lean body mass, positive effect on insulin resistance and on bone health (Belury, 2002; Park and Pariza, 2007; Soel *et al.*, 2007; Tricon and Yaqoob, 2006; Wang and Jones, 2004). The isomer 9-CLA, which has been considered to have the main biological activities, is mainly responsible for the anticarcinogenic effect, while 10-CLA isomer is involved in the lipid metabolism and body composition, and in some cases the health-promoting effects appear to be the synergistical interactions of these two isomers (Bhattacharya *et al.*, 2006; Churruca *et al.*, 2009; Pariza *et al.*, 2001; Park and Pariza, 2007).

To increase the intake of CLAs, dietary and non-dietary manipulations on food products have been routinely employed, such as supplementing the ruminant diet with plant oils or animal fats that contain either LA or linolenic acid (Liu *et al.*, 2011; Wall *et al.*, 2008). Substantial amounts of 9- and 10-CLA can be produced commercially by chemical isomerization, but they are contaminated with a variety of other isomers and toxic compounds and cannot be used directly. Due to the high cost and difficulties in isomer purification, such synthesized CLA is not reliable a dietary source (Liu *et al.*, 2011; Pariza *et al.*, 2001). On the other hand, the potential of CLA synthesis by food-grade bacterial strains is attracting more and more attention as a promising approach for the production of dietary CLA (van Nieuwenhove *et al.*, 2007; Wall *et al.*, 2008).

Some researchers suggest that the high levels of CLA in fermented dairy products are attributed to the activity of Bifidobacteria and lactic acid bacteria (LAB), however the contribution of presently used dairy starter bacteria to increased CLA content in cheese is found to be relatively minor (Sieber *et al.*, 2004). Bacterial strains belonging to a few genera such as *Lactobacillus*, *Propionibacterium*, *Bifidobacterium* and *Enterococcus* have been reported to produce CLA in either synthetic media or milk, but the ability to produce CLA can vary from strain to strain (Alonso *et al.*, 2003; Ogawa *et al.*, 2005; Sieber *et al.*, 2004; Zeng *et al.*, 2009). Therefore, isolation of LAB with the ability to produce significant amounts of CLA is of high interest for the application of such bacteria as starter cultures for functional foods with high CLA content and as industrial CLA strain-producers (Al-Hindi and El Ghani, 2015; Kuhl and Lindner, 2016; Meraz-Torres and Hernandez-Sanchez, 2012). Therefore, the aim of the present study was to assess the ability of 35 LAB strains isolated from traditional Bulgarian dairy and cereal-based fermented products to convert free LA to CLA isomers (*cis*-9, *trans*-11 and *trans*-10, *cis*-12) by using a rapid spectrophotometric method.

## Materials and Methods

The present study was carried out with 35 LAB isolates originating from traditional Bulgarian cereal-based and dairy fermented products and belonging to the following species: *Lactobacillus plantarum* (strains 5.2; 3.2; BB2; Bom2; Lin2; Pro; K4, Bom 816), *Lb. fermentum* (strains 21.1; 26.1; 3.1; 3.2; 11, BH6; Ed2; K4), *Lb. rhamnosus* (strain 18), *Lb. pentosus* (strains BH3; N3), *Lb. casei* (strains A; Pro1), *Lb. paracasei* (strains LC1; Pr1, ya2,

DA1), *Lb. paralimentarius* (strain C3), *Pediococcus acidilactici* (strains BH5; BB1; Bom3; Lin1; Pd3; LP), *P. pentosaceus* (strain K3), *Streptococcus bovis* (strain 1.1), and *Enterococcus faecium* (strain B). Their ability to produce CLA was tested according to the method of Barrett *et al.* (2007). The strains were incubated in MRS broth containing 0.5 mg/ml free linoleic acid and 2% (wt/vol) Tween 80 at 37°C for 48 h. The cultures (1 ml) were centrifuged at 20,000x *g* for 1 min. The culture supernatant was mixed with 2 ml of isopropanol by vortexing and allowed to stand for 5 min. The fatty acids were extracted with 1.5 ml of hexane preceded by vortexing. The presence of CLA in the culture supernatant was assayed spectrophotometrically by measuring the absorbance at 233 nm. *Cis*-9, *trans*-11 and *trans*-10, *cis*-12 isomers of CLA were used for standard curves in order to calculate the concentration of CLA produced by the tested LAB strains.

## Results and Discussion

The ability of some strains of *Lactobacillus*, *Propionibacterium*, *Bifidobacterium* and *Enterococcus* to produce CLAs in synthetic media or milk has been reported only in the recent years (Alonso *et al.*, 2003; Ogawa *et al.*, 2005; Sieber *et al.*, 2004; Zeng *et al.*, 2009). Due to the beneficial physiological effects of CLA, and the difficulties related to its production by chemical synthesis, the isolation of LAB with the ability to produce significant amounts of CLA is of high interest for the application of such bacteria in functional foods with high CLA content. This ability is also regarded as a probiotic property of microorganisms (Wall *et al.*, 2008).

In the present study, 35 LAB strains isolated from traditional Bulgarian dairy and cereal-based fermented products were assayed for their ability to convert free LA to CLA. Biotransformation of LA to CLA is performed by the enzyme linoleate isomerase which is bound to the bacterial membrane (Ogawa *et al.*, 2005; Van Nieuwenhove *et al.*, 2007). Results showed that all tested strains except for one (*Lb. plantarum* Pro) were able to produce CLA at levels ranging from 0.031 mg/ml to 0.132 mg/ml (Figure 1). The spectrophotometric method applied for analysis was rapid and sensitive to determine the amount of CLA produced. However, the method could not differentiate the isomers of CLA since it is based on measurement of the conjugated double bond in the fatty acid. In order to identify CLA isomers, GC/MS analysis must be applied (Al-Hindi and el-Ghani, 2015; Alonso *et al.*, 2003).

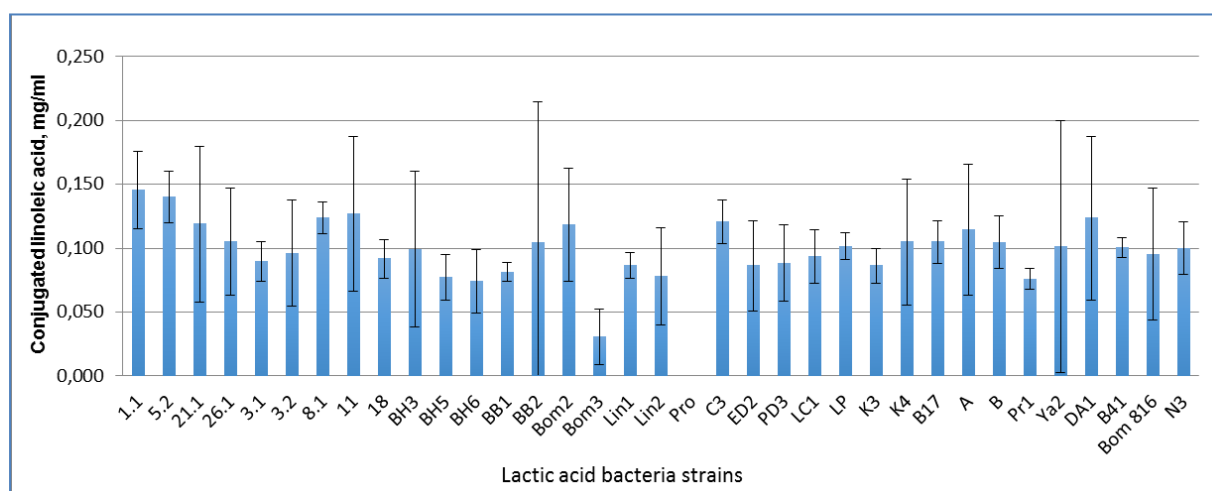


Figure 1. Production of conjugated linoleic acid by lactic acid bacteria

Eighteen of the strains, most of which *Lb. plantarum*, produced CLA of 100 mg/ml and higher. Zeng *et al.* (2009) reported 0.623 mg/ml CLA for *Lb. plantarum* NCUL005 isolated from sauerkraut. Similar results were obtained in another study with 43 *Lb. plantarum* strains originating from fermented pickles which yielded levels of 0.1 to 0.6 mg/ml (Liu *et al.*, 2011). Results from the present study showed significant variability of CLA production and conversion ratio both between species and between strains from the same species. Nine of the tested strains converted more than 22% of the LA to CLA in the culture supernatant (Figure 2). The highest conversion capacity of LA to CLA isomers was shown by strain *Streptococcus bovis* 1.1 (29%) and *Lb. plantarum* 5.2 (28%). The tested *Lb. fermentum* strains also showed good conversion capacity of approximately 24-25%. These levels were similar to that reported for *Lb. plantarum* by Zeng *et al.* (2009) - 26.7%, and Liu *et al.* (2011) – 25% CLA conversion. In another study, six LAB strains were found able to form CLA in MRS broth after 24 h of incubation, with varying percentage of LA conversion between 17% and 36%. Of the tested strains, *L. casei*, *L. rhamnosus*, and *S. thermophilus* showed the highest LA conversion (Van Nieuwenhove *et al.*, 2007).

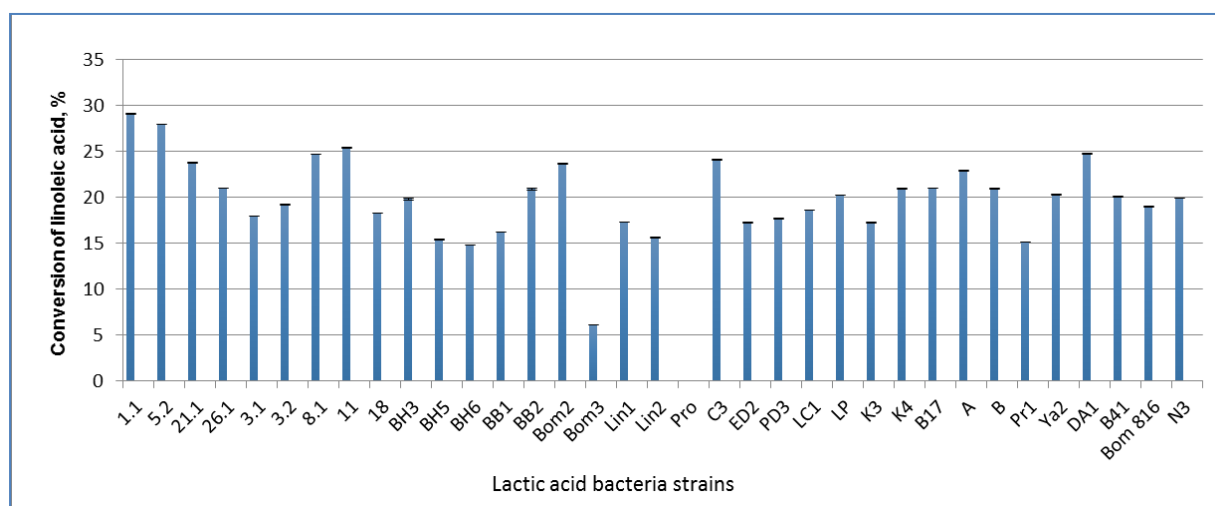


Figure 2. Conversion of free linoleic acid to conjugated linoleic acid by lactic acid bacteria

Some authors found a positive correlation between CLA production and tolerance to LA. However, the efficiency of CLA production in some LAB and *Bifidobacterium* decreased at higher levels of free LA in the medium (Van Nieuwenhove *et al.*, 2007; Xu *et al.*, 2008).

Despite that most strains studied for CLA production belonged to *Lb. plantarum*, it is estimated that this ability is strain-specific and depends on the culture medium, the carbon source used, as well as the cultivation conditions and duration. The types of the produced isomers are also strain-specific, with some strains producing only one isomer and others – more than two. It is also interesting to note that while most LAB produce CLA only by converting LA, some strains show the ability to produce CLA from other substrates (Kuhl and Lindner, 2016; Liu *et al.*, 2011; Ogawa *et al.*, 2005; Van Nieuwenhove *et al.*, 2007; Xu *et al.*, 2008).

### Conclusions

In conclusion, the present study revealed the capacity of LAB strains isolated from Bulgarian cereal-based and dairy fermented foods to convert free LA to CLA. The spectrophotometric method applied for analysis was rapid and sensitive to determine the amount of CLA

produced, but could not differentiate CLA isomers. The strains belonged to several LAB species, with highest CLA production observed mostly for *Lb. plantarum* strains. The rapid methodology used facilitated and greatly reduced the time and labour needed to screen a large number of bacterial isolates for the ability to produce conjugated fatty acids.

The use of LAB for the bioconversion of LA to CLA isomers can contribute to increased functionality of probiotic foods which could be an excellent source of CLA for a healthy diet. However, more research is needed to assess how to enhance CLA production by LAB and to determine the optimal requirements for those microbial cultures which show ability to produce CLA.

### Acknowledgements

The authors are grateful to the Scientific Research Fund of the Bulgarian Ministry of Education and Science for the financial support of project DFNI B 02/27.

### References

- Al-Hindi R.R., El Ghani S. (2015) Production of free conjugated linoleic acid by fermentation performed using *Lactobacillus casei* and *Bifidobacterium bifidum*. *Global Veterinaria*, Vol. 14 (5), 720-728.
- Alonso L., Cuesta E.P., Gilliland S.E. (2003) Production of free conjugated linoleic acid by *Lactobacillus acidophilus* and *Lactobacillus casei* of human intestinal origin. *Journal of Dairy Science*, Vol. 86, 1941–1946.
- Barrett E., Ross R.P., Fitzgerald G.F., Stanton C. (2007) Rapid screening method for analyzing the conjugated linoleic acid production capabilities of bacterial cultures. *Applied and Environmental Microbiology*, Vol. 73 (7), 2333 – 2337.
- Belury M.A. (2002) Dietary conjugated linoleic acid in health: physiological effects and mechanisms of action. *Annual Review of Nutrition*, Vol. 22, 505-5312.
- Bhattacharya A., Banu J., Rahman M., Causey J., Fernandes G. (2006) Biological effects of conjugated linoleic acids in health and disease. *The Journal of Nutritional Biochemistry*, Vol. 17 (12), 789-810.
- Chin S.F., Liu W., Storkson J.M., Pariza M.W. (1992) Dietary sources of conjugated dienoic isomers of linoleic acid, a newly recognized class of anticarcinogens. *Journal of Food Composition and Analysis*, Vol. 5, 185-197.
- Churrua I., Fernandez-Quintela A., Portillo M.P. (2009) Conjugated linoleic acid isomers: differences in metabolism and biological effects. *Biofactors*, Vol. 35 (1), 105-111.
- Kishino S., Ogawa J., Omura Y., Matsumura K., Shimizu S. (2002) Conjugated linoleic acid production from linoleic acid by lactic acid bacteria. *Journal of the American Oil Chemists' Society*, Vol. 79, 159–163.
- Kuhl G.C., Lindner J.D. (2016) Biohydrogenation of linoleic acid by lactic acid bacteria for the production of functional cultured dairy products: a review. *Foods*, Vol. 5 (13), 1-11.
- Lehnen T.E., da Silva M.R., Camacho A., Marcadenti A., Lehnen A.M. (2015) A review on effects of conjugated linoleic fatty acid (CLA) upon body composition and energetic metabolism. *Journal of the International Society of Sports Nutrition*, Vol. 12 (36), 1-12.
- Liu P., Shen S., Ruan H., Zhou Q., Ma L., He G. (2011) Production of conjugated linoleic acids by *Lactobacillus plantarum* strains isolated from naturally fermented Chinese pickles. *Journal of Zhejiang University Science B*, Vol. 12 (11), 923 – 930.
- Meraz-Torres L.S., Hernandez-Sanchez H. (2012) Conjugated linoleic acid in dairy products: a review. *American Journal of Food Technology*, Vol. 7 (4), 176-179.

- National Cattlemen's Beef Association (2008) Conjugated linoleic acid and dietary beef. Beef Facts, 1-8.
- Ogawa J., Kishino S., Ando A., Sugimoto S., Mihara K., Shimizu S. (2005) Production of conjugated fatty acids by lactic acid bacteria. *Journal of Bioscience and Bioengineering*, Vol. 100 (4), 355 – 364.
- Pariza M.W., Park Y., Cook M.E. (2001) The biologically active isomers of conjugated linoleic acid. *Progress in Lipid Research*, Vol. 40 (4), 283-298.
- Park Y., Pariza M. (2007) Mechanisms of body fat modulation by conjugated linoleic acid (CLA). *Food Research International*, Vol. 40 (3), 311-323.
- Sieber R., Collomb M., Aeschlimann A., Jelen P., Eyer H. (2004) Impact of microbial cultures on conjugated linoleic acid in dairy products – a review. *International Dairy Journal*, Vol. 14 (1), 1-15.
- Soel S.M., Choi O.S., Bang M.H., Park J.H.Y., Kim W.K. (2007) Influence of conjugated linoleic acid isomers on the metastasis of colon cancer cells *in vitro* and *in vivo*. *Journal of Nutritional Biochemistry*, Vol. 18, 650 – 657.
- Tricon S., Yaqoob P. (2006) Conjugated linoleic acid and human health: a critical evaluation of the evidence. *Current Opinion in Clinical Nutrition and Metabolic Care*, Vol. 9, 105-110.
- Van Nieuwenhove C.P., Oliszewski R., Gonzalez S.N., Perez C.A.B. (2007) Conjugated linoleic acid conversion by dairy bacteria cultured in MRS broth and buffalo milk. *Letters of Applied Microbiology*, Vol. 44 (5), 467-474.
- Wall R., Ross R.P., Fitzgerald G.F., Stanton C. (2008) Microbial conjugated linoleic acid production - a novel probiotic trait? *FST Bulletin*, Vol. 4 (8), 87-97.
- Wang Y., Jones P.J.H. (2004) The role of conjugated linoleic acid in human health. Dietary conjugated linoleic acid and body composition. *American Journal of Clinical Nutrition*, Vol. 79 (6 suppl), 1153S-1158S.
- Xu H., Lee H.Y., Hwang B., Nam J.H., Kang H.Y., Ahn J. (2008) Kinetics of microbial hydrogenation of free linoleic acid to conjugated linoleic acids. *Journal of Applied Microbiology*, Vol. 105 (6), 2239-2247.
- Zeng Z., Lin J., Gong D. (2009) Identification of lactic acid bacterial strains with high conjugated linoleic acid-producing ability from natural sauerkraut fermentations. *Journal of Food Science*, Vol. 74 (4), M154 – M158.

## **ROLE OF WOMEN IN DECISION MAKING IN THE FIELD OF AGRICULTURE A STUDY AT BIHAR (INDIA)**

Arunima KUMARI, Pooja KUMARI, Richa KUMARI, Kritika

Department of Home Science Extension and Communication Management  
College of Home Science, Dr. Rajendra Prasad Central Agricultural University, Pusa Bihar (Samastipur), India  
Corresponding author: arunima.rau@gmail.com

### **Abstract**

Agriculture is the main engine of growth for economic development as well as to eradicate the poverty in almost all developing countries. Women are the main pivot around which this whole phenomenon rotates. They play key role in not only producing and preparing food but in rearing animals, collecting fuels, caring for family members and maintaining their homes, nursery gardening, rural marketing and trading, fetching of water and many more activities related to farm and production. For total livelihood sustainability it is the women who play a major role but somehow it has been found that their role in decision-making has been gradually diminished from Vedic era to modern era (particularly in case of Indian context). In India women were more privileged and bold in our early civilization. That is why the present study was conducted in 2015 in a small district of Bihar (India) in order to access their percentage in decision-making process in the field of agriculture. During early age women were allowed to take decision not only in ruling the kingdom but in war field too. As the age turned on due to different emperors their role went down but still few examples are there in front of us (Rani Laxmibai, Indira Gandhi, Pratibha Singh Patil etc.). The result of collected data out of 100 respondents depicts that only 8.33% landless women farmers take decisions in the field of agriculture followed by 19.27 % of medium women farmers and 20.47% of small women farmers and maximum of 29.35% by marginal women farmers.

**Keywords:-** *Landless, Medium, Small Women farmer.*

### **Introduction**

Women are the backbone of the rural & national economics. Women comprise 43% of the world's agricultural labour force which rises to 70% in some countries. In Africa 80% of the agricultural production comes from small farmers who are mostly rural women. Women comprise the largest percentage of the workforce in the agricultural sector, but do not have access and control over all land and productive resources. (SOFA Team & Cheryl ) Women in agriculture are often physically visible but conceptually invisible & remain marginalized. Rural women besides their normal household responsibilities play a very significant role in agriculture and allied activities. In India, women as farmers are involved in pre-sowing, post-sowing, harvesting & post- harvesting operations as well as allied activities through physical participation & supervision. Their activities typically include producing agricultural crops, tending animals, processing & preparing food, working for wages in agricultural or other rural Enterprises, collecting fuel & water, engaging trade & marketing caring for family members and maintaining their homes. Many of these activities are not defined as "economically active employment" in national accounts but they are essential to the well being of the rural households. Despite their important role, women farmers face several disparities in different areas of agriculture even though their significant contributions in different agricultural activities. Brar ,Gill And Walia(2007) observed that 42.9 percent of the total surveyed Farmers consulted women in decision making regarding number of hierd labourers and kind of wages,while in 11.3 percent cases their opinions were considered in



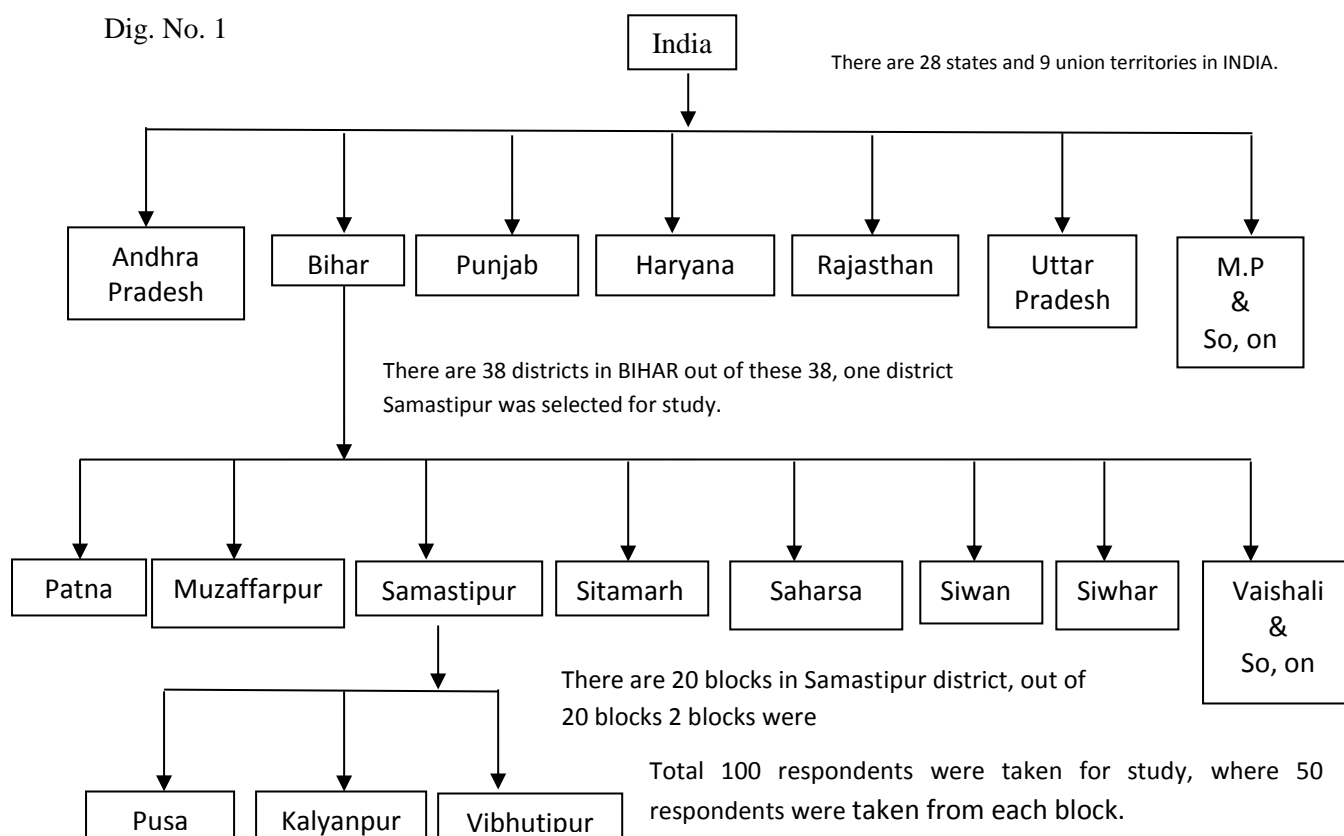
this areas of decision making in agriculture, only 9.3 percent of the total surveyed farmers considered the opinion of women, while 68.7 percent not even consulted the women of family during marketing of their farm produce. Decision making refers to the mode of decisions taken by farm women regarding various aspects of agricultural activities either solely or jointly with husband & family members (Gondaliya and Patel (2012) Sharma *et. al.*, (2013) found that maximum number of farm women i.e., 58.33% were not taking active part in decision –making. Only 19.17% of farm women were taking active participation in decision making. Hence to know women contribution and pattern to take decision in agricultural activities present study was conducted with following objectives:-

1. To know the socio-economic characteristic of rural farm women.
2. To study the decision –making pattern of farm women in different agricultural activities.
3. To ascertain the relationship between selected socio-economic characteristics with the decision – making pattern of farm women.

### Materials and Methods

When women are empowered they can claim their rights and access to land, leadership, opportunities and choices, economies grow, food security is enhanced and prospects are improved for current and future generations”, Michelle Bachelet – Under- Secretary –General and Executive Director of UN Women. The study was undertaken at Samastipur district which is situated in one of the state of India i.e., Bihar. Out of its 20 blocks 2 blocks namely, Pusa & Kalyanpur were selected purposively for the study. From these 2 blocks, 4 villages, 2 from each block i.e. Gorai, Madhurapur, Harpur & Mahmadda were selected. The selection was based on assumption that there was having maximum number of farm women involved in agricultural activities. A total of 100 respondents were taken for the present study. Keeping in view the objectives of the study, well structured interview scheduled was developed. The data was collected from the respondents through personal interview method. It has been shown through dig. No. 1

Dig. No. 1



## Results and Discussion

General information: The women respondents were categorized into four categories based on the size of land holding they possess i.e., landless laborers (having no land), marginal farmers (Upto 2.5 acres), small farmers (2.5 to 5.00 acres) and medium farmers (5.01 to 10.00 acres). No respondents were found having above 10 acres of land holding.

### Socio- economic information:

Table. 1: Distribution of respondents according to their caste, marital status, education level and land holding size

Sl. No.	Category		Landless (N=13) %	Marginal (N=45) %	Small (N=11) %	Medium (N=11) %	Pooled (N=100)
1	Caste	Forward	0.00	2.23	27.28	45.46	9.00
		Backward	30.31	86.67	72.73	54.55	63.00
		Schedule caste	69.70	11.12	0.00	0.00	28.00
2	Marital status	Married	81.82	84.45	100	90.91	86.00
		Widow	18.19	15.56	0.00	9.09	14.00
3	Education Level	Illiterate	87.88	44.45	27.28	18.19	52.00
		Read and write only	9.09	13.34	9.09	36.37	14.00
		Primary	3.03	31.12	54.55	18.19	23.00
4	Land-holding size		33	45	11	11	100

### Classification of the respondents Caste-wise Marital status and Education level possessing various landholding categories:

Caste of an individual is defined as a hierarchy of endogamous divisions in which membership is hereditary and permanent In this study, caste has been categorized as forward, backward and scheduled caste categories. It can be observed from Table no. 1, that 63 per cent of the respondents belonged to backward class followed by 28 per cent of scheduled caste and only 9 per cent of the respondents belonged to forward class and majority of them were from small and medium land holding category of farmers. The respondents were classified into two categories on the basis of their marital status viz., married and widow. Table no 1 also inferred that majority of the respondents i.e., 86 per cent were married followed by 14 per cent of widow respondents. No respondents were unmarried or divorced. Education is the individual's ability to read and write, and the amount of formal education possessed by them. In the present study, it refers to the extent of formal schooling undergone by the respondents. It also appears from Table 1, 52 that per cent of the respondents were illiterate, 23 per cent were having primary education, 14 per cent can only read and write, 7

per cent have middle education and only 2 per cent were high school passed and graduate. This has also been depicted in the fig. 1.

**Fig. 1. Distribution of respondents according to their caste, marital status, education level and land holding size.**

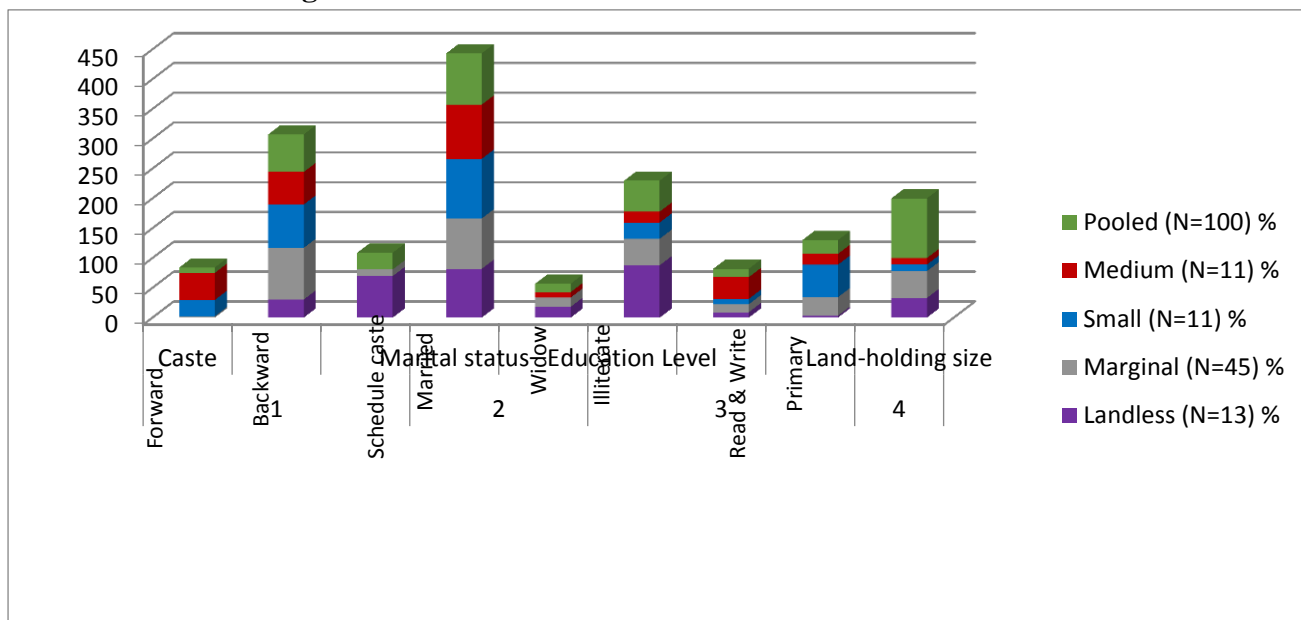


Table 2: Percentage Participation of women in overall decision – making pattern in Agricultural Activities.

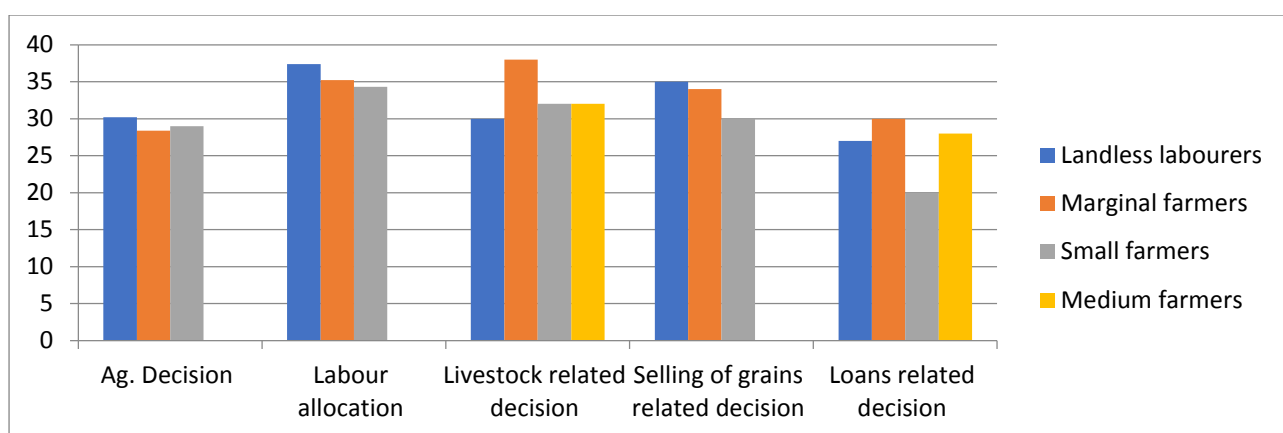
Sl. No.	Decision making area	Landless (N=13)	Marginal (N=45)	Small (N=11)	Medium (N=11)
A	Agriculture decision	0.0	20.22	13.64	14.54
B	Labour allocation decisions	0.0	28.89	22.72	18.18
C	Livestock related decision	21.21	40.0	27.17	27.27
D	Selling of crops related decision	0.0	37.78	31.89	20.45
E	Loan related decision	20.45	19.86	6.81	15.91
	All Farm related decision (mean)	20.08	29.35	20.47	19.27

Table no2 indicates that the mean score value of percentage participation of women farmers (i.e. landless, marginal, small & medium farmers) in decision making process–in different areas of agricultural activities.

- Agricultural decision – Table 2 showed 20.22 per cent marginal land holding women farmers took decision related to agriculture followed by 14.54 per cent medium land holding category of women farmers & 13.64% by small farmers respectively. Landless labourers do not participate in agricultural decision – making process. This result was also similar to study observed by Kumari A (2001) that men dominated women in making independent decision related to all the three sub areas of farm related decision namely crop production decision (81%),labour allocation decision (73.2%) and livestock related decisions (76.2%).

- Labour allocation decision –It is clearly indicated that 28.89, 22.72 & 18.19 per cent of marginal, small & medium land holding category of women farmers take decisions.
  - Livestock – related decision – It has been showed that 40 % of marginal land holding category of women farmers participated in livestock related decision followed by 27.27 % of medium & small land holding category of women farmers, 21.21 % by landless laborers.
  - Selling of grains related decision – 37.78, 31.89 & 18.38% of marginal, small & medium category of women farmers took decision related to selling of grains as show in table 2.
- Loan related decision – Table 2 showed that 20.45, 19.86, 6.81 & 15.92% of landless, marginal, small & medium land holding category of women farmers took decisions. This has also been depicted in the fig.

**Fig 2: Decision making pattern of four categories of women farmers in agriculture**



**Table 3: Coefficient of correlation between decision – making pattern of women farmers with the independent variables.**

Variable	Value of ‘r’
Age (X <sub>1</sub> )	-0.55
Cast (X <sub>2</sub> )	0.110
Marital Status (X <sub>3</sub> )	0.347**
Education respondent (X <sub>4</sub> )	0.045
Type of family (X <sub>5</sub> )	-0.119
Size of land holding (X <sub>6</sub> )	-0.006
Family income (X <sub>7</sub> )	-0.006
Domestic animal (X <sub>8</sub> )	0.046
Social participation (X <sub>9</sub> )	0.050
Knowledge level (X <sub>10</sub> )	0.050
Agricultural implements(X <sub>11</sub> )	0.036*

\*=Significant at 5% level of probability

\*\*= Significant at 1% level of probability

An individual’s contribution in decision – making has been found to be influenced by numbers of Socio-economic characteristics.

Table 3 showed that only marital status (r =0.347) & knowledge level (r=0.050) were found significant & positive with decision making pattern of rural women. All other independent

variables were non-significant. The variables age, type of family, size of land holding & family income were negative while caste, respondents' education, domestic animals & social participation were positive.

Lad, Wattamwar and Bothikar (2012) observed that majority of farm women (50.83%) were found in medium decision making category followed by 32.50 % in low decision making category, where as only 16.67 % in high decision making category.

It means majority of respondents involved in medium to low category of decision making in different categories.

### **Conclusion**

The study confirms the universal fact that women play a very crucial role and contribute a lot in income generation. Women's having more involvement in production process were participating more in decision – making process. It can be also as concluded from the study that women having higher educational status & knowledge level were participating more in decision – making process.

### **References**

- Brar, A.S., Gill, M.S., & Walia S.S (2007). Participation of women in decision making in agricultural in South –western Punjab. *J. Res. Punjab. Agri. Univ.* 44 (2) : 99-100
- Gondaliya, R.H. and Patel . J.K. (2012). Decision – making pattern of farm women in relation to selected different agriculture activities *Asian Science* . 7 :78-81
- Kumari A. (2001). Role of rural women in decision – making in farm & home activities. unpublished M. Sc. Thesis, RAU, Pusa.
- Lad, A.S. Wattam war., V.T. and Bothikom., G.R. (2012). Correlates of participation of farm women in decision – making *Agri. Sci. Digest* 32 (1) : 52-54.
- Sharma S., Rao P.K. & Sharma R. (2013). Role of Women in Decision making Related to Farm: A study of Jammu district of J&K State, *International Journal of Scientific and Research Publications*, Volume 3, Issue 1
- <http://www.fao.org/publications/sofateam/>.

## **INTERNATIONAL NETWORKING FOR RURAL AREAS SUSTAINABLE DEVELOPMENT: THE CASE STUDY OF A.M.A.R.-W.F.A.R.A.**

Adriano CIANI

General Secretary of AMAR-WFARA, University of Perugia, Italy  
Corresponding author: [adriano.ciani@unipg.it](mailto:adriano.ciani@unipg.it)

### **Abstracts**

The number 17 Goal of the SDG 2015-2030 entrusts us with the task of *Strengthen the implementation instruments and revitalize the global partnership for sustainable development*. In the paper is made the analysis of the role of the international networking to apply the new paradigms for the sustainable progress of all rural areas population around the world. The author sustain that is time to apply, as best practice, some experience with modern and updating vision concerning the achievement by the Rural Areas the base for to be transformed in this century in Smart Territories and Smart Communities.

He present the proposal of the implementation of a A.M.A.R.-W.F.A.R.A. (Associazione Mondiale di Amicizia delle Aree Rurali -World Friendship Association of Rural Areas) that it's in ongoing foundation with the launching on 22<sup>th</sup> April 2017 (the Earth Day) and signature of a MoU toward the final approval of the Statute in 2018.

The paper show all motivations, targets, structure and management of the A.M.A.R.-W.F.A.R.A. that will promote and will put in place all the actions at the local, national and international in order to make repeatable and transferable models of local development, and process and product innovations that could be, the same, repeatable and transferable and in meantime can contribute to the concrete improvement of quality of life in the rural areas around the world toward the Gross National Happiness indicator for it's measurement.

**Keywords:** *rural areas, international networking, smart territories, smart communities, sustainable development*

### **Introduction**

The 21th century is characterized for three challenge represented by the :Age of Sustainable Development, Green and Circular Economy , 4th Industrial Revolution. In this framework of reference is a strongly movement and approach a the vision of “act locally” and “think globally”. The world is in the way gradually to abandon the hold monocriterial approach to measure the level of development with the only one indicator of IGP-Internal Gross Product towards a substitution with a multicriterial approach trough high number of the indicators that minimum must take into account the economic, social, environmental, managerial and cultural aspects. The HLPF-High-Level Political Forum last July 2017 have left us that for the implementation of the 17 Goals and the 169 targets of Sustainable Development for 2015-2030(UN, 2015) we need to use 232 complex indicators (UN, 2017).In this way there are also a movement that try to substitute the IGP with synthetic indicator of development that must be measured trough the IGH –Internal Gross Happiness where the happiness same it's measured by a list of indicators of SWB-social well-being (SDSN, 2017) . The human world road map at the International Policy Level is to achieve for any people peace and happiness. This challenge anyway even must, day by day, running ,when meantime in many areas, special in the rural location , of the world we have hungry, deep poverty, the big problem of

the access(education, Energy, ICT, social and health services, etc.) and the safeguard and promotion of the territories.

The framework of reference require for all actors of the society and all stakeholders a strong change driving, in all the world and specially in the rural areas , any process of development for each Community in each own Territory, with the strictly observation of the vision *act locally and thing globally* .This because any Community need to accelerate the process and to avoid the mistake done in similar actions. In this way the updating networking that could contain also some dreams to be everybody citizens with acceptable level of happiness of the global village(*Mc Luhan, 1962*) in the current and future time.

In this vision the idea of a World Network of the Rural Areas have derived the practical application.

### Literature on issue

The networking it's a pillar of the society in 21th Century. Social network is a social structure made up of a set of social actors (such as individuals or organizations), sets of iterative and interactive exchange of knowledge , and other social interactions between actors. The networking is in continue evolution and more and more acquire prominent role in each development process. In fact the social network perspective provides a set of methods for analyzing the structure of whole social entities as well as a variety of theories explaining the patterns observed in these structures. The study of these structures uses social network analysis to identify local and global patterns, locate influential entities, and examine network dynamics.

Social networks and the analysis of them is an inherently interdisciplinary academic field which emerged from social psychology, sociology, statistics, and graph theory. In the late 1890s, both *Émile Durkheim(1882)*and *Ferdinand Tönnies(1887)* foreshadowed the idea of social networks in their theories and research of social groups. *Georg Simmel(1890)* authored early structural theories in sociology emphasizing the dynamics of triads and "web of group affiliations". *Jacob Moreno (1907)*is credited with developing the first *sociograms* in the 1930s to study interpersonal relationships. These approaches were mathematically formalized in the 1950s and theories and methods of social networks became pervasive in the social and behavioral sciences by the 1980s. Social network analysis is now one of the major paradigms in contemporary sociology, and is also employed in a number of other social and formal sciences. Together with other complex networks, it forms part of the nascent field of network science. The social network referred in the current time at many different types of relations, singular or in combination, form these network configurations. Network analytics are useful to a broad range of research enterprises. In social science, these fields of study include, but are not limited to anthropology, biology, communication studies, economics, geography, information science, organizational studies, social psychology, sociology, and sociolinguistics.

By the 1970s, a growing number of scholars worked to combine the different tracks and traditions. One group consisted of sociologist *Harrison White(1977)* and his students at the Harvard University Department of Social Relations. Also independently active in the Harvard Social Relations department at the time were *Charles Tilly(1988)*, who focused on networks in political and community sociology and social movements, and *Stanley Milgram(1977)*, who developed the "six degrees of separation" thesis *Mark Granovetter (2005)* and *Barry Wellman (2001)* are among the former students of White who elaborated and championed the analysis of social networks.

Beginning in the late 1990s, social network analysis experienced work by sociologists, political scientists, and physicists such as *Albert-László Barabási(2013)*, *James H. Fowler(2007)*, and others, developing and applying new models and methods to emerging

data available about online social networks, as well as "digital traces" regarding face-to-face networks. The dynamics evolution of the theoretical concept and the practice day by day of the networking open the perspective concrete to built a true egalitarian world village. (Dawes, C. T. & Others, 2007). For the rural areas very important is the contribution by Granovetter with his vision concerning the strong role in the development process and the improvement of the quality of life by the informal or weak network

### **Targets, Material and Method**

The paper has the target to demonstrate that for the Rural Areas to implement the SDG 2015-2030, the principles of the Green and Circular Economy and to go ahead in the way of the 4th Industrial Revolution it's essential to try to arrange an large International cooperation through a not formal and strong infrastructure but under the approach of the bottom-up and subsidiarity a profitable, repeatable, transferable, effective and efficient networking process. The materials used derive from a deep literature research about the origin, history and updating vision on the networking role in the society in the current time. After that was used the material derived by the memorandum signed by 39 partners of 20 countries the 22 April 2017 (the Earth Day 2017) creating the AMAR-WFARA (Associazione Mondiale di Amicizia delle Aree Rurali – World Friendship Association of Rural Areas). The method it's concrete empirical approach a sit show a practical case of networking.

### **Result and discussion**

*The aims of the Memorandum of Understanding signed the 22 April 2017*

The promoted document takes the inspiration by the framework of reference of the international policy of the main institutions at the world level. The same has the following contents:

#### **“TAKING INTO ACCOUNT**

*the documents of the UNGASS "Our Future City, (1987)", "The future we want" the WSSD in 2012 (Rio + 20), "Transforming our world: the 2030 agenda for sustainable development", with the promotion of SDG-2015 -2030, (2015), the Encyclical "praise You" by Pope Francis, (2015), l' "Paris agreement" of UNFCCC COP-21, (2015), l' "Marrakesh Agreement" of UNFCCC COP-22 (2015) Charter of the Milan 'Expo 2015' s "Marrakesh Agreement Uruguay Round in 1995," the objectives and conclusions of the 'international Year of the ground in 2015, the objectives of the Year International sustainable tourism for development in 2017, the Horizon 2020, the circular of the EU on 'circular Economy Principles, the CAP from 2014 to 2020, the II Cork Declaration of 2015, the Industrial Revolution IV-IV-RI 2016 and the strategy of SDG 2015-2030, the Declaration of Rome on 25 March 2016 by the EU,*

#### **VERIFIED TO EACH OTHER THE VOLUNTY**

*to put in value their own experiences inspired to improving the quality of life, in terms of economic, social, environmental, managerial and cultural, rural populations around the world and anchored in the principles of peace, intercultural and interfaith and on this basis of*

*create A.M.A.R. (World Association of Friendship of Rural Areas.*

#### **CLAIM UNDER THE VISION OF AMR-WFARA**

*that international cooperation, to achieve positive field results, it needs a coherent, comprehensive, operational plan of interrelations among peoples. All this to allow the gradual creation and placement of the elements that bind science as peace and solidarity instrument, through the use of technological innovations, increasing the friendly use and general accessibility. All initiatives must follow the guidelines of the ambitious program,*



which aims to achieve the creation of a "common house", the supply of scientific research on a global scale, involving in its planning at the level of the whole world, the potential that every reality socioeconomic can bring: in education, science and technology, and the "spearhead" of the necessary actions to support the culture of sustainable development. A scientific society in which the University can be once again the "Universita", as the starting point of a new Renaissance, a process related to each country and the Company throughout the world. What the multitude of young people living today needs to receive, are concrete signs of hope and freedom, leading to a more sustainable lives and livelihoods, and overcome the current systematic way of working, which dominates our modern times "like a prison" in order to achieve a happier and sweeter now.

The AMAR-WFARA Association aims to improve a method of administration of the territories can ensure - through continuous monitoring - development, good quality of life, and the protection of environmental resources, especially the landscape and biodiversity. In this sense, science must facilitate the removal of barriers, the ancestral values of ancient societies often imprisoned and put in the shade, not to be dealt with as if they belonged in a museum rather with the spirit of rebirth and rediscovery: a type of science that values have but especially being. The growth of associations like AMAR-WFARA stand out even more, as a conscientious window along with their spirit of analysis, and expertise offered by all of the Autonomous Communities' Clubs in the World level.

AMAR-WFARA takes as the keyword "TRADI-OVATION" (TRADITION-INNOVATION) (for short) stands for "Territory, Rural Areas, through the Development, Innovation, Organization, Promotion, user friendly, Technology, ICT sharing, Networking, Online".

SHARE THAT THE OBJECTIVES OF AMAR ARE REPRESENTED BY:

#### **1-The Sustainable Development Goals SDG-2015-2030**

AMAR has primarily aims to promote at local and International level the objectives of the Agenda for Sustainable Development for the period 2015-2030 as a result reported.

1. Put an end to poverty in all its forms, anywhere.
2. Ending hunger, ensuring food security, improving nutrition and promoting sustainable agriculture.
3. Ensuring a healthy lifestyle and promote the welfare of all for all ages.
4. Ensure all inclusive education and promoting life long learning opportunities and fair quality.
5. Achieving gender equality by empowering women and girls.
6. Make sure all the availability and sustainable management of water and sanitation.
7. Ensure the availability of affordable energy, reliable, sustainable and modern for all.
8. To promote an inclusive economic growth, sustained and sustainable, full and productive employment and decent work for all.
9. Build a solid infrastructure, promote inclusive and sustainable industrialization and foster innovation.
10. Reducing inequalities within and between countries.
11. Create sustainable human settlements and towns that are inclusive, safe and sound.
12. Ensuring sustainable consumption and production patterns.
13. Take urgent measures to combat climate change and its consequences.
14. Store and sustainable use of the oceans, seas and marine resources for sustainable development.
15. To protect, restore and promote the sustainable use of terrestrial, manage forests sustainably, combat desertification, halt and reverse land degradation and halting the loss of biodiversity.
16. Promote peaceful and inclusive societies for sustainable development, ensuring that every one has access to justice and create effective, accountable and inclusive at all levels.

*17. Strengthen the implementation instruments and revitalize the global partnership for sustainable development.*

## **2-The objectives of CORK 2.0**

*AMAR makes its own decisions of the 2nd Declaration of CORK-5-6 September 2016 better known as CORK 2.0 and with the title "Improving the quality of Life in Countryside e" that encloses the 10 points indicated hereinafter*

- 1. To promote prosperity in rural areas*
- 2. Strengthening the value chains in rural areas*
- 3. Investing in accessibility and in the viability of rural areas*
- 4. Preserving the rural environment*
- 5. Managing natural resources.*
- 6. Encourage the climate action*
- 7. Stimulating the knowledge and innovation*
- 8. Strengthening governance of rural areas*
- 9. More targeted policies to results and simplification*
- 10. Improve the performance and responsibilities*

## **3-The Principles of the Charter of Milan EXPO 2015**

*4-AMAR will promote and will put in place all the actions at the local, national and international in order to make repeatable and transferable models of local development, and process and product innovations that are repeatable and transferable and can contribute to the development of quality of life in rural areas around the world with objective reference pillar of National Gross Happiness.*

### **GIVE MANDATE TO THE ORGANIZING COMMITTEE**

- -to prepare the Statute and the Regulations AMAR on the basis of the attached Draft that is an integral part of this Memorandum (Annex 1)*
- -to bring locally, nationally and internationally every action and take action to widen to as much 'as possible the number of partners in the project;*
- to activate the Web Site;*
- to start fund raising activities, crowdfunding, required funding and sponsorship and to open special c / bank account;*
- to prepare logo can also through local or international bid, but at no cost;*
- to initiate contacts with all national and international institutions that may be involved in the establishment of AMAR;*
- to create a temporary stamp and a simple letterhead with the words in Italian and English AMAR based at the Municipality of Montecastrilli.*

*The undersigned and adherent subjects of the Memorandum*

### **COMMIT THE ORGANIZING COMMITTEE**

*to prepare and report between now and the date of April 1, 2018 with a special payable quarterly report of the President and Secretary General, on the progress of the assigned the same step, at least in Italian and English, and to prepare everything necessary for the Notarial Act Official creation of AMAR in the next edition of Agricollina in 2018. “*

*At this document have, with direct signature the date of 22 April 0217 or previous official letter 39 different subjects represented by Ngo, LAG, Municipalities, Villages,*

Universities, Entreprises, declared the direct involvement till July 2017 number 39 partners by 20 countries of all 5 Continents.

Now we are ongoing to prepare the International Statute and Regulation trough the activity of the Staff of General Secretary and the Presidence Commission. The targets is to achieve for the next Earth Day that will be the 22 April 2018 the Official Foundation with a noter act the AMAR- WFARA. And to increase the activities and acquire a strong role a the International Level as important stakeholder concerning the Rural Areas Policy all around the world.

### Conclusions

The paper has shown that the networking, specially for the rural areas it's a very important modality try to achieve the SGD for the Sustainable Development Agenda 2015-2030.

The study case of AMAR –WFARA have permitted to achieve a result very positive that encourage the perspectives of the increasing and improving of the networking for development to create the basis in all the world to transform the weakness of the rural areas in a opportunities of development .In this way it's crucial a very strong campaign of the use and diffusion of the ICT and suitable and friendly platform to put inside a intuitive and concrete useful and appointed services for the Local Population . All of this to create a world situation for all rural areas to be smart, sustainable and inclusive. To transform the vision of the smart cities and smart lands in a Smart Communities and Smart Territories.

### References

- Barabási A.L. & Barzel B., (2013), "*Universality in Network Dynamics*", *Nature Physics* 9, 673–681 (2013) "Universality in Network Dynamics", *Nature Physics* 9, 673–681 (2013)
- Dawes, C. T.; Fowler, JH; Johnson, T; Mc Elreath, R; Smirnov, O (12 April 2007). "*Egalitarian Motives in Humans*" (PDF). *Nature*. **446** (7137): 794–796. PMID 17429399. doi:10.1038/nature05651.
- Fowler, J. H.; Kam, C. D. (August 2007). "*Beyond the Self: Altruism, Social Identity, and Political Participation*" *Journal of Politics*. **69** (3): 811–825. doi:10.1111/j.1468-2508.2007.00577.x.
- Durkheim E., (1982). *The Rules of Sociological Method*. Simon and Schuster. pp. 2–. ISBN 978-0-02-907940-9. Retrieved 17 March 2011.
- Granovetter, M. (2005). "*The Impact of Social Structure on Economic Outcomes*". *Journal of Economic Perspectives*. **19**: 33–50. doi:10.1257/0895330053147958.
- Harrison C. W. (1995), *Social Networks Can Resolve Actor Paradoxes in Economics and in Psychology*, *Journal of Institutional and Theoretical Economics*, 151:58-74.
- Milgram, S. (1977), *The individual in a social world: Essays and experiments*. 3rd expanded edition published 2010 by Pinter & Martin, ISBN 978-1-905177-12-7.
- Mc Luhan M., (1962), *The Gutenberg Galaxy: The Making of Typographic Man*, Toronto, Canada: University of Toronto Press. p. 293. ISBN 978-0-8020-6041-9.
- Moreno, J. L. (1934). *Who Shall Survive? A new Approach to the Problem of Human Interrelations*. Beacon House. ISBN 978-9992695722
- Simmel G.,(1908), *Soziologie,-Sociology : inquiries into the construction of social forms-*, Leipzig ,Duncker & Humblot, 1908
- SDSN, (2017), *World Happiness Report*, Editors: John Helliwell, Richard Layard, and Jeffrey Sachs, <http://worldhappiness.report/wp-content/uploads/sites/2/2017/03/HR17.pdf>

- Tilly C. (1988). "Misreading, then Rereading, Nineteenth-Century Social Change." Pp. 332–58 in *Social Structures: A Network Approach*, edited by Barry Wellman and SD Berkowitz. Cambridge: Cambridge University Press.
- Tönnies F., (1998) *Complete Works (Ferdinand Tönnies Gesamtausgabe)*, 24 vols., critically edited by Lars Clausen, Alexander Deichsel, Cornelius Bickel, Rolf Fechner (until 2006), Carsten Schlüter-Knauer, and Uwe Carstens (2006– ), Berlin/New York: Walter de Gruyter (1998– )
- UN,(2017)*Report of the Inter-Agency and Expert Group on Sustainable Development Goal Indicators (E/CN.3/2017/2), Annex III*, <https://unstats.un.org/sdgs/indicators/indicators-list/>
- Wellman B.,(2001) "Computer Networks as Social Networks." *Science* 293 (September 14, 2001): 2031-34

## SUSTAINABLE TOURISM AND RURAL AREAS DEVELOPMENT: THE CASE STUDY OF MUNICIPALITY OF SACHKHERE IN GEORGIA

Adriano CIANI\*<sup>1</sup>, Meri KHVEDELIDZE<sup>2</sup>, Kumar Prasad BHATTA<sup>3</sup>, Annalisa GAMBARDELLA<sup>4</sup>

<sup>1</sup>Perugia University, Italy

<sup>2</sup>Tbilisi State University, Georgia

<sup>3</sup>Tokyo University of Agriculture, Department of International Agriculture Development, Japan

<sup>4</sup>Freelance, Italy

\*Corresponding author: [adriano.ciani@unipg.it](mailto:adriano.ciani@unipg.it)

### Abstracts

The 2017 is declared the International Year of Sustainable Tourism for Development. The authors demonstrate that the Agritourism and Rural Tourism are the main important forms of Sustainable Tourism that can contribute at the innovative and inclusive Local Development because are linked respectively with the agricultural or others activities in the rural areas.

Georgia is a prevalent mountainous country with till current time an high relevance of the agriculture and the other production sectors disseminate in the rural areas. The authors present the analysis of the potentiality of these two forms of Sustainable Tourism in Georgia through the territorial analysis and presentation of the SWOT. In this framework they make a concrete case study that is referred at the Municipality of Sachkere in the Western part of the Country. The municipality contains 13 administration units and have 54866 inhabitant, the relief is average and low mountainous, with many natural resources and rich with historical and touristic objects. The culture and tradition of the territory joint with a typical food, drinks and handcraft and textile represent the important elements on which to set up the growth of the Agritourism and Rural Tourism and the creation a sample of model for all the Georgia and the Others Caucasus Area.

**Key Words:** sustainable tourism, agritourism, rural tourism, local development, Georgia Country

### Introduction

The rural development model established in the last twenty years attaches particular importance to the productive diversification of a territorial context and recognizes the opportunities that rural tourism can offer to those areas that are no longer competitive due to the dynamics of markets and the evolution of agricultural policies. It can, in fact, bring a number of benefits from the economic, social, cultural and environmental point of view, provided it is characterized by an intersectoral, integrated, endogenous, sustainable and qualitative development process.

The territory represents the size from which to start to interpret the characters of sustainability. From its distinctive features and its peculiarities, it is possible to intercept and orient the trajectories necessary to a more sustainable development in terms not only of economic but above all social, environmental and generational (*Cesaretti 2011, Ciani 2015*)

The territory becomes a place where social, political, cultural and economic relations are developed and consolidated (*Ciani 2015, Granados Cabezas 2015, Valls & Porta 1997*). In this context, the different subjects, the different activities and components that characterize a territory become the protagonists of its success. From this point of view, it is crucial to re-read the territories in the light of a multidimensional and integrated vision of their

specificities, but above all in the light of a new culture of rurality. The latter is to be understood as a living expression of increasingly diverse and multifunctional agriculture strongly rooted in the territory, environmental and landscape resources increasingly integrated into identity and innovation matrices, relational and institutional assets based on sustainability-oriented systems (*Andreupoulou, Cesaretti, Misso 2012*)

Sustainable development of tourism is one of the challenges launched by Europe's main travel destination in the world: a challenge that Georgia can gather through its cultural and environmental artistic heritage. Tourism contributes to economic growth and job creation.

According to the definition provided by WWF, sustainable tourism must be able to "coexist, in the short and long term, the expectations of residences with those of tourists without diminishing the qualitative level of tourist experience and without harming the environmental values of the territory".

### **Rural Tourism and Sustainable Development**

#### *General Overview*

Over the years, definitions and general principles of sustainable tourism have been identified in a number of important documents such as the "European Charter for Sustainable Tourism" 25 of 1995, the Charter "Tourism: Basic Principles for Sustainable Development" .The WTO (World Tourism Organization) in 1996 and the Berlin Declaration on "Sustainable Tourism and Sustainable Development" of 1997, the result of the International Conference of Environment Ministers on Biodiversity and Tourism. Integration between the environment and tourism and sustainability considerations become fundamental issues in the field of rural tourism development, as it is an activity closely linked to natural resources and small local communities. (*George & Other 2009, Cohen 1988, Hunter 2002*)

#### *Sustainable Tourism and Sustainable Development Goals*

In 2012 at the Rio + 20 Conference on Sustainable Development, the United Nations declared that well-managed and well-managed tourism contributes to sustainable economic, social and environmental development (*Sachs, 2015*) All seventeen can be a priority for tourism, but it is explicitly provided for three: SDG 8 (tourism as a driver for global, lasting and inclusive economic growth, already able to provide jobs every eleven in the world) ; SDG 12 (tourism that adopts sustainable patterns of consumption and production can accelerate the global transition to sustainability) and SDG 14 (coastal and maritime tourism - the most important in terms of global turnover and especially for the development of small states Is closely related to the well-being and defense of the marine ecosystem). (*E. Marchiafava, 2017*).

#### *The Benefits of Sustainable Rural Tourism*

Achieving the goals of sustainable development, as they are rich in natural, but also cultural and social resources. For these territories, quality rural tourism is an opportunity for development thanks to the many benefits it can make from the economic, social, cultural and environmental point of view (*Kaján, & Saarinen 2013, Lane, 2009*). It can therefore be stated that tourism can play an important role in the development of rural areas thanks to its high expansion capacity, for which the benefits will not be limited to the economic sphere but will also affect the protection of the environment, culture and quality of life of the host population, activating a virtuous circle of valorisation of both resources and local activities.

#### *Rural tourism and agriculture*

The rural area has a strong agricultural characterization of the use of local resources and a centrality of agriculture in the landscape and in landscape management; here agriculture maintains a primary position in cultural terms, though not in economic terms from a

"functional" point of view, the rural world is characterized by its multifunctionality (Ohe Y. (2007). Within the rural area, the following functions are integrated:

- "economic": agricultural production, raw materials, crafts, tourism and recreation ";
- "environmental ": safeguarding the very bases of life (soil, water, air), protection of biotypes and landscape, conservation of biodiversity ";
- "socio-cultural": preservation of the socio-cultural characteristics of local communities.

Agriculture, while being one of the many components of the economic, social, cultural and environmental structure of a rural area, plays a central role in these areas, as it is still strongly present and decisive in the local system. Traditional farming, which distinguishes rural areas, provides the basis for the development of sustainable rural tourism

### **Analysis of the potentiality of Sustainable Tourism in Georgia**

#### *Territorial Analysis Synthesis and Potentiality of Sustainable Tourism in Georgia*

Georgia, country of Transcaucasia located at the eastern end of the Black sea on the southern flanks of the main crest of the Greater Caucasus Mountains. It is bounded on the north and northeast by Russia, on the east and southeast by Azerbaijan, on the south by Armenia and Turkey and on the west by the Black Sea. Georgia is spread over 69,700 km<sup>2</sup> with a population of 37 million people. Other ethnic groups include Abkhazians, Armenians, Assyrians, Azerbaijanis, Greeks, Jews, Kists, Ossetians, Russians, Ukrainians, Yezidis and others. The Georgian Jews are one of the oldest Jewish communities in the world. Once Georgia was also home to significant ethnic German communities, but most Germans were deported during World War II. Conservation International has identified the Caucasus region as a global "hotspot", that is one of the 25 most biologically rich and *most endangered* terrestrial ecosystems in the world. These hotspots have been identified based on three criteria: the number of species present, the number of those species found exclusively in an ecosystem and the degree of threat they face (USAID 2000,FAO 2015).

*The term "Georgian" does not derive from Saint George but from the ancient Persian Gurgor Gorg, meaning wolf, "supposedly a totemic symbol, or from the Greek "georgios" ("farmer," "cultivator of land"). Starting from the early 16<sup>th</sup> century, although certain aspects of more recent times were already incorporated since the 12<sup>th</sup> century, until the course of the 19<sup>th</sup> century, Georgian culture became significantly influenced by Persian culture. During the modern period, from about the 17<sup>th</sup> century onwards, Georgian culture has been greatly influenced by cultural innovations imported from elsewhere in Europe.*

Georgian culture suffered under the rule of the Soviet Union during the 20<sup>th</sup> century, during which a policy of Russification was imposed but was strongly resisted by many Georgians. Since the independence of Georgia in 1991, a cultural resurgence has taken place, albeit somewhat hampered by the country's economic and political difficulties in the post-Soviet era.

Georgian cuisine is considered one of the main attractions for tourists in Georgia, and it is particularly popular throughout the former Soviet Union..

The importance of both food and drink to Georgian culture is best observed during a feast, or supra, when a huge assortment of dishes are prepared, always accompanied by large amounts of wine, and dinner can last for hours. In a Georgian feast, the role of the *tamada* (toastmaster) is an important and honoured position.

The Georgian economy includes diversified and mechanized agriculture alongside a well-developed industrial base. Agriculture accounts for about half of the gross domestic product and employs about one-fourth of the labour force; the industry and service sectors each employ about one-fifth of the labour force. About rural areas, poor diversification of the rural

economy and the low productivity of the agricultural sector underpin the chronic weakness of the rural economy. In fact, more than 48% of the total added value is created in Tbilisi, which shows that the urbanization level of Georgia's economy is very high.

Georgia's typical food products are probably the most important attraction in the country. Since the traditional Georgian festival is an integral part of culture, Georgian entertainment should match its top level. The Georgians have been able to make their cuisine not only magical delightful but also bright, original, exquisite, unique and unforgettable.

### **The study case of Municipality of Sachkhere in Georgia**

#### *The Municipality of Sachkhere*

Sachkhere is a town at the northern edge of the Imereti Province in Western Georgia. It is the center of the Sachkhere Municipality. The relief of Sachkhere Municipality is average and low mountainous. From minerals sulphury water of Kvereti, quartz sand and marble are considerable.

There are 54866 inhabitant in the municipality of Sachkhere and many of them are Georgian, only few of them are Ossetian, Russian and Jewish.

On the territory of the municipality there are the following reservoirs deposits:

- Ceramic clay ore of "Perevi";
- Marmorous limestone of the Skitator (Bajte District) ;
- Sachkerer limestone (II degree calcium cigar) ;
- Lashuri (175m) clay ore, stock;
- Quail-sourced sand quarries, supplies;
- Jruchula's sand-gravel;
- River Exposure of inert materials to Kvirila and Chikhura;

Farming is a major contributor to the economy of Sachkhere. Alva LLC estimates that there are 4,000 small and medium-sized farms and ranches in the region, supported by a program of technical assistance sponsored by USAID and administered by the Farmer-to-Farmer program of CNFA.

The agricultural lands hold about 17 380 hectares, which is 22.5% of the total area and approximately 60,000 ha (78%) are covered by forests. In Sachkhere Municipality agriculture is the main source of income for the population, despite the scarcity of agricultural lands. In recent years the agricultural land area has not decreased, but land degradation has been caused by erosion processes. According to the information provided, 5% of agricultural land is eroded. Apparently, one of the causes of erosion is excessive grazing because the municipality faces this problem. In the municipality of Sachkhere arable land resources are scarce and only 7 962 hectares. Cultivars are the priority cultures: maize, beans, vine and fruit. The yield of maize is 3-3.5 t / ha, the tree fruit - 6-6.5 t / ha, the beans - 1.8-2 t / ha and the vines 4-5 t / ha. According to the Municipality data, as of 2012, the administrative unit has 24 200 souls of cattle. 0.3 ha of hay cattle come in one of the cattle. As the calculation shows, the livestock are suffering from hay-grassage deficiency. The reason for the lack of hay-pastures is the excessive grazing and drought. Passing through the municipality is one of the causes of erosion.

Forest resources are large in Municipality of Sachkhere. The main problems related to forest resources are forest cutting (including illegal), which seems to have a growing trend and a significant reduction in windbreaks. Forest cutting can be the reason for the rise of natural threats.

In consideration at this reality the perspectives of Sustainable Tourism in Sachkhere have very high potentialities.



*The SWOT of Sustainable Tourism in Georgia*

The SWOT of the Strategic Plan of Sustainable Tourism it's show in the following Fig1.

**Figure 1\_ SWOT Analysis of Sustainable Tourism in Georgia**

<b>Strengths</b>	<b>Weakness</b>
<b>Natural attractions:</b> <b>Rich Tradition&amp; Culture</b> <b>Handicraft:</b> <b>Typical products</b> <b>Friendly and laborious people</b> <b>Upgrading road connectivity</b> <b>Near from capital city</b> <b>Inside a the attractive Caucasus area Recent local-level restructuring</b>	<b>Human Resources:</b> <b>Traditional Technology</b> <b>Quality products and services</b> <b>No Irrigation</b> <b>Soil Erosion</b> <b>Road system specially in rural areas</b> <b>Internal Transportation System</b> <b>Professional Organizations</b> <b>National Policy Role of the Local Community</b>
<b>Opportunity</b>	<b>Threats</b>
<b>Government policy</b> <b>The gradual increment of the international visitors</b> <b>Workforce</b> <b>Development spirit and commitments:</b> <b>Improve the the incomes of the small farmers</b> <b>Improve the cash follow of the small farmers</b> <b>Introduction and diffusion of the ICT</b> <b>Improvement of the quality of life in the rural areas</b> <b>Increasing of the small business network in the Country</b>	<b>Termination of interest of the people</b> <b>Competition</b> <b>Natural disasters</b> <b>Failure of the local participation Not activation of the Local Community</b> <b>Failure of the Pilots Project</b> <b>Gap between policy and not enough financial resources</b> <b>Loss of the traditional behaviour</b> <b>Gradually broken of the social cohesion in the Villages.</b>

\*Source: Author s' elaboration based on the obtained result.

**Results, discussion and open questions**

One of the primary factors of the project success is the appropriately formulating the project. On the other hand, proper formulation of the project depends upon the quality and reliability of the available data. Thus, the first step of the project should be on the in-depth study and analysis of the local conditions and confirmation such that it can have an influence and significance into the national level strategy of Nepal for developing the sustainable tourism. Particularly, agricultural sector of the remote village should be linked with the agritourism. The collection of proper data, analysis of it and the involvement of the local community remains the major aspect of the project success.

**Conclusions**

The preliminary result of the pre-feasibility analysis of the project provides the clear picture that developing National Plan for Sustainable Tourism in Georgia needs to focus on the agritourism. It can be argued on the basis of information gathered in the project development phase. Furthermore, agritourism can also be a very successful way of improving the sustainable development of the agriculture. This concept is more evident in case of Sachkhere Municipality where the aforementioned strengths are more incisive. Nevertheless, the successful implementation of the project first needs the introduction of a strategy at the national level that try to implement the opportunities of the new paradigm as:

- *The didactical and socially inclusive farms for expanding the provision of service of the farmhouse with the educational farm service that can also include direct participation of young people and children in sharing the know-how of some of the family farm production such as homemade breads, jams, crafts etc.;*
- *Territorial laboratory to support in the activity of agricultural enterprises to be transformed through activities of inclusion for the individuals who are more vulnerable and marginalized that can be an instrument in facilitating the social cohesion.*
- *"farm culture and heritage museums", the training and professional learning, the renewable energy production, the short food chains, the restaurants of local food, the landscape promotion and fruition, the leisure time.*

This could activate a vital process of transformation of the rural areas which we call the *Green Virtuous Territorial Circuit*.

The farmers are those that can guarantee the continuity of supply of these services. The territory should be understood as an intelligent cognitive system that educates and makes learning as the cornerstone in building this perspective. It is demonstrated that the *Territorial Management Contracts*, the activation, and exploration of good management practices and promotion of the area are the concrete model which can ensure the *viability of good quality of life and well-being* in the rural areas.

The exploratory analysis is ongoing and future activities could permit to achieve the targets of the project.

### References

- Andreupoulou Z, Cesaretti G.P., Misso R., "Sostenibilità dello sviluppo e dimensione territoriale, il ruolo dei sistemi regionali a vocazione rurale", 2012, <http://www.agriform.org/disco2/pdf/07/07C01.pdf>
- Ciani A, Fagioli F.F., (2015), Territory: A Living Book To Be Able To Read Which Inspires and Contaminates Feelings of Wellbeing, Florence "Sustainability of Well-being" International Forum 2015: "Food for sustainability and not just food" Florence SWIF 2015, 4-6 June 2015, Agriculture and Agricultural Sciences Procedia, Elsevier, 8(2016) Pag 339-335
- Ciani, A. (2012), The Rural Tourism and Agritourism : a new opportunity for agriculture and rural areas (Between Pluria-activity, Multifunctionality, Sustainable Development Strategy and Green Economy Growth), In Atas do VIII-CITURDES– Congreso Internacional de Turismo y Desenvolvimento Sustentavel "Turismo rural em tempos de novas ruralidades", Chaves, UTAD)
- Ciani A. (2014), Exploring best practices in territorial management for rural tourism and agritourism, Proceedings EAAE 2014 Congress, "Agri-Food and Rural Innovations for Healthier Societies", Ljubljana
- Cinti D, (2009) Turismo rurale e progetto di paesaggio, <https://agrireregionieuropa.univpm.it/it/content/article/31/20/ruralita-e-turismo>
- Cohen, E. (1988), Authenticity and commoditization in tourism, *Annals of Tourism Research*, (15), 371–386.
- George and Oth. (2009), *Rural Tourism Development: Localism and Cultural Change*, MPG Book Limite
- Granado Cabezas V., (2009); Sustainable Management of Territory as key element for tourism development, in Enzo Paci Paper, Vol 6, UNTWO
- Hunter, C., (2002) "Aspects of the Sustainable Tourism Debate from a Natural Resources Perspective" in *Sustainable tourism – a global perspective*. edited by: Harris R., Griffin, T. and Williams P. Oxford: Butterworth-Heinemann.

- Kaján, E., &Saarinen, J.,(2013)Tourism, climatechange and adaptation, *Journal Sustainability*  
A review. *Curr. IssuesTourism* ,16, 167–195
- Lane, B. (2009)“ThirtyYears of SustainableTourism: Drivers, Progress, Problems—and the  
Future”, in *Sustainable tourism future*, edited by: Gossling, S.,Hall, M., Weaver, D.  
New York: Routledge, 2009
- Marchiafava E.(2017),, L’anno del turismo sostenibile, 2017,  
<http://www.ilpost.it/emanuelamarchiafava/2017/04/11/turismo-sostenibile/>
- USAID (2000), *Biodiversity Assessment For Georgia*, Task Order Under TheBiodiversity &  
Sustainable Forestry Iqc (Biofor), Washington E&E Bureau, Environment & Natural  
Resources Division, Chemonics International Inc. Washington, D.C. February 2000
- FAO(2015), *Georgia at a glance*, <http://www.fao.org/georgia/fao-in-georgia/georgia-at-a-glance/en/>
- Ohe Y. (2007). “Multifunctionality and rural tourism: a perspective on farm diversification”,  
*Journal of International Farm Management*, n.4.
- Sachs J., (2015, *The Age of SustainableDevelopment*, Columbia Univeristy Press, ISBN-13:  
978-0231173155, Pag 543, New York
- Sack R.D. (1986),*Human Territoriality: its theory and history*, Cambridge University Press,  
Cambridge.
- UNGASS-United Nation General Assembly,(2015),*Trasforming OurWordl:the Agenda 2030  
for Sustainable Development* ,25th September 2015, New York, A/RES/70/1
- Valls J.F.&Porta F, (1997),*Sustainable tourism and economy; Territory and heritage*,

## **FOOD WASTE AND LOSSES: INITIATIVES FOR SUSTAINABLE DEVELOPMENT**

Rosalina GRUMO, Simona GIORDANO\*

University of Bari “Aldo Moro”, Bari, Italy

\*Corresponding author, simo\_giordano@yahoo.it

### **Abstract**

Rural exodus represents a major cause of urbanization processes in Third world countries. This phenomenon is particularly evident where the failure of markets regulatory mechanisms together with the lack of governance of the agroindustrial sector on an international scale have brought about several effects on a market where global dynamics prevail over local ones. Global food scenarios show a deep contrast between extreme hunger on one side, and food waste and losses on the other one. Therefore, the real issue to take into consideration is not the lack of food but its limited access, or no access at all, especially in less developed countries, as well as the inability of the agricultural sector to play its historical and fundamental role of socioeconomic growth booster. The mentioned subject matter, in particular, has been ignored for a long time, thus resulting in a current limited availability of data and of specific literature and bibliography. Recently there has been a growing interest in this theme, due to its relevance in facing environmental, economic and social challenges. The considered scale is both international and Italian, through the employment of a territorial approach. The identified initiatives consider the phenomenon of waste and losses in a global aspect and refer to companies, foundations and organizations of the large scale retailer sector.

**Keywords:** Sustainable agriculture, Rural development, Food waste, Governance, Food supply chain, Global famine

### **Introduction**

The global scenario is characterized by the abandonment of the countryside as a result of the urbanization process that has reduced the presence of arable land and has produced a scarcity of food resources. A scientific approach detects a two-way relationship between agriculture and hunger and poverty. About three-quarters of the world's poor people live in the rural areas of underdeveloped countries and derive their main livelihood from subsistence agriculture on marginal areas. However, there is also a relationship between hunger generated by food insecurity and poverty. The strategies of the rich countries in the primary sector have predicted major material interventions (construction of irrigation networks, processing facilities, machinery for working the land) to provide modern skills in countries with predominant traditional agriculture, leaving the beneficiaries in condition of dependence.

Great importance has been given to the theme of food waste in the last years and this has brought to a considerable increase of scientific research on the topic. The European project FUSIONS<sup>12</sup> is a clear example of this, and a great deal of recent research has been carried out within this project. Significant importance is also to be given to factors that concern population growth that makes the gap between demand and domestic supply of increasingly growing quantities of food and other environmental issues as population pressure on natural

---

<sup>12</sup> Cf.: <https://www.eu-fusions.org/>

resources in rural areas often results in degradation and resource depletion. In the face of agricultural production that is increasing faster than the population and the availability of sufficient food to feed twice the entire global population, so as to determine the waste phenomenon or even to over-nutrition, it raises a paradox concerning the presence of people who suffer from hunger (about one billion). So the problem is not related to lack of food but is linked to the accessibility of the food source. The contribution is intended to offer some reflections on the various issues mentioned in the international and Italian scale, through a regional economic approach and aims to analyze the phenomenon of food waste by focusing on rural areas and their development, on the food chain and the waste phenomenon finally, highlighting the strategies adopted by companies and international bodies for the redistribution of food and implementation of sustainable development.

### **Materials: Global Food supply chain, with particular reference to Italy**

Nowadays, the primary sector goes through a phase of profound transformation, if not even of revolution, that regards agriculture and, more in general, agri-food supply chains<sup>13</sup>, intended as the set of all the stakeholders playing a role in the production of a certain final product; from raw materials purchase to transformation, to delivery of the end product to consumers. These stakeholders are actors of different nature: production enterprises and workers, including representatives of the same category and trade associations, consultants, brokers and traders, institutional bodies and consumers organizations. In particular, the world of institutions and administrations play a vital role through intervention in support and regulation of all the activities and phases of the supply chain itself. Different attributes can be used to qualify a supply chain: long or short, regional or national up to global, with different concentration levels at various stages of production and, finally, a stable or variable composition in relation to the strength of the relations between all the stakeholders. The combined effect of increased speculative activities on commodities and protectionist decisions from some countries regarding governance, has resulted in a significant markets volatility, increasingly globalized and open to the entry of new potential operators and new categories of consumers. As a consequence, it is possible to encounter an upheaval of the traditional competitive equilibrium and, to an increasing extent, the spread of new technological applications. All the above mentioned elements are accompanied by a parallel restructuring of the same equilibrium of agricultural and food systems. New competitive structures are determined both from the production and from the distribution side, that, according to the different ability to control all the phases of the supply chain, cause a smaller or greater imbalance in the allocation of the value between the operators, often to the detriment of farmers and consumers.

The European agricultural sector is experiencing a phase of decisive and complex restructuring characterized by elements such as: the decrease in employment, the aging of the operators and the lack of generational change, the arrival of new immigrant labor force, the extreme heterogeneity of types of farms (ranging from small family businesses to large capitalist realities, with higher financial resources, particularly in the enlarged Europe scenario), whose different needs and priorities require specific policies.

The current global economic environment, characterized by the above elements as well as continuous innovations and evolving relationships, requires policies regarding agriculture and, in particular, the agri-food sectors to adapt to the mentioned environment, in view of the considerable complexity of the systemic interrelations. There is, therefore, a clear need to

---

<sup>13</sup> Cf.: Gereffi G., Humphrey J., The governance of global value chains, *Review of International Political Economy*, 12-1, pp.78-104, 2005.

break the isolation of the Common Agricultural Policy (CAP) and to integrate it into an overall framework of governance for agricultural and food systems in the European Union, in harmony with all other Community policies.

The global food system shows a series of paradoxes, examined below, that make it necessary to rethink the entire food supply chain, from production to transformation and consumption, in order to make it more efficient and sustainable; the creation of a viable long-term alternative to common practices such as "land grabbing", the increasing intensification of agriculture through the use of a massive use of fertilizers and pesticides, and the introduction of genetically modified organisms (GMOs).

The lower technological innovation capacity and the lack of openness to global markets have caused, in the last decades, an increasing gap of growth in Europe compared with other industrialized countries<sup>14</sup>. Notwithstanding the above, it is interesting to note that, compared to other world economies, the United States and the European Union recorded the highest values related to trade in goods<sup>15</sup>; in 2013, the EU-28 recorded exports for about 1.736,6 trillion euro, the highest value in international trade. China and the United States follow at short distance, with 1.663,3 trillion euro and 1.188,2 trillion euro, respectively. The United States have experienced a decrease in their relative weight in recent years, especially in exports, starting from 2007, that is the year when China overtook the US and became the second largest exporter of goods, after the EU-28.

The Italian economic scenario is in line with the above mentioned "picture", in relation to a production system characterized by low tech industries, suffering strong competition from emerging countries. In this context, the agri-food sector has been a resource for the country, showing substantial stability and contributing positively to the growth of the domestic product; this performance is even more impressive if one takes into account the context of declining markets and the sharp decrease in families food consumption. The introduction of the new Common Agricultural Policy (CAP) brings new challenges at a geopolitical-economic level: on one hand, in fact, the agricultural sector has to deal with the structural changes resulting from the new EU rules; on the other one, the fortunes of the industry are related to the ability of our "country-system" to seize opportunities arising from more competitive national and international markets.

Some data regarding the Italian agricultural balance should be emphasized<sup>16</sup>; in 2014 it recorded a deficit of around 6 billion euro, in a scenario of increasing agri-food trade flows. In particular, it should be noted data relative to growing exports (2.7%), amounting to about 35 billion euro, and imports (2.9%), amounting to just over 41 billion euro.

Regarding the geographic distribution of agri-food trade, in 2014 the European area accounted for just over 66% of our exports and about 70% of imports; North America is our second largest market, followed by Asia.

At dynamic level, the development of trade by geographical area shows a good increase in exports towards South and North America; on the contrary, exports to the EU-28 recorded a more modest increase. Similar figures can be noted regarding imports, with a decrease of approximately 21% of imports from Mediterranean African countries. Looking at the distribution of agri-food trade linked to the income level of the partners, the developed countries have the largest share of trade.

---

<sup>14</sup>See the INEA Report at: [http://dSPACE.inea.it/bitstream/inea/1004/1/Rapporto\\_stato\\_agricoltura\\_2014.pdf](http://dSPACE.inea.it/bitstream/inea/1004/1/Rapporto_stato_agricoltura_2014.pdf)

<sup>15</sup>See the Report Eurostat at: [http://ec.europa.eu/eurostat/statistics-explained/index.php/USA-EU\\_-\\_international\\_trade\\_and\\_investment\\_statistics](http://ec.europa.eu/eurostat/statistics-explained/index.php/USA-EU_-_international_trade_and_investment_statistics)

<sup>16</sup>See the INEA Report at: [http://dSPACE.inea.it/bitstream/inea/1216/5/Commercio\\_estero\\_prod\\_agroalim\\_2014.pdf](http://dSPACE.inea.it/bitstream/inea/1216/5/Commercio_estero_prod_agroalim_2014.pdf)

### **Methods: the phenomenon of food waste and territorial, economic and social impacts**

The largest share of production and trade in Developed Countries, as mentioned earlier, however, creates a corresponding high level of surplus and food waste, which information must be made in relation to countries in the developing world. In analyzing the phenomenon of food waste one first notices the absence of a definition both at institutional level and in the scientific literature. In this context an important role is played by the FAO (Food and Agriculture Organization of the United Nations) which refers to the food waste as any healthy and edible substance that instead of being used for human consumption is wasted, lost, degraded or consumed in any phase of the agri-food chain. Furthermore, in a recent study conducted by the Swedish Institute for Food and Biotechnology commissioned by FAO, there was a distinction between food losses "food losses during the agricultural production, post-harvest and processing of food and food waste" wasted food that occur in the latter part of the food chain (distribution, sale and final consumption). The first depends on logistical constraints and the latter by behavioral factors (FAO, SIK, 2011)<sup>17</sup>. There are, however, some studies relating to the waste and losses that do not take into account the whole food chain. The definition of "food waste" actually varies depending on the country. In Europe there is still no single definition, but recently, within the Commission for Agriculture and Rural Development, it is emphasized that food waste can be understood as "the sum of the products discarded from the food supply chain for economic reasons, cosmetics or for the proximity of a use by date, albeit still edible and therefore potentially destined for human consumption, in the absence of a possible alternative use, are intended to be discarded and disposed of, producing adverse effects from the environmental point of view, economic and missed Speeds earnings for companies (European Parliament, 2011)<sup>18</sup>.

At the root of the phenomenon can be highlighted some global nature trend with significant implications in the volumes of losses and food waste, in the relationship between developing countries and PS. This refers primarily to the urbanization that has resulted in the progressive extension of the agri-food supply chain to meet the food needs of the population living in cities. The greater distance between the place of production and place of final consumption, in fact, creates the need to transport food over long distances, with the need to improve transport infrastructure, storage and sale and avoid additional losses. The second element is the change of the composition of the diet, due to the increase in disposable income. This phenomenon, particularly evident in transition economies such as Brazil, Russia, India and China, imply that instead of starch based foods tend to favor the more meat, fish and fresh produce, such as fruit and vegetables, all the most perishable.

Finally, the third element is the increasing globalization of trade and the rapid spread of the mass distribution (GDO) in many emerging countries. The supermarkets in fact have become the dominant intermediary between farmers and consumers, replacing the retailers in areas such as Africa, Asia and South America, allowing a wider diversification of the diet. In addition, the need for better quality and food safety standards for consumers and the increase in the volume of marketed foods have consequences on the level of generated waste (BCFN, 2012)<sup>19</sup>. The analysis made in 2011 by the FAO estimates food waste in the world's 1.3 billion tons per year, equal to about a third of the total production of food for human consumption. But what are the reasons for food waste? In agriculture, food losses are due in

---

<sup>17</sup> Cf.: FAO, SIK, *Global Food Losses and Food Waste. Extent, Causes and Prevention*, Roma, 2011, pp. 5-6.

<sup>18</sup> Cf.: Parlamento Europeo, *Evitare lo spreco di alimenti: strategie per migliorare l'efficienza della catena alimentare nell'UE*, Commissione per l'Agricoltura e lo Sviluppo Rurale, 22 giugno 2011.

<sup>19</sup> Cf.: BCFN (Barilla Center For Food Nutrition), *Lo spreco alimentare. Cause, impatti, proposte*, Roma, 2012, p. 17, 42.

the first analysis to climatic and environmental factors, the spread of diseases and parasites. Technological and infrastructural facilities, agronomic skills and techniques of soil preparation, planting, cultivation, harvesting, processing and storage are behind the significant differences between countries in the developing and developed countries found in this stage. In developed countries, but sometimes also in developing, they are relevant all the regulatory and economic justification.

But there is much still to be done to understand the causes of the losses in the initial part of the supply chain. In the first processing of the agricultural product phases and finished the causes of waste are primarily detectable in technical malfunctions and inefficiencies in production processes: Normally we talk about "production waste". In the distribution and sale (whether wholesale and retail) waste depend on multiple causes, including improper orders and erroneous demand forecasts. Domestic waste arise from the difficulty of the consumer to correctly interpret food labeling; because they are prepared too generous portions (both in restaurants and at home); because of errors made in the process of procurement planning (often induced by promotional offers); when food is not properly stored (Slow Food, the Ministry of Agriculture Food and Forestry Policies, 2012)<sup>20</sup>. The distribution of food waste along the various links of the global food supply chain is as follows: in agricultural production (32%); in the immediate aftermath to the collection (post-harvesting and storage) (22%); on the consumer (in household and catering) (22%); during deployment (13%); in industrial processing (11%). The phenomenon of waste and food losses assumes different proportions in different regions of the world. Overall, about 55% of waste take place in developed countries, the remaining 45% in countries in the developing as can be seen from Figure 1 (Fig. 1) (FAO, 2013). The data show that even between developed countries and those in developing countries, with the exception of South-East Asian countries, the levels of waste and per capita losses that occur in the upstream stages of final consumption differ but didn't. In particular in developing countries causes the upstream waste are: farming techniques and crop inefficient, lack of infrastructure (which hinder the transport and distribution operations), storage and conservation systems inadequate, often adverse weather conditions. What is the main difference between developing countries and developed countries is mainly the amount of waste in the final part of the supply chain. We notice, in fact, that in Europe and North America such waste amounts to 95-115 kg per capita per year, mind in the South, South-East Asia and in sub-Saharan Africa counted only 6-11 kg (WRI, 2013)<sup>21</sup>.

There are also differences in what is wasted with regard to agricultural products: mostly fruits and vegetables and roots and tubers (45% respectively) followed, fish (30%) and 20% meat, dairy products and oilseeds and legumes. In particularly in Italy specialized literature and surveys on the subject official statistics are almost non-existent. In Italy food waste amounts to 2.4% of GDP and it is traceable at every link in the food chain: agricultural production, food industry, wholesale and retail distribution, catering, household consumption. Every year in Italy will lose 20 million tons of food. The main culprit is the agricultural sector: in the fields, in fact, are not collected, over 17 million tons of fruit, vegetables and cereals, 87% of the lost food before reaching the final consumer. Several reasons: aesthetic, commercial and market. The main cause is that the surplus production that stands out in cyclical or structural

---

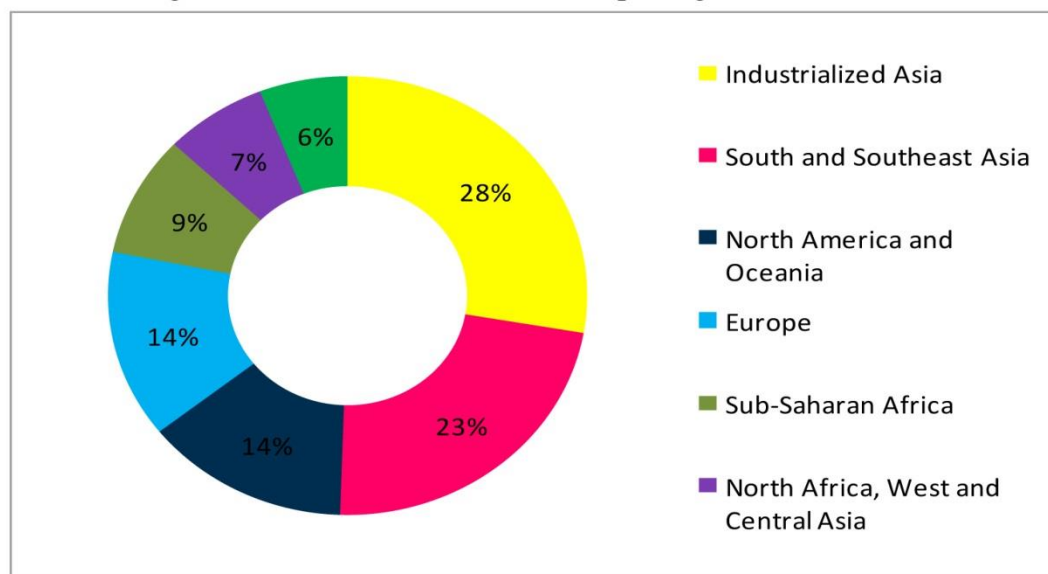
<sup>20</sup> Cf.: Slow Food Italia, Ministero delle politiche agricole alimentari e forestali, *Il nostro spreco quotidiano*, Slow Food Editore, Bra, 2012, pp. 1-17.

<sup>21</sup> Cf.: WRI (World Resource Institute), *Reducing Food Losses and Waste*, Working Paper, June 2013, Washington, p.14.



surplus (Segrè, Falasconi, 2011)<sup>22</sup>. All this creates some impacts. Regarding the first impact of environmental concerns waste water, climate change, soil extension (FAO, 2013)<sup>23</sup>.

Fig 1: Global food losses and waste per regions of the world



Source: WRI (World Resource Institute), 2013, based on FAO data, 2011

The economic impact and the costs of food wasted globally are around \$ 1,000 billion / year. Costs "live" food production should be added the "hidden" costs such as those attributable to the conflicts linked to the control of natural resources, the treatment of diseases related to the use of pesticides in agriculture, to water purification, the loss of natural habitats and the related ecosystem services, the effects of climate change and the reduction of water availability, erosion and reduction of the health status of agricultural land, to public subsidies for food production. The estimate that results (2,600 billion dollars) into account only in part of the "hidden costs" of food globally waste. Many other aspects were not taken into account for the lack of reliable estimation methods (FAO, 2014)<sup>24</sup>. Besides the ethical impact is related to the paradox of the food that ends up in landfills (in industrialized countries 222 million tons, an amount equal to the available food production in sub-Saharan Africa which is of 230 million tons). and the number of people without access to food, not only in low-income countries, but also in Europe. In fact, according to Eurostat, 81 million people in Europe are at risk of poverty (the equivalent of 17% of the European population) and 42 million already living below the poverty line. Wasted global production (around 40%) can feed 12 billion people with a world population in 2014 it was just over 7 billion. The over-production system and persists food waste at the expense of the right to food in quantity and quality adequately and sufficiently conform to the cultural traditions of the people to which the consumer and to guarantee a physical and mental life, individual and collective, fulfilling

<sup>22</sup> Cf.: Segrè A. e Falasconi L., *Il libro nero dello spreco in Italia: il cibo*, Milano, Edizioni Ambiente, 2011, pp.10-20.

<sup>23</sup> Cf.: FAO, *Impacts on natural resources. Summary Report*, 2013, pp. 26-40.

<sup>24</sup> Cf.: FAO, *Food wastage footprint. Full cost accounting. Final Report*, 2014, pp. 10-31.

and dignified and access that must be continuous, constant and unlimited, directly or through purchases (BCFN, 2012, p. 42)<sup>25</sup>.

### **Results and Discussion: the initiatives promoted**

Globally it is considered important to launch some recommendations. For example developing protocol measures to food waste. In this sense the movement in the direction of standardized measurement is underway. FAO is in the process of developing a standard method to assess and monitor food losses at the national level, with a focus on developing countries. The European Union is developing a method for assessing and monitoring food waste. WRAP, in conjunction with UNEP and FAO, has developed methods for measuring food waste within corporate supply chains. Several European countries such as Denmark, Sweden, and Norway are exploring establishing food loss and waste reduction targets and metrics. We recommend bringing these and related efforts together in collaboration with other stakeholders to establish a food loss and waste measurement protocol that will be robust, globally relevant, and universally adopted by countries and companies.

Recently the Council of the European Union has expressed its concern about the amount of food that is produced but not eaten, estimated in nearly a third of the food produced for human consumption. In terms of money, food waste has a terrible influence on the global economy with a cost of approximately USD 990 billion per year. In addition, even the food that is lost requires water to grow up, a vast cropland area and produces gas emissions.

The target to be reached is the Zero Hunger, through an increase of the availability of food able to meet the global demand of a population that is estimated to grow to 9 billion people by the year 2050. If only a quarter of the food currently lost were saved, it would feed about 900 million people starving. So, the reduction of food waste has many positive benefits because it not only reduces negative impact on climate water and land but also improves the economy of companies and households and, above all, makes it possible to feed a larger number of people with the food produced.

But there are also other recommendations as: Set food loss and waste reduction targets. Setting quantifiable, time-bound targets could raise awareness, stimulate focused attention, and mobilize resources toward reducing food loss and waste. Targets could be adopted across a range of geographic scales and types of entities. Four in particular come to mind: Global target, National Target, Sub National Target, Corporate Target; Increase investment in reducing postharvest losses in Developing Countries; Create entities devoted to reducing food waste in Developed Countries and Accelerate and support collaborative initiatives to reduce food loss and waste (WRI, 2013, pp. 28-31)<sup>26</sup>.

Worldwide there are numerous organizations and intervention initiatives aimed at reducing and / or recovery of food products no longer sold but still edible that can be classified into the following types, depending on the nature of being a promoter and / or the objectives to be achieved:

- Organizations (profit and non-profit). It is mainly voluntary organizations (the Food Bank and the Company of the Daily Bread in Italy, Fare Share in Britain, City Harvest in the United States and Mesa Brazil SESC in Brazil) or private (the Italian spin-off Last Minute Market that favors the direct meeting of supply and demand). Finally, directly from the agricultural sector (Feeding America and the Society of St. Andrew in the United States may collect discarded food).

---

<sup>25</sup> Cf.: BCFN (Barilla Center For Food Nutrition), *Lo spreco alimentare. Cause, impatti, proposte*, Roma, 2012, p. 17, 42.

<sup>26</sup> Cf.: WRI (World Resource Institute), *Reducing Food Losses and Waste*, Working Paper, June 2013, Washington, p.14.

- Initiatives to reduce, recycle and reuse of food, promoted by government agencies, local or municipal government agencies: the WRAP (Worldwide Responsible Accredited Production) in Britain; EPA and the certification made by supermarkets recycling (SRPC), sponsored by the Massachusetts Department of Environmental Protection in the United States; the information campaign "Too good for the bin!" of the Federal Ministry of Food, Agriculture and Consumer Protection in Germany or the Good Samaritan project of the City of Torino in Italy.
- Public awareness campaigns on food waste (Love Food, Hate Waste WRAP nationwide and This Is Rubbish in Britain, at the local level; the ADEME campaign in France and the movement "Stop Wasting Food" in Denmark. Sometimes campaigns They are aimed specifically at teenagers, through projects undertaken in schools (the Edible Schoolyard project in the United States and the Manger autrement dans les collèges in France).
- Cooperatives in private households in the agricultural sector, (the Grow Sheffield's Abundance Project in Great Britain and the City Slicker Farms in the United States).
- Initiatives of the major retail chains, through the collection and distribution of surplus food (Happy End of Coop in Italy), the purchase deferral of commercial promotions (the formula "buy one, get one later" adopted by Sainsbury's and Tesco in Great Britain); the use of food waste as a fuel for electricity generation (Sainsbury's and Tesco in Britain); the joint acquisition mechanism (A.N.D.E.S. in France): the improvement of packaging (Morrisons and Marks & Spencer in the UK); offering suggestions to customers on its mode to a better food preservation, indicated on product labels or the web (Morrisons).
- Internet sites which market at discounted food prices close to the recommended expiration date (the experience of What's in Italy and Approved Food in Britain).
- Initiatives "zero impact" of catering to the recovery of leftover food and wine left by customers (in the case of the Italian countryside "The good that advances" in Lombardy and "Buta Stupa" in Piedmont, or the campaign "Take me away" Italian Sommeliers Association).
- Initiatives launched by individual structures (the reorganization of the catering service at the Hospital of Hvidovre in Denmark and the People's Supermarket in London involving the local communities) (BCFN, 2012, pp. 82-108; Slow Food Italy, 2012)<sup>27</sup>.

As mentioned in the introduction, the project FUSIONS provides a definition of food supply chain: "Any substance or product, whether processed, partially processed or unprocessed, intended to be, or reasonably expected to be ingested by humans. 'Food' includes drink, chewing gum and any substance, including water, intentionally incorporated into the food during its manufacture, preparation or treatment" (the so called "FUSIONS Definitional Framework for Food Waste", Östergren et al. 2014)<sup>28</sup>. The food supply chain is the connected series of activities used to produce, process, distribute and consume food. The FUSIONS report adopts the definition given by the FAO (FAO 2011)<sup>29</sup> of food waste (any food removed from the food supply chain) and indicates that EU countries produce about 100 Mtonnes of food waste every year, and that about 45% of this is generated from households. The FUSIONS Project is coordinated by the Wageningen University (Holland) and the University of Bologna (Italy), together with Last Minute Market, a Spin Off from the

---

<sup>27</sup> Cf.: BCFN (Barilla Center For Food Nutrition), *Lo spreco alimentare. Cause, impatti, proposte*, Roma, 2012, p. 17, 42; Slow Food Italia, Ministero delle politiche agricole alimentari e forestali, *Il nostro spreco quotidiano*, Slow Food Editore, Bra, 2012, pp. 1-17.

<sup>28</sup> Cf.: Östergren K., Gustavsson J., Bos-Brouwers H., Timmermans T., Hansen. O., et al., FUSIONS Definitional Framework for Food Waste, 2014. FUSIONS Report - European Commission FP7 Grant agreement no. 311972, available at: <http://bit.ly/1ulc5OH>.

<sup>29</sup> Cf.: FAO, *The state of the world's land and water resources for food and agriculture (SOLAW)*, 2011, available at: <http://bit.ly/1LJXyIa>.

University of Bologna, founded in 1998, and nowadays an entrepreneurial society working at Italian national level for the recovery of unsold goods in favor of non-profit organizations.

### Conclusions

In the world, the present system reduces farmers and food processors to producers of goods. In particular in developing countries, this system deprives peasants of access to land and water and the communities as a whole, access to food. The land is not often cultivated by local people to meet their needs, while respecting food sovereignty<sup>30</sup>. In some cases the land is used to grow export crops, promoting the importation of food from abroad whose price is highly volatile and co-responsible for the food crisis in the southern hemisphere. Moreover, the current food system download the unwanted food in the North to the South of the world markets at prices that exclude from local producers market. Finally, the system based on overproduction and waste is responsible for the waste of the threat and pollution of our limited public resources: water, soil and air, reducing the living creatures, such as plants and animals, commodities exploited to produce as much as possible and as quickly as possible. The main flows of FW are generated by a variety of causes and they require specific prevention measures. For example, to avoid the waste of products that are edible but not harvested for not being in line with the required commercial standards, something could be done to foster new market opportunities (dedicated shops, community catering etc) or to promote a sort of reduced price sale within the great food retailing chain. This analysis originated by the presence of so many questions that giving an answer to them ends with even more questions: what attitude you decide to take against the global world and common goods like air, water and soil, on which one depends the future of the next generations? Responding to these issues and looking for solutions corresponds to what can be described as a correct and responsible approach to a live and sound research to support a just and sustainable model.

### References

- BCFN (Barilla Center For Food Nutrition), *Lo spreco alimentare. Cause, impatti, proposte*, Roma, 2012, p. 17, 42.
- FAO, *The state of the world's land and water resources for food and agriculture (SOLAW)*, 2011, available at:<http://bit.ly/1LJXyIa>
- FAO, *Impacts on natural resources. Summary Report*, 2013, pp. 26-40
- FAO, *Food wastage footprint. Full cost accounting. Final Report*, 2014, pp. 10-31.
- FAO, SIK, *Global Food Losses and Food Waste. Extent, Causes and Prevention*, Roma, 2011, pp. 5-6.
- Gereffi G., Humphrey J., *The governance of global value chains*, *Review of International Political Economy*, 12-1, 2005, pp.78-104.
- Östergren K., Gustavsson J., Bos-Brouwers H., Timmermans T., Hansen. O., et al., *FUSIONS Definitional Framework for Food Waste*, 2014. FUSIONS Report - European Commission FP7 Grant agreement no. 311972, available at: <http://bit.ly/1ulc5OH>
- Parlamento Europeo, *Evitare lo spreco di alimenti: strategie per migliorare l'efficienza della catena alimentare nell'UE*, Commissione per l'Agricoltura e lo Sviluppo Rurale, 22 giugno 2011.

---

<sup>30</sup> Cf.: FAO, *Impacts on natural resources. Summary Report*, 2013, pp. 26-40.

- Segrè A. e Falasconi L., *Il libro nero dello spreco in Italia: il cibo*, Milano, Edizioni Ambiente, 2011, pp.10-20.
- Slow Food Italia, Ministero delle politiche agricole alimentari e forestali, *Il nostro spreco quotidiano*, Slow Food Editore, Bra, 2012, pp. 1-17.
- WRI (World Resource Institute), *Reducing Food Losses and Waste*, Working Paper, June 2013, Washington, p.14.

### **Sitography**

- <http://carta.milano.it/it/> Accessed on 06/06/2017
- [http://dspace.inea.it/bitstream/inea/1004/1/Rapporto stato agricoltura 2014.pdf](http://dspace.inea.it/bitstream/inea/1004/1/Rapporto_stato_agricoltura_2014.pdf) Accessed on 14/06/2017
- [http://dspace.inea.it/bitstream/inea/1216/5/Commercio estero prod agroalim 2014.pdf](http://dspace.inea.it/bitstream/inea/1216/5/Commercio_estero_prod_agroalim_2014.pdf) Accessed on 10/06/2017
- [http://ec.europa.eu/eurostat/statistics-explained/index.php/USA-EU - international trade and investment statistics](http://ec.europa.eu/eurostat/statistics-explained/index.php/USA-EU_-_international_trade_and_investment_statistics) Accessed on 02/06/2017
- <https://www.eu-fusions.org/> Accessed on 23/06/2017
- [www.inea.it](http://www.inea.it) Accessed on 30/05/2017
- [https://www.wto.org/english/res\\_e/booksp\\_e/anrep\\_e/anrep15\\_e.pdf](https://www.wto.org/english/res_e/booksp_e/anrep_e/anrep15_e.pdf) Accessed on 28/05/2017

## **RURAL POVERTY AND RURAL DEVELOPMENT: A CASE FOR FAMILY FARMING AND SUSTAINABLE TOURISM IN THE NATIONAL PARK of gargano (ITALY)**

Simona GIORDANO

Université Paul Valéry Montpellier, University of Bari “Aldo Moro”

\*Corresponding author simo\_giordano@yahoo.it

### **Abstract**

Nowadays agricultural markets are going through a process of radical transformation and chances arise to make significant progress in the fight against rural poverty. Although during the past ten years more than 350 million people in rural areas have reached a standard of living out of the state of absolute poverty, global poverty itself remains a phenomenon predominantly rural. In order to put in place effective strategies, it is fundamental to create an environment that allows people living in rural areas to overcome all the challenges they face in their efforts to successfully manage their economic activities. This is particularly true with reference to Family farming in protected areas; in the National Park of Gargano, in Puglia region (Italy), the Park authority recognizes the important role of farmers in managing the territory of the Park itself, and in fostering rural development; an in-depth analysis of the Park agro-ecosystems constitutes the starting point to develop effective governance tools to preserve the agro-pastoral traditions of local communities and to enable the National Park of Gargano and the farmers operating in it to interact in order to develop a “management model” capable of assessing the agro-environmental sustainability of farms and promote their multifunctionality, with particular regard to sustainable tourism, leading the National Park of Gargano to become member of the Europarc Federation.

**Keywords:** *Rural poverty, innovative agriculture, agro-ecosystems, agro-biodiversity, sustainable tourism*

### **Introduction**

The concept of agro-biodiversity has emerged in the last fifteen years as the intersection between biodiversity and agriculture. According to the definition given by the FAO, "agro-biodiversity is the result of processes of natural selection and of the careful selection and developments in the inventiveness of farmers, herders and fishers over millennia. The agro-biodiversity is a vital by-product of biodiversity"<sup>31</sup>. The agro-biodiversity reflects the existing dynamic relationships in each ecosystem between human activities, cultivated plants and domestic animals (Cromwell et al., 2003); it is perceived as threatened and in need of protection by means of ad hoc innovative legal instruments both at national and international level. As a result, and perhaps for the first time, lawmakers are engaged in a major process of innovation that aims to protect and improve local and traditional agricultural systems seen as incubators of the agrobiodiversity itself; in this context a crucial role is played by the preservation of agro-ecosystems, defined by the OECD as "an ecosystem subjected to agricultural management, connected to other ecosystems"<sup>32</sup>. In the Puglia region, in the context of the Gargano National Park, in the Province of Foggia<sup>33</sup>, an important initiative is

---

<sup>31</sup>Source: <http://www.fao.org/docrep/007/y5609e/y5609e01.htm>

<sup>32</sup> Source: <http://stats.oecd.org/glossary/detail.asp?ID=82>

<sup>33</sup> Site [http://www.parcogargano.gov.it/servizi/notizie/notizie\\_homepage.aspx](http://www.parcogargano.gov.it/servizi/notizie/notizie_homepage.aspx)

carried out in order to enhance the fundamental role of farmers in protecting and managing the environment, and to involve them in a number of actions for the protection of the Park and to keep up the efficiency of the companies/farms themselves.

As argued by Vedeld et al. (2012), parks and protected areas are established to solve challenges of biodiversity conservation and to secure different environmental services, all with the aim of contributing to local livelihood improvements. The bad consequences brought by unmanaged tourism have more and more highlighted the importance of developing strategies carefully worked out to achieve sustainability in those natural areas usually devoted for tourism. Different aspects of the relationship between tourism, on one side, and local agriculture and local people, on the other one, need to be explored; it is necessary to investigate, for example, whether an increased interest in local food and traditions can really help to develop a sustainable tourism industry focusing not just on academic debates, but taking into consideration the responses of tourists and the opinions of local people (Sims, 2009). Though rural tourism is not a recent phenomenon (Lane, 2005), nowadays, rural areas are living a complex process of development and change that needs to be carefully dealt with in order to avoid the negative impact that can come from the inflow of tourists; this is particularly true with reference to protected areas (Lane, 2005).

### **Materials and Methods**

The project proposal springs up from the need to create a network whose main actors are the Gargano National Park (Table 1) and the various farms operating in the Park territory, through the identification of so called "Park Friends Enterprises", i.e. those farms that decide to join a "Convention" for the Park territory proper environmental management<sup>34</sup>. The purpose, in general, is to come to develop a "business management model ideal and environmentally sustainable" both in valuable natural areas as well as in the territories used for agricultural and forestry equipment, and to draw up a Catalogue of the "Park Friends Enterprises" in order to enhance the productions and the tourist offers of the farms involved in the initiative.

Table 1 - Mastery of the National Park Authority of Gargano

Organization name	Gargano National Park Authority
Classification of the area	National Protected Area
Total area	118.144 ha
Municipalities included in the territory of the Park	n. 18 Municipalities: Apricena - Cagnano Varano - Carpino - Ischitella - Isole Tremiti - Lesina - Manfredonia - Mattinata - Monte Sant'Angelo - Peschici - Rignano Garganico - Rodi Garganico - San Giovanni Rotondo - San Marco in Lamis - San Nicandro Garganico - Serracapriola - Vico - Vieste.
Other protected areas	Protected sea area (Area Marina Protetta: AMP) Isole Tremiti

---

<sup>34</sup>The need for a Convention for the correct environmental management of the Park territory arises from the desire of the Park Board to set up with farmers working relationships for the proper management of the territory of the protected natural area.

Special Protection Areas (“Zone a Protezione Speciale: ZPS”) present in the territory of the Park	n. 5
Sites of Community Importance (SIC) in the Park Area	n. 13

From the ecological point of view, the project is grounded in the high biodiversity and geological diversity of the territory of the Park, and aims both at recording the productions and the agro-environmental resources of the farms, and at identifying a series of synthetic indicators capable of obtaining a "qualitative model" for a proper business management, both biocompatible and environmentally friendly. The project can be described through the identification of three main activities, highly connected the ones with the others; the Park institution is currently engaged in the promotion of alternative economic activities, identified through 8 main Projects (Table 2), aimed at adopting restoration strategies and actions based on a clear understanding of the context in which different agro-ecosystems evolve, first of all the wealth status of the farmers (Belem et al., 2011).

As to Activity 1, the farms identified on the basis of those who joined the aforementioned "Convention" for the correct environmental management of the Park territory are divided by uniform size classes, in blocks according to the farm agreed area and proportioned in number to the "weight" of the same dimensional block on the total. The profile of each farm is described through the creation of an interview sheet in Excel format, aimed at reporting the data collected during the inspection on the field and the interview with the farm owner<sup>35</sup>, and the subsequent visit to the farms, it is possible to describe the "profile" of the single farm.

Table 2: Intervention Axes and Projects



	A- Natural Heritage Conservation	B- Historical and cultural heritage of traditions	C- Accessibility, Mobility and Integration System	D- The tourist and social enjoyment of the Park	E- Agriculture, forestry and fishing	F- Management of pressures and polluting factors	G- Enhancement and qualification of human resources	H- Office Activities
<b>P1 Biodiversity</b>	✓				✓			✓
<b>P2 Mobility</b>	✓		✓					✓
<b>P3 Fruition</b>	✓	✓	✓	✓			✓	✓
<b>P4 Farms</b>	✓	✓			✓			✓
<b>P5 Culture</b>	✓	✓		✓	✓		✓	✓
<b>P6 Lagoon environment and coast</b>	✓				✓	✓		✓
<b>P7 Tremiti Islands</b>	✓					✓		✓
<b>P8 Landscape of Traditions and Innovations</b>	✓	✓	✓		✓	✓	✓	✓

The documentary material collected is subsequently filed using a logical pattern and the data are then sorted and digitized in a holding file<sup>36</sup>. Synthetic information can be extrapolated, needed to fill out a card and a descriptive text representative of each farm within the catalogue; technical details and practical information are both merged with others more strictly functional to the practical use of the farm land and the surrounding area (Table 3).

<sup>35</sup>The factors taken into account are: farmland, crop types, presence of breeding animals, presence of valuable architectural manufacts, crop management and production companies of excellence, local products and high biodiversity value crops, the presence of karstic caves and peculiar views of the landscape, wildlife and flora life relevant stations, architectural and naturalistic emergencies, legends about places or people who have lived in it, origin of place names.

<sup>36</sup>Each monitored company has its own file, which consists of: the Excel sheet of business survey; georeferenced photographs of the farm territory and the main structures; a technical report in Word format that describes extensively the farm in all its aspects (“Agrostorie”); a shapefile of "significant" points manageable through GIS programs.



Table 3: Descriptive Card (Excel format)

Farm X	
Farm	
SAU	
SAT	
Natural vegetation	
Town	
Agritourism	
Didactic farm	
Association/Territorial Consortium	
Organic Agriculture	
Livestock	
Product Transformation	
Direct sale of products	
Products	
Main Cultivations	
Contacts	Phone/Email

As regards the selection criteria of the companies mentioned within the project, it is fundamental that they hold a stable business center within the Park Area<sup>37</sup>; they are divided into groups based on the size of the farm agreed area. Within these groups, a certain number of farms is selected appropriate and proportionate to the total number of farms belonging to the Park. In this way, a large database, interactive and heterogeneous as to content (reports, tables, digital images, shapefiles)<sup>38</sup>, can be developed; the mentioned proportions among the dimensional blocks can help to give a true idea of how farms different in size (in relation to an agreed area on the total surface) carry on their agro-environmental commitments. Moreover, a database is created, in order to evaluate the spatial distribution of farms among the municipalities of the Park (Figure 1). Using this method it is certainly possible to reach a representative sample, considering the division of the area subjected to the Park bond among different municipalities. Stated the respect of geographical and size criteria of the farms in the Park, the project aims to give farmers the awareness that they are the main actors of the Gargano National Park<sup>39</sup>. The choice of the farm to "investigate" is followed by a series of preliminary steps carried out during a visit to the field, aimed at knowing in advance the complex agro-environmental features; analysis of AGEA questions ("bibliographic analysis")<sup>40</sup>; mapping survey of the farm area through GIS, focusing on the farm area internal to the Park and on the one adjacent to the protected area boundaries (scale landscape

<sup>37</sup>These companies are also registered with the Chamber of Commerce as farms or as individual farmers.

<sup>38</sup>In completing the project, this material is merged in the drafting of a catalogue of the farms involved in the project, each of which is represented by a "business farm card" where various aspects of the farm are described.

<sup>39</sup>The parameters, the techniques and the information used to select the farms to be evaluated are integrated with: previous case studies, in order to have a basic set to start from; experiences of previous collaborations (eg. excursion activities promoted by the Board and by local associations) with farmers; direct observations of various kinds; semi-structured individual interviews on several occasions; analysis of secondary sources of data (eg. maps, archives).

<sup>40</sup>It is the case of the AGEA applications submitted by the farms in the phase of drawing up of the agreements for "good agricultural practices"; from the analysis of AGEA file registered at the Park Authority, it is possible to extract all the data related to the owner of the farm, the use of farm areas, the presence of animals, the type of management, the UAA, the surface devoted to each crop, the natural vegetation portion.

analysis)<sup>41</sup>; detailed analysis of natural areas or not typically cultivated ones (accurate cartographic analysis); definition of a list of hot-points that, loaded on the GPS, are observed in the field. After the preliminary phase it is possible to proceed to visit all the hot-points, to detect flora and fauna features not recognizable on aerial photo<sup>42</sup>. The photographic data and field notes are then computerized and translated into the farm survey form and in a set of data, complex and multidisciplinary, available for future Board projects and future actions of land management.

In Activity 2, the main objective to pursue is the definition of a methodology for the monitoring and the evaluation of individual farms in the area of the Park; the methodology has to meet the following characteristics simultaneously:

- 1) Conciseness. It must be able to offer a concise opinion on the coherence of enterprise management systems (land use, crop choices, management techniques, aspects of flora and fauna) with the objectives of nature conservancy and sustainable development suggested by the Park, including tourist activities.
- 2) Reproducibility. It must be applicable in any farm present in the park and offer comparable results.
- 3) Sharing and appropriateness. It must not be imposed, but accepted by the farms in the Park as fully corresponding to real situations, without reference to external models difficult to apply.
- 4) Functionality and easeness. It must allow a continuous adaptation and improvement of the concrete conservation actions promoted by the Park Authority.

The purpose is to define the parameters and conditions necessary to detect the so-called "ideal farm", i.e. a company that through the management strategies will be able to improve production performance and, at the same time, help to save the natural resources of the territory. As to this stage, it is feasible to set a series of indicators on the basis of theoretical and conceptual models consistent with each other and combined with a view to their practical application in the context of the Gargano National Park. A first level of classification consists in organizing the indicators in four dimensions of sustainability (physical, ecological, productive-economic and socio-cultural) corresponding to respective domains in the agro-eco-system (Pacini et al., 2009); for each of these dimensions, a precise number of systems can be identified (Lazzerini&Vazzana, 2005). The indicators themselves are finally grouped according to the belonging systems and to the functions they represent. The functions are then categorized on the basis of studies of international importance such as the Millennium Ecosystem Assessment (De Groot et al., 2010) and interdisciplinary European research projects on the assessment of sustainable impact of land management policies (Paracchini et al., 2011). The development of an evaluation system of indicators and indexes according to their importance is set, as well as the translation of the valuation rules in an automated program<sup>43</sup>, on the basis of data collected in "case study" farms; then, for the evaluation of agro-environmental sustainability of these selected farms, the application of the Program is carried out as assessment tool of the mentioned "case study" farms, on the total number of farms involved in the project. In detail, in each of the dimensions of sustainability, the system identifies within each dimension and eco-systemic functions, as well as in relation to each

---

<sup>41</sup>The presence of geomorphological features of particular interest is recorded.

<sup>42</sup>Data on plant and animal communities present in the farm territory are of "qualitative" kind, linked to the presence of certain target species, but they are certainly influenced by the time period when the measurements were made and are therefore not comparable.

<sup>43</sup>This program is similar to the Dexi-sustainability farms Alta Murgia Park program is built on the basis of an open-source software Dexi (<http://www.wai.ijs.si/MarkoBohanec/dexi.html>). The software comes with an original manual in English language.

indicator, some weights to be assigned<sup>44</sup>. The approach to be used is based on a multi-criteria linear additive model that assumes that each of the indicators listed represents, through the level of its score, the performance produced by a company in relation to a particular eco-systemic function. To each indicator it corresponds a utility function of its own, that represents the contribution that each farm gives with respect to each of the eco-systemic functions identified; the utility function is a linear function, or function at fixed coefficients. Each coefficient depends, in the chosen model, on the number of indicators that contribute to the achievement of a given level of utility for the farmer/actor linked to an eco-systemic function. The model is additive in that the sum of the level of utility of the functions related to each indicator gives, as a result, the level of the eco-systemic function achieved by a single farm analyzed. This result is then given by the sum of the products of the business performance (values of the indicators, standardized to sustainability scores between 0 and 1) multiplied by the relative weights (percentage calculated dividing by 100 the number of indicators of each eco-systemic function). Such method ensures equal distribution and importance to the various aspects to be measured; the calculation of the overall agro-environmental sustainability of a farm cannot be positive if one of the four dimensions (physical, ecological, productive-economic and socio-cultural) is negatively evaluated, in order to select only those companies really engaged in all the aspects taken into consideration.

As to Activity 3, in order to actively engage all the farms in the Park in the territorial liveliness and let the public know the features of the same farms, a set of tours is organized, whose itineraries start from local farms; during the tours, participants have the opportunity to discover the naturalistic beauties of the Gargano area and to approach the farms that brighten up the Park through the knowledge of their activities and their products. This action is an important local promotion intervention; in particular, the overall goal is to allow people to discover the reality of farms in the Park and then bring citizens closer to the agro-livestock operators, as major knowers of the area<sup>45</sup>. In order to manage the organization of the general program a "Laboratory" is established; the function of the secretariat is to manage the project as a whole, from the contacts with the companies/farms to the overall organization of the project excursions<sup>46</sup>.

### **Conclusions**

As argued by Valbuena et al. (2014), the analysis of the diversity of current states, life cycles and past trajectories of local farms and agro-ecosystems is vital to effectively design more sustainable management tools of the same agro-ecosystems. The analysis of the strengths and weaknesses of the investigated area highlights, considering the socio-economic characteristics and their evolution, the need to adopt strategies able to improve the regional competitiveness of the area; a first objective is the launching of processes to improve the

---

<sup>44</sup>The assignment is carried out as proposed by Paracchini et al., 2011.

<sup>45</sup>For all the excursions, a top limit of 40-50 people will be set up, in order to ensure the best possible service and guarantee a low level of inconvenience to the places visited.

<sup>46</sup>In detail, it will carry on the following tasks: manage the relationships with the farms contacted (appointments, etc.); contribute to the archiving of the material collected and of all the material collected throughout the project (photos, popularity cards, etc.); provide logistical and organizational support to the organization of public events where required (spread promotional material, contact the speakers, organize and book meeting rooms etc.); collaborate in the monitoring of the Project; manage the relationships with the press and media organs and provide a logistical support to the correct carrying out of all the activities involved in the project.

quality standards of agricultural products and to ensure the integration of the supply chain. These processes will allow the improvement of competitiveness in domestic and international markets, through interventions on productive structures, but also on marketing strategies. All these strategies towards the revaluation of local food and wine products must be related to the enhancement of environmental and cultural resources and the diversification of business activities in rural areas, towards an effective multifunctionality; another goal is the promotion of innovation and integration along the supply chain, aimed at the introduction of all those technical and organizational innovations that improve the competitiveness of the agricultural sector and, consequently, the tourist one.

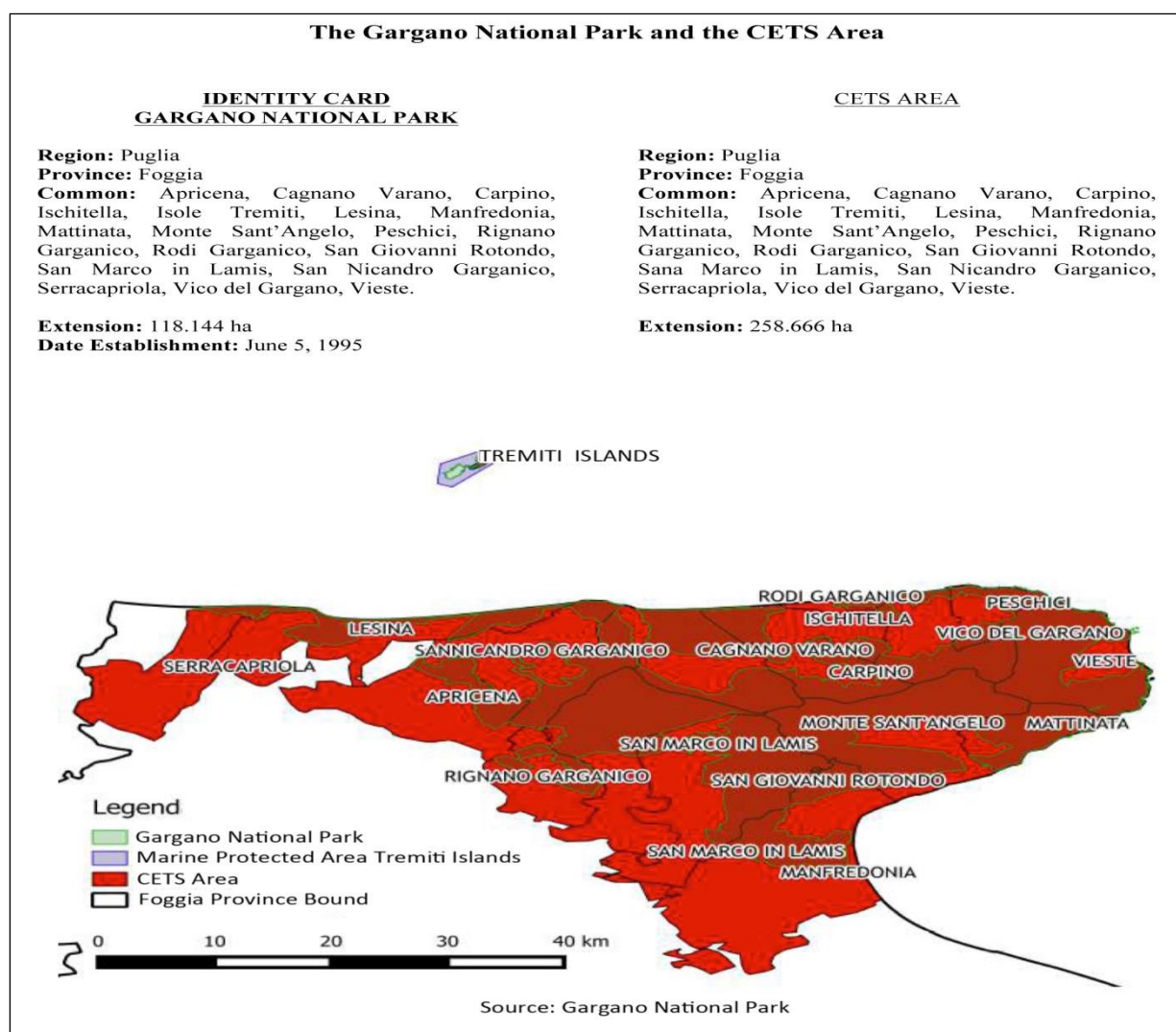


Figure 1: The Park Territory

Particular attention should also be given to investments in public infrastructures in support of marketing and, above all, to promote the diffusion of technological innovations; ultimately, it is vital to improve the entrepreneurial and professional skills of local players. All of these goals are attainable bringing together the different professionalisms in the area, in order to take advantage of all the skills needed for a better carrying out of actions for local development; all this combined with the aim of the conservation of biodiversity, key resource within each protected area. In this regard, the primary sector can contribute through the diffusion of agro-forestry systems of high naturalistic value; the protection of biodiversity in agriculture is not only an issue regarding habitats and wild species, but it is also related to the

genetic diversity of the species cultivated and raised. This involves the introduction or continuation of support of extensive and organic production methods, as well as the protection and safeguard of animal and plant genetic resources, and the diversification of agricultural activities towards the creation of new environmental services, comprising the tourist ones. Everything mentioned is at the basis of a project aimed at giving to a group of farmers the awareness to be key players in local dynamics and in the decisions of the Park Board, as well as in the further development of the tourism sector and its sustainability. Local participation is also to be stressed in any plan-making process and decision making (Lane, 2005). This idea of “all-round sustainability” (Sims, 2009) is perfectly coherent with the aims of the mentioned Slow Food movement<sup>47</sup>, its concern with the consequences on the environment of a highly industrialized food system and the necessity to foster a food system based on principles of high quality and taste, environmental sustainability and social justice. Successful sustainable tourism needs a long term strategy based on a wider perspective that starts from the analysis of the different needs of the area (cultural, economic, environmental, and so on) and of how tourism can help to improve the local economy; the same strategy, then, develops, through the active participation of local people to plans and decisions, a long-term program able to protect the environment, to foster new local enterprises, to support local farming and agriculture, in a word the regional economy.

### References

- Belem M., Bayala J., Kalinganire A., (2011), Defining the poor by the rural communities of Burkina Faso: implications for the development of sustainable parkland management, *Agroforest Syst.*, 83, pp. 287–302.
- Blondel J., Aronson J. (1995), «Biodiversity and Ecosystem Function in the Mediterranean Basin : Human and Non-Human Determinants », in DAVIS G.W., RICHARDSON D.M., eds. *Mediterranean-Type Ecosystems : The Function of Biodiversity*, Berlin, Springer-Verlag, pp.43-119.
- Caporali F. (2004), *Agriculture and Health : The Challenge of Organic Farming*, Cento (FE), Editeam.
- Caporali F. (2007), « Agroecology as a science of integration for sustainability in agriculture », *Italian Journal of Agronomy*, 2, pp.73-82.
- Cromwell E., Cooper D., Mulvany P. (2003), « Defining agricultural biodiversity », in *Conservation and Sustainable Use of Agricultural Biodiversity : A Sourcebook*, Centro Internacional de la Papa (CIP) and Users' Perspective with Agricultural Research and Development (UPWARD), Manila, volume 1, chapter 1, pp.1-12.
- De Groot R. S., et al., (2010) « Challenges in integrating the concept of ecosystem services and values in landscape planning, management and decision making », *Ecological Complexity*, 7, 2010, pp.260–272. Journal homepage: [www.elsevier.com/locate/ecocom](http://www.elsevier.com/locate/ecocom).
- Lane B. (2005), « Sustainable Rural Tourism Strategies: a tool for Development and Conservation », *Revista Interamericana de Ambiente y Turismo RIAT*, 1, 1, University of Bristol, pp.12-18.
- Lazzerini G., Vazzana C., « Indicatori agro-ambientali come strumenti di gestione aziendale e di valutazione della sostenibilità ambientale », *Proceedings 36th National Meeting Italian Society of Agronomy*, Foggia, Italy.

---

<sup>47</sup>See: <http://www.slowfood.it/>

- Pacini G. C., Lazzerini G., Migliorini P., Vazzana C. (2009), « An Indicator-Based Framework to Evaluate Sustainability of Farming Systems: Review of Applications in Tuscany », *Italian Journal of Agronomy*, [S.l.], 4, 1, pp.23-40. Site: <<http://www.agronomyjournal.it/index.php/agro/article/view/ija.2009.1.23/293>>.
- Pacini G. C., Lazzerini G., Vazzana C. (2011), « AESIS: a support tool for the evaluation of sustainability of agroecosystems. Example of applications to organic and integrated farming systems in Tuscany, Italy », *Italian Journal of Agronomy*, [S.l.], 6, 1, pp.3. Site: <<http://www.agronomy.it/index.php/agro/article/view/ija.2011.e3/298>>.
- Phillips A. (2005), « Landscape as a meeting ground : Category V protected landscapes/seascapes and world heritage cultural landscapes », in *The Protected Landscape Approach : Linking Nature, Culture and Community* (BROWN J., MITCHELL N., BERESFORD M., eds), IUCN, Gland, Switzerland, and Cambridge, UK, pp.19-35.
- Rosler M. (2005), « World Heritage cultural landscapes : a global perspective », in *The Protected Landscape Approach : Linking Nature, Culture and Community*, (BROWN J., MITCHELL N., BERESFORD M., eds), IUCN, Gland, Switzerland, and Cambridge, UK, pp.37-46.
- Santilli J. (2005), *Socioambientalismo e Novos Direitos : Proteção Jurídica à Diversidade Biológica e Cultural*, Editora Peiropolis, ISA/IEB, Sao Paulo, Brazil.
- Sims R. (2009), Food, place and authenticity: local food and the sustainable tourism experience, *Journal of Sustainable Tourism*, 17:3, pp.321-336.
- Valbuena D., Groot J. C. J., Mukalama J., Gerard B., Tittonell P. (2014), Improving rural livelihoods as a “moving target”: trajectories of change in smallholder farming systems of Western Kenya, *Reg. Environ. Change*, 15, pp. 1395–1407. Available at: [Springerlink.com](http://Springerlink.com).
- Vedeld P., Jumane A., Wapalila G., Songorwa A. (2012), « Protected areas, poverty and conflicts. A livelihood case study of Mikumi National Park, Tanzania », *Forest Policy and Economics*, 21, Elsevier, pp.20-31.

#### **Sitography**

- <http://www.fao.org/docrep/007/y5609e/y5609e01.htm> Accessed 30/05/2017
- <http://www.parcoaltamurgia.gov.it/> Accessed 03/06/2017
- [http://www.parcoaltamurgia.gov.it/images/convenzioneambientale/Schema\\_convenzione\\_gestione\\_def\\_23\\_03\\_2011.pdf](http://www.parcoaltamurgia.gov.it/images/convenzioneambientale/Schema_convenzione_gestione_def_23_03_2011.pdf) Accessed 05/06/2017
- [http://www.parcogargano.gov.it/servizi/notizie/notizie\\_homepage.aspx](http://www.parcogargano.gov.it/servizi/notizie/notizie_homepage.aspx) Accessed 28/06/2017
- <http://www.slowfood.it/> Accessed 10/06/2017
- <http://stats.oecd.org/glossary/detail.asp?ID=82> Accessed 30/05/2017

## ROLE AND IMPORTANCE OF SMALL AGRICULTURAL HOLDINGS IN LATVIA

Aina DOBELE\*, Andra ZVIRBULE

Faculty of Economics and Social Development, Latvia University of Agriculture, Latvia

\*Corresponding author: Aina.Dobele@llu.lv

### Abstract

An opinion is being popularised nowadays that the future production of food and other goods may be only industrial, large-scale and uniform. The Common Agricultural Policy of the European Union and the Rural Development Programme of Latvia has directed agricultural and rural development towards this particular goal, focusing less on small agricultural holdings. Four land reforms in Latvia have been implemented within a relatively short period (during the last century), making significant effects on the size of farms and agricultural development in Latvia. The research *aim* is to identify the role of small agricultural holdings by examining the historical background of formation of agricultural holdings in Latvia. Based on data provided by the Central Statistical Bureau, small agricultural holdings, in terms of utilised agricultural area and standard output, accounted for 90% of the total agricultural holdings in Latvia in 2010 and 2013. However, the number of such farms decreased year by year. For this reason, the preservation and development of small and medium agricultural holdings in the rural areas of Latvia is an essential matter. The insolvency and liquidation of small agricultural holdings can only increase the number of poor families, depopulation and unemployment in rural areas and in Latvia as a whole. In Latvia, small agricultural holdings are defined as those with an annual standard output of less than EUR 15 000 and an agricultural area of less than 50 ha. Small agricultural holdings perform not only economic but also ecological functions, and they play an essential social role in rural development.

**Keywords:** *small agricultural holdings, land reform, standard output, Latvia.*

### Introduction

Nowadays an idea is popularised that the future production of food and other products could be only industrial, large-scale and uniform. According to rural development experts of the Latvian Farmers Federation, the *capture of land resources, the standardisation of products, the use of pesticides, the cooperation of the financial market with large producers, the unavailability of credit for small farms, the production of monocrops in large areas, agricultural land depletion, increase in unemployment and rural depopulation* are the most visible problems in rural areas that affect the development of small agricultural holdings. For many years, the Common Agricultural Policy of the European Union and the Rural Development Programme of Latvia have directed agricultural and rural development towards the expansion of large farms, placing less focus on small agricultural holdings. After regaining independence, farms of various sizes emerged in Latvia. Some farms had a lot of technological resources, agricultural constructions and adapted and appropriate local infrastructures, whereas others had limited resources, low production capacity and poor infrastructures. Since the independence, there has been a popular conclusion that large farms had undoubted advantages in production, business development and competition. There is no single definition of an agricultural holding; however, in its July 2011 report „*What is a small farm?*” the European Commission’s Directorate-General for Agriculture and Rural

Development pointed out that the definition of a small agricultural holding has to be associated with such aspects as poverty risk, farm disadvantages, a lack of opportunities for development and the necessity of support, as well as certain criteria of such farms and their performance have to be set; this information could be used for statistical analyses and for defining agricultural policy goals. Beginning with the end of the 19<sup>th</sup> century, the political and economic literature often predicted no long period of operation for small farms. In reality, the predictions did not prove to be true, and an important factor – **family teamwork** – contributed to it. The produce of small agricultural holdings is not intended only for the market. Part of the produce is used to meet the needs of family members – for self-consumption – that is not affected by market price fluctuations, while the other part is intended for other consumers, yet it is not sold in the market and often takes the form of reciprocal private relationships with locals and neighbours.

### Materials and Methods

The present research is based on an analysis of specific literature and information from scientific databases (Science Direct). Regulations of the European Union, laws and Cabinet regulations of the Republic of Latvia were used to examine the legal framework, and quantitative data were acquired from the database of the Central Statistical Bureau of the Republic of Latvia. Since 2010, a new classification of agricultural holdings and their economic sizes has been employed in Latvia, and the type of farming of a holding is determined calculating its **standard output** (SO). The sum of standard outputs of all products of a holding represents the **economic size** of the holding. The purpose of determining economic sizes is to compare agricultural holdings being different in terms of production (e.g. holdings growing different crops and having different cropped areas and numbers of livestock) and economic performance. Every EU Member State sets its own economic size threshold, and agricultural holdings are classified into economic size classes. An economic size threshold of an agricultural holding set by the FADN of Latvia equals EUR 4 000 (Latvijas lauku saimniecību..., 2014). Various sources provide different definitions of a small agricultural holding. The present research employed a definition available in the legal framework of Latvia for small agricultural holdings, which specifies some criteria: a **small agricultural holding** is a natural or legal person, the place of residence of which is declared in a rural area or a legal person whose registered office is in a rural area and whose **total standard output** is in the range of **EUR 2 000 – 15 000** and the owned or rented **utilised agricultural area** of which is less than **50 ha** (Valsts un Eiropas...).

### Results and Discussion

The formation of agricultural holdings in Latvia was influenced by a number of political and economic processes. After 1920, there was a need to develop an independent national economy and a new management model. Because of the war, the population of Latvia decreased (from 2.5 million in 1914 to 1.6 million in 1920); buildings, infrastructure and farms were destroyed and farmland was overgrown (Boruks, 2003).

However, in 1929, after the *second agricultural reform* (1920-1937) (the *first land reform* began in 1861 in Russia after feudalism was abolished and the land of large land owners – German feudal lords – was distributed among Latvian peasants) when a decision was made to distribute the land of landlords among landless and small peasants, paying no compensation for the nationalised land to the former owners, the total number of agricultural holdings increased by 37%.



An analysis of changes in the number of agricultural holdings broken down by land area reveals that in the 1920s and 1930s the number of those being called family farms with an area in the range of 10-30 ha increased the most, reaching 115 thousand or 49% of the total agricultural holdings. However, the proportion of large farms holding a land area of more than 50 ha decreased (from 10.5% in 1923 to 6.8% in 1939) (Ozols et al., 2012). In the result of the *third land reform* (in 1940), which involved enforcing the system of collective farming, the land was again expropriated from its owners, and everything what was achieved during the earlier two reforms was eliminated. Private property was abolished, and land was nationalised and became the property of the state. The advantages of large collective farms, compared with small private ones, were stressed, avoiding defining their negative aspects. Positive changes towards private farming began on 6 May 1989 when the earlier abolition of individual farming was annulled. After the economic and political crisis in the Soviet Union, which resulted in its collapse and Latvia became a parliamentary republic, privatisation was started, and one of its goals was transition from socialism to a market economy. Small family farms emerged in rural areas. During the restoration of ownership of land and other property at the beginning of 1991, land in rural areas was granted to almost eight thousand individuals who managed a total area of 152 thousand ha, and many former collective farmers gradually established their own private farms and household plots. The liquidation of collective farms and the *fourth land reform* affected the size of agricultural holdings – small holdings emerged and prevailed and the utilised agricultural area (UAA) was fragmented – which, in its turn, influenced agricultural output and farmland management techniques. As shown in Table 1, at present agricultural holdings that are small in terms of economic size account for 90% of the total, while in Latvia as a whole the number of agricultural holdings decreases. This is mainly due to a decrease in the number and proportion of very small holdings (with a SO of less than EUR 4 thou.). The calculations showed that the process of production concentration took place in the agriculture of Latvia.

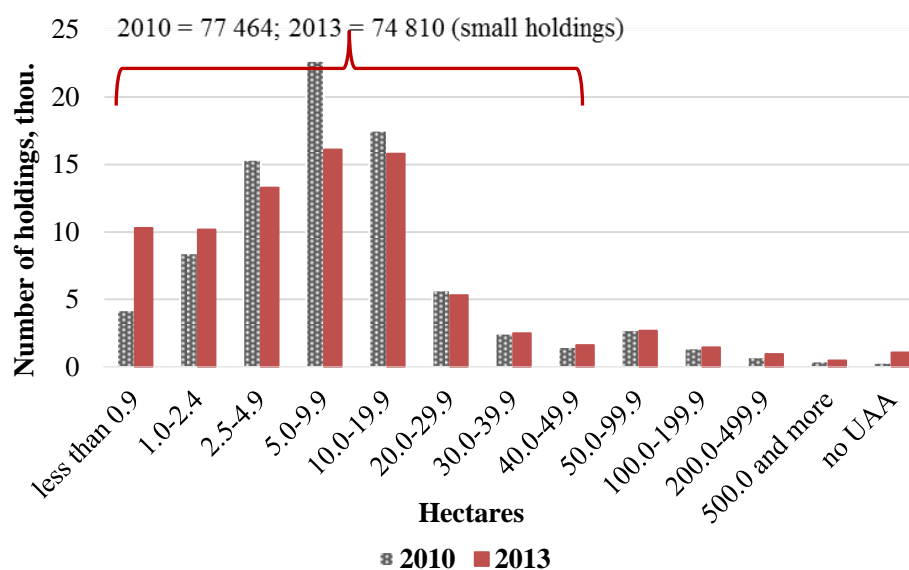
Table 1. Distribution of agricultural holdings by economic size in Latvia

Standard output	2010		2013		Change from base year
	number	percentage	number	percentage	
< EUR 4 thou.	<b>60 692</b>	<b>72.8</b>	<b>57 126</b>	<b>69.8</b>	<b>-6</b>
<b>EUR 4.0 – 14.9 thou.</b>	<b>15 585</b>	<b>18.7</b>	<b>16 170</b>	<b>19.8</b>	<b>4</b>
EUR 15.0 – 24.9 thou.	2 706	3.2	3 079	3.8	14
EUR 25.0 – 49.9 thou.	2 181	2.7	2 537	3.1	16
EUR 50.0 – 99.9 thou.	1 115	1.3	1 387	1.7	24
EUR 100.0 – 499.9 thou.	952	1.1	1 270	1.5	33
> EUR 500.0 thou.	155	0.2	228	0.3	47
Total number of holdings	83 386	100.0	81 796	100.0	-2

Source: authors' calculations based on CSB data, 2014

After summarising the CSB data on agricultural holdings broken down by UAA for 2010 and 2013 (Figure 1), one can find that very small holdings comprised more than 90% of the total. In 2013 compared with 2010, the number of very small holdings decreased (-3%), while the number of those holding 50 ha and more increased (+18%). After 2010, the decrease in the number of small agricultural holdings and the increase in the numbers of medium un large ones were affected by:

- modernisation and expansion of agricultural holdings;
- depopulation.



Source: authors' construction based on CSB data

Figure 1. Distribution of agricultural holdings by utilised agricultural area in Latvia

The number of small agricultural holdings is directly associated with territorial development as well. Latvia is a small country with a great diversity of natural and human resources and disparities in the development of its regions. Most small holdings operate in Latgale region, which is an economically less developed region. However, small holdings play an important role in this region in relation to the development of rural environment. Based on the available CSB information, small agricultural holdings mainly specialised in field crop farming, and the number of the holdings increased by 5% in 2013 (Table 2). The fewest holdings specialised in vegetable farming, yet it has to be mentioned that the number of holdings of this particular specialisation increased by 48% in 2013, and the greatest increase in the number of holdings was observed only for one more specialisation – permanent crops (+75%). A trend emerges – small holdings shift from livestock to crop farming, which is affected by both political and economic processes in the world.

Table 2. Types of small agricultural holdings in Latvia

Type of farming	2010		2013		Change from base year
	number	percent-age	number	percent-age	
Field crops	32 973	43.2	34 636	<b>47.3</b>	5
Vegetables	288	0.4	425	0.6	<b>48</b>
Permanent crops	1 119	1.5	1 961	2.7	<b>75</b>
Mixed farming	4 915	6.4	5 832	8.0	19
Dairy farming	14 894	19.5	9 937	13.5	<b>-33</b>
Grazing livestock, except dairy cattle	4 987	6.5	5 022	6.9	1
Pigs and poultry	2 703	3.5	1 937	2.6	<b>-28</b>
Mixed livestock farming	4 435	5.8	2 355	3.2	<b>-47</b>
Mixed crop and livestock farming	9 963	13.2	11 191	<b>15.2</b>	12
Total	76 277	100.0	73 296	100.0	-4

Source: authors' calculations based on CSB information

The decision of small agricultural holdings to engage in both types of farming – crop and livestock – is determined by a number of factors:

- it ensures a steady cash flow;
- less problems due to price hikes;
- changing demand;
- limited resources or, conversely, their abundance.

Small agricultural holdings do not have the same production capacity as large ones; therefore, their revenues are lower, their opportunities for development are more limited and their production costs are higher. However, in this case too particularly the family factor allows improving the situation – in most of the instances, remuneration for the work of family members is not included in production costs, which allows having the production cost at a level that keeps the farm solvent. The problem of such a situation is that it is impossible to reach a high quality of life; however, living and working on a family farm is a lifestyle.

### **Conclusion**

The formation of agricultural holdings in Latvia has been affected by four land reforms. In Latvia, small agricultural holdings make up 90% of the total, yet their distribution across the regions of Latvia is uneven. The highest proportion of small agricultural holdings was reported in Latgale region (92%), whereas the lowest was in Kurzeme region (86%). Small agricultural holdings were engaged in both livestock and crop farming; however, the calculations showed that the number of holdings, the main economic activity of which was crop farming, tended to increase. The development of small agricultural holdings, the use of their advantages and the avoidance of their disadvantages are determined by the common vision of family members regarding their farm goals, a critical vision of the disadvantages and a search for effective solutions to avoid the disadvantages.

### **References**

- Agricultural Censuses and Gender Considerations - Concept and Methodology (1999): Food and Agriculture Organization of the United Nations. Available: <http://www.fao.org/docrep/003/x2919e/x2919e05.htm>.
- Boruks A. (2003) Zemnieks, zeme un zemkopība Latvijā. No senākiem laikiem līdz mūsdienām. Jelgava: Latvijas Lauksaimniecības universitāte (Farmers, Land and Farming in Latvia. From Ancient Times to Nowadays. Jelgava: Latvia University of Agriculture) (in Latvian). 717 p.
- Definition of „farm” in English [s.a.]: Oxford Dictionaries. Available: <https://en.oxforddictionaries.com/definition/farm>.
- Eiropas Parlamenta un Padomes Regula (EK) Nr. 1166/2008 (2008. gada 19. novembris), kas attiecas uz lauku saimniecību struktūras apsekojumiem un lauksaimnieciskās ražošanas metožu apsekojumu un ar ko atceļ Padomes Regulu (EEK) Nr. 571/88 (Regulation (EC) No. 1166/2008 of the European Parliament and of the Council of 19 November 2008 on farm structure surveys and the survey on agricultural production methods and repealing Council Regulation (EEC) No. 571/88). Available: <http://eur-lex.europa.eu/legal-content/LV/TXT/PDF/?uri=CELEX:32008R1166&from=LV>.
- Farm Accountancy Data Network (FADN) [s.a.]: European Commission. Available: [https://ec.europa.eu/agriculture/fadn\\_en](https://ec.europa.eu/agriculture/fadn_en).
- Future of small farms (2014): European Parliamentary Research Service Blog. Available: <https://epthinktank.eu/2014/02/15/future-of-small-farms/>

- Lauku saimniecību struktūra - 2010. un 2013.g. apsekojumu dati (Structure of Agricultural Holdings – Data of the 2010 and 2013 Surveys) (in Latvian). Available: [http://data.csb.gov.lv/pxweb/lv/lauks/lauks\\_ikgad\\_laukstrukt\\_13\\_\\_1.visp/?tablelist=true&rxid=cdbc978c-22b0-416a-aacc-aa650d3e2ce0](http://data.csb.gov.lv/pxweb/lv/lauks/lauks_ikgad_laukstrukt_13__1.visp/?tablelist=true&rxid=cdbc978c-22b0-416a-aacc-aa650d3e2ce0)
- Latvijas ilgtspējīgas attīstības stratēģija līdz 2030.gadam (2010): Pārresoru koordinācijas centrs (Sustainable Development Strategy of Latvia: Inter-ministerial Coordination Centre) (in Latvian). Available: [http://www.pkc.gov.lv/images/LV2030/Latvija\\_2030.pdf](http://www.pkc.gov.lv/images/LV2030/Latvija_2030.pdf).
- Latvijas lauku saimniecību uzskaites datu tīkla metodika (2014): Latvijas lauku saimniecību datu uzskaites tīkls (Latvian Farm Accountancy Data Network Methodology: Latvian Farm Accountancy Data Network) (in Latvian). Available: [https://sudat.lvaei.lv/pub/SUDAT%20metodika\\_2015.pdf](https://sudat.lvaei.lv/pub/SUDAT%20metodika_2015.pdf).
- Latvijas mazo un vidējo (SI līdz EUR 25 000) lauku saimniecību attīstības iespējas (2013): Latvijas Valsts agrārās ekonomikas institūts (Development Opportunities for Small and Medium Agricultural Holdings (SO less than EUR 25 000) in Latvia: Latvian State Institute of Agrarian Economics) (in Latvian). Available: [http://www.lvaei.lv/images/Nacionalie\\_projekti/LAP\\_2013/Mazoun%20videjo%20lauku%20saimniecibu%20attistibas%20iespejas.pdf](http://www.lvaei.lv/images/Nacionalie_projekti/LAP_2013/Mazoun%20videjo%20lauku%20saimniecibu%20attistibas%20iespejas.pdf).
- Meaning of „farm” in the English Dictionary [s.a.]: Cambridge Dictionary. Available: <http://dictionary.cambridge.org/dictionary/english/farm>.
- Ozols E., Dobeļe A., Pilvere I., Dobeļe L. (2012) Land Resources for Agricultural Production in Latvia. In: West East Institute International Academic conference „2012 Zagreb”: WEI International European Academic Conference Proceedings, Zagreb, Croatia, No. ZG 12-261, pp. 162-174.
- Saimniecību perspektīvas Latvijas laukos [s.a.]: Zemkopības ministrijas Lauku attīstības atbalsta departaments (Prospects for farms in the Rural Areas of Latvia: Rural Development Support Department of the Ministry of Agriculture) (in Latvian). Available: [http://www.laukutikls.lv/sites/laukutikls.lv/files/article\\_attachments/acimeau\\_saimiecabas\\_laukos\\_zm\\_30.10.2014.pdf](http://www.laukutikls.lv/sites/laukutikls.lv/files/article_attachments/acimeau_saimiecabas_laukos_zm_30.10.2014.pdf).
- SUDAT metodoloģiskais pamats [s.a.]: LR Zemkopības ministrija (FADN Methodological Basis: Ministry of Agriculture of the Republic of Latvia) (in Latvian). Available: <https://www.zm.gov.lv/zemkopibas-ministrija/statiskas-lapas/lauku-saimniecibu-datu-uzskaites-tikls-sudat-?id=1569#jump>.
- Valsts un Eiropas Savienības atbalsta piešķiršanas kārtība pasākuma "Lauku saimniecību un uzņēmējdarbības attīstība" apakšpasākumā "Atbalsts uzņēmējdarbības uzsākšanai, attīstot mazās lauku saimniecības" (2015): Ministru kabineta 2015. gada 9.jūnija noteikumi No. 292 (Procedure of Granting National and European Union Support under the Measure “Farm and Business Development”, Sub-measure “Business Start-up Aid for the Development of Small Farms: Cabinet Regulations No. 292 of 9 June 2015) (in Latvian). Available: <http://m.likumi.lv/doc.php?id=274938>.
- What is a small farm? (2011) [online]: EU Agricultural Economic Briefs. Available: [http://ec.europa.eu/agriculture/rural-area-economics/briefs/pdf/02\\_en.pdf](http://ec.europa.eu/agriculture/rural-area-economics/briefs/pdf/02_en.pdf) [Accessed: 15 April 2017].

## **PERSPECTIVES FOR BEEF CATTLE PRODUCTION AND SALES IN LATVIA**

Andra ZVIRBULE, Aina DOBELE

Latvia University of Agriculture, Faculty of Economics and Social Development, Jelgava, Latvia

\*Corresponding author: andra.zvirbule@llu.lv; aina.dobele@llu.lv

### **Abstract**

Production of beef cattle is one of the most prospective agricultural industries in Latvia. This consideration could be made based on the following preconditions - suitable climate conditions, suitable land areas for beef cattle production, gained management experience, rational opportunities for industrial by-product (manure) use and a wide range of opportunities to increase product sales both in the domestic and foreign markets.

In Latvia, the beef cattle industry showed increase during 2011-2015, which had been supported by the positive outlook for beef cattle farming in the entire European Union (EU) market, intensification of rural area diversification in accordance with increased requirements for agricultural land management as well as economic considerations.

The topicality of the research is determined by the trends of the beef cattle market, which are assessed as stable in the whole world. In the EU, the number of slaughtered cattle has increased by 4%, while meat production – by 3.70%. The total number of live cattle exports in the EU Member States has also increased by 7.30% during the last five years.

In Latvia, the transition to beef cattle farming is stimulated by low milk prices and the limited milk sales market, where there is a tendency that many dairy farms have started parallel beef cattle farming.

The aim of the research is to explore prospects for the production and sales of beef cattle in Latvia. The specific tasks of the research: 1) to characterise trends in the production and sales of beef cattle in the world and the EU; 2) to explore the conditions that influence the production and sales of beef cattle in Latvia; 3) to determine the prospects for the production and sales of beef cattle in Latvia.

The research results shows dynamic changes in beef cattle production in Latvia. In the in the period 2011-2015 the key trends of which were as follows: with the number of beef cattle farms increasing insignificantly, the number of beef cattle and the number of beef cattle herds increased fast.

**Keywords:** *beef cattle production; beef sales; production and consumption balance; price of beef; Latvia*

### **Introduction**

A number of authors and organisations that research agricultural development (N.Alexandratos and J.Bruinsma,2012; FAO, 2012) stress the variables trends in the production and sales of beef cattle in the world, yet, at the same time, they identify several global problems. The livestock sector is one of the most dynamic parts of the agricultural economy. The sector has expanded rapidly in recent decades and demand for livestock products is expected to continue growing strongly through the middle of this century, driven by population growth, rising affluence and urbanisation. Decisive action is required if the sector is to satisfy this growth in ways that support society's goals for poverty reduction and food security, environmental sustainability and improved human health. It is believed in

Latvia too that beef cattle production is one of the most prospective agricultural industries that considerably enhanced its competitiveness in the domestic market owing to the intensive popularisation of beef cattle breeding and the activities of the Latvian Beef Cattle Breeding Association in recent years.

There are all the necessary preconditions for the development of the beef cattle industry in Latvia: suitable climate conditions, suitable land areas for beef cattle production, gained management experience, rational opportunities for industrial by-product (manure) use and a wide range of opportunities to increase product sales both in the domestic and foreign markets. A number of authors and research studies (V. Muriel *et al.*, 2015; M. McCarthy *et al.*, 2003; C.A. McAlpine *et al.*, 2009; A. Hessle *et al.*, 2017.) emphasise economic, social and sustainability aspects in the production, processing and consumption of beef. In the global beef market, discussions increasingly focus on problems that relate to the cattle raising stage – the problem of CO<sub>2</sub> emissions, the problematic aspects of meat quality, environmental impacts and, at the same time, cost optimisation. However, in view of the fact that the beef cattle industry is only at the initial stage of development, the key objective of this industry is the production of high-value and quality beef, the supply of domestically produced meat of beef cattle to consumers in Latvia as well as the enhancement of its competitiveness and opportunities for export.

The above-mentioned considerations formed the basis for the present research on the prospects for the production and sales of beef cattle in Latvia, taking into consideration the overall trends in this industry in the world and the EU.

The following research aim was set: to explore prospects for the production and sales of beef cattle in Latvia. The specific tasks of the research: 1) to characterise trends in the production and sales of beef cattle in the world and the EU; 2) to explore the conditions that influence the production and sales of beef cattle in Latvia; 3) to determine the prospects for the production and sales of beef cattle in Latvia.

## **Materials and Methods**

The following research methods were employed to achieve the aim and perform the tasks: logical construction, analysis and synthesis, the graphic method as well as statistical analysis methods to compute annual changes and changes from the base year.

The authors of the paper used the following materials: research papers for theoretical justification; data on the situation in the industry in Latvia and in the world from FAO and from annual reports of the Ministry of Agriculture of the Republic of Latvia; information provided by the Latvian Beef Cattle Breeding Association for the assessment and analysis of the industry as well as practical research and observations done by the authors.

## **Results and Discussion**

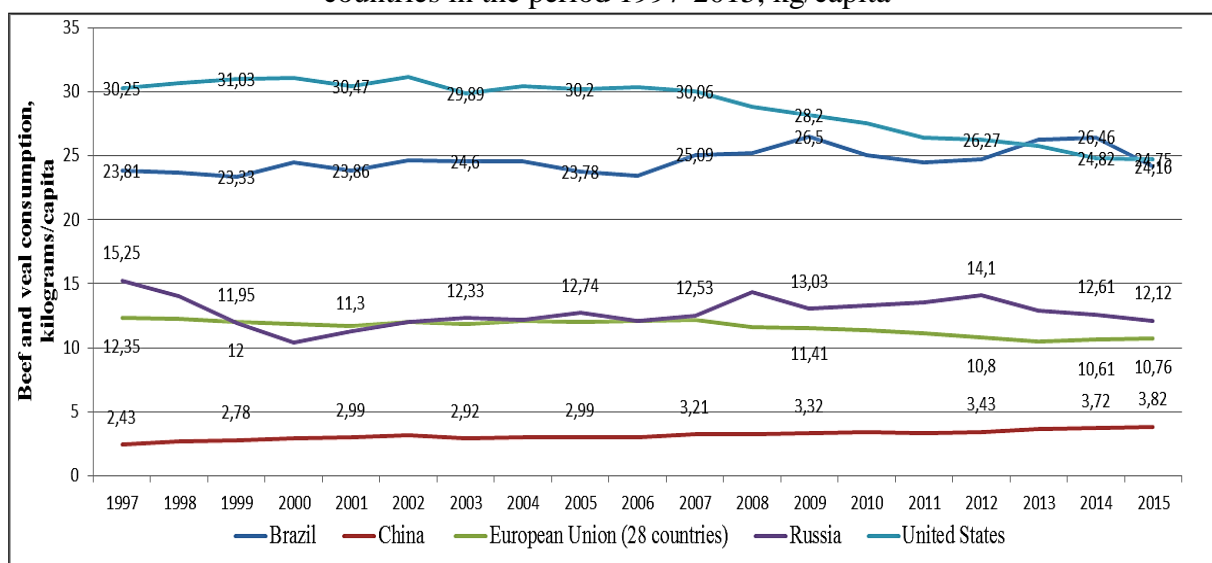
Trends in the production and sales of beef cattle in the world and in the EU

In view of the fact that the potential quantities of beef produced and sold in Latvia are relatively insignificant, Latvia is not going to be a significant market player on a global scale due to its small capacity. However, an analysis of the trends in the production and consumption of beef in the world allows identifying the key potential courses of development for this industry. First of all, an analysis of the output of beef and veal in the world allows concluding that the USA, Brazil, the EU Member States and China are the leading beef suppliers and beef market shapers in the world. An analysis of the statistics by country shows that in the period 2011-2015 insignificant changes in output were observed in all the leading countries. Such a situation indicates that the supply of beef was quite steady and no fast and

dynamic changes occurred in the markets of the leading countries. A positive fact is that from the perspective of Latvia, a quite steady situation in the output of beef was in the EU Member States that took high and stable positions in the world market.

Further, an analysis of the consumption of beef and veal reveals that the average per capita consumption of both kinds of meat was equal to 6.50 kg/year. However, a lot of various factors affect the consumption of beef: the standard of living, religion, food consumption behaviour, price, the quality of an assortment etc. In 2015, according to the OECD, the highest per capita consumption of beef and veal was reported in Argentina, 41.80 kg/year, whereas the lowest – 0.60 – in India. In the European Union Member States, this indicator was, on average, 10.76 kg/year per capita.

Fig. 1. Trends in the consumption of beef and veal in the leading beef consumption countries in the period 1997-2015, kg/capita



\*Source: authors' construction based on FAO data

The data on the trends in the consumption of beef and veal in the period 1997-2015 indicate that unlike the trends in the output of both kinds of meat, dynamic changes were observed in the sales of both kinds of meat in the world. Annual change rates for the consumption of beef by country reveal that the largest changes in consumption in the period of analysis were reported in Brazil (-8.69%....+7.08%), China (-8.17%....+8.64%) and Russia (-14.64%....+14.60%). The steadiest situation was in the USA (-4.02%....+2.19%) and the EU Member States (-4.03%....+2.91%). Furthermore, only China and Brazil demonstrated an increasing trend in the consumption of beef. Such overall trends in consumption were affected by change in food consumption habits, which was specific to China, quite dynamic fluctuations in the global beef markets where beef prices reached a record high level in 2014 and interaction among the meat markets – an increase in the price of pork due to the outbreaks of swine diarrhoea in the USA and African swine flu in Europe as well as an increase in the price of mutton in New Zealand where the number of herds decreased for several years.

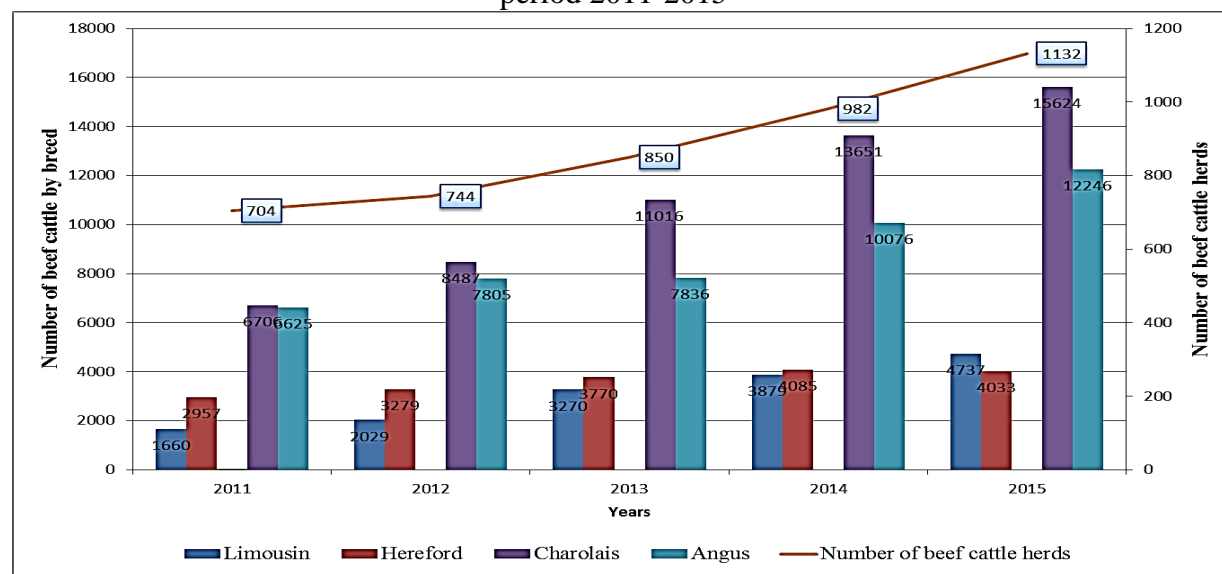
#### Production and sales of beef in Latvia

After analysing the situation in Latvia within the context of global trends, one could make an assumption that dynamic changes occurred in the production of beef. The changes were due to the following key trends – with the number of beef cattle farms increasing insignificantly, the number of beef cattle and the number of beef cattle herds increased fast.

In 2015, with the number of farms increasing insignificantly, the number of beef cattle reached 59250 (pure-breeds and crosses of beef cattle), which was 9.8% more than in the previous year. However, according to the Agricultural Data Centre (ADC), there were 27229 farms with 419 084 cattle recorded in the register of animals, which was 0.7% cattle less than in 2014, which indicated that a number of farms engaged in cattle farming professionally, keeping beef breed cattle in particular.

A further analysis focuses on changes in the numbers of beef cattle and beef cattle herds in Latvia by year.

Fig. 2. Changes in the numbers of beef cattle and beef cattle herds in Latvia in the period 2011-2015



\*Source: authors' construction based on ADC data

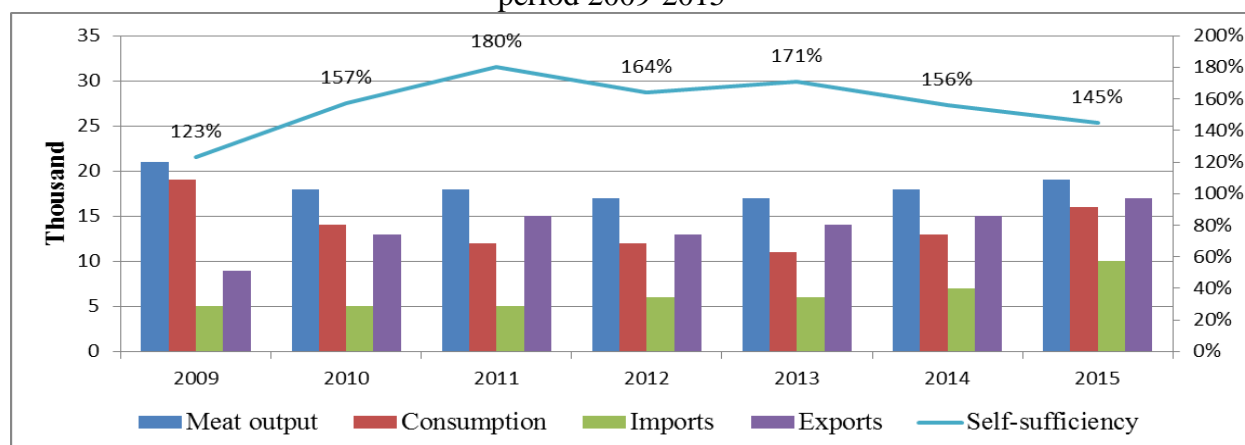
As shown in Figure 4, the number of beef cattle herds increased by 60.79% from the base year, which was fast growth. Such growth was fostered by quite low milk purchase prices and the limited milk sales market. A lot of dairy farms began engaging in beef cattle farming in parallel with dairy farming. On the one hand, such a trend could be viewed positively, as the beef cattle industry grew, while on the other hand beef cattle were not mainly raised and fattened to produce quality meat on such farms, as most of the farms sold calves in particular (weaned at the age of 6-8 months) for export. In Latvia, mostly four beef cattle breeds are widespread: Charolais, Limousine, Hereford and Angus, as well as Simmental and Highland become popular. In raising beef cattle, the following objectives are set: high live weight gains through feeding economical diets, quality carcasses according the SEUROP classification, easy farrowing, high fertility rates, body structure typical of the breed and a calm temperament.

#### Prospects for the production and sales of beef cattle in Latvia

The prospects for the production and sales of beef cattle are mainly determined by domestic consumption, changes in beef purchase prices and export opportunities.



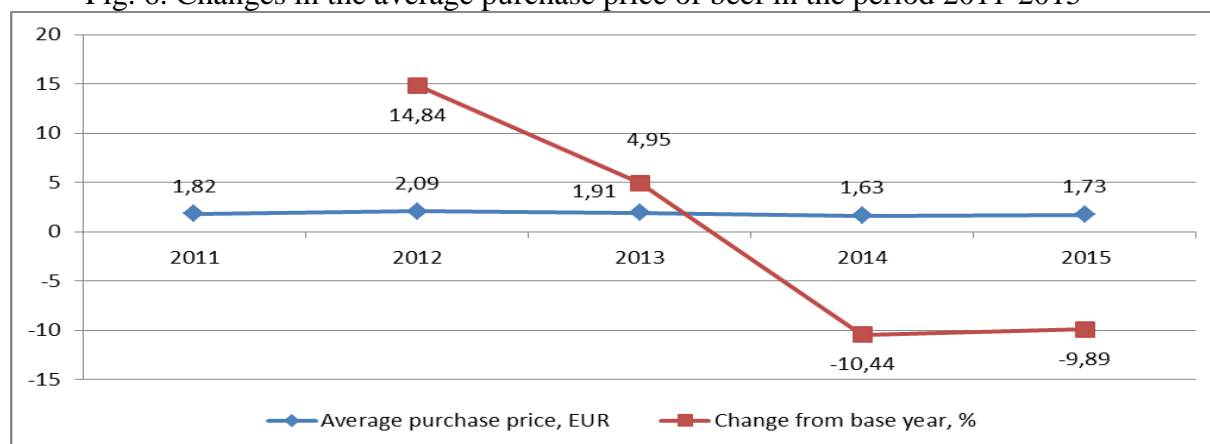
Fig. 3. Production and consumption balance of beef and its products in Latvia in the period 2009-2015



The production and consumption balance of beef and its products in Latvia shows that the output of beef in 2015 compared with 2014 increased by 6%, while beef consumption rose by 20%. A trend was observed – the imports of beef rose by 32%, while the exports of it increased by only 15%.

The beef purchase price factor contributes to the use of opportunities for beef export, yet the beef is imported because of growing domestic consumption. For example, the average price of a cow carcass in Latvia in January 2016 was EUR 1.67 per kg of meat, while in the EU it was EUR 2.72. However, the average price of veal in Latvia was EUR 1.90, compared with EUR 3.87 in the EU.

Fig. 6. Changes in the average purchase price of beef in the period 2011-2015

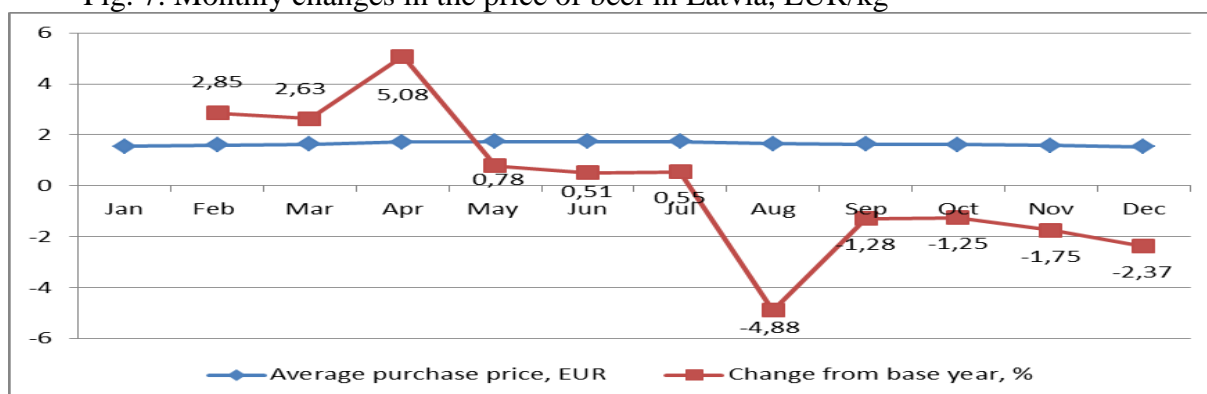


\*Source: authors' construction based on CSB data

Furthermore, a negative trend in beef purchase prices was observed in the period 2011-2015, as the prices decreased. Overall, such a trend did not contribute to the growth of the beef cattle industry but led to practising a certain management pattern. Namely, at present in Latvia, the most widespread management pattern observed on beef cattle farms is as follows: calves are weaned at 6-7 months and sold through an auction house or to an intermediary. The advantages of such a management pattern are as follows: 1) no need to feed the cattle for a long period; 2) no need to restructure the herd; 3) no need to buy follow-on feed; 5) cash flow is faster, compared with the production cycle involving cattle fattening.

Beef price fluctuations are observed every year; besides, there are seasonal price changes as well.

Fig. 7. Monthly changes in the price of beef in Latvia, EUR/kg



\*Source: authors' construction based on CSB data

As shown in Figure 7, a price increase is usually observed in the beginning of a year, reaching the highest level in spring, whereas a price decrease occurs at the end of summer. Overall, the average purchase price declined in 2016, which could be explained by the large number of slaughterhouses in the country. The slaughterhouses were not exploited at full capacity; therefore, there were interruptions and losses in production, which directly affected the cost of slaughtering and, consequently, there was no opportunity to offer a higher purchase price. Beef cattle purchase prices varied among some meat processing enterprises, yet the reason was the cattle quality standards set according to the EUROP classification, which was employed to calculate how much to pay farmers for the carcass weight of their cattle. However, no quality characteristics are specified when selling the beef at supermarkets as well as it is not specified whether the beef is from a heifer or a bull. This means that the strategy of a supermarket is a hindering factor for beef cattle farmers in making use of their advantages.

## Conclusions

There was a quite steady situation in the output of beef in the EU Member States in global context, which served as a positive signal for beef cattle producers in Latvia.

The average per capita consumption of beef and veal in the EU Member States was equal to 10.76 kg/year, yet quite significant changes (-4.03%....+2.91%) were reported in the period 1997-2015.

In Latvia, dynamic changes were observed in beef cattle production, the key trends of which were as follows: with the number of beef cattle farms increasing insignificantly, the number of beef cattle and the number of beef cattle herds increased fast.

The output of beef in Latvia in 2015 compared with 2014 increased by 6%, while beef consumption rose by 20%. The trend was that the imports of beef increased by 32%, while the exports of it rose by only 15%.

A negative trend in beef purchase prices was observed in the period 2011-2015, as the prices decreased. Overall, such a trend did not contribute to the growth of the beef cattle industry but led to practising intermediary deals. Beef cattle purchase prices varied among some meat processing enterprises, yet the reason was the cattle quality standards set according to the EUROP classification, which was employed to calculate how much to pay farmers for the carcass weight of their cattle.

## References

- Alexandratos N., Bruinsma J. (2012). World agriculture towards 2030/2050: the 2012 revision. ESA Work. Pap, 3.
- Average Meat purchase price: <http://data.csb.gov.lv/sq/4939> Accessed on 14/04/2017
- Beef cattle monitoring data: <http://www ldc.gov.lv/lv/statistika/parraudziba/#p2> Accessed on 07/06/2017
- FAO data: <http://www.fao.org/3/a-i4691e.pdf> Accessed on 30/05/2017.
- Foreign Agricultural Service. Office of Global Analysis Livestock and Poultry: World Markets and Trade: [www.apps.fas.usda.gov/psdonline/.../livestock\\_poultry.PDF](http://www.apps.fas.usda.gov/psdonline/.../livestock_poultry.PDF)
- Hessle A., Bertilsson J., Stenberg B., Kumm K., Sonesson U. (2017) Combining environmentally and economically sustainable dairy and beef production in Sweden, *Agricultural Systems*, Vol 156, pages 105-114.
- McAlpine C.A., Etter A., Fearnside P.M., Seabrook L., Laurance W.F. (2009) Increasing world consumption of beef as a driver of regional and global change: A call for policy action based on evidence from Queensland (Australia), Colombia and Brazil, *Global Environmental Change*, Vol. 19 (1), pages 21–33.
- McCarthy M., De Boer M., O'Reilly S., Cotter L. (2003) Factors influencing intention to purchase beef in the Irish market, *Meat science*, Vol. 65 (3), pages 1071–1083.
- Muriel V., Dagevos H., Antonides G. (2015) Sustainable food consumption. Product choice or curtailment?, *Appetite*, Vol.91, pages 375-384.
- OECD/Food and Agriculture Organization of the United Nations (2015), *OECD-FAO Agricultural Outlook 2015*, OECD Publishing, Paris. [http://dx.doi.org/10.1787/agr\\_outlook-2015-en](http://dx.doi.org/10.1787/agr_outlook-2015-en) Accessed 12/02/2017

## **EVALUATION OF LAND USE AND AGRICULTURAL PRODUCTION IN THE DEVELOPMENT AREA OF THE MAJOR CITIES OF LITHUANIA**

Jolanta VALČIUKIENĖ\*, Daiva JUKNELIENĖ, Virginija ATKOCEVIČIENĖ

Institute of Land Use Planning and Geomatics, Aleksandras Stulginskis University, Lithuania

\*Corresponding author: valciukienejolanta@gmail.com

### **Abstract**

Recently, especially big concern is that the consequences of the development of suburban areas are usually manifested by the reduction of productive agricultural land area. Agriculture in Lithuania is very important not only for enshrining agricultural traditions, but for the national economy as well. The tests involved suburban sub-districts bordering the three largest Lithuanian cities (Kaunas, Vilnius, Klaipeda). The study found that in suburban areas the influence of urban development on the use of agrarian land areas was manifested in the fact that they have been suffering from the decrease of agricultural lands, farms and the number of domestic animals more rapidly than in other areas. During the ten-year period in Vilnius, Kaunas and Klaipeda districts the area of the used agricultural land decreased by an average of 4.2 percent (throughout Lithuania it increased by 7.2 percent.), the number of farms producing crops decreased by 36.6 percent (in Lithuania – by 32.5 percent), the number of cows kept in farms decreased by 39.6 percent (in Lithuania – by 21.8 percent.). The average area of legally registered agricultural plot of land in Vilnius district is only 2 hectares, in Kaunas district – 2.2 ha, in Klaipeda district – 2.1 hectares. Such kind of fragmentation of the fields and agricultural land plots, the increasing concentration of the population as well as the rapid decrease of agricultural land areas with negative impact on agricultural development potential in these areas occurring due to the decline in urbanization and self-renaturalization of land, determine peculiarities of the use of agrarian landscape features. Therefore, according to the territorial planning documents, the layout of areas used for agricultural activities in these areas and farm land holdings prospective limits formation must be provided for intensive agricultural activities through creating opportunities for agricultural traders to specialize in horticulture, gardening, and livestock farming, combining land users' preferences and legal requirements for fertile agricultural land preservation.

**Keywords:** *land use, agricultural production, suburban areas, territorial planning.*

### **Introduction**

In the process of global integration and with the ever-increasing population of cities, urbanized areas have been developing quite intensively lately. Europe is one of the most urbanized continents. About 75 percent of its population lives in cities. It is estimated that by the year 2020 this proportion will make up about 80 percent of the total population. According to the data of the European Environment Agency since 1950 urbanized areas increased by more than 78 percent (Urban sprawl ..., 2006). All this increases the demand for land for urban development within city limits and the surrounding territories. Urban development in Lithuania has its own characteristics. At the level of urbanization, Lithuania lags behind the countries of Western Europe. Only the regions of big cities, such as Vilnius, Kaunas and Klaipeda have reached the level of these countries (Vanagas, 2008). The suburbanization process is first and foremost the fastest in the largest cities, but it also affects

smaller settlements located in the metropolitan area. Even before the 20th century, the cities of Europe and North America were surrounded by residential suburbs. In Lithuania, this phenomenon has become particularly evident in the last 10-20 years. In the context of such intensive urbanization, the problem of land use is becoming more acute. At the beginning of the 21st century, it was about 3.2 billion ha of land suitable for agriculture in the world. At present, almost all arable land is used – 1475.43 million ha, i.e. 0.24 ha per capita, but its area decreases by about 16 million ha annually. It is predicted that by 2025 the agricultural land will fall to 0.17 ha per capita, at 8.4 billion of earth's inhabitants. 25 years later, this volume would reach 0.13 ha per capita globally if 9.8 billion of people live in the world. In addition, from an ecological point of view, it is estimated that about 10-12% of land used now for agriculture should be eliminated from agricultural and forestry accounting and "returned to nature" for environmental purposes – for preserving biosphere self-regulation functions and biodiversity (Bučas, 2010). The Lithuanian general plan also foresees that the area of agrarian territories may decrease annually by an average of 0.7 percent per year. According to the data of state land registration in 2017, there were 3421.53 thousand ha of agricultural land in the territory of Lithuania, of which the largest part – 3052.91 thousand ha consisted of arable land. Compared to the previous year (2016), agricultural land fell by about 10.02 thousand ha per year, it is 0.29% of the total area. On average, in the last 15 years, agricultural land has decreased by almost 0.7 thousand ha according to their statistical accounting. This was influenced by the afforestation of infertile agricultural land areas, the process of self-transformation, when most of the meadows and pastures swallow due to inappropriate use, the overgrowth with shrubs or trees, and the development of indigenous urbanized areas. Meanwhile, the area of built-up areas grew in both cities and around them. For the target planning period (until 2020) the level of urbanization determined by the urban population in the total population of Lithuania is 72-75 percent (Lietuvos ..., 2002). According to the data of state land registry, during the last 15 years the area of the built-up areas in Lithuania has increased by more than 6,600 ha, i.e. about 5 percent. Although in the context of urbanization the territorial integrity, ecological stability of the countryside and biodiversity preservation are emphasized, however the importance of economic priorities is raised, which results in more uncoordinated intensive use of suburban areas. It is of great concern that the consequences of urban (suburban) development are often the reduction of productive agricultural land and, exceptionally, the destruction of forest areas. It is increasingly acknowledged that the boundary between the city and the countryside becomes difficult to describe, volatile, conditional. World urbanists, cultural landscape and environmental analysts (D. Lowenthal, A. M. Tung, O. L. Boon, J. Jacobs, A. Berger, etc.) argue that in the 21st century, the city became an antropoecosystem tumour of rural landscape, which is rapidly expanding into the natural and rural landscape environments with urban enclaves (Bučas, 2010). However, when viewed strategically, we must adhere to the notion that agriculture in Lithuania is very important not only for the cultivation of agricultural traditions, but for the economy of the country as well – even in suburban areas. Suburban territorial planning and development problems are relevant in all countries with large urban agglomerations, however, territorial planning methods applied in foreign countries are intended not for adaptation of non-agricultural territories to specialized farming, but for rational harmonization of the layout of urbanized areas and green spaces (Metods ..., 2001; Green ..., 2005). Meanwhile, the rational use of the Lithuanian Land Fund is associated with the formation of a cultural landscape, in which issues of conservation of suitable agricultural land are to be addressed through the development of territorial planning documents based on scientific recommendations and proper organization of their implementation. The purpose of this article is to analyse the use of the land of suburban territories of the major cities of Lithuania and the peculiarities of agricultural production in these territories.

## **Material and Methods**

The methods of analysis, comparison, graphical modeling, generalization and logical abstraction of scientific literature, territorial planning and other documents related to the analyzed topic were used during the research. The management of agricultural areas and the changes they are undergoing are not only intended for the development of agriculture, they reflect the needs of different branches of industry. This is most pronounced in suburban areas of major cities, which are characterized by more intensive urbanization processes, population concentration, increasing land demand for industrial and warehousing enterprises, residential and recreational construction sites. Therefore, three major Lithuanian cities Vilnius, Kaunas and Klaipeda and their suburban territories, i.e. detailed analyzes of those sub-districts that have a common border with the respective metropolitan area. The main data for the study were obtained from the Lithuanian Department of Statistics and the National Land Service under the Ministry of Agriculture. For the performance of analytical surveys the layers of the KDB10LT sub-district and residential areas and subdivisions of the mapping database of the topographical map M 1:10 000 of the Republic of Lithuania, data from the general agricultural census, 2002-2017 State accounting data of the land were used. In order to determine the impact of urban development on agricultural production and land use, the features of agricultural production as well as land use and its changes (structure of land utilities) were analyzed in suburban areas. Based on theoretical and analytical researches and the analysis of the data obtained, the corresponding conclusions were formulated.

## **Results and Discussion**

In analyzing land use and volume of agricultural production in suburban areas, land areas were divided into the following parts: 1) built-up land; 2) the areas of human activity started to be used for agricultural activities (conditionally called agricultural land, although in this area there are intruded other land utilities which contours have not been mapped on a small scale); 3) man's little redeveloped territories (the rest of the land, the majority of which is made up of forests, as well as swamps, shrubs, other natural or semi-natural land). Due to the impact of urban development, the structure of these components has changed, mainly by reducing agricultural land. Analyzing the data of land registration of the last 15 years, it is evident that the development of urbanized territories in Kaunas and Vilnius districts was at similar rates – almost by 657 and 729 ha, i.e. an average of 69 ha per year. Slower than 3 times the area of built-up areas has changed in Klaipeda district. The built-up areas here increased by about 222 ha, i.e. by 7.71%. However, considering the inaccuracies in accounting for land use changes, the actual area of the built-up areas may be even higher: for the most intensive urban development period in these cities and their suburbs an average of 715.5 hectares were transferred annually from agricultural land to the land used for other purposes.

On average, rural areas of Lithuania (excluding urban land) account for 53.8% of the total agricultural land, 46.0% in Vilnius district, 52.0% in Kaunas district, 55.8% in Klaipeda district. In suburban areas, these indicators are distributed in the following way: in the Vilnius suburban territories – 58.5 percent, Kaunas district – 62.5 percent, Klaipeda district – 71.7 percent. The percentage of built-up areas in Vilnius and Kaunas suburban areas is almost the same, respectively 11.3 and 11.2 percent, while in Klaipeda is slightly smaller – 8.2 percent. (Table 1). However, as can be seen from the data presented above, agricultural land areas, especially in suburban territories, decrease dramatically, mainly at the expense of the rise of built-up areas. Such trends are also very clearly reflected in the general plans of each of the

analyzed areas, where the development of urbanized areas, especially larger suburban settlements, at the expense of agricultural land is very clearly visible. Due to the increasing use of land resources in suburban areas, land plots are shrinking and the area of agricultural land is decreasing.

Table 1. The structure of the agrarian landscape of suburban sub-districts of Vilnius, Kaunas and Klaipeda districts

Sub-districts of suburban district	Number of villages	Area, ha	Built-up territories		Agricultural land		Forests and other lands	
			ha	percent	ha	percent	ha	percent
Vilnius district	245	40011.7	4503.5	11.3	23422.7	58.5	12085.5	30.2
Kaunas district	192	60017.9	6705.8	11.2	37531.8	62.5	15780.2	26.3
Klaipeda district	146	46295.2	3800	8.2	33206	71,7	9289.1	20.1
Total in suburban sub-districts:	583	146324.8	15009.3	10.3	94160.6	64.4	37154.8	25.3

Note: the table does not include villages in which forests and other natural land utilities make up more than 70% of the total area

Thus, in suburban areas, the influence of urban development on the use of land for agrarian territories is manifested in the fact that there is a decrease in the area of agricultural land in them faster than in other areas. However, opportunities for the development of agricultural activities remain in suburban areas as well. Agricultural production indicators that can characterize the impact of a city on specialization of farms include the composition of agricultural plants and the number of domestic animals and poultry per unit area. The amount of livestock held in the farms of suburban sub-districts of Vilnius district per 100 hectares of agricultural land is, in some cases (poultry), considerably higher than in the remaining sub-districts, and the land is more intensively used for potato and vegetable production, and, in some cases, for cereals and industrial plants (Table 2).

Table 2. Comparative indicators of agricultural production (according to the data of the 2010 Census of Agriculture)

Sequence number	Indicators	Vilnius district		Kaunas district		Klaipeda district		Republic of Lithuania
		Suburban subdistricts	Remaining subdistricts	Suburban subdistricts	Remaining subdistricts	Suburban subdistricts	Remaining subdistricts	
1.	Agricultural land efficiency score	36.6	36.2	44.0	47.2	39.9	37.6	42.3
2.	Average farm size, ha	4.2	5.4	5.4	17.6	11.3	9.2	13.7
3.	Structure of agricultural lands and crops, percentage from agricultural land:							
3.1	orchards	1.1	1.0	1.1	0.6	0.4	0.3	0.7
3.2	cereal and industrial plants	28.7	24.2	48.6	69.3	42.9	23.0	49.3
3.3	potatoes and vegetables	6.2	4.5	2.3	1.2	2.6	1.5	1.5
3.4	other plants, perennial grasses, meadows and pastures	53.8	62.2	40.6	24.6	47.9	69.3	43.4
3.5	fallow land and unused land	10.2	8.1	7.4	4.3	6.2	5.9	5.1
4.	Number of livestock per 100 hectares of agricultural land:							
4.1	Cattle	21.5	19.9	27.6	27.6	21.8	31.4	26.9
4.2	Pigs	11.6	67.1	14.9	14.9	7.6	53.7	31.4
4.3	Poultry	21654	127.8	91.9	11.7	64.6	65.4	365.2
4.4	Sheep, goats, horses	17.5	12.5	3.1	3.5	4.0	4.1	4.0

This can be explained by the denser number of farmsteads and the agricultural production adapted to the needs of the urban population, where more potatoes, vegetables and fruits are grown in suburban territories. During the period between the years 2003 and 2010 according to the data of the Universal Agricultural Census, the area of agricultural land used in the districts of Vilnius, Kaunas and Klaipeda decreased by 4.2% on average (in Lithuania it increased by 7.2%). The number of farms growing crops decreased by 36.6% (in Lithuania – 32.5%), the number of farm cows decreased by 39.6% (in Lithuania – 21.8 percent). Due to the ongoing sale of private land or its use for urban construction and other non-agricultural activities in Kaunas district suburbs, fallow land and unused land make up as much as 7.4% of agricultural land (in the remaining sub-districts only 4.3%). In the suburban areas of Vilnius district, this indicator reaches 10.2 percent, while in Klaipeda district 6.2 percent. It needs to be noted that in the district of Vilnius, due to the higher concentration of rural population, farms are the smallest in comparison with other analyzed areas, agricultural land areas are smaller as well.

The largest difference in the size of a medium-sized farm between the suburban and the remaining sub-districts is observed in Kaunas district, i.e. in the suburban areas the average size of the farm is almost 3 times lower than in the remaining sub-districts. Meanwhile, the average area of legally registered land plot used for agricultural purposes in the district of Vilnius is only about 2 ha, in Kaunas district – 2.2 ha, in Klaipeda district – 2.1 ha.

According to the latest data, one person declaring land in Kaunas district used 13.7 ha of agricultural land, on average in Lithuania – 15 ha, and 11.1 ha and 6.1 ha in Klaipeda and Vilnius districts respectively. The largest amount of agricultural land is declared by farms up to 3 ha. The distribution of farm holdings according to the area of agricultural land declared by them is presented in Figure 1.

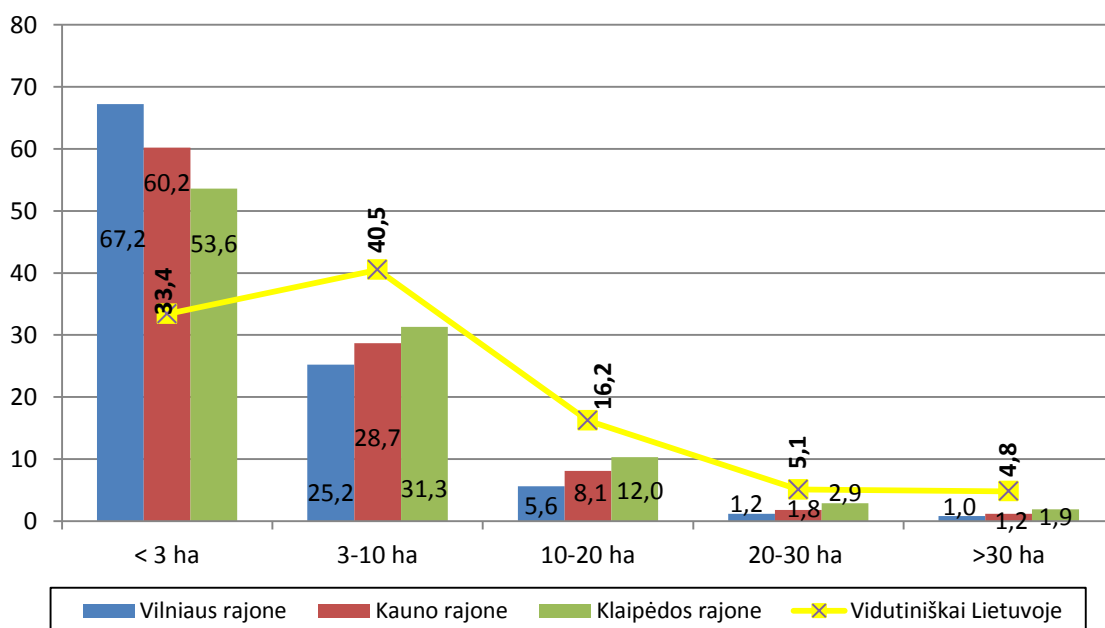


Fig. 1. The structure of farms registered in the Farmer's Farm Register according to the declared agricultural land area in 2011, in percentage

In Vilnius district    In Kaunas district    In Klaipeda district    On average in Lithuania

Such fragmentation of fields and plots of other land utilities and a larger number of small farms determine not only peculiarities of the use of agrarian landscape but agricultural production ones as well: it enables the intensification of agricultural production, in the



suburban areas specializing farms to grow the production necessary for the inhabitants of the city – fruit, berries, vegetables, milk, poultry and so on. However, in the absence of intensive land use, in the suburban areas, the rapid decrease in agricultural land area due to the use of the territory for the layout of structures, the afforestation and the renaturalization of self-propelled land on unused agricultural land limits the possibilities of agricultural development more than in the rest of the territories. Therefore, according to the territorial planning documents, the layout of areas used for agricultural activities in these territories and the formation of outlook for farm land holdings should be foreseen by combining the wishes of land users and the requirements established by legislation for the conservation of productive agricultural land areas.

### **Conclusions**

In Lithuania, as in the whole world, the development of suburban areas is rather intensive, and these tendencies are especially characteristic to the metropolitan areas of large cities, where the influence of urban development on the use of agrarian territories is indicated by the fact that there is a faster decrease (in comparison with other locations) in the area of productive agricultural land, the number of farms in them and their average size as well as the number of animals most commonly held. According to the latest agricultural census data (2003-2010), the area of agricultural land used in Vilnius, Kaunas and Klaipėda districts decreased by 4.2% on average (the total increase in Lithuania was 7.2%), the number of farm crops decreased by 36.6% (in Lithuania – 32.5%), the number of farm cows decreased by 39.6% (in Lithuania – 21.8 percent). The average size of a farm in suburban areas in some cases (in Vilnius district) is even 3 times lower than the average in Lithuania (13.7 ha). According to the territorial planning documents, the layout of areas used for agricultural activities in the suburban territories and the formation of perspective outlets for agricultural holdings should be foreseen for intensive agricultural activity, allowing agricultural entities to specialize in horticulture, gardening and livestock farming, by harmonizing the requirements of land users and the legal requirements for the preservation of productive agricultural land areas.

### **References**

- Bučas J. (2010). Urban development in rural areas: social and agro-protective aspects. Urban forum of Lithuania: splice of urban and rural areas, p. 5-11 (in Lithuanian).
- Green structure and urban planning (2005). Luxembourg: Office for Official Publications of the European Communities.
- General plan of Kaunas city. Municipality of Kaunas city, <http://bendrasiplanas.kaunas.lt/> (accessed on 25 March 2017, in Lithuanian).
- General plan of Kaunas district. Municipality of Kaunas district, [http://www.kaunoplanas.lt/bendrieji\\_planai/kauno\\_rajono\\_savivaldybes\\_bendrasiplanas\\_sprendiniai](http://www.kaunoplanas.lt/bendrieji_planai/kauno_rajono_savivaldybes_bendrasiplanas_sprendiniai) (accessed on 25 March 2017, in Lithuanian).
- General plan of Klaipėda city. Municipality of Klaipėda city, [<http://www.klaipeda.lt/go.php/lit/Miesto-bendrasiplanas/366> (accessed on 29 March 2017, in Lithuanian).
- General plan of Klaipėda district. Municipality of Klaipėda district, <http://old.klaipedos-r.lt/?lt=1252479830> (accessed on 29 March 2017, in Lithuanian).
- Results of census of 2010 in agriculture of the Republic of Lithuania (2010), [https://osp.stat.gov.lt/documents/10180/204989/2010\\_ZUS\\_rezultatai.pdf/47181188-ad5c-4c7c-9b4f-2cd542714007](https://osp.stat.gov.lt/documents/10180/204989/2010_ZUS_rezultatai.pdf/47181188-ad5c-4c7c-9b4f-2cd542714007) (accessed on 3 April 2017, in Lithuanian).

- Data of land fund accounting of the Republic of Lithuania (2002 – 2017), <http://www.nzt.lt/go.php/lit/Lietuvos-respublikos-zemes-fondas> (accessed on 25 March 2017, in Lithuanian).
- General plan of the Republic of Lithuania (2002), <https://www.e-tar.lt/portal/lt/legalAct/TAR.737EFE13DAE0> (accessed on 25 March 2017, in Lithuanian).
- Methods of Environmental Impact Assessment (2001). London, New York: Spon Press.
- Urban sprawl in Europe (2006). European environment agency, [http://www.eea.europa.eu/publications/eea\\_report\\_2006\\_10](http://www.eea.europa.eu/publications/eea_report_2006_10) (accessed on 10 April 2017).
- Vanagas J. (2008). Basics of urbanization. Vilnius, VGTU: Technika (in Lithuanian).

## **MODEL OF REGIONAL DEVELOPMENT THROUGH RURAL AREAS AS RURAL ECONOMIC DEVELOPMENT POLES: CASE OF THE REPUBLIC OF MACEDONIA**

Blagoj GORGIEVSKI<sup>1\*</sup>, Marija GJOSHEVA KOVACHEVIKJ<sup>2</sup>,

<sup>1</sup> University “St. Kliment Ohridski”, Faculty of law, Bitola, Republic of Macedonia,

<sup>2</sup> Institute of Sociological, Political and Juridical Research University, Skopje, Republic of Macedonia

\*Corresponding author: marija9272@yahoo.com

### **Abstract**

During the regional economic development certain rural areas become attractive owing to concentration of economic activity through different channels of economy of scale, external economies and agglomeration of economic activities. Its has been formed like rural areas with certain formative economic development forces. Furthermore, their “spread effects” from growth poles cause induced growth in the remaining peripheral areas. These rural areas as a rural regional development poles are able to generate respectable economic impact in the geographical area becoming pole of the rural development in a certain rural region. In the Republic of Macedonia the model of regional economic development trough rural areas as a rural economic development poles need to have a major role in the formulation of a rural regional economic development policy, respecting the specificities of the regional development of small and underdeveloped economy.

**Key words:** *rural areas, rural development poles, regional development.*

### **Introduction**

Perroux (1955) defined growth poles in terms of what he called *abstract economic space*. According to him “growth does not appear everywhere at the same time; it becomes manifest at points or poles of growth with variable intensity and spreads through different channels with variable terminal effects on the whole of the economy”. Perroux and other writers on Growth Pole tried to base the concept on the notion of external economies, agglomeration and linkages. It was believed that beneficial “spread effects” from growth poles would eventually induce development in the remaining peripheral areas, and that they would have a significant relay function in the process of innovation diffusion through the urban hierarchy. Economic geography contends that proximity is essential in order to access spillovers, pecuniary and non- pecuniary, originating in the interaction between people, firms and institutions, through vertical and horizontal linkages. Furthermore, concentrated production also gives rise to external scale effects. Thus there would appear to be a clear link between growth and densely concentrated production. This has preciously been discussed in the theoretical literature (Fujita and Thisse, 2002; Perroux 1961; Kaldor 1961; Myrdal 1957; Hirschman 1958). The neoclassical regional growth model primarily focuses on the long-run potential growth path of the economies. Further to this is the ‘Circular and Cumulative Growth Model’ enunciated by Gunnar Myrdal. This model advocates a regional growth approach, which is sought to be “selfequilibrating”. It is assumed that the expansion of a business or industry would create a multiplier effect, which would lead to more jobs and business as money flows through the economy. This growth would increase the likelihood of new inventions or innovations, thus creating another round of expansion. So, in the

polycentric model articulated on the only urban poles, the dynamic principles of social, economic and territorial cohesion are imperfectly implemented whereas one of the initial characteristics common to the European States is to have rural areas with strong cultural and social expression, and inhabited everywhere. Without mobilizing the building capacities of rural territories, one misses a genuine social, economic and territorial engine for sustainable development. The right thing to do is thus to organize social, economic, territorial exchanges balanced between rural territories and urban poles. The recognition of the rural areas as development poles, and neither only as natural and agricultural spaces, is a precondition to stimulate advantageous and balanced exchanges between the urban and rural poles and to motivate the convergent mobilization of the urban and rural actors. The rural areas becoming development poles are able to meet, as partners, the great rural and societal questions, but according to programmed and prospective steps. They can in this context accommodate new populations and offer to them a real statute of inhabitant. They can offer new activities linked with the territory project and the local resources or integrated in the relationships with the rural poles of proximity and their own sector of development. In term of regional planning, this multipolar approach is also a response to the continuous extension of the rural centres; it allows, through land planning perspective shared between urban and rural poles, to preserve green and open spaces between high-density areas. The rural pole of development is an inhabited territory where the social, economic and residential evolutions are led within the framework of an integrated and prospective project of development. The rural pole is not a small town, an agglomeration, but a rural territory as a whole and guided by an integrated project of territory. The rural pole of development is an inhabited territory where the social, economic and residential evolutions are led within the framework of an integrated and prospective project of development. In the first stage of elaboration, were identified priority rural areas in consultation with various rural sector stakeholders. Initially, this study was prepared for priority sub-sectors in the rural regions (milk and dairy, meat and meat products, fruit and vegetables and wine and grapes) to identify the major potentials to be boosted.

### **Material and methods**

The four sub-sectors and into its rural areas were selected based on their importance in the agricultural GDP and according to the process of adoption of the EU acquis according to the National Programme for Adoption of Acquis (NPAA) and institutions related ( self-governments, regional agricultural departments, regional offices of the National Extension Agency, Farmers Federation and Non-governmental organisations). The programme was based on the National Development Plan (NDP), the National Strategy for Agriculture and Rural Development, as well as the Multi-annual Indicative Planning Document (MIPD), framework of available measures under Instrument for Pre-accession Assistance for Agriculture and Rural Development (IPARD) and the results of the independent sub-sector and rural areas analysis.

### **Results and Discussion**

In the Republic of Macedonia., the concept of rural growth poles has usually emphasised geographic locations, which are called *Growth Rural Centres*. Altogether, the concept of Growth Poles has been of only marginal importance in analysing rural regional economic problems. Throughout the country the concept of Rural Growth poles has not had a major role in the formulation of a rural regional economic development policy.

Rural areas have tended to be forgotten in Macedonian development strategies in the past. However, their development must now become the main objective and this has also been linked to growth pole strategies.

For administrative purposes, the differentiation between rural and urban areas in the country is based on the local territorial divisions according to the Law on Territorial Organization of the Local Self-Government (official gazette OG - 55/2004, 12/2005) i.e. Article 6: The Definition of the Populated Areas (settlements) of the Territory of the country providing definitions of towns and villages as presented below:

- The towns are compactly built up residential areas with a population exceeding 3000, has a developed structure of various economic activities, above 51% of the employees are working in the secondary and tertiary sector, has an urban physiognomy of zones for residence, recreation and green area (parks), town square, street infrastructure, communal services and acts as a functional centre for the surrounding populated places.

- Villages are defined as mono-functional populated areas, in which one business activity is prevalent and whereas the area has agricultural physiognomy and function. According to the Law all Municipalities being with headquarters settled in villages.

The rural territory of the country includes all territory of the country, except towns, which have no rural territories or characteristics of villages pursuant to the Law on Territorial Organization of the Local Self-Government (OG 55/2004, 12/2005) and Determination of a Status of Populated Areas in Article 6.

Rural areas abound of high quality of natural environment (lakes, mountains, protected areas), attractions (landscapes, traditional villages, hunting, fishing, SPA resort, etc.) and of rich historical/cultural heritage for the development of rural, cultural, religious and agri tourism. Furthermore, availability of raw materials (timber, region-specific products, local traditional agricultural and livestock products) and so existence of traditional skills, crafts and food production.

The main opportunities in the rural development poles in the R. Macedonia are:

- geographic diversity of culture, customs, traditional events
- labour- force from decreasing agricultural sector is open for other rural activities, for which there are available natural resources
- growing demand for well-established tourist destination in the country is generating foreign visitors interest in rural tourism
- increased government concerns about rural/urban and regional disparities and the environment, and formulation of consistent policies
- possibilities for production and sale of high quality/typical/organic local rural produce
- creation of new entrepreneurs, family businesses and additional jobs in rural areas
- new important transit corridors will soon be completed.

The growth poles strategies, can be proposed and implemented in widely diverse ways in various settings, have a set of general characteristics among them and:

- Involve increasing the growth of employment and population within rural areas at particular locations or planned poles over some specified period.
- Require a limitation on the number of locations or centres which are designated as planned poles.
- Necessarily require spatial discrimination or selectivity among locations.
- Inevitably involve modifications of spatial structure of employment and population within a rural areas.

The common method, which will be applied for the purpose of implementing Rural policy programme can be defining rural areas as rural development poles being located outside of urban area and characterised by three main characteristics:

- settlements placed in municipalities based in rural centers (rural Municipalities);
- settlements placed in municipalities based in town centers with predominantly agricultural and forests land use systems (urban versus agriculture land (incl. forests, pastures, marshland, fishponds); and
- towns with population of less than 30,000 inhabitants with predominantly agricultural and forests land use systems (urban versus agriculture land (incl. forests, pastures, marshland, fishponds) and rural identity of the community.

Generally, rural areas have certain problems about attractiveness to businesses for several reasons: lack of concentration of population, poorer educational levels, lesser flexibility of the potential workforce, and distances from potential markets (for both inputs and outputs), all putting businesses in rural areas at a cost disadvantage. Poorly developed and diversified economic infrastructure and the consequent lack of quality jobs are common features of rural areas in the country. These are also the main causes of development lag typical of these areas which need to play a role like a rural development poles.

### **Conclusions**

The above analysis has singled out a series of aspects, by no means comprehensive, to highlight issues arising from the rural areas as rural development poles. In the country the concept of Rural Growth poles has not had a major role in the formulation and implementation of a rural regional economic development policy Rural policy programme, can be defining rural areas as rural development poles being located outside of urban area.

Futhermore, to poin out the main opportunities in the rural development poles in the R. Macedonia. Rural areas abound of high quality of natural environment, attractions and of rich historical/cultural heritage for the development of rural, cultural, religious and agri- tourism.

The main opportunities in the rural development poles are geographic diversity of culture, customs, traditional events, growing demand for well-established tourist destination in the country is generating foreign visitors interest in rural tourism creation of new entrepreneurs, family businesses and additional jobs in rural areas and new important transit corridors will soon be completed. Generally, rural areas have a certain problems about attractiveness to businesses for several reasons: lack of concentration of population, poorer educational levels, lesser flexibility of the potential workforce, and distances from potential markets (for both inputs and outputs), all putting businesses in rural areas at a cost disadvantage. Poorly developed and diversified economic infrastructure and the consequent lack of quality jobs are common features of rural areas in the country. These are also the main causes of development lag typical of these areas which need to play a role like a rural development poles. A growth pole strategy for Macedonian economic growth is what a country pursues unconsciously in practice. The eligible measures and areas of development support include implementation of the economic infrastructure projects and, also, implementation of non-economic infrastructure projects.

### **References**

- Fujita, M and Thisse, J.-F., (2002), *Economics of Agglomeration. Cities, Industrial Location and Regional Growth*, Cambridge University Press, Cambridge
- Hirschman, A.O., (1958), *The Strategy of Development*, Yale University Press, New Haven, CN.
- Myrdal, G., 1957, *Economic Theory and Underdeveloped Regions*, Duckworth, London.
- National plan for agriculture and rural development 2007-2013, MAFWE, Skopje, 14 December 2007

- Nacional strategy for agriculture and rural development 2014-2020, MAFWE, Skopje, December 2014
- Perroux, F., (1955), “Note Sur la Notion de Pôle de Croissance”,” *Economique Appliquée*” 1–2, 307–320.
- Kaldor, N., 1961, “Capital Accumulation and Economic Growth”, in Lutz, F.A. and Hague, D.C. (eds.), *The Theory of Capital*, MacMillan, London.
- Strategy for regional development of the Republic of Macedonia, Official Gazette of the Republic of Macedonia 119/09

## **MANAGERIAL CHALLENGES AND LEADERSHIP IN FUNCTION OF DEVELOPMENT OF MODERN AGRIBUSINESS COMPANIES**

Katerina BOJKOVSKA, Trajan DOJCHINOVSKI, Nikolche JANKULOVSKI, Goran MIHAJLOVSKI, Sasho BOJKOVSKI, Elena JOSHEVSKA

University “St. Kliment Ohridski” – Bitola, Faculty of biotechnical Sciences – Bitola, Macedonia

\*Corresponding author: katerina.bojkovska@uklo.edu.mk

### **Abstract**

The turbulent global environment and the current conditions in the economy are forcing agribusiness companies for a fast and flexible adaptation to the changes. A precondition for that is an effective system of management and application of appropriate leadership style. The management is a process of creating and maintaining a business environment where individuals work in teams to achieve the set goals. The leadership as a function of management involves the establishment of interpersonal relationships, leadership, employee motivation and communication. The purpose of this paper is to determine the capacity of managers as leaders of certain organizational levels in enterprises in the field of agricultural business. Considering the absence or presence of certain characteristics, it is estimated the extent to which managers express their leadership potential. To achieve the goal of the research, we applied the method of questionnaire survey conducted in ten medium-sized enterprises (from 50-250 employees) in the field of agribusiness in Republic of Macedonia, at a strategic, tactical and operational management level. The results from the conducted survey indicate that managers in agribusiness companies mostly expressed tendency to think like leaders and their behavior is close to modern knowledge for effective leadership. In the agricultural business sector in Republic of Macedonia predominates the known and stable management practice. It is a fact that the dynamic business environment of the food industry requires particularly high professionalism, innovation and ability to coordinate their leading personnel. Regarding the actuality of the topic of leadership and its importance for the business success of the company, this research provides an overview of the functions of management in some selected Macedonian enterprises in the area of agricultural business.

**Key words:** *Management, Leadership, Agribusiness, Business success.*

### **Introduction**

Management has been studied for hundreds of years, and its beginnings date back thousands of years before our era. Despite the nature of the business revolution that caused management, it is still occupied with its fundamental problem - optimal use of resources in the organization in conditions of uncertain everyday life. Already in the last decades of the last century, and especially today, companies have become a mix of increasingly complex networks of relationships in which it is difficult to determine effective communication and create a favorable environment for employees, while at the same time achieving the desired business results. Management requires greater engagement of managers with respect to their time, knowledge and social skills, and precisely the high demands and their successful fulfillment represent the fundamental difference between the successful and the less successful managers. In this sense, modern theory leads to a systemic approach by which the



organization is seen as a whole consisting of related components and unforeseen (situational) approach, where each situation is unique because there is no single, perfect style of leading. Leadership involves a set of qualities and managerial knowledge that have influence on the success of companies through segments of relationships between levels of management, business decision-making, communication, understanding of the goals and vision of the company and as a result - the product or service of the company. For this reason, the topic is multidimensional, and the paper is an approach from a theoretical, descriptive and empirical aspect of conducting survey questionnaires. Leadership (leading) is referred as the most important function of management, according that the success does not depend to any extent on any other function. When mentioning leadership, it is necessary to distinguish two basic relationships: leadership and leading, as well as management and leading. In the first case, leading is superior because leading with motivating employees and interpersonal relationships is part of its action. Leadership acts as a subset i.e. presents one of its functions. In that sense, theorists strive to distinguish the managerial characteristics from the leading that in some cases results in a (too) extensive division in which deliberately or not are specified the positive aspects of the characteristics of the leading. Experts are still divided about leadership, more precisely whether it is a process or ability. This approach strongly is connected with the question of whether leaders are born or created? Northaus (2007) removed the thinking that leading is not characterized by one person only and is not reserved for several defenses, but it is a transaction of events between leaders and followers in which each side contributes. In this sense it is a matter of two-way events because the leader has influence and is influenced by his followers (Northaus, 2010). Contrary to Northaus's perceptions of leading as a process, the authors Robbins and Judge (2009) attach importance to the ability and the art, thereby emphasizing its less mysterious side. However, everyone is unanimous about one thing - the influence of the leader of a group of people in common would be focused on achieving the common vision and goals (Northaus 2010; Robbins and Judge, 2009). Agribusiness enterprises as a food sector are resistant to the effects of crises due to the profitable inelasticity of food costs in relation to non-food companies (Hadelan et al., 2012). Related to the success of the companies, the main subject of the research revolves around examining the characteristics of the managerial levels i.e. the assumptions in the Macedonian agribusinesses compared to the success, grows the 'value' of the managers in terms of their management, decision-making, horizontal and vertical relations with co-workers, i.e. - whether the quality of management is in line with the success of the company. The subject of research is the managerial function of leading and its contribution to the success of the agribusiness organizations through exploring the theoretical foundations of management and leading and questioning the managers in the randomly selected agribusiness enterprises from Republic of Macedonia. Collecting data about their profile characteristics and actions given the hierarchical levels was done in order to further interpretation of the difference of the leader from the manager. The assumption is how the highest levels of management in percentages have characteristics of leaders because it is needed for their work, and middle and low level managers have more pronounced managerial qualities that are suitable for their day-to-day tasks. Finally, the search for leaders in agribusiness is a guide to this research.

### **Materials and methods**

For the needs of the labor, the descriptive method was used as the basis for providing facts about the observed behavioral phenomena and striving to explain them by means of statistical analysis of the data. Furthermore, a survey method was used to collect data for the characteristics of the managers of Macedonian agribusinesses by means of questionnaires.

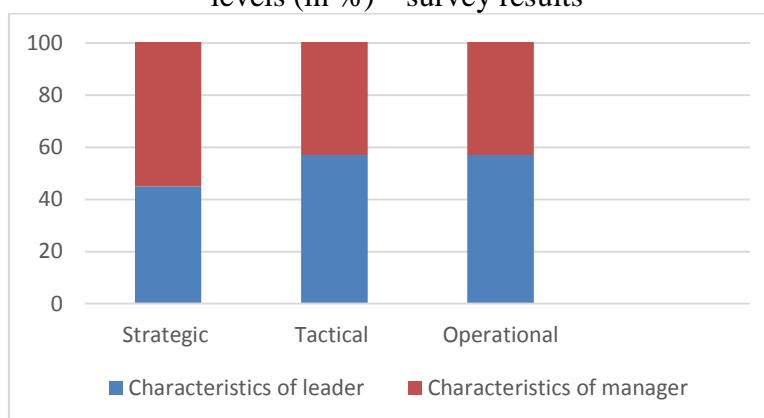
Compilation and comparison methods are used in terms of comparing the results of the researches with those of the existing literature. For the survey is applied questionnaire. In this research, the survey questionnaire acts as a verification method that will help to check the hypothesis based on the collected data and information. The survey procedure started with the selected voluntary sample, which is unique available in such surveys. The main activity of the examined enterprises covers the production of agro-food products. In 100% of cases, respondents probably for the efficiency and time savings have chosen the online service option which greatly facilitates the procedure itself. An online survey allows quick answering of the questions and an automatic reply to the sender. The selected sample consists of managers who are in the higher (strategic), middle (tactical) or low (operational) level of management. The survey has been implemented between March 15 and April 15, 2017. In the survey participated 5 agribusiness enterprises and two companies from the banking sector as a control group. The survey examined 11 agribusiness managers (n = 11).

### **Results and discussion**

The main framework refers to a horizontal comparison of levels of management (strategic, tactical and operational), which seeks to determine and describe the manager's behavior depending on his hierarchy. Most of the agribusinesses in terms of legal form belong to joint stock companies, while to a lesser degree are companies with limited responsibility. In the agribusiness there are three levels of management (37%), although there are firms with two levels (31%) and with four levels (27%) are also known. In terms of professional training, all managers at the highest level have a high degree of preparation (100%), while at the secondary levels except high (50%) there are still higher professional training (25%) and master specialization (25%). At low levels, all surveyed managers also have a high degree of preparation (100%). According to the above, it is obvious that the representation of higher education in the workforce at the managerial levels in the Macedonian agribusinesses is evident. In the field of professions, leads the economic (high level 75%, intermediate and low level 100%), and specialist knowledge of agricultural sciences is highlighted only by one high-level manager. Male managers predominate at high (100%), secondary (75%) and low level (100%). The age structure indicates that the oldest managers (between the ages of 41-50) are the most represented in strategic positions while the tactical and operational ones are younger (between 31-40) years. The opinion of the managers on the importance of the function shows that the high and low levels of management as the most important evaluate cost control, and the middle function - the organization. The low level pleads with high scores for functions that are typical of their superiors - organizing (4.5), goals and strategy (4.5), while contrary to that developing and empowering employees at this level lags behind what was not expected. On the question of the nature of the relationship to management, all the examined levels consider that the skill is to a large extent, with which the characteristics of knowledge and the arts are suppressed in the background. Managers at high and low levels think that their own skills and the capabilities of their co-workers are most deserving of their success. The middle managers besides the stated, as a reason for success, also indicate the situation that surrounds them. According to the above, the success of the company arises the most from the ability of its management. In the surveyed enterprises, the line management system predominates (83%) in which employees receive orders from one senior manager. No presence of modern project or matrix forms of organizational structure has been noticed yet. According to the answers of the respondents, the most important features of managers at all levels are: the ability to transfer knowledge, innovation and coordination of activities, decision-making speed and expertise. Higher general education and great managerial experience are considered as least important for managerial success.

Indication of one's own characteristics is neither simple nor precise, and it is massive to perceive the desired qualities as those already possessed. High levels of management are completely committed to work and are capable of motivating collaborators and deciding in different situations. Medium managers are considered as trustworthy people. Low managers perfectly understand their work and give freedom to collaborators in deciding. The groups of variables that determine whether managers have expressed characteristics of leaders in the research are set in the form of a choice between two offered assertions that describe the attitude of the respondent. Given the tested group of properties, the first group contains 6 questions, the other group contains 4 questions, the third group one question, and the fourth group contains 4 questions.

Figure 1 Comparison of characteristics of leaders and managers according to management levels (in %) – survey results



Source: Author's research

Medium and low level managers show a greater inclination to thinking as leaders (57%) in terms of senior management (45%) (Figure 1). These results need to be seen from the aspect of the environment in which managers act - at strategic and tactical levels are the characteristics of managers and leaders, deployed with only a little overpower of one of them. The Great Hierarchy requires individuals who are both quality managers and dedicated leaders. The survey showed that in agribusinesses at the highest levels largely dominated the managerial way of thinking and at the other levels the respondents gave greater importance to leadership. One of the most difficult tasks of management is the decision-making, in particular the choice of the direction of taking action to solve the problems (Schermerhorn et al., 2002). Professional ability, responsibility, as well as objective information the best encourages good decision-making at all levels of management. Senior and middle managers carry not programmed decisions that are based on objective rationalities in a changing environment. In contrast, low levels of management often decide on the basis of the estimation whose results are programmed decisions. The risk aversion is greatest in the low levels of management that can be brought about in terms of their position on the hierarchical scale which generally requires making less responsible decisions with short-term consequences in terms of decision-making at higher levels. The autocratic leadership style maximizes the authority and power of a person who makes decisions and for subordinates applies a system of rewards and punishments. In contrast, superiors who in the decision-making process include their subordinates and give great attention to the positive, interpersonal relationships using democratic style of leadership. Managers in Macedonian agribusinesses do not apply an autocratic management style. To a large extent, the democratic style is practiced (60%). Apart from the second style, there is also a style that is characterized between autocratic and

democratic (40%). The stated styles are in line with the high and low levels (size 50:50), while the democratic style predominates at the middle levels (80%).

Table 2 Profile of agribusiness manager according to levels – survey results

<b>Variables</b>	<b>Strategic level</b>	<b>Tactical level</b>	<b>Operational level</b>
<b>Leader’s characteristics</b>	45%	57%	57%
<b>Democratic leadership style</b>	50%	80%	50%
<b>Non-programmed decisions</b>	52%	51%	31%
<b>Strong risk tendency</b>	25%	60%	100%
<b>Management as a skill</b>	100%	100%	100%

Source: Author’s research

In accordance with the hierarchy, senior managers spend an average of 35%, middle managers around 33% and low managers 25% more than the established working hours. Intermediate managers spend most of their time communicating with their superiors, while high and low levels of management often address to collaborators inside the organizational unit. On the basis of the conducted research, a profile of the agribusiness manager has been constructed by levels (Table 2) which shows their main characteristics.

### **Conclusion**

The assumption that at higher levels, managers in larger percentages have the qualities of leaders, and managers at medium and low levels expressed managerial attributes has not been verified. Managers in agribusiness, according to the average for all levels, express the qualities of leaders in 53% of cases. High levels of management in agribusiness enterprises express the attributes of leaders in 45% of cases. At medium and low levels, contrary to expectations, the characteristics of leaders predominate (57%). In agribusiness, the most democratic is the leading style (60%) and the style between autocratic and democratic (40%). According to the above, it is confirmed the assumption for agribusiness as a sector whose management operates in accordance with other economic activities. Managers at higher levels of management in agribusiness are male at the age of 41-50, have economic training, make un programmed decisions, are partially risk-prone, prefer democratic as well as a style between autocratic and democratic, and 45% of their characteristics describe them as leaders. Medium sized agribusiness managers are generally male, aged 31-40, economists, often make un programmed decisions, they are risk-prone, and largely use a democratic style of leading and accomplish 57% of the characteristics of leaders. At low levels, predominate male managers with 31-40 years of age, from an economical profession, make programmed decisions, the most are prone to risk. They direct their leading to the democratic style as well as to the style between autocratic and democratic and express 57% of the characteristics of the leaders. The research of the characteristics of the examinee as well as the linking of their characteristics with the success of the enterprises points to the great potential of agribusiness management in Republic of Macedonia and serves for further direction of scientific researches. The central thinking that arises refers to the lack of strictly separated boundaries between managerial and leadership style, it is difficult to accurately define a person who completely reflects the characteristics exclusively of one of them, but that is not the final goal. In their combination and manifestation of a separate style, given certain factors from the immediate and wider environment depend the management success, and preconditions are the knowledge, skills and abilities of the leaders and the employees. In the modern dynamic and

uncertain environment, a sharp increase in the significance of the quality of interpersonal relationships is expected in every connection, and especially in business, which requires researches with which the attributes of managers and leadership styles will reach a recognizable and clear dimension just like the size of their impacts on the success of the operation.

### **References**

- Hadelan L., Tea Karlič, Ornella Mikuš, V. Par, (2012). Family farms decision making features. *Agronomski glasnik*. 2-3/2012.
- Northous, P., (2007). *Leadership: theory and practice*, 4<sup>th</sup> ed. Thousand Oaks, CA: Sage Publications.
- Northous, P., (2010). *Leadership: teory and practice*, Zagreb: MATE d.o.o., Croatia.
- Robbins, P. and Judge, T., (2009), *Organizational Behavior*, Twelfth Edition, Zagreb: MATE d.o.o. Croatia.
- Schermerhorn, J., Hunt, J., Osborn, R., (2002), *Organizational behavior*, seventh edition, SAD: John Wiley & Sons, Inc., University of Phoenix.

## INFLUENCE OF GENDER EQUALITY ON SUSTAINABLE DEVELOPMENT OF VILLAGES IN THE REPUBLIC OF MACEDONIA

Marija GJOSHEVA KOVACHEVIKJ<sup>1\*</sup>, Blagoj GORGIEVSKI<sup>2</sup>

<sup>1</sup>Institute of Sociological, Political and Juridical Research, Skopje, Republic of Macedonia,

<sup>2</sup>University “St. Kliment Ohridski”, Bitola, Faculty of Law, Republic of Macedonia

\*Corresponding author: marija9272@yahoo.com

### Abstract

Sustainable rural development is important for the society, posing a challenge for rural households, in terms of ensuring continuous improvement of the quality of life and wellbeing for present and future generations. The equal participation of rural women and men is crucial for sustainable development but still remains a complex goal. The aim of this paper was to review the status of women in rural areas from the perspective of gender balance and to highlight the role of the equality in the activities related to sustainable rural development. The methods of descriptive statistics of data were used to process the official data for gender balance in the labour market. Additionally, a field interview for gender equality in decision-making and management was conducted on 140 rural households in Macedonia. The findings demonstrate that the employment rate of rural women amounted to 34%, what is lower than the employment rate of men in rural areas (66%). According to the structure of the status of employees in rural areas, women in the “unpaid family workers” category amounted to 8%, compared to women in urban areas amounting to only 1%. Additionally, the data from the field research show that rural women have very low levels of decision-making in the family and leadership of family businesses, especially in the rural areas with predominantly Muslim population. By identifying gender-differentiated opportunities and constraints, policy makers in Macedonia can develop gender-responsive actions that can lead to more effective measures for the overall improvement in natural resources management.

**Key words:** *Gender, Rural women, Sustainable rural development, Macedonia.*

### Introduction

Sustainable development is a multidimensional principle which calls for integrating social, ecological and economic objectives at various geographical scales, and ensuring compliance with general system requirements, such as ecological and cultural integrity, economic stability, social equity, and economic efficiency (Hediger *et al.*, 1998). Sustainable rural development, as a crucial component for many societies, especially for the countries with predominant rural areas as it is Macedonia, poses a big challenge to ensure mitigation of the unsustainable trends regarding climate changes, energy usage, poverty and social exclusion, demographic pressure and aging, threats to public health, use of natural resources and loss of biodiversity.

Inspired by the common agricultural policy of the EU, the Republic of Macedonia reaffirmed its rural development policy in order to increase the competitiveness of family businesses and to improve the living conditions in rural areas. This is in particular important as rural areas cover 80% of the total territory of the country and 59% of the total population lives in predominantly rural regions (compared to 22,5% in the EU 27, according to the Eurostat). However, the indicators show that the country has modest improvements or even negative

trends in some areas consider as significant for rural sustainable development. For those who live in rural areas, the problem of access to banking services face 36%, access to postal services 24% and access to cultural facilities 20%. Basic transportation services are not available or are difficult to access for 22% of the populations in rural areas. The need to improve the road network in rural areas is highlighted as a high priority, both in lowland villages (51%) and in the mountain villages (54%) (MAFWE, 2015). Furthermore, internal migration data show an increase from rural to urban migration. In 2015, the total number of migrants from rural to urban areas increased by 2.7% in comparison with the previous year. The number of migrants aged 15-29 decreased by 2.0%, while the number of working-age migrants (30-64) grew by 9.0%. Considerable share (13,4%) of rural population above age of 15 has insufficient or total lack of education, 2,6% are illiterate and 10,9% have not completed primary education. Illiteracy is higher among women (4,5%) than among men (1,3%) and it is particularly worrisome among the female adult population as there are more than three times as many adult illiterate women as there are illiterate men. The educational problem is obvious among the unemployed, since only 16% of them have higher or university education, the majority (55%) has secondary education, and the remaining 29% are unqualified (MAFWE, 2015). These facts designate that the development of the the socio-economic situation in the rural areas should be high priority for the country at all levels. Studies from FAO (2015) and World Bank group (2010) indicate that the women's empowerment is a pre-condition for achieving of the sustainable rural development goals, such as poverty, responsible consumption and production, migration, affordable and clean energy, clean water and sanitation and others. Consequently the rural women and men have different needs, priorities, and knowledge about diverse crops, plants, and animals what play important roles in resource management and genetic diversity. Women, therefore, play an important role in maintaining biodiversity, working against the decrease in biodiversity caused in part by men favouring cash-oriented monocultures (Lope-Alzina, 2007). Gender inequality in the rural society cause increased vulnerability of women with the inappropriate management of the natural resources, what are the main sources for living of the rural population. The aim of this paper is to provide an overview of the current situation of the rural women in Macedonia, and highlights the importance of the gender dimensions in the planning and implementation of the strategies for rural sustainability.

### **Material and Methods**

The research is based on primary and secondary source of data. The target group are the rural households in Macedonia, which according to the Statistical data cover 59% of the total population. The survey refers to the 2015, encompassing data from 140 rural households from two different regions in Macedonia, Polog and Pelagonia. The questionnaires are composed of three sections. One section contained questions about households' characteristics (location, nationalities, gender structure of the families and family holders), the second focus on the source of incomes in the family and involvement of the rural woman in the family rural businesses, and the third asked about role of women in decision-making in the family in terms of children nutrition and task assignments, family businesses, spending of the family budget and selling of the family produced products and services.

Apart from field survey, the research use secondary source of data, mainly from official statistics. The methods of descriptive statistics of data were used to process the official data for sustainable indicators in the Republic of Macedonia, in order to get the general picture of the current situation, as well data for the gender balance in the labor market were provided by Labor force survey in 2016 and from the publication for women and men in Macedonia for 2016. In addition, research data for gender equity in education, land ownership, migration

agricultural production in Macedonia, conducted by concerned institution on this issue, such as FAO, World Bank group, Ministry of agriculture, forestry and water economy, UN women, CRPM (Centre for research and policy making in Macedonia), have been used.

### **Results and Discussion**

According to the field survey, for most of the interviewed rural households (75% or 105 rural households) agriculture is the primary activity and the main source of income, followed by households with main incomes from own small businesses (crafts, rural tourism, processing of agricultural products) representing around 10% (14 households), 13% (18 households) live from salaries from employments at others and about 2 % from pensions.

The research revealed that out of the total surveyed rural households; there are only 9 women family holders (7%). The situation is worse in the Polog region with predominantly Muslim population (Albanians and Turks are around 65% of total interviewed households) with share of only 3% of women family holders compared to the Pelagonia region with share of 10% (Table 1). This indicates a low level of gender equality in terms of ownership, i.e. the holder of the rural economy, but the involvement of women in production, especially labor in harvesting as a family, is a highly prevalent and an average of 33% of the total family labor. In most cases, the woman is the owner of the rural family business as formality due to higher state support for rural women.

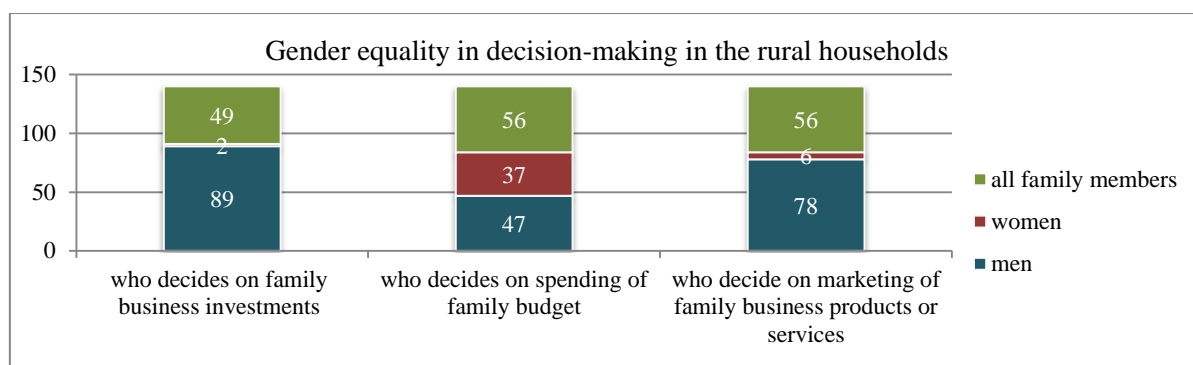
Table 1. Structure of family holder according to the gender and nationality

Nationalities/Regions	Macedon.	Albanian.	Turks	Vlachs	Others	Total	Share
<b>Pelagonia</b>	<b>54</b>	<b>10</b>	<b>2</b>	<b>3</b>	<b>1</b>	<b>70</b>	100%
women	4	0	0	3	0	7	10%
men	50	10	2	0	1	63	90%
<b>Polog</b>	<b>24</b>	<b>40</b>	<b>6</b>	<b>0</b>	<b>0</b>	<b>70</b>	100%
women	2	0	0	0	0	2	3%
men	22	40	6	0	0	68	97%
<b>Grand Total</b>	<b>78</b>	<b>50</b>	<b>8</b>	<b>3</b>	<b>1</b>	<b>140</b>	100%

Sources: Own field survey, 2015

The most of the interviewed family members (72%) consider that the role of rural women have decision making power in assigning working tasks to the children and nutrition. In addition, the field research indicates that the main decision making power in Macedonian rural families lies with males who make almost all decisions concerning family business investments (less than 1% of the rural women population has role in taking decision for family business occupation). About 26% (37 women) of the rural women take decisions on spending of the family budget and only 4% (6 women) on marketing of the family business products or services. However, the rural women are involved in the groups where the decisions are taken by all family members, with a share of approximately 40% or 56 responds to this group.





Graph 1: Gender equality in decision making in rural households  
Sources: Own field survey, 2015

The labour market in Macedonia is characterized by a gender imbalance in favour of males in both, rural and urban areas. In 2016, the employment rate for women in urban areas (43%) is lower than the employment rate for men (57%), but this ratio is much higher in rural areas, where employment rate for women is 34% compared to 66% of employment rate for men (Table 2). In addition, the gender gap between unpaid rural male workforce and unpaid rural female workforce sees disparity in favour of women, accounting 5% and 8% respectively, while the share of unpaid women labor in urban areas is even less than 1%. Only 4% of rural women are registered as self-employed mainly because in less than 6% of rural households, women own farmland or a house (CRPM, 2012). On contrary, 16% of the total male labour force in rural areas is self-employed, what are the mostly agricultural workers. The share of businesses run by women is very low in rural (1%) and in urban (2%) areas as well, with little advantage in urban areas.

Table 2. Employed by economic status and gender in urban and rural areas, 2016.

Employed by economic status and gender in urban areas, 2016										
Gender	Total		Employee		Employer		Self-employed		Unpaid family worker	
<b>Total</b>	<b>413,383</b>	100%	<b>350,609</b>	85%	<b>22,097</b>	5%	<b>33,107</b>	8%	<b>7,570</b>	2%
Men	234,951	57%	190,331	46%	15,812	4%	25,680	6%	3,129	1%
Women	178,432	43%	160,278	39%	6,286	2%	7,427	2%	4,441	1%
Employed by economic status and gender in rural areas, 2016										
Gender	Total		Employee		Employer		Self-employed		Unpaid family worker	
<b>Total</b>	<b>310,167</b>	100%	<b>198,364</b>	64%	<b>9,905</b>	3%	<b>62,258</b>	20%	<b>39,641</b>	13%
Men	204,765	66%	131,096	42%	8,234	3%	49,980	16%	15,455	5%
Women	105,402	34%	67,268	22%	1,671	1%	12,278	4%	24,186	8%

\*Source: State Statistical Office, 2016.

Women's participation in agriculture in the country is also characterized by lack of land ownership, little input into agricultural decision making, and lack of control over their time and labour (FAO, 2015). Women in rural areas tend to have primary education only, while in the urban areas, they tend to complete secondary levels at least. According to the survey of rural women by UN Women, in the majority of households women and men together make the important decisions concerning children (CRPM, 2012). Access to new technology, information, and training related to natural resource management remains highly gendered, with most of the related initiatives targeted to men (World Bank group, 2010). It is known that communities are better off during natural disasters when women play a leadership role in

early warning systems and reconstruction. Other studies have found that women tend to share information related to community well-being, choose less polluting energy sources and adapt more easily to environmental changes when their family's survival is at stake (International Union for Conservation of Nature and Natural Resources, 2007; Women's Environment and Development Organization, 2007). Despite numerous efforts to mainstream gender, many governments, nongovernmental organizations (NGOs), and development agencies find these efforts particularly difficult in the agriculture and natural resource arenas. For example, extension personnel in agriculture and natural resources frequently speak only to men, often erroneously expecting that the men will convey information to their wives. Until gender is successfully mainstreamed, women's groups, organizations, and networks can increase women's access to knowledge, information, and technologies (Enarson and Meyreles 2004). Women are still absent from the climate change and natural resource-related decision-making processes at all levels (World Bank group, 2010). Equal participation in community-based decision making remains a complex and difficult goal to achieve, especially in the contexts of highly unequal gender and class relations. At the local level, more natural resource projects and interventions emphasize community-level participation (World Bank group, 2010).

### **Conclusions**

The sustainable rural development is a crucial for growing of the Macedonian economy take into consideration that rural area cover 80% of the total territory of the country and 59% of the total population. Data from the field research and official sources demonstrate that the population in rural areas in the country is significantly deprived in terms of population in urban areas in many respects. For example, the rural areas in Macedonia outside urban municipalities experience higher population decline; less access to public services; have less-educated labour force; experienced much higher unemployment rates and have lower incomes. Furthermore, the figures show that the Macedonian rural woman faces various challenges in terms of gender equality in many areas such as: daily activities and households, receiving of incomes (in most cases the rural women occurs as unpaid workers), access to education, participation in decision making at the households level and employment representation in the decision making at local and national levels. Women and men of varying ethnic groupings have varying levels of socio-economic status, political participation, and access to resources, all of which affect their ability to cope with and respond to sustainable development challenges. Various studies determine that women's role in families and communities, as well as their local knowledge in rural areas of environment, soils, water and production, are valuable resources for reduction and adaptation sustainable strategies—making them effective actors and agents of change. According to these finding, the gender equality is a prerequisite for sustainable rural development of the Republic of Macedonia, contributing to reducing of migration, unemployment and poverty. Sustainable development as a key principle for rural policy is a big challenge for all involved and concerned actors in the country. If women are more involved in decision-making, and if they had the required and needed access as men to productive and financial resources, income, education and services, agricultural yields would increase and the number of poor and hungry people would fall (FAO, 2015). Traditional agricultural support policies are increasingly ineffective in accomplishing rural sustainable development objectives. For this purpose, a comprehensive analysis is required to deal with the inter-linkages between the agro-food sector and the economic, societal and environmental systems of rural areas, and the national and international political and economic context with accent on gender sensitive procedures and mechanisms:

- Equal opportunities in employment and equal wages for rural men and women commensurate with the nature of work must be ensured.
- Community and institutional system for increasing of knowledge for natural resource management, climate changes, biodiversity and energy efficiency by ensuring of women participation should be set up.
- Women should be given rights over village common property land to access the resources for their livelihood, and benefit-sharing mechanisms should be developed for wider participation.
- Common property resources must meet daily household needs for fuel and fodder and provide livelihood options for women. Social fencing creates hardships for vulnerable groups. To circumvent the long gestation period for realizing the benefits, a buffer zone approach should be used to develop common property land.

In general, greater female participation in economic development poses an asset to a community's and country's ability to recover and sustain growth in times of change and stress. (Aguirre et al, 2012).

### **References**

- Aguirre D., Dustin J.M. (2012). Genetic diversity increases population productivity in a sessile marine invertebrate. *Ecological society of America*, Vol. 93, Issue 5; pp. 1134-1142.
- Enarson, E. and L. Meyreles (2004) 'International Perspectives on Gender and Disaster: Differences and Possibilities', *The International Journal of Sociology and Social Policy* 24(10):49–93.
- Eurostat (2017) [http://ec.europa.eu/eurostat/statistics-explained/index.php/Rural\\_development\\_statistics\\_by\\_urban-rural\\_typology](http://ec.europa.eu/eurostat/statistics-explained/index.php/Rural_development_statistics_by_urban-rural_typology) (accessed on 10/06/2017)
- FAO (Food and agriculture organisation of the United Nations) (2015). FAO and the 17 sustainable development goals. FAO, Rome, Italy.
- Hediger W., Theler A., Lehmann B. (1998). Congress of the European Regional Science Association: Sustainable development of rural areas – methodological issues. 28 August – 1 September 1998, Vienna.
- Lope-Alzina D. G. (2007). Gendered production spaces and crop varietal selection: Case study in Yucatán, Mexico. *Singapore Journal of Tropical Geography*, Vol. 28, Issue 1; pp. 21-38.
- Ministry of Agriculture, Forestry and Water economy (MAFWE) (2015). IPARD (Instrument for Pre-Accession for Rural development programme), 2014-2020. MAFWE, Skopje, Macedonia;
- Risteska M., Lazarevski G., Raleva A. (2012). Perspectives of women in rural areas. CRPM (Center for research and policy making), Skopje.
- SSO (State Statistical Office) (2016). Sustainable development, 2016. SSO of Republic of Macedonia, Skopje.
- SSO (State Statistical Office) (2017). Labour force survey, 2016. SSO of Republic of Macedonia, Skopje.
- SSO (State Statistical Office) (2016). Women and men in Macedonia, 2016. SSO of Republic of Macedonia, Skopje.
- UNDP (United Nations Development Programme) (2013) Ensuring gender equity in climate change financing. New York.
- World Bank Group (2010). Gender and natural resources management. World Bank group, Washington DC.

## **KALAKALAN SA ANA KALANG: MARKETING STRUGGLES OF FARMERS AND TRADERS IN BRGY. BUKAL, NAGCARLAN, LAGUNA, PHILIPPINES**

Justin Paolo D. INTERNO<sup>1\*</sup>, Sherry B. MARASIGAN<sup>1</sup>, Kim Lynet E. BERMUDEZ<sup>2</sup>, Kevin Throy S. WAGWAG<sup>2</sup>

<sup>1</sup>Agricultural Systems Institute, College of Agriculture and Food Science, University of the Philippines Los Banos

<sup>2</sup>Department of Social Sciences, College of Arts and Sciences, University of the Philippines Los Banos

\*Corresponding Author: jdinterno1@up.edu.ph

### **Abstract**

Social struggles of agricultural marketing in the Philippines' rural communities remained understudied despite its viewable effect to the patterns of local rural development and agricultural systems. Given the complex and disorganized nature of the country's agricultural marketing, the smallest stakeholders playing in the grassroots—farmers and small village traders—were usually overlooked with regards to the problems they face, especially on pre-production, production, post-production and postharvest, transportation, and sales stages. Interviews among selected farmers and traders in the community of *Barangay Bukal, Nagcarlan, Laguna, Philippines* and key informants were conducted to elicit a narrative representative of the community's social panorama. Collectively, results show that issues on variable climatic conditions, overproduction, flexible market prices and price margins dictated by the middlemen and big traders, and land tenure surfaced as Bukal farmers' and traders' major struggles against economic good. Although the Local Government provided ample technical-political-cultural support to address these issues, the root cause of this struggle was not responded thoroughly due to the degree of willingness of farmers to reorganize their paths towards a more successful agricultural marketing activity.

**Keywords:** *Agricultural marketing, middlemen, Philippines, social struggles*

### **Introduction**

Agricultural marketing is a “process which starts with a decision to produce a saleable farm commodity, and it involves all the aspects of market structure or system, both functional and institutional, based on technical and economic considerations, and includes pre- and post-harvest operations, assembling, grading, storage, transportation and distribution” (National Commission on Agriculture XII Report, 1976 as cited by Kiruthiga, Karthi, and Asha Daisy, 2015). As an agricultural activity, it is one of the aspects that plays an important and crucial role in rural development, as it is the “heart” of the economic growth process for developing countries who rely on farm production (FAO, Undated). Although, some parts of the Asian region suffer from social barriers from the following economic aspects of the agricultural system: entry to the market, massive asset polarization, debt relationships between large and small traders and farmers, diverse institutional and contractual arrangements, and collusive behavior, enforced in part by manipulation of the state regulatory system (Jones, 1996 as cited by Kindness and Gordon, 2001). Some of the most common problems in agricultural marketing existing in developing countries are related to product quality, market information, product quantity, functionaries' participation, lack of transportation facility, and inadequate storage facility (Kiruthiga, Karthi, and Asha Daisy, 2015). Intal and Ranit (2001) also stated price margins, monopoly power in agricultural distribution, and technology as other common

issues in agricultural marketing. Delving to one of its problems, the ‘middlemen’ tend to take advantage poor consumers and small-scale farmers through monopolizing pricing systems in the market, as well as illegally lending money with expected high interest. High competition was also existing in wholesaling by mills to retailers as well as retailing to consumers (Ruttan, 1969; Mears, 1974, 1981, as cited by Hayami, Kikuchi, and Marciano, 1999). In postharvest, some barriers such as relatively minute exposure and access of farmers to postharvest facilities, cold storage, farm-to-market roads, trading posts and the likes, and lapses on extension services on crop production are experienced by farmers (Andales, 2000 as cited by Castro, Undated).

*Report and Recommendations of the Congressional Commission on Agricultural Modernization* of the Congress of the Philippines in 1997 (as cited by Intal and Ranit, 2001) exposed that as a system, Philippine marketing is complicated and disorganized. Supply chain of agricultural products from the producers to consumers are operational but constantly experiences constraints at various levels. Most consumers lack direct contact to producers, as contributed by intermediaries such as the middlemen. Problematic marketing constraints--inequitable trading margin, marketing infrastructure, taxes and the likes are associated as major factors affecting imbalances on costs of marketing. As a developing country, the Philippines is more likely to experience various issues and constraints meddling with its agricultural marketing processes, starting from the local level. One of the most interesting location to study regarding this matter is Brgy. Bukal, Nagcarlan, Laguna. At present, some Brgy. Bukal farmers who are also known as the ‘*mang-aangkat*’ are those individuals who transport their produce in bulk on a regular basis, linking themselves to traders who could manage and market these goods further. Bukal farmers are known to travel to sell their produce as far as the markets of San Pablo, Laguna, Tanauan, Batangas, and Antipolo, Rizal. At least for the past decade, research about the area’s agricultural system focus mostly on agricultural production, agricultural extension and technology adoption schemes, and even developmental programs and policies that the local government are implementing, but lack emphasis on the social-ecological aspect. As the whole process of farming--from pre-production and post-production and its challenges, constraints from production, harvest to post-harvest have to be taken into account with emphasis on its social implications.

### **Materials and Methods**

Respondents of the study include five (5) smallholder local farmers and farmer-traders of different agronomic and horticultural crops who also transport their produce independently or through a community trader to areas such as Tanauan, Batangas, San Pablo, Laguna, and Antipolo, Rizal. Farmers and traders that were interviewed are determined through purposive sampling. Nagcarlan Municipal Agriculturist, Barangay Chairman of Brgy. Bukal, Nagcarlan and Barangay Councilor for Agriculture were interviewed as Key Informants. Farmers’ and traders’ situation and specific marketing challenges when it comes to pre-production, production, post-production and post-harvest, transportation, sales, and contingency plans for unmarketed goods with respect to social, economic, technological, biophysical and policy-institutional factors were determined. The role of the Local Government Unit, the *barangay* and the Municipal Agriculturist Office (MAO) in addressing related issues will also be gathered. Farmers’ and key informants’ perceptions about the involvement of middlemen in the marketing process are included. Pre-formulated guide questions were utilized to elicit information and thematic analysis has been employed to synthesize perceptions and opinions.

## Results and Discussion

Farmers and village traders has established a strong link when it comes to securing produce for trading. While smallholder and medium-to-large local farmers manufacture various cash crops in certain timeframes, village traders centralize farmers' harvest. At some cases, farmers also assume the role of traders, especially when they are logistically and financially capable. In an environmental perspective, Barangay Bukal is able to produce crops all year round. Farmers have areas where chayote, tomato, cabbage, cucumber, beans, and the likes are germinated: Mabuna and Silangan, among others. Tramlines are considered as a postharvest infrastructure as it helps hasten transport of produce from upland areas. This structure, which has been granted by the Philippines Department of Agriculture, has been functional and accessible at least for the past three years.

Minot and Hill (2007) pointed out that one of the policy options to establish connection among markets and farmers is the establishment of farm-to-market roads as it optimizes cost and lessen the duration of transporting the harvest to markets. In Barangay Bukal, this infrastructure allows them to transport at an easier rate. The most accessible farm-to-market road is the *Banago-San Francisco-Abo-Bukal* farm-to-market road which meets the Nagcarlan-Rizal road. Postharvest techniques farmers are using include simple processes for cooling, cleaning, drying, sorting and packing. Farmers situate their harvest accordingly in empty rice sacks, pack them, and take them to their homes or under their roofed garage through manual means (back carry) or through a horse--depending on the distance and volume of yield. Village traders collate species of produce by conducting farmer's house-to-house collections either on a daily basis (if the crop of interest is at its peak season), or when a farmer could provide some amounts of produce; or by allowing these farmers to go and transport their harvest directly to these village traders' areas. Then, sacks are dismantled by batch and cleaned through water washing. After washing, crops are transferred to a flattened plastic sheet (e.g. tarpaulin) for drying and let it stood until it's ready for packaging. When dried, crops are then packaged in polyethylene sheets according to class. Some farmers still consider putting the packs into another layer of sack for harvest' double protection. Farmers and village traders tend to skip the postharvest cooling process since the *barangay* is an upland area where temperature is relatively low.

Quality of harvest is directly proportional to its marketability. Interviews among farmers have validated that in fact, fruits and vegetables are designated with classes where the relatively most marketable falls under 'Class A' or *primera*, and those that are minutely damaged or relatively not aesthetically appealing would be downgraded to 'Class B' or *segunda*. Rejects or the worst-looking but could still be sold in very cheap prices falls under 'Class C' or *tercera*. Although farmers claimed that they make sure that all they have harvested have been pre-selected accordingly by its external appearance, they cannot avoid instances where some produce get scarred and damaged while transporting them from farms to trading areas. Instead of securing 100% assurance of the quality of Class A harvests, some were rejected and were resold the other day under the lower classes. According to some accounts, there were times when the agent or middleman returns some bulk of produce because those were not accepted by the standards set by stockists, wholesalers and retailers.

Supply chain begins with local farmers who produce fruits or vegetables. After harvest, all applicable postharvest techniques will be undergone and later be linked to prospect buyers. Following the chain, there will have two possible passages where the produce could be taken to, depending on the capabilities of the farmer: First, if the farmer also plays the role of the trader, he or she could go straight to his or her '*suki*' or buyer/ middleman/ agent where they could agree on the prices of goods right away and complete a transaction. Second, if the farmer lacks ways and means to transport the goods immediately--due to financial, logistical

and other relevant concerns, he/she could coordinate with a local trader who may have or have not predetermined the prices before coming to the market. Local traders will later negotiate with those agents. The difference with the two options at this point is that the farmer-middlemen would offer market-updated prices for goods. Meanwhile, the former could just charge the farmer with an amount that could be lower or higher than the current price being followed, and so, could possibly mean a relatively lower revenue on the farmer's end, or lack of net income on the side of the village trader. From the middlemen, the goods could proceed to variable recipients like stockists (supermarkets who sell wet goods, etc.), wholesalers (wet and dry market dealers, etc.), factories needing raw materials and the likes. Unfortunately, further positions the supply chain were not traced beyond this point.

Farmers and farmer-traders subscribe to the 'suki' system where they have pre-established connections among agents and middlemen, and consider some as their regular buyers. A day or a night before transporting the goods to the trading post, village traders are contacted by these agents and cast bulks of orders. Most of the time, the amount of produce traders carry was reserved and considered sold. Otherwise, they stay in the market for some couple of hours (or the whole morning) and make some price adjustments. Worst case, farmers will have to lower the price of their produce, either on or below breakeven just to convince prospect buyers to purchase theirs. It is better for them to have it sold than not at all. In effect, these farmers would suffer from the consequences of a low income. In some cases where goods are not sold, traders decide to re-sell them the next day depending on the price that is applicable (as price margins are very flexible), or depending on its freshness, marketability and aesthetic value.

Those crops that were not qualified from pre-selection or were unaccepted by buyers and intermediaries after reselling are either dumped back to the farms and spoiled (as organic fertilizers), or used as alternative feeds to their swine, cattle or horse, integrated with their roughage formulations (grasses) and leaf meals (*Gliricidia sepium*). Also, there are cases when unsold goods are given for free among barangay residents and neighboring communities upon request. Unsold goods rarely happen, but given the situation, they really have no productive or money-generating backup plans aside from re-selling it over and over.

Farmers and traders consider a healthy competition among their ranks since according to them, they are not negatively affected by their co-existence. In fact, a culture of helping each other in selling the goods apply. While farmers and traders have secured their own 'suki', in the macro scale, competition and its effects are interrelated. For example, in the market situation in Baguio and Divisoria, the prices introduced or agreed on by agents coming, and dealing from and within these areas would possibly be used as standard throughout the national market. Whenever sellers from these areas assign a certain price for a certain good with the intermediaries, the rest will have to follow in order for their produce to be sold.

Commodities, especially crops grown in the Philippines have variability when it comes to demand. Seasonally, there are specific cash crops that increase in demand because of various considerations and events (holidays, etc.). Farmers attempted to take advantage of these events and produce these goods in their own areas. Having this familiar mindset among themselves, the tendency is for them to produce in large amounts without considering that other farmers think likewise. In the locality, significant amount of produce turns into surplus, and surplus implies socio-economic problems related to overproduction, as well as farmers and village traders' revenues. In order to deal with this lapse, farmers and village traders' had to set lower prices for their crops and end up earning minute amounts.

Prices set per kilogram on each crop is very flexible and according to farmers, there is an external body that manipulates pricing on each. Before entering the market, they are really unsure of how much their goods cost. They cannot do anything about standardizing the ever-changing crop prices on the micro level, yet. The only resolution they could work on is

innovating and integrating more ways where they could earn. For example, some farmers venture to cropping with different types of crops in a given season. At times where a demand for a certain crop increases, and there's a verge of oversupply and lowering of prices, at least they set some backup plan where losses and lapses in income would somehow be lessened. Also, they have been provided with options to develop products by which they could sell at a relatively higher price although, it is more costly than that of a raw produce. Say, banana chips, cassava chips, or the likes. These farmers, through agricultural extension, were also exposed to facilities like the tomato paste maker so they could somehow improvise and/or become skilled on this procedure, especially when the facility is made available in the barangay in the future. When all these means are already exhausted but the goal to earn deservingly is still out of reach, their last resort is to pray for a bountiful harvest and high pricing on the crops they produce the next time they engage in such agricultural marketing activities.

Middlemen, as a part of the supply chain, possess positive and negative characteristics in the perception of farmers and village traders. Without them, selling goods would be difficult for farmers. These intermediaries, for one, are those who buys in bulk because they have a larger market to respond to (wholesalers, retailers). These people coordinate to the farmers and smaller village traders and cast orders a day before. But then, in a different perspective, even though they appear to be 'sure buyers', they tend to manipulate selling prices and farmers are somehow restricted to cover for their computed expenses.

Among the interviews, most of them are fully aware of this discrepancy. Although, as a social phenomenon, some see it as a normal occurrence and just take into account the positive effects of having middlemen while considering less about its repercussions. In contrast, some see it as a type of oppression the government and the community should deal with accordingly. As of now, middlemen are tagged as a major intervention that elaborates the supply chain in Brgy. Bukal, and so, even though the local government and the people of the municipality continue to innovate and resort to more efficient means to improve their incomes, circumstances still make farmers resort to tolerance.

Frequent destructive rainfalls/typhoons during the rainy season and cases of *El Nino* mixed with precipitation when dry season is assumed as another concern Bukal farmers are facing. An old farmer respondent regards this phenomenon as a major threat to his farming activities, especially on the marketing of goods. Climatic constraints could hinder his productivity, because for one, instead of going out to the field and perform necessary agricultural activities, the farmer stays at home to secure his safety instead. Second, it could distract the growth and development of crops undergoing maturity. Such phenomena also decrease how much a farmer normally harvests, and eventually affects the expected income negatively. Although there were large scale and grassroots strategies to combat climatic constraints such as climate change adaptation and even the planting of *Gliricidia* trees throughout the barangay implemented, some farmers still lack involvement to help, and enough consciousness to appreciate these initiatives.

With all the advisory services, seminars, trainings, information drive, field trips, referral to marketing outlets and other forms of promoting local produce from the Local Government through the MAO, as well the barangay council that have delivered to the local farmers, some concerns are left unaddressed. The MAO may have claimed that they have done all the possible ways to heighten farmers' interest in various marketing approaches or to develop various products from the locality, but stakeholders at the grassroots could not easily respond to these options without being completely confident on their financial, social and cultural capital. They might have been exposed to solutions but they lack expertise and long-term guidance. At some point, farmers' common social mindset also remained unpolished or insufficient and they just settle to keeping up with these conditions. More so, farmers,



thinking about loads of everyday struggles, could not see the relevance of those policy-institutional interventions because it does not directly solve what they think should be prioritized.

### **Conclusion**

Production-wise, concerns farmers face are linked to climatic conditions where the dry season gets too dried with some hints of destructive rains on some days, and rainy season brings totally devastating super typhoons, among others. Some have observed such changes and unconsciously, they are starting to adapt strategies to combat these changes. But then, more farmers are not fully informative about it. It is high time to let the farmers know how this biophysical occurrence is actually threatening to their marketing activities in the long run so they could be advised accordingly and respond in a good light.

Overproduction in Bukal is a decade-age issue but accounts reveal that their mindset about responding to the demand hype at a certain point in time is very detrimental. For further research, combating overproduction and establishing a more efficient marketing strategy makes a very interesting angle to be understood and be shared more.

Problems on varying market prices and the involvement of middlemen has been the most highlighted issue farmers and traders have imparted. With all the unpredictability in the prices of vegetables in the market, small traders-big traders competition, subtle oppression by the middlemen in terms of harassment, too much lowering of price equivalence per kilogram of goods, late payments, returns and exchanges, and the likes, it is not a good move to stay silent about this discrepancy. Although the local government is proactive about delivering agricultural marketing services to farmers through extension and advisory services, exposure to innovations, training, outsourcing, and promotions, solving this middlemen fiasco as a root cause of inequality could somehow provide a different degree of freedom among farming societies. Government officials and concerned government units should act upon this irregularity because up to the present, farmers cannot get the best out of their hard work, and it is really unfair for their well-being.

Contributing and limiting factors influencing the marketing activities of Brgy. Bukal farmers and traders, is somehow similar with the issues and concerns they have encountered all throughout the process. With all the concerns surfaced, the nature of these factors is more of socio-economic, socio-political and biophysical. Understanding the social implications of the marketing system in the country should be given the limelight to improve the current knowledge base available locally. In order to track the similarities and patterns occurring among farmers and local traders' experiences in the market, such type of research must be expanded to neighboring municipalities of the area.

### **References**

- Castro, S.G. (Undated). Postharvest Technology in the Philippines. Agricultural Mechanization Development Program, University of the Philippines Los Banos. Retrieved from: <http://unapcaem.org/Activities%20Files/A20/10%20Philippines.pdf>
- FAO, (Undated). Agricultural and Food Marketing. FAO Document Repository. Retrieved from: <http://www.fao.org/docrep/004/w3240e/W3240E01.htm>
- Hayami, Y., Kikuchi, M., & Marciano, E.B. (1999). Middlemen and peasants in rice marketing in the Philippines. *Agricultural Economics* 20 (1999) 79-93. Retrieved from: <http://ageconsearch.umn.edu/bitstream/174795/2/agec1999v020i002a001.pdf>
- Intal, Jr., P. S., & Ranit, L. O., (2001). Literature Review of the Agricultural Distribution Services Sector: Performance, Efficiency, and Research Issues. Philippine Institute for

- Development Studies, Discussion Paper Series No. 2001-14. Retrieved from <http://dirp4.pids.gov.ph/ris/dps/pidsdps1314.pdf>
- Kindness, H., & Gordon, A. (2001). Agricultural Marketing in Developing Countries: The Role of NGOs and CBOs. Policy Series 13, Natural Resources Institute, University of Greenwich. Retrieved from: <http://www.nri.org/projects/publications/policyseries/PolicySeriesNo13.pdf>
- Kiruthiga, K., Karthi, R., & Asha Daisy, B. (2015). Agricultural Marketing--An Overview. International Journal of Scientific and Research Publications, Volume 5, Issue 4, April 2015 1 ISSN 2250-3153. Retrieved from: <http://www.ijsrp.org/research-paper-0415/ijsrp-p40135.pdf>
- Minot, N., & Hill, R. V. (2007). Developing and Connecting Markets for Poor Farmers. 2020 Focus Brief on the World's Poor and Hungry People. Washington, DC: IFPRI. Retrieved from: <http://dev.mtnforum.org/sites/default/files/publication/files/4324.pdf>

## **SOCIO-CULTURAL ROLE OF GREEN AREAS IN THE RURAL DEVELOPMENT**

Agnieszka JASZCZAK

Department of Landscape Architecture, University of Warmia and Mazury in Olsztyn, Poland

\*Corresponding author: agaj77@tlen.pl

### **Abstract**

Contemporary village space is "multi-layered" and it consists of the forms, functions and historical structures and new elements, which are important in the creation of its future image. The research focuses on the analysis of the Polish countryside (Warmia and Mazury Region) in terms of the use of green areas in social and cultural development. During the study, the directions of villages development under the Rural Renewal Program in the context of improving the quality of inhabitants life and alternative forms of development were analyzed. The research was based on the goals of the village network and the results of existing spatial and social development initiatives. The examples of actions connected with protection and the landscape shaping as well as designing of green areas are also indicated. It is hypothesized that rural areas may compete for large urban structures as spaces for peace and health (so-called green therapy) in the future. The research, analysis and design tasks started in 2013 and they are still continuing. So far 6 from 80 villages participating in the rural renewal program since 2012 have acceded to the full research project and participated in planning process (Stare Siedlisko, Nowe Monastarzysko, Żytkiejmy, Wójtowo, Ruszajny, Kronowo). While additional studies, including a fragment of the village were taken in more than 20 villages.

**Keywords:** *rural renewal program, green areas, village space, design*

### **Introduction**

Uneven social and economic development in rural areas, cities and suburban zones that require considerable investment is a problem that affects Poland as well as many other European countries. Various efforts have been initiated to address this issue and develop strategies for the harmonious development of regions in observance of their national and cultural identity, including the international project entitled "Hinterland potentials for a spatial development under the aspects of decline" (Jaszczak, 2009) while the answer to problems of space transformation, economic development or identification of the rural community are activities concentrated on the Rural Renewal Program in Europe. According to Damyanovic and Reinwald (2014) changes in social structures and demographic problems are challenges for local governments and thus are seen as a central task for the future development of the municipalities and village renewal programme. Intensification of social capital through networking and participation of citizens in local development are important for the proper development of rural areas (Husak, 2012, Falk and Kilpatrick, 2000).

The reconstruction, restoration, revitalization and creation of community-friendly spaces are important goals of the movement's social and spatial development strategies. Programs and projects are initiated by the local authorities, institutions and associations as well as members of the local communities who actively participate in the process of shaping the village's image to acquire a sense of belonging and shared responsibility for their surroundings. The anticipated results can be achieved only through a community-driven approach (Jaszczak

2015). Villages and surrounding rural areas offer an alternative path of development and can set an example for other towns and areas on the regional and national scale. This paper discusses the goals of the Rural Renewal Program and the outcomes of social and spatial development projects initiated by the network. Examples of regional projects aiming to improve the local quality of life, protect and shape the local landscape are presented. This paper explores the hypothesis that green spaces play a significant role in the inhabitants' integration and are a cultural value which builds a "village image". They also help to preserve the traditional character of a village and affect the health of residents and tourists using agritourism offers.

### **Material and Methods**

The research and the choice of the area stem from actions implemented under the project "Renewal of Village" in the Warmia and Mazury region. It was a tree-step procedure to pursue aims. In the first step, it was important to assess the rural renewal program using a compound of different sources including contemporary resources, national and regional documents. Information on rural renewal have been captured in a wide range of sources containing archives, primary and secondary literature. In the second step, distinctive rural areas of both social and cultural importance (including green areas) were identified by means of an analytical survey conducted to understand individual preferences of the area. A number of direct interviews primarily with the staff of the Marshal's Office in Olsztyn (Poland), local leaders, as well as persons responsible for the implementation of the village renewal program in Warmian-Masurian Voivodship were conducted. The meetings with inhabitants were particularly important. They helped to determine preferences for planning of common areas and those ones with cultural importance in the countryside. Additionally, the author has completed a number of training courses in the field of landscape analysis and planning of green areas for particular groups of recipients. In the third stage, analytical and inventory work was started, which resulted in the project's completion. Students of the University of Warmia and Mazury in Olsztyn were invited to this stage. It was also very important that inhabitants were attended at every stage of design works. After identifying the places requiring revitalization or new planning in the villages, the design process was started. The research, analysis and design tasks started in 2013 and they are still continuing. So far 6 out of 80 villages participating in the rural renewal program since 2012 have acceded to the full research project and participated in the planning process (Stare Siedlisko, Nowe Monastarzysko, Żytkiejmy, Wójtowo, Ruzajny, Kronowo). On top of that, additional studies focusing on fragments of villages were taken in more than 20 villages.

### **Results and Discussion**

*The main goals of the renewal program in the region of Warmia i Mazury (Poland)*

Village renewal is a direction of development of rural areas, combining respect for tradition with the need to search for an appropriate place for the village in a changing world. It is a process and constant adaptation to social and economic, internal and external changes, which leads to the overall shaping of the living conditions of the rural population. The concept of village renewal comes from German *Dorferneuerung* because the village renewal movement began in Germany in the sixties of the last century. Then Austria, Luxembourg, Hungary, Romania, Slovenia, the Czech Republic, Slovakia and Poland joined the movement. In Poland, the program of the village renewal occurred in 1997, as a formal movement, covering the region of south-western Poland. The first region that started it was Opole province. Historical background of this movement was the work of many social activists, scientists and entrepreneurs who contribute to improving the lives of rural residents and to preserving their

identity (Idziak and Wilczynski, 2013). Implementation of the Programme of Warmia and Mazury was started in 2011 by the development of the General Basic Principles. The main objective of the initiative is to increase the activity and the integration of rural communities and the involvement of citizens in their efforts to [create/govern] village councils, as well as to improve the living conditions of the rural population. This is a valuable support for the residents' activity and practical implementation of the village renewal plans. Additionally, within the framework of the competition "Active village of Warmia, Mazury and Powiśle", Warmia and Mazury voivodships allocate funds from their budgets for the implementation of small investments. Small projects include the construction of playgrounds, bridges, development of beaches or cents, construction of arbors and outdoor gyms. It is important to ensure the proper management of green areas in the countryside. Therefore, the Marshal Office has partnered with the Department of Landscape Architecture since 2013. The cooperation encompasses the planning of green areas in the countryside. Additionally, the author conducted the training workshops for rural inhabitants concerning: landscape planning, selection of plants, creation of aesthetics places during the yearly conference "Rural Renewal" which took place in Galiny 2013, Ryn 2015, Mrągowo 2016. She also provides the expert assistance with respect to the planning of green areas in the countryside.

*Socio-cultural role of green areas in villages*

In the era of intensification of urbanization and industrialization processes as well as demographic problems, it is the man who needs a "green space" for rest, relaxation or healing (Nilsson et al. 2011). Interdisciplinary research confirms the special role of greenery in therapy (Kaplan 2001, Mitchell and Popham 2008, Björk et al. 2008, Shukor et al. 2012) and social integration. Green therapy is increasingly included in the development programs of regions with high natural and cultural potential and widely used in health resorts and tourist resorts in rural areas. Green therapy is also utilized by small towns and villages where green tourism is developing, wherein the green areas are used not only by tourists, but also by the locals. The development of public places in the countryside affects social integration. It should be added that green areas are often part of the cultural landscape (historical green areas - historical parks, gardens, greenery near sacred objects, gardens in rural farms, roadside alleys). For this reason, green space plays an equal role with architecture in preserving the cultural potential of the countryside. In recent years a positive reverse trend has been noticed with regard to the design of green areas in country style. This is reflected in the return to nature, the use of traditional forms, rural plants and materials. In the program of village renewal, the greatest importance is attached to giving new image, aesthetisation of space and identification of villages. There are several examples of the creation of a "village image" through the green conception (tab.1.).

Table 1. Program of creation the common areas (including greenery) in selected villages

Proposal	Examples	Main goals
Aesthetisation of the village	Conscious planning of green areas with expert cooperation	Improving the quality of rural space Improving the aesthetics of common places to residents Improving the cleanliness and order of areas
Spatial identification	Compositional and material linkage of green areas	Conferring a common system of green planning Defining one style and template Homogenous composition for places with different functions

		Introduction of the marking system
Thematic identification	Identifying the leading theme of village (especially in thematic villages)	Use of forms and materials related to the village's topic
Planning of the village entries	Arrangement of the entrance zones (so called "gates to the village" and "introduction zones")	Selection of forms and inscriptions on boards which are similar to the identification system and the theme of a village Use of ornamental plants to highlight the entry zones
Village center planning	Preparation of common places for residents being "the showcase of a village"	Planning of places such as central village squares, markets, squares, creating spaces

\*Source: Author's elaboration

The author is the initiator of the program "Creation of the new image of a village" in which students with inhabitants work on the design of the green areas, gardens and a small architecture in selected villages. They also provide ideas for the village marking system (welcome boards, thematic signs, information boards, details). So far, a number of projects of squares, lawns, beaches, greenery near educational, sport and social objects, greenery near sacred sites in selected villages were submitted. Among the most commonly designed green areas in villages are:

- Parks, squares, green areas (including historical monuments)
- Greenery near recreational and tourist facilities
- Greenery near educational facilities
- Greenery at sacred sites
- Green roadside, squares, roundabouts, green at the crossroads
- Greenery at sports facilities
- Farm greenery, home gardens (tab.2)

Table 2. Examples of the designed green areas in selected villages

Village	Year	Examples of the designed areas	Project stage
Nowe Monasterzysko	2015	Project of an area near a community room Restoration of cemetery Project of parking for bicycles on the bike path Project of sport facilities Projects of individual gardens Project of visual identification	ready for realization  Work in progress Ready for realization Ready for realization Work in Progress Work in Progress
Stare Siedlisko	2015	Project of a BBQ area Project of a village's square near a church Project of an area for village festivals and events Projects of individual gardens Project of visual identification	Completed  Ready for realization  Ready for realization Partly completed Completed for realization
Żytkiejmy	2015	Project of an educational garden near the Department of Landscape	Partly completed

		Park "Romnicka Forest" Project of an area for village festivals and events Projects of individual gardens Project of visual identification Project of a central square	Partly completed Partly completed Ready for realization Ready for realization
Wójtowo	2016	Project of greenery near children playground Project of sport facilities Project of an area near water ponds Project of a sacral area near a church Projects of individual gardens Project of visual identification	Ready for realization  Ready for realization Ready for realization Ready for realization Partly completed Completed
Ruszajny	2017	Project of an area near a community room Project of a sacral area near a small chapel Project of a recreational area and technical equipment Project of an area near water ponds Projects of individual gardens Project of visual identification	Ready for realization  Ready for realization  In the project phase Ready for realization In the project phase Ready for realization
Kronowo	2017	Project of a recreational area with playground Project of an area near a community room (recreational path) Project of an area in the village centre (natural path) Projects of individual gardens Project of visual identification	Ready for realization  Ready for realization  In the project phase  In the project phase Ready for realization

\*Source: Author's elaboration

The given examples of projects of green areas have individual character. In the initial phase it was particularly important to identify the potential of the countryside, including architecture, architectural details and unique elements in the countryside. On this background, the characteristic features were defined. They were the basis for the creation of projects in the next stage. It had a great significance in the projects of visual identification of the village. Some of the projects are fully implemented, others are partially implemented or prepared for implementation (tab.2). Some of the projects from 2017 are in the deployment phase (in the project phase). However, in most cases the projects; execution ratio depends on the possibility of funding from the Rural Renewal program (so called small projects), regional competitions and regional, national and EU funds for rural areas. As previously noted, local leaders and villagers played a very important role in the green space planning . It should be underlined that only collaboration between the scientific center (in this case the University of Warmia and Mazury in Olsztyn), regional government (Marshal's Office in Olsztyn) and rural administrative unit can bring tangible results.

## **Conclusions**

Rural renewal is a joint action aimed at improving of the quality of residents' lives, including all what the countryside is extremely valued for: landscape, architecture, historical and important places, sacred objects, technical objects. This is a trend of rural development assuming that the identity of the village and the values associated with rural life have a special role to play.

The Village Renewal Program also takes into account the development of cultural ecosystem services, which include recreational functions for both residents and tourists travelling in the region. It was arranged for them the space of the village, including the elements of sport, recreation and leisure. Therapeutic role of greenery increasing now; therefore, vegetation with special health significance has been included in the projects, as well as "sensory paths" were arranged. It is also important to use the planned spaces for educational purposes. Referring to the cultural ecosystem services it is important to remember about the natural and cultural heritage. Within the framework of co-operation with Marshal Office and local population there were prepared projects of development of sacred green areas with special attention to the symbolism of greenery. The village renewal is also a project resulting from the inhabitants' needs of the for, the development of common places, renovation and restoration of historical objects, historical, rural space, playgrounds, outdoor gyms, etc. In the Warmia and Mazury region Marshal Office plays a special role in the implementation of these tasks. It initiated the implementation of the Rural Renewal Program with a range of socio-cultural initiatives and activities that have influence on the improvement of rural areas planning, including green areas.

The paper presents briefly the essence of the Rural Renewal program in Poland and its objectives in the area of rural space management. The basic principles for the creation of common spaces in rural areas and the possibilities of their planning based on social participation were also defined. Presented examples of greenery projects in selected villages of the Warmia and Mazury region were developed together with inhabitants, with particular attention to their remarks. Ultimately, some of the projects have been completed so far, others are expected to be realized. Hopefully their implementation will be possible from the funds raised under rural support programs.

## **References**

- Björk J., Albin M., Grahn P., Jacobsson H., Ardö J., Wadbro J. (2008). Recreational values of the natural environment in relation to neighborhood satisfaction, physical activity, obesity and wellbeing. *Journal of Epidemiology & Community Health*, Vol. 62(4), p. 2.
- Damyanic D., Reinwald F. (2014). The "Comprehensive Village Renewal Programme in Burgerland" as a Means of Strengthening the Social Capital in Rural Areas. *European Countryside*, Vol. 1, pp. 18-35
- Falk, I., Kilpatrick, S. (2000). What is Social Capital? A Study of Interaction in a Rural Community. *Sociologia Ruralis*, Vol. 40 (1), pp.87-110
- Husák, J. (2012). Synergy of Social and Human Capital in rural development – Czech and German Cases. *European Countryside*, Vol. 4(4), pp. 240-250
- Idziak W., Wilczyński R. (2013). Village renewal. Space, People, Activities, Foundation for Aid Programs for Agriculture FAPA, p. 4.
- Jaszczak A. (2009). From „Hinterland" to "Innoland". That is how to develop the rural areas. *Dissertations of Cultural Landscape Commission, PTG, Sosnowiec*, Vol. 12, pp. 215-223.
- Jaszczak A. (2015). Future of cittaslow towns. *Landscape architecture*, Vol.1, pp 70-78



- Nilsson K., Sangster M., Gallis C., Hartig T., de Vires S., Seeland K., Schipperijn J. (2011). Forests, trees and human health. Springer, Dordrecht.
- Kaplan S. (2001). Meditation, restoration, and the management of mental fatigue. *Environment & Behavior*, Vol. 33, pp. 480–506.
- Mitchell R., Popham F. (2008). Effect of exposure to natural environment on health inequalities: an observational population study. *Lancet*, Vol. 372(9650), pp. 1655–1660.
- Shukor S.F.A., Stigsdotter U.K., Nilsson K. (2012). A Review of Design. Recommendations for Outdoor. Areas at Healthcare Facilities. *Journal of Therapeutic Horticulture*, Vol. XXII(2), pp. 32–47.
- Karwowska J., Sarnowski J., Górska-Kłodzińska K. (2016). Village Renewal Program of Warmia and Masuria Province "Village of Warmia, Masuria and Powiśle as a place worth to living", Education and Activation of Local Communities. Theoretical Issues And Practical and Appropriations. University of Warmia and Mazury in Olsztyn, Olsztyn, p.140

## **THE ROLE OF COOPERATIVE MOVEMENT IN DEVELOPMENT OF RURAL AREAS: A CASE STUDY OF POLAND**

Maria ZUBA-CISZEWSKA

Institute of Economics and Management, The John Paul II Catholic University of Lublin, Poland

\*Corresponding author: maria.zuba@kul.pl

### **Abstract**

The cooperative movement evolves in contemporary economies through care for interests of its members and as a result of professing practical ideas (economic solidarity, collective resourcefulness, mutual cooperation). Cooperatives mainly serve local communities, since they often are their closest partner. Agriculture is one of the sectors of the Polish economy with the largest number of cooperatives (2629 in 2015 or 15% of all in the country). Cooperatives still play an important, though decreasing role in agriculture. There are several types of well-functioning rural cooperatives that support the development of agriculture and rural areas. There are the so-called cooperatives "Farmers Mutual Aid" (over 1100) engaged in retail and wholesale trade, food production. Agricultural production cooperatives (700 cooperatives), which are focused on plant and animal production. Cooperatives of Farmer's Circles (517) mainly provide services to farms and other entities in the countryside. Dairy cooperatives (140) hold 60% in purchasing and processing milk in the country. The development of agriculture and rural areas also supports a specific type of cooperative, ie. cooperative banks (559 in 2016). They have a dense network of outlets (4633 or 38% of the banking sector with 33,000 employees or 20% in the banking sector). Tradition of credit cooperatives in Polish lands in the field of financing rural and agriculture is over 140 years. Cooperative banks include in their operating activities capital needs of agriculture, finance structural transformations in this sector. Agricultural cooperatives in Poland face developmental challenges. The opportunities for growth is the revival of trust among farmers for this form of cooperation.

**Keywords:** *Cooperatives, Cooperatives movement, Rural development, Poland*

### **Introduction**

A co-operative is an autonomous association of persons united voluntarily to meet their common economic, social, and cultural needs and aspirations through a jointly owned and democratically-controlled enterprise. Cooperative's values concern:

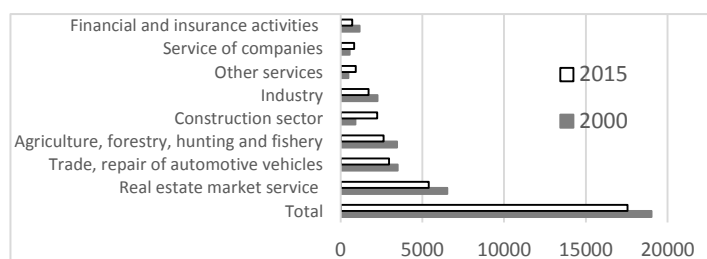
- ideological (democracy, equality, self-aid),
  - ethical (fairness, integrity, thoughtfulness, faith in cooperative ideas),
  - related to cooperative principles (voluntary participation, participation in management, autonomy, training and personal development for the good of a cooperative, and interaction).
- The cooperative movement holds an important position in the global economy, cooperatives employ worldwide 250 million people, generated \$ 2.2 trillion of revenues. There are over 2.6 million co-operatives in the world with about 1 billion members. Agricultural cooperatives are the largest group among all cooperatives in the world (26% in 2016) (ICA, 2017). The agriculture and food industries sector groups together all co-operatives that operate along the entire agricultural value chain, starting from the cultivation of agricultural products and livestock farming to the industrial processing of agricultural products and

animals. Agricultural cooperatives are one specific typology of farms. They are unique enterprises that combine economic and social goals, rather than the pursuit of profit alone. This being the case, they can contribute to reducing poverty, improving food security and nutrition, as well as to promoting the sustainable use of natural resources.

In the last 15 years the number of cooperative initiatives in Poland dropped by almost 8% to 17.5 thousand entities. Farming is one of the branches that still has relatively large number of cooperatives, with 2600 active in 2015, which is still ¼ less than in 2000.

Figure 1. Number of cooperatives in Poland

Source: CSO



There were 430 active cooperatives in food and beverage industry (529 in 2010), that is the subsequent link in food manufacturing chain. The increase of number of cooperatives is mainly observed in services. Even when the value of GDP created by the cooperative sector in Poland

increased by 22%, its total share in the economy fell down from 1.8 to 0.7%. The cooperative sector now employs 221 thousand people, half of the 2000 number. The aim of the work was to show the role of cooperatives in rural development on the example of Poland. The paper presents comparative analysis in time. The work uses statistical data published by Central Statistical Office (CSO), National Council of Cooperative (NCC) and literature on cooperives in Poland.

### Result and Discussion

There are several traditional types of cooperatives supporting the development of rural areas. First of them is the Self-help Farmers Cooperatives (Pol. “Samopomoc Chłopska”), which is closely bound with village and rural society. Up to the market transformation of 1989 this cooperatives were well developed and had large economic base (tab. 1). Their main task was to provide inhabitants of rural areas with food and industry products, production aids and provision of purchasing centers for farm products. They were also active as manufacturers, processors and service providers. They promoted advances in farming.

Tab. 1. Scopes of activity of the self-help farmers cooperatives in Poland

Earlier period	Currently
<ul style="list-style-type: none"> <li>- number of cooperatives rose from 1279 to 1912 between 1945 and 1988, number of members from 694 to 3532 (thousand) that is to 24% of the total rural population, employment figure was 468 thousand.</li> <li>- they were formed on the basis of farming cooperatives and small processing plants</li> <li>- their task was to provide rural population with food, industrial products, production means and purchase farm products</li> <li>- organize and leading manufacturing and processing activities (bakeries, butcher’s works, sparkling water factories, small processing plants for fruits and vegetables), services for rural population (transport, construction and repairs, gastronomic)</li> <li>- their tools were retail outlets (71452 in 1988), retail centers for farming supplies (9311), farming produce purchasing centers (36067) production and service facilities (4988) gastronomic facilities (5500), technical bases for transport (777), training bases (399), social and cultural establishments (5374)</li> </ul>	<ul style="list-style-type: none"> <li>- 1193 cooperatives and 150 thousand members in 2013</li> <li>- task is to provide the rural and small town population with basic food and industrial products and farming supplies</li> <li>- 10 thousand retail stores, 450 bases for sale of bulk farming supplies (e.g. coal, artificial fertilizer), 200 food and industry product wholesales, 100 gastronomic facilities, 600 production facilities (bakers, confectioneries, butcher’s shops, water and beverage production facilities, fodder mixing plants and other food processing facilities)</li> <li>- introduction of HAACP system and Good Manufacturing (GMP) and Hygienic (HMP) Practices</li> </ul>

Source: own work based on NCC; Brodziński, M., G., (2014). Aspects of rural cooperatives, FREL, Warszawa, p. 103-111, 178-192

After transformation to market economy system the central and regional cooperative associations were disbanded by an act of law, and support forms for cooperatives, their legal, economic counseling and training services, their cultural and social activities abolished. This caused a drop in the number of cooperatives, their members, employees, dissolution of social bonds between cooperatives and their members, employees and also contractors. Many cooperatives went bankrupt due to indebtedness incurred due to detrimental credit facilities and a tax system that was more severe than in the private sector. In the result of abolishment of the regional cooperative associations the basic cooperatives were left without logistic services and organization for purchase of farm product. They were unable to use their manufacturing potential and base, which made them loose the majority of their assets (through sale, rental or creditors entering the property). They were eliminated by private companies from the sector of purchase of farm products and slaughter animals. The scope of their remaining activity decreased significantly. Also the Farmer's Production Cooperatives (Pol. "Rolnicze Spółdzielnie Produkcyjne") did not cope with the consequences of economic reform (they were to be "3S" - self-governing, self-sustained, self-financing) (tab. 2). Even with the value of purchased farm products increased 3-fold in the last twenty years, their role in that process was diminished (from 26 to 17%). Their main activity is plant production (mainly grain crops) followed by animal farms and mixed production. The advantage farmers have in participating in cooperative is the increased scale of production, concentration and specialization and the contracting deals for farm produce with prices higher than in case of individual farmers. These entities also receive direct support from CAP funds for their production and activities conducted in detrimental farming conditions.

Tab. 2. Scopes of activity of the Farmer's Production Cooperatives in Poland

Earlier period	Currently
<ul style="list-style-type: none"> <li>- created after WW II as element of state farming policy that assumed that this leads the path for transformation of individual farms in collective farming companies</li> <li>- between 1950 and 1988 the number of cooperatives rose from 635 to 2207, number of members from 25.3 to 190.4 thousand, and the area of arable land from 190 to 701 thousand hectares</li> <li>- the aim of their activity was to lead common farm and activities for individual farms (aiding them in field works by lending modern equipment, organization of purchase of materials for cooperative food processing plants)</li> </ul>	<ul style="list-style-type: none"> <li>- 694 cooperatives with a total of 40 thousand members and 235 thousand hectares of arable land</li> <li>- some 8 thousand people find seasonal employment in those cooperatives – member's relatives, several thousand farmers cooperate with production cooperatives on regular basis</li> <li>- large production cooperatives also create their own retail networks</li> <li>- additional services for individual farmers, transport, construction and repair services, agritourism</li> </ul>

Source: own work based on NCC; Brodziński, M., G., (2014). Aspects of rural cooperatives, FREL, Warszawa, p. 139-145, 218-222

Also the next type of farming cooperatives that is the cooperatives of farmer's circles (Pol. "Spółdzielnie Kółek Rolniczych") suffered from systemic transformation.

Tab. 3. Scope of activity of the Cooperatives of Farmer's Circles in Poland

Earlier period	Currently
<ul style="list-style-type: none"> <li>- farmer's circles are the oldest farmer's association (dating back to 19<sup>th</sup> century); prior to WW II they supported different forms of aid for their members and local communities, including education of farmers, introducing technical, technological and biological improvements in farms; They also organized mechanization and chemization services in individual farms</li> <li>- they were re-established in 1956. Their aim was to service the works</li> </ul>	<ul style="list-style-type: none"> <li>- 517 cooperatives</li> <li>- production services for farmers (mechanization of field work), production supplies, non-farming services (e.g. production of</li> </ul>

<p>connected with mechanization of farming and provide specialized rural transport. They were also active in manufacturing and processing sector.                  - In 1973 they were reformed in farmer's circles cooperatives. Their main roles was food production, mechanization, irrigation, use of meadows and pastures, produce seed material, increase the productivity of green pastures and production of fodder, improve fertilizer use. The number of these cooperatives rose from 1889 to 2006 between 1980 and 1988, with the number of members growing from 55.5 to 113.6 thousand and the employment figure dropping from 230 to 154 thousand.</p>	<p>construction materials, construction and repair services, construction of waterworks and sewage networks, construction &amp; repairs of local roads, transport) sales (fuels, mineral fertilizers, plant protection agents, petrol stations) food processing (fodder factories, mills).</p>
---	--

Source: own work based on NCC; Brodziński, M., G., (2014). Aspects of rural cooperatives, FREL, Warszawa, p. 150- 153, 234-241

The number of these institutions fell dramatically (tab 3). Currently only 1/3 of them offer traditional farming services, with the remaining ones acting in different fields. They use their service and production facilities to a small extent only, as majority of services in rural areas were taken over by private enterprises or went to the so called “gray zone” – that is aid by neighbors. Additionally the technical equipment of farms improves and there is no need for services of those cooperatives. At the same time these cooperatives still have to pay the costs of maintaining their technical facilities.

Dairy cooperatives have the biggest share in production services for farms. There are currently 147 cooperative dairy plants, employing over 20 thousand employees, with over 130 thousand milk suppliers as members-co-owners of dairy cooperatives. The dense national network of dairies has good material base. Most of the regions with large number of dairies are also characterized by high volumes of milk production and sales. This enables the national dairies to offer a broad range of products. Most of dairies offer full range of dairy products, including the basic and more differentiated dairies, including innovative products, e.g. for sportsmen, ecological or for lactose-intolerant. Many dairies also offer traditional and regional products, with appropriate certificates. The national dairy cooperative movement is characterized by its experience and long tradition of making dairy products, which wins them customers concentrated on local culture. First Polish dairies were founded at the end of 19th century, at rich mansion houses, as private initiatives or companies of landlords, but also as peasant's cooperatives. Immediately before Second World War there were already 1475 dairy cooperatives, with some 700 thousand members. Ever since their creation the objective of dairy cooperatives remains unchanged – to improve profitability of farm production and improve the market position of milk suppliers. Dairy cooperatives were also centers for civilizational improvement in local communities, with its educational activities, and in some periods acting as centers of movements for national liberation (KZSM, 2017). It were the dairy cooperatives that adopted best, among different branches, to functioning in conditions of market economy. This was accompanied by processes of consolidation, concentration and specialization of dairy cooperatives (Zuba-Ciszewska, 2015). Still, after the economic transformation the share of dairy cooperatives in purchase of cow milk fell down from 100% to now 65%. In the result of modernization the dairy cooperatives hold one of the most modern milk processing facilities in Europe, successfully competing in European and World markets, which is further proven by the growing value of Polish export of dairy products, and in particular after EU accession (from 618 to 1650 million Euro). Some of dairy cooperatives: SM “Mlekpól” in Grajewo, SM “Mlekovita” of Wysokie Mazowieckie or the OSM Łowicz took over from several to over ten other, smaller dairy cooperatives each, thus improving their market position.

Gardening and apiarian cooperatives are one of the younger forms of cooperative farming organizations in Poland. They were first founded a hundred years ago. In their golden age

they held a 2/3 share in purchase of fruit and vegetables, 1/3 share in retail sales and 40 and 50% share in national processing of frozen fruit and vegetables, respectively (tab. 4). In the new economic system these cooperatives were left without central management, organizational, economic and legal support, with 90% of the assets of the central transferred to the privatized company. That is why the scope of activity of those cooperatives shrunk to several percent. There are several cooperatives with brands that are recognized throughout Europe, but the vast majority slowly ceases their activities.

Tab. 4. Scope of activity of traditional gardening-apiarian cooperatives in Poland

Earlier period	Currently
<ul style="list-style-type: none"> <li>- between 1945 and 1988 the number of cooperatives rose from 46 to 140, and the number of members from 6.5 to 371 thousand</li> <li>- number of permanent purchasing centers rose from 110 to 1113, of retail outlets from 40 to 6455, number of fruit &amp; vegetable processing plants from 9 to 210</li> <li>- these cooperatives were involved in gardening, beekeeping, purchase and processing of honey, vegetables and fruits, retail and wholesale of fresh produce, products and flowers</li> </ul>	<ul style="list-style-type: none"> <li>- 72 cooperatives</li> <li>- several cooperatives with good position in European market (e.g. APIS – manufactures meads, Grzybek Łosicki – mushrooms, Spółdzielnia Ogrodnicza w Grójcu – apples)</li> <li>- they include vegetable, fruit and flower producers, as well as producers of honey and derivatives</li> <li>- they keep purchasing centers for fruits and vegetables, fruit and vegetable stores, florists'; provide seed stores with gardening supplies, seeds, tools and plant protection agents</li> <li>- other activities, such as sale of planting stock (trees, shrubs) from qualified nurseries</li> </ul>

Source: own work based on Brodziński, M., G., (2014). Aspects of rural cooperatives, FREL, Warszawa, p. 134-138, 244-252

The new (introduced in 2000) form of cooperatives in rural areas are producers' groups. They have limited administration, use the technical infrastructure of producers (warehouses, transport, packaging). Their aim is to jointly sell the products of farms of their members, concentrate the demand, improve the efficiency of farming, increase farmers' income by reducing costs (e.g. joint purchases of production supplies), plan and prepare large and homogenous batches of high quality products. The advantages the membership in such group bring to farmers also include joint investment (capital, credit facilities, machines, warehouses, cold storages, etc.), introduction of new technologies, distribution of risk on all group members and joint problem solving, use of consultancy services, exchange of information and expertise (KSOW, 2017). There were 524 producers' groups with some 8 thousand farmers in 2015 that were functioning in form of cooperatives, accounting for 31% of the total number of groups. (Brodziński, Leśniak, Bomba, 2015). Their intensive development is the result of financial support for this organizational form within the framework of the CAP. These cooperatives are involved in plant or animal production, including their specific types, such as fuel or technical plant production, production of seed and planting material or ecological production.

And the ecological farming in Poland is growing very dynamically. This is further confirmed by the growing retail sales of ecological food in the period from 2004 to 2015, from 25 to 165 million Euro, which is part of the worldwide trend (21 to 76 billion Euro in respective period). In the years 2004-2014 the share of ecological farms in the total number of farms in Poland increased 13-fold, up to 1.8% (some 25 thousand farms) and their area 8-fold to 3.5% (660 thousand hectares). The main stimulating factor for development of ecological farming in Poland, especially since 2004, are the subsidies to ecological production within the CAP. The development of farming, including ecological farming is further fostered by the fact that the majority of Poland is located in lowlands, and 60% of its area is occupied by arable land, that is directly used for farming or horticulture. Ecological farming can improve the issues of poor soil quality. By using crop rotation and proper fertilization strategies farmers improve the fertility of soil and crop yields. There are also large workforce resources in the national

farming industry, which means large fragmentation of farms and large proportion of population living from farming, as well as the need for better allocation of the potential of workforce both outside farming and in the farming industry. That is why the introduction of ecological farming practices, that frequently require larger workloads than conventional farming, allows the improvement in use of workforce resources allocated to farming. Creation of cooperatives could help overcome the development barriers in this branch of farm production. The scattered, small and frequently changing character of ecological production causes problems of processing plants that are unable to acquire large batches of farm products with similar characteristics, that would allow them to broaden their sales to foreign markets. Farmers are poorly organized, and have problems in receiving thorough support services. There are no organizational structures (e.g. wholesales) that would actually integrate the links of the ecological production chain. There are obstacles (mainly legal) for direct sales, which does not foster building direct bonds of producers with consumers. That is why there is still place here for not only producers' but also processing cooperatives. Even with the number of ecological processing plants growing 11-fold in Poland – between 2004 and 2014 – from 55 to 484, they still account only for 3% of food and beverage manufacturing bodies (Zuba-Ciszewska, Zuba 2016). The development of agriculture and rural areas also supports a specific type of cooperative, ie. cooperative banks. Cooperative banks are more stable institutions than large commercial banks. They are focused mostly on ensuring access to basic bank products, in particular beneficial credits for the local community. Their local character results from legal regulations. As a result, they play crucial role in regional and local development, especially in the areas far from large cities where commercial banks often do not serve well. The offers of cooperative banks are well adjusted to the needs of farmers, micro, small and medium-sized enterprises (SMEs), due to knowledge of their operating conditions (Zuba, 2013). A long, several-century-long tradition of the development of banking cooperatives in Poland explains the large number of cooperative banks (559) and the dense network of outlets (4633 or 38% of the banking sector with 33,000 employees or 20% in the banking sector).

### **Conclusion**

Cooperatives still play an important, though decreasing, role in agriculture in Poland. As the development encompasses a long period of time, the author presents in a long time the perpsip of the review of the activities of different types of cooperative. As a result of market transformation, the role of cooperatives in the economy of Poland has decreased. Not all types of agricultural cooperatives coped with the need to adapt to fierce competition in the market (except dairy sector and financial). Agricultural cooperatives need farmers, their members, employees and contractors. The efficiency of cooperation, e.g. in raw material collection, prices of raw materials or products, the availability of services for farmers, is the basis for evaluation of functioning of cooperatives by farmers. Therefore, it appears that traditional cooperatives in rural areas that do not achieve satisfactory economic results should adapt their activities to the needs of the market by searching for new, maybe niche activity such as e.g. ecological production and processing cooperatives, cooperative groups of agricultural producers.

### **References**

- Brodziński, M., G., (2014). Aspects of rural cooperatives, FREL, Warszawa.  
Brodziński, M., G., Leśniak, L., Bomba, J., (ed.) (2015). State and prospects for the development of rural cooperatives in Poland, CDR, Kraków  
CSO <http://stat.gov.pl/> [4.6.2017]  
ICA <http://ica.coop/> [4.6.2017]

NCC <http://www.krs.org.pl> [3.6.2017]

KSOW <http://ksow.pl/grupy-producentow-rolnych.html> [5.7.2017]

KZSM <http://www.mleczarstwopolskie.pl> [5.7.2017]

Zuba, M., (2013). Changes of the credit-activity of cooperative banks in Poland and in Europe in years 2007–2011, *Zeszyty Naukowe SGGW w Warszawie, Ekonomika i Organizacja Gospodarki Żywnościowej*, No. 103, pp. 93-105.

Zuba-Ciszewska, M., (2015). The structure of dairies regards to scale of the production of chosen milk products in Poland and Germany (in years 2003-2012), *Zeszyty Naukowe SGGW w Warszawie, Problemy Rolnictwa Światowego*, Vol. XXX/1, pp. 161-171.

Zuba-Ciszewska, M., Zuba, J. (2016). The place of the organic farm output in the Polish agriculture, *Roczniki Naukowe SERiA*, Vol. XVIII/3, pp. 411-418



## THE ANALYSIS OF THE PROJECTS IMPLEMENTED BY MEASURE 313, IN TIMIS COUNTY (WEST ROMANIA)

Adrian BĂNEȘ<sup>1</sup>, Manuela-Dora ORBOI<sup>2\*</sup>, Tiberiu IANCU<sup>2</sup>, Vasile GOȘA<sup>1</sup>

<sup>1</sup>Romanian Academy – Timișoara Branch, Timișoara, Romania

<sup>2</sup>Faculty of Agricultural Management, Banat's University of Agricultural Sciences and Veterinary Medicine "King Michael I<sup>th</sup>" from Timisoara, Timișoara, Romania

\*Corresponding author: manuela\_dora@yahoo.com

### Abstract

Measure 313 "Encouragement of tourism activities" falls under Axis III - "Improving the quality of life in rural areas and diversifying the rural economy" and has as general objective the development of tourism activities in rural areas that contribute to increasing the number of jobs and alternative incomes, as well as increasing the attractiveness of rural space. The financial support of Measure 313 was allocated from the European Agricultural Fund for Regional Development. Eligible beneficiaries were: Micro-enterprises (private equity companies, including craft and consumer cooperatives that have set up activities related to rural tourism in the constitutive act); Individuals (not registered as economic agents) who, until the date of signing the grant agreement, will be authorized with a minimum status of authorized natural person; Communes through their legal representatives, as well as intercommunity development associations made only between the communes; NGOs. As a result of the analysis of the projects submitted on Measure 313 "Encouragement of tourism activities", on 30.06.2011, in Timis county the number of submitted projects was only 50 (226 in the whole 5 West region), of which only 18 (out of 113 from total region) financing contracts, so the absorption level being 0.02% of the total public expenditure allocated at country level. Thus Timis County was ranked second to last in the four counties that form the Region 5 West Romania. In addition to these data, the paper also presents the distribution of projects submitted and concluded on localities, value, domain (public or private), as well as demographic details of legal representatives of applications for funding (age, gender, training, etc.).

**Keywords:** *funds absorption, tourism activities, financing contracts, Timis County*

### Introduction

Measure 313 "Encouraging tourism activities" falls under Axis III - "Improving the quality of life in rural areas and diversifying the rural economy" and has as a general objective the development of tourism activities in rural areas that contribute to increasing the number of jobs and alternative incomes, as well as increasing the attractiveness of rural space. The specific objectives of this measure refer to: creating and maintaining jobs through tourism, especially for young people and women; increasing the added value in tourism activities; creation, improvement and diversification of tourism infrastructure and services; increase the number of tourists and the duration of visits (\*\*\*, PARDF Timiș report, 2011, \*\*\*, Applicant's Guide "Encouraging Tourism Activities" Measure 313, Ministry of Agriculture and Rural Development, Bucharest).

Operational objectives relate to: increasing and improving small-scale tourist reception facilities; development of tourism information and promotion systems; creating recreational facilities to ensure access to natural areas of tourist interest (Feher *et al.*, 2010).

The public contribution related to measure 313 was 388.280.074 Euro (9.540.000 Euro represents the financial allocation related to the SME Guarantee Scheme) of which the Romanian Government's contribution from the central state budget - 20%, the European Union contribution - 80%. The total cost, made up of the public contribution and private contribution, was 597.353.960 Euro (\*\*\*, Annual Progress Report on the Implementation of the NRDP in Romania in 2011, 2011).

Eligible beneficiaries for support under Measure 313 "Encouragement of tourism activities" are: Micro-enterprises (private equity companies), Physical persons (not registered as economic agents), Communities through their legal representatives, NGOs.

### Materials and methods

In order to see the number, value and scope of the projects, we used a qualitative study, namely interviews with the people in the leadership of the communes. The interview was applied for two areas: public and private. For both, public and private sectors were considered 14 municipalities, with 14 projects in the first case and 29 for the second case. The questions in the interview referred to the submitted projects (name, value) and to the legal representative (his / her position, age, sex and training). All the interviews took place in the mayor's office, lasted between 10 and 15 minutes and were applied in August-September 2011 period.

### Results and discussion

In table 1, we present the situation of compliant submitted projects number and the eligible public declared value, number of contracts and total value of contracts (euro) and the total amount paid to the concluded contracts on the West Region of Romania – Measure 313, Caras-Severin County with 85 applications having the largest share.

Table 1. The status of the projects and the value of the contracts submitted and concluded in the West Region for Measure 313 "Encouragement of tourism activities"

Region / County	Compliant submissions		Contracts concluded		
	Number	Amount of non-reimbursable public aid (RON)	Number	Total public value of contracts - Euro	Total amount of payments - EURO
West Region	<b>226</b>	<b>164.008.862,59</b>	<b>113</b>	<b>20.598.793,0</b>	<b>515.555,20</b>
Arad (AR)	52	30.380.563,47	18	3.018.193,0	144.767,70
Caras-Severin (CS)	85	66.080.013,65	55	10.116.106,0	154.169,19
Hunedoara (HD)	39	28.167.245,64	22	4.129.188,0	103.629,31
Timiș (TM)	50	39.381.039,84	18	3.317.193,0	112.989,00

Source: Synoptic table, PARDF Timiș report, 31.06.2011

Out of the total of 226 projects submitted on the West Region, in Timis County were submitted only 50 applications, of which 18 were concluded, with a paid value of 3317193 Euro.

As a result of the analysis of the projects submitted on Measure 313, public domain, in the period 2010-2011, in Timis county, it was found that 14 applications for funding were submitted, all in rural areas, in Balint, Barna, Belinț, Bethausen, Coșteiu, Criciova, Fârdea, Gavojdia, Nădrag, Pișchia, Satchinez, Sânandrei, Traian Vuia and Victor Vald Delamarina. The execution time was 12 months (7 applications), 15 months (1 project) and 36 months (6 projects), the title of the projects being (table 2):

- Tourist information center in Belinț / Coșteiu / Criciova / Fârdea / Gavojdia / Satchinez / Traian Vuia (6 financing requests).

- Establishment of a local tourism information center and tourism promotion / Establishment of tourist information center and development of marketing services related to tourism / Establishment of local tourist information and marketing services related to rural tourism in Balint / Barna / Bethausen / Nădrag / Pișchia / Sânaandrei / Victor Vlad Delamarina, Timiș County (7 applications for funding).

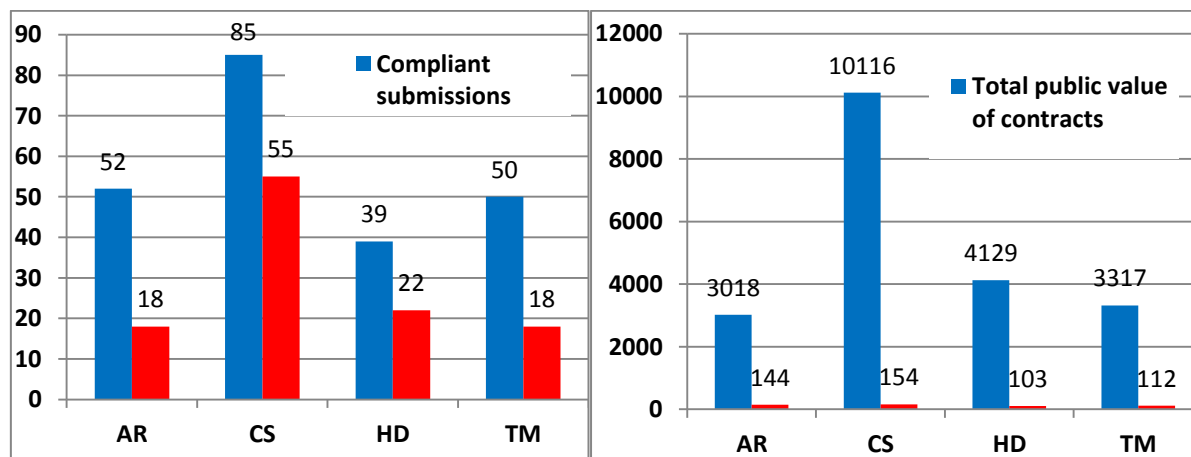


Figure 1. Number of projects submitted/number of contracts concluded and Public value of the concluded contracts/public value of the contracts paid for Measure 313 – mil. EUR

Table 2. Analysis of projects submitted and concluded in Timis County for Measure 313 - public domain

Project name	Number of projects	Project location, residence environment, locality	Legal Representative	
			Studies	Age
Tourist Information Center	7	R, Belinț	Statement that it will follow a qualification course	45-49
		R, Coșteiu	Statement that it will follow a qualification course	40-44
		R, Criciova	Statement that it will follow a qualification course	45-49
		R, Fârdea	Statement that it will follow a qualification course	40-44
		R, Gavojdia	Statement that it will follow a qualification course	45-49
		R, Satchinez	Higher education	45-49
		R, Traian Vuia	Secondary education	65-69
Establishment of a local tourist information and promotion center	1	R, Pișchia	Statement that it will follow a qualification course	45-49
Setting up the tourist information center and developing the marketing of tourism related services	1	R, Sânaandrei	Statement that it will follow a qualification course	45-49
Establishment of a local tourist information center and marketing services related to rural tourism	5	R, Balinț	Statement that it will follow a qualification course	50-54
		R, Barna	Statement that it will follow a qualification course	50-54
		R, Bethausen	Statement that it will follow a qualification course	50-54
		R, Nădrag	Statement that it will follow a qualification course	40-44
		R, Victor Vlad Delamarina	Statement that it will follow a qualification course	60-64

Source: Interview Guide applied on the field

The results show that the declared value in the application was in the range 210409 to 257451 Euros, and the value declared eligible in the application was in the range 167497 to 200000 Euros. In all cases, the legal representative of the funding applications was the mayor from the respective localities, aged 40-44 years (3 persons), predominantly 45-49 years (6 persons), 50-54 years (3 persons), 60-64 years (1 person), 65-69 years (1 person), all male. In the case of the studies, 12 persons gave a "Declaration that will follow a qualification course" until project finalization and implementation, 1 person has higher education and 1 person has medium education.

In the private sector, following the analysis of the projects submitted on Measure 313, in the period 2008-2011, Timis County, it was found that 29 requests for funding were submitted (\*\*\*, NRDP – National Rural Development Programme, 8<sup>th</sup> version, March 2012), all in rural areas, in Beregsău Mare (2 projects), Cenei, Chevereșu Mare, Coșteiu, Dumbrava, Fârdea (4 projects), Gavojdia, Mănăștiur (2 projects), Pădureni, Parța (4 projects), Periam, Săcălaz (8 projects), Sănanđrei, Surduc (2 projects), the execution time being 18 months (1 project), 22 months (6 projects), 24 months (11 projects), 30 months (1 project) and 36 months (8 projects). Project names are very varied, as seen in table 3.

Table 3. Analysis of projects submitted and concluded in Timis County for Measure 313 - private domain

Project name	Project location, residence environment, locality	Legal representative			
		Position	Studies	Sex	Age
Arranging recreation area	R, Cenei	Unique associate	Faculty of Economics	F	30-34
Construction of swimming pool and amusements mini-park, including administrative building	R, Săcălaz	Manager	Statement that it will follow a qualification course	F	20-24
Construction of swimming pools, leisure base - mini golf and bowling	R, Săcălaz	Manager	Statement that it will follow a qualification course	M	25-29
Construction of swimming pools, including ground floor commercial administrative building	R, Săcălaz	Manager	Statement that it will follow a qualification course	F	40-44
Construction of leisure center	R, Parța	Manager	Statement that it will follow a qualification course	F	40-44
Constructing horse manege	R, Săcălaz	Manager	Statement that it will follow a qualification course	M	35-39
Construction of boarding house	R, Săcălaz	Manager	Statement that it will follow a qualification course	M	65-69
Construction of fitness building and sports field	R, Săcălaz	Manager	Statement that it will follow a qualification course	M	45-49
Construction of tourist reception and recreational activities	R, Săcălaz	Manager	Statement that it will follow a qualification course	M	35-39
Construction of tourist boarding house by consolidating and changing the destination of existing built spaces	R, Sănanđrei	Manager	Faculty of Agriculture	F	45-49
Construction of tourist boarding house, courtyard fitting, swimming pool location, indoor parking and field fencing	R, Beregsău Mare	Manager	Statement that it will follow a qualification course	M	35-39
Construction of boarding houses, garages and changing rooms, fencing	R, Beregsău Mare	Manager	Statement that it will follow a qualification course	F	25-29
Construction of tourist board and landscaping	R, Parța	Manager	Certificate	F	20-24
	R, Parța	Manager	Certificate	M	20-24
Boarding house construction, dismantling, removing land from agricultural use	R, Pădureni	Legal Administrator	Statement that it will follow a qualification course	F	50-54
Construction of a rural tourist boarding house in the recreation area	R, Fârdea	Manager	Faculty of Economics and Business Administration	F	25-29

Expansion of hunting lodge, swimming pool construction, parking and installation of solar panels	R, Mănăștiur	Manager	Certificate	M	40-44
Establishing a recreational base	R, Mănăștiur	Manager	Statement that it will follow a qualification course	M	20-24
Establishment of an agro-tourist boarding house	R, Dumbrava	Manager	Statement that it will follow a qualification course	F	30-34
Establishment of an tourist boarding house	R, Fârdea	Manager	Statement that it will follow a qualification course	F	35-39
	R, Chevereșu Mare	Titular	Statement that it will follow a qualification course	F	35-39
Establishment of tourist boarding house with restaurant	R, Gavojdia	Manager	Statement that it will follow a qualification course	F	35-39
Setting up a tourist board and leisure activities	R, Parța	Manager	Faculty of Tourism and Commercial Management	M	25-29
Establishing a tourist pension and parking	R, Fârdea	Manager	Statement that it will follow a qualification course	F	35-39
Establishment of tourist pension, parking and access road	R, Fârdea	Manager	Statement that it will follow a qualification course	F	35-39
Agrotourist boarding house	R, Coșteiu	Legal representative	Statement that it will follow a qualification course	F	40-44
Tourist guesthouse	R, Surduc	Manager	Statement that it will follow a qualification course	M	40-44
Rural tourism “bed and breakfast”	R, Săcălaz	Manager	Tourism certificate	M	40-44
	R, Periam	Legal representative	Statement that it will follow a qualification course	M	45-49

Source: Interview Guide applied on the field

The amount declared in the application was in the range of 140981 – 1395707 Euros, and the declared value in the application was in the range 100000 – 646750 Euros. The amount declared in the application was lowest for the project "Establishment guesthouse in Dumbravita, Timis" - 140981 Euro, and the highest for the project "Construction of boarding house, dismantling, removing land from agricultural town Pădureni, Timiș county" - 1395707 Euro. Regarding the declared value eligible in the financing application the lowest was for the project "Agrarian tourism Gardenia, height Demisol + Ground floor + floor, Coșteiu locality, Timiș County" - 100000 Euro, and the highest for project "Construction of boarding house, dismantling, removing land from agricultural use”, Pădureni locality, Timis County – 646750 Euros.

The legal representative of the grant applications was: the administrator (24 projects), legal administrator (1 project), sole associate (1 project), legal representative / representative (2 projects), holder (1 project). The age of the legal representative was between 20-24 years (4 persons), 25-29 years (4 persons), 30-34 years (2 persons), - predominantly - 35-39 years (8 persons), 45-49 years (3 persons), 50-54 years (1 person) and 65-69 years (1 person). As legal representative by sex, there are 12 male and 17 female persons. With regard to the studies, 22 persons submitted a "Declaration that will follow the qualification" until the project is finalized and implemented, 1 person has a tourism certificate, 3 persons have a professional qualification certificate and 4 persons have graduated higher education diplomas.

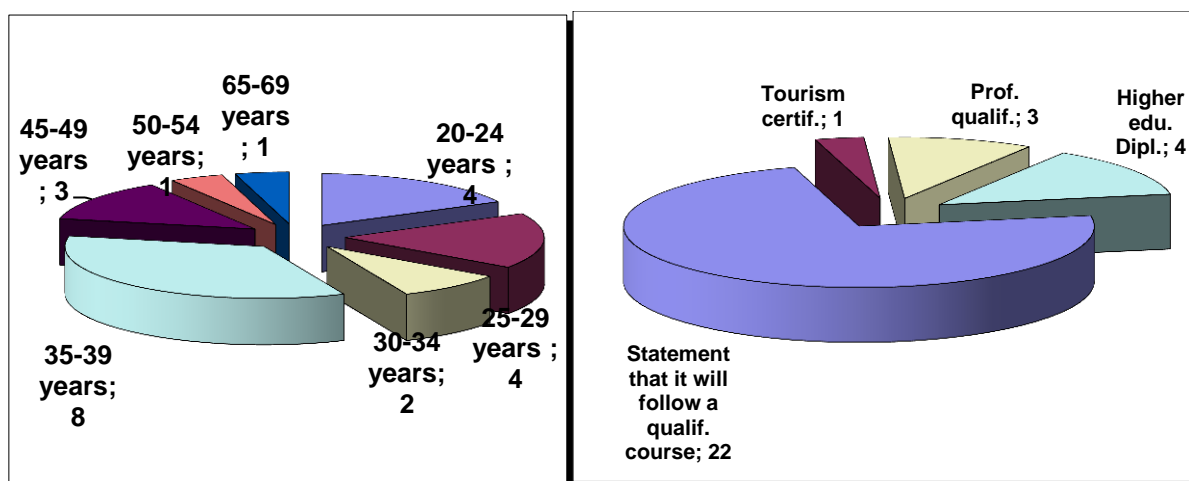


Figure 2. Legal representative of the projects submitted for Measure 313 - private domain (age and studies)

### Conclusion

If we refer to public sector projects, all have been applied to create a tourist information center. Thus, there is a desire on the part of the local authorities to develop the tourist component in the area, especially since the vast majority do not have the necessary studies and have declared that they will follow qualifying courses. Still, it remains a question: in the localities where the legal representative will change after the local elections in 2012, who will state that he has passed the qualification course submitted with the application for funding and what will happen if the new representative does not have the necessary studies?

In the private sector it was found that most of the funding applications were for the construction of pensions and the extension of existing ones with new facilities such as parking, swimming pools and other recreation places (generally, with few exceptions, a project at every locality). Unlike the public domain, the age of legal representatives is lower (18 persons under 40 years, to 5 over 40 years) and women predominate (17 to 12). Also, the percentage of those who already have the necessary studies is almost double that of the public sector. Last but not least, due mainly to the reduced tourist potential, the percentage of projects in Timis county was lower compared to the other counties in the region, both in number and value.

### References

- Feher Andrea, Goşa V., Adamov Tabita, Stanciu S., (2010), Analysis on the Implementation of the National Program for Rural Development in Timiş County and in the Development Region V-West, *Lucrări științifice Facultatea de Zootehnie și Biotehnologii*, ISSN: 1221-5287, vol. 43 (2), pag. 458-462
- \*\*\*, PARDF (Paying Agency for Rural Development and Fisheries) Timiş report, 31.06.2011
- \*\*\*, Applicant's Guide "Encouraging Tourism Activities" Measure 313, Ministry of Agriculture and Rural Development, Bucharest
- \*\*\*, NRDP – National Rural Development Programme, 8<sup>th</sup> version, March 2012
- \*\*\*, Annual Progress Report on the Implementation of the National Rural Development Program in Romania in 2011, Ministry of Agriculture and Rural Development, Bucharest.

## **IDENTIFICATION OF THE IMPORTANCE OF EUROPEAN PROJECTS IN THE DEVELOPMENT OF RURAL COMMUNITIES IN TIMIS COUNTY, IN ROMANIA**

Manuela-Dora ORBOI<sup>1</sup>, Adrian BĂNEȘ<sup>2\*</sup>, Ioan PETROMAN<sup>1</sup>, Ioan BRAD<sup>1</sup>

<sup>1</sup> Faculty of Agricultural Management, Banat's University of Agricultural Sciences and Veterinary Medicine "King Michael I<sup>th</sup>" from Timisoara, Timișoara, Romania

<sup>2</sup>Romanian Academy – Timișoara Branch, Timișoara, Romania

\*Corresponding author: abanes@gmail.com

### **Abstract**

The opportunity represented by the European funding, which the Romanian rural and urban system of settlements was able to benefit through European programs, was a topical element. In order to identify the importance and role of European projects in the development of rural communities in Timis County, we conducted a study through a qualitative analysis. In conducting this analysis we used an application of an interview guide to the local authorities, mayor or deputy mayor, from 22 communes of Timis County. The Interview Guide has 4 distinct parts: Sustainable Development / Rural Development, National Rural Development Program / Operational Programs, Development Issues and Perspectives. As a result of the analysis, it was observed the maximum exploitation of the opportunities offered by the projects with European financing and the focus of the interest in the directions established as priority by the European Union only in some communes. The paper presents the number of applications submitted, as well as the title of the project and the extent to which these applications have been submitted. Also, there is the respondents' answers to the reasons why they did not apply for funding, as well as their response on the role of European projects in the development of their rural communities. As a result of the implementation of the European projects, there are changes in the rural area, which make the rural space a tempting space with facilities similar to those in the urban area, but there are problems like lack of jobs, in some areas insufficient infrastructure development, lack of projects and means of capitalizing the agricultural products.

**Keywords:** Rural community, opportunity, role, development, Timis county

### **Introduction**

To achieve our goals of sustainable development, we need more effective, democratic and accountable international and multilateral institutions (\*\*\*, Johannesburg Declaration on Sustainable Development, 2002). Starting with 2007, Romania is a member of the European Union and has taken the first steps on the EU market. Restructuring, modernizing and developing the agri-food sector, as well as the forestry and wood processing sector, pose a great challenge to increase their competitiveness (Otiman P.I. *et al.*, 2006). In December 2005, the National Development Plan (NDP) for 2007-2013, a tool for prioritizing public investment for development, was completed, in which Romania tried to recover as soon as possible the socio-economic development disparities towards the EU member countries. NDP has established the allocation of public funds for investment with significant impact on economic and social development from internal sources (state budget, local budgets, etc.) or external (Structural and Cohesion Funds, EU funds for rural development and fisheries, external credits, etc.). The National Rural Development Program targeted a number of objectives that support the increase of agro-food and forestry competitiveness, improve the

environment and rural area, improve the quality of life in rural areas, diversify the rural economy, start and operate local development initiatives. The objectives of the program was made by implementing measures provided for each axis. (\*\*\*, RDP 2007-2013, 2012).

The programming of support operations through the National Rural Development Program focuses on four priority axes: (\*\*\*, Annual Progress Report on the Implementation of the National Rural Development Program in Romania in 2011, 2011).

- Axis 1 "Increasing the competitiveness of the agricultural and forestry sectors", aimed at improving the efficiency of the agricultural and forestry sectors in order to prepare them for the competition in an open commercial environment.

- Axis 2 "Improving the environment and rural areas" - the general objective of Axis 2 measures is to improve the environment in rural areas and to preserve biodiversity through sustainable land and forest management.

- Axis 3 "Quality of life in rural areas and diversification of the rural economy" - the strategic objectives of this axis are to improve the quality of life in rural areas, diversify the rural economy, promote knowledge and improve human potential.

- Axis 4 "LEADER" - aims to support rural development by improving local governance and promoting endogenous potential. The Leader approach will contribute to achieving the Axis 1, Axis 2 and Axis 3 objectives through integrated local development strategies and innovative actions.

Within each axis, depending on the type of investment and the areas concerned were established concrete measures to be implemented under the program. The opportunity represented by the financing that the settlement system could have benefited through the European programs was a novelty element for the Romanian settlement system and was an additional argument for the attention and importance given to the cities, considered the main engines of the growth, the real factories of materials and energy, which ensures the optimal functioning of the settlement system (Feher *et al.*, 2011).

### **Materials and methods**

The opportunity represented by the European funding, which the Romanian rural and urban system of settlements was able to benefit through the European programs, was a topical element (Orboi Manuela–Dora *et al.*, 2016). In order to identify the importance and role of European projects in the development of rural communities in Timis County, we conducted a study through a qualitative analysis. In conducting this analysis, we have resorted to the application of an interview guide to local authorities, mayors or deputy mayors, from 22 communes of Timis County, in a predetermined meeting. We used the "funnel" semistructured interview, where the interview begins with general questions that graduate to the particular, as the interview progresses, focusing on a single subject. The Interview Guide has 4 distinct parts: Sustainable Development / Rural Development, National Rural Development Program / Operational Programs, Development Issues and Perspectives. The selected communes for this study from Timis county are: Biled, Birda, Boldur, Cărpiniș, Cenei, Checea, Dudeștii Noi, Dumbrăvița, Giarmata, Giroc, Lenauheim, Lovrin, Orțișoara, Otelec, Remetea Mare, Satchinez, Săcălaz, Sănandrei, Șag, Uivar, Valcani and Variaș, around Timișoara. The interviews took place in the mayor's office and lasted between 10 and 15 minutes. The period in which these interviews were applied was August 2011.

### **Results and discussions**

The question "Your City Hall has submitted funding applications for projects under available operational programs?" Is a closed question with a well-defined answer with two variants of



the answer, in which the interviewee had to choose a variation of answer. Thus, the question "Your City Hall has submitted applications for funding for projects under the operational programs available?", 20 people responded "YES" and 2 persons "NO" (Figure 1). The following question, "If YES, could you please tell me, the title of the project and the Operational Program / Measure", is closely related to the previous question, the subject answered freely, the answers were those indicated in Table 1.

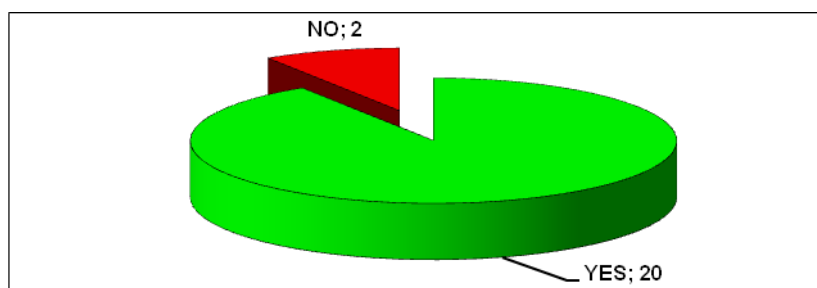


Figure 1. Number of financing applications submitted by the City Hall  
Source: Interview Guide applied on the field

Tabel 1. The answer to the question, "If YES, could you tell me the title of the project and the Operational Program / Measure?"

"Title of the project, Operational Program / Measure" - details
- Rehabilitation of water supply and sewer system - Measure 322
- Rehabilitation and modernization of the park - Environment Operational Program
- Green House - Environment Program; Modernization of agricultural exploitation road - Measure 125; Integrated project: modernization of communal roads and streets, development of community social services (rehabilitation and endowment of cultural homes + after-school construction and endowment) - Measure 322
- Modernization of the communal road, establishment of "after school" children's center, preservation and promotion of local cultural traditions through folk ensemble "Ghiocelul" - Measure 322; Implementation of an innovative document management system and modernization of the Citizens Information Center within the City Hall - Administrative Capacity Development Operational Program
- Domestic sewer system, water treatment plant and extension - Measure 322; Modernization of agricultural infrastructure - Measure 125; Improvement by cleaning and afforestation of degraded land - Environmental Program; Green Commune - Operational Program Increasing Economic Competitiveness; Water World - Tourist Recreational Park - Regional Operational Program; Rehabilitation and inclusion in the tourist circuit of the Roman Catholic Church - Regional Operational Program; Platform E - PCDN - Operational Program Increasing Economic Competitiveness
- Rehabilitation of streets, establishment of water supply network, establishment of sewerage network in localities and purification station, acquisition of folk costumes, establishment after school - Measure 322
- For the future and progress. Elaborating the development strategy - Administrative Capacity Development Operational Program
- Street modernization; Upgrading, fencing and landscaping; Domestic sewage network; Harvest day festival - Measure 322
- Construction of the sewage system, construction of the wastewater treatment plant, modernization and extension of the centralized water supply system, modernization of the street, endowment of the cultural center and establishment of a after-school center - Measure 322
- Developing administrative capacity. Efficient Management System - Administrative Capacity Development Operational Program
- Integrated project "Establishment of the public sewerage network and extension of the public water supply network" - Measure 322

- Establishment of 1 MW photovoltaic park - Operational Program Increase of Economic Competitiveness
- Public lighting project with unconventional energy, solar energy - Environmental Operational Program
- Modernization the streets, setting up and after school, arranging recreational spaces and purchasing popular costumes - Measure 322
- Improving Physical Infrastructure and Basic Services - Measure 322
- Modernization of streets, construction of a nursery and investment to preserve the local specificity and cultural heritage - Measure 322
- Sewerage network and sewage treatment plant, modernization and extension of water supply, modernization of streets, rehabilitation of cultural house in order to promote local traditions, establishment after school - Measure 322
- Roads modernization, renovation and repartitioning cultural center, nursing home - Measure 322
- Modernization of streets, sewerage system (sewerage network and sewage treatment plant), establishment and endowment of a after-school assistance center and modernization and rehabilitation of the cultural center and the purchase of popular costumes - Measure 322

Source: Interview Guide applied on the field

Of the total of 20 affirmative responses, there is a town hall where most of the projects have been submitted - 7, in two other municipalities two applications have been submitted, and in the other municipalities one project has been submitted for financing . The distribution of projects by measures, respectively operational programs, is presented in figure 2.

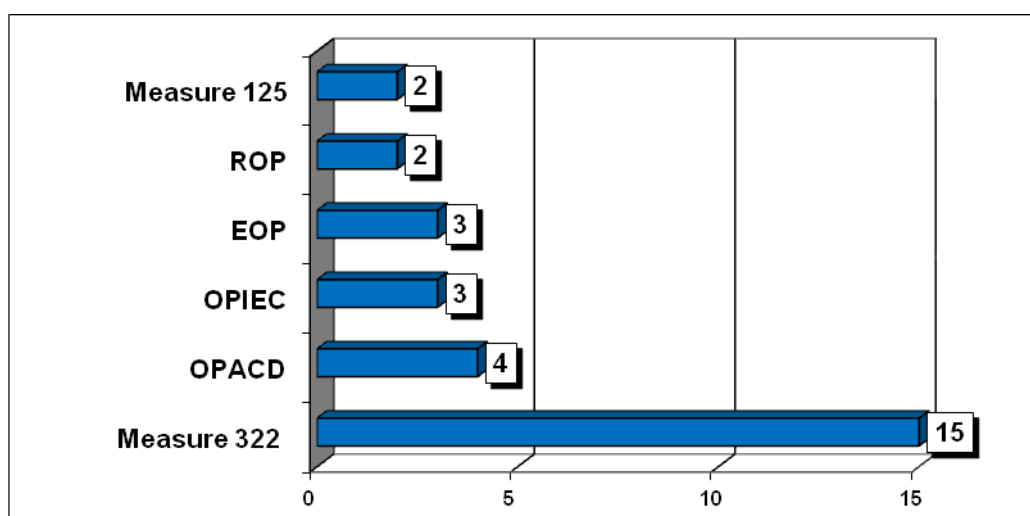


Figure 2. Top of applications for funding on operational programs and measures

Source: Interview Guide applied on the field

It can be noticed that most of the projects were submitted on Measure 322 - 15 applications for funding, on the Operational Program Administrative Capacity Development - 4 applications for funding, Operational Program Increase of Economic Competitiveness - 3 applications, Environment Operational Program - 3 applications for funding. It can be seen making the most of opportunities offered by European funded projects and interest in the directions set as a priority by the European Union, in some communities. Unfortunately, we have not noticed the capitalization of tourist potential in areas that have what "looks" and no immediate prospects for this to happen. Concerning the "reasons for the City Hall to submit project applications", they are presented in Table 2. Generally, the reasons are of a general nature - "lack of funds from own resources to achieve investments / development of the commune / modernization of the existing objectives / modernization of the commune /

continuation of older investments / sustainable development of the commune ". Only 3 mayoralties have clearly stated which was the reason for submitting the applications -" obtaining the ISO certificate (quality, environment, work safety) In the submission of projects ", " the decrease of the public lighting expenses / the decrease of the electricity consumption in the public institutions ". Interviewed subjects (2 people) who gave the answer "NO" to the first question went to the question "If you have not submitted applications for funding for projects, why have you done so?" and he was in both cases this was "Lack of money for co-financing (2%)".

Tabel 2. The answer to the question, "Could you tell me, in the case of your commune, what were the reasons that prompted you to apply for funding for projects?"

"Reasons for submitting applications" - details
- Lack of funds from own resources to make investments; Obvious access to European funds as our country is a contributing member
- Development of the commune; Modernizing existing objectives
- Development of the commune (5 replies)
- Rural development; Attracting funds that cannot be received from the local budget
- Local needs
- Modernization of the commune
- Continue of older investments
- Raising the commune to higher standards
- Obtaining the ISO certificate (quality, environment, work safety), help in projects submission
- Need
- Development of the commune; Decreasing electricity consumption in public institutions
- Lowering public lighting costs
- Sustainable development of the commune
- Development of the commune, lack of funds from the local budget
- Community development
- Continue of older investments and Development of the commune

Source: Interview Guide applied on the field

The question "Do you think that this kind of projects could help your commune?" Is also an open question that allowed the respondents to give a very wide range of answers, the answers were those shown in fig. 3. Subjects gave the following answers: "YES" - 16 subjects, "YES, very much / YES, obviously, YES, surely" - one answer, general answers, "YES, Ensures standards close to the city "- one answer each.

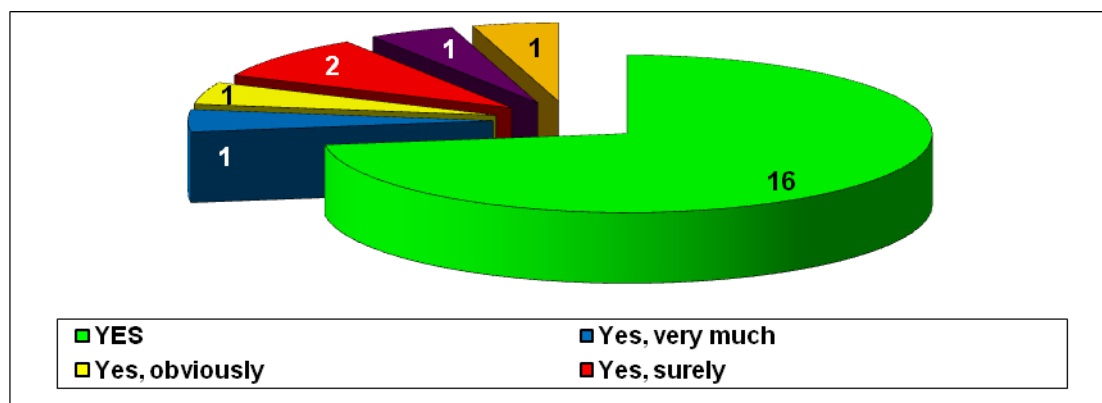


Fig. 3. Distributing of the answer to the question "Do you think this kind of projects could help your commune?"

Source: Interview Guide applied on the field

After a careful analysis of all the opinions expressed in the study, we noticed how recent changes make rural space a tempting place with facilities similar to those in the urban area, but there remain problems such as lack of jobs, in some areas insufficient infrastructure development and lack of the possibilities of capitalizing agricultural products. However, the main problem of the rural environment is the predominant share of the agricultural sector in the economy, non-diversified and with a mono-economic structure, a trend contrary to the European economic policies, low level of infrastructure and services development, lack of alternative sources of employment and income for the aging population of this area.

### **Conclusions**

The development of the Romanian village is a topic of real interest, both from a theoretical and practical point of view, in various fields - social, economic, political etc. In recent years, the village has seen a remarkable development, investments in infrastructure, drinking water supply, sanitation, modernization of schools, kindergartens, dispensaries, parks and sports halls are just a few of the projects implemented in these areas that have radically changed, both the life of the people and the prospects for their development. From the analysis of the answers to the questions we noticed that in recent years the authorities have launched a series of large-scale projects meant to improve the rural area, to bring more comfort to the rural population and to create new opportunities for development. The views of mayors / vice mayors on the difficulties encountered in recent years are varied and they highlight the bureaucratic problems faced by authorities in developing investment projects but also other issues specific to the so called "mioritic" space: the importance of "attention", the mentality of the Romanians, the benefit of communes that have representatives of the same "political color" as those from the government. A delicate and hard-to-manage issue by authorities is also the resistance of change in rural areas - resistance often justifiable and in terms of costs associated with it. The fact is that each implemented project should bring new jobs, new personal development perspectives for those who access it. Rural development projects for Timis County should be based on local specificities and should take into account a polysectorial development, a development in which agriculture is no longer the sole source of income for the inhabitants.

### **References**

- Feher Andrea, Goşa V., Hurmuzache Tabita, Stanciu S., The impact of European Economic Recovery Plan (EERP) on Romanian rural area, *Scientific Journal of University of Szeged, Faculty of Agriculture, „Agrár-és vidékfejlesztési szemle”*, Vol. 6(1), CD, pp. 218-222, ISSN 1788-5345, 2011
- Orboi Manuela–Dora, Băneş A., Otiman P.I., Iancu T., Brad I., Identification of the understanding level of the sustainable development and rural development concept in rural areas from Timis county, 16<sup>th</sup> International Multidisciplinary Scientific Geoconference SGEM2016, ISBN 978-619-7105-65-0, ISSN 1314-2704, book 5, vol. 1, 909-918 pg., 2016
- Otiman P.I. et al., *Dezvoltarea rurală durabilă în România*, Editura Academiei Române, Bucureşti, 2006
- \*\*\*, Annual Progress Report on the Implementation of the National Rural Development Program in Romania in 2011, Ministry of Agriculture and Rural Development, Bucharest.
- \*\*\*, Johannesburg Declaration on Sustainable Development, 2002
- \*\*\*, NRDP – National Rural Development Programme, 8<sup>th</sup> version, March 2012

## **AGRICULTURE - A BASE FOR ECONOMY IMPROVEMENT**

Anja ROSANDIC<sup>1</sup>, Danica MICANOVIC<sup>2</sup>, Vladimir Yu. YUSHKOV<sup>3</sup>, Adriana RADOSAVAC<sup>4</sup>, Snježana GLUMAC<sup>5</sup>, Srdjan ATANASIJEVIC<sup>6</sup>, Desimir KNEZEVIC<sup>7\*</sup>

<sup>1</sup>University of Novi Sad, Faculty of Economics, MSci., Segedinski put 9-11, Subotica 24000, Doktora Sime Miloševića 16, Novi Sad 21000, Serbia;

<sup>2</sup>Serbian Chamber of Commerce and Industry, Resavska15, Belgrade, Serbia;

<sup>3</sup>Perm State Agricultural Academy, Russia;

<sup>4</sup>University Business Academy, Faculty for Economy and Engineering Management in Novi Sad, Cvecarska 2, 21000 Novi Sad, Serbia;

<sup>5</sup>Secretariat for Environmental Protection, City of Belgrade, Serbia,

<sup>6</sup>Technical College of Professional Studies, in Kragujevac, Dept Informatics, R. Domanovica 12, Kragujevac, Serbia

<sup>7</sup>University of Pristina, Faculty of Agriculture, Kosovska Mitrovica-Lesak, Kopaonicka bb, 38219 Lesak, Kosovo and Metohija, Serbia

\*Corresponding author: deskooa@ptt.rs

### **Abstract**

Agricultural production is a main resource for food products and prevention of malnutrition of world population. Arable land is a limited resources for agricultural production - 0.4 ha per capita in the world. This requires attention for rational and optimal use of natural resources for agricultural production, particularly because of the fact that the rise of world human population in the future is predicted, over ten billions citizens. In previous century progress in agricultural production was achieved by developing conventional agriculture and industrial revolution, particularly from the beginning of „Green Revolution” which was characterized by growing technology with a greater use of fertilizers and pesticides. Agricultural resources are under pressure of spreading urbanization, and arable land used for developing factories, towns, industrial buildings, landfills, roads, railways etc., from the period of the Industrial Revolution, up to nowadays. Another problems that disrupts agricultural production is pollution from metal and chemical industry, towns, while in the future a new challenge is climatic changes. Since the beginning of the Industrial Revolution, the concentration of carbon dioxide in the atmosphere has increased by 30%, the concentration of methane has doubled and the sodium oxide increased by 15%. These increases affect the retention of heat in the earth's atmosphere on the principle of the greenhouse effect. The influence of unfavorable condition on agricultural production requires intensive work on resolving adaptive and efficient model(s) of agricultural production under the global climate changes and trend of increasing human world population.

**Key words:** *agriculture, production, economy, rural development, technology*

### **Introduction**

Agriculture is an important branch for production food to the human population, as well as provides a various of raw materials for the textile, tobacco, leather industry, etc., Also, agriculture realizes a surplus of products, which are exported to the world market and creates profit. In Serbia, agriculture is important for the economic, social, environmental and rural development, that in this decade participates about 10% of GDP, while in the previous decade, its share in GDP was higher (25%). The high share of agriculture in GDP confirms its importance for the overall progress of the national economy, although it is necessary to

establish a balance between the value of primary agricultural production and processing of food industry (Mićanović and Zecevic, 2012). The improving productivity in agriculture is directed particularly through efficient water and soil management practices, crop nutrition and protection from pests and diseases. This program needs support from national and International organization in food and agriculture. The average rate of growth of agricultural production in Serbia, at the beginning of the 21st century, is 1.3% of net worth, with dominant plant production. This trend in agricultural production in Serbia is in agreement with global prediction that meet of needs of the world population for food in 2050 will be necessary to increase crop yields by 1.3% per annum (Fischer et al., 2014). The basis for intensive agriculture has remained the selection of new cultivar and hybrids of plant species and breeds of domestic animals, which had greater potential productivity. Today, the main task is the creation of high-yielding varieties and hybrids, which are the basis for increasing food production (Fridman and Zamir, 2012). However in developed Country within agriculture production, the dominant role is production of domestic animals and better market linkage.

The statement of agriculture production is the reflection of statement of overall economy and the degree of technology in processing industry as well level of integration with the institutions and programs of socio-political system.

Climate change is one of the disturbing problems that is currently happening, and already expected global warming in the future is greater than previously predicted. Prevailing view of scientists that we now face an inevitable increase in global temperature and that is great probability that climate change has already occurred. With the threat of climate changes, more and more regions of the world are also at risk of drought and desertification. In order to mitigate the negative effects of climate change, it is necessary to take advantage of current scientific knowledge and develop new ones (Lin et al., 2005). Improved irrigation practices will help conserve water and protect vulnerable land. Stable and radioactive isotopes can be used as “tags” at the molecular level to monitor how plants use essential nutrients as well as to study crop growth and nutrient requirements to increase yields, while conserving water and preventing further degradation of marginal lands.

In economically developed countries, agriculture is characterized by high productivity, which is based on modern technical and technological means and methods of production, then a high degree of organization adapted to the type of agricultural production and integration with modern systems of processing and the appearance on the market of finished products, a further and product placement and income and profit (Knezevic and Micanovic, 2013).

This paper aimed at estimating agriculture’s role on economic growth and its impact on poverty reduction.

### **Agriculture influence to economic and social development**

Agriculture can contribute to growth of economy and modernisation of society, because of its abundance of resources and its ability to transfer surpluses to the industrial sector. Crop production as well livestock production need to be more intensive in the purpose to satisfy demand of increasing world population for food, what require additional investments of 80 billion Euros every years for reducing poverty. Agricultural investments can generate benefits as increasing productivity and food availability, employment of people, reducing poverty, introducing and transfer modern technology and access to capital and markets. In agriculture most resources are used for food production and have role as a one way flow of resources towards the industrial production, because of weak possibilities for trade. For developing economy agriculture is important for food production for different purposes as well

population with different incomes. Agriculture represents source of accumulation for new investment in industry and contributes to the enlarging market for industry products. In addition agriculture supply primary products for processing industry. Also, agriculture earnings in export provide for payment of imported goods (Timmer, 2002).

However, industry produce modern machine and equipment which contribute to improving technology of agricultural production and increasing production per hectare and per worker what significantly modernising economy. In the purpose to commercialise products, producers in cooperation with service sector and partly substitute chemicals and machines for their labour and for remain products receive lower price, in return, their spend less time on the market. This indicate that added values falls over the time, from labour, land and capital of agricultural producers as a share of the gross value of agricultural output. The increasing of purchased intermediate inputs and services can influence to decline of production in agriculture as well in GDP and employment.

The linkages between agriculture and industry is not simple, and share of agriculture to industry and services varied in dependance of level of agricultural and industrial development. For modernisation of agriculture and getting income is necessary supply incentives to realize agricultural goods without rising prices and resources in agriculture need toward industry centres (Rosandic and Knezevic, 2014). On the base of primary production we can estimate demands of industry and urban centres, as well potential agriculture. General estimation is that agricultural production is main base for economic growth and contribute to generate income in agricultural (rural) and urban areas and results of increasing incomes increasing of investment. Agriculture provides tax revenues and supplies materials to agricultural-based manufacture which contribute to lower price of products and have positive impact to economic development.

The impact of agriculture in GDP depends from linkage of agriculture and technology, human resources which directly support to farm productivity and reducing costs, as well connection agriculture and technology. The significance of agriculture share in GDP also, connected with macroeconomic policies through measure of taxation of food producers, traders and exporters, by investment in producing technological innovations and investment in rural incomes to generate social progress and infrastructure.

However, the industrialized management of agriculture refers to the management system that established agricultural bases with enterprises involved in agricultural product processing, sales or technical service as leading force and lead farmers in the agricultural production bases to embark on specialized production of agricultural products. This management can effectively solve the linkage problem between agricultural households of small-scale operation and domestic and foreign big markets, increase the value-added of agriculture by elongating the industrial chain, and improve the management efficiency.

### **Role of science in agriculture developing**

The increasing of agricultural production based on application scientific measure of farming and growing high yielding and quality cultivars and hybrids which were created through breeding by using scientific methodology (Knezevic et al., 2016). The aim of breeding is creation genotypes with enhancing nutritional components and residue as a reason to be performed for the purpose of improving the yield and quality as well resistance to biotic (viral infections, mycoses) and abiotic stresses (drought, cold, salinity). In breeding program were created cultivars and hybrids with double and more increased yield, protein contents, content of fat, carbohydrates (Knezevic et al 2013), eg. in barley and oat content of antioxidants,  $\beta$ -glucan content, in sunflower specific fatty acids (oleic acid), in cotton cellulose extensibility characteristic, in wheat contents of essential amino acids, antioxidants

etc. (Menkovska et al., 2015). The biological quality have great importance for human health, to prevent certain diseases occur due to lack of the presence vitamin D (rickets), an amino acid (e.g., phenylalanine, is created from dopamine and two hormones adrenaline and noradrenaline, which lack in certain cases causes Parkinson's disease). This progress is achieved in a relatively small number of plant species, mainly in species which are the most use in the diet.

At the beginning of the Green Revolution, i.e. in the time of application of new scientific farming measures, creation of new hybrid and cultivars the production of food was increased. This progress based on increasing yield thanks to the introduction of new genotypes and increased application of fertilizers and pesticides in plant production practice. However in all developed and developing economy the significant effect on increasing of agricultural production had introduction of agricultural machinery (tractors, seed, combines, mowers) and than authomation of processing production (mills, processing plants, milking cows and sheep) which contribute to decline manual labour. The strong interdependence between agriculture and science and industry, through which agricultural growth supports overall economic growth and reduce poverty.

Human population rise is imposed by the production of large quantities of food. The required food production can be realize by conducting production on larger metering surfaces or through increasing yield per unit area (Fischer et al., 2014). Increasing of agricultural productivity can increase farm incomes through introduction new technical equipment for transport, processng and marketing and satisfiying demands of consumers and services. This is associated with economic growth and poverty reduction (Rosandic and Knezevic, 2014).

Climate change is estimated on the base of increasing of temperature in some area 5-6 °C, approximately; ice sheets in the Arctic melt significantly, increasing of carbon dioxide in the atmosphere etc., as a consequence of natural disasters (earthquakes, floods, hurricanes, cyclones) non-rational exploitation non-renewable and renewable energy resources, increasing of indusry pollution (Jolánkai and Birkás, 2007). Pollution is a very important factor of extinction, and the consequences of which are present in the agricultural practice after the use of toxic chemicals. Use of toxic hydrogen chloride, dihlor-difenil-trihloretan (DDT) and polychlorinated biphenyl (PCB) has a negative impact on the species that are at the top of the food chain (soften and distort the eggshell will develop a bird, disrupt reproduction carnivores, cause cancer in animals and are probable human carcinogens). This suggests that is need to maintain the coexistence of crops and weeds by application adequate herbicide, otherwise it disrupts soil microfauna, food chains and disappearance many insects, invertebrates and other species in the ecosystem (Pachepsky et al., 2007). Survival depends on ecosystem biodiversity, so that eviction or the loss of one or more species can disrupt ecosystem to decay and brought into question the survival of man, if it is known that over 40% of new drugs in medical pharmacy obtained from plants and animals.

A more economical aspect is to produce plants with an increased yield wherein the significant role had accomplishment in biotechnology through the creation of transgenic plants. The transgenic plants have higher yield, as well as resistance to pests, diseases and tolerance to herbicides, insecticides, etc. However, the occurrence of adverse effects of the use of food from genetically modified plants, aroused caution to the opposition and rejection of the newly plants, as well as due to the risk upsetting the balance in the ecosystem and the negative impact on communities biocenoses (Fridman and Zamir, 2012). It came to initiate a new approach to the growth of plants in natural conditions for food production. In contrast, very intensive requirements present for organic production. The areas for production of organic wheat in 2002 were the largest in Australia 7.7 million ha, in Europe 4.3 milion ha, in Central and North America 3.6 million ha, in North America 1.3 million ha, and at least in



Asia (94.000 ha) and Africa 60.000ha (FAO, 2002). There is a trend of increase in area under organic production. In fact, based on a harmonized ecosystem simulation wants to produce biologically valuable and safe food.

The perspective in agricultural production is in recognizing the importance of innovation, knowledge and education. The registration, acceptance and implementation of innovation can contribute to launching the economic development in all Countries. The transfer of knowledge in economy is not simple, but can contribute to improving technological development of the country, and as well as to accelerate progress of modern economy, particularly agriculture as well improve rural livelihoods, protect biodiversity and environment.

### **The perspective of the rural economy development**

The one of the former form of organization of agricultural production based on cooperatives farm, today is less and less present. The reasons for this are varied, and among them manifested unprofitable existence, emphasized trade and administration functions, unjustified borrowing for investment, low productivity results and others. On this basis, the cooperative could not fulfill its primary function in the interest of members. Also, the complex ownership structure of assets in cooperatives aggravated their renewal. Instead arise new forms of organization of small and medium-sized enterprises, which have an impact on the development of social relations and economic development.

It is certain that the necessary association of producers in order to strengthen production safety, contribution to meeting the demands of the market for the quantity and quality of products. Whether the small land holders are merged and enlarged in the future so the plot or to larger companies buying or renting land plots enlarged in the future production, to creating better adopted for higher productivity. Small producers themselves can hardly meet the criteria of competitiveness in agricultural production. All farms according to their capacity to perform the production and control as in plant and animal production, which is a function of a higher level of consumer protection and food safety. The key for food and nutrition security is agricultural investment by farmers or the public sector. The investment can contribute to increasing productivity at the farm production and can increase quantity and quality of food on the market, decline price and stronger connection between rural and urban consumers.

The introduction of technical-technological innovation in agriculture can contribute to its development, which is based on the concentration of technical means and enlargement of land areas, whereby the developed new agricultural and manufacturing relations (Knezevic and Micanovic, 2013). To cooperative could operate successfully, it is necessary to their establishment on a voluntary basis, in which all operations of the cooperative must have the ability of control operations, economic investment in the development of cooperatives, private education, modernization of equipment. Also, it is necessary to contribute to the strengthening of the independence of cooperatives, strengthening its own budget, and have an impact on the development of the environment and society. Cooperatives could autonomously decide on the structure of production in line with available resources and market needs within the business environment. Achieved by integration of small agricultural areas in larger systems (cooperative farms, combines, mixed holdings) and also all stronger connections agriculture and industry such as agricultural products were used as raw materials for industrial production. These dynamic changes in the organization, structure and modernization of agriculture were present in Western Europe, the United States, the former Soviet Union, etc.

The future progress of agricultural production will based on using of new technologies in farmers production and developing an open market environment to make the resulting production as profitable to producers as employment opportunities in other sectors. In

environment where agricultural development is not possible, rural poverty will only be solved by migration to urban areas (Rosandic and Knezevic, 2014).. Too little public and private capital was invested in rural areas as well in raising rural productivity. The improving of public investments and favorable policy stimulate growth in the agricultural sector is possible achieve through the opportunity for farm investment without financial intermediaries, and the potential to earn high rates of return on public investments that correct for urban bias (Timmer, 2002). The agriculture growth have share in economic growth and direct contribution to growth in GDP.

The scientific potential that we have put into operation improving the level of technological development of the economy, above all, bridging the gap between science and economy (Mićanović et al., 2011). Incentives should be provided for according to the foreseen quotas and applicable standards in manufacturing, whether it is a plant species or species of domestic animals as well as products from them. Also, the stimulus should be reinforced in case the diversification of production, which is required for proper disposal of waste (fertilizer in growing animals), biomass (in the cultivation of cereals, etc.). Thereby manure produced can be used in the nutrition of the plants, which can not be greater than 170 kg ha<sup>-1</sup> per year.

Labeling throat domestic animals, bee colonies increases the level of protection of the environment and human health. In order for Serbia to be recognized on the EU and world market, it is necessary to protect the originality of agricultural products, the geographical origin of the product or process in the manufacture of a product, especially a product of the grapes (wine), dairy products (cheese, cream), bee products (honey, royal jelly, propolis) and fish products.

### **Agricultural production and poverty reduction**

The high level of production and export of agricultural products, achieved in developed countries, thanks to the use of modern technology and encouragement of the European Union. Agriculture in the European countries, after a period of protectionism, the deflection in the single market, on which it freely without customs costs, makes the sale of agricultural products on the one hand, while also implementing protective tariff rates on imported products. This approach was developed in the EU in order to protect the single market of goods produced in the European Union, as well as assistance for the export of goods to other markets in the world. Strengthening agriculture in the European Union is based on: improving the competitiveness of the agricultural sector, improving the quality of agricultural products and environmental protection, development of farmland diversity, and justification for spending the EU budget for agriculture.

In the European Union, of the total agriculture, the production of 75% is achieved in 7 countries as follows: France (18%), Germany (14%), Italy (13%), Spain (10%), the UK (8%), the Netherlands (7%) and Poland (5%). France has become a leading producer and exporter thanks to the effect of incentives of agricultural production eg., in 2007 year. The France, after export of agricultural products was the third in the world, of which the most important export products were wheat, poultry, dairy products, beef, pork, champagne burgundy. In France, the 3.8% of the active population is employed in agriculture and the food industry had a share of 4.2% of GDP. France after export of agricultural products was the third in the world, of which the most important export products were wheat, poultry, dairy products, beef, pork, champagne burgundy.

In the structure of the agricultural production in the EU, the production of cereals represent about 13% of the total production (330 million tons). The largest increase in cereal production was recorded in Slovenia (over 40%), similar in Slovakia and in Austria, Hungary, the UK and Estonia is ok increase of 20%.

The production of pigs, cattle and sheep represents around 17% of total agricultural production in the EU. In France, it is grown around 22% of the total production of about 88 million cattle heads in the EU, followed by Germany 14%, UK 11%. Of the total production of sheep in the EU (84 million head), about 23% is grown in the UK, 15 million in Spain, Romania and Greece, with more than 9 million head. The EU has grown about 148 million pigs, of which more than a third of the products together in Germany (26 million individuals) and Spain (24 million individuals). In production of livestock in Serbia, is dominated production of pigs (3.2 mil. Individuals) which is higher than in neighboring countries (11th place in Europe), than are bred cattle around 920000 and 1.7 million sheep. The Serbia need focused on improving economy with reducing food imports and by increasing food production in agriculture and processing industry. In Serbia present resources to support agricultural based economy.

In the model of the EU agricultural provided market intervention for products that are important to food security and revenue producer, such as sugar, wine, olive oil, etc., Wherein is carried out foreign-protection intervention buying and other forms of product withdrawal from the market, and support consumption and production of certain products. Agriculture and food industry in the EU play an important role in ensuring the health of the population, in rural development and environmental protection. Some 500 million EU consumers spend nearly a quarter of their earnings on food. In the agricultural production is employed about 2% of the labor force, which contributes to more than 4% of the GDP of the EU, and the food industry are employed, about 3% of the labor force, which contributes to more than 3% of the GDP. The potentials of the food sector are significantly higher in the EU for employment (20%) and thus a better share of GDP (about 10%). In terms of the current economic situation establishes a system of organization of agricultural production, transport, and joint technologies of launch of agricultural product (Latacz-Lohmann and Hodge, 2001)

Today's volume of agricultural production in Serbia is at the average level of developing countries, which is paradoxical given the existing professional human and natural resources. This is due, obsolescence and lack of technical resources, unfavorable age structure and the number of agricultural population, as well as the inexperience and incompetence of returnees from urban areas in agriculture (Micanovic and Zecevic, 2012). Also, a significant factor affecting the maintenance of stagnation in agricultural production is the presence of competition, the presence of managers in comes to building production without adequate education and experience, insufficient investment in science and support scientific and mid-career programs, if they exist at the level of analysis without further implementation of the formulated conclusions and the program of measures for development of agriculture (Fridman and Zamir, 2012). Also, a significant inhibition factor is the lack of investment and existing expensive investment in agriculture

### **Conclusion**

For efficient agricultural development is necessary financial resources, revision current import and export regulations and stronger subvention and realisation on the market. Also, is necessary mobilize human resources and use natural resources to make strong agricultural sector which will be the main source of revenue for the Country. The intensification of agricultural production is based on the development and application of new technologies of cultivation of plants and animals, technology, nutrition, harvest, storage and marketing. Improving productivity in agriculture in a sustainable manner is today a realistic target. The future progress of agricultural will based on using of new technologies in farmers production and developing an open market environment to make the resulting production as profitable to producers as employment opportunities in other sectors. In environment where agricultural

development is not possible, rural poverty will only be solved by migration to urban areas. The intensive investment in agriculture, application of scientific methodology, achieve production with low input and high output and provision open market for agricultural product will contribute to economy strengthening and reduction of poverty.

### **Acknowledgements**

This investigation supported by Ministry of Education, Science and Technology Development of Republic of Serbia, Project TR 31092.

### **References**

- Fischer, T., Byerlee, D. and Edmeades, G. (2014): Crop Yields and Global Food Security: Will Yield Increase Continue to Feed the World?: ACIAR Monograph 158.
- Fridman, E., Zamir, D. (2012): Next-generation education in crop genetics. *Curr. Opin. Plant Biol.* 15: 218-223.
- Jolánkai M. and Birkás, M. (2007): Global Climate Change Impacts on Crop Production in Hungary. *Agriculturae Conspectus Scientificus* 72 (1):17-20.
- Knezevic, D., Kondic, D., Markovic, S., Micic, N., Đuric, G. (2013): Breeding for crop improvement. Fourth International Scientific Symposium "Agrosym Jahorina 2013", Editorial in Chief: Dušan Kovačević, 03-06. october 2013. Jahorina, Proceeding, pp.441-448.
- Knezevic, D., Rosandic, A., Kondic, D., Radosavac, A., Rajkovic, D. (2016): Impact of quality of grain wheat on food value. *Növénytermelés*, 65:99-102.Suppl.1.
- Knezevic, D. and Micanovic, D. (2013): The role of science to development of economy and agriculture. Thematic Proceedings. International scientific conference „Sustainable agriculture and rural development in terms of the republic of Serbia strategic goal realization within the Danube region”. Topola, December 5-7th 2013, pp 158-174. Institute of Agricultural Economics, Belgrade
- Latacz-Lohmann, U. and Hodge, I. (2001): European agri-environmental policy for the 21st century. *The Australian Journal of Agricultural and Resource Economics*, 47:1, pp. 123–139.
- Lin, E., Xiong, W., Ju, H., Xu, Y., Li, Y., Bai, L. Xie, L. (2005): Climate change impacts on crop yield and quality with CO<sub>2</sub> fertilization in China. *Phil. Trans. R. Soc. B*, 360: 2149–2154
- Menkovska, M., Brankovic, G., Pajic, V., Momirovic, G.S. and Knezevic, D. (2015): Associations between nutritional composition and farming type of organically and conventionally grown cereals. *Natural Science and Discovery* 1(4): 97-101. DOI: 10.20863/nsd.44541
- Mičanović, D. Knežević, D. and Zečević, V. (2011): Transfer of knowledge and technologies in the function of economic development. Proceedings of the scientific conference Technological inovacijegenerator economic development, Banja Luka, Republic of Srpska, pp.41-49. Ministry of Science and Technological Development of the Republic of Slovenia and the Association of Inventors, Banja Luka.
- Micanovic, D. and Zecevic, V. (2012): Science and Economy. Tematic Proceedings. International Scientific Meeting-Sustainable agriculture and rural development in terms of the Republic of Serbia strategic goals realization within the danube region-Preservation of rural values. Dec, 6-8 2012, pp.189-205 (CD-ROM). Inst. of Agric. Economics, Belgrade
- Pachepsky, E., Bown, J.L., Eberst, E., Bausenwein, U., Millard, P., Squire, G.R. and Crawford, J.W. (2007): Consequences of intraspecific variation for the structure and function of ecological communities Part 2: Linking diversity and function, *Ecological Modelling* 207, 277-285.

- Rosandic Anja and Knezevic, D. (2014): Economic aspects sustainability of the natural and social resources. 65th Anniversary of the Institute of Agricultural Economics Belgrade. International Scientific Conference. In: (eds. D.Cvijanović, J.Subić and Andrei Jean Vasile), „Sustainable agriculture and rural development in terms of the republic of serbia strategic goals realization within the danube Region“ - rural development and (un)limited resources- Tara Belgrade, 5-7 June 2014. Proceeding pp.580-596.
- Timmer, C. P. (2002): Agriculture and Economic Growth. In Bruce Gardner and Gordon Rausser, eds., Handbook of Agricultural Economics, Vol. IIA. Amsterdam: North-Holland. . 1487-1546.

## **ANALYSIS OF THE ECONOMIC EFFECTS OF DRIED PLUM PRODUCTION ON FAMILY FARMS**

Mirjana LUKAČ BULATOVIĆ<sup>1</sup>, Dušan MILIĆ<sup>1\*</sup>, Branka KALANOVIĆ BULATOVIĆ<sup>2</sup>

<sup>1</sup>Faculty of Agriculture, University of Novi Sad, Serbia

<sup>2</sup>Faculty of Agriculture, University of Belgrade, Serbia

\*Corresponding author: milic@polj.uns.ac.rs

### **Abstract**

The traditional model of fruit drying in Serbia is founded upon small family dryers, which are used for drying plums and occasionally apples. Such model features a sustainable energy supply due to utilizing biomass as an energy source. However, a serious technological disadvantage of the model is reflected in the employment of direct drying, which inevitably results in fruit oxidation. Changes in consumers' habits, accompanied by increased sanitary and health requirements, have made this technology obsolete on the market. The contemporary production of dried fruit necessitates "friendly technologies" with a stable and inexpensive energy support. Therefore, a number of researches at the Faculty of Agriculture in Novi Sad examined the adoption of friendly fruit drying technology with a sustainable energy supply. Consequently, the solution was found in the combined fruit drying technology powered by renewable energy sources. Using the combined technology, the production of dried fruit in small drying facilities on family farms can be very profitable. On the basis of the financial analysis of dried plum production, the total and variable costs were calculated for a dryer with a capacity of 450 kg of fresh plums per day. The contribution margin was computed as the difference between the total sales revenue and variable costs, whereas the profit was calculated as the difference between the value of production and total costs. The cost price of dried plum halves was 187.3 RSD/kg (1.52 €/kg). A retail price of 504 RSD/kg was set for dried plum halves by adding an average trade margin of 20% and a value-added tax of 20% to a wholesale price of dried plum halves totalling 350 RSD/kg. The calculations showed that a gross margin of 843,960 RSD (6,861 EUR) and a profit of 729,480 (5,931 EUR) was generated during 40 days of production, using the given purchase and selling prices.

**Key words:** *dried plums, cost price, contribution margin, profit, Serbia.*

### **Introduction**

The industrial significance of plums is determined by their usability, prevalence in the total fruit and agricultural production, share in international trade, production workforce requirements, processing and marketing, as well as their contribution to sustainable agriculture and environmental protection (Lukač Bulatović, 2014). Plums are consumed fresh or used in domestic and industrial processing. According to Vlahović (2003), plums are mostly used for plum brandy production (approximately 65%), processing (21%), fresh (8%) and dried (4%) consumption, whereas the smallest share of plums is utilised in jam production (2%). The Serbian plum production ought to be enhanced by applying contemporary growing and protection technologies.

The development of fruit production in Serbia greatly depends on the prospects of marketing fresh and frozen fruit, as well as processed fruit products. Fruit processing is primarily

focused on producing juices, alcoholic beverages, aromas, jams and marmalades (Lukač Bulatović et al., 2013). Furthermore, there is a possibility of producing dried fruit, which is, with the exception of dried plums, present to a lesser extent on Serbian family farms. An increase in dried fruit consumption in the world emphasizes the potential of domestic dried fruit production. Relative to the available production resources, the dried fruit production in Serbia ought to be enhanced, particularly the production of dried apricots, pears, apples, nectarines, peaches, plums and sour cherries. Contemporary fruit preservation and storage technologies encompass drying as one of the fundamental and most frequently used processes (Živković et al., 2006). There are various fruit drying systems, ranging from the simplest such as direct drying to highly automated systems with predetermined drying parameters. Drying results depend on the quality of dried products and drying costs, which mostly include energy consumption and investments in the facilities and equipment. The development of small and medium-sized enterprises could be substantial in fruit processing, offering a vast array of possibilities to entrepreneurs. Fruit drying is a fruit processing technology with a respectable domestic tradition (Babić et al., 2005). However, traditional drying methods do not meet the quality requirements of contemporary markets as products feature poor organoleptic properties, appearance and marketing (i.e. poor advertising, packaging and design). Regarding plums as a raw material in processing, the purpose of this paper is to examine the principal economic effects of dried plum production on family farms. In order to reduce the plum production costs, certain production lines were located in the immediate vicinity of raw material sources, whereas the final production lines were established near consumer centres.

### **Material and Methods**

One of the most comprehensive and effective technological solutions for drying fruit, based on the combined drying technology, was developed by a group of researchers at the Faculty of Agriculture in Novi Sad. In the initial stage of drying, this technology uses osmotic pretreatments in a sucrose and water solution. Upon reducing the fruit moisture content by one-third to one-half (using osmotic pretreatments), fruit is further dried in a classic heated-air dryer. During the entire process, the temperature of fruit does not exceed 45°C. Drying at lower temperatures preserves high quality and nutritional values of fruit.

This paper examines the major economic impacts of dried plum production using the combined fruit drying technology. The analytical calculations performed were based on the data collected from the fruit drying facility at the Faculty of Agriculture in Novi Sad. The calculations were primarily based on the cost calculation of dried plum production, i.e. the direct variable costs, production value and contribution margin.

The contribution margin (gross margin, marginal result and net income) is the key indicator of business results, particularly from the perspective of short-term decision-making (a period of 1 year). In order to fully investigate the profitability of dried plum production, additional performance indicators were also provided (total costs, revenues and cost prices). An analysis of the main economic indicators was carried out in 2016.

### **Results and Discussion**

The following fruit species can be dried using the equipment designed at the Faculty of Agriculture in Novi Sad and combined drying technology: apricots, peaches, nectarines, vineyard peaches, pears, apples, quinces, plums, sour cherries and cherries. The equipment can also be used for the conventional drying (without osmotic pretreatments) of the following fruit crops: sour cherries, cherries, plums, apples slices (chips), soft fruit and seedless grapes.

In addition to fruit drying, a convective tray dryer is used for drying vegetables, medicinal plants, forest fruits, etc. (Babić Ljiljana et al., 2003).

The cost calculation of dried plum production was made for a dryer with a capacity of 450 kg of fresh plums per day. The drying duration was 40 days with a total of 18,000 kg of fresh plums dried (1 EUR= 123.0 RSD).

The major economic impacts of agricultural production are chiefly reflected in the gross margin (contribution margin, marginal result, contribution margin income, net income, etc.). As an indicator of economic impacts and relative to final financial results, the contribution margin comprises the amount for covering the fixed costs incurred and the amount of the profit generated (Milić i Sredojević, 2004). As an economic indicator, the gross margin is increasingly used in analyzing the business results of a farm. The gross margin indicates the profit of a farm exceeding the production costs (Ivana S. Ivkov et al., 2008).

The gross margin represents the production output (value) reduced by the production-specific variable costs. Chadwick (2000) argues that the gross margin is not profit. The total amount of gross margins of all production lines on a farm is deducted by all the fixed costs incurred in order to calculate the profit of a farm.

The production value reflects the conditions on a farm and the market value of outputs during a fiscal year. The economic effects of a farm depend on production outputs and costs, i.e. financial gains generated by their difference. Moreover, the production value is a result of the production volume and the unit selling price.

Table 1. The cost calculation of dried plum production by cost types

No.	Costs	Units	Amount	Price (RSD)	Total RSD/day	RSD/kg	Structure (%)
1	Fresh plums	kg	450	15	6,750	60.3	32.2
2	Sugar	kg	7.6	60	456	4.1	2.2
3	Water	l	1,000	0.113	113	1	0.5
4	Packaging and etc.				2,860	25.5	13.6
<b>I</b>	<b>Material costs (1-4)</b>				<b>10,179</b>	<b>90.9</b>	<b>48.5</b>
5	Electrical energy	kwh	61.6	8.12	500.2	4.5	2.4
6	Heat energy (straw)	kg	168	3.7	621.6	5.6	3
7	Labour costs	h	40	170	6,800	60.7	32.4
<b>A</b>	<b>VARIABLE COSTS (1-7)</b>				<b>18,100.8</b>	<b>161.7</b>	<b>86.3</b>
8	Equipment and facility depreciation				2,242.4	20	10.7
9	Overhead costs				620	5.6	3
<b>B</b>	<b>TOTAL COSTS (1-9)</b>				<b>20,963</b>	<b>187.3</b>	<b>100</b>
No.	Results	Unit	Amount	Price (RSD)	Value RSD/day	RSD/kg	Cost price
10	Dried plums	kg	112	350	39,200	350	187.3
<b>C</b>	<b>PRODUCTION VALUE (10)</b>				<b>39,200</b>	<b>350</b>	
<b>D</b>	<b>CONTRIBUTION MARGIN (C - A)</b>				<b>21,099.2</b>	<b>188</b>	
<b>E</b>	<b>PROFIT (C - B)</b>				<b>18,237</b>	<b>163</b>	

The material costs, amounting to 90.9 RSD/kg and accounting for 48.5% of the total costs, exerted the most significant effect on the cost price of dried plums (Table 1). The labour costs claimed the second largest share in the total cost structure, amounting to 60.7 RSD/kg and



accounting for 32.4% of the total costs. The energy costs amounted to 10.1 RSD/kg. The fixed costs accounted for 13.7% of the total production costs. The equipment and facility depreciation accounted for 10.7% of the total costs. The overhead costs of dried plum production accounted for 3% of the total costs, and were forecast on the basis of empirical estimates. The cost price of dried plum halves was 187.3 RSD/kg (1.52 €/kg). A retail price of 504 RSD/kg was set for dried plum halves by adding an average trade margin of 20% and a value-added tax of 20% to a wholesale price of dried plum halves totalling 350 RSD/kg. The calculations showed that a gross margin of 843,960 RSD (6,861 EUR) and a profit of 729,480 RSD (5,931 EUR) was generated during 40 days of production, using the given purchase and selling prices.

### **Conclusions**

There is an increase in the production and consumption of dried fruit both in Serbia and the world. The existing volume of fruit drying in Serbia is minute because the traditional drying model is founded upon small family dryers, mostly used for drying plums and apples. A serious technological disadvantage of this model is reflected in the employment of direct drying, which inevitably results in fruit oxidation. Therefore, strict domestic regulations and international standards ought to render such models obsolete by promoting latest drying technologies. The contemporary production of dried fruit in Serbia ought to comply with the international standards and regulations, using stable and inexpensive energy sources. The existing level of fruit drying ought to be enhanced due to the enormous processing potential, which could be exploited on family farms and in small and medium-sized enterprises.

The material costs, amounting to 90.9 RSD/kg and accounting for 48.5% of the total costs, and the labour costs, amounting to 60.7 RSD/kg and accounting for 32.4% of the total costs, exerted the most significant effect on the cost price of dried plums. The cost price of dried plum halves was 187.3 RSD/kg (1.52 €/kg). A retail price of 504 RSD/kg was set for dried plum halves by adding an average trade margin of 20% and a value-added tax of 20% to a wholesale price of dried plum halves totalling 350 RSD/kg. The calculations showed that a gross margin of 843,960 RSD (6,861 EUR) and a profit of 729,480 (5,931 EUR) was generated during 40 days of production, using the given purchase and selling prices.

Dried plums are the most important plum product in Serbia from the nutritional and economic perspective (95% of the total dried plum production is exported). Plums are dried in industrial, mini- and farm dryers. In order to produce high-quality dried plums, indirect drying methods ought to be employed in concurrent-flow dryers. Plum drying encompasses all the requisite procedures leading from fresh plums to final products (packaged and ready for market).

### **Acknowledgment**

This paper is a result of the research within the project 114-451-2601/2016-2, supported by the Provincial Secretariat for Science and Technological Development of the Autonomous Province of Vojvodina and the project TR31058 (2011-2017), supported by the Ministry of Education, Science and Technology of the Republic of Serbia.

### **References**

- Babić LJ., Babić M., Pavkov I. (2003). Coupled osmotic and convective drying of apricot. PTEP - Journal on Processing and Energy in Agriculture, Vol. 7, No 1-2, pp. 1-3.
- Babić M., Babić Lj., Pavkov I. (2005). Energetic and mass balance of combine fruits drying. PTEP - Journal on Processing and Energy in Agriculture, Vol. 9, No 3-4, pp. 54-56.

- Chadwick, L. (2000): The Farm Management Handbook 2000/2001. 21st Edition. The Scottish Agricultural College.
- Ivkov Ivana, Todorović S., Munćan M. (2008): Bruto marža kao značajan pokazatelj poslovanja poljoprivrednih gazdinstava, Tematski zbornik, Agroekonomska nauka i struka u tranziciji obrazovanja i agroprivrede, Poljoprivredni fakultet, Beograd, str.235-244.
- Lukač Bulatović M. (2014). Ekonomska efikasnost proizvodnje i prerade voća, Monografija, Poljoprivredni fakultet, Novi Sad.
- Lukač Bulatović M., Rajić Z., Đoković J. (2013). Development of Fruit Production and Processing in the Republic of Serbia. Journal „Economics of Agriculture“, Vol. 60, No 1, pp. 141-153.
- Milić, D., Sredojević Zorica (2004): Organizacija i ekonomika poslovanja, Poljoprivredni fakultet, Novi Sad.
- Mitrović Olga, Mitrović V., Gavrilović Jelica, Kandić M.: Organizacija sušenja šljive u individualnim gazdinstvima, Zbornik radova, Koštunići, 2000, s. 72-80.
- Živković M., Zarić V., Radojević R. (2006). Cost - benefit analysis of fruits drying using different technical alternatives. PTEP - Journal on Processing and Energy in Agriculture, Vol. 10, No 1-2, pp. 26-28.
- Vlahović B. (2003). Tržište poljoprivredno –prehrambenih proizvoda, Specijalni deo-knjiga II, Poljoprivredni fakultet, Novi Sad.

## GENERAL MATHEMATICAL MODEL FOR THE LINEAR OPTIMIZATION OF A MULTIFUNCTIONAL FARM

Nebojša NOVKOVIĆ\*, Christoph HUSEMANN, Nataša VUKELIĆ

University of Novi Sad, Faculty of Agriculture, Trg Dositeja Obradovića 8, Novi Sad, Serbia

\*Corresponding author: nesann@polj.uns.ac.rs

### Abstract

In this paper, a general mathematical model of the multi-criteria linear programming problem has been developed that can be used to optimize the production processes and services, offered by multifunctional farms. The model comprises the following components: independent variables, the matrix of limitations and two objective functions. The independent variables for plant production, husbandry another processes and services are defined individually. The model also takes into the account internal (production and technology related, biological) limitations as well as external (market related, financial) limitations. The objective functions of the model deal with both, the total maximal effectiveness and the overall efficiency of the farm. The economic effectiveness within the model is represented by the total gross margin (difference of the total income and the direct variable costs), whereas the farm efficiency defined as the quotient of total income divided by the total costs. For solving the model, which deals with the maximization of the total gross margin, a linear optimization method has been applied, while for the maximization of the farm's efficiency a non-linear approach has been utilized. Also, by applying two different optimization methods, two different optimal solutions have been received. Eventually, the farmer must decide, which solution is the most suitable for him/her. The model has been tested on a multifunctional farm in Germany.

**Keywords:** *model, linear optimization, multifunctional farm.*

### Introduction

The paper deals with a multifunctional farm. The aim of the paper is to define a general, theoretical mathematical model for optimization of total farm business operations on the basis of two economic optimality criteria: effectiveness and efficiency. Defining of the mathematical model of production and services (business operations) of a farm is transformation of the actual relevant relations determined for the object of research into a set of logical relations defined by mathematical symbols. Setting a mathematical model is the basis for solving the defined problem of agricultural production structure optimization, by applying exact mathematical methods. The general mathematical model for optimization of the production and service structure of a multifunctional farm encompasses all elements for determining independent variables, the matrix of the constraining conditions and the function of the optimization criteria. Factors which determine to which extent a specific model will adopt all of these parameters for defining dependent variables, constraining conditions and criteria function, include: the available information basis, assessment of how relevant individual parameters are in relation to independent variables and individual constraints, as well as the specific goal of the optimization. These issues were studied thoroughly over the long-term period by the authors of this paper (Šomođi, Novković, 1989; Novković, 1990, Novković, Šomođi, 1991; Novković et al. 2013, Husemann et al. 2012; Paunović et al. 2016).

## Material and Methods

This paper is of a methodological nature. It presents an algorithm for solving of the model set as described above. The method applied for maximization of the effectiveness (net income) is classical linear programming, while the method applied for maximization of the efficiency (cost-effectiveness) is fractional linear programming.

## Results and Discussion

Defining of the general mathematical model includes defining of independent variables, objective function and constraint matrix.

### Independent variables

The mathematical model for optimization of a multifunctional farm can include four types of independent variables: crop production, livestock, primary processing of agricultural products and services.

#### Crop production

$B_{cde}$  = crop area "c", of the variety (hybrid) "d" on the plot "e" (ha)

$B_{cde} \geq 0$ ;  $c = 1(1)i$ ;  $d = 1(1)j$ ;  $e = 1(1)k$ ;

$i$  = the number of crop production lines;  $j$  = the number of varieties / hybrids / individual production lines;  $k$  = the number of plots

#### Livestock

$S_{lmn}$  = the number of structural heads of the livestock production line "l", of the breed "m", in the livestock keeping conditions "n"

$S_{lmn} \geq 0$ ;  $l = 1(1)p$ ;  $m = 1(1)r$ ;  $n = 1(1)s$

$p$  = the number of livestock production lines;  $r$  = the number of breeds of certain livestock types;  $s$  = the number of different livestock keeping conditions

#### Primary processing

$P_g$  = the annual volume of the processed product "g" (unit of measure)

$P_g \geq 0$ ;  $g = 1(1)q$ ;  $q$  = the number of types of processed products

#### Services

$U_t$  = the type of the service "t"

$U_t \geq 0$ ;  $t = 1(1)y$ ;

$y$  = the number of different types of services

### Objective function

Maximum economic effectiveness is typically the objective function in the models of linear programming. In order to meet the demands of linearity, net income (gross margin), i.e. the difference between the production value and direct variable costs, is usually taken as a category which represents economic effectiveness. If all direct variable costs (costs of direct material, services and labor) are taken into account when determining the net income, then determination of the maximum net income is an indicator of the maximum profit; and if the cost of the farmers' own labor is not included into the calculation (as it is the case with farms), then the net income indicates the maximum earnings, i.e. newly generated values.

The other, equally important economic goal of business operations of agricultural business systems is efficiency. The basic measure of production and business efficiency is cost-effectiveness. Cost-effectiveness, as the ratio between the total income and total operating costs of the farm, is an economic category, which indicates to which degree the investments

in the production process and the business process are efficient. It is different from maximization of the net income, where fixed costs in the short term have no impact on the optimal production structure in determining the maximum cost-effectiveness.

Production effectiveness, measured by the net income, and production efficiency, measured by cost-effectiveness, are not mutually proportional categories. Since effectiveness is a measure of the absolute performance and efficiency is a measure of the relative performance of the production process, both categories are equally important economic objectives that must be taken into account in the planning process.

Maximum business effectiveness of a multifunctional farm:

$$\sum_{c=1}^i \sum_{d=1}^j \sum_{e=1}^k np_{cde} B_{cde} + \sum_{l=1}^p \sum_{m=1}^r \sum_{n=1}^s np_{lmn} S_{lmn} + \sum_{g=1}^q np_g P_g + \sum_{t=1}^y np_t U_t = NP_{max}$$

$np_{cde}$  = planned net income per hectare;  $np_{lmn}$  = planned annual net income per structural head;  $np_g$  = planned annual net income per processing unit ;  $np_t$  = planned annual net income per unit of service;  $NP_{max}$  = maximum total net income of the farm

Maximum production efficiency:

$$\frac{\sum_{c=1}^i \sum_{d=1}^j \sum_{e=1}^k up_{cde} B_{cde} + \sum_{l=1}^p \sum_{m=1}^r \sum_{n=1}^s up_{lmn} S_{lmn} + \sum_{g=1}^q up_g P_g + \sum_{t=1}^y up_t U_t}{\sum_{c=1}^i \sum_{d=1}^j \sum_{e=1}^k vt_{cde} B_{cde} + \sum_{l=1}^p \sum_{m=1}^r \sum_{n=1}^s vt_{lmn} S_{lmn} + \sum_{g=1}^q vt_g P_g + \sum_{t=1}^y vt_t U_t + FT} = Ek_{max}$$

$up_{cde}$  = planned total income per hectare;  $up_{lmn}$  = planned annual total income per structural head;  $up_g$  = planned annual total income per processing unit;  $up_t$  = planned annual total income per unit of service;  $vt_{cde}$  = planned variable costs per hectare;  $vt_{lmn}$  = planned annual variable costs per structural head;  $vt_g$  = planned annual variable costs per processing unit;  $vt_t$  = planned annual variable costs per unit of service;  $FT$  = total fixed costs of the farm;  $Ek_{max}$  = maximum cost-effectiveness of the farm

#### Constraint matrix

For most farms, important constraining factors include the available area of the farm, labor or working hours, time spent using mechanization, animal reproduction rate and market sales. However, certain less obvious factors, such as planned crop rotation, also constrain the extent of the farmer's freedom in decision-making (Novković 1988).

##### 1. Capacity constraints

###### Constraints of the land

$$\sum_{c=1}^l \sum_{d=1}^j B_{cde} = P_e$$

$P_e$  = available area of the land of the plot “e” in hectares

###### Constraints of livestock capacity

$$\sum_{m=1}^r S_{imn} \leq K_{ln}$$

$K_{ln}$  = available capacity for keeping livestock of the production line “l” in the keeping conditions “n” in structural heads.

**Processing capacity**

$$P_g \leq K_g$$

$K_e$  = available capacity for processing of the product “g”

- **Service capacity**

$$U_t \leq K_t$$

$K_t$  = available capacity of the service “t”.

2. Biotechnological constraints

$$\sum_{d=1}^j \sum_{e=1}^k B_{cde} \leq c_c \sum_{e=1}^k P_e$$

$c_c$  = coefficient of the maximum share of the crops  $B_c$  in the total area of the farm

3. Maximum (minimum) placement constraints

**Crop production**

$$\sum_{d=1}^j \sum_{e=1}^k q_{cde} B_{cde} \begin{matrix} \geq \\ < \end{matrix} Q_c$$

$Q_c$  = maximum possible (minimum required) amount of the product “c” that can be placed on the market in kg;  $q_{cde}$  = technical coefficient, which indicates the yield of the crop “c”, of the variety / hybrid “d” on the plot “e” in kg/ha.

**Livestock**

$$\sum_{m=1}^r \sum_{n=1}^s q_{lmn} S_{lmn} \begin{matrix} \geq \\ < \end{matrix} Q_l$$

$Q_l$  = maximum possible (minimum required) amount of the livestock product “l” that can be placed on the market (kg, l, head)

$q_{lmn}$  = technical coefficient, which indicates the yield of the livestock product “l”, of the breed “m” in the keeping conditions “n” in kg (l, head)/structural head.

**Processing**

$$P_g \begin{matrix} \geq \\ < \end{matrix} P_{gu}$$

$P_{gu}$  = maximum possible (minimum required) amount of the product “g” that can be placed on the market in appropriate units of measure.

**Services**

$$U_t \begin{matrix} \geq \\ < \end{matrix} U_{tu}$$

$U_{tu}$  = maximum possible (minimum required) amount of the service “t” that can be placed on the market in appropriate units of measure.

4. Constraints linking interdependent production lines

### Crop production – Livestock

$$\sum_{d=1}^j \sum_{e=1}^k q_{cde} B_{cde} - \sum_{l=1}^p \sum_{m=1}^r \sum_{n=1}^s c_{lmn} S_{lmn} = 0$$

$c_{lmn}$  = technical coefficient, which indicates the annual demand of the structural heads of the livestock production line “l”, of the breed “m” in the keeping conditions “n”, for the field crop product “c”.

The number of such constraints in the model will be equal to the number of the field crops used as raw materials for the farmer’s own livestock production.

### Crop production – Processing

$$\sum_{d=1}^j \sum_{e=1}^k q_{cde} B_{cde} - \sum_{g=1}^q c_g P_g \geq 0$$

$c_g$  = technical coefficient, which indicates the annual demand of the processed product “g” for the field crop product “c”.

### Crop production – Services

$$\sum_{d=1}^j \sum_{e=1}^k q_{cde} B_{cde} - \sum_{t=1}^y c_t U_t \geq 0$$

$c_t$  = technical coefficient, which indicates the annual demand of the service “t” for the field crop product “c”.

### Livestock production – Processing

$$\sum_{m=1}^r \sum_{n=1}^s q_{lmn} S_{lmn} - \sum_{g=1}^q l_g P_g \geq 0$$

$l_g$  = technical coefficient, which indicates the annual demand of the processed product “g” for the livestock product “l”.

### Livestock production – Services

$$\sum_{m=1}^r \sum_{n=1}^s q_{lmn} S_{lmn} - \sum_{t=1}^y l_t U_t \geq 0$$

$l_t$  = technical coefficient, which indicates the annual demand of the service “t” for the livestock product “l”.

### Processing – Services

$$P_g - \sum_{t=1}^y g_t U_t \geq 0$$

$c_t$  = technical coefficient, which indicates the annual demand of the service “t” for the processing product “g”.

### 5. Constraints of direct labor

$$\sum_{c=1}^l \sum_{d=1}^j \sum_{e=1}^k r_{cde} B_{cde} + \sum_{l=1}^p \sum_{m=1}^r \sum_{n=1}^s r_{lmn} S_{lmn} + \sum_{g=1}^q r_g P_g + \sum_{t=1}^y r_t U_t \leq R_u$$

$r_{cde} / r_{lmn} / r_g / r_t$  = technical coefficient, which indicates the required annual number of working hours per capacity unit of crop production / livestock / processing;  $R_u$  = total available annual number of working hours of direct labor.

Since agricultural production is seasonal, it is possible to set constraint for certain periods of working peaks.

### 6. Constraints of operative mechanization

$$\sum_{c=1}^l \sum_{d=1}^j \sum_{e=1}^k mk_{cde}^t B_{cde} \leq MK^t$$

$mk_{cde}^t$  = technical coefficient, which indicates the required number of working hours of the category of operative mechanization “mk”, per hectare of the independent variable in the time period “t”;  $MK^t$  = total available number of working hours of the category of operative mechanization in the time period “t”.

## Conclusion

The general mathematical model for optimization of business operations on multifunctional farms represents a theoretical basis for constructing specific models of optimization on individual farms. Application of this model is useful because it provides the farmer with the possibility to choose between two optimal variants, as well as to define one’s maximum economic potential. Application of this model requires a good information basis, as well as constant monitoring of business activities on the farm and monitoring of external conditions and possibilities (price, placement...).

## References

- Novković, N. (1990) Optimiranje poljoprivredne proizvodnje na bazi više kriterijuma optimalnosti (Multiple criteria programming implementation in agriculture production), Institut za ekonomiku poljoprivrede i sociologiju sela, Poljoprivredni fakultet, Novi Sad
- Novković, N. Šomodji, Š. (1991) Multiple criteria programming implementation in the integral production planning in the agricultural enterprises of Yugoslavia, Zbornik radova 20. konferencije CIRET, Budimpešta, 351-373
- Novkovic, N., Krasnic, T, Nikolic, G.(2013): Optimalization of vegetables for consume in fresh condition producion structure, Fourth International Scientifi Symposium "Agrosym 2013" – Book of Proceedings, University of East Sarajevo, Faculty of Agriculture, BIH; University of Belgrade, Faculty of Agriculture, Serbia, Jahorina, str. 1320-1325
- Paunović, T., Novković, N., Ceranić, S. (2016): Optimization model of vegetable production structure in Serbia, AGROFOR International Journal, Volume 1, Issue No 3, page 104-109; ISSN 2490-3434; ISSN 2490-3442 – Online DOI: 10.7251/AGRENG1603104P
- Husemann, Ch., Novkovic, N., Vukelic, N (2012): The Model of Farm Management Information System: A Case-Study of Diversified German Farm, DETUROPE, Central



European Journal of Regional Development and Tourism, University of South Bohemia in České Budejovice, Faculty of Economics, Czech Republic, University of Pannonia Georgikon, Faculty Keszthely Hungary, Regional Science Association of Subotica, Serbia, Volume 4, Issue 1, str.76-90,

Šomodji, Š. Novković, N. (1989) Optimalization of economic relation in a reproduction chain for meat production, Zbornik radova 21. seminara EAAE o integraciji i kooperaciji u agroindustriji, Kijev - Ukrajina, 466-474

## **INTAGIBLE ASSETS IN THE RETAIL FOOD**

Radojko LUKIC<sup>1\*</sup>, Srdjan LALIC<sup>2</sup>, Nedeljko TICA<sup>3</sup>

<sup>1</sup> Faculty of Economics, Belgrade, University of Belgrade, Serbia

<sup>2</sup> Faculty of Economics, Brcko, University of East Sarajevo, Bosnia and Herzegovina

<sup>3</sup> Faculty of Agriculture, University of Novi Sad, Serbia

\*Corresponding author: rlukic@ekof.bg.ac.rs

### **Abstract**

There is growing importance of econometric analysis of intangible assets impact on the performance of companies, what seems apprehensive concerning the innovations, new technologies, brand, knowledge and other components of intangible assets for improving the companies' performance. To our knowledge, there are a few papers dedicated to the research of specifics of intangible assets impact on the performance of trading and retailing companies, food retailers, respectively. One of the reasons for this we find in lack of adequate data, especially for econometric analysis, because many companies do not enclose full data on intangible assets in their financial reports, or do it partially. Taking all this into account, we intend to elaborate the specifics and impact of intangible assets on the performance of global food retailers, with particular emphasis on Serbia. We ground our research on theoretical and methodological knowledge and reliable empirical data. The aim of the research is to thoroughly elaborate on theoretical and practical issues of non-material assets in retail. The knowledge of significance and the structure of non-material assets is fundamental prerequisite for its efficient management so as to meet the desired profit in concrete retail food company. As far as we know, there are no fully written papers dedicated to the analysis of intangible assets in retail food, especially in Serbia, in what we find our contribution to the treated problems. There is growing contemporary literature written on the general analysis of intangible assets of companies, both from the accounting point of view, and from its influence on performance. Nevertheless, as far as we know, there are no fully written papers dedicated to the analysis of specifics of size and structure of intangible asset in retail food. We strive to research the issue, especially on the examples of global, and food retailers in Serbia, in what we find scientific and professional contribution of this paper. Adequate managing of intangible investment can fulfil the desirable profits of retailing companies. Under the influence of different factors, above all technology innovations, development of private brand and advancement of knowledge, the share of intangible assets in total assets in trade and retail (food) differs among countries. So, for example share of intangible assets in total assets of retail (food) companies in Serbia is significantly lower compared to countries of developed market economies. It reflects their overall performance. That is why there should be more investments in creating intangible assets, especially private brand, information and communication technologies and advancement of knowledge. (**Jel classification:** L810, M420, Q320)

**Key words:** *innovation, customers, brand, technology, knowledge.*

### **Introduction**

Intangible assets have profound influence on company's value, productivity of work (Marrocu, 2011) and performance in trading companies (including retailing, food retailers). Due to that, detailed analysis of the impact of intangible assets on the performance of

companies is given a considerable importance. Starting with the significance of the issue, this paper lay emphasis to specifics and the impact of intangible assets on the performance of trading, especially retailing companies, food retailers. We aim at pointing that managers can exert its influence in improving the desired profits of trading companies (Christine, 2015), food retailers. Innovations, human resources, intellectual capital, information, goodwill etc. are regarded as crucial factors of creating companies' value and sustainable growth (Sorescu et al., 2011; Greuning, 2011; Vidracsu, 2015; Lev, 2004; Villalonga, 2004; Acito, 2007; Marrocu, 2011; Lukic et al., 2016; Lukic, 2017). In its character, they are nothing else than the elements of non-material investment (intangible assets), and inasmuch as of this, careful research attention is devoted to them in theory and practice. We will draw our attention to the specifics of their impact on the performance in retail food globally, and particularly in Serbia. The aim of the analysis is to point to the significance of managing intangible assets so as to accomplish targeted profit of retail companies, food retailers. The aim of the research is to thoroughly elaborate on theoretical and practical issues of non-material assets in retail (food). The knowledge of significance and the structure of non-material assets is fundamental prerequisite for its efficient management so as to meet the desired profit in concrete retail (food) company. As far as we know, there are no fully written papers dedicated to the analysis of intangible assets in retail (food), especially in Serbia, in what we find our contribution to the treated problems. There is growing contemporary literature written on the general analysis of intangible assets of companies, both from the accounting point of view, and from its influence on performance. Nevertheless, as far as we know, there are no fully written papers dedicated to the analysis of specifics of size and structure of intangible asset in retail (food). We strive to research the issue, especially on the examples of global, and (food) retailers in Serbia, in what we find scientific and professional contribution of this paper. The primary hypothesis of the research is increasing significance of intangible assets on the performance of global (food) retailers. For that reason, it is necessary to manage non-material assets more effectively. Given hypothesis is also confirmed through empirical research conducted in retail (food) companies in Serbia.

### **Material and Methods**

Basic methodology of research is founded on comparative analysis, ratio analysis and statistical analysis. For the sake of implementation of econometric analysis in the future it is necessary to develop unique enclosure system of intangible assets in financial reports of retail companies, especially in Serbia. It will contribute to better analysis of non-material assets in retail (food). (Primary restriction of research in this work is reflected in notion that reliable empirical data are not fully comparable since retail companies differently enclose data in financial reports. Partially, it was due to frequent normative change of International standards for financial reporting and others. Nevertheless, we consider that research results in this work can serve as basis for further theoretical, methodological and empirical analysis of the given issue, and especially to managers in retail to efficiently manage the non-material assets so as to make desired profit. In that we also find scientific and professional contribution of this paper.) Relevant data for the research in this work were collected from different sources, such as: literature, studies, papers, annual financial reports of analysed retail companies. Web sites also served as sources (Brand Finance, GIFT (Global Intangible Financial Track) 2016, May 2016; available at: [http://brandfinance.com/images/upload/gift\\_report\\_2016\\_for\\_print.pdf](http://brandfinance.com/images/upload/gift_report_2016_for_print.pdf) (September 20, 2016) and (KPMG – The Application of IFRS: Retail companies, March 2013; available at: <https://www.kpmg.com/Global/en/IssuesAndInsights/ArticlesPublications/ILine-of-Business-publications/Documents/LOB-retail-companies-march13.pdf> (September 27, 2016). Data on

trade and analysed retail companies in Serbia we collected from Business registers Agency of the Republic of Serbia.

### Results and Discussions

The structure of assets in retail (food) is specific compared to other economy sectors, and so is the structure of intangible assets. This is due to the nature of its business – bulk purchasing and selling in small quantities of goods, primarily to end customers (Acito, (2007). In accordance with specifics of business operation in retail (food), there is system of (ratio) indicators of intangible value that has been developed (Acito, (2007). Adequate measure of intangible assets' contribution to the market value is considered to be Tobin's  $q$  ratio (Dybvig, 2010). It is defined as relation of firm market value and its assets replacement value, i.e. Tobin's  $q = \text{Total market value of firm} / \text{Total assets value of firm}$  Reduced version of Tobin's Q ratio is: Tobin's  $q$  ratio = Market equity value / Account equity value In contrast to return on equity, as a measure of past firm performance, Tobin's  $q$  ratio refers to measurement of firm performance in the future (Villalonga, 2004; Acito, 2007). Table 1 illustrates top ten retailers by Q ratio.

Table 1. Top ten retailers by Q ratio

Company	Country	Q ratio
H & M Hennes & Mauritz AB	Sweden	6.465
Tractor Supply Company	U.S.	5.176
BİM Birleşik Mağazalar A.Ş.	Turkey	4.759
Next plc	U.K.	4.679
Inditex, S.A.	Spain	4.570
Dollar Tree, Inc	U.S.	4.514
Nike, Inc.	U.S.	4.353
The TJX Companies, Inc.	U.S.	4.338
Ross Stores, Inc.	U.S.	4.331
Fast Retailing Co., Ltd.	Japan	3.951

Source: Deloitte. Global Powers of Retailing 2015 Embracing innovation, available at: [https://www2.deloitte.com/content/dam/Deloitte/fpc/Documents/secteurs/consumer-business/deloitte\\_global-powers-of-retailing\\_2015-en.pdf](https://www2.deloitte.com/content/dam/Deloitte/fpc/Documents/secteurs/consumer-business/deloitte_global-powers-of-retailing_2015-en.pdf) (September 30, 2016)

As we can see, retailers which prevail by Q ratio come from the United States of America. There are major differences in food retail between retailers in relation to Q ratio. This is shown by the data in Table 2.

Table 2. Tobin's Q ratio of food retailers

Food retailer	2000	2005	Changes
Whole Foods Market	2.53	5.71	3.18
SuperValu	0.56	1.08	0.52
Ingles Markets	0.76	0.97	0.21
Albertsons	1.09	0.82	-0.27
Winn-Dixie	1.02	0.59	-0.43
Ahold USA	1.46	0.86	-0.60
Kroger	1.65	0.98	-0.67
Safeway	2.30	0.99	-1.31

Source: Acito, (2007)

Altogether, Tobin's Q ratio is adequate measure of intangible assets and its impact on market value of retail companies. Non-material assets have been significant factor of performance in economy, especially in trade sector and retail (Yu, 2014, Mohr, 2014). There are differences

among countries concerning intangible assets in service and retail sector and their share in gross domestic product. So, for example, share of non-material assets in gross domestic product in retail, hotel and transport amounted as follows: Japan 2.7% (2010), Korea 2.1% (2010), Germany 3.5% (2004), and UK 6.4% (2004) (Chun, 2015). Likewise, it differs among retail companies, types of store and category of products. Under influence of numerous controlled and uncontrolled factors, intangible assets in retail are dissimilar from country to country. Table 3 show non-material assets and intellectual capital of retail in the US for 2009.

Table 3. Non-material assets and intellectual capital in U.S. retail, 2009

	Intangible assets as a share of market value (%)	Intellectual capital on and off the balance sheets (\$ billions)	Intellectual capital share in market value (%)	Economic competence on and off the balance sheets (\$ billions)	Intangible assets: Intellectual capital + Economic competence (\$ billions)
Retail	78.4%	\$267	43.69%	\$211	\$478
Food retail	75.3%	\$161	41.97%	\$128	\$288

Source: Hassett, (2011)

We came to conclusion that the share of non-material assets in market value of US retail is high, what is also the case in other countries with developed market economy. The fact that speaks in that favour is growing share of private brands in contemporary retail (Kelle, 2006). In other words, there is emerging power of brand as a component of non-material asset in retail. So, for example, in February 2016 the value of brand (in million dollars) of selected retail companies amounted: Wal-Mart (US) 53,657, Home Depot (US) 28,798, CVS Caremark (US) 22,891, IKEA (Sweden) 17,009, Target (US) 15,331, Aldi (German) 14,552, Lowe's (US) 12,712, Tesco (UK) 12,499 (According to: Brand Finance: Global 500 2016, The annual report on the world's most valuable brands, February 2016, available at: [http://brandfinance.com/images/upload/global\\_500\\_2016\\_for\\_print.pdf](http://brandfinance.com/images/upload/global_500_2016_for_print.pdf)) (September 21, 2016). To a great extent it determines the performance of global retail companies. There are also significant investments in development of new information and communication technologies and knowledge advancement (competences) of the employed in retail. Share of intangible assets in market value is also high in all companies (Vidrascu, 2015), including retailing. Table 4 shows the non-material value (assets) of selected retailers.

Table 4. The estimate of intangible assets of selected retail companies, (September 22), 2016

Company	Market value ( billion dollars)	Accounting value ( billion dollars)	Non-material value ( billion dollars)	Share of non-material value in market value
Wal-Mart	222,62	83,61	139,01	62.44%
Home Depot – non food	156,71	6,32	149,68	95.51%
Target	39,45	12,96	26,49	67.14
Tesco	18,38	8,62	9,76	53.10%
Kroger	36,88	6,80	30,08	81.56

Note: Calculation performed by the author based on the data: Market Watch: Stock Market News - Financial News; We mark market value of firm with MV and accounting value with A, we came up with: Non-material assets = (MV – A). Source: <http://www.marketwatch.com/> (September 22, 2016)

The data in the given table show high share of non-material value (assets) in market value of presented retailing companies. Therefore, it belongs to important factors of business success of the observed companies. The similar trend is with the other companies that operate on the global level. In order to thoroughly envisage the importance of non-material assets in retail, Table 5 shows the share of non-material assets in total assets of selected retailing companies for the period 2011 – 2015.

Table 5. Share of non-material assets in total assets of selected retail companies, 2012 – 2015

Company	2012	2013	2014	2015
Wal-Mart	10.67%	10.09%	9.52%	9.09%
Home Depot – non food	2.76%	2.84%	3.18%	3.39%
Costco	-	23.14%	23.22%	23.03%
Target	0.25%	0.22%	0.74%	0.72%
Tesco	9.09%	8.69%	7.57%	8.52%
Marks & Spencer	8.03%	9.13%	10.22%	10.46%

Note: Calculation performed by the author based on annual reports. Source: <http://www.marketwatch.com/> (September 23, 2016)

Data in the given table show great share of non-material assets in total assets in retail companies Wal-Mart, Tesco and Marks & Spencer, in what we recognize the fact that those companies have major investments in innovation, as crucial factor of business success.

In order to deeply contemplate the importance of intangible assets in retail we will analyse data from company Fast Retailing. U Table 6 shows the data on intangible assets of company Fast Retailing for the period 2013 – 2015.

Table 6. Share of intangible assets in total assets of the company Fast Retailing, 2013 – 2015

	2013	2014	2015
Goodwill	4.10%	2.69%	2.33%
Other intangible assets	5.86%	4.73%	3.52%

Note: Calculation performed by the author. Source: Fast Retailing – Annual Report, available at: [http://www.fastretailing.com/eng/ir/financial/bs\\_5yrs.html](http://www.fastretailing.com/eng/ir/financial/bs_5yrs.html) (October 4, 2016)

The data derived from this table indicate that the share of intangible assets (Goodwill and other intangible assets) in total assets of the company Fast Retailing is less compared to Wal-Mart and Mark & Spencer.

Unlike the trade sector, information and communication (IT) sector is unique to intangible assets influence on performance. As illustration, we will analyse the world wide known company Apple, which has very high level of intangible assets share in its economic value.

Data in the table show that In company Apple intangible assets participate in total value with 49%, what is very significant from the impact on total performance point of view. The peculiar is that only 3.4% of intangible assets is disclosed. As crucial factors of business performance, share of technology and marketing is substantial in the structure of intangible assets. Also, there is major share of brand value in total intangible assets. ( Source: [http://brandfinance.com/images/upload/gift\\_report\\_2016\\_for\\_print.pdf](http://brandfinance.com/images/upload/gift_report_2016_for_print.pdf) (September 19, 2016) Given the fact that Delhaize Group (as part of Ahold Delhaize from 2016) does business in Serbia with important market share, we will analyse in detail its non-material assets with special insight into one of its entities which does business in Serbia (Delhaize Serbia). Table 7 show data on Goodwill and intangible assets share in total assets of Delhaize Group for the period of 2013 – 2015.

Table 7. Percentage share of Goodwill and intangible assets in total assets of company Delhaize Group, 2013 – 2015

	2013	2014	2015
Share of Goodwill in total assets (%)	25.52%	25.95%	26.58%
Intangible assets share in total assets (%)	6.31%	6.29%	6.13%
Intangible investment depreciation share in gross margin (%)	0.57%	0.56%	0.48%

Note: Calculation performed by the author based on Annual Report 2015 data

Source: Delhaize Group – Annual Report 2015, available at: [https://annualreport.delhaizegroup.com/wp-content/uploads/2016/04/160407\\_DLZ\\_RA15\\_UK\\_WEB.pdf](https://annualreport.delhaizegroup.com/wp-content/uploads/2016/04/160407_DLZ_RA15_UK_WEB.pdf) (October 3, 2016)

According to the data showed in the table, share of intangible assets in total assets is slightly higher than 6%. It is lower than in Wal-Mart (2015 – 9.09% ) and Marks & Spencer (2015 – 10.46%). Intangible investment depreciation share in gross margin ranges from 0.48 – 0.57%. It is similar to other retail companies in the world (for example, Russia).

In order to envisage the trends of intangible assets development in Delhaize Group, Table 8 shows data on its market capitalisation for the period 2011 – 2015.

Table 8. Market capitalisation of company Delhaize Group, for the period 2011 – 2015

	2011	2012	2013	2014	2015
Market capitalisation (million €, end of year)	4423	3083	4425	6213	9339
Enterprise value (million €, end of year)	7082	5155	5899	7210	10119
Total capital (million €, end of year)	5416	5186	5073	5453	6171
Intangible assets (million €, end of year)*	-993	-2103	-648	760	3168
Intangible value share in market capitalisation (%)*	-22.45%	-68.21%	-14.64%	12.23%	33.92%

Note: Value of enterprise = Market capitalisation plus net debt. Net debt = Financial obligations minus cash. Financial obligations = Short-term loans plus long-term loans. \*Calculation performed by the author. Source: Delhaize Group – Annual Report 2015, available at: [https://annualreport.delhaizegroup.com/wp-content/uploads/2016/04/160407\\_DLZ\\_RA15\\_UK\\_WEB.pdf](https://annualreport.delhaizegroup.com/wp-content/uploads/2016/04/160407_DLZ_RA15_UK_WEB.pdf) (October 3, 2016)

In the given table intangible assets is measured as difference between market capitalisation and total assets (as a measure of accounting value of the firm). It shows the tendency of positive increase in the last two years of the analysed period, what positively reflects in the performance of company Delhaize Group. Table 9 shows intangible assets of company Delhaize Serbia, (part of Ahold Delhaize since 2016) in 2014 and 2015.

Table 9. Intangible assets of company Delhaize Serbia, 2014 and 2015

	2014	2015	Index 2015/2014*
Intangible investment (000 RSD)	3,942,314	4,785,547	121,35
Goodwill	197,432	197,432	100,00
Depreciation of intangible investments	88,900	82,521	92,82
Material physical assets	35,895,916	38,945,414	107,65
Total assets	66,600,435	73,304,405	110,06
Total business expenses	71,646,608	73,853,030	103,07
Share of intangible assets in total assets (%)*	5.91%	6.52%	110,32
Relation between intangible assets and material physical assets*	0,1096 (10.98%)	0,1228 (12.28%)	111,83 (111,29)
Share of Goodwill in total assets (%)*	0.29%	0.26%	89,65
Share of depreciation of intangible assets in total operating expenses (%)*	0.12%	0.11%	91,66

Note: \* Calculation performed by the author. Source: Delhaize Serbia Ltd., Belgrade, Notes to financial statements 31. December 2015. Business registers agency, The Republic of Serbia

According to the data in the given table, intangible assets in 2015 in Delhaize Serbia increased by 21.35% compared to 2014. The share of intangible assets in total assets of company Delhaize Serbia is on the level of parent company, considerably higher compared to average of total trade in Serbia, but it is lower in relation to companies such as Wal-Mart and Tesco. All in all, it has positive effect on its total performance, considering intangible assets as crucial factors of business success.

In order to enlighten the specifics of accounting treatment of intangible assets we will bring one case from concrete trading practice. So, for example retail company Delhaize Serbia applies the following concept of accounting treatment of intangible assets: "Intangible assets are non-monetary assets (they do not represent tangible physical assets) such as patents, licences, concessions, trademarks, hallmark, accounting software, franchise, investment in development of new products, processes and devices, copyright and other. There is a possibility that there will be an economic benefit for these resources in the period longer than one year, to the amount that exceeds costs. Intangible assets are initially measured by purchase price or cost price. After initial recognition, intangible assets are expressed as cost less accumulated depreciation and impairment. The right to use the land, even though it is limited to 99 years, due to the very essence and the anticipated conversion to ownership of the land, the Company is considered to have an indefinite useful life on land and after the expiry of this period, it has opportunity to turn the right to use to the right of ownership of construction land, without compensation. Subsequent expenditure on investments in intangible assets can be capitalized only regarding the expected future benefits of assets they refer to. All other expenses represent expenses for the period in which they were made. Depreciation of intangible assets starts with the following month in relation to the month in which the assets were available for use. The basis for depreciation is purchase price. Intangible assets are depreciated on straight-line method within five years, with depreciation rate of 20%. Depreciation method and useful life is estimated at the end of each reporting period and when necessary, they are corrected" (According to: Delhaize Serbia Ltd., Belgrade, Notes to financial reports 31. December 2015. Business registers agency, The Republic of Serbia). In 2015 depreciation rate of intangible assets in Delhaize Serbia was



20%, and the estimated lifetime 5 years (According to: Delhaize Serbia Ltd., Belgrade, Notes to financial reports 31. December 2015. Business registers agency, The Republic of Serbia). In the same (2015) year, depreciation of intangible assets participated in total expenditures with 0.060% (Calculation performed by the author based on the data: Delhaize Serbia Ltd., Belgrade, Notes to financial reports 31. December 2015. Business registers agency, The Republic of Serbia). The situation is similar in other retailing companies in Serbia (Mercator-S, IDEA). The share of intangible investment depreciation in total expenditures in trade is insignificant, and differs among countries. For example, in Russia 2014 it amounted: motor vehicle and repair 0.10%, wholesale 0.10%, retail 0.50% and social nutrition 0.40% (Torgovia v Rossii 2015, Statističeskij sbornik, Moskva, 2015).

### **Conclusion**

Intangible assets gradually became crucial factor of retail companies' business success. There is increasing share of intangible assets in trade value and total assets of global (food) retailers. It specially refers to innovation, brand, knowledge and technology. Special system of intangible investments indicators for trading business was developed, within which more attention is paid to Tobin's Q ratio. Fundamental prerequisite for efficient managing is integrated approach in the analysis of indicators of intangible assets in retail (food) (based on econometric analysis). Adequate managing of intangible investment can fulfil the desirable profits of retailing companies. Under the influence of different factors, above all technology innovations, development of private brand and advancement of knowledge, the share of intangible assets in total assets in trade and retail (food) differs among countries. So, for example share of intangible assets in total assets of retail (food) companies is Serbia is significantly lower compared to countries of developed market economies. It reflects their overall performance. That is why there should be more investments in creating intangible assets, especially private brand, information and communication technologies and advancement of knowledge.

### **References**

- Acito, F. and Williams, T.D. (2007). Positioning the Retail Firm for Future Value – Recognizing and Measuring Intangible Assets. The Centre for Education and Research in Retailing, Kelle School of Business, Indiana University.
- Christine, D., Devie, W. and Tarigan, J. (2015). The Impact of Employee Satisfaction on Profitability in Fashion Retail Business in Indonesia. *World Applied Sciences Journal*, 33(99), 1533-1538.
- Chun, H., Tsutomu, M., Pyo, H.K. and Konomi, T. (2015). Do Intangibles Contribute to Productivity Growth in East Asian Countries? Evidence from Japan and Korea? RIETI *Discussion Paper Series* 15-E-055.
- Delhaize Serbia Ltd., Belgrade, Notes to financial reports 31. December 2015. Business registers agency, The Republic of Serbia.
- Delhaize Group – Annual Report 2015, available at: [https://annualreport.delhaizegroup.com/wp-content/uploads/2016/04/160407\\_DLZ\\_RA15\\_UK\\_WEB.pdf](https://annualreport.delhaizegroup.com/wp-content/uploads/2016/04/160407_DLZ_RA15_UK_WEB.pdf) (October 3, 2016).
- Deloitte. Global Powers of Retailing 2015 Embracing innovation, available at: [https://www2.deloitte.com/content/dam/Deloitte/fpc/Documents/secteurs/consumer-business/deloitte\\_global-powers-of-retailing\\_2015-en.pdf](https://www2.deloitte.com/content/dam/Deloitte/fpc/Documents/secteurs/consumer-business/deloitte_global-powers-of-retailing_2015-en.pdf) (September 30, 2016).

- Dybvig, P. H., & Warachka, M. (2010). Tobin's Q Does Not Measure Performance: Theory, Empirics, and Alternative Measures. Paper. Washington University in Saint Louis, Olin School of Business; Singapore Management University, L.K.C. School of Business.
- Greuning, H. V., Scott, D. and Terblanche, S., (2011). *International Financial Reporting Standards, A Practical Guide*. Sixth Edition, The Washington, D.C. Global Intangible Financial Track) 2016, May 2016. available at: [http://brandfinance.com/images/upload/gift\\_report\\_2016\\_for\\_print.pdf](http://brandfinance.com/images/upload/gift_report_2016_for_print.pdf) (September 20, 2016).
- Hassett, K. A. and Shapiro, R.J (2011). What Ideas Are Worth: The Value of Intellectual Capital And Intangible Assets in the American Economy. Sonecon. Internet source: [http://brandfinance.com/images/upload/gift\\_report\\_2016\\_for\\_print.pdf](http://brandfinance.com/images/upload/gift_report_2016_for_print.pdf) (September 19, 2016).
- Ivanov, G. and Mayorova, E. (2015). Intangible Assets and Competitive Advantage in Retail: Case Study from Russia, *Asian Social Science*, 11 (12), 38-44.
- Keller, K.L. and Lehmann, D.R. (2006). Brands and Branding: Research Findings and Future Priorities. *Marketing Science* 25 (6) (November / December), 740-759.
- KPMG – The Application of IFRS: Retail companies, March 2013; available at: <https://www.kpmg.com/Global/en/IssuesAndInsights/ArticlesPublications/ILine-of-Business-publications/Documents/LOB-retail-companies-march13.pdf> (September 27, 2016)
- Lev, B. and Daum, J. H.(2004).The dominance of intangible assets: consequences for enterprise management and corporate reporting. *Measuring Business Excellence*, 8(1),6-17.
- Lukic, R. and Vojteski Kljenak, D. (2017). Analysis of Intangible Assets in Retail Trade. *Strategic Management*, 22(2), 18-26.
- Lukic, R., Lalic, S. and Vojteski Kljenak. D. (2016). Research and Development Costs in Retail Trade. *Management and Economics Review*, 1(2), 170-183.
- Marrocu, E., Paci, R. and Pontis, M. (2011). Intangible capital and firms productivity. *Industrial and Corporate Change*, 21(2), 377-402.
- Market Watch: Stock Market News - Financial News, available at: <http://www.marketwatch.com/> (September 22, 2016).
- Mohr, A. and Batsakis, G. (2014). Firm resources, international speed of retailers, *International Marketing Review*, 31(6), 601-620.
- Sorescu, A., Frambach, R.T., Singh, J., Rangaswamy, A. and Bridges, C. (2011). Innovations in Retail Business Models. *Journal of Retailing*, 87, Supplement 1, S3-S16.
- Torgovia v Rossii 2015, Statističeskij sbornik, Moskva, 2015.
- Vidrascu, P-A, (2015). Intangible assets – Sustainable Economic Factors and New Creators of Value. *Internal Auditing & Risk Management*, 1(37), 65-75.
- Villalonga, B. (2004). Intangible resources, Tobin's  $q$ , and sustainability of performance differences. *Journal of Economic Behaviour & Organization*, 54, 205-230.
- Yu, W., Ramanathan, R. and Nath, P. (2014). The impacts of marketing and operations capabilities on financial performance in the UK retail sector: A resource-based perspective. *Industrial Marketing Management*, 43, 25-31.

## **IMPORTANCE OF THE NON-AGRICULTURAL SECTOR FOR RURAL DEVELOPMENT OF THE AREA OF FRUŠKA GORA (VOJVODINA PROVINCE, SERBIA)**

Sanja ĐUKIĆ<sup>1\*</sup>, Mirela TOMAŠ-SIMIN<sup>1</sup>, Dunja DEMIROVIĆ<sup>2</sup>

<sup>1</sup>University of Novi Sad, Faculty of Agriculture, Department of Agricultural Economics and Rural Sociology, Novi Sad, Serbia

<sup>2</sup>University Business Academy, Faculty of Economics and Engineering Management, Novi Sad, Serbia

\*Corresponding author: sanja.djukic@polj.edu.rs

### **Abstract**

Current global trends in the development of rural areas are increasingly developing in the direction of strengthening the role of the non-agricultural sector, which is synchronized with the development of agriculture. The objectives of this work were aimed at identifying the presence of non-agricultural activities in the area of Fruška gora (Vojvodina Province, Serbia), and their impact on rural development in this area. A survey was conducted in 2014 in the area of Fruška gora in order to achieve the objectives of this research. The research analyzed the attitudes of 117 residents of the area from different socio-economic categories. The sample of the respondents was relatively balanced by gender (53.8% females and 46.2% males), with greater participation of young and middle age respondents (aged under 50 years). The SPSS statistical package was used for the purpose of the statistical analysis of the obtained data. The research results show the positive orientation of the respondents regarding the economic importance of non-agricultural activities in rural development, as well as the development of agriculture. In this context, a significant number of the respondents highlighted tourism as the most important non-farm activity, and then forestry, fruit and vegetable processing and catering. The results indicate that there is a variety of choices for the respondents regarding the importance of certain forms of tourism for rural development in this area (agrotourism, sports and recreational tourism, wine tourism, religious tourism etc).

**Key words:** *non-agricultural sector, rural development, tourism, Fruška gora, survey.*

### **Introduction**

Current trends in the world show that agriculture is no longer a dominant economic activity in rural areas, non-agricultural activities have received increasing attention. Strengthening the rural economy is often associated with the continual introduction of new, non-agricultural enterprises (Van der Ploeg et al., 2000). Also, there are frequent cases of agricultural households in rural areas having diversified economic activity, so agricultural and non-agricultural activities co-exist. Reardon et al. (1998) point out that there are production linkages between the farm and non-farm sectors:

- The linkage is upstream when growth in the farm sector induces the non-farm sector to increase its activities by investing in productivity or additional capacity for supplying inputs and services to the former.
- The linkage is downstream when the non-farm sector is induced to invest in capacity to supply agroprocessing and distribution services, using farm products as inputs.

Haggblade et al. (2010) define the key components of the rural non-farm economy are: mining, manufacturing, utilities, construction, commerce, transport, financial, personal, and government services, as well as agroprocessing (the transformation of raw agricultural products by milling, packaging, bulking, or transporting). Diversification of the rural economy can contribute to (Bogdanov et al., 2007):

- accelerating the growth of the local economy,
- reducing the gap between rural and urban areas, and
- reduction of rural poverty.

The area of Fruška gora occupies the southeastern part of the Autonomous Province of Vojvodina (Republic of Serbia). This unique geographical area extends over an area of 139,430.01 ha, and the National Park “Fruška gora” is located in the center of this area. There are eight territorial-administrative units in this area (municipalities Bačka Palanka, Beočin, Irig, Indija, Šid, Petrovaradin, Sremski Karlovci, Ruma and town Sremska Mitrovica). The settlements within the area of Fruška gora are mostly rural, except the two municipalities Petrovaradin and Sremski Karlovci that have the attributes of urban communities (Njegovan, Pejanović, 2009; Pejanović, Njegovan, 2011). Fruška gora as rural area is faced with a number of developmental problems, where infrastructural development is crucial to the survival of the population in this area (Njegovan et al., 2011; Đukić, Pejanović, 2014). The main economic activity in the area of Fruška gora is agriculture (Pejanović et al., 2012). According to Spatial Plan for the special purpose of Fruška gora until 2022, in this area beside agriculture, there are several activities: forestry, tourism, catering, mining, trade, crafts, industry, transport, public utilities. Developmental characteristics of existing activities in the Fruška gora are as follows (Official Gazette of the AP Vojvodina, 2004):

- there is a different level of development of certain economic areas in relation to available resources, the comparative advantages of the area and the real expressed needs;
- there is a concentration of the population, the capacity of industry, trade, service industries and hospitality in the following settlements: Beočin, Sremski Karlovci, Petrovaradin, Šid and Irig, as a result of the existing raw materials basis and favourable conditions for transport links with broader region;
- the use of natural and man-made comparative advantages is incompletely and unevenly, particularly in the field of agriculture (fruit growing, viticulture, animal husbandry), as well as tourism and catering industry;
- excluding economic development on the line Sremski Karlovci-Petrovaradin-Beočin-Šid, basically it can be observed that the area has a picture of an under-developed and the monofunctional economy in stagnation;
- agriculture is the dominant economic activity.

The purpose of this study is to determine the presence of non-agricultural activities in the area of Fruška gora, and their impact on rural development in this area.

### **Material and Methods**

For the purpose of this research was made a specific questionnaire where questions were close-ended type and the five point Likert scale was used. The survey was conducted in 2014 in the area of Fruška gora (Autonomous Province of Vojvodina (Republic of Serbia), which included 117 respondents. A standard type questionnaire was applied which consisted of six questions. The questionnaire is structured on three levels. The first level is the identification part consisting of sociodemographic questions (gender, age and interest group affiliation). The second level of the questionnaire consisted of questions aimed at the identification and significance of certain non-agricultural activities, and the third level of the questionnaire

concerned the determination of the significance of certain forms of tourism in the area of Fruška gora. During the research there were obstacles due to the different level of education of the respondents, so that their answers do not have an equal value. Descriptive statistical method was used in order to adjust the survey data (arithmetic mean, median, mode, and standard deviation). Data were analyzed with the SPSS software package.

The purpose of this study is to determine the presence of non-agricultural activities in the area of Fruška gora, and their impact on rural development in this area.

### Results and Discussion

The socio-economic structure of respondents included the different categories: municipal/city administration, regional organization, the media, non-government organization, financial organization, a public company, the private sector: industry, service sector, agriculture, hunting, forestry, fisheries, water management (table 1). The sample of the respondents was relatively balanced by gender (53.8% females and 46.2% males), with greater participation of young and middle age respondents (aged under 50 years).

Table 1. Socio-demographic structure of respondents

Variables	Frequency	%
<i>Interest group</i>		
municipal/city administrations	8	6.8
regional organizations	3	2.6
the media	1	0.9
academic institutions	0	0
non government organizations	5	4.3
financial organizations	6	5.1
public companies	9	7.7
private sector (industry)	7	6.0
private sector (service industries)	39	33.3
private sector (agriculture, hunting, forestry, fishery, water management)	32	27.4
other	7	6.0
<i>Gender</i>		
female	63	53.8
male	54	46.2
<i>Age</i>		
18-30	21	17.9
31-40	34	29.1
41-50	31	26.5
51-60	22	18.8
61-70	7	6.0
over 70	2	1.7
Total	117	100.0

Source: Author's calculation based on the survey data

Table 2. The importance of certain economic activities within the rural development of area of Fruška gora

Variables	Frequency	%
<i>The most important economic activity</i>		
agriculture, hunting, forestry, fishery and water management	53	45.3
tourism	54	46.2
industry	3	2.6
other service activities	6	5.1
do not know or have no opinion about it	1	0.9
Total	117	100

Source: Author's calculation based on the survey data

Assessing the important of current economic activity in the area of Fruška gora, respondents (table 2) highly valued tourism (46.2%) and agriculture (45.3%). Although previous studies (Njegovan et al., 2011; Đukić, 2015) have shown that agriculture was the dominant economic activity. In this study was observed that the respondents did not give such priority to agriculture. Non-agricultural activities which respondents most valued are tourism, forestry, processing of fruits and vegetables, catering, where the average values were in the range of 3.22 to 3.44, the values of mode for all variables were 4. The standard deviation for those variables was less than 1 which indicated the high level of agreement among the respondents. Contrary to that, energy, mining, industry and civil engineering are non-agricultural activities (according to the respondents) did not have any significant development potentials, where the average values were in the range of 1.83 to 2.03. Between these two extremes, it can be noticed something more important potentials of other non-agricultural activities: processing of milk and meat, water management, production of renewable energy, traditional crafting, trade, transport and communications and other service activities. The average value for those variables were in range of 2.45 to 2.80 (table 3).

Table 3. The potential of development of non-agricultural activities in the area of Fruška gora

Variables	Mean	Mediana	Mode	Standard deviation
Processing of Fruits and Vegetables	3.41	4.00	4.00	0.767
Processing of Milk and Meat	2.74	3.00	3.00	1.070
Forestry	3.44	4.00	4.00	0.814
Water Management	2.54	3.00	3.00	1.087
Production of Renewable Energy	2.57	3.00	3.00	1.140
Tourism	3.60	4.00	4.00	0.732
Traditional Crafting	2.81	3.00	Multiple	1.159
Trade	2.50	3.00	3.00	1.149
Catering	3.22	3.00	4.00	0.975
Other Industrial Activities	1.94	2.00	1.00	1.003
Other Service Activities	2.56	3.00	3.00	1.102
Transport and Communications	2.45	3.00	3.00	1.082
Mining and Energy	2.03	2.00	1.00	1.062
Civil Engineering	1.83	1.00	1.00	1.036

Source: Author's calculation based on the survey data

Table 4. The importance of certain forms of tourism in the context of rural development of Fruška gora

Variables	Mean	Mediana	Mode	Standard deviation
Agrotourism	3.35	3.00	3.00	0.735
Wine Tourism	3.44	4.00	4.00	0.803
Hunting Tourism	3.21	4.00	4.00	1.022
Spa Tourism	3.17	3.00	4.00	0.959
Fishing Tourism	2.70	3.00	3.00	1.069
Ecotourism	3.14	3.00	3.00	0.890
Geotourism	2.75	3.00	3.00	0.991
Sports and Recreational Tourism	3.36	4.00	4.00	0.845
Cultural Tourism	3.38	4.00	4.00	0.935
Religious Tourism	3.40	4.00	4.00	0.799
Gastronomic Tourism	2.93	3.00	3.00	1.006
Manifestation Tourism	3.07	3.00	3.00	0.917

Source: Author's calculation based on the survey data

Respondents had the opportunity to assess the importance of certain forms of tourism in the context of rural development of Fruška gora (table 4). According to their opinion, the greatest development potentials have the following forms of rural tourism: wine tourism, agrotourism, religious tourism, cultural tourism, and sports and recreational tourism. The average values for these variables mean value were in the range of 3.36 to 3.44, the values of mode for all variables were 4. The survey results indicate that hunting tourism, spa tourism, manifestation tourism and ecotourism had mediocre development potentials, while fishing tourism, geotourism and gastronomy tourism had the least development potentials. In most of these variables the standard deviation was less than one, and it can be noted that there was a high degree of agreement among interviewees on this issue.

### Conclusions

The improvement of rural areas implies most often their change, and above all their economic structure. Alongside agriculture, a variety of other non-agricultural activities can be found within rural areas. The results of the research showed a significant degree of agreement of the respondents regarding the possibility of diversification of the rural economy in the area of Fruška gora, and tourism was given almost the same importance as agriculture. These results were in line with the real state of the development of rural economy in the area of Fruška gora. It should be emphasized that this area possesses significant potential for the development of other non-agricultural activities, which have not been significantly used. In this regard, the results of the research showed that this area had industrial potential, since forestry and food industry had the greatest potential for development in the area of Fruška gora. When it comes to the services sector, respondents highly valued the potentials of tourism and hospitality for the further development of this area. Tourism in rural areas gives a good basis for securing additional activities in agricultural holdings. Accordingly, the results of the research provide information that agrotourism and wine tourism have significant potentials in the area of Fruška gora. In addition, this area has the potential to develop tourism that is not closely related to agricultural resources (religious tourism, cultural tourism, and sports and recreational tourism). Having all this in mind, there are specific circumstances for the area of Fruška gora that should be taken into consideration when

planning the rural development, primarily through the provision of investment for the development of non-agricultural activities, as well as rural infrastructure.

### **Acknowledgements**

The article is the result of research within the project financed by the Ministry of Education, Science and Technological Development, Republic of Serbia, Sustainable agriculture and rural development aimed at reaching the strategic objectives of the Republic of Serbia in the Danube region, No III 46006, project period 2011-2017.

### **References**

- Bogdanov, N. L., Đorđević-Milošević, S., Clark, L. (2007). Mala ruralna domaćinstva u Srbiji i ruralna nepoljoprivredna ekonomija (Small rural households in Serbia and rural non-agricultural economy). United Nations Development Programme (UNDP). In Serbian.
- Đukić, S. (2015). Agroeonomski faktori održivog razvoja regiona Fruške gore (Agricultural factors of sustainable development of the region of Fruška gora). Unpublished doctoral dissertation, Faculty of Agriculture, Novi Sad. In Serbian.
- Đukić, S., Pejanović, Lj. (2014). Infrastructure as a factor of rural development of the region of Fruška gora. Thematic Proceedings, International Scientific Meeting „Sustainable Agriculture and Rural Development in Terms of the Republic of Serbia Strategic Goals Realization within the Danube Region – rural development and un(limited) resources“, 5-6. June 2014, Belgrade, Institute of Agricultural Economics, Belgrade, Serbia, pp. 836-852.
- Haggblade, S., Hazell, P., Reardon, T. (2010). The rural non-farm economy: Prospects for growth and poverty reduction. *World Development*, 38(10), pp. 1429-1441.
- Njegovan, Z., Pejanović, R. (2009). Ruralna regionalizacija AP Vojvodine: novi teorijsko metodološki pristupi upravljanju ruralnim razvojem (Rural regionalization of AP Vojvodina: new theoretical methodological approaches to rural development management), Faculty of Agriculture, Novi Sad, pp. 177-178. In Serbian.
- Njegovan, Z., Pejanović, R., Kosanović, N., Đukić, S. (2011). Ruralni razvoj u konceptu „Master plan održivog razvoja Fruške Gore 2012-2022.“ (Rural development in the concept "Master Plan for Sustainable Development of Fruška gora 2012-2022"). *Agroeonomika*, Faculty of Agriculture, Novi Sad, vol. 49-50, pp. 77-87. In Serbian.
- Pejanović, R., Njegovan, Z. (redaktori) (2011). Ruralni i lokalni ekonomski razvoj AP Vojvodine (Rural and local economic development of AP Vojvodina). Monograph, Faculty of Agriculture, Novi Sad. In Serbian.
- Pejanović, R., Panjković, B., Đukić, S., Glavaš-Trbić, D. (2012). Sustainable Development of the Region Fruška gora within AP Vojvodina, *Research Journal of Agricultural Science*, vol. 44, No. 3, pp. 246-253.
- Reardon, T., Stamoulis, K., Balisacan, A., Cruz, M. E., Berdegue, J., Banks, B. (1998). Rural non-farm income in developing countries. *The state of food and agriculture*, 1998, pp. 283-356.
- Republika Srbija, Autonomna Pokrajina Vojvodina, Skupština Autonomne Pokrajine Vojvodine (2004). Prostorni plan područja posebne namene Fruške gore do 2022. „Službeni list APV“, br. 18/04 (Spatial Plan for the special purpose of Fruška gora until 2022. "Official Gazette of the Autonomous Province of Vojvodina", no. 18/04). The Republic of Serbia, Autonomous Province of Vojvodina, Assembly of the Autonomous Province of Vojvodina. In Serbian.



Van der Ploeg, J. D., Renting, H., Brunori, G., Knickel, K., Mannion, J., Marsden, T., de Roest, K., Sevilla-Guzmán, E., Ventura, F. (2000). Rural development: from practices and policies towards theory. *Sociologia ruralis*, vol. 40, No. 4, pp. 391-408.

## **SOCIOECONOMIC CHARACTERISTICS AS A DEVELOPMENT FACTORS OF RURAL AREAS OF AUTONOMOUS PROVINCE OF VOJVODINA (SERBIA)**

Zoran NJEGOVAN, Sanja ĐUKIĆ\*, Mirela TOMAŠ-SIMIN

University of Novi Sad, Faculty of Agriculture, Department of Agricultural Economics and Rural Sociology,  
Novi Sad, Serbia

\*Corresponding author: sanja.djukic@polj.edu.rs

### **Abstract**

Vojvodina is a rural area that is located in the northern part of the Republic of Serbia. The authors analyzed seven administrative districts of Vojvodina which meet the criteria for classification at NUTS 3 level. The research had two objectives: (1) determining socioeconomic disparities as a development factors of rural areas of Vojvodina (at the level of administrative districts); (2) clustering of Vojvodina's districts based on selected socioeconomic indicators. The following socioeconomic indicators were used for comparison of Vojvodina's districts: population density, dependency ratio, the share of the population with secondary, higher and university education, as well as the average net salary. Authors ranked Vojvodina's districts for two reference periods (2010 and 2015), using the obtained values of selected indicators. Statistical software Statistica 13.2. was used for the purposes of the cluster analysis, and the results were displayed in the form of dendrograms. The results showed that there is an imbalance of development in Vojvodina's rural districts in the context of selected socioeconomic indicators. In accordance with this, the authors concluded that rural area of Južnobački district had the most favourable socioeconomic profile. By contrast, two rural districts of Banat (Severnobanatski and Srednjobanatski) had extremely unfavourable socioeconomic characteristics. The authors estimate that there will be no drastic changes in socioeconomic characteristics of Vojvodina's districts in the coming period.

**Keywords:** *socioeconomic indicators, rural districts, Vojvodina, cluster analysis.*

### **Introduction**

Rural development indicators serve to measure different dimensions of rural development. Socioeconomic indicators of rural development are different depending on the applied methodology. According to the OECD methodology (UNECE, FAO, OECD, WB, Eurostat, 2007) rural development indicators are defined through four groups of topics: population and migration; economic structure and performance; social well-being and equity; environment and sustainability. Within the indicators of rural development of the European Union (UNECE, FAO, OECD, WB, Eurostat, 2007) there is a narrow group that relates to the following areas: population and migration - demographic structure and evolution; social well-being - quality of life; economic structure and performance. Rural Development Indicators of the World Bank for development (UNECE, FAO, OECD, WB, Eurostat, 2007) are divided into the following groups: basic socio-economic data; enabling environment for rural development; broad based economic growth for rural poverty reduction; natural resource management and biodiversity; social well-being (education and health). FAO rural development indicators (UNECE, FAO, OECD, WB, Eurostat, 2007) are classified by groups: poverty alleviation with equity; access to land, water and other natural resources; access to inputs, markets and services; development of non-farm rural activities; education,

training and extension; growth. In the case of rural regionalization of the area of AP Vojvodina (Njegovan, Pejanović, 2009) there are three groups of indicators: socioeconomic indicators, indicators for the agriculture sector and indicators of living and welfare conditions were used. In the analysis of socio-economic indicators of AP Vojvodina were used the following indicators (Njegovan, Pejanović, 2009): population density, dependency ratio, share of the population with secondary, higher and university education and average net salary.

Respecting the criteria of Eurostat, it is possible to divide the territory of AP Vojvodina into NUTS territorial units (Njegovan, Pejanović, 2009). Accordingly, the rural area of AP Vojvodina can be divided into NUTS level 2, where three regions are defined: Bačka, Banat and Srem. Administrative districts represent NUTS 3 territorial units (Južnobački, Severnobački, Zapadnobački, Srednjebanatski, Severnobanatski, Južnobanatski and Sremski). In determining rurality of areas in Vojvodina by the OECD methodology, six out of a total of seven districts (Zapadnobački, Severnobački, Severnobanatski, Srednjebanatski, Južnobanatski and Sremski) can be considered predominantly rural regions because more than 50% of the population lives in rural municipalities. Južnobački district only meets the criteria for partial (mixed) rural regions where about 44.5% of the inhabitants live in rural areas (Njegovan, Pejanović, 2009).

Previous studies of rural development of Vojvodina indicate that the limiting factors for this rural area are processes of depopulation and deagrarization (Pejanović, 2010). Also, Čobanović and Petrović (2006) have found that there has been a significant change in the rural structure of AP Vojvodina, which is evident in the processes of deagrarization, senilization and depopulation. Rodić et al. (2013) point out that the demographic characteristics of the rural population might be a serious constraint on rural economy diversification and rural development in Vojvodina, so that decision makers must be aware of this and adjust development policies to the existing conditions. Ivkov et al. (2007) point to problems in the labour market (high unemployment, high hidden unemployment and insufficient mobility of the labour force). Košić et al. (2015) highlight the following elements of rural development in the area of AP Vojvodina: out of 465 inhabited places in the Autonomous Province of Vojvodina in total, 415 are rural settlements, and an average Vojvodina rural settlement has around 2,200 inhabitants and 22.94% of them are older than 60.

### **Material and Methods**

The basic assumption in this research refers to the possibility of development disparities in the socioeconomic dimension of rural development of the AP Vojvodina. The research had two objectives: (1) determining socioeconomic disparities of Vojvodina (at the level of administrative districts); (2) clustering of Vojvodina's districts based on selected socioeconomic indicators. As a source of data, the authors used information available from Republic Institute for Statistics of Serbia. The methodological framework in this paper is the analytical-synthetic method, method of comparison, historical method, and from the statistical methods cluster analysis was used. Statistical software Statistica 13.2. was used for the purposes of the cluster analysis, and the results were displayed in the form of dendrograms. The time frame of observation includes the period of the second decade of the twenty-first century.

### **Results and Discussion**

Socioeconomic indicators are indicators that can be defined as general. This group includes those variables that relate to: the population (total population; population density; age,

gender, education and occupational structure of the population), salary (average net salary denominated in local currency), total area, etc. The following socioeconomic indicators were used in this research:

- population density (PD),
- dependency ratio (DR),
- share of the population with secondary, higher and university education (EDU)
- average net salary (ANS).

Population density is calculated as the number of inhabitants per square kilometer, and in general this indicator is used as a criterion for determining rural areas. Dependency ratio is an indicator that shows how much of the working population is burdened with dependent non-working population. This indicator is calculated as the ratio of non-working segments of population (younger than 15 and older than 65 years) and the working part of the population (aged 15 to 65 years). The share of the population with secondary, higher and university education is significant indicator for assessment of the extent to which the favourable educational structure of the population. The indicator which refers to average net salary, takes into account those salaries generated by operations in a given territory (municipality, district...).

Based on the table below (table 1), it can be noticed that Južnobački district has the most optimal values of socioeconomic indicators for 2010 (the table shows the ranking of the rural districts of AP Vojvodina for the observed indicators). This district had the highest values for: population density (151 inhabitants /km<sup>2</sup>); the share of the population with secondary, higher and university education (59.89%) and average net salary (36,327 dinars). Also, this district had the lowest value for the dependency ratio (44.12%). Somewhat more favourable values of socioeconomic indicators had Severnobački district, with the values for: population density (107 inhabitants/km<sup>2</sup>), dependency ratio (46.06%), share of the population with secondary, higher and university education (52.17%) and average net salary (30,998 dinars). The relatively low values relating to (table 1): population density had Srednjebanatski district (59 inhabitants/km<sup>2</sup>) and Severnobanatski district (65 inhabitants/km<sup>2</sup>); share of the population with secondary, higher and university education had Severnobanatski district (46.87%) and Južnobanatski district (49.67%), and average net salary had Sremski district (29,442 dinars) and Zapadnobački district (30,291 dinars). The relatively high values for the dependency ratio have Srednjebanatski district (47.69%) and Severnobanatski district (47.51%),

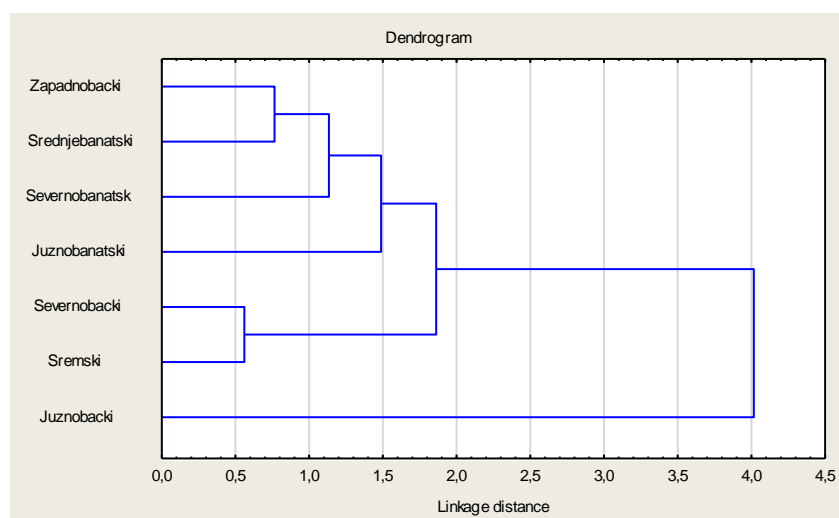
Table 1. Socioeconomic indicators for 2010 (by rural areas of AP Vojvodina)

District	PD*	Rank*	DR* (%)	Rank*	EDU* (%)	Rank*	ANS (dinars)	Rank*
Zapadnobački	80	4	47.28	3	52.43	6	30,291	2
Južnobanatski	70	3	46.70	4	49.67	2	35,212	6
Južnobački	151	7	44.12	7	59.89	7	36,327	7
Severnobanatski	65	2	47.51	2	46.87	1	30,467	3
Severnobački	107	6	46.06	5	52.17	5	30,998	4
Srednjebanatski	59	1	47.69	1	52.01	4	32,358	5
Sremski	93	5	46.04	6	51.00	3	29,442	1

\*Authors' calculation

Source: [www.stat.gov.rs](http://www.stat.gov.rs)

Cluster analysis for 2010 for the observed indicators gave the distribution of the rural districts of AP Vojvodina to four clusters. Within the first cluster belongs Južnobački district, which from all other districts stood out with the most favourable values of socioeconomic indicators. The second cluster includes two districts: Sremski and Severnobački. These two districts had a somewhat higher density of population and a lower burden of the working population with dependent non-working population than other districts (except Južnobački district). Within the third cluster is the Južnabanatski district, which compared to other districts, had relatively higher average net salaries (except Južnobački district). The fourth cluster consists of three districts: Severnabanatski, Srednjebanatski and Zapadnobački. Those three districts had the highest burden of the working population with a dependent non-working population (dendrogram 1).



Dendrogram 1. Cluster analysis of socioeconomic indicators by rural areas of AP Vojvodina for 2010

*\*Authors' calculation*

Source: [www.stat.gov.rs](http://www.stat.gov.rs)

Based on the table below (table 2), it can be noticed that the Južnobački district had the most optimal values of socioeconomic indicators for 2015. This district had the highest values for: population density (153 inhabitants/km<sup>2</sup>), share of the population with secondary, higher and university education (71.32%), and average net salary (47,445 dinars). Also, this district had the lowest value for the dependency ratio (43.04%) Somewhat more favourable values of socioeconomic indicators had Sremski district-population density (87 inhabitants/km<sup>2</sup>), dependency ratio (43.56%), share of the population with secondary, higher and university education (63.76%) and average net salary (39,195 dinars). The relatively low values relating to (table 2): population density had Srednjebanatski district (56 inhabitants/km<sup>2</sup>) and Severnabanatski district (61 inhabitants/km<sup>2</sup>); share of the population with secondary, higher and university education had Severnabanatski district (57.44%) and Južnabanatski district (61.44%), and average net salary had Zapadnobački district (37,593 dinars) and Severnabanatski district (38,630 dinars). The relatively high values for the dependency ratio had Severnabanatski district (46.21%) and Zapadnobački district (46.10%).

Cluster analysis for 2015 for the observed indicators gave the distribution of the rural districts of AP Vojvodina to four clusters. Within the first cluster belongs Južnobački district, which from all other districts stood out with the most favourable values of socioeconomic indicators. The second cluster includes two districts: Sremski and Južnabanatski. These two districts had a lower burden of the working population with dependent non-working

population than other districts (except Južnobački district). Within the third cluster is the Severnobački district which, in relation to other districts had the most unfavourable constellation of observed socioeconomic indicators. The fourth cluster consists of three districts: Severnobački, Srednjebanatski and Zapadnobački. Those three districts had a mediocre burden of the working population with dependent non-working population and the share of the population with secondary, higher and university education (dendrogram 2). This constellation of the values of socioeconomic indicators as development factors of the rural development of AP Vojvodina (for 2010 and 2015) indicates that there is no balanced development of this area.

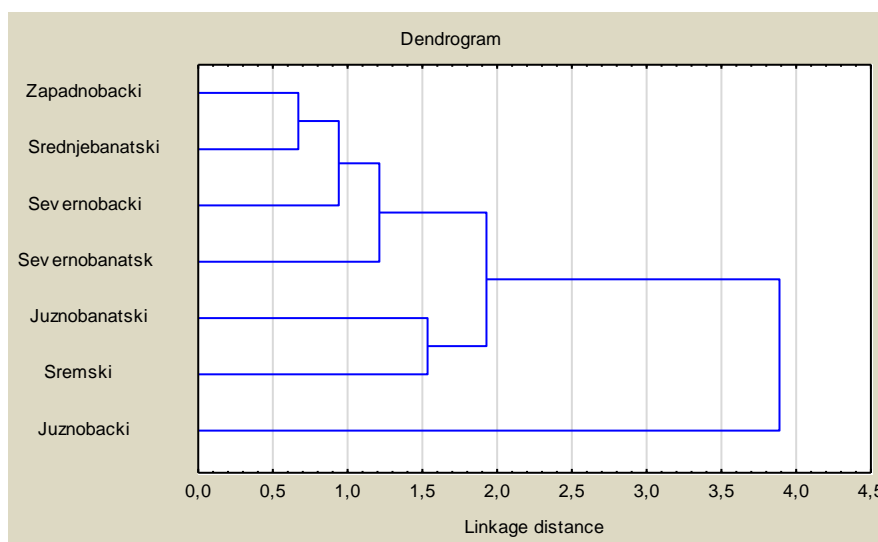
Accordingly, socioeconomic characteristics as a factor of rural development of AP Vojvodina give an expression of the differentiation of rural districts for both observed years: Južnobački district-most developed (leader), Sremski district- developed, Zapadnobački, Južnobački, Severnobački and Srednjebanatski districts-in development, and Severnobački-undeveloped.

Table 2. Socioeconomic indicators for 2015 (by rural areas of AP Vojvodina)

District	PD*	Rank*	DR* (%)	Rank*	EDU* (%)	Rank*	ANS (dinars)	Rank*
Zapadnobački	72	4	46.10	2	63.40	5	37,593	1
Južnobački	67	3	44.87	5	61.44	2	45,928	6
Južnobački	153	7	43.04	7	71.32	7	47,445	7
Severnobački	61	2	46.21	1	57.44	1	38,630	2
Severnobački	102	6	45.61	3	62.54	4	39,216	5
Srednjebanatski	56	1	45.31	4	61.98	3	39,054	3
Sremski	87	5	43.56	6	63.76	5	39,195	4

\*Authors' calculation

Source: [www.stat.gov.rs](http://www.stat.gov.rs)



Dendrogram 2. Cluster analysis of socioeconomic indicators by rural areas of AP Vojvodina for 2015

\*Authors' calculation

Source: [www.stat.gov.rs](http://www.stat.gov.rs)

## **Conclusions**

The results of the research show that in terms of socioeconomic conditions there is a very unbalanced development of the rural districts of AP Vojvodina. Socioeconomic characteristics as a factor of rural development of AP Vojvodina give an expression of the differentiation of rural districts for both observed years: Južnobački district-most developed (leader), Sremski district- developed, Zapadnobački, Južnobanatski, Severnobački and Srednjebanatski districts-in development, and Severnobanatski-undeveloped. Južnobački district for both periods had a much higher value of selected socioeconomic indicators. By contrast, Severnobanatski district had extremely unfavourable socioeconomic characteristics. During 2010, Severnobački district had somewhat more favourable development of the socioeconomic dimension of rural development. However, already in 2015, that constellation of socioeconomic characteristics of rural development was more favourable in Sremski district. The authors emphasize that it is realistic to expect that in the future Južnobački district will continue to maintain its dominance over the socioeconomic framework of rural development. A somewhat more favourable development of socioeconomic indicators of rural development can be expected in two districts: Sremski and Severnobački, while these indicators will remain unchanged for other districts. The authors conclude that it is necessary to take into account the socioeconomic specificities of all districts of AP Vojvodina in the further planning of rural development.

## **Acknowledgement**

The article is the result of research within the project financed by the Ministry of Education, Science and Technological Development, Republic of Serbia, Sustainable agriculture and rural development aimed at reaching the strategic objectives of the Republic of Serbia in the Danube region, No III 46006, project period 2011-2017.

## **References**

- Čobanović, K., Petrović, Ž. (2006). Agricultural population of the Autonomous Province of Vojvodina and rural development. *Matica Srpska Journal of Social Sciences*, Issue 121, pp: 333-340. In Serbian. Available at: <http://www.doiserbia.nb.rs/Article.aspx?id=0352-57320621333C> (accessed Jun 26, 2017).
- Ivkov, A., Kovačević, T., Dragin, A., Djurdjev, B., Ivanović, L. (2007). Influence of tourism on the employment in Vojvodina. *Geographica Pannonica*, vol. 11, pp. 54-58. Available at: [http://www.dgt.pmf.uns.ac.rs/cirilica/pannonica/papers/volume11\\_11.pdf](http://www.dgt.pmf.uns.ac.rs/cirilica/pannonica/papers/volume11_11.pdf) (accessed Jun 26, 2017).
- Košić, K., Demirović, D., Pejanović, R., Lazić, L., Stamenković, I. (2015). Key principles of rural tourism households development strategy-case study of Vojvodina. *Ekonomika poljoprivrede*, vol. 62, No. 4, pp. 975-988. Available at: <http://www.ea.bg.ac.rs/images/Arhiva/2015/Broj%204/6%20EP%204%202015-6.pdf> (accessed Jun 26, 2017).
- Njegovan, Z., Pejanović, R. (2009). Ruralna regionalizacija AP Vojvodine: novi teorijsko metodološki pristupi upravljanju ruralnim razvojem (Rural regionalization of AP Vojvodina: new theoretical methodological approaches to rural development management), Faculty of Agriculture, Novi Sad, pp. 177-178. In Serbian.
- Pejanović, R. (2010). Demografski problemi kao ograničavajući faktori ruralnog razvoja AP Vojvodine (Demographic problems as limiting factors of rural development of AP

- Vojvodina). *Journal of the Anthropological Society of Serbia*, No. 45, pp. 65-75. In Serbian.
- Rodić, V., Bošnjak, D., Janković, D., Karapandžin, J. (2013). Demographic characteristics of rural populations in Vojvodina as a factor of rural economy diversification. In *The Seminar: Agriculture and rural development-challenges of transition and integration processes*, September 2013, Department of Agricultural Economics, University of Belgrade, Serbia, pp. 112-123. Available at: <http://ageconsearch.umn.edu/record/161797/files/08-Rodic-Finall.pdf> (accessed Jun 26, 2017).
- UNECE, FAO, OECD, WB, Eurostat (2007). *Rural Households' Livelihood and Well-Being, Statistics on Rural Development and Agriculture Household Income. The Wye Group Handbook*, United Nations, New York and Geneva. Available at: <http://www.fao.org/docrep/015/am085e/am085e00.htm> (accessed Jun 26, 2017).



## **THE POTENTIALS FOR ORGANIC PRODUCTION OF SERBIA AND OTHER EUROPEAN UNION (EU) CANDIDATE COUNTRIES**

Sanja ĐUKIĆ\*, Mirela TOMAŠ-SIMIN, Janko VESELINOVIĆ

University of Novi Sad, Faculty of Agriculture, Department of Agricultural Economics and Rural Sociology,  
Novi Sad, Serbia

\*Corresponding author: sanja.djukic@polj.edu.rs

### **Abstract**

Organic agriculture is an important element of agricultural and environmental policy of the European Union (EU), which aims to ensure the sustainability of agriculture and environmental protection. In this paper, the authors analyzed the potential for organic production of countries that are candidates for membership in the European Union (Albania, FYR Macedonia, Montenegro, Serbia and Turkey). The authors analyzed three characteristics for observed countries manifested during the second decade of the XXI century: 1) legal framework and support policy, 2) agricultural area for organic production (including those areas that are under conversion), 3) other areas that are in a broader context classified under organic areas, 4) the number of participants in organic production (producers, processors, importers and exporters). As a source of data, the authors used information available from: Research Institute of Organic Agriculture (FiBL), International Federation of Organic Agriculture Movements (IFOAM), as well as data from the Ministry of Agriculture and Environment of the Republic of Serbia and the Republic Institute for Statistics of Serbia. The research results showed that the greatest potential for organic production has Turkey. Turkey has the highest representation of agricultural organic areas and the most developed network of participants in organic production. After Turkey, significant potential for organic production has Serbia, which recorded the highest growth of organic agricultural areas, and FRY Macedonia with the largest total organic area.

**Keywords:** *Potentials, Organic production, European Union candidate countries, Serbia.*

### **Introduction**

Consumer awareness in terms of quality and health-safe food and growing ecological movements have led to more intensive growth of organic agriculture in the world during the 20th century. During 1972, IFOAM was formed (International Federation of Organic Agriculture Movements), and only eight years after the same organization brings basic principles on organic production. On these principles are designed other documents of the European Union on organic farming. In the present conditions, in Europe Union there are several regulations: Council Regulation (EC) No 834/2007, No 889/2008 and No 1235/2008, as well as some updates the European Commission for organic yeast, organic aquaculture and organic wine.

In the context of Europe Union (EU) enlargement towards the Balkans, at the moment the current candidacy five countries: Albania, The Former Yugoslav Republic of Macedonia, Montenegro, Serbia and Turkey. Unlike Montenegro, Serbia and Turkey, The Former Yugoslav Republic of Macedonia and Albania have not yet started accession negotiations with the European Union. The European Union strongly supports the accession of the candidates from Western Balkans states to World Trade Organization (WTO) membership.

Turkey, Albania, the Former Yugoslav Republic of Macedonia and Montenegro are already WTO members, while negotiations with Serbia are still in progress. In the framework of an analysis of organic production potential of the EU candidate countries, Bteich et al. (2014) emphasized that all the EU candidate countries have already started the process of harmonising their national laws on organic production, but Serbia and Former Yugoslav Republic of Macedonia are particularly well advanced in the process.

### **Material and Methods**

The basic assumption in this research stems from the belief that there are different potentials for the development of organic agriculture among the candidate countries for EU membership. Accordingly, the main goals in this paper are focused on determining factors for organic production of countries that are candidates for membership in the EU (Albania, FYR Macedonia, Montenegro, Serbia and Turkey). As a source of data, the authors used information available from: Research Institute of Organic Agriculture (FiBL), International Federation of Organic Agriculture Movements (IFOAM), as well as data from the Ministry of Agriculture and Environment of the Republic of Serbia and the Republic Institute for Statistics of Serbia. The methodological framework in this paper is the analytical-synthetic method, method of comparison, as well as historical method, while the time frame of observation includes the period of the second decade of the twenty-first century.

### **Results and Discussion**

#### ***Legal framework and support policy (subsidies)***

Legislation on organic production in Albania exists since 2004, when it was adopted the Law on the Production, Processing, Certification and Marketing of “Bio” Products. Also, there is a subsidy scheme for organic farmers since 2008. In that context, Bernet and Kazzazi (2012) highlighted the constraints that exist in this field: “the lack of structures to allocate these subsidies, the unclear and complicate procedures, and the relatively small amounts per farm hampered the efficiency of this new measure”. In FYR Macedonia the Law on Organic Agricultural Production was adopted in 2004, and there is also The Law on Agricultural Development Support. El Bilali et al. (2014) noticed that organic production in Macedonia is still in an early stage of development, but there are aggressive marketing and high support from government for this sector. Funds for organic production are divided between the different segments of the supply chain: production, processing and trade (Vittuari, 2011). In Montenegro the organics law was adopted 2004, and there are payments granted under a special scheme. Since 2009, direct payments in organic agriculture per hectare and livestock unit have been introduced (National Action Plan for the Development of Organic Agriculture 2012-2017, MARD, 2012). Legislation on organic production in Serbia was adopted 2010, and the Rulebook on the control and certification of organic production and organic production methods in 2011. The legal framework for subsidies in organic production of Serbia is provided through two acts: The Law on Subsidies for Agriculture and Rural Development and The rulebook regulating the subsidies for organic production. Incentives can be achieved at a premium for milk produced with organic production method, then in organic crop production, followed by the recovery of plant nutrition products are allowed for use in organic crop production, as well as in organic livestock production (Nikolić et al., 2017). Nikolić et al. (2017) also noted a reduced level of incentives for organic production in 2016 (747,359.87 euro), compared to the level of incentives for 2013 (1,745,200.70 euro). In Turkey the organics law was adopted 1994. Turkish organic producers can also make use of

additional direct income support payments since 2005, but the level of state recognition and the financial support for organic agriculture are really insufficient (Özbilge, 2007).

**Agricultural area for organic production**

There were 507.345 hectares of organic agricultural land in 2015, including in conversion areas in EU candidate countries. Turkey has the largest total agricultural area under organic production in 2015 (486.069 hectares) compared to other EU candidate countries (chart 1). However, in 2015, the organic share of total agricultural land was the highest in Montenegro (1.4%). With respect to other candidate EU countries, in 2015 Albania had the lowest total organic agricultural area (515 hectares), and the organic share of total agricultural land (0.04%) (chart 2).

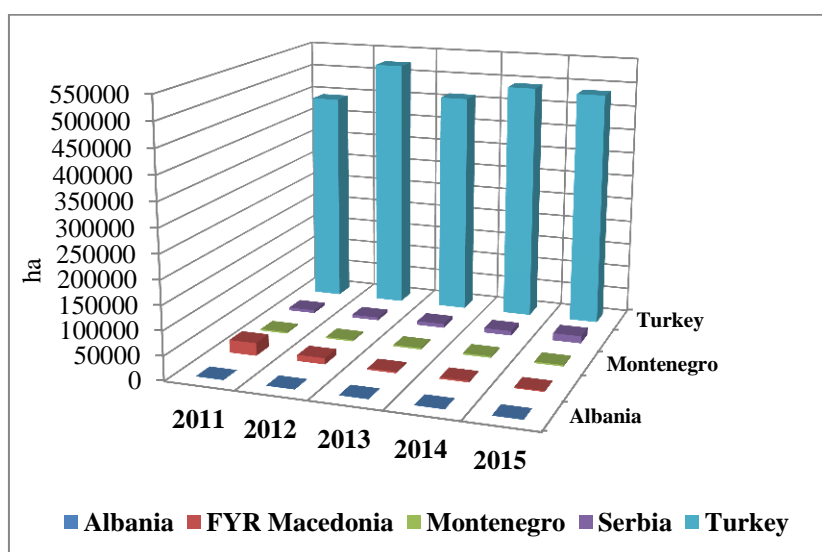


Chart 1. Total organic agricultural area by country in hectares (2011-2015)

Source: FiBL, 2017

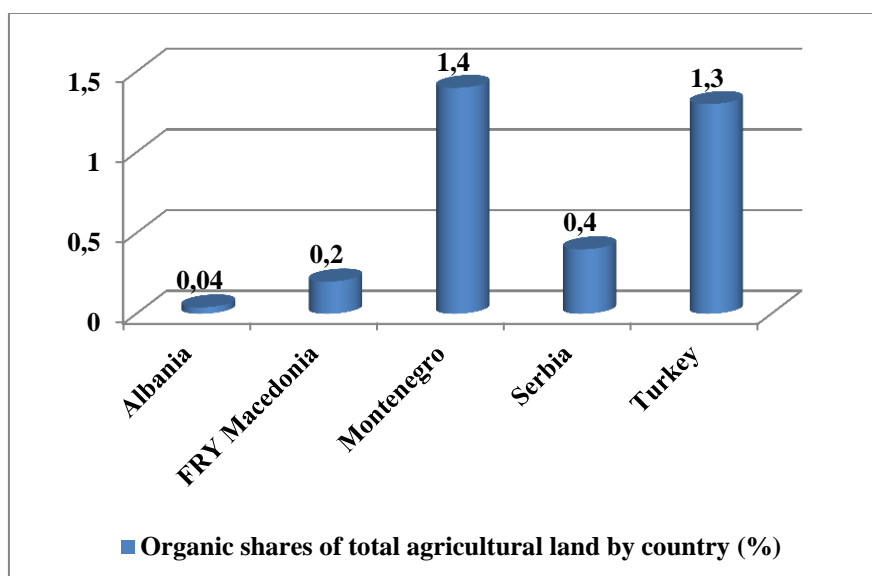


Chart 2. Organic shares of total agricultural land by country (%) (2015)

Source: FiBL, 2017

In the observed period, all EU candidate countries (except FRY Macedonia) recorded the growth of agricultural land under organic production (table 1). The highest growth rate of agricultural land under organic production in the period from 2011 to 2015 was recorded in Serbia (19.66%), while there was a decline in these areas in FRY Macedonia (-39.32%).

Table 1. Annual rate of change of the total organic agricultural area by country (2011-2015)

Country	Annual rate of change (2011-2015)*
Albania	2.83
FRY Macedonia	-39.32
Montenegro	1.4
Serbia	19.66
Turkey	1.89

Source: Authors' calculation based on FiBL data

### **Other areas that are in a broader context classified under organic areas**

Distributions of other areas that can be classified as organic surface are different in the EU candidate countries (table 2). During 2015, FYR Macedonia in relation to other observed countries had a major area of its territory falling within other organic surfaces (8,122 hectares grazed non agricultural areas and 556,600 hectares areas as wild collection). Except Macedonia, significant presence of other organic surfaces (for 2015) was in Albania (467,783 hectares of the wild collection) and in Montenegro (139,809 hectares of the wild collection). When looking at the total organic areas in the EU candidate countries, a completely different picture is obtained about the potentials of organic farming for observed countries. Namely, during 2015, Macedonia stood out with the highest total organic area in relation to the other countries (566,886 hectares). The areas under the pastures in FRY Macedonia are almost four times higher than organic agricultural areas, which provide a good basis for the development of organic livestock. Also, the greater the overall organic surfaces have been recorded in Albania (468.298 hectares), and Turkey (547,299 hectares).

Table 2. Total organic and other organic areas by country (2015)

Country	Other organic areas (hectares)					All organic areas (hectares)
	Aquaculture	Forest	Grazed non agri. land	Wild collection*	Other non agri. land	
Albania	-	-	-	467,783	-	468,298
FRY Macedonia	-	-	8,122	556,600	-	566,886
Montenegro	-	-	-	139,809	-	143,097
Serbia	-	-	-	1,550	-	16,848
Turkey	-	-	-	61,230	-	547,299

Source: FiBL & IFOAM, 2017

\*Wild collection and beekeeping areas

### **The network of participants in organic production**

During 2015, Turkey has the most developed network of participants in organic production (producers, processors, importers and exporters). In addition to Turkey, the developed networks of processors in organic production were Serbia and Albania. Regarding importers operating in the organic production sector, Turkey and Serbia had a developed network of these participants in relation to other observed countries. On the other hand, Turkey and Albania had a developed network of exporters of organic products (table 3). The small

number or lack of participants in organic production shows a relatively still underdeveloped organic product market, whose development should be encouraged by various financial measures (higher level of subsidies in production, providing facilities for trade and investments).

Table 3. The number of participants in organic production by country (2015)

Country	Network of participants			
	Producers	Processors	Importers	Exporters
Albania*	39	22	4	25
FRY Macedonia	460	7	-	6
Montenegro**	167	9	-	-
Serbia	264	37	30	3
Turkey	69,967	1,064	44	42

Source: FiBL & IFOAM, 2017

\* Available data refers to 2012

\*\* Available data refers to 2014

### Conclusions

Legislation and support policy related to organic production is present in all EU candidate countries, which is an important factor for the further development of organic production. However, there are significant differences between the observed countries, both in the length of the implementation period of the legal frameworks, and in the amount of subsidies (as one of the measures of support policy) that are granted to organic producers. In the observed period Turkey most stood out with its total organic agricultural areas. Positive trends in the development of organic production are present in Serbia (the highest growth of organic agricultural areas for the observed period). Considering that the potential for organic production on other organic areas, FRY Macedonia was distinguished by significant potentials due to large areas under pastures and wild collection. In addition to Turkey, in all other observed countries there was a relatively underdeveloped network of participants operating in the organic production sector (producers, processors, importers and exporters). Despite existing potentials, there are limitations that can affect the further development of organic agriculture: insufficient subsidies (Albania, Serbia and Turkey); decline in organic agricultural areas (FRY Macedonia), underdevelopment of participants' network in organic production (Albania, FRY Macedonia, Montenegro and Serbia). The authors conclude that a more important role of the state is needed, primarily through the growth of subsidies for organic producers, as well as the improvement of investment and trade facilitation in the organic production sector.

### Acknowledgement

Paper is a part of research project financed by the Ministry of Education, Science and Technological Development of the Republic of Serbia “Production of cheese with added value manufactures from the milk from organic and sustainable systems”, No. TR 31095.

### References

IFOAM (International Federation of Organic Agriculture Movements). Available at: <http://www.ifoam-eu.org> (accessed Jun 21, 2017).

- Information portal of the Research Institute of Organic Agriculture (FiBL). Country info. Available at: <http://www.organic-europe.net> (accessed Jun 21, 2017).
- Research Institute of Organic Agriculture (FiBL). Key indicators. Available at: [http://www.organic-world.net/statistics/statistics-data-tables/ow-statistics-data-key-data.html?tx\\_statisticdata\\_pi1%5Bcontroller%5D=Element2Item&cHash=1454ae80c62646f2ea29bd52b7a5248d](http://www.organic-world.net/statistics/statistics-data-tables/ow-statistics-data-key-data.html?tx_statisticdata_pi1%5Bcontroller%5D=Element2Item&cHash=1454ae80c62646f2ea29bd52b7a5248d) (accessed Jun 23, 2017).
- Bernet, T. Kazazi, Iris, S. (2012). Organic Agriculture in Albania – Sector Study 2011. Swiss Coordination Office in Albania (SCO-A), Research Institute of Organic Agriculture (FiBL) and Ministry of Agriculture, Food, and Consumer Production of Albania (MoAFCP), Tirana, Albania. Available at: <http://orgprints.org/22709/1/berner-and-kazazi-2012-sectorstudy2011-albania.pdf> (accessed Jun 21, 2017)
- Bteich, M. R., Al-Bitar, L., Pugliese, P., Belsanti, V. (2014). Policy support for organic agriculture in EU Candidate and Potential 38 candidate countries. In Meredith, Stephen and Willer, Helga (Eds.) (2014). Organic in Europe - Prospects and Developments. IFOAM EU Group, Brussels.
- El Bilali, H., Despotović, A., Berjan, S., Driouech, N., Kulina, M., & Rusevski, K. (2014). Organic agriculture in the Republic of Macedonia: potential, governance, policy framework and market. *Poljoprivreda i šumarstvo*, vol. 60, no. 1, pp. 15-26.
- Ministry of Agriculture and Rural Development of Montenegro (2012). Nacionalni akcioni plan razvoja organske poljoprivrede 2012-2017. (National Action Plan for the Development of Organic Agriculture 2012-2017), March 2012, Podgorica. In Montenegrin.
- Nikolić, S. R., Vuković, P., Grujić, B. (2017). Measures to support the development of organic farming in the EU and Serbia. *Economics of Agriculture*, vol. 64, no. 1, pp. 323-337.
- Özbilge, Z. (2007). An analysis of organic agriculture in Turkey: the current situation and basic constraints. *Journal of Central European Agriculture*, vol. 8, No. 2, pp. 213-222. Available at: [http://hrcak.srce.hr/index.php?id\\_clanak\\_jezik=27875&show=clanak](http://hrcak.srce.hr/index.php?id_clanak_jezik=27875&show=clanak). (accessed Jun 23, 2017).
- Vittuari M. (2011). Macedonia discovering a green economy. Osservatorio alcani e Caucaso (OBC). Available at: <http://www.balcanicaucaso.org/eng/Regions-and-countries/Macedonia/Macedonia-discovering-a-green-economy-104620> (accessed Jun 21, 2017).
- Willer, Helga and Julia Lernoud (Eds.) (2017). The World of Organic Agriculture. Statistics and Emerging Trends 2017, Research Institute of Organic Agriculture (FiBL), Frick, and IFOAM – Organics International, Bonn. Available at: <http://www.organic-world.net/yearbook/yearbook-2017.html> (accessed Jun, 23, 2017).

## **LAND CONSOLIDATION – A NECESSARY CONDITION AND IMPERATIVE FOR AGRICULTURE PRODUCTION DEVELOPMENT**

Rajko BOŽIĆ<sup>1</sup>, Milan TRIFKOVIĆ<sup>2</sup>, Žarko NESTOROVIĆ<sup>3\*</sup>, Jelena LAZIĆ<sup>4</sup>

<sup>1</sup>Republic Geodetic Authority of Republika Srpska, Banja Luka, Republika Srpska, Bosnia and Herzegovina

<sup>2</sup>Faculty of Civil Engineering, Subotica, Serbia

<sup>3</sup>PC EPS, Djerdap Kladovo, Serbia

<sup>4</sup>Faculty of Technical Sciences, Novi Sad, Serbia

\*Corresponding author: nzarko07@gmail.com

### **Abstract**

Agriculture production development in contemporary social and economic conditions shall be considered from aspect of its economic efficiency. Fragmented holdings which characterize the state of the art of the agricultural property represent the basic and biggest source of superfluous and unnecessary costs of agricultural production. Inadequate infrastructure for agricultural production (property disposition and irrigation systems) as well as unsolved property rights are the crucial factor of inefficient land utilization and consequently reduce the competitiveness of agricultural products on the market. Economic dimension of land consolidation is also not negligible. Bearing in mind today's low price of geodetic works in region it may be considered as a chance for providing land consolidation at a very reasonable costs. Also, low cost of land consolidation is a chance for return on investment in a short period of time with additional benefits of solving property rights and establishing an updated cadastral system. In this paper the model for calculating return on investment period of land consolidation process was used in order to highlight the economic benefit of land consolidation. In spite of the fact that obstacles in land consolidation process exists it is proved in theory and practice that land consolidation remains the best method for agriculture development and land management. This paper aims to point out the significance of land consolidation as a factor of agricultural production development with special emphasis on the state in entity of the Republic of Srpska (Bosnia and Herzegovina).

**Key words:** *Land consolidation, Agriculture development, Parcel, Irrigation systems, economics.*

### **Introduction**

Land is undoubtedly the main source of food and as well today's agricultural economy. Agricultural land as a base for agricultural production is the ultimate source of food production and significant economic resource especially for developing countries. Extensive use of land has a consequence in losses of its characteristics and consequently decreasing its capacity for agricultural production. Considering agricultural land as a non-renewable resource warns the humanity on its importance as well as on its limited utilization.

Degradation of land is an issue of numerous studies but the main characteristic of degraded land is that, "when land becomes degraded, its productivity declines unless the steps are taken to restore that productivity and check further losses" (Piers and Brookfield, 2015). As a consequence of land degradation appears additional costs including time lost for land productivity restoration.

Additional losses in land productivity seem to be also significant and not obvious in short period of time. Extreme farmland ownership fragmentation is becoming a limiting factor for

sustainable land management in some countries, and example of the Czech Republic as a state with extremely high farmland ownership fragmentation shows that this phenomenon can currently determine the land use of up to 40% of the country's farmland (Sklenicka *et al.*, 2015).

According to FAO document (FAO, 2017) the situation about soil resource utilization for agricultural production in Central and Eastern Europe is estimated as follows:

- The great majority of farms are very small, usually under five ha and with many smaller than one ha;
- Farms comprise a number of parcels. About 4-5 parcels in a holding is common and some farmers have over 15 parcels. The size of the parcel is between 0.25 and 0.6 ha.
- Parcels are often some distance apart, sometimes up to 20 km, and can be in different administrative districts.
- Parcels are often awkwardly shaped for agricultural purposes. Some parcels are very narrow and long, e.g. three metres wide and 1 000 metres long.
- Farms are often owned by the elderly.
- Farms are often jointly owned by a number of people.
- Farm owners are often absent, with many living in urban areas.
- Owners sometimes do not have legal titles.

The state of agricultural land according to described situation points out serious problems in land management and also implicates that chances for earning a decent living in both agricultural and non-agricultural sectors in rural areas in Central and Eastern Europe are decreasing. These trends shall to be considered very seriously especially bearing in mind importance of agricultural land and its potential for rural areas development.

Attempts for increasing the chances in land utilization are mainly related to land consolidation. Land consolidation is firstly originated as a tool for grouping small parcels into bigger ones but its development showed that it land consolidation possess potential for solution wider area of rural areas' problems.

Analysing the effects of land consolidation (LC) in Spain for about half of century (since the 1950) the researches formulated five questions as follows (Crecentea and Alvarezb, 2006):

Q1. Has LC influenced property structure in rural areas?

Q2. Has LC influenced land usage?

Q3. Has LC intensified agricultural and forestry production?

Q4. Has LC tended to reduce emigration from rural areas?

Q5. Does the paralysis of LCPs depend on local socioeconomic factors, and if so, on which?

The results of this research are obtained as follows:

Q1. LC has indeed favoured reductions in both the number of plots of land per municipality and the number of plots per active holding.

Q2. LC has lessened the conversion of agricultural land to forestry that is associated with the generalized decline in rural population.

Q3. Regardless of LC activity, there has been an overall increase in land devoted to forestry at the expense of agriculture. However, this trend was almost twice as marked where no LC had been carried out where LC schemas had been implemented.

Q4. The results are that losses of population have been less severe where LC has been carried out than where no LC processes has been completed.

Q5. Here results were that the larger the percentage of the working population is involved in agriculture, the more likely are LC processes to be paralyzed. This may be attributed to the fact that it is harder to design LCPs that satisfy all owners in areas where a relatively large number of owners work a small amount of good-quality agricultural land. Summing up these results it is clear that land consolidation has positive effects whenever it is provided related to areas where it was not.



According to (Đokić and Marošćan, 2017) land consolidation is a very successful instrument that can be used for rural development and as such it should provide:

- Improvement of rural living conditions and not only the improvement of agricultural production;
- Renewal of villages by permanent economic and political development of the community and the protection and permanent management of natural resources;
- Active and democratic participation;
- Assistance to villagers in order to define the new use of community resources and appropriate spatial rearrangement and
- Connection between the elements of wider regional development including between rural and urban area.

Above quoted papers implicate that land consolidation could be considered as a very useful and applicable tool for solving wide area of problems in rural areas. The main questions of land consolidation utilization from aspect of agricultural development are related with its contribution to increase efficiency, other possible gains and costs reduction in agricultural production. In this paper the case of entity of Republic of Srpska (RS) in Bosnia and Herzegovina is analysed.

### Material and Methods

The methodology of land consolidation contribution to agricultural development will be utilized as proposed by Trifković and Nestorović (2017) and slightly modified in order to highlight the agricultural development. Proposed methodology includes only measurable and experiential verified gains from land consolidation. The model for potential contribution of land consolidation to agricultural development is used as follows.

The model of potential contribution of land consolidation to agricultural development is explicated in following way:

$$LC_{CAD} = PC_{ALALC} - PC_{ALBLC} - I_{LC} \quad \dots (1)$$

where:

- $LC_{CAD}$  – Land Consolidation Contribution to Agricultural Development;
- $PC_{ALALC}$  – Production Capacity of Agricultural Land After Land Consolidation;
- $PC_{ALBLC}$  – Production Capacity of Agricultural Land Before Land Consolidation and
- $I_{LC}$  – Investment in Land Consolidation.

Because of different units in which it is possible to explicate the terms in equation (1) it is suitable to use coefficient of land consolidation contribution “ $c$ ” to multiply the term  $PC_{ALALC}$ . Modified equation (1) then could be explicated as follows:

$$LC_{CAD} = PC_{ALBLC} * c - I_{LC} \quad \dots (1a)$$

Considering alternative investment is not utilized in model (1), because importance of aims which shall be reached by land consolidation is crucial.

Mathematical model which describes the period of time in which the return on investments could be expected shall include relation between invested amounts of money and expected additional earnings caused by land consolidation project. It means that expected earning shall be expressed in the same money unit as the invested amount. Then the period of time in which the return on investment could be expected may be calculated in simple way as follows:

$$t = \frac{I_{LC}}{A} \quad \dots (2)$$

Where:

- $t$  – period of time in which investment will be fully returned;
- $I_{LC}$  – amount of invested money and
- $A$  – additional agricultural production per year as a consequence of land consolidation project expressed in same money units.

In that case formula (1), including express of additional agricultural production in units of money, will read as follows:

$$t = \frac{I_{LC}}{A * p} \quad \dots (3)$$

where  $p$  is the price per unit of additional agricultural production.

Equation (3) also could be explicated as:

$$t = \frac{I_{LC}}{PC_{ALBLC} * c * p} \quad \dots (4)$$

Production capacity of land is considered only from aspects of increased agricultural area (which is estimated on 10%) and increased production (estimated on 2%). Another gains obtained by land consolidation such as: improved irrigation systems, road networks through agricultural land and additional benefits discussed by (Crecentea, and Alvarezb, 2006) and (Đokić and Marošán, 2017) were not included in model.

Benefits of land consolidation as well as natural process of parcels fragmentation creates the need of repeating land consolidations especially in regions with high value of land or high potential of agricultural production.

For entity of RS according to “Statistical Yearbook of Republika Srpska 2014” there exists 582 000 of hectares of arable land and gardens thereof the 136,000 of hectares are sown by maize and 45,000 hectares are sown by wheat. The production of maize and wheat is 550,000 of tones and 180,000 of tones respectively. This means that average production is approximately 4 tonnes per hectare both for maize and wheat.

## Results and Discussion

The relevant data in this research for entity RS, according to Republic Geodetic Authority of Republika Srpska are:

- Population: 1,425,549;
- Households: 408,825;
- Cadastral municipalities: 1670;
- Cadastral parcels: 3,986,799 and
- 843,525 legal owners.

Presented data indicate that average owner possess approximately 5 parcels which is in accordance with above mentioned FAO result. Also bearing in mind that land consolidation was not provided in entity RS other results may be considered accordant with the situation in Central and Eastern Europe. This assumption implicate that there exist potential for agricultural production development in RS.

Assuming:

- $c = 0.10 + 0.02 = 0.12$

- $PC_{ALBLC} = 730,000$
- $I'_{LC} = 200 \text{ €/ha}$
- $p = 100 \text{ €/t}$

and using formula (1a) we obtain

$$LC_{CAD} = PC_{ALBLC} * c = 87,600 \text{ ha}$$

where  $LC'_{CED}$  denotes the potential contribution of land consolidation to agricultural productivity. As said before this contribution includes only benefits from grouping fragmented parcels and increased agricultural productivity caused by rearranged and consolidated land property. Other benefits including reduced costs for agricultural production, reduced time for agricultural works and increased efficiency are not included in model.

Assuming that all 730,000 hectares will be included in process of land consolidation the total investment in land consolidation will be

$$I_{LC} = I'_{LC} * 730,000 \text{ ha} = 200 \frac{\text{€}}{\text{ha}} * 730,000 \text{ ha} = 146,000,000 \text{ €}$$

Land consolidation contribution to agricultural development after land consolidation explicated in € is as follows

$$LC_{CAD} = PC_{ALBLC} * c = 87,600 \text{ ha} * 100 \frac{\text{€}}{\text{t}} * 4 \frac{\text{t}}{\text{ha}} \cong 35,000,000 \text{ €}$$

Using formula (4) we obtain:

$$t = \frac{I_{LC}}{PC_{ALBLC} * c * p} = \frac{146,000,000 \text{ €}}{35,000,000 \frac{\text{€}}{\text{year}}} = 4.17 \text{ year} \quad \dots (4)$$

Utilization of proposed model with data for entity of Republic of Srpska (Bosnia and Herzegovina) resulted with return on investment period of approximately 4 years. This result, even though considered as imprecise is important. The importance of this result is explicated by its only economical meaning. Other benefits as a consequence of land consolidation could be only positive and additionally shortening the period of return on investment.

### Conclusion

Land consolidation is an inevitable tool for successful land management. Utilizing land consolidation wide spectra of problems in land management could be solved but also lot of additional benefits could be obtained. Considering land consolidation strictly economically, even excluding a benefits which hardly could be measurable in the phase of its planning, the results indicate that period of return on investment is very short (in case of entity Republic of Srpska that period is approximately 4 years). That fact favours land consolidation as a toll which shall be considered seriously in decision making for agricultural development. It is possible to state that absence of land consolidation disables agricultural development. In that sense, especially for countries in economic development the land consolidation could be treated as imperative and necessary condition for agricultural development.

## References

- Blaikie, Piers, and Harold Brookfield, eds. (2015). *Land degradation and society*. Routledge.
- Sklenicka, P., Janovska, V., Salek, M., Vlasak, J., & Molnarova, K. (2014). The Farmland Rental Paradox: extreme land ownership fragmentation as a new form of land degradation. *Land Use Policy*, 38, 587-593.
- FAO Corporate Document Depository, Produced by Economic and Social Development Department, Title: “ The design of land consolidation pilot projects in Central and Eastern Europe”, FAO. <http://www.fao.org/docrep/006/Y4954E/y4954e05.htm> (January, 2017)
- Crecentea, R., and Alvarzeb, M. F. (2006). "Land consolidation in inland rural Galicia, NW Spain, since 1950: An example of the formulation and use of questions, criteria and indicators for evaluation of rural development policies\$." *Land Use Policy* 23: 511-520
- Đokić, V., Marošán, S. (2017). New model of land consolidation and rural development in Serbia, *spatium* 61, <http://www.doiserbia.nb.rs/img/doi/1450-569X/2008/1450-569X0818061D.pdf>
- Trifković, M., Nestorović, Ž. (2017). Land consolidation and its potentials for economic development in Serbia, 6th International Scientific Tourism Conference, Vrnjacka banja, 202-209.
- Statistical Yearbook of Republika Srpska 2014, Agriculture and fishery; [http://www2.rzs.rs.ba/static/uploads/bilteni/godisnjak/2014/14pol\\_2014.pdf](http://www2.rzs.rs.ba/static/uploads/bilteni/godisnjak/2014/14pol_2014.pdf) (August, 2017)

## **AN EVALUATION OF MARKET PARTICIPATION OF SMALLHOLDER FARMERS IN EHLANZENI DISTRICT, MPUMALANGA PROVINCE, SOUTH AFRICA**

Phokele MAPONYA<sup>1,2\*</sup>, Sonja Louise VENTER<sup>1</sup>, Christian Philippus DU PLOOY<sup>1</sup>, Erika VAN DEN HEEVER<sup>1</sup>

<sup>1</sup>Agricultural Research Council-Vegetable and Ornamental Plant, Pretoria, South Africa

<sup>2</sup>University of Johannesburg, Department of Geography, Environmental Management and Energy Studies, South Africa

\*Corresponding Author: maponyap@arc.agric.za

### **Abstract**

This paper highlights the factors affecting market participation of rural small-scale farmers in Ehlanzeni South District Municipality. Project assessment was conducted in Ehlanzeni South District by the Agricultural Research Council (ARC) in collaboration with the Department of Rural Development and Land Reform (DRDLR) with an attempt to identify market needs in the district. A total of 54 horticultural projects with 538 beneficiaries participated in the study, coming from the following local municipalities: Mbombela, Umjindi and Nkomazi. Quantitative and qualitative designs were used as a detailed questionnaire written in English, with a focus group discussion, stakeholder's discussion and field observations as part of the data collection. A purposive sampling technique was used to select fifty-four (54) projects, in order to cover uniformity and homogenous characteristics, such as infrastructure requirements, skills availability, production challenges, agricultural training needs, water source needs, educational level, market availability and other factors. Data were coded, captured, and analysed using SPSS. The descriptive and univariate regression analyses were conducted. The results showed a positive association among the following variables: age, educational level, farming experience, land size, planted crop, water source, land acquisition, production inputs, fulltime farming, agricultural training and market participation. It is evident that interventions should be implemented, with a focus on the identified factors in order to improve market participation of small-scale farmers.

**Key words:** *Market Participation, Horticultural Projects, Ehlanzeni South District Municipality, Mpumalanga Province and South Africa.*

### **Introduction**

Smallholder farmers, irrespective of their selected farming niche are faced with many difficulties before being able to enter the market. Most smallholder farmers lack the knowledge, information and resources required to meet formal market specifications. Baloyi (2010), stress that it is easy to link farmers to markets, but it is difficult for a smallholder farmer to satisfy the market. A lack of formal contractual agreements to enable them to meet these requirements further discourage these farmers from investing in such an enterprise. In addition, these requirements (quality of the product, sanitary measures) are that they overwhelm the technical and organisational capacities of the small entrepreneur (Bienable and Sautier, 2005). In South Africa there is a dual agricultural sector, dominated on the one hand by modern capital intensive organised agriculture, and on the other, by a tradition subsistence small-scale communal sector. According to Barret, 2007; Machete et al., 1997 since 1980s, market liberalisation has prompted rapid industrialisation of the agricultural

sector. This created both new opportunities and challenges for smallholder farmers in South Africa. Agro-industrialisation has stimulated an improved agricultural industry, with farmers and agribusiness being able to position themselves in a globally competitive environment. This has increased the gap between the small-scale communal and extensive capital intensive agricultural sectors. According to Bienable and Sautire (2005) the exclusion of small farmers from dynamic markets emanates from current economic and historical perspectives. As a result, these farmers are economically neither enough in the production environment for successful integration into the mainstream agribusiness, nor are they empowered to commercialise their production. Agriculture in Ehlanzeni District has annual turnover of R1, 5 billion consisting of subtropical fruit farming and processing, avocados, bananas, mangoes, litchis, macadamia nut, sugar cane cultivation by large and small-scale farmers and sugar production at two mills producing nearly 20% of South Africa's sugar (EDM, 2014). Ehlanzeni produces 16% of South Africa's citrus crop and export 70% (EDM, 2014).

The key rationale for the study was based on the South African government focus on establishing agricultural markets in 44 districts in South Africa. Two billion rands was allocated by President Jacob Zuma to Department of Rural Development and Land Reform during 2015 state of the nation address for the establishment of agricultural markets. The establishment of this markets will ensure increased production and consumption of fruit and vegetables, creating a complete and viable agro-value chain that will expand community-driven agricultural production and processing, enhance the role of horticultural crops in addressing the immense malnutrition problem of vulnerable groups in South Africa and to capacitate rural communities to reduce wastage of produce, address food security and add value through small-scale agro-processing operations. The Agricultural Research Council (ARC) is involved in an agricultural project in the Ehlanzeni South district in Mpumalanga Province where beneficiaries were trained and mentored so as to implement sustainable production and develop markets. In the present study, research was conducted with the overall aim of establishing if sustainable agricultural markets are viable in the Ehlanzeni South district. The major objectives were: (1) To identify and describe the characteristics of selected agricultural projects in the Ehlanzeni South district (Table 1 – Table 4). (2) To determine factors that affect decision making to participate in agricultural markets in Ehlanzeni South district (Table 5).

### **Materials and methods**

The research used quantitative and qualitative methods. A detailed questionnaire written in English was developed as a quantitative data collection method. The questionnaire used both open and closed ended questions. Qualitative data collection method included focus group discussions and field observations. As part of standard protocol for conducting the study, meetings were held with all stakeholders in the Ehlanzeni South district namely: (1) Local municipalities, (2) Department of Agriculture, Forestry and Fisheries (DAFF), (3) Department of Rural Development and Land Reform (DRDLR), (4) Local economic agencies and (5) Local farmers. The aim of the meetings was to introduce and explain the aim of the study. A purposive sampling technique was used to select 54 agricultural projects. The sampling was used to assess uniformity and homogenous characteristics like infrastructure needs, skills availability, production challenges, agricultural training needs, and water source needs, educational level, land acquisition, size of land farming experience, source of water, inputs and implements used. Agricultural projects visited in the Ehlanzeni South district were prioritized based on the agriculture potential of the area namely project type, numbers of projects around an area, size of the land, chances of extending production, water availability, commitment of members to their projects, internal conflicts and working material and

infrastructure. As indicated in Figure 1, Ehlanzeni South district has 3 local municipalities, namely: Mbombela, Umjindi and Nkomazi (StatsSA, 2011).

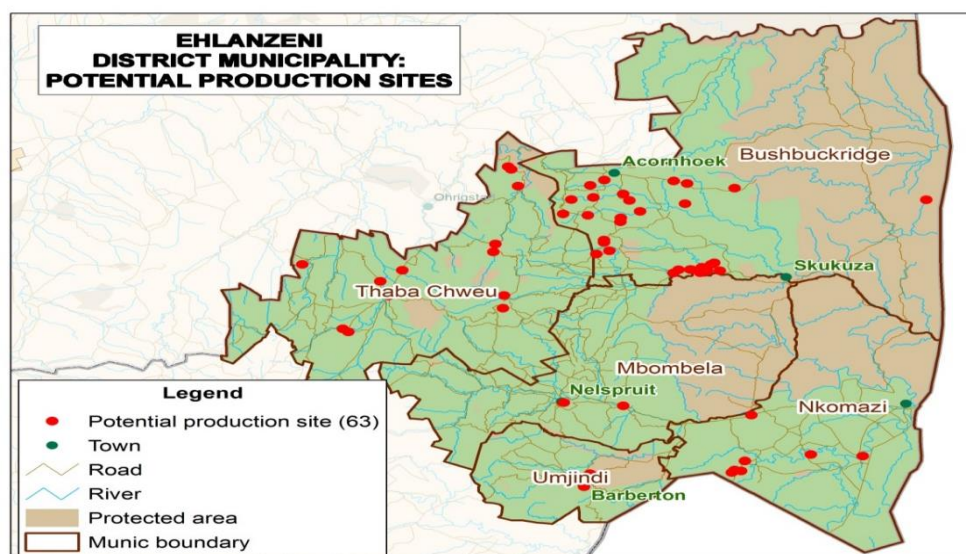


Figure 1: Ehlanzeni District Map

### Results and Discussion

A total of 54 projects in 3 local municipalities were visited and they all formed part of the AgriPark project. As shown in Table 1, three local municipalities were visited: Mbombela (35%), Umjindi (11%) and Nkomazi (54%). Agricultural projects visited were prioritized based on the agriculture potential. Ehlanzeni South District has a total of 538 beneficiaries and spread across local municipalities: Mbombela (179), Umjindi (61) and Nkomazi (298).

Table 1: Ehlanzeni South projects per local municipality

Local municipality	Projects	% per Local Municipality
Mbombela	19	35
Umjindi	6	11
Nkomazi	29	54
<b>Total</b>	<b>54</b>	<b>100</b>

The age distribution of project respondents indicated that the majority were in the age group of 46 – 60 (40%). As indicated in Table 2, youth involvement is 17%, 36 – 45 (13%) while > 61 had 30%. In this project, 19% had incomplete primary education, 28% had completed primary education, 4% had incomplete secondary education, 44% of project respondents had completed secondary education and 5% had completed tertiary education. The results in Table 2 indicated gender composition with females at 35.2 % and males at 64.8 %. Majority of farmers (96%) were farming full time (Table 2). This results are in line with project sampling criteria, which targeted fulltime farmers.

Table 2: Ehlanzeni South District Age, Gender, Educational level and Employment characteristics

	Respondents	% of Socio- economic Characteristics
<b>Age (Years)</b>		
18 – 35	9	17
36 – 45	7	13
46 – 60	22	40
>61	16	30
<b>Total</b>	<b>54</b>	<b>100</b>
<b>Gender</b>		
Male	35	64.8
Female	19	35.2
<b>Total</b>	<b>54</b>	<b>100</b>
<b>Educational level</b>		
Primary education incomplete	15	28
Primary education completed	10	19
Secondary education incomplete	2	4
Secondary education completed	24	44
Tertiary education completed	3	5
<b>Total</b>	<b>54</b>	<b>100</b>
<b>Employment Status</b>		
Farming Full time	52	
96		
Farming fulltime, working part-time	1	2
Farming fulltime, unemployed	1	2
<b>Total</b>	<b>54</b>	
<b>100</b>		

Table 3 indicated that most projects were engaging in informal markets (70.4%) with 16.7 % trading in both formal and informal markets. Ehlanzeni South district projects have been presented to Fruit and Vegetable City and Woolworths SA. Supermarket chains like Woolworths, Fruit and Vegetable City, Massmart etc. provide lucrative market for smallholder farmers. According to Reardon and Barret (2000) these linkages between smallholder and supermarket chains is only limited to smallholder farmers that meet product variety and quality standards. Smallholder farmers in Ehlanzeni South district often find their prices undercut by produce that informal traders buy from commercial farmers.

Table 3: Ehlanzeni South District markets access per project

Markets access	Projects	% of Market Access
Formal market	7	13
Informal market	38	70.4
Formal and Informal Markets	9	16.6
<b>Total</b>	<b>54</b>	<b>100</b>



A large percentage (50%) of projects utilized 1-5 hectares (Table 4) while 28 % utilized (6 – 10 hectares). Some projects were using different land sizes as indicated in Table 4. This results indicated Ehlanzeni South district is dominated by small scale farmers and more support is needed to enable them to be commercial as recommended to other district (Maponya et al., 2014 and Maponya et al., 2015).

Table 4: Ehlanzeni South District land size per project

Size (Ha)	Projects	% of Land Size
1- 5	27	50
6-10	15	28
11- 20	7	13
21- 49	1	2
50>	4	7
<b>Total</b>	<b>54</b>	<b>100</b>

Results in Table 5 showed that there is positive association among the following variables; age, education, farming experience, land acquisition, land size, crops planted, water sources, agricultural training, production inputs, farming fulltime and market participation. This was supported by more than 1 estimate values at the 95% confidence interval. The results in Table 5 further predicted 82 % (R - squared = 0.82) variation in the dependent variable was explained by the independent variables. Prediction accuracy were assessed based on the coefficient of determination (R - squared). The coefficient of determination R- squared was used to explain the total proportion of variance in the dependent variable explained by the independent variable. The R- squared removes the influence of the independent variable not accounted for in the constructs. R-squared is always between 0 and 100%. In general, the higher the R-squared, the better the model fits the data.

It must be emphasised that social-demographic characteristics of the farmers play a very important role in either promoting or impeding their participation in agricultural markets. As indicated in Table 5, farmers age had a positive association with market participation (>1). Studies by Barret (2007) indicated that younger farmers participated more in the market because they are more receptive to new ideas and are less risk averse than older farmers. This information is in line with studies by Maponya et al. (2014); Maponya et al. (2015) and Makhura (2001) who found that age is positively associated with market participation. There is a positive association among farming experience, farming fulltime, education and market participation as indicated in Table 5. A well-educated, fulltime farmer with experience will always understand market conditions better and will enhance smallholder farmer's market orientation. Advancement in education increases the education level and the ability to obtain better market information Maponya et al., (2015) and Makhura (2001). Agricultural training is also positively associated with market participation as smallholder farmers need to be equipped with technical skills to improve their productivity and to negotiate in the agricultural markets.

As indicated in Table 5, there is a positive association among land acquisition, land size and market participation (>1). Land acquisition and size are generally acknowledged to be a necessary condition for agricultural growth and development and ultimately successful agricultural commercialization of smallholder farmers. Smallholder farmers with land and bigger land size were found to participate more because of their ability to produce bigger volumes to the market. According to Alene et al., (2008) land acquisition and land size enables smallholder farmers to produce surplus to the market. The results are also in line with

Azam et al., (2012) who recognised that Cambodian farmers with larger land sizes are more likely to participate in the markets. A positive association existed between production inputs and market participation (>1). Production inputs availability will go a long way in improving smallholder's farmer's participation in the market. Majority of smallholder farmers in Ehlanzeni South district have on several occasions been supplied with fertilisers by both local and provincial government in order to assist them in their farming operations and enhance productivity. According to Van Schalkwyk et al., (2012) production inputs used is an important determination of smallholder access to agricultural markets. The research had distributed sweet potatoes cultivars and fruit trees as part of popularising Agricultural Research Council cultivars. Production inputs were also distributed as it was found that low crop yields was attributed to farmers to use improved inputs and it led to lack of competitive production and low market participation. As shown in Table 5, there is a positive association among water sources, crop planted and market participation. This is true as available water resources and their level of assurance of supply would inform types of crops to be planted at specific times to avoid crop failure (Evans and Sadler, 2008). Thus ensuring long sustainability of water sources and crops planted will accelerate production and market participation.

Table 5: Univariate Regression Analysis of factors affecting market participation in Ehlanzeni South District

Variable	Total	(%)	OR [95%CI]
Farming Experience	54	100	1.11[0.45-303]1
Age	54	100	1.34[0.058-2.9]1
Land Acquisition	54	100	1.09[0.272- 3.9]1
Education	54	100	1.29[0.226- 13.6]1
Farming fulltime	54	100	1.33[0.23-4.3]1
Land Size	54	100	1.05[0.24-5.57]1
Crops Planted	54	100	1.11[0.18-4.5]1
Water Source	54	100	1.07[0.10- 5.011]1
Agricultural Training	36	66.7	1.12[0.28 - 4.88]1
Production Inputs	54	100	1.66[0.18 - 4.14]1

OR= Odds ratio; 95%CI = 95% confidence intervals; 1< = no association; 1> = association

### Conclusions and Recommendations

Different socio-economic characteristics of smallholder farmers were described and determined. It is apparent that factors like age, educational level, farming experience, land size, crop planted, water source, land acquisition, production inputs, farming fulltime, agricultural training positively influences the decision to participate in the market. The identified factors will affect the manner in which smallholder farmer's benefit from the opportunities available in the agricultural markets in respect of the quality and quantity of the agricultural produce. It is expected that addressing such factors may create enabling conditions that would encourage smallholder farmers to access and participate more effectively in markets. Such efforts could improve the ability of smallholder farmers to become part of the mainstream or commercial agricultural economy. Based on the findings, the research recommends that for holistic market participation among smallholder farmers in Ehlanzeni South District, the government and other policy makers should increase the

knowledge, experience and skills of farmers. This will go a long way in assisting farmers to supply quality products to the market and improve their livelihoods.

### **Acknowledgements**

The authors wish to acknowledge the following: Department of Rural Development and Land Reform for funding. The following Departments/Research Institutes / Local Municipalities are acknowledged: Mpumalanga Province Department of Agriculture; Ehlanzeni South District; Ehlanzeni Local Municipalities; Ehlanzeni South Local Farmers; Ehlanzeni Local Economic Development Agencies and Agricultural Research Council.

### **References**

- Alene DA., Manyong V.M., Omany G, Mignouna H.D., Bokanga.M & Odhiambo G.D. (2008). Smallholder marketed surplus and input use under transactions costs: Maize supply and fertilizer demand in Kenya. *Food Policy* 32(4):318–328
- Azam M.S, Imai K.S & Gaiha R. (2012). Agricultural supply response and smallholders market participation - the case of Cambodia. Discussion Paper, Research Institute for Economics and Business Administration, Kobe University, 2012.
- Baloyi J.K. (2010). An analysis of constraints facing smallholder farmers in the Agribusiness value chain: A case study of farmers in the Limpopo Province. Unpublished dissertation retrieved on 25th March 2013 from: <http://upetd.up.ac.za/thesis/available/etd-195609/unrestricted/dissertation.pdf>
- Barret C.B. (2007). Smallholder Market Participation: Concepts and Evidence from Eastern and Southern Africa. *Food Policy*, 4, 33.
- Bienabe E. & Sautier D. (2005). The role of small scale producers' organizations in addressing market access. Paper presented at the International Seminar beyond Agriculture: Making Markets Work for the Poor, London, 28 February-1 March.
- Ehlanzeni District Municipality (EDM). (2014). Ehlanzeni District Municipality 2013/14 IDP review, Mpumalanga province.
- Evans R.G & Sadler E.J. (2008). Methods and technologies to improve efficiency of water use. *Water Resources Res.* 44:1–15.
- Machete C, Reardon T & Mead D. (1997). Promoting farm/non-farm linkages for employment of the poor in South Africa: A research agenda focused on small scale farms and agro industry, *Development Southern Africa*, 14(3) 377 – 394.
- Makhura M.T. (2001). Overcoming Transaction Costs Barriers to Market Participation of Smallholder Farmers in the Northern Province of South Africa. PhD Dissertation. Pretoria: University of Pretoria
- Maponya P.I., Modise D, Van Den Heever E, Mahlangu S, Baloyi T, Maluleke A, Carsten J, Van Der Walt M, Chauke D, Mkhari R, Sole L, Duba M, Malebana J & Mphahlele M.(2014). Establishment of Fruits and Vegetables Markets: A case of Waterberg District in Limpopo province, *Journal of Agricultural Science* Vol. 6 (6), June 2014.
- Maponya P, Venter S.L., Modise D, Van Den Heever E, KekananV, Ngqandun P, Ntanjana N & Pefile A. (2015). Determinants of Agricultural Market Participation in the Sarah Baartman District, Eastern Cape of South Africa, *Journal of Human Ecology*, 50 (1) 1 - 9, 2015.
- Reardon T & Barrett C. (2000). Agro-industrialization, globalization, and international development: An overview of issues, patterns, and determinants. *J. Agric. Econ.* 23(3): 195 -205.

- StatsSA (Statistics South Africa). (2011). Community survey 2007. Statistics South Africa, Pretoria.
- Van Schalkwyk H.D, Groenewald J.A., Fraser G.C.G, Obi, A & Van Tilburg A. (2012). Unlocking markets to smallholders: Lessons from South Africa. Mansholt Publication series, 10. The Netherlands.

## DEVELOPMENT OF THE PROTOTYPE APPLICATION OF A WIRELESS SENSOR NETWORK AND INTERNET OF THINGS FOR GREENHOUSES

Mehmet Ali DAYIOGLU<sup>1\*</sup>, Furkan UGUR<sup>2</sup>, Ufuk TURKER<sup>1</sup>

<sup>1</sup>Ankara University, Department of Agricultural Machinery and Technologies Engineering, Ankara, Turkey

<sup>2</sup>Ministry of Food Agriculture and Livestock, Department of Training Extension and Publications, Ankara, Turkey

\*Corresponding author: dayioglu@agri.ankara.edu.tr

### Abstract

Nowadays, new technological developments in smart farming have contributed to horticulture, greenhouse, and livestock production. Wireless Sensor Networks (WSN) and Internet of Things (IoT) technologies can be used in data-driven intelligent agriculture applications. With the more efficient use of energy, water and fertilizers, the increase in productivity and efficient management of all processes from production until storage can be provided by using WSN and IoT technologies. The correct irrigation, fertilization and pesticide spraying applications will contribute to low cost production and the protection of the environment, as well as making things easier of farmers. The local agro-meteorological and field data based on sensors are important. These data can be used to evaluate meaningful outcomes for risk estimation, agricultural insurance, financial support and compensation mechanism. In this study, a cheap prototype system for greenhouses was developed by using WSN and IoT technologies. The system consists of four wireless sensor nodes: one master node and three slave nodes. A Raspberry Pi-2 board was used as the master computer. A DS18B20 temperature sensor was used for each node. Raspbian Linux OS run the master computer to measure the temperature of master nodal point, link wireless with slave nodes, and record data coming from slave nodes. As slave nodes, a Raspberry Pi-2 board, a NodeMCU module and an ESP8266 WiFi module were used. The air, substrate, leaf and water temperatures for soilless crop cultivation applied in greenhouses were measured in real time. Data coming from slave nodes were recorded on the SD card of the master node.

**Keywords:** *Smart farming, Greenhouse, Internet of things, Wireless sensor network.*

### Introduction

Agriculture, which provides the employment in large-scale for peoples, plays a vigorous role in economy of countries. However, agriculture is highly dependent upon weather and climate due to changes in temperature, soil moisture and carbon dioxide. In order to manage crop growth and increase the agricultural production yield, the monitoring of environmental parameters is important (Cao-hoang and Duy, 2017). The recent developments in the area internet of things based on wireless sensor networks have created many opportunities for environmental monitoring. Wireless sensor networks (WSNs) consist of in a large number of sensor nodes distributed to monitor the physical environment. Sensor nodes distributed in the wireless sensor networks can be used to sense the change of single or multiple physical parameters (Dargie and Poellabauer, 2010). Internet of Things (IoT) has emerged as a technological revolution which relies on the development of wireless sensor networks, cloud computing and information sensing (Padalkar and Pacharaney, 2016). IoT has provided flexible access among the objects over the internet according to different structural characteristics of each sector in environment, industry, agriculture, health, security sectors

(Borgia, 2014; FAO, 2015; ITU and Cisco, 2016).

IoT and WSN technologies have provided the more efficient use of energy, water, fertilizer, fuel and resources, as well as increasing productivity by using smart systems and machines in agriculture. In agriculture, all processes including cultivation, production, storage and distribution of plants can be efficiently managed via IoT (ITU and Cisco, 2016).

In recent years, many studies and projects based on IoT and WSN had conducted: Cropinfra Platform (Blank *et al.*, 2013), iGreen project (Pesonen *et al.*, 2014), weather forecasting, wildlife management, forestry, livestock farming, market identification and rural financing in rural areas (Dlodlo and Kalezhi *et al.*, 2015), applications on precision irrigation, fertilization and climate management (Guo and Zhong, 2015), using a wireless sensor information archive (Wisekar) in India (Sarangi *et al.*, 2016), using a wireless sensor network for greenhouses (Ugur, 2016). Local sensor information including air and soil temperatures, relative humidity of air, soil moisture levels, solar radiation, wind direction and wind speed, atmospheric pressure, rainfall, soil electrical conductivity can be measured, and local image information can be obtained. These data can be used to evaluate meaningful outcomes for risk estimation, agricultural insurance, financial support and compensation mechanisms (FAO, 2015; ITU and Cisco, 2016). Temperature, relative humidity, light, carbon dioxide levels in the greenhouses are important for plant health, yield and quality. This information involving real-time data can be used for saving energy, water and fertilizer. In this study, a cheap prototype system was developed, which could be measure the temperatures at different points with wireless sensor nodes that could be connected to internet, intranet and web network by using Internet of Things technology.

## Material and Methods

The prototype system involves four sensor nodes, one of which is master node that is used of Raspberry Pi 2 board, three of which are slave nodes that are used Raspberry Pi 2 board, NodeMCU-v2 and ESP8266-01 modules. One DS18B20 temperature sensor for each sensor node is used to develop prototype applications. A DS3231 module was connected to master node for measuring with real time clock (RTC).

The system was designed based on three-layer architecture: user layer, software layer and hardware layer (Figure 1). User layer covers all devices, such as personal computers with internet access, smart phones and other smart devices. Software layer performs database, Web server and data processing tasks. Hardware layer includes single card ARM computer, sensor and wireless modules.

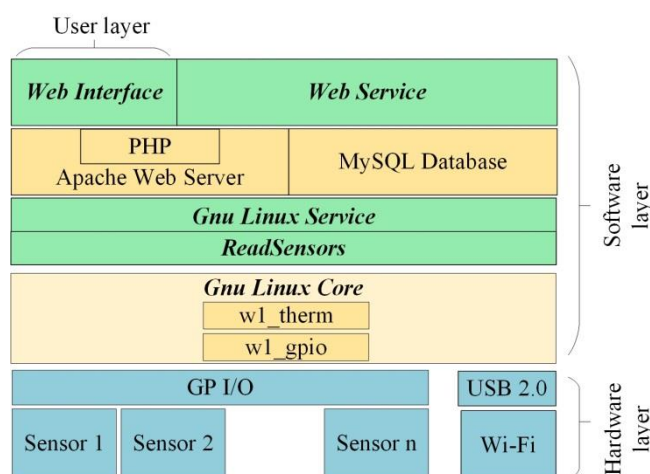


Figure 1. Three-layer architecture for WSN

The wireless sensor network was designed according to star topology. The wireless sensor nodes are programmed according to the hardware and software specifications of the system. The wireless sensor network system proposed for IoT in greenhouses is shown in Figure 2. WSN involves a master node (SN 1) and three slave nodes (SN 2, SN 3, SN 4). Raspberry Pi 2 Model B board was used as master node. For wireless access on Raspberry Pi 2 board, a wireless network adapter (ZyXEL NWD-270N) was used. DS3231 module was used to determine the real-time as independent from internet. DS18B20 sensors were used to measure the temperatures of various mediums at different positions in greenhouse. Nodes were programmed as based on the one wire protocol for master and slave operating modes. The 64-bit serial number of each sensor was assigned as address information. A single program was written to use in both master and slave nodes of network.

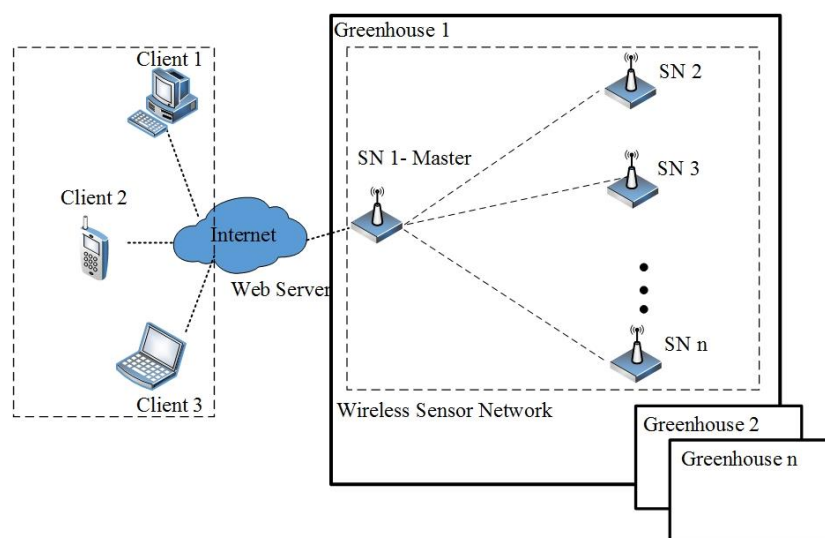


Figure 2. Greenhouse wireless sensor network system for IoT

IP (Internet Protocol) address and API (Application Program Interface) key were defined for each slave node. API keys were entered as same code in all nodes. Internet access of the sensor network inside the greenhouse was activated on only master node. If the serial number of each sensor corresponds with the node number, the measurements are made, and results are returned. After reading the temperature data, a cyclic redundancy check (CRC) was performed. The confirmed data set including “*node nickname*”, “*serial number of the sensor*” and “*temperature data*” were stored in database of the master node.

The backbone of system was set on software sub-structures involving Linux service, Web service and user interface. The Linux service is the most important component of the system. It is responsible for preparing the service core modules, taking measurements from the sensors at specified time intervals and sending these measurements to the local or remote server. The service software was compiled using the Mono C # compiler. The web service bridges between the Linux service and the intranet-database server, and stores in the database the information read from the sensors. To protect from the unauthorized access the system, the web service compares the data packet incoming with the API key at the node. In the case of API key matching, data packet stores in the database. The user interface of the system is prepared with Html5, PHP, JS and CSS and was designed to be flexible for installation and remote monitoring of nodes. The interface was improved with the help of Bootstrap 3 CSS framework to improve user efficient. The measurement results can be accessed by using the web interface and the sensor node input information; the configuration of nodes can be easily done. A password authentication feature was added to the system to prevent unauthorized attempts. For this purpose, two different functions were defined for the user interface: Active

user functions and passive user functions. User can monitor measurement results and can change node settings by active functions. On the other hand, the passive user only uses the node-tracking feature. The authority of the logged-on person was restricted to browsing the node's general information and monitoring the measurement results.

The prototype system was made up of a four-node wireless sensor network that can be connected to the Web environment. Experiments were carried out under laboratory and greenhouse conditions at Department of Agricultural Machinery and Technologies Engineering of Ankara University. The field trials of the system were carried out between July 29 and August 1, 2016 in a greenhouse having a size of 64 m<sup>2</sup>, covered with polycarbonate, with steel construction and suitable for a soilless production substructure. Figure 3 shows the positions (a) of the wireless sensor nodes (b) in greenhouse. API key and the measurement interval were set as "1234567890" and one minute, respectively.

Air temperature ( $T_A$ : SN-1), substrate temperature ( $T_S$ : SN-2), crop leaf temperature ( $T_L$ : SN-3) and water temperature ( $T_W$ : SN-4) were measured in real time. IP values for master and slave nodes were "192.168.42.1", "192.168.42.36", "192.168.42.31" and "192.168.42.45", respectively.



Figure 3 (a) Positions of sensor nodes in greenhouse, (b) Greenhouse experiments

## Results and Discussion

The prototype WSN system proposed for greenhouses was developed as simple application. In this study, unlike study done by Ugur (2016), no wireless gateway was used. Furthermore, the cheaper NodeMCU-v2 and ESP8266-01 modules were used. Sensor nodes were set up via Wi-Fi connection of laptop, tablet or mobile phone; and the streaming data were monitored. Data of master node and slave nodes were recorded in real time to SD card on the Raspberry Pi 2 board.

The daily variations of temperatures in various mediums given in Figure 3 (a) are graphically shown in Figure 4. Average temperatures for the air, substrate, leaf and water mediums measured by sensor nodes were calculated as 26.74°C, 25.81°C, 24.57°C and 23.86°C, respectively. Although the expected number of data to be retrieved is 17,284, 17,260 of which were received. Only 24 data (13 data of SN-3 and 11 data of SN-4) were lost. The wireless data transfer without being error is at rate of 99.86%. Information detailed about experiments is given in Table 1.



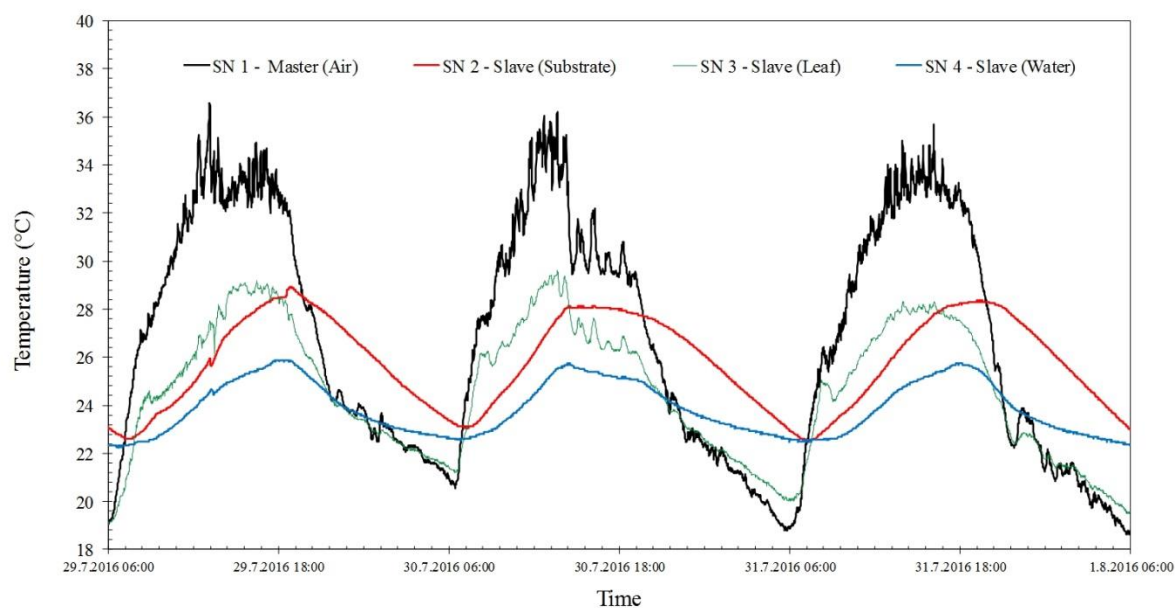


Figure 4. The daily variations of air, substrate, leaf and water temperature data.

Table 1. Information detailed about greenhouse experiments.

	Master Node (1)	Slave Node (2)	Slave Node (3)	Slave Node (4)
Data number	4321	4321	4308	4310
Minimum	18.62	22.56	19.13	22.25
Maximum	36.56	28.94	29.63	25.88
Average	26.74	25.81	24.57	23.86
Standard deviation	4.94	1.89	2.75	1.11

Temperature data measured in the greenhouse were used to determine microclimatological information. Information detailed about physical, biological, and chemical environments around the greenhouse was obtained by using wireless sensor nodes to be placed to different positions. Greenhouses can be managed like an industrial facility. The management organization can be integrated based on energy and climate management, water-fertilizer management, disease-quality management.

### Conclusions

A prototype system consisting of four wireless sensor nodes was designed by using ARM based mini computers and Wi-Fi modules. The system was programmed as master and slave nodes for temperature measurements in the scope of IoT technology. The nodes with different hardware and cost were used in the same system. The performances of those were tested for simple and inexpensive solutions. Thanks to the embedded web server on the master node, it is possible to use the system via intranet without internet connection. A network adapter that is compatible with Linux for access to other wireless nodes and clients such as mobile phones, tablets and laptop computers over master node was used. For this reason, there is no need to use a wireless gateway in the system. The system was designed, and programmed to be multifunctional.

The fact that hundreds of wireless sensor nodes will be used in future systems will be important for ensuring cheap solution.

Wireless sensor network and IoT technologies have expected to provide a flexible and inexpensive solution to many agricultural applications such as climate management for

greenhouses, water management for vineyard and field, weather forecasting, plant-animal disease tracking, transportation and storage of agricultural products.

### **References**

- Blank S., Bartolein C., Meyer A., Ostermeier R., Rostanin O. (2013). “iGreen: A ubiquitous dynamic network to enable manufacturer independent data exchange in future precision farming”. *Computers and Electronics in Agriculture* 98: 109–116.
- Borgia E. (2014). (2015). “The Internet of Things vision: Key features, applications and open issues”, *Computer Communications*, 54: 1–31.
- Cao-hoang N., Duy C.N. (2017). Environment Monitoring System for Agricultural Application Based on Wireless Sensor Network Seventh International Conference on Information Science and Technology, Da Nang, Vietnam; April 16-19, 2017, 99-102.
- Dargie W.W., Poellabauer C. (2010). *Fundamentals of wireless sensor networks: theory and practice*. John Wiley & Sons.
- Dlodlo N., Kalezhi J. (2015). The Internet of Things in Agriculture for Sustainable Rural Development. *IEEE International Conference on Emerging Trends in Networks and Computer Communications*, Page: 13 – 18, Windhoek, Namibia,
- FAO (2015). *Success stories on information and communication technologies for agriculture and rural development*. FAO Regional Office for Asia and the Pacific, Pages: 94 p, Bangkok.
- Guo T., Zhong W. (2015). “Design and Implementation of the Span Greenhouse Agriculture Internet of Things System”, *IEEE International Conference on Fluid Power and Mechatronics*, 398-401, August 5-7, 2015, Harbin, China
- ITU and Cisco (2016). *Harnessing the Internet of Things for Global Development*, 58 pages, Geneva.
- Padalkar S. A., Pacharaney U. (2016). Energy Efficient Data Gathering in Wireless Sensor Networks and Internet of Things with Compressive Sensing at Sensor Node, *International Conference on Advanced Communication Control and Computing Technologies (ICACCCT)*, 551-554,
- Pesonen L.A., Teye F.K-W, Ronkainen A.K., Koistinen M.O. Kaivosoja J.J., Suomi P.F., Linkolehto R.O. (2014) “Cropinfra: An Internet-based service infrastructure to support crop production in future farms”, *Biosystems engineering*, 120: 92 -101.
- Sarangi S., Umadikar J., Kar S. (2016) “Automation of Agriculture Support Systems using Wisekar: Case study of a crop-disease advisory service”, *Computers and Electronics in Agriculture* 122: 200–210.
- Ugur, F. (2016). *Development of Wireless Sensor Network and Web-Based Temperature Monitoring System for Greenhouses*, Master of Science Thesis written in Turkish, Ankara University Graduate School of Natural and Applied Sciences, Ankara.

## MANAGEMENT OF GREENHOUSE CROP GROWTH SYSTEM

Mehmet Ali DAYIOGLU\*, Ayten ONURBAS AVCIOGLU

Ankara University, Department of Agricultural Machinery and Technologies Engineering, Ankara, Turkey

\*Corresponding author: dayioglu@agri.ankara.edu.tr

### Abstract

In recent decades, the greenhouse area has risen to grow the vegetables, ornamentals and fruit crops at worldwide year-round. Today, the greenhouse farming has been carried out in modern production facilities. The greenhouse management is a key factor at all growing stages, different timescales and market patterns. The sub-sectors such as energy, climate and water-fertilizer crop quality, and pest-disease in greenhouse can be integrated under management concept. In this paper, the hierarchical manager method is proposed for profitable and sustainable crop growth and production in greenhouse. This method involves three layers named as climate and nutrition manager layer, crop growth manager - layer and tactical manager layer. The greenhouse management is carried out based on fast crop dynamics (transpiration, photosynthesis, and respiration), and slow crop development (crop growth and fruit changes). High-tech greenhouses can be managed according to the strategic, tactical and operational levels based on computer, sensors, communication, and software sub-systems.

**Keywords:** *Greenhouse, Greenhouse management, Multilayer hierarchical control.*

### Introduction

A modern greenhouse is a plant factory where a lot of equipment is used to control the growth and development of the plant (Dayioglu, 2014). Greenhouse is a complex system along with physical and biological environment. The crop is its main element directly influenced from different variables, such as weather variations (temperature, humidity, photosynthetic active radiation [PAR], and carbon dioxide concentration) nutrition (water and nutrients), biotic (pests, diseases, viruses, bacteria, and weeds), and cultural management (pruning, spraying). Today, the greenhouse farming has been carried out by using automation technologies in modern production facilities (van Straten *et al.*, 2011). The crop production at large-scale greenhouses requires a lot of energy, water and chemicals. In recent years, it is accepted that greenhouses consist of sub-sectors of crop, water-fertilizer, climate, energy, crop quality (Dayioglu, 2014). Some authors have studied on energy management (Kolokotsa, 2010), climate management (van Henten, 1996), water-fertilizer management (Pardossi *et al.*, 2011), crop management (De Pascale and Leonardi, 2012), quality and pest-disease management (Albajes *et al.*, 2000). These sub-sectors along with automation, computer and sensor technologies can be considered for the sustainable production. All those sectors and technologies required for greenhouses can be integrated for a successful management. Modern greenhouses can be managed by using the hierarchical control architecture derived from industrial automation systems (Scattolini, 2009). There are seven layers for industrial automation systems: 1) primary technology, 2) sensors and actuators, 3) low level control, 4) group control, 5) supervision, 6) manufacturing, 7) enterprise. These layers are configured for greenhouse climate in Watergy project (Speetjens *et al.*, 2008). The crop growth system can be defined by using a hierarchical control architecture. In this paper,

the hierarchical manager method is proposed for profitable and sustainable crop growth. The integrated management concept based on crop is defined for smart greenhouses.

### Material and Methods

Greenhouses are equipped with many sub systems to meet the climate and nutritional requirements of crops. Sub-systems such as heating, ventilating, cooling, shading and fogging are used to control the greenhouse climate. Irrigation and fertilization sub systems are combined with dosing systems suitable to the soilless culture. The modern greenhouses can be managed as to the simplified automation scheme shown in Figure 1.

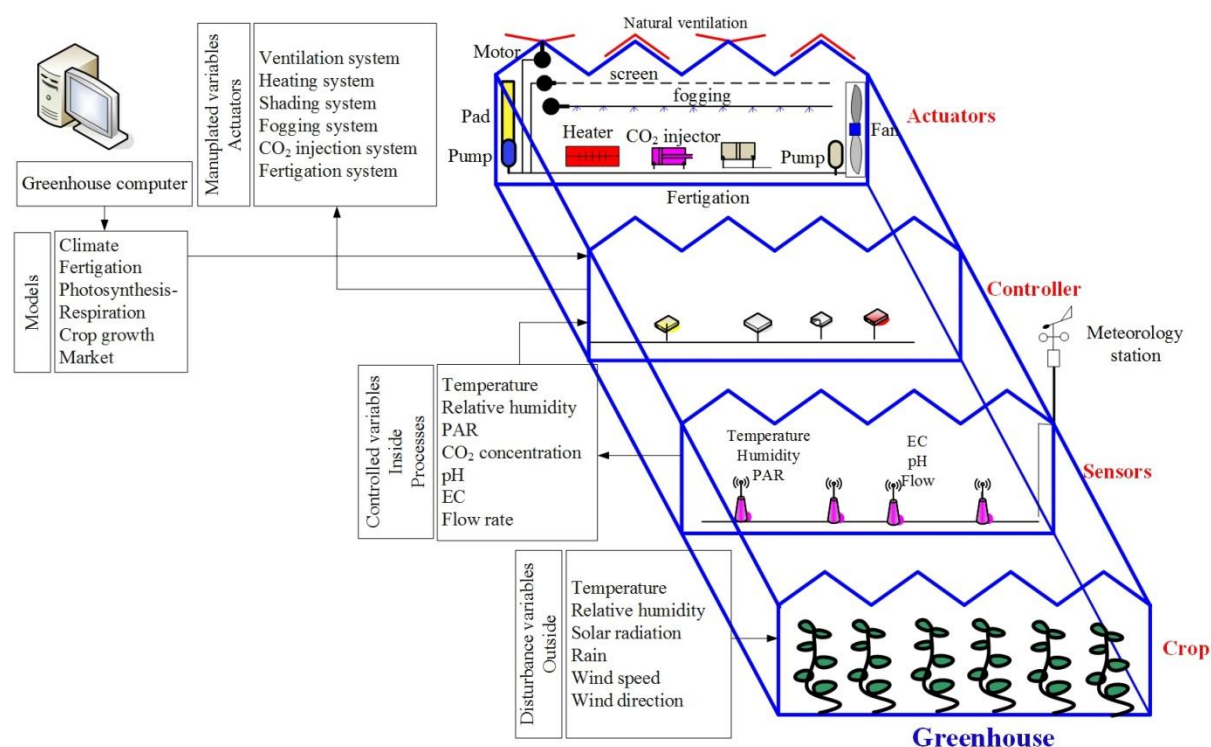


Figure 1. Greenhouse automation scheme

In this scheme, the modern greenhouse components such as crop, sensors, controllers, actuators are stratified to illustrate processes realized in background. Greenhouse processes are controlled in conformity with information flows among sensors, controller, and actuators. The disturbance variables including temperature, relative humidity, solar radiation, wind speed and direction at outside of greenhouse are taken into account for the successful climate management. Inside variables such as temperature, relative humidity, PAR, CO<sub>2</sub> concentration, pH, electrical conductivity (EC), water flow rate to be controlled according to seasons, day – night courses and crop growing levels must be properly set. Greenhouse computers are used so that farmers and/or engineers can follow the climatologic and nutritional variables and the control parameters, pest-disease and crop status, as well as alarm information arranged automatically. The control algorithms, expert software, predictive crop growing models are the most important tools for modern greenhouses. The dynamic models are used to define the knowledge among all the interactions and processes, to obtain efficient automation and optimum crop growth (Fortuna *et al.*, 2000). The wired systems such as Ethernet, RS485, CAN, ModBus and/or wireless systems including Bluetooth, WiFi ZigBee, as well as GSM for long range (Serodio *et al.* 2001; Pawlowski *et al.*, 2009) are need for the successful management.

## Hierarchical Manager Method

The greenhouse-crop growth system can be managed by “*hierarchical manager method*” with three layers in the light of information given by (Ramirez-Arias *et al.*, 2012; Rodríguez *et al.*, 2015). In this method, three layers are defined at various the time scales such as seconds/minutes, minutes/hours, months/season, hours/days: (1) *Climate and nutrition manager layer*, (2) *Crop growth manager layer*, (3) *Tactical manager layer*. Furthermore, three different levels are taken into account at hierarchical control architecture: (1) *Real system level*, (2) *Model level*, (3) *Controller level*. Figure 2 shows schematically the application of the hierarchical manager method with three layers defined for greenhouses:

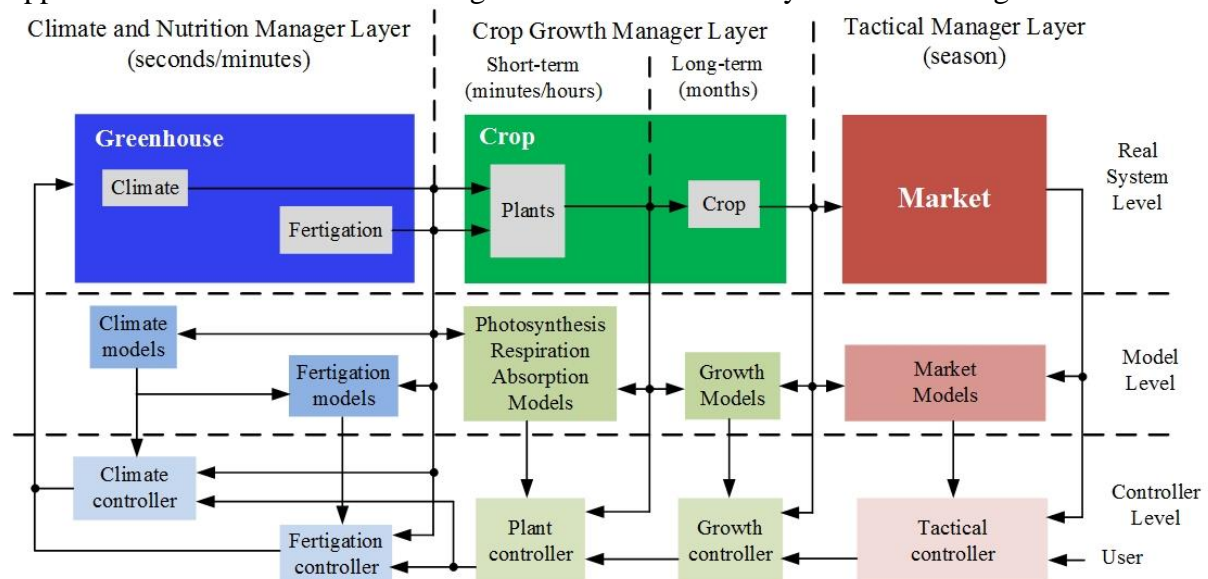


Figure 2. Hierarchical manager method with three layers (modified and adapted from Rodríguez *et al.*, 2015)

## Results and Discussion

Greenhouses can be managed by the hierarchical control approach to provide the optimum crop growth based on economic criteria. We offer a hierarchical control scheme for greenhouses. Hierarchical layers consist of climate and nutrition manager layer, crop growth manager-layer and tactical manager layer. The proposed hierarchical control scheme corresponds to that given by Ramírez -Arias *et al.* (2012) and Rodríguez *et al.* (2015).

- *Climate and nutrition manager layer* is responsible from computing of control signals to be sent to the actuators by using temperature and EC set-points calculated by the tactical manager layer. The control algorithms such as feed-forward control, adaptive control, predictive control and hybrid control have been proposed for greenhouse control (Rodríguez *et al.*, 2008; Rodríguez *et al.*, 2015).
- *Crop growth - manager layer* finds the growth trajectories from tactical manager layer and calculates the set points suitable air temperature and electrical conductivity (EC) trajectories for the greenhouse crop according to long-term and short-term weather predictions. The daytime and night-time temperature levels and the EC set points are calculated. Generally, this layer is divided into two levels: Short-term growth control, Long-term growth control.
  - *Short-term growth control*: The physiological processes such as photosynthesis or crop respiration, which directly influence the crop growth, are taken place at

temporal horizon of hours. In this level, the set points for the next day are calculated by using short-term weather predictions, the actual state of the crop, and the short-term grower goals according to crop status.

- *Long-term growth control:* This contains the decisions about the total production schedule of the crop. These decisions are taken by using information based on the growing rate, vegetative features and the crop specific climatic set point values. The main variables are the dry matter production and leaves production matching with the crop growth process. Thus, the climatic and irrigation set points are calculated according to probable harvesting date or an expected growth curve.
- *Tactical manager layer* solves the optimization problem that is defined for different objectives. The outputs of this layer are the growth trajectories limited by the crop to maximize the profit. The long-term objectives and the long-term predictions are taken into account. The long-term objectives are market prices, harvesting dates, and required quality.

The greenhouse climate is managed according to outputs of climate model and climate controller. The fertigation process is controlled with outputs of fertigation model and fertigation controller taken from optimization procedure of tactical manager layer. The mechanisms of decision support of greenhouse are defined from crop growth models. The fertigation balance is set from crop growth and market variations. The growth models of crop are affected from market models defined in tactical layer. Many devices including sensor and actuator, and expert model and software are used to control the climate and fertigation processes.

Smart greenhouses can be designed based on “*hierarchical management method*” defined in above and “*integrated management concept*” shown in Figure 3.

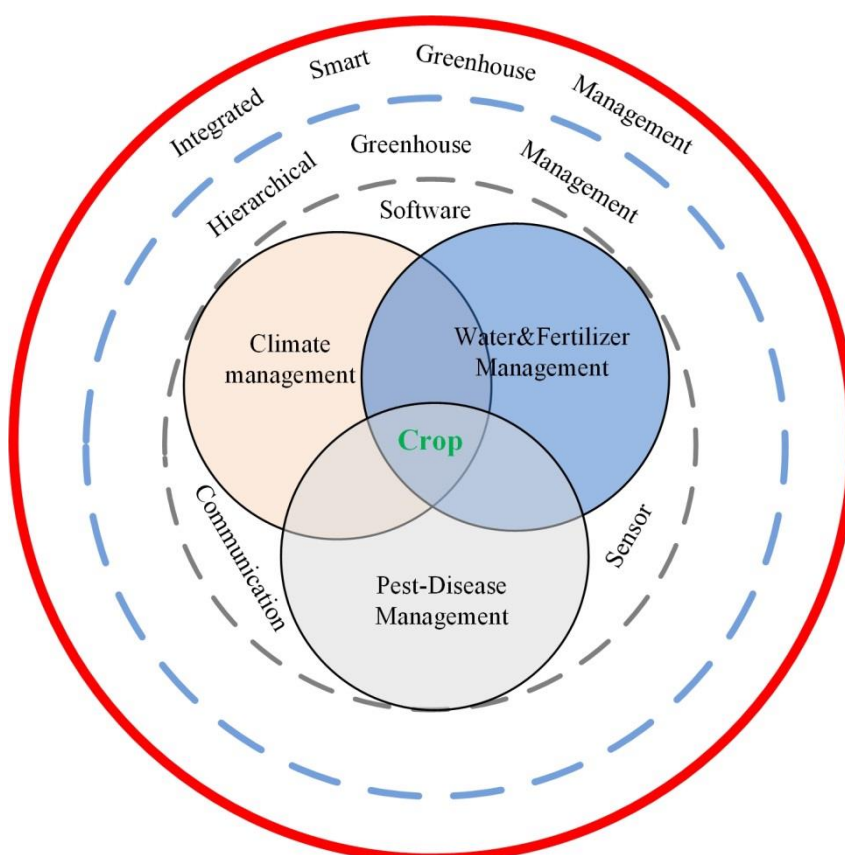


Figure 3. Integrated smart greenhouse management

The sophisticated greenhouse management relies on the use of information and automation technologies including monitoring and controlling of all processes in the production cycle for high quality products (Aaslyng *et al.*, 2005). Furthermore, the integrated smart greenhouse management is planned to be provided the following outputs:

- Increasing in production,
- Decreasing in product cost,
- Improving in product quality,
- Decreasing in labor use,
- Flexible use for coming up with short-term and long-term targets,
- Decreasing in energy use,
- Increasing the efficiency in using of energy,
- Using of alternative energy sources and industrial waste heat,
- Decreasing in greenhouse gas emission,
- Decreasing in environmental pollutions and wastes,
- Decreasing in pesticide use.

### **Conclusions**

The greenhouse is a closed environment where climate and fertigation processes must be controlled for ideal crop growing. The greenhouse agro-system is a complex system including physical, chemical and biological processes in which are take place simultaneously. Therefore, the crop growing conditions can be just controlled by sub-systems including heating and screening system, ventilating system, cooling and shading system, fogging system, CO<sub>2</sub> injection system, irrigation and fertilization system and automation system, as well as transportation and packaging. Greenhouses can be managed by using hierarchical methods like an industrial facility. Modern greenhouses can be operated as smart facilities based on the integrated management concept and hierarchical method. The management organization for greenhouses can be integrated based on energy and climate management, water-fertilizer management, disease-quality management. Greenhouse computers are the strategical devices to manage the climate and fertigation procedures of greenhouse. These are usually programmed based on crop and market models. High-tech greenhouses can be run at the strategic, tactical and operational levels by using computers, sensors, wired-wireless communication and software sub-systems. Information detailed about physical, biological, and chemical environments of the greenhouse can be obtained by using wireless sensor nodes and actuators to be placed to different positions.

### **References**

- Aaslyng J. M., Ehler N. Jakobsen L. (2005). Climate control software integration with a greenhouse environmental control computer, *Environmental Modelling & Software* 20: 521-527.
- Albajes R., Gullino M. L., van Lenteren, J. C., Elad Y. (2000). *Integrated Pest and Disease Management in Greenhouse Crops*, Kluwer Academic Publishers, pp.545, New York
- Dayioglu M.A. (2014). *Intelligent Greenhouses: Integrated Hierarchical Management*, pp. 301-307, *Proceedings of 12<sup>th</sup> International Congress on Mechanization and Energy in Agriculture (ADAGENG2014)*”, 3-6 September 2014, Cappadocia-Nevsehir.
- Fortuna R.L., Nunnari G., Occhipinti L., Xibilia M. G. (2000). Soft computing for greenhouse climate control. *IEEE Transactions on Fuzzy Systems*; 8(6):753–760.

- De Pascale, S., Leonardi C. (2012). Greenhouse Crop Management: New Approaches to an Old Challenge, Proc. IS on GreenSys2011 343-350, Eds.: C. Kittas et al. Acta Hort. 952, ISHS 2012.
- Kolokotsa D., Saridakis G., Dalamagkidis, K., Dolianitis S., Kaliakatsos I. (2010). Development of an intelligent indoor environment and energy management system for greenhouses, Energy Conversion and Management, 51, 155–168.
- Pardossi A., Carmassi G., Diara C., Incrocci L., Maggini R., Massa D. (2011). Fertigation and Substrate Management in Closed Soilless Culture, Pisa, pp:1-63.
- Pawlowski A, Guzman J.L, Rodriguez F., Sanchez M.B.J., Dormido S. (2009). Simulation of greenhouse climate monitoring and control with wireless sensor network and event-based control. Sensors, 9: 232–252.
- Ramírez-Arias A., Rodríguez F., Guzmán M.B.J.L., Berenguel M. (2012). Multiobjective hierarchical control architecture for greenhouse crop growth, Automatica, 48, 490–498.
- Rodríguez F., Guzman J. L., Berenguel M., Arahál M. R. (2008). Adaptive hierarchical control of greenhouse crop production, International Journal of Adaptive Control and Signal Processing, 22:180–197.
- Rodríguez F., Guzmán M.B.J.L., Ramírez-Arias A. (2015). Modeling and Control of Greenhouse Crop Growth, Springer.
- Scattolini R. (2009). Architectures for distributed and hierarchical Model Predictive Control – A review, Journal of Process Control, 19,723–731.
- Serodio, C., Cunha, J. B., Morais, R., Joao C. C. (2001). A networked platform for agricultural management systems Monteiro Computers and Electronics in Agriculture 31, 75–90.
- Speetjens S.L., Janssen, H.J.J. van Straten, G.Gieling, Th.H., Stigter J.D. (2008). Methodic design of a measurement and control system for climate control in horticulture, Computers and Electronics in Agriculture, 64, 162–172.
- van Henten, E.J., Bontsema J. (1996). Greenhouse climate control: a two time-scale approach. Acta Horticulturae 406: 213-219.
- van Straten, G. van Willigenburg, G., van Henten, E. and van Ooteghem, R. (2011). Optimal Control of Greenhouse Cultivation, pp. 296, CRC Press.



## DETERMINATION OF NITROGEN STATUS OF SUGAR BEET USING MOBILE OPTICAL SENSOR

Ufuk TURKER\*, Uğur YEGÜL, Babak TALEBPOUR

Ankara University, Department of Agricultural Machinery and Technologies Engineering, Ankara, Turkey

\*Corresponding author: uturker@agri.ankara.edu.tr

### Abstract

Recently, measurement of the optical characteristics of vegetation at specific wavelengths has been adopted for N status assessment in various crops. Optical sensing instrumentation can be used to calculate vegetative indices, which are indicators of a plant's photosynthetic potential and above ground, living biomass. Development of NDVI for prediction of sugar beet yield and quality during the growing season would be of value to producers and industry. During the growing season, monitoring the status of the plant in sugar beet production system will enable farmers to improve nitrogen management. The main objective of this study was to determine in-season nitrogen status in sugar beet using the mobile optical sensor. An experiment was established to determine the effect of nitrogen on root yield, sugar content and  $\alpha$ -amino N content using a randomized block design by applying five different rates of nitrogen (0, 60, 90, 120, 150 kgN/ha) for two sugar beet varieties. The amount of 115.64 kgN/ha was determined as economic optimum nitrogen rate when quadratic polynomial model was used to describe the relationship between nitrogen and root yield, sugar content, and  $\alpha$ -amino N content. The use of NDVI values were proposed 93 days after sowing at approximately 1486 CGDD. Thus, N status in plants and in-season N requirement could be determined taking advantage of the relationship between N rates and NDVI values. So, the variable rate nitrogen fertilization process can be realized as an important element of precision agriculture. Environmental pollution will be minimized due to increasing nitrogen use efficiency.

**Keywords:** *Sugar beet, Nitrogen management, Optical sensor, Variable rate nitrogen application, root yield, sugar content.*

### Introduction

All crops require nitrogen (N) for the production of a photosynthetically active canopy, whose functionality will strongly influence yield. There is an absolute requirement for N for plant growth, and crop yields and quality depend upon substantial N inputs. Profitable sugar beet production requires wise use of technology and precise management of fertilizer especially nitrogen fertilizer. This new technological approach to the nitrogen management has the potential to increase sugar beet yield and quality as well as other nitrogen consumed plants. This strategy allows for fertilizing more productive area across the field and decrease nitrogen fertilizer cost. High root yield production means successful sugar beet production in many regions. But successful sugar beet production is a combination of high root yield, sugar yield and low impurities. Site specific management of inputs can be applied not only by using soil analyzing but also by employing various remote sensing techniques to monitor plant status in different growing stages, for instance to suggest the optimal rate of nitrogen. A study conducted by Weisler et al. (2002) can be referred to as an example of using remote sensing in sugar beet production. They used a hand-held multispectral scanner for canopy light

reflectance measurements and calculated sensor values as an indicator for canopy greenness. Franzen et al., 2003 investigated the advantages of using ground based sensors rather than satellite images. For this purpose, the value of dry matter content and nitrogen content in sugar beet were compared with NDVI values obtained from ground based sensor (Greenseeker). Hoffmann and Blomberg, 2004 investigated the possibility of using remote sensing in order to estimate variation in leaf area development of sugar beet from different agronomic application. The results indicated a very close relationship between LAI and NDVI in all trials and the coefficient of determination of the functions was highly significant. Along with considering weather conditions another way of predicting the potential sugar beet yield is the use of crop growth models combined with NDVI data. Humburg et al., 2002 used a fertility experiment to linking canopy reflectance measurements to a portable spectroradiometer and airborne images in sugar beet to a set of root quality measures. Prediction of nitrogen status during fertilizing application is extremely important to manage nitrogen application. The aim of this study is to use optical sensor to establish a model to determine actual in-season nitrogen requirements according to the relationship between NDVI index and N status in midseason.

### Material and Methods

Field experiments were carried out in a complete randomized block design with five replications at two different locations (Altinekin and Alakova) in central Anatolia, Konya, Turkey. Each experiment included 50 treatments which were the combinations of two commercial varieties of sugar beet ( $T_1 = \text{Mohican}$ ,  $T_2 = \text{Eldorado}$ ) and four nitrogen rate as urea fertilizer (0, 60, 90, 120, 150 kgN/ha). All other culture practices, including bottom fertilizing were carried out as recommended at experiment region. The root yield obtained from 10 m<sup>2</sup> of each plot were weighed and sucrose content,  $\alpha$ -amino N were analyzed in laboratories. NDVI values were collected in different stage of plant growth (45 day after planting (before fertilizing), 74, 93, 127 days after planting (after fertilizing) respectively) using the Green Seeker handheld sensor (NTech, Ukiah, California). The data collected at each experimental location was analyzed as a five-replication in randomized complete design. The data were also analyzed using analysis of variance and Tukey's multiple comparison method was applied to determine differences between treatments. Statistical Analysis System (SAS) programs were used for analyses of variance and determination of variance components. To describe the sugar beet yield and sucrose content response to nitrogen fertilizer, quadratic regression models were fitted to the data as the best statistical model (Cerrato and Blackmer, 1990, Sayılı and Akça, 2004). The acquired models for estimating root yield and sucrose content were used to determine the economic optimum rate of nitrogen fertilizer. In order to determine the economic optimum nitrogen rate, a net return function combined with the price-sucrose relationship function was used when nitrogen fertilizer takes into account as a production input (Gandorfer et al., 2008, Baker et al., 2004):

$$NR = p_s \cdot f(N) - p_N \cdot N + \left( \frac{g(N) - 3}{13} \cdot p_s - p_s \right) \cdot f(N)$$

Where;

NR : Net return (TL/ha),

$p_s$  : base price (TL/ton) and

$p_N$  : price of nitrogen fertilizer.

In order to determine the best appropriate time of fertilizing, the concept of RI (Response Index) was exploited. This index was calculated for NDVI and Yield separately. Response index for yield is known as  $RI_{\text{harvest}}$  and indicates the actual crop response to applied nitrogen

(Johnson and Raun, 2003) and in-season sensor measurements of NDVI that indicates N uptake between plots receiving nitrogen and those not receiving nitrogen can be used for calculating NDVI response index (Mullen et al., 2003) by using following equations:

$$RI_{NDVI} = NDVI (\text{max}) / NDVI (\text{control})$$

$$RI_{\text{harvest}} = \text{Yield} (\text{max}) / \text{Yield} (\text{control})$$

The calculated value related to response index in terms of yield and NDVI was compared with each other. As a result of the correlation analysis, the measurement period with the highest R-square obtained from comparing two series of data was identified as appropriate period for applying fertilizer. After determining the appropriate time for applying nitrogen fertilizer, the relationship between corresponding NDVI values and nitrogen rates was determined using linear regression method in order to estimate the nitrogen requirement in sugar beet. The concept of INSEY (in-season estimated yield) was used to estimate potential yield using GreenSeeker readings (Franzen et al., 2013). In-season estimated yield (INSEY) values were computed using NDVI readings in any period of growth divided by the cumulative growing degree day (CGDD) over the same time period from planting to sensing (Lukina et al., 2001, Teal et al., 2006). Equation resulted from regression analysis between INSEY values as an independent variable (x) and sugar beet yield of the same pilot as response variable (y) may be used as a calibration equation in variable rate nitrogen application.

### Results and Discussion

The influence of different nitrogen rate on sugar beet quantity (yield) and some quality index (sucrose concentration,  $\alpha$ - amino N) in two experiments are shown in Table 1. The result of variance analysis showed that all quantities and quality parameters were affected significantly by N rates.

Table 1. Effect of nitrogen fertilizer rate on sugar beet yield, sucrose content and  $\alpha$ -amino N in Altnekin ve Alakova experiment location\*.

N rate KgN /ha	Altnekin				Alakova							
	Sucrose content		Yield	$\alpha$ -amino N	Sucrose content		Yield	$\alpha$ -amino N				
0	19.38±0.71	ab	70.94±7.10	b	1.91±0.58	b	16.18±0.42	b	65.12±10.52	b	1.90±0.84	bc
60	19.46±0.78	ab	84.54±11.70	ab	2.55±0.58	ab	16.60±0.60	ab	68.88±6.95	ab	1.88±0.84	c
90	19.60±0.68	a	86.36±12.07	ab	2.92±0.83	a	17.11±0.27	a	74.75±5.50	ab	2.04±0.65	bc
120	18.81±0.68	ab	100.06±13.84	a	3.21±0.85	a	15.99±0.69	b	77.20±3.21	a	3.52±1.08	a
150	18.60±0.71	b	89.68±10.43	ab	3.39±0.65	a	16.01±1.00	b	76.73±6.19	a	3.31±1.02	ab

\* Means with the same letters are not significantly different at the 5% probability level.

As a result, the relationship between nitrogen fertilizer rate and yield, sucrose content and  $\alpha$ -amino N values were statistically significant at 0.05 probability level. The P value obtained for yield, sucrose concentration and  $\alpha$ -amino N at Altnekin and Alakova locations were determined as 0.01, 0.01, 0.02 and 0.008, 0.019, 0.003 respectively. However, according to results obtained from the experiment, the effect of seed varieties on sucrose content were statistically significant at the same probability level, but in terms of yield and  $\alpha$ -amino, were not significant. Based on results from both experiments, while 90 kgN/ha was found as the appropriate nitrogen fertilizer rate in terms of sucrose content, the highest root yield was

obtained when 120 kgN/ha was applied. The amount of  $\alpha$ -amino N at Altnekin location increased with increasing nitrogen fertilizer rate, but the same trend was not observed in another experiment.

### Determination of economically optimum nitrogen fertilizer rate

Determination of optimum nitrogen rate in nitrogen fertilizer consumption is important because of its impact on the sugar beet quantity and quality. In spite of observing the positive effect of using nitrogen fertilizer above the optimum rate on sugar beet yield, excess nitrogen rate, reducing the sucrose content and increasing the impurity index in sugar beet root, therefore cause to decrease the amount of refinable sugar in the sugar production process (Franzen et al., 2010). On the other hand, since nitrogen is a mobile nutrient (Harper, 1994) unnecessary use of this fertilizer leads to leaching nitrogen into ground water which it also leads to contamination (Spalding and Exner, 1993). Therefore, determination of the economical optimum rate of nitrogen is required. In order to determine optimum nitrogen rate, the average of yield and sucrose content values from two experiment were used to estimate response functions to nitrogen (Figure 1).

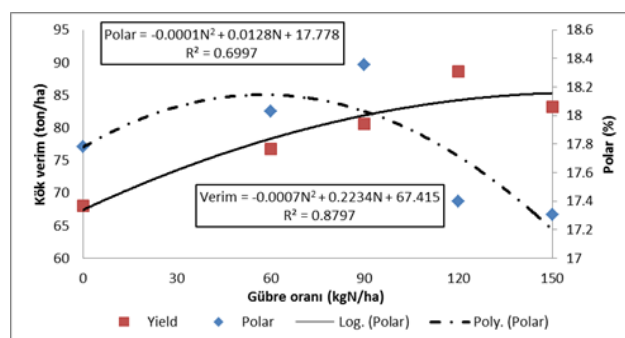


Figure 1. Estimated sugar beet yield and sucrose concentration response function to nitrogen rate.

Quadratic polynomial curves, as the most appropriate statistical model, were used to estimated yield and sucrose content values. Economically optimum nitrogen rate corresponding to sugar beet yield, sucrose content, sugar beet price and net return derived from net return equation using mean values of two experiments was determined as 115.64 kgN/ha. According to the result of statistical analysis related to yield and sucrose content, as it was mentioned before; the high sucrose content was obtained when the amount of 90 kgN/ha nitrogen was applied.

### Evaluation of NDVI results

Descriptive statistics related to NDVI readings achieved from different measurement periods at two experiments are shown in Table 2. Considering the average NDVI value from two experimental locations, these values were changed from 0.22 to 0.71 and 0.35 to 0.68 in Altnekin and Alakova, respectively. Measurements were performed at four different cumulative growing degree days; the first one (before fertilizing) at 561 CGDD and the other three measurements (after fertilizing) at 1083.6, 1486.7 and 2235.3 CGDD, respectively.

Table 2. Descriptive statistics of NDVI readings at two experimental locations.

Measuring interval	ALTINEKIN				ALAKOVA			
	Min	Max	Mean	STDEV	Min	Max	Mean	STDEV
NDVI (before fertilizing)	0.13	0.39	0.22	0.056	0.24	0.43	0.35	0.043
NDVI 1 (after fertilizing)	0.39	0.54	0.46	0.041	0.18	0.51	0.42	0.072
NDVI 2 (after fertilizing)	0.54	0.69	0.62	0.046	0.32	0.67	0.50	0.082
NDVI 3 (after fertilizing)	0.63	0.75	0.71	0.029	0.38	0.77	0.68	0.082

Green seeker sensor reading and root yield values were used to determine optimum timing of nitrogen fertilizing. For achieving this purpose, response index calculated from different NDVI readings and root yield at different measurement periods were utilized. The results of regression analysis to determine the relationship between  $RI_{NDVI}$  and corresponding  $RI_{harvest}$  are reported in Table 3.

Table 3. Relationship between  $RI_{NDVI}$  ve  $RI_{Hasat}$  from two locations ( $R^2$ ).

$RI_{NDVI}$	$RI_{Harvest}$	
	Altinekin	Alakova
$RI_{NDVI}$ - first reading after fertilizing	0.27	0.46
$RI_{NDVI}$ - second reading after fertilizing	0.38	0.63
$RI_{NDVI}$ - third reading after fertilizing	0.11	0.45

As given in Table 3, the linear regression results indicated that the highest correlation value ( $R^2$ ) was obtained during second Green Seeker readings (1486.7 CGDD) after fertilizing in both trial locations. According to this result, second Green Seeker reading period (93 day after planting) was determined as an appropriate time to apply variable rate nitrogen application. The impact of different nitrogen fertilizer rates on NDVI values that obtained before fertilizing application at the Altinekin trial site were not statistically significant (probably due to poor germination of seeds). Therefore, despite the impact of nitrogen rate on the percentage increase of NDVI values when compared with NDVI readings from the first fertilizing application, the significant relationship was not found between nitrogen fertilizer rate and NDVI values at the time of planned variable rate nitrogen application. However, the results of variance analysis at the Alakova trial site indicated that the differences between both NDVI value and their percentage increase response to nitrogen fertilizer rates were statistically significant (Table 4).

Table 4. The effects of different nitrogen fertilizer rate on NDVI values at second Green Seeker readings after fertilizing\*.

N Rate	Altinekin			Alakova		
	NDVI	Increase (%)		NDVI	Increase (%)	
0 KgN/ha	0.58±0.029	192.24±50.34	ab	0.40±0.405	26.64±4.77	b
60 KgN/ha	0.64±0.035	125.84±45.45	b	0.46±0.039	33.93±19.23	b
90 KgN/ha	0.64±0.035	181.36±32.92	ab	0.48±0.035	35.56±8.42	b
120 KgN/ha	0.65±0.044	203.92±39.34	a	0.54±0.055	51.18±16.15	ab
150 KgN/ha	0.59±0.049	254.14±46.59	a	0.61±0.037	70.81±20.18	a

\* Means with the same letters are not significantly different at the 5% probability level.

Because of the importance of yield potential for determining nitrogen application rate, INSEY index were used to predict potential yield by Green Seeker sensor readings. In order to create this equation, INSEY index calculated from second NDVI readings after fertilizing

(93 day after planting that have high correlation with  $RI_{\text{harvest}}$ ) was used. The following equation estimated the potential yield at Alakova trial site (where NDVI values response to nitrogen fertilizer were significant) without additional nitrogen fertilizer:

$$\text{Potential Yield} = 81769 \text{ INSEY} + 37.855 \quad (R^2=0.51)$$

Considering that CGDD were 1486.7 °C at 93th day after planting and with reference to  $\text{INSEY} = \text{NDVI}/\text{CGDD}$ , the relationship between Potential yield and NDVI values can be calculated as follows:

$$\text{Potential Yield} = 55 \text{ NDVI} + 37.8$$

So, using INSEY index can be used to determine potential yield without additional nitrogen fertilizer.

### **Determination of variable nitrogen rate using green seeker readings**

In order to drive nitrogen rate using a NDVI-based calibration equation, the data from Alakova trial site with meaningful data were used. Using obtained equation resulted in maximized economic return by avoiding unnecessary use of nitrogen and balancing between yield and sucrose content and harmful nitrogen. Because of statistical significance of the effect of two seed variety on NDVI values ( $p < 0.05$ ), the relationship between NDVI and additional nitrogen rate were determined for both seed varieties. The results were expressed by the following equations:

First seed variety (Mohican):

$$\text{N Fertilizer Rate} = 591.21 \text{ NDVI} - 227.02 \quad (R^2=0.76)$$

Second seed variety (Eldorado):

$$\text{N Fertilizer Rate} = 596.44 \text{ NDVI} - 199.14 \quad (R^2=0.80)$$

Nitrogen fertilizer rate obtained from above equations was determined as nitrogen level in sugar beet. Therefore, calculated NDVI values using Green Seeker sensor can be used to estimate the nitrogen status in sugar beet. So, the recommendation of nitrogen rate that should be used in the variable rate nitrogen application can be done by subtracting estimated nitrogen level in plants from predetermined optimum nitrogen rate (115.64 kgN/ha).

### **Conclusions**

The adoption of precision nitrogen management in sugar beet production based on implementing soil and plant properties can increase sugar beet yield and quality as well as other nitrogen consumed plants, maintain its quantity and quality in low producing areas across the field and reduce cost of inputs. Sugar beet processing efficiency is directly related to root yield and quality that is greatly affected by nitrogen fertilizer. In addition, the percentage of sucrose and the level of impurities are two concepts of sugar beet quality which affect sucrose extraction by the processor. Production of high quality sugar beet is especially important to growers whose payment is based on the extractable sucrose content of their beets (Cattanach et al., 1991). In this study, applying different nitrogen fertilizer rates has significant impact on the yield and quality parameters. According to the result, maximum root yield and sucrose content were achieved when 120 and 90 kgN/ha was applied, respectively. The result of an anticipatory research conducted by Bauer and Stevenson, 1972 shows that, maximum level of sucrose content can be achieved by the use of a moderate rate of nitrogen (112 kgN/ha), so, maximum root yield can be obtained by applying 224 kgN/ha. The value obtained for nitrogen rate related to root yield in this study agreed with what resulted from a research reported by El-Sarag et al., 2013.  $\alpha$ -amino N values in sugar beet root were increased with addition of nitrogen that were similar to the result of a study carried out by Gehl and Boring, 2005. Determined economically optimal nitrogen fertilizer rate in

terms of beet price and nitrogen fertilizer price on the basis of root yield and sucrose content response to applied nitrogen is one of the important steps to determine nitrogen requirement. To achieve this goal, quadratic model was used to determine the relationship between applied nitrogen rate and root yield and sucrose content (Adams et al., 1983, sayılı and Akça, 2004). The results show that the estimated economically optimal nitrogen rate for mean values of two experimental sites was 115.64 kgN/ha when the relationship between the sucrose content and the price are considered. In previous research, the results of determining economically optimal rate were carried out using only root yield values without considering sucrose content (Rezvani et al., 2012). Only a few studies related to winter wheat investigated economic consequences with regard to quality factors response to nitrogen fertilizer and the relationship between protein content and yield (Baker et al., 2004, Gandorfer and Rajsic, 2008). Based on the results of NDVI readings from experimental pilots, the relationship between in-season estimate yield (INSEY) computed from NDVI readings collected from second sensor reading after fertilizing divided by the number of days from planting to the reading date, and measured sugar beet yield were used to determine potential sugar beet yield. With regard to response index of NDVI readings and yield at harvest, the application of nitrogen fertilizer at 1486.7 °C CGDD was suggested when the highest correlation were obtained between NDVI indeces. Nitrogen fertilizer requirement can be calculated using response function of NDVI to different fertilizer rate. The method of in-season prediction of nitrogen requirement in winter wheat by using INSEY values were also used to improve the yield potential model compared to using NDVI readings in sugar cane and sugar beet (Lofton et al., 2012, Franzen et al., 2013).

### References

- Adams, R. M., Farris, P. J., & Halvorson, A. D. 1983. Sugar beet N fertilization and economic optima: Recoverable sucrose vs. root yield. *Agronomy Journal*, 75(2), 173-176.
- Baker, D. A., Young, D. L., Huggins, D. R., & Pan, W. L. 2004. Economically optimal nitrogen fertilization for yield and protein in hard red spring wheat. *Agronomy Journal*, 96(1), 116-123.
- Bauer, C.S. and Stevenson, C.K. 1972. North Dakota State Univ. Ext. Ser. 2, 49-56.
- Cattanach, A. W., A. G. Dexter, and E. S. Oplinger. "Sugarbeets. Alternative Field Crops Manual. University of Wyoming Cooperative Extension and University of Minnesota Center for Alternative Plant and Animal Products and Minnesota Extension Service." (1991).
- Cerrato, M. E., & Blackmer, A. M. 1990. Comparison of models for describing; corn yield response to nitrogen fertilizer. *Agronomy Journal*, 82(1), 138-143.
- El-Sarag, E. I. and Moselhy, S. H. 2013. Response of Sugar Beet Quantity and Quality to Nitrogen and Potasium Fertilization under Sandy Soils Conditions. *Asian Journal of Crop Science*, 5, 295-303.
- Bojnec Š. (2004). Farm tourism: myth or reality? In Petrick, M. & Weingarten, P. (eds.), "The Role of agriculture in Central and Eastern European Rural development: engine of change or social buffer?"; Studies on the Agricultural and Food Sector in Central and Eastern Europe, Vol. 25, Halle; pp. 286-304.
- Ćejvanović F., Đurić A., Vujić T. (2013). The competitiveness of tourism and rural tourism offer in Bosnia and Herzegovina through application of the marketing approach. 113<sup>th</sup> EAAE Seminar, Belgrade, December 9-11, 2009.
- Draganic A. (2011). Decentralisation, power of local self-government and multi-level dynamics in Trebinje Municipality. SeeNet Programme: A trans-local network for the

- cooperation between Italy and South East Europe; Second report; May 2011. Centro Studi di Politica Internazionale (CeSPI), Rome.
- Franzen, D., Honggang, B and Sharma, L., 2013. Relationship of active-optical sensor readings with sugar beet yield and quality, sunflower yield and spring wheat protein. Department of Soil Science, North Dakota State University.
- Franzen, D.W., Wagner, G. and Sims, A. 2003. Application of a ground-based sensor to determine N credits from sugar beet. Sugarbeet research and extension reports. 34, 119-123.
- Gandorfer, M., & Rajsic, P. 2008. Modelling Economic Optimum Nitrogen Rates for Winter Wheat When Inputs Affect Yield and Output-Price. *Agricultural Economics Review*, 9(2), 54-64.
- Gehl, J. R. and Boring, T. J. 2005. Nitrogen rate effects on sugarbeet yield and quality. Michigan State University Crop and Soil Science.
- Harper, J. E. "Nitrogen metabolism." *Physiology and determination of crop yield physiology* (1994): 285-302.
- Hoffmann, C. M., & Blomberg, M. 2004. Estimation of leaf area index of *Beta vulgaris* L. based on optical remote sensing data. *Journal of agronomy and crop science*, 190(3), 197-204.
- Humburg, D. S., Lamb, K., Stange, K. W. and Schmitt, M. A. 2002. Modelling of sugar beet quality variables from canopy spectral indices in a fertility trial. *American Society of Agricultural Engineers*, 45(5), 1651-1659.
- Lofton, J., Tubana, B. S., Kanke, Y., Teboh, J., Viator, H., & Dalen, M. 2012. Estimating sugarcane yield potential using an in-season determination of normalized difference vegetative index. *Sensors*, 12(6), 7529-7547.
- Lukina, E. V., Freeman, K. W., Wynn, K. J., Thomason, W. E., Mullen, R. W., Stone, M. L., ... & Raun, W. R. 2001. Nitrogen fertilization optimization algorithm based on in-season estimates of yield and plant nitrogen uptake. *Journal of Plant Nutrition*, 24(6), 885-898.
- Mullen, R. W., Freeman, K. W., Raun, W. R., Johnson, G. V., Stone, M. L., & Solie, J. B. 2003. Identifying an in-season response index and the potential to increase wheat yield with nitrogen. *Agronomy Journal*, 95(2), 347-351.
- Rezvani, S. M., Noruzi, A., Azari, K. and Jafari, A. M. 2013. Determination of an appropriate model for optimum use of N fertilizer in furrow irrigation. *Journal of Sugar Beet*, 29(1), 53-63. (in Persian, abstract in English).
- Sayili, M., & Akca, H. 2004. Comparison of different models for describing sugarbeet yield response to nitrogen fertilizer (case study of Turkey). *Asian Journal of Plant Sciences*, 3(4), 529-531.
- Teal, R. K., Tubana, B., Girma, K., Freeman, K. W., Arnall, D. B., Walsh, O., & Raun, W. R. 2006. In-season prediction of corn grain yield potential using normalized difference vegetation index. *Agronomy Journal*, 98(6), 1488-1494.



## **CLASSIFICATION OF AGRICULTURAL TRACTORS BASED ON ENERGY EFFICIENCY IN TURKEY**

Ufuk TURKER\*, Mehmet Ali DAYIOĞLU

Ankara University, Department of Agricultural Machinery and Technologies Engineering, Ankara, Turkey

\*Corresponding author: uturker@agri.ankara.edu.tr

### **Abstract**

Testing tractors to make sure that they meet their advertised performance claims has been a central focus of the manufacturers and farmers for decades. Agriculture uses energy directly as fuel to operate machinery and equipment and indirectly in the fertilizers and chemicals produced off the farm. There has been a continuing growing interest in fossil fuel economy and reducing greenhouse gas emissions in terms of economic and ecological reasons. A general goal of more energy efficiency encourages the use of tractors with better energy performance in agricultural operations. Tractor manufacturers report that customers are beginning to factor in fuel as part of the tractor-buying equation. Farmers are adding fuel efficiency to their list of purchasing criteria. In this study, an efficiency index, using the specific fuel consumption as a benchmark was applied to 58 tractors for classification of agricultural tractors derived from official tests that follow the OECD (Organisation for Economic Co-operation and Development) codes. The survey was based on the results of tests conducted between 2010-2014 by TAMTEST (Agricultural Machinery Test Center of Ministry of Agriculture in Turkey). 58 models of tractors from 13 different tractor brand ranged from 10 kW (13.4 BG) to 119.3 kW (160 BG) sold in Turkish market were taken into account for classification. 24 tractors were fallen into average energy index category. 18 tractors out of 58 tractors are ranked above the average energy efficiency level. 15 tractor among the 55 tractor are found to be under the average energy efficiency level. This index provides a good option for comparing the fuel-efficiency tractors under standardised conditions. Additional testing is needed on other models of tractors from other manufacturers in order to determine whether the trends found in this study pertain to all tractors or if they are specific to this tractor model and manufacturer.

**Keywords:** Tractors, energy efficiency, consumption rates, engine.

### **Introduction**

Energy efficiency of tractor is one of the most important factor influencing the progress of energy conservation and emission reduction for agricultural mechanization. The energy input in a tractor comes from the fuel introduced into its engine. From this energy, tractors provide energy outputs for drawbar pull, power take-off (PTO) and hydraulic power. Energy losses happen in engine and transmission. Knowledge of energy efficiency of tractor can guide farmers to select their best energy efficient tractor. However the energy efficiencies of tractors in Turkey expressed by specific fuel consumption are not well understood. Tractors are more difficult to rate because their performance is based more on kilograms pulled than kilometers traveled. It is impossible to establish an efficiency classification based on data of actual work due to variability of conditions in agriculture. The only reliable data come from the standardized PTO and drawbar tests performed according to the OECD test codes.

There have been number of studies to classify tractors depending on their energy efficiency. Harris (1992) developed a method to obtain the performance of the engine based on the data given by OECD tests. Souza et al. (1994) explained two functional relationship for the efficiency of tractors. They stated that multiple parameter curves are adequate to analyze the overall tractor efficiency. According to Siemens and Bowers (1999), “Depending on the type of fuel and the amount of time a tractor or machine is used, fuel and lubricant costs will usually machine is used, fuel and lubricant costs will usually represent at least 16 percent to over 45 percent of the total machine costs. Thus, fuel consumption plays a significant role in the selection and management of tractors and equipment.

Grisso et al.(2004) predicted fuel consumption of a tractor (Lh<sup>-1</sup>) for any engine speed and load. Similarly, ASABE (2005) developed an estimation of average annual consumption of diesel-powered tractors. With the general adoption in 2005 for OECD test code 2 of the new 6 points tested at the PTO (OECD Standard Code 2, 2008). Gil-Sierra et al.(2006b) studied the relationship between the coefficient C<sub>j</sub> and rated to 206 tractors, pidindo them into five categories.

Gil-Sierra et al. (2007) classified tractors based on their efficiency in Spain. They used theoretical assumptions of Grisso et al.(2004) to fit the fuel consumption of a tractor at full throttle with variable loads measured during PTO test using the equation indicated below:

$$Q \text{ (L/h)} = (a \cdot X + b) \cdot P_{pto} \text{ (kW)} \quad (1)$$

Where Q is the engine fuel consumption at partial load, X is the ratio between the power at any partial load and at the rated power, P<sub>pto</sub> is the rated power at the PTO, and a and b are the parameters. This equation was extended to evaluate the consumption at lower engine speeds as:

$$Q \text{ (L/h)} = (a \cdot X + b) [A \cdot X \cdot N_{red} + B \cdot N_{red}] \cdot P_{pto} \text{ (kW)} \quad (2)$$

Where N<sub>red</sub> is the percentage of reduced engine speed for a partial load from full throttle (%) and A and B are the parameters.

In March 2005 the OECD code 2 has introduced six points to be included in the test report whose coordinates of engine speed and power are shown in figure 1 (OECD,2007). The 6 points are: 1) maximum power at rated speed b) 80% power at rated speed 3) 80% power at 90% rated speed 4) 40% power at 90% rated speed; 5) 60% power at 60% rated speed and 6) 40% power at 60% rated speed as it can be seen from figure 1.

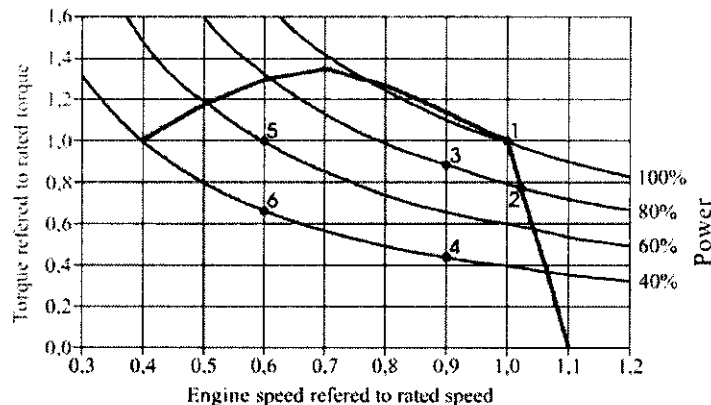


Figure 1. New points tested in the PTO incorporated in march 2005 in OECD

## Material and methods

Tractor test data was obtained from TAMTEST reports performed for tractors tests starting from 2010 according to OECD test procedure. In those data, PTO test data including power, engine speed and corresponding fuel consumption data running the PTO at its standard speed at full and 5 partial loads were taken into account. One example of points tested at the PTO to measure power, engine speed and fuel consumption given in figure 2.

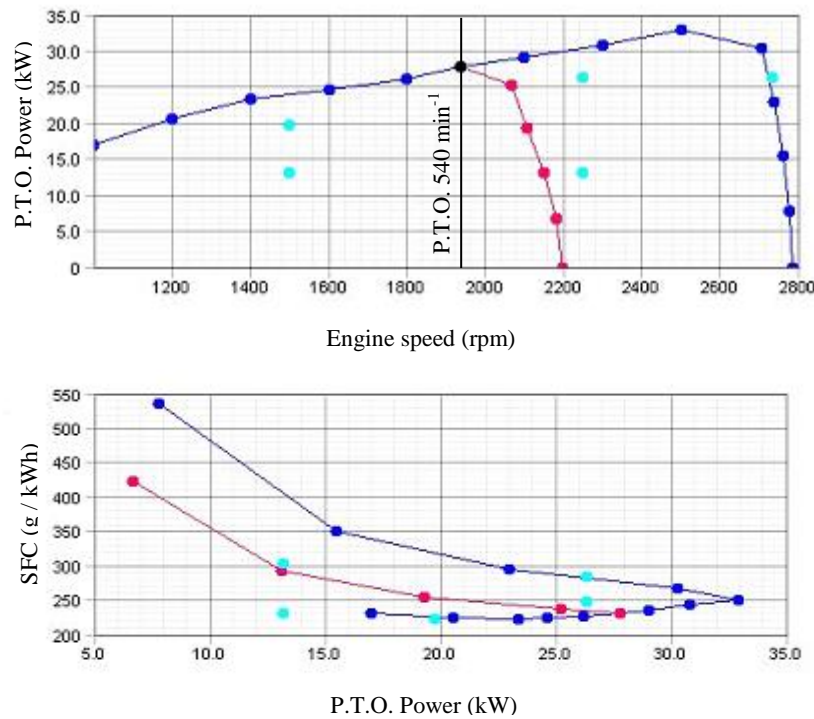


Figure 2: Points tested at the PTO to measure power, engine and fuel consumption.

### Engine efficiency index development from tractor tests

Tractor test reports according to the OECD test codes 1 and 2 give data of fuel consumption, power and engine speed for the following points; a) rated power and full throttle at partial loads; b) standardized PTO speed at full and partial loads and c) maximum power. It has been possible to have better overall information of the fuel consumption of the tractor engine with the general adoption in March 2005 for OECD test code 2 of the new 6 new points tested at the PTO (Figure 1). PTO tests are given these 6 points for each tractor. An example of the tractor PTO test results are given in table 1. Considering the 6 new points, an index 'C<sub>k</sub>' of the energy efficiency of the tractor engine was defined according to OECD code 2 and Ortiz-Sierra (2007).

The index C<sub>k</sub> is calculated as the average specific volumetric fuel consumptions (SVFC) of these six points;

$$C_k = \frac{6}{i=1} \frac{SVFC}{6}$$

From the six points, C<sub>k</sub> is calculated for each tractor. These calculated C<sub>k</sub> was plotted versus the rated power of each tractor and an exponential regression line was fit to represent an average value of all tractors tested, meaning that approximately 50 % of tractors are above this line and 50% below. Then tractor models were classified according to their index C<sub>k</sub> in seven categories with a bandwidth of 7 % around the average line. According to this

categoric classification, a tractor which is represented by a point in one specific area was assigned to that category. In this way, the seven categories were created from lower efficient to higher efficient values of  $C_k$  as A,B,C,D,C,E,F and G.

Table 1. An example of PTO test results for new 6 points of a tractor used in Turkish agriculture according to OECD code 2.

Power	Speed			Fuel consumption			Specific Energy
	Engine	PTO	Fan	Hour		Specific	
kW	min <sup>-1</sup>			kg/h	l/h	g/kWh	kWh/l
3.1.6.1. Maksimum power at rated speed							
32.9	2500	697	2950	8.21	9.80	249	3.36
3.1.6.2. 80% power at rated speed							
26.3	2734	762	3226	7.49	8.93	284	2.95
3.1.6.3. 80% power at 90% rated speed							
26.3	2250	627	2655	6.52	7.78	248	3.39
3.1.6.4. 40% power at 90% rated speed							
13.2	2250	627	2655	4.01	4.78	304	2.75

### Results and conclusions

Plotting the value of SFC versus rated power of every tractor, figure 3 is obtained in which there is a trend to reduce the value of SFC while rated power is increasing. In the figure is represented the exponential line (with a higher determination of coefficient of straight line) which represents average the trend of SFC versus rated power.

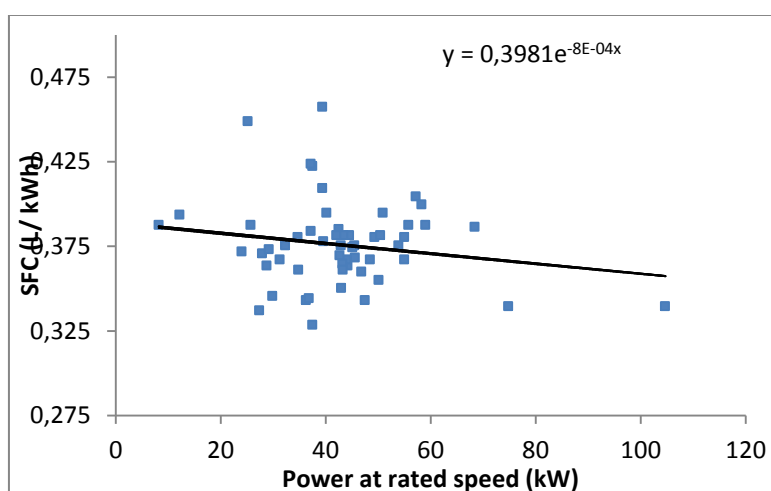


Figure 3. SFC (L/kWh) versus power at rated speed for all tested tractors

The tractor models were classified according to their index  $SVFC_{PTO-d}$  in seven categories with a bandwidth of 5 % around average line. A tractor which is represented by a point in one specific area belongs to that category. The seven categories are called from lower to higher values of  $SVFC_{PTO-d}$ : A, B, C, D, E, F, and G, "A" being the most efficient and "G" the least efficient (fig4 and fig. 5). It is also useful to represent them with different colors, ranging from dark green through green, pale green, yellow, orange, pale red to red.

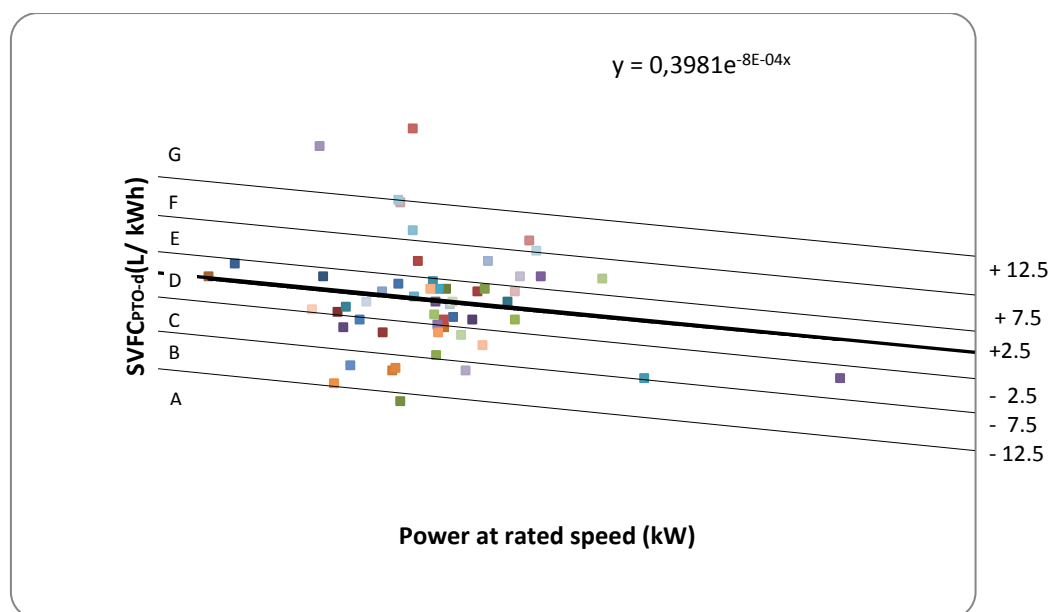


Figure 4. Areas in which the SVFC<sub>PTO-d</sub> versus rated power plot is divided around the average line

The number of tractors in each category is shown in each column. There are a smaller of models in the most and least efficient categories and a large number in the middle categories. The tractor models were classified according to this histogram follow a normal distribution. Therefore it is justified to assume that this method chosen to classify agricultural tractors according to the energy efficiency of PTO and drawbar test

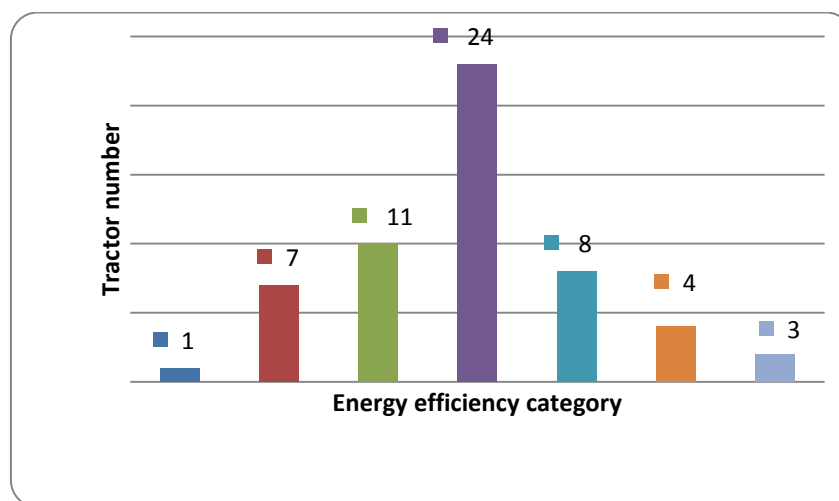


Figure 5. Histogram for 58 tractors in each category according to the efficiency index SVFC<sub>PTO-d</sub>

The results are shown as a histogram in figure 5 for the 58 tractor models considered. The number of tractors in each category is shown in each column. There are a smaller number of models in the most and least efficient categories, and a larger number in the middle categories. The tractor models classified according to this histogram follow a normal distribution. This is verified by the Kurtosis normality test where, for a 5% level of significance the value obtained is 0.2 (very close to 0) showing that that the distribution can be considered to be normal. Therefore it is justified to assume that this method chosen to classify agricultural tractors according to the energy efficiency of the engine is satisfactory.

When the graphic is examined; it can be seen that category A which is the most energy efficient tractor of whole tractor that tested. Only 2 of the tractor out of 58 has fallen category G as indicating least energy efficient tractors. Majority of the tractors have fallen between B and E. Average energy efficiency level category include 24 tractors, 19 tractors out of 58 tractors are above the average energy efficiency level. 15 tractor of 58 tractor are under the average energy efficiency level.

### **Conclusions**

The results demonstrate that there is an energy efficiency differences between tractor models. So a new approach before buying a new tractor should involve the energy efficiency level of tractors. But farmer selection of a tractor cannot be based on only to energy efficiency. There other factors like operational flexibility, continuously variable transmission (CVT), hydraulic power, etc. A further study should also be included these factors. Consequently, this study is an example to classify agricultural tractors in terms of energy efficiency sold in Turkish market and farmers in Turkey may benefit to select more efficient tractor for their field operations.

### **References**

- ASABE standards, 52 Ed. 2005. Agricultural machinery management, Michigan, USA.
- Gil-Sierra J, Ortiz-Canavate J, Gil-Quiros V. 2006. Agricultural tractor classification according to their energy efficiency. An ASABE Annual International Meeting Paper Number: 061205, Portland Oregon, USA.
- Gil-Sierra J, Ortiz-Canavate J, Gil-Quiros V, Casanova-Kindelan J. 2007. Energy efficiency in agricultural tractors: A methodology for their classification. *Appl Eng Agric.*23:145-150.
- Grisso R, Kocher MF, Vaughan DH. 2004. Predicting tractor fuel consumption. *Appl. Eng. Agric.* 20:553-561.
- Grisso R, Vaughan D.V, Robertson GT, Robert P, Hoy RM. 2009. Using tractor test data for selecting farm tractors. Virginia Cooperative Extension Publication No: 442-072.
- Harris HD. 1992. Prediction of tractor engine performance using OECD standard test data. *J Agric. Eng. Res.* 53:181-193.
- OECD Annual Tractor Meeting for Standard CODE 2. 2007 and 2008: Development of indexes to classify agricultural tractors according to their energy efficiency.
- Ortiz-Canavate J, Gil-Sierra J, Casanova-Kindelan J, Gil-Quiros V. Classification of Agricultural tractors according to the energy efficiencies of the engine and the transmission based on OECD tests, [www.oa.upm.es/3251/2/INVE\\_MEM\\_2008\\_53860.pdf](http://www.oa.upm.es/3251/2/INVE_MEM_2008_53860.pdf), 2008.
- Siemens JC, Bowers WW. 1999. Machinery management: how to select machinery to fit the real needs of farm managers. Farm Business Management series. J. Deere Pub.
- Souza EG, Lima SS, Milanez LF. 1994. Overall efficiency of tractor operating in the field. *Appl. Eng. Agric.* 10:771-775.

## **OPPORTUNITIES AND CHALLENGES FOR THE FRESH STRAW MUSHROOM VALUE CHAIN DEVELOPMENT IN VIETNAM**

HO Thi Minh Hop<sup>1,3\*</sup>, Philippe BURNY<sup>2,3</sup>, Jan HELDER<sup>4</sup>, NGUYEN Huu Hy<sup>5</sup>, NGUYEN Thi My<sup>5</sup>

<sup>1</sup>Institute of Agricultural Sciences for Southern Vietnam (IAS), Vietnam

<sup>2</sup>Walloon Center for Agricultural Research (CRA-W), Belgium

<sup>3</sup>Gembloux Agro-Bio Tech, University of Liège (Ulg), Belgium

<sup>4</sup>Wageningen University and Research, The Netherlands (WUR)

<sup>5</sup>HungLoc Agricultural Research Center (HARC-IAS), Vietnam

\*Corresponding author: hop.htm@iasvn.org

### **Abstract**

Straw mushroom sector has been strongly growing in Vietnam since last decade with more than 64,500 tons/year of production. The development of the sector helps improving both farm household's income and the environment by reducing pollution from rice straw burning at the end of the rice cultivation season. Basing on the potential of the sector, Vietnamese government issued an agricultural development programme in 2010 in which mushrooms will be the focus to develop as one of five national strategic commodities. In order to help the sector reaching this goal and growing more sustainably, the study was carried out in 2014 and 2016 to identify its opportunities and challenges by analysing stakeholders in the fresh straw mushroom value chain. The study was carried out through different meetings among the main actors of the straw mushroom value chain in August 2014 in Can Tho and in 2016 in Dong Nai province, Vietnam, to get opinions of target groups, key persons, as well as information concerning the aims of the study. An analysis of the main stakeholders was conducted to identify opportunities and challenges for the sector to grow more sustainably. Low investment costs, depending on production scale, quickly received income circle, low land and labour effort use are the main opportunities for farmers while limited use of improved production/processing technologies, limited production due to the seasonal character and climatic conditions are the main challenges for the other stakeholders of straw mushroom value chain. To enhance the use of hi-technology in production, preservation and processing and to build a brand for the Vietnamese straw mushroom are proposed to improve the current issues of the sector.

**Keywords:** *Mushroom, value chain, stakeholder, Vietnam*

### **Introduction**

Straw mushroom is known as a new food for the future thanks to its clean, safe and high nutrition content (Getachew, 2016). This sector has been strongly growing in Vietnam since the last decade with more than 64,500 tons/year of production (Nguyen and Pham, 2013). The development of the sector helps improving not only farm household's income but also the environment by reducing pollution from rice straw burning at the end of the rice cultivation season. In 2010, basing on the ready available input materials from by-products of rice production and potential demand, the Vietnamese government decided to make mushrooms become one of five national strategy products (Ho, 2014) which means more investments received by the sector. In order to help the sector reaching this goal and growing more sustainably, the study was carried out in 2014 and 2016 to answers the questions what

are the current status of mushroom value chain as well as its opportunities and challenges, and what does the sector needs to improve by analysing stakeholders in the fresh straw mushroom value chain.

### **Materials and methods**

The research was conducted in the Mekong Delta, Vietnam which accounts for more than 90% of straw mushroom production of the country (MARD, 2012). The Participatory Rural Appraisal (PRA) (FAO, 1999) and Key Informant Interview (KII) (USAID, 1996) methods were applied to collect primary data through vary open questions and discussion with the different groups of actors in the value chain. Different meetings among the main actors of the straw mushroom value chain were organised in August 2014 in Can Tho University and in 2016 in Dong Nai province, Vietnam to get opinions of target groups and key persons, as well as information concerning the aims of the study. Relying on the discussion, it was easier to understand real problems and needs of each target group. In addition, potential solutions proposed by local communities that are appropriate for the existing problems and feasible to local community's resources were well understood for a qualitative analysis. Data were analysed by the Stakeholder Analysis method created by the UK Department for International Development (Brugha and Varvasovszky, 2006; DFDI, 2008).

### **Results and discussion**

#### *Fresh straw mushroom value chain in Vietnam*

Straw mushrooms are usually cultivated in the tropical climate condition like Vietnam or other South-Eastern Asian countries with the temperature at about 28<sup>0</sup>C-35<sup>0</sup>C and air humidity at about 75-90%. Currently, there are more than 100 species of straw mushrooms in Vietnam (Rice 2, 2017) which is a high potential for the country to develop the sector. Straw mushroom production process starts by producing spawn in combination with a paddy straw preparation for both in house and open air type of cultivation and as followed by different stages to the fully fruiting development. The process duration is only 10-18 days from the button, eggs, elongation to mature stages when the fruiting bodies form looks like an umbrella. In Vietnam, more than 80% of the population follow the Buddhist religion and almost eight percent are real Buddhists. Therefore straw mushroom market has a very high demand due to its high vegetarian protein content which is the main meal of Buddhists. Straw mushroom product has high demand on the first, fourteenth, fifteenth and thirtieth day of the lunar month and the seventh month of the lunar calendar due to the tradition of culture as a Buddhist country. Hence, fresh mushroom production is also very highly seasonal and focuses very much on above mentioned days. Farmers always have to calculate their cultivation calendar to supply to the market in order to get higher prices at high demand period in the market. Out of those days, the product prices could be dropped down by three or four times. Demand of the product in the market has a high potential. The fresh straw mushroom distributes in the markets through the three following flows:

- 1) Flow 1: Farmers → Collectors → Retailers (at supermarkets or markets) → Consumers;
- 2) Flow 2: Farmers → Collectors → Processors;
- 3) Flow 3: Farmers → Consumers.

The first flow is the main distribution channel of fresh mushroom from farmers to consumers followed by the second, and the third, respectively.

Different stages of the production process and product flows enlighten the role of main actors in the fresh straw mushroom value chain in Vietnam involving primary and secondary ones. The main primary actors of fresh straw mushroom value chain include input suppliers,



production farmers, collectors, processors, retailers and consumers (Figure 1). Secondary actors of the fresh straw mushroom value chain are noted as Extension services which support technique and market information for farmers, research institutions which carry out the studies on techniques to produce better quality of spawn and other techniques concerning the sector, local authorities represented by the Department of Agriculture and Rural Development of provinces, and bankers.

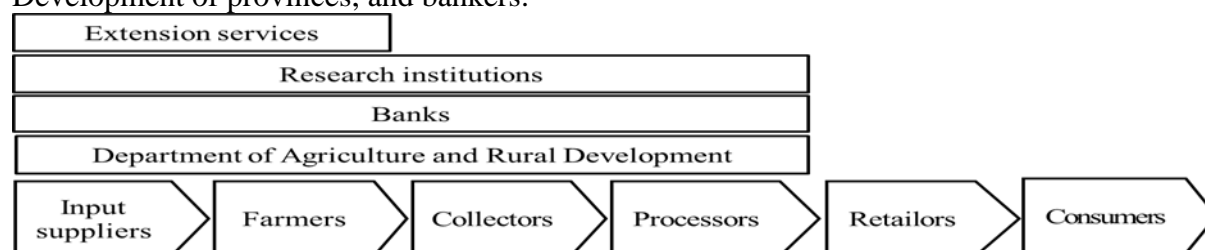


Figure 10 Fresh straw mushroom value chain in Vietnam

*Analysis of main fresh straw mushroom stakeholders*

**Input suppliers** provide input material such as spawn, paddy straw and chemicals for farmers to cultivate. They are one step backward of farmers in the straw mushroom value chain. Currently, farmers buy spawn and pay cash for input suppliers. There is no credit form for this action. Though the straw mushroom production sector exists since a long time in Vietnam, spawn producers are known as small scale, too low technique and skill level to produce high quality outputs. Therefore, spawns provided to farmers are often of low quality, lead to low yield of mushrooms on farm. The study observed that spawn diseases in recent years are also a very big problem which prevents the sector to increase its production.

**Production farmers** play a very important role in the fresh straw mushroom value chain in Vietnam. Farmers made up their paddy straw to cultivate mushrooms at the early step of the sector history. By the time, when the product became an important commodity for the country defined by the government in the national product strategy, farmers invested more with an expectation to get a higher profit. Presently, there are two mushroom cultivation types such as in house and outdoor. Average production area is 70-150 m<sup>2</sup>/in house farm and 1,500/outdoor farm, showing the small scale of mushroom farmers. Farmers reached an average yield of 8-10 tons/ha and sold at VND 40-60 billion/ton depending on harvest time of the day and season. Mushrooms were cultivated two or three times per yers depending on rice production seasons and climate conditions.

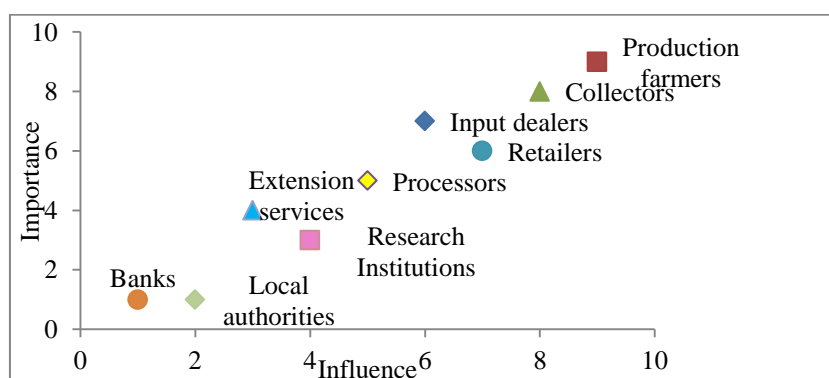


Figure 11 Influence and importance matrix of farmers in the straw mushroom chain in Vietnam

The influence and importance matrix of farmers in the straw mushroom value chain is presented in the figure 2. Farmers stay at the highest position in the matrix compared to other

primary actors like input suppliers, collectors, retailers and processors showing that the sector is still supply-driven rather than demand-driven. This trend created excess product volumes on the market the next days after traditional demand days as mentioned above. As the product is a fresh food with short life duration of 3-4 days, selling price will drop down sharply on the next days after harvest. Nevertheless, a short production circle will help farmers to get a return on investment faster.

Cultivation outputs were presented to collectors at around 9am on local market. Due to its typical fresh product character, farmers only brought their mushroom sample to the market and sold them under informal auction form. The selling price was decided by farmers after consulting different prices given by collectors basing on their product quality. Harvest of mushrooms only started after this action until 12am. Only a direct cash payment relation exists among collectors and farmers. Therefore banks do not have much influence on farmers' activities and demand.

Most of straw mushroom farmers are also rice producers. They cultivate mushrooms after rice harvest period by making up their family labour and land. For that reason, mushroom production is not the main activity of farmers. Consequently mushroom income is not the main income source of the household. This observation is confirmed in a research of Ngo (2017). Hence, farmers do not invest a large amount in mushroom activities. This leads their technical level staying at a low, old and early stage compared to current advanced techniques of the sector in the world. Low yields and low economic efficiency are obvious results. Furthermore, as the market is the supply-driven one, farmers have been presently concentrated their actions on technology, and much less on marketing.

**Collectors** rank at the second most important position in the fresh mushroom value chain after farmers, and before processors and retailers. In this value chain, collectors also play the role of wholesalers to supply fresh products to retailers and processors. This is the different point compared to other agro-product value chains in Vietnam mentioned in Ho (2012), and Ho and Burny (2016). Collectors provide reference market information to farmers on product price, demand and production period. However, the study noted that there is not any product quality preferences provided by collectors to producers. There is no official cooperation between farmers and collectors. The relationship among them is not strong.

**Processors** do not play a very strong role in the fresh straw mushroom value chain in Vietnam. They bought their input only from collectors. There is not any quality standard for straw mushroom products set up by the government therefore they do not have preferences for their input materials. Currently, processors do not get enough fresh mushrooms for their process. Boiled, cut and salty mushrooms conserved in cans and dried mushrooms are the main outputs of processors. Most of their products are for exports and a very small volume is supplied to the domestic market. No official relation among processors and other actors in the value chain was found during the study.

**Retailers** are one step forward of collectors in the fresh straw mushroom value chain in Vietnam. They are the main fresh mushroom suppliers to consumers in Vietnam. The product is often sold in the traditional markets rather than specialised shops or supermarkets due to the habit of Vietnamese customers to buy fresh food. Harvested mushroom arrived usually to retailers from collectors within maximum one day. Retailers just keep their goods for 2-3 days basing on its level of freshness. Currently, there is not any conservation technique to prolong mushroom life.

*SWOT analysis of fresh straw mushroom value chain in Vietnam*

Table 1 shows an analysis of fresh straw mushroom value chain in Vietnam where there is no official collaboration among the primary actors.

Table 5. SWOT analysis of straw mushroom value chain in Vietnam

Strengths	Opportunities
<ul style="list-style-type: none"> <li>• Lack of collaboration resulting in high transaction costs and high consumer prices</li> <li>• High tech skill on spawn production</li> <li>• Limited plant protection knowledge: mushroom disease</li> <li>• Limited use of improved production/processing technologies</li> <li>• Limited production due to seasonal character and climatic conditions</li> </ul>	<ul style="list-style-type: none"> <li>• A clean, safe and high nutritious food</li> <li>• Abundance of low cost mushroom growing materials: straws, logs, enriched sawdust → reducing the loss of roots and tubers</li> <li>• Low investment cost, depending on production scale. Quickly received income circle.</li> <li>• Low land use, labour effort use and water use</li> <li>• Great potential: could reach 40 million tonnes per year</li> <li>• Enhancing the use of hi-technology in production, preservation and processing and build brand for Vietnamese mushroom</li> </ul>
Weaknesses	Threats
<ul style="list-style-type: none"> <li>- Low technical skills</li> <li>- High capital requirement</li> <li>- Low education level to learn new technology</li> </ul>	<ul style="list-style-type: none"> <li>- No support from government</li> <li>- High competitiveness among actors</li> <li>- Seasoning of straw mushroom production</li> </ul>

### Conclusions

Primary actors of fresh straw mushroom value chain currently do not play very well their roles to help the product become a main commodity in the market as expected by the Vietnamese government. Though farmers have many opportunities thanks to the quickly received income circle, low land and labour effort use, farmers and processing plants still have limited use of improved production/processing technologies and their investments remain low. The limited production due to its seasonal character and climatic conditions is also a challenge that hinders the increase of the farmers' production. Consequently, processors do not have enough raw materials to deal with. No official relation among actors is also a restrain of this value chain.

Enhancing the use of hi-technology in production, preservation and processing for the Vietnamese straw mushroom and building a mushroom brand name are proposed to improve the current status of the sector in order to achieve the government's national product development strategy issued in 2010.

Further quantitative analysis of the fresh mushroom value chain needs to be conducted to confirm the results of this study and to get a more precise and in-depth knowledge of this sector.

### References

- Brugha, R. and Varvasovszky, Z. (2006). A stakeholder analysis. *Health Policy and Planning* (2000) 15 (3). p338-345.
- FAO (1999). *Conducting a PRA Training and Modifying PRA Tools to Your Needs. An Example from a Participatory Household Food Security and Nutrition Project in Ethiopia.* Consulted on 5th july 2017 at <http://www.fao.org/docrep/003/x5996e/x5996e06.htm>
- Getachew, D. W., Zemedu L. S., and Eshete A. W. (2016). Mushroom value chain analysis in Addis Ababa Ethiopia. *Journal of Agricultural Extension and Rural Development*. Vol.8(8), p130-140.

- Ho, T. M. H. (2012). Integration of farmer in the shrimp subsector in Mekong River Delta, Vietnam, 177p, PhD thesis. Gembloux, Belgium.
- Ho, T. M. H. (2014). Straw mushroom value chain: a strategy product for Vietnam. Chain wide Learning conference within the international refresh course on Market Access for Sustainable Development organised by Centre for Development and Innovation, Wageningen University, The Netherlands.
- Ho, T. M. H. and Burny P. (2016). Impact of value chain governance on the development of small scale shrimp farmers in Vietnam, *International Journal of Business and Economic Sciences Applied Research*, Volume 9 Issue 2-Special Issue of the 1st International Conference of Development and Economy, ISSN: 2408-0098, p93-98.
- Ministry of Agriculture and Rural Development of Vietnam-MARD (2012). MARD report on Current status of mushroom production and consumption in Vitenam presented at the Conferences on Current status of mushroom production and consumption in Vitenam organised in Ho Chi Minh city, 2012.
- Ngo, T. T. T. and Nguyen T. Q. H. (2017). Economic efficiency of outdoor straw mushroom (*Volvariella volvacea*) production in Long My District, Hau Giang Province. *Vietnam J. Agri. Sci.* 2017, Vol. 15, No. 1. p118-127.
- Nguyen, N. H. and Pham, V. D (2013). Current status and solutions for mushroom development in Vietnam. Rural development and agricultural extension forum. Special issue on Efficient development of mushroom cultivation in Vietnam. p17-25.
- Rice 2 (2017). Several popular mushroom varieties cultivated in Vietnam. Consulted on 7th July 2017 at <https://m.2lua.vn/article/mot-so-loai-nam-dang-nuoi-trong-pho-bien-o-nuoc-ta-5844e4a9e495194c018b456b.html>
- UK Department of International Development (2008). Making value chains work better for the poor: A tool book for Practitioners of value chain analysis. Version 3. Making markets work better for the poor (M4P). Agricultural development international: Phnom Penh, Cambodia.
- USAID (1996). Conducting key informant interviews, Performance Monitoring and Evaluation Tips, Number 2, USAID Center for Development Information and Evaluation.

## **THE NEED FOR INNOVATION POLICY SUPPORT IN AGRI-FOOD SECTOR**

Marcin GOSPODAROWICZ, Adam WASILEWSKI, Marek WIGIER

Institute of Agricultural and Food Economics – National Research Institute, Warsaw, Poland

\*Corresponding author: Adam.Wasilewski@ierigz.waw.pl

### **Abstract**

The research objective of this paper is preliminary justification of the need to support the transfer of innovations to the food-processing sector. Another objective of the study is also to determine changes in the last period in policies to improve innovativeness and induced by them changes in legislation related to the system of innovation transfer. The basis for the research was studied literature, especially in the field of main stream economics, New Institutional Economics, public choice theory. According to the literature review the public financial support generally slows down the process of innovation transfer, but it is necessary if other countries apply such instrument. The empirical material for analysis was the statistical data of the Central Statistical Office (CSO) for the years 2010-2015 and Agency for Restructuring and Modernization of Agriculture (ARMA). The findings show that in the case of food processing sector the efficient policy support in innovation transfer seems to be needful. Conducted research also shows that it is very urgent issue. Reached findings lead also to the formulation of questions for further research, i.e. what are the appropriate policy measures to induce innovativeness improvement in food processing sector.

**Key-words:** innovation policy, food processing, law, fiscal policy.

### **Introduction**

Poland is now a country with a relatively low level of innovation in the economy. According to the report of the European Commission (2014), a synthetic innovation indicator of the Polish economy amounted to 0.279, which put Poland in the group of countries with moderate innovation (Tusinska 2015). In fact, Poland was ahead in terms of innovation to only those European Union countries such as Bulgaria, Latvia and Romania. Reasonable seems to be speculation that one reason for this may be unreliable transfer system of innovation in the sector engaged in research and development to manufacturing and services. The increase innovativeness of the economy is, however, one of the priorities of European Union policy for 2014-2020. Under this policy, Poland should receive from structural funds the amount of EUR 82.5 billion, much of which can and should be used for the development of innovativeness.

Low level of innovation in the economy or its specific sector may be due to market failures that are related to the extent of the occurrence of certain internal structures (Hewitt-Dundas, Roper 2017). This provides grounds to the introduction of various institutional arrangements - e.g. to prepare and implement appropriate policies - supporting the transfer of innovation. When undertaking such initiatives with respect to a particular sector, it is worth to examine whether they are justified by the importance of this sector to the national economy. Another aspect to be considered is the current use of knowledge in the business. It may turn out that the sector does not require state intervention. Therefore the research objective of this study is preliminary justification of the need to support the transfer of innovations to the food-processing sector, which seems to be very important for rural economy as well as whole

economy of Poland. Another objective of the study is also to determine changes in the last period in policies to improve innovativeness and induced by them changes in legislation related to the system of innovation transfer.

### **Methodical approach**

The paper presents the results of the first stage of the research on institutional determinants of transfer of innovation into economic activity with particular focus on agri-food sector and rural areas in Poland. The basis for the research was studied literature, especially in the field of main stream economics, New Institutional Economics and public choice theory, referring to the question of the importance of knowledge transfer to business. Documentation studies were carried out also in the field of literature consolidating issues related to innovation and process of innovation transfer, the development strategy of determining the directions of the policy and the main acts forming the regulatory environment. Assessment of the importance of food processing and innovation in this sector were carried out using methods of descriptive and comparative analysis. The empirical material was the statistical data of the Central Statistical Office (CSO) for the years 2010-2015 and Agency for Restructuring and Modernisation of Agriculture (ARMA). Empirical studies were conducted at the national level.

### **Theoretical background**

When considering the issue of institutional support for the transfer of innovation must be first and foremost in mind the fact that it can be a form of state interference in market processes. From the theory of prosperity, it is clear, however, that the market economy is inherently efficient (Feldman, Serrano 2006 Mas-Colell et al., 1995, Herbener 1997). The existence of a market economy in the European Union should therefore lead to the widespread use of innovation as a source of performance (Aghion, Jarave 2015 Arrow 1962 Thirtle, Ruttan 1987). In this case, support the transfer of knowledge and implementation of new innovative solutions should be superfluous and even leading to deterioration in efficiency. This can in fact be considered as a form of interventionism, which is not conducive to improving efficiency (Ajefu, Barde 2015, Cordato 1980, Grand 1991) - of course if these activities are directed only to a specific group of companies.

The economic literature indicates, however, the existence of market failure (Stiglitz 2004), which is a source of inefficiency. Therefore, we can believe that imperfect competition, asymmetric information and other market failures are limiting to a certain extent the use of innovation as a source of efficiency. An example of this is large diversity of innovative economies of the European Union (European Commission 2014) and the fact that the policy of support for the transfer of innovation not always causes an adequate growth of economic innovation (European Commission 2013). In practice, the country's economic growth - at least in the short term - is not necessarily due to the transfer of knowledge to industry and services sectors. Its source may be the low price of labour factor, the availability of cheap raw materials and favourable conditions on the world market (Kasperkiewicz 2008). According to Kasperkiewicz (2008), Polish economic growth in recent years has also resulted primarily from the use of these factors. Underestimation of the importance of knowledge transfer has led, however, to maintain, and even the rise of the technological gap between Poland and the most innovative economies of the European Union.

Limited use of knowledge as a factor of development and economic growth may concern the entire national economy and its individual sectors (Consortium Europe INNOVA 2011, Pavitt 1984, Malerba et al. 1997). All sectors, including food processing sector, are exposed to it.

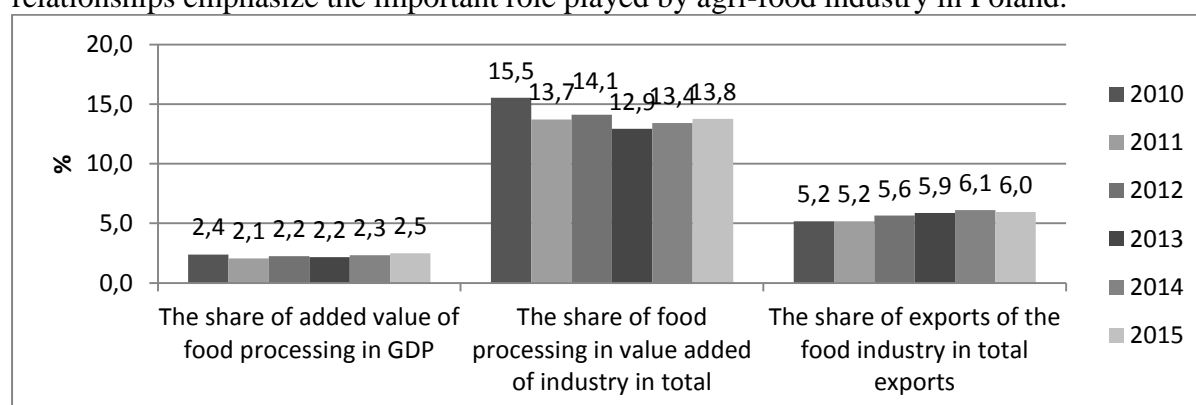
One of the main reasons for limited innovation is existing structural conditions of a particular sector in a particular state. It can be exemplified by the implementation of organizational innovations related to new methods of human resource management in Serbia (Ratković 2015). According to Ratković (2015), the implementation of these innovations was conditional upon both the size of the company and form of ownership. It is generally that innovation results from complex interaction mechanisms. In small food firms innovation is strongly interwoven with the dynamics of the local environment, are also related to the characteristics of the firm (Noronha Vaz et al. 2004). The specificity of the structure of the food industry in Poland (Mroczek 2014) may also condition the specific institutional arrangements for promoting innovation transfer. The specific structure of the sector can be a barrier to the transfer of innovation to be taken into account when planning policy of support for this process. The internal structures of a particular sector are tied to a certain extent market failures. Example may be the unreliability of competition and information asymmetry. The severity of specific market failure is linked in turn to the degree of utilization of knowledge as a factor of efficiency improvements. This in turn may lead to institutional changes in the area of knowledge transfer, as exemplified by various policies oriented to support this process. Currently, one of the main trends of dealing with the role of the institution is the New Institutional Economics. With reference to the relationship between competition and knowledge transfer one of the leading representatives of this trend, namely North (2005) states that "... companies, political parties, and even higher education institutions in the face of competing organizations must strive to improve efficiency." According to the author muffled competition limits the motivation of organization to invest in new knowledge and, consequently, does not cause sudden institutional changes. On the other hand, strong competition accelerates institutional changes. In these considerations, the author concludes, therefore, that the cause of improvement of the effectiveness is generally the competition, and the measure for this is raising the level of knowledge.

Assuming the occurrence of dependences indicated by North it can be said that the support of the transfer of knowledge, e.g. by pursuing specific policies should take into account the competitive environment in which the organization operates, i.e. the company. If competition is negligible, the support for entrepreneurship through subsidizing the transfer of knowledge can bring marginal results, because companies will not be motivated to use it. Whereas the opposite effect will be in a highly competitive environment. From the above relationships, it also appears that some policies to support economic activity, as a form of assistance that utilize transfers of funds to selected companies, can cause the elimination of competitive companies in the long term to limit the willingness to invest in new knowledge, due to the lack of sufficient competition. So designing institutional support for the transfer of innovation should be taken into account the interactions that may occur between the hitherto functioning forms of business support, and the new - that should be considered for public support for transfers of innovation. Under certain conditions, however, policies may complement each other. Such a situation appears when in the conditions of zero competition financial transfers will contribute to the creation of new businesses, which will motivate existing businesses to improve efficiency, e.g. by implementing new innovative solutions. Institutions supporting the transfer of knowledge could then make a big difference for those companies that cannot cope with its acquisition on market principles. The consequence may then form an even more competitive environment. The scale of this support and the conditions, under which it is granted, however, should be defined in such a way as not to eliminate companies from the market using a particular policy.

## Results and discussion

The study confirmed to a certain extent the importance of food processing for the Polish economy. Generally importance of this sector is primarily due to the fact that it allows the use of domestic raw materials produced in agriculture. However, the gross value added produced in this sector in 2015 reached over PLN 43 billion. It is 2.5% of Polish GDP (Figure 1). The share of manufacturing in gross domestic product, however, maintained since 2010 at a relatively constant level. Since 2010 a downward trend in the share of the food processing in industry value added is shown (Figure 1). In the analyzed period, this decline amounted to 1.7 percentage point. This may to some extent indicate that opportunities for further development based on the existing structure of production factors have been exhausted.

The processing of domestic raw materials, a significant role in the creation of Polish GDP and declining share in the added value of the industry is already some evidence to justify the institutional support for transfer of innovation in the food industry. However, the importance of this industry in the Polish economy much more indicates its achievements in terms of exports. Analyses show that in 2010-2015 exports of this sector accounted for over 6% of total exports in the economy and it showed an upward trend. This means that Polish food processing industry is competitive on the international market. It is also able to improve its competitive position. Foreign net trade of food processing is growing steadily. In 2013, this industry exports exceeded imports of more than 60%. In the case of the entire national economy, in the analyzed period, there was a negative balance of foreign trade. These relationships emphasize the important role played by agri-food industry in Poland.



Source: Calculations based on statistic data from the Central Statistical Office.

**Fig. 1 The importance of food processing for the Polish economy in years 2010-2015.**

Food processing industry also plays an important role in shaping the labour market in Poland. The sector employs about 450 thousand people, representing about 16.5% of all those working in the industry. The share of food processing in employment is therefore higher than the share of value added. This phenomenon can be seen on one hand as positive because the food industry produces relatively more jobs and to some extent, more than other sectors it contributes to reducing unemployment. On the other hand, such relations testify to the lower labour productivity. This is confirmed by further studies, which indicates that labour productivity measured in terms of gross value added per 1 employee was lower in the food processing than in the industry in general. In addition, in 2010-2013, growth in labour productivity in the food industry amounted to PLN 8.1 thousand, while in industry up to PLN 25.5 thousand. The growth rate of labour productivity in food processing was so much lower. This in turn is another prerequisite to the conclusion that the development of this sector to a lesser extent, based on the implementation of new, innovative production technologies, and the basis of this development are still low labour costs.



The research shows that only less than 12% of enterprises engaged in food processing in 2011-2013 has been introducing any innovation. Throughout the industrial sector such enterprises was 6.5 percentage points more. In the agri-food industry was relatively fewer companies than in the whole industrial sector, for both product innovation and process. Differences in the implementation of different types of innovation, however, were developed at a similar level. This means that the improvement in innovation of agri-food processing can be associated with significant changes in both the technology used in production and organization of the production process. This observation is confirmed by the fact that only 6% of companies in this sector both implemented the considered types of innovation.

The development strategy of Poland also includes the growth of economic innovation as a separate objective. In Poland is not expected the increase in expenditure on R&D to 3% of GDP, as in the Europe 2020 strategy, but only a "substantial increase in spending", which is quite imprecise term. However, it is expected to take measures to increase demand for innovative solutions among entrepreneurs. Among the instruments that are geared to achieving this objective are mentioned:

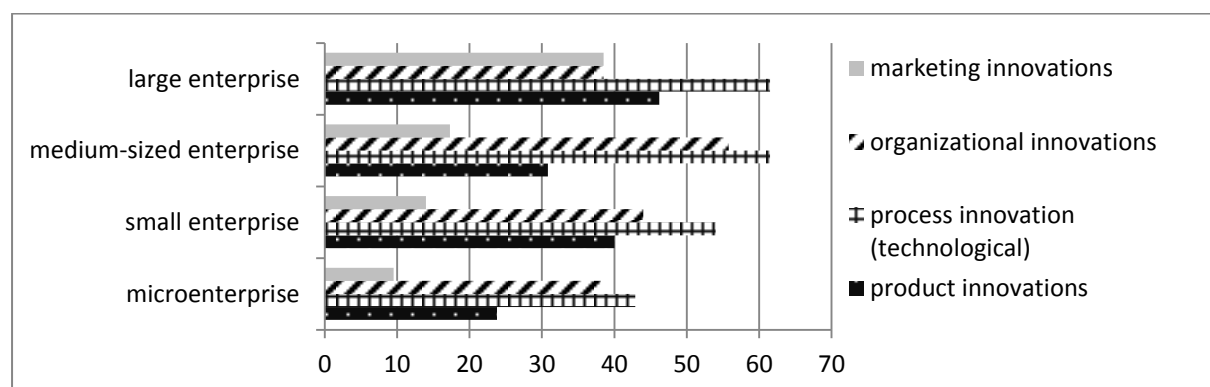
- tax instruments,
- loan guaranties,
- revolving instruments,

Support for investments in the food industry in Poland under EU aid programmes implemented in period 2003-2015 exceeded 1.4 billion Euro, including the share of European funds – over 1 billion Euro. The RDP program 2007-2013 was supported 996 food companies with funds in the amount of 0.5 billion Euro, and the total amount of investment has exceeded 1.6 billion Euro. The table 1 and figure 2 present in sequence number of enterprises introducing new products or techniques nad percentage of enterprises implementing different types of innovation projects in RDP 2007-2013.

	New product	The new technics (including technology)	New products and new techniques
Food industry	61	124	26
Industry non food	23	16	2
Wholesale	15	35	2
Total	99	175	30

Source: Monitoring data from the ARMA.

Table 1. Number of enterprises introducing new products and / or techniques in RDP 2007-2013



Source: Calculations based on monitoring data from the ARMA.

Fig. 2. Percentage of enterprises implementing different types of innovation projects in RDP 2007-2013, by size of enterprises

In addition, this strategy involves the development of the financial market enhancing innovativeness. A special role will play:

- capital funds,
- loan or guarantee funds,
- leasing companies.

In connection with the implementation of the objectives of these development strategy aimed at improving innovation in the economy, some steps have already been made in aligning legislation. This is reflected in the Act of 25 September 2015 on the change of certain acts in relation to the promotion of innovation (Journal of Laws 2015).

### **Conclusions**

According to persisting economic theories each policy is a form of the interventionism, which disturb market processes. Usually it is justified by government failure, which leads to the inefficient resource allocation. Therefore policy measures should be as much market-friendly as possible. In the last period we observe the evolution in policy measures focused on innovativeness improvement. Both EU policy measures and national ones are more oriented on the utilisation of repayable financial instruments than on the support in the form of direct subsidizing of economic activity linked to the innovation transfer. It seems to be right way to increase the efficiency of EU and national policy.

In the case of food processing sector the efficient policy support in innovation transfer seems to be needful. Conducted research also shows that it is very urgent issue. The high input in GDP and positive balance of foreign trade justify the importance of this sector for Polish economy. Food processing creates also a lot of jobs for rural people. But the reason of its success is still low labour cost – not the innovativeness of products and processes. It can be the barrier of its development or even defeat in the long run. Reached findings lead also to the formulation of questions for further research, i.e. what are the appropriate policy measures to induce innovativeness improvement in food processing sector, which will be efficient and acceptable and do we really need to create a new set of measures or we can introduce the solutions existing in other EU and non-EU countries.

### **References**

- Aghion, P., Jarave, X. (2015). Knowledge spillovers, innovation and growth. *Economic Journal*, 125 (March), John Wiley & Sons Ltd on behalf of Royal Economic Society. Published by John Wiley & Sons, USA, 533–573.
- Ajefu, J., Barde, J. (2015). Market Efficiency and Government Intervention Revisited: What Dorecent Evidence Tell Us? *Journal of International Business and Economics*, 3(1), American Research Institute for Policy Development, 20-23.
- Arrow, K. (1962). Economic welfare and the allocation of resources for invention. (in: R. Nelson, ed.) *The Rate and Direction of Inventive Activity*. Princeton: Princeton University Press.
- Consortium Europe INNOVA. (2011). Sectoral Innovation Watch. [http://www.praxis.ee/wp-content/uploads/2014/03/sector-report-knowledge\\_en.pdf](http://www.praxis.ee/wp-content/uploads/2014/03/sector-report-knowledge_en.pdf).
- Cordato, R. (1980). The Austrian Theory of Efficiency. *The Journal of Libertarian Studies*, 4(4), 393-403.
- European Commission. (2013). Knowledge Transfer Study 2010 – 2012. Directorate-General for Research and Innovation, Brussels.
- European Commission. (2014). Innovation Union Scoreboard. Brussels.

- Feldman, A., Serrano, R. (2006). *Welfare Economics and Social Choice Theory*. Springer US, 1-369.
- Grand, J. (1991). The theory of government failure. *British Journal of Political Science*, 21(4), 423-442.
- Herbener, J. (1997). The Pareto rule and welfare economics. *Review of Austrian Economics*, 1, 79-106.
- Hewitt-Dundas, N., Roper, S. (2017). Exploring Market Failures in Open Innovation. *International Small Business Journal*, 1-18.
- Journal of Laws 1991 No 80 item 350 as amended.
- Journal of Laws 1992 No 21 item 86 as amended.
- Journal of Laws 2005 No 57 item 491 as amended.
- Journal of Laws 2015 item 1767.
- Kaperkiewicz, W. (2008). In search of innovation strategy of the Polish economy. *CeDeWu, Warsaw*, 27-46.
- Malerba, F., Orsenlgo, L., & Peretto, P. (1997). Persistence of innovative activities, sectoral patterns of innovation and international technological specialization. *International Journal of Industrial Organization*, 15, 801-826.
- Noronha Vaz T., Vieane J., Wigier M., (2004) *Innovation in Small Firms and Dynamics of Local Development*, Scholar Publishing House, Warsaw, 1-258.
- Tusinska, M. (2015). The fundamentals of innovativeness – a comparative analysis of European Union countries. *Journal of Economics and Management*, Vol. 20 (2) Katowice, 23-37.

## **ASSESSING THE EXTERNAL ENVIRONMENT OF PUBLIC EXTENSION SYSTEM IN THE KINGDOM OF SAUDI ARABIA**

Bander M. ALSAGHAN<sup>1</sup>, Ahmed M. DIAB<sup>2\*</sup>

<sup>1</sup>National Agriculture & Animal Resources Research Centre, Ministry of Environment, Water & Agriculture, Riyadh, Kingdom of Saudi Arabia

<sup>2</sup>Departement of Rural Sociology and Agricultural Extension, Faculty of Agriculture, Assiut University, the New Valley Branch, Kharga, Egypt

\*Corresponding author: a.diab@aun.edu.eg

### **Abstract**

The government of the Kingdom of Saudi Arabia (KSA) is increasingly emphasizing the importance of institutional re-arrangements. One area of current interest to the Ministry of Environment, Water & Agriculture involves reforming public agricultural extension system. This research aimed to assess the external environment of KSA national system of agricultural extension. A scale concerning the external environment of organization (seven dimensions with 39 statements) was used for the assessment. The reliability of the scale was estimated by Cronbach's alpha; reliability coefficient was 0.813. Data were collected using an internet-based questionnaire form (in collaboration with Extension Administration, Ministry of Agriculture) with 81 extension personnel representing all extension directories in the country during the period May-August 2016. Percentages and mean scores were used for data presentation. The findings revealed that scores for extension personnel's perceptions of the external environment scale were above average levels for four components (socio-cultural, political, administrative, and geographical environment) of the scale and below average levels for the remaining three components (technological, legal and economic environment). The mean score of socio-cultural environment was at the top of the list with the mean score of 3.98 (66.3% of the maximum score), followed by political environment (63.1%). While the mean of extension personnel's perception of the economic environment reached 4.5 (37.6%) followed by legal environment with about 45.6% of the maximum score. The result also showed that the mean score of the total scale reached 41, which represent 52.63% of the total score of the scale. Finally, some interventions for more enabling external environment of extension organization were recommended.

**Keywords:** *Organizational environment, Agricultural extension, Saudi Arabia*

### **Introduction**

Approximately spreading over an area about four-fifths of the Arab Peninsula, with a total area of around 2,000,000 square kilometers, the kingdom of Saudi Arabia is the home of 31.8 million masses. It comprises about 80 percent of the Arabian Peninsula. It has borders with Jordon, Iraq and Kuwait in the north; Arab Gulf, Bahrain, Qatar and the United Arab Emirates in the east; the Sultanate of Oman and Yemen in the south and the Red Sea with a coastline of 1750 km in the west. The climate of Saudi Arabia varies from one region to another because of its diverse topographical features. As a result of a subtropical high-pressure system, the Kingdom is generally hot in summer and cold in winter where rains fall often. Moderate climate is seen in the west and the southwestern part of the Kingdom; dry hot summer and cold winter in the interior parts; and high temperature and humidity in the coastal areas. Major parts of the Kingdom usually receive scanty amounts of rain in winter

and spring. However, in the summer, rainfall is significant in the southwestern mountains. Humidity is high on the western coasts and mountains almost all year and it gets lower as we go inland. The Kingdom is divided into 13 administrative regions. Each one of them is divided into a number of governorates differentiating in number from one region to another. And each governorate is divided into centers linked administratively to the governorate itself or the emirate. The emirate, governorate or center includes a number of population settlements linked administratively to it (GASTAT, 2016).

The Ministry of Agriculture has an elaborate network of centers, branches and facilities located across the country that provide various agriculture-related services to the farmers and other stakeholders in line with the mandate of the Ministry. The network comprises the following: six main sectors (five technical i.e. agriculture, agricultural development, livestock and fisheries, as well as agricultural natural resources and one for administrative and financial affairs), thirteen general directorates for agricultural affairs, located in main provinces, twelve directorates, 122 branches, 28 agricultural plant and animal quarantines, 34 veterinary units, 5 agricultural research centers, one olive research unit, three aquaculture research centers, 10 centers and branches for fisheries services, a national research center for combating locusts, eight veterinary diagnostic laboratories, a veterinary vaccine production center, a gene bank and artificial insemination, eight veterinary laboratories, and four agricultural training centers. The ministry has overall responsibility for providing public agricultural extensions services to the farmers. The Extension and Agricultural Services Division, performs this function in collaboration with the extension staff located in the General Directorates for Agricultural Affairs (Alsaghan, 2006, 2011; Ministry of Agriculture, 2016; Alsaghan et al., 2017; GFRAS, 2017).

Organizations are social entities oriented to certain goals. They are characterized by a designed structure and coordinated activities, and are open in terms of closeness with their environment (Fabac, 2010: 34). Organizations could be handled as open systems getting influences from the environment where they act, but the influence is not only unilateral; organizations also target shaping and reshaping the environments for themselves (Reino, et al., 2007: 124). The organization does not exist in a vacuum. It is located in a country and region to which it is inextricably linked. It operates within a legal and cultural context. These and other external-environment variables influence how an organization operates and what it produces. Such variables can shape the ways an organization defines itself and the ways it defines good performance (Lusthaus *et al.*, 1999: 52). The organizational environment is defined as all elements that exist outside the boundary of the organization and have the potential to affect all or part of the organization. The environment of an organization can be understood by analyzing its domain within external sectors (Daft, 2010: 53).

The development of any organization is one of the most important goals of its policy makers, so as to achieve the organization's objectives and programs to promote and grow at the level of the organization (Al-Qahtani, 2015). The process of improving the performance of any organization is the essence of comparing the actual performance of the organization with predetermined standards and measures. It aimed to diagnose, shed the light on the deviations and identify causes in order to taking the necessary rearrangements (AbdulRahman and Majeed, 2012: 191).

The organizational environment could be subdivided into the task environment and general environment as follows (Daft, 2010: 54-55): i) The task/ internal environment includes sectors with which the organization interacts directly and that have a direct impact on the organization's ability to achieve its goals. The task environment typically includes the industry, raw materials, and market sectors, and perhaps the human resources and international sectors; and ii) The general/ external environment includes those sectors that may not have a direct impact on the daily operations of a firm but will indirectly influence it.

The general environment often includes the political, sociocultural, legal conditions, technology, and economic resources sectors. In contrast to the specific or task environment, the general or external environment mostly influences many enterprises at the same time. The term ‘external environment’ means the total of all individuals, institutions and other forces that are outside the control of the organization but that may affect its performance (Kattookaran, 2015: 5)

A good understanding of environment by managers enables them not only to identify and evaluate, but also to react to the forces external to their organizations. Thus, the economic, social, political, technological and other forces which operate outside the organization are part of its environment (ICSI, 2014: 2).

Dimensions of, or the factors constituting the external environment include economic, social, technological, political and legal conditions, which are considered relevant for decision-making and improving the performance of an enterprise. However, management of every organization can benefit from being aware of these dimensions instead of being disinterested in them. Elements constituting the external environment of organization are given below (Lusthaus *et al.*, 1999: 52-56; ICSI, 2014; Kattookaran, 2015):

1. **Administrative Environment** includes all administrative issues that can affect the organization i.e. administrative norms and values, rules of related organizations, bureaucracy, etc.
2. **Economic Environment:** Interest rates, inflation rates, changes in disposable income of people, stock market indices and the value of SR are some of the economic factors that can affect management practices in an organization.
3. **Socio-cultural Environment:** The social environment of organization includes the social forces like customs and traditions, values, social trends, society’s expectations from business, etc.
4. **Technological Environment** includes forces relating to scientific improvements and innovations which provide new ways of producing goods and services and new methods and techniques of operating a business.
5. **Political Environment** includes political conditions such as general stability and peace in the country and specific attitudes that government representatives hold towards organization.
6. **Legal Environment** includes various legislations passed by the Government, administrative orders issued by government authorities, court judgments as well as the decisions rendered by various commissions and agencies at every level of the government.
7. **Geographical Environment** includes geographical conditions such as location, climate, and natural phenomenon and ecological factors that can effect on the organization.

Extension organization does not exist in isolation. Each organization is not an island unto itself; it exists, survives and grows within the context of the element and forces of its environment. While an individual organization is able to do little to change or control these forces, it has no alternative to responding or adapting according to them. Based on this quick discussion, this study is aimed to assess the external environment of KSA public system of agricultural extension.

## **Materials and Methods**

A scale for organizational external environment (seven dimensions with 39 statements) was developed based on review of literature in the field of organizational environment. Respondents were asked to indicate their opinion on each statement on a 3-

point scale ranging from zero to 2 (not applicable, somewhat, applicable). The reliability of the scale was estimated by Cronbach's alpha. Data were collected using internet-based questionnaire (in collaboration with Extension Administration, Ministry of Agriculture) form within personal interviews with 81 extension personnel representatives from the extension directorates around the nation during the period from May-August 2016. Percentages and mean scores were used for data presentation.

In order to confirm the reliability of the used scale, reliability analysis (for the items of each component and the overall scale) was carried out via Cronbach's alpha by SPSS software. Findings in table 1 show that reliability coefficient (Cronbach's Alpha) was about 0.813 for the overall scale. While it ranged from 0.656 to 0.879 for the components of the scale. These findings indicate that the scale is reliable and could be used for measuring the external environment of agricultural extension system in KSA.

Table 1. Number of items of organizational environment dimensions and corresponding values of Cronbach's Alpha.

No	Dimensions of external environment	No. of items	Cronbach's Alpha
1	Socio-Cultural Environment	3	0.665
2	Political Environment	6	0.825
3	Administrative Environment	10	0.880
4	Geographical Environment	3	0.656
5	Technological Environment	5	0.847
6	Legal Environment	6	0.875
7	Economic Environment	6	0.879
	Overall External Environment	39	0.813

Source: The study's findings.

## **Results & Discussion**

Table 2 shows mean scores and percentages for extension workers' perception of the organizational environment dimensions. It can be realized that the respondents' overall perception of the enabling environment for extension system is 40 which represents 52.6% of the total score; this implies that extension workers barely perceive the enabling environment for public agricultural extension organization in KSA. The table also revealed that scores of four dimensions of external environment are above overall average of scale while the remaining three are under the overall average scores.

The table revealed also that "Socio-cultural environment" received the highest score among the seven components (66.3% of the maximum score) followed by the "political environment" (63.1%). This implies that public agricultural extension system has gained the socio-cultural advocacy as well as the political advocacy which could be reflected in its potential success.

On the other hand the "economic environment" received the lowest score (37.6%) followed by the "legal environment" (45.6%) and the "technological environment" (52%); this indicates that the low satisfaction of the extension personnel on the economic circumstances around extension organization, the disabling legal environment as well as inappropriate technical resources available for public agricultural extension system.

Findings also revealed that administrative and geographical environments have gained a moderate satisfaction of extension personnel with percentages of 55% and 54%, respectively. This result indicates that these dimensions do not act as inhibitors or as catalysts for the extension organization, so some more efforts in these directions may improve the performance of extension organization.

Table 2. Means and percentages of extension workers’ perceptions of the organizational environment dimensions.

No	Dimensions of external environment	Max. score	Mean		Gap*	
			Score	%	Score	%
1	Socio-Cultural Environment	6	3.98	66.33	-2.02	-33.67
2	Political Environment	12	7.57	63.08	-4.43	-36.92
3	Administrative Environment	20	11.09	55.45	-8.91	-44.55
4	Geographical Environment	6	3.25	54.17	-2.75	-45.83
5	Technological Environment	10	5.19	51.9	-4.81	-48.1
6	Legal Environment	12	5.47	45.58	-6.53	-54.42
7	Economic Environment	12	4.51	37.58	-7.49	-62.42
	Overall external environment	78	41.05	52.63	-36.95	-47.37

Source: The study’s findings. \* gap score = mean score – maximum score.

The radar chart as shown in Figure 1 was used to illustrate the gap between maximum and mean scores of extension workers' perceptions of the studied scale components; this gap could be calculated by subtracting the maximum scores from the mean ones. It could be noticed that gap score have negative signs, indicating a value of reduction in the respondents' perceptions compared to the maximum scores of each component

The Figure also revealed that the component “socio-cultural environment” showed the lowest gap (33.7%), followed by “political environment” component with value of (37%). While the component “economic environment” received the highest gap value (62%), followed by component “legal environment” (54%), and component “technological environment” (48%).

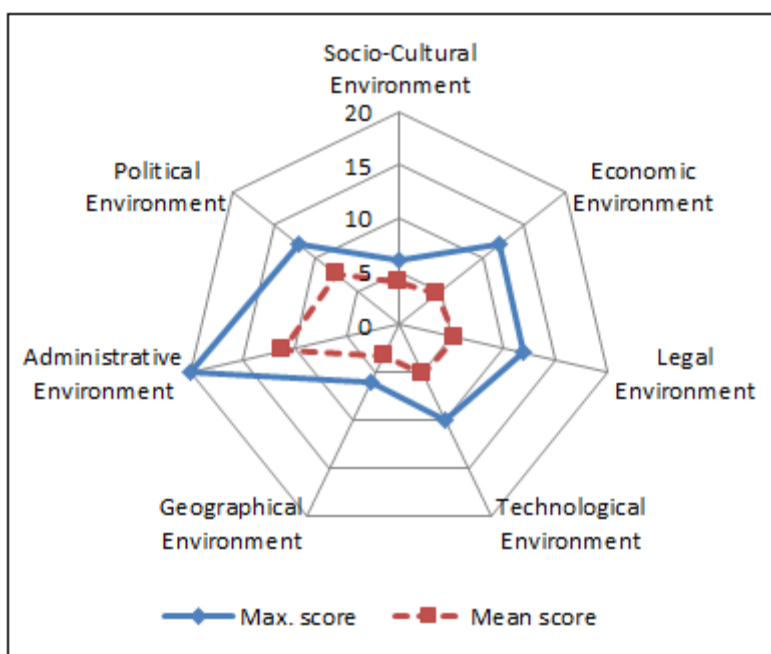


Figure 1: Radar chart displays of gaps of the external environment dimensions.  
Source: The study’s findings.



## **Conclusion**

This study highlighted the significance of recognizing extension workers' perception of the enabling environment for the national system of agricultural extension. It could be noticed that scores of administrative, political, and socio-cultural dimensions of organizational environment are above the overall average of scale while legal, economic and technological dimensions are under the overall average scores.

It could be concluded that there is high opportunity to support the organizational environment of extension system concerning all studied dimensions, much effort has to be done to reach an enabling environment for extension system. One of these efforts is policy-makers' faith on the importance of creating an enabling environment for agricultural extension through planned, purposeful and constructive vision.

Since, the government (The Minister of Agriculture, Director of the General Administration of Agricultural Extension, Director of the Department of Agricultural Extension) tend to achieve more enabling external environment for extension organization, bellow some suggestions to improve agricultural extension in Saudi Arabia: 1) Moving towards digitalization of agricultural extension system and utilization of ICTs services provision as well as extension management; 2) Establishing a flexible organizational structure to respond to changes and modern trends; 3) Availability of financial and human resources needed to support agricultural extension projects and plans; 4) Supporting public-private and local-international partnerships; and 5) Improving the efficiency of the institutional performance by applying quality assurance criteria in extension organization.

## **References**

- AbdelRahman, F. Y. and S. A. Majeed (2012). The physical work environment and its impact on improving the performance of employees: A survey study in the General Company for Electrical Industries. The magazine of Economics & Administration (91):184-204, (In Arabic).
- Al-Qahtani, M. D. (2015). Human Resources Management: Towards an Integrated Strategic Approach. 4th Edition, Obeikan Library, Riyadh, KSA, (In Arabic).
- Alsaghan, B. M. (2006). The reality of agricultural extension work in Riyadh and Qassim from the perspective of extension workers. MSc. thesis, College of Food and Agricultural Sciences, King Saud University, Riyadh, KSA, (In Arabic).
- Alsaghan, B. M. (2011). Evaluation of the performance of agricultural extension workers in some regions of the Kingdom of Saudi Arabia. PhD thesis, Cairo University, Egypt, (In Arabic).
- Alsaghan, B. M., A. M. Diab, and A. S. Alhotan (2017). Social network sites utilized in agricultural extension services in Kingdom of Saudi Arabia. AGROFOR International Journal 2(1): 19-27.
- Al-Shayaa, M. S.; M. B. Baig and G. S. Straquadine (2012) Agricultural extension in the kingdom of Saudi Arabia: difficult present and demanding future. The Journal of Animal & Plant Sciences, 22(1):239-246.
- Daft, R. L. (2010). Organization Theory and Design. Tenth Edition. South-Western, Cengage Learning, USA.
- Fabac, R. (2010). Complexity in organizations and environment – adaptive changes and adaptive decision-making. Interdisciplinary Description of Complex Systems, 8(1), 34-48.
- GASTAT (2016). The Statistical Yearbook. Fifty-two issue, The General Authority for Statistics, KSA.

- GFRAS (2017). Saudi Arabia: Major Institutions Providing Extension/Advisory Services. Global Forum for Rural Advisory Services. Accessed at: <http://www.g-fras.org/en/about-us/130-world-wide-extension-study/asia/western-asia/317-saudi-arabia.html#extension-providers>
- ICSI (2014). Business Environment and Entrepreneurship. Study Material, foundation program. Paper 1, The Institute of Company Secretaries of India, New Delhi.
- Kattookaran, T. P. (2015). Business Environment. Study material. School of Distance Education. University of Calicut. Available at: [http://www.universityofcalicut.info/SDE/I\\_M\\_Com\\_Business\\_Environment\\_on16March2016.pdf](http://www.universityofcalicut.info/SDE/I_M_Com_Business_Environment_on16March2016.pdf)
- Lusthaus, C.; M.H. Adrien; G. Anderson and F. Garden (1999). Enhancing Organizational Performance: A Toolbox for Self-assessment. International Development Research Centre, Canada.
- Ministry of Agriculture (2016) Annual report on achievements of the Ministry of Agriculture in 2016, KSA.
- Reino, A.; T. Kask and M. Vadi (2007). Organizational culture and environment: dynamics in dynamics. Case of Ordi. TRAMES, 11(61/56), 2: 24–138.

## **STATE AND PROSPECTS OF RURAL TOURISM DEVELOPMENT IN KOLUBARA DISTRICT (SERBIA)**

Dragan STEVANOVIC\*

Municipality Ljig, Tourist organization of the municipality Ljig, Serbia

\*Corresponding author: belipersin@gmail.com

### **Abstract**

The paper is based on a multifunctional model of agriculture, which in addition to manufacture of vegetable and livestock production, implies development of other complementary activities for the economic viability of rural households and their family farms.

The implementation of this model of agriculture on small family farms in Serbia, puts a special emphasis on rural tourism. The study analyzed Kolubara District, and six municipalities and their villages: Valjevo, Ub, Lajkovac, Mionica, Ljig and Osecina. The expected results of this work are the promotion of Kolubara District, as a new destination rural tourism at national, regional and European tourist market.

Taking into account the level of research for this study, the expected contribution would be to identify tourism products of Kolubara District and to identify tourist attractions and potential for rural tourism development. Kolubara District with natural resources its cultural and historical heritage of traditional architecture, cuisine, folk traditions, local crafts, native livestock breeds and plant varieties has the potential for development of rural tourism. The offer of the rural tourism in Kolubara District includes villages, ethnic villages, ethnic houses and events that give tourists an authentic experience of a rural environment.

Development of rural tourism in Kolubara District is directly connected with the income from tourist consumption because the purchase of additional products and special services outside of rural household, income can increase by 50 percent or more.

All municipalities in the Kolubara District have a strategy for the development of agriculture and tourism, which emphasize rural tourism as an important factor of mutual development. Their implementation would be applied in practice multifunctional model of agriculture and rural development, and rural tourism.

**Keywords:** *Rural tourism, tourist services market, promote, Kolubara district.*

### **Introduction**

Tourism in rural areas has become a reality, a need and a desire of tourists, but also a carrier and instrument for the development of rural areas (Koscak M., 1998). Rural capital includes various components of rural wealth. They can be natural (eg agricultural or forest populations), then infrastructure (eg built village settlements and other infrastructure facilities necessary for the life and work of residents and visitors and users of rural tourism services), or social, such as local cultural tradition, historical monuments, and more.

Serbia has great untapped potential for the development of rural tourism, due to the preserved nature, traditional architecture, local cuisine, folk customs, homemade crafts and indigenous breeds of cattle and plant varieties. Rural tourism in Serbia, as well as in other European countries, is a significant factor in the multifunctional development of agriculture and rural

areas in general - which "involve 85% of the territory of Serbia, with 55% of the population living in them and forming 41% of the country's GDP" (Bogdanov N., 2007 : 31).

Rural tourism in Serbia does not have a long tradition. The beginnings of the development of rural tourism in our country date from the 1970s, and the pioneers are the villages of Seca Reka (Kosjeric), Sirogojno (Cajetina) and others. Although Serbia has a diverse and attractive structure, it is not accompanied by an adequate profile of tourism products. Prior to the above mentioned period, rural tourism rarely appeared in the tourist offer of Serbia. Despite the initial offer 40 years ago, fragmented and dispersed peasantries, insufficiently developed awareness of the value of the environment, and primarily the focus on other forms of mass tourism (marine, urban, spa and mountain), have affected the poor development of rural tourism. The absence of Serbia from the international tourist market in general, and in particular the rural tourism market during the sanctions and other consequences of the disintegration of the former SFRJ, contributed to the absence of Serbia, so rural households as potential bidders remained unprepared and unorganized to form more serious offers to potential users of this type of tourist services.

Rural tourism in the wider context of the topic of this work includes not only a holiday in rural households, but also all other tourist activities in rural areas: tourist events dedicated to traditional agricultural production, participation in agricultural works and works in the household, brandy road, wine roads, sports -requirements (hiking trails, riding, cycling tours, paragliding, rafting, boating and kayaking, ...), hunting, fishing and photo safari, visits to natural, historical and cultural monuments, religious sites, harvesting and processing of forest fruits, medicinal and other wild plants, etc.

Table 1. Basic information about Kolubara District

Municipality	Area (in km <sup>2</sup> )	Population (Census 2011.)	Population density (inh./ km <sup>2</sup> )	Number of settlements	Number of households	Average household size
Valjevo	905	90312	100	73	30728	2,9
Ub	456	29101	64	38	9119	3,2
Lajkovac	186	15475	83	19	5050	3,1
Ljig	279	12754	46	27	4407	2,9
Mionica	329	14335	44	36	4577	3,1
Osecina	319	12536	39	20	4150	3,0
Kolubara District	2474	174513	62,67	213	58031	3,0

Source: Republican Bureau of Statistics, Belgrade

Kolubara District is located in the northwestern part of Serbia and covers a space of 2.474 km<sup>2</sup>, which represents 2.8% of the total area of the Republic of Serbia. The municipalities include Valjevo, Lajkovac, Ljig, Mionica, Osecina and Ub. In 213 settlements there are 174.513 inhabitants or 2% of the total population of the Republic of Serbia (Table 1). The seat of Kolubara Administrative District is the city of Valjevo. The municipalities of Mionica and Osecina from the area of the district belong to the group of underdeveloped areas of the Republic of Serbia.

The comparative advantages of the Kolubara District are: agricultural, mining, traffic and tourism potentials.

Natural conditions allow 80% of the surface of the district to be favorable for the development of livestock and fruit growing, and about 90% of the surface of the district is favorable for agriculture in general.

Natural potentials and ambient values combined with favorable tourist geographical position in relation to the sources of demand, are a good basis for the development of health and recreational (industry, health), mountain, rural, transit, eco, religious, hunting and fishing tourism.

Priority of the development of the Kolubara District economy is the activation of tourism potentials in already well-known tourist destinations, by raising the quality of the tourist offer (improvement of the off-site content), with the implementation of new projects.

### **Material and Methods**

The following methods of research were used in this paper:

- Historical method and method of content analysis are used in the study of archival material and other historical documents important for the consideration of the development of rural tourism, statistical data and for the research of results related to thematic in other countries;
- Cartographic method is also used to determine the state of rural tourism in the Kolubara District and for the comparison of Serbia and other countries, a comparative method is used;
- A method of interviewing is used to determine the situation in selected households that provide rural tourism services in the Kolubara District;
- In the formulation of attitudes about the tourist potentials and significance of individual rural areas, the assessment of the current development, the current situation and the indication of possibilities for further development of rural tourism in Kolubara District, the method of trivial conclusion is used.

### **Results and Discussion**

Rural tourism in the Kolubara District began to develop in the 1960s, and is associated with villages with tourist attractions, such as Brankovina, Valjevska Kamenica, Slavkovica, Belanovica, Struganik and others.

The beginnings of the organized development of rural tourism in Valjevo region and Kolubara District are related to the year 2000, when one enthusiast, according to the expert forestry engineer, Dragić Tomić, initiated an initiative and wrote a project entitled "If he is, I will." Tomic has very well understood the problem of thinking and functioning of a man in the village, especially when it comes to matters and material attitudes. Thanks to this project, Tomic succeeded in using this Serbian initiative in direction of healthy competition, in a way that the host will be convinced of the material and social benefits that his neighbor accomplishes in this activity. Of course, this is primarily meant for the fact that rural tourism is an activity that provides additional income for the provision of accommodation and food, but also additional services such as trips in nature, walking through the forest and surrounding areas, reading mushrooms and forest fruits, storing healthy food with the housekeeper in a traditional manner, keeping cattle grazing, etc.

The next step in the promotional activities was made by the members of the Internet club from Ljig in 2004, by launching the project "Development of rural tourism of Serbia" with the help of the funds of the Ministry of Agriculture, Forestry and Water Management at the then Ministry of Agriculture for the allocation of incentives for development of agriculture. The funds used were used for the visit of the households and the launch of the website [www.selo.co.rs](http://www.selo.co.rs).

The continuation of the development of rural tourism in the Valjevo region followed in 2005 when Tomić formed a non-governmental organization called the Association of Hosts „Valjevo“, with the main goal of improving rural life with a special emphasis on the development of rural tourism as one of the best ways to goal achieves. At the very beginning, a survey was conducted, that is, about a hundred rural households were interviewed, 60 of whom wished to engage in rural tourism. The survey wanted to determine what potentials were and how the general situation was related to households, number of members, capacities, etc (Stevanović D., 2012).

After this research it was established that there are good bases for the development of rural tourism in Valjevo region. Immediately started with the process of categorizing objects, but also educating the host about the proper engagement with this activity.

Analyzing the total accommodation capacities in Kolubara District, it can be concluded that 94 households in 56 villages are currently categorized for rural tourism, that there are available 250 rooms with 479 beds as well as 14 modern apartments.

It can also be seen that these are rural households who provide accommodation and meals as a form of supplementary activity, which provides additional income for the household. So these are households that mostly issue rooms within their houses or the whole floor, or the whole house. In this case, it would be desirable that hosts are housed in another house in the same courtyard, but this is not always the case.

But, this is also about the hosts who live and work in the city, while the village households are betrayed. Nutrition of tourists is provided by engagement of the nearest neighbor, or they are given a ready meal. This can not really be called true rural tourism, since there is no clearly defined host-to-host relationship, nor does it create an impression of the host's gallantry.

Accommodation capacities vary from household to household, although these are family houses where two, three or four generations live. The courtyards are classical countryside, with large lawns and plenty of flowers, and sometimes with which old object such as vajat<sup>48</sup> or dairy. In the vicinity there is an economic part with stables, hens, pigs, there are also gardens and orchards all in the function of food production, both for hosts and for guests.

However, there are outdated facades of houses, worn furniture, etc. which has to be restored. It is necessary to pay more attention to aesthetics, interior and exterior. This implies the use of old furniture, which often goes down somewhere in a basement, and whose restoration would return to its function, and in appearance would satisfy the ethno style. The use of any ethnic object is welcome in the form of a small garden exhibition, or for use when serving food (wooden bowls for cream and cheese).

When collecting data from official statistics, there were problems with the records of tourist traffic and overnight stays in the field of rural tourism. Namely, the Republican Bureau of Statistics does not have official data (such records are not kept), but they came through the Tourist Organization of Serbia (TOS), tourist organizations (TO), associations and others.

Observing the estimated data on the number of overnight stays in rural tourism received from the Association "Rural Tourism of Serbia", we can conclude that the participation of overnights of rural tourism in the Kolubara district in relation to the overnights of rural tourism in the Republic of Serbia in 2007 reached a maximum of 8,77%, when it started its constant decline to a minimum of 3,34% in 2010. In the observed period, this phenomenon can be characterized as a permanent development of rural tourism and an increase in the number of overnight stays in the Republic of Serbia, and on the other hand, the stagnation and decrease in the number of overnight stays in the Kolubara District since 2007. In support of this, the fact that the Kolubara District still does not have an adequate strategy for the

---

<sup>48</sup> Vajat - a small wooden house without windows in the yard.

development of rural tourism, but its development took place in a styche with an inadequate base of serious rural tourism households.

Table 2. Tourism turnover and share of rural tourism turnover in R. Serbia and Kolubara District

Year	Number of overnight stays in rural tourism in Serbia	Number of night. in rural tourism in the Kolubara District	Participation rates of rural tourism Kol. District overnight stays in rural tourism R. Serbia (in %)
2007.	131130*	11500*	8,77
2008.	177455*	11000*	6,20
2009.	220505*	12500*	5,67
2010.	284320*	9500*	3,34
2011.	241321*	11350*	4,70
2012.	279337*	10500*	3,76
2013.	265556*	9890*	3,72
2014.	220450*	8210*	3,72
2015.	291300*	12105*	4,16
2016.	271852*	11892*	4,37

\*Assessment - Data obtained from the Association "Rural Tourism of Serbia", Ljig, Karadjordjeva 7.

Regarding the turnover of tourists in rural tourism, official data are scarce and unreliable, mostly because this type of tourism is still in development. The biggest problem is the poor organization of the competent institutions, but a few people from the villages who irregularly report their guests.

Comparing the data of the non-governmental organization responsible for the development of rural tourism in the Kolubara District - "Village tourism of Serbia", it can be noted that, in 2016, 11892 nights were registered, in July and August, mostly in July and August they stay 3-5 days. Families with small children are usually on vacation or it is about older clients. It was also noted that in all villages there is not equally represented the visit, so most tourists go to the villages: Popucke, Brezovica, Bacevci (Podbukovi), Valjevska Kamenica, Milicinica, where they are households that have been serious for four, five and more years deal with this business, and which have made remarkable results in recent years.

It is necessary to point out, and according to the research in the territory of the Kolubara District, that in the period from 2007 there was a certain filtration and selection of rural tourist households who want to deal with this business seriously. These include those of agricultural holdings and ethno-households who have the necessary conditions and accommodation capacities in accordance with the requirements of tourists. However, there are also a group of registered, for various interest reasons, who cease to deal with and slowly gas, which can be understood as a legal phenomenon in this perspective branch of tourism, which should now be developed qualitatively and in line with market demands.

#### *Research of rural tourist households in Kolubara District*

The author conducted a survey of 19 owners of rural households and ethno-households on the territory of the Kolubara District. The rural households that were included in the survey are located in the municipalities of Valjevo, Ljig, Mionica and Osecina.

- A large number of facilities in rural tourism started operating between 2004 and 2009 (89%), while only 2 buildings (11%) started to work between 1985 and 2004;
- It was found that 17 facilities (89%) provide services throughout the year, while 2 facilities (11%) work either seasonally or by announcement.
- Most rural households employ 3-5 household members;
- Equal representation of agriculture and tourism as primary activities in the proportion of 50: 50 percent;
- 100% of households offer accommodation and meals;
- The most frequent activities during their stay in rural households are trips and walks in the environment (47%), and sports and recreational activities (26%);
- It was found that the largest number of respondents has area of 5-10 ha (37%), while at least those are up to 1 ha (10%);
- The most common cultivated crop is maize (53%), followed by wheat and leguminous plants (37%), while (26%) of the surveyed owners do not have arable land at all;
- The most common cultivated fruit crop is plum (95% of the respondents), second place is apple and pear tree (74%), third place raspberries (42%);
- The majority of owners (79%) are engaged in sheep farming, second place is poultry (74%), pig farming (68%), while the fourth place belongs to cattle breeding (58%);
- The tractor and all ground handling machines are 63%, 42% seedling and sprinkler, 37% tractor and cultivator, 21% motocultivator, and 16% of the hay baling machine.
- Most respondents have a passenger car (95%), a van has a 16%, a freight and off-road vehicle has 11%, while the delivery vehicle is only 5%.
- Production of cheese over 500 kg has 21%, up to 500 kg 16%, over 300 kg 21%, up to 100 kg 5%, and 37% of them do not produce cheese.
- The largest production of kajmak (cream speciality) up to 100 kg has 26%, up to 50 kg 21%, over 200 kg 11%, up to 200 kg kajmak produces 5%, the other 37% does not have this production;
- Over 100 liters of brandy are produced by 58% of the tested, from 50-100 liters 11%, to 50 liters 5%, while 26% do not produce brandy at all;
- Poor use of the Internet: only 26% of households have a web site and e-mail;
- The largest number of households sell their services on their own (63%), while through travel agencies it makes up 37%;
- Only 21% of rural households are included in a tourist arrangement;
- A relatively smaller number of households have their own prospect (32%), while at fairs they rarely perform independently;
- The cooperation with the tourist organization of the municipality and the host associations has the highest percentage of respondents 42%, while 16% of respondents do not cooperate with any tourist organization or association;
- 95% of tourists are of domestic origin;
- The average length of stay is 3-5 days.

#### *Research of tourist organizations in Kolubara District*

The survey questionnaire encompassed 5 tourist organizations in the Kolubara District. The survey was attended by employees in the following tourist organizations: Tourist Organization of the Municipality of Valjevo (by 2011. J.P. "Valjevo-turist"), Tourist Organization of Ljig Municipality, Tourist Organization of Mionica Municipality, Tourist Organization of Osecina Municipality and Tourist Organization of Lajkovac Municipality . The test was carried out individually.

It should be noted that the Municipality of Ub still has no established tourism organization.



- Most tourist organizations were established between 1994 and 2005;
- On average, rural tourism is in second place by importance and development in the observed municipalities;
- All surveyed tourist organizations have precise data, i.e. They know their accommodation capacities in rural tourism;
- Association of providers of rural tourism services exist in as many as 3 out of 4 surveyed municipalities that have rural tourism in development (75%);
- 50% of tourism organizations believe that rural tourism in their municipality is of local importance, while the other 50% say it is of regional importance;
- All tourism organizations that have rural tourism have their own website;
- The most common form of promotion of tourist organizations is the participation in fairs.

Regarding the limiting factors for the development of rural tourism in the municipalities of the Kolubara District, the main factor limiting the number of tourist organizations was the human factor, i.e. Poor interest and poor education of the local population to deal with this type of tourism. The second place is the lack of financial resources, then there is no legal basis for this type of tourism, i.e.

The incompatibility of the regulations on the registration of rural households and the lack of a development strategy in many municipalities. Some tourist organizations, as limiting factors, have also identified poor infrastructure, poor marketing and political factors.

As an advantage for the development of rural tourism in municipalities, favorable tourist-geographical position, natural environment, cultural heritage, healthy environment, good traffic connections, developed agricultural production are listed.

#### *The strategies for the development of agriculture and tourism in Kolubara District*

The strategies for the development of agriculture and tourism of municipalities in Kolubara District were made by eminent institutions in cooperation with local authorities and non-governmental organizations.

Strategies have their own form and form, but they propose activities of a general character, which should be concretized and clearly defined.

Almost all strategies involve rural tourism, but its ranking of development priorities is clearly not seen, and then it can be understood as a declarative item.

Except for some municipalities that have proposed concrete projects for the development of rural tourism, in others it is related to the overall rural development.

As local tourism products are weak and insufficiently attractive, the only way to increase visibility and attractiveness is the development of a regional, destination product, which will clearly profile and position the region.

### **Conclusion**

Previous development of rural tourism in the Kolubara District, despite numerous available resources, took place slowly, and has no long tradition.

The fact is that in this area, there are 94 households registered in the private accommodation that are registered to engage in tourism activity. These households now have 479 beds, which is certainly not a small number for some initial steps. Out of the above number of registered, only 20 are truly engaged in this activity. In preliminary research, it was found that almost 80% of categorized do not have adequate conditions for reception of guests and are still in the phase of re-examination whether they should start this job at all. The causes of these

phenomena are the following: lack of financial assistance, demographic factor, lack of promotion and cooperation with the TO, indecision and uncertainty of the host in gaining economic profit.

The possibilities for the development of rural tourism, which is the most frequent in the Kolubara District, will depend on three factors:

- The level of income that the household provides on the basis of agricultural production,
- Existence of tourist resources, and
- Accessibility by interested tourist regions.

The existence of appropriate resources for the development of tourism and traditions in the development of rural tourism in the Kolubara District is the basis for distinguishing two specific types of approaches related to the planning and management of tourism development, for:

- Rural areas with a tradition in the development of tourism,
- Rural areas with significant resources, but not enough tradition in tourism development.

Both of these types require different types of approaches and strategies, with the existence of a common methodology of planning and management.

All municipalities in the district have developed strategies for the development of agriculture and tourism, in which rural tourism is emphasized as an important factor of mutual development. Implementation of these Strategies will result in multifunctional development of agriculture and villages, and in this regard the development of rural tourism.

From the above it can be concluded that rural tourism in the Kolubara District has not been sufficiently developed and that the overall results of rural tourism development in Kolubara District can not be satisfied, since in the years of the economic crisis, conditionally speaking, it is partially in stagnation.

In order for the rural tourism of the Kolubara District to achieve sustainable development, it is very important that the progress of this activity fits into the development of Serbia's entire tourism. This implies competitiveness, improvement of the entire value system, ie adaptation and sustainability, with as few negative effects as possible. Assuming that economic, organizational and other conditions are gaining, with the willingness of the population to deal with this activity that is present in many villages and households, more intensive development of rural tourism could give multiple positive effects on the overall development of the villages in Kolubara District.

### **References**

- Bogdanov N. (2007): Small rural households in Serbia and rural non-agricultural Economy, UNDP and the Ministry of Agriculture, Forestry and Water Management, Belgrade. Census of Population, Households and Housing 2011, data by municipalities, RZS, Belgrade.
- Košćak M. (1998): Integral development of rural areas, tourism and village novation. Trebnje, Slovenia, Tourism Management, Vol. 19, No. 1 I, pp. 81-86.
- Stevanović D. (2012): The state and possibilities of development of rural tourism in the area of Kolubara district, master thesis, Faculty of Agriculture, University of Belgrade, Library Faculty.
- www. selo.rs (Accessed 20.03.2017); www. seoskiturizam.rs (Accessed 20.03.2017)

## FOOD LOSSES AND WASTE IN FRUITS AND VEGETABLE AGRI-FOOD CHAIN IN TURKEY<sup>49</sup>

Fatma Fusun ERDEN<sup>1\*</sup>, İlkey DELLAL<sup>1</sup>, Zeki BAYRAMOĞLU<sup>2</sup>

<sup>1</sup>Department of Agricultural Economics, Faculty of Agriculture, Ankara University, Ankara, Turkey

<sup>2</sup>Department of Agricultural Economics, Faculty of Agriculture, Selcuk University, Konya, Turkey

\*Corresponding author: fferden@ankara.edu.tr

### Abstract

Global food losses and waste has received much attention recently in the world. According to FAO, from almost 1/3 of food produced for human consumption approximately 1.3 billion tons per year is either lost or wasted globally. Reduction of food losses and waste (FLW) is presented as essential to improve food security and reduce the environmental footprint of food systems. The objective of the study is to assess FLW and critical loss points (CLPs) in the agri-food chain for fruits and vegetable in Turkey. When all fruits and vegetable types and varieties are considered, Turkey is one of the top 10 countries in the world. In this study, to determine FLW as well as CLPs along supply chains, in-depth interviews were done with key experts from the sector. In these interviews, semi-structured questionnaires were used and set five stages for losses emerging in agri-food chain as: 1.Agricultural production, 2.Postharvest handling and storage, 3.Processing and packaging, 4. Distribution, 5.Consumption. According to research results, FLW ratios along the agri-food chain respectively were determined as 20%, 8%, 10%, 10% and 5%. The highest rate of loss was observed in the agricultural production chain. The structural problems of Turkish agriculture such as small and fragmented farms, low cooperation level were the main causes of losses at this stage. Losses were mainly associated with farmers' traditional methods, habits and practices. Losses emerge from farmers' unwillingness to seek information related to agricultural production. Furthermore agricultural production was generally undertaken by elderly people since rural youth were willing to immigrate to urban areas and preferring to work in non- agricultural sector.

**Keywords:** *Food loss and waste, Agri-food chain, Fruits and vegetable, Turkey.*

### Introduction

This study is carried out to validate food losses and waste in fruits and vegetable agri-food chain which is one of the primary agri-food sub-sectors in Turkey. Fruits and vegetables are among the indispensable food groups of the nutrition of individuals. The various studies conducted to determine the eating behaviors of the individuals, were determined that vegetables were the second mostly consumed product group after cereal and cereal products (Köksal 1974, Scherz and Senser 1989, Arslan *et al* 2006, Pekcan 2009).

Turkey is one of the top 10 countries in fruit and vegetable production in the world. Tomato is the leading product in vegetable production and followed by green pepper and cucumber. Besides, Turkey ranks 4<sup>th</sup> in the world in tomato production with annual production of 11.9

---

<sup>49</sup> This paper is part of Turkish Country Report which was prepared on request from Food and Agriculture Organization(FAO) of United Nations in 2013.

million tons (FAO 2017) and mainly consumed in the domestic market; only 2% of the vegetable production is exported (Keskin and Gun 2004).

The leading regions of Turkey in vegetable production are the Mediterranean, Aegean, Marmara and Black Sea regions. While Aegean region leads the list in terms of area under vegetable production, yield per unit of land is the highest in the Mediterranean region since quite widespread greenhouse production in that region (Anonymous 2012a). In terms of foreign trade, Turkey is a net exporter of vegetables. As in production, in exports to the first place belongs to tomato (50%), followed by dry onion (24%), cucumber (8%) and green pepper (7%). Tomato are consumed both as fresh and also as processed (tomato paste, tomato juice, tomato puree, sun dried tomatoes) (Anonymous 2012b).

Food loss and waste is one of the policy issues in recent years and getting much more attentions of public and researches. Some of the studies estimated that as much as half of all food grown is lost or wasted before and after it reaches the consumer (Lundqvist et al 2008). According to FAO, from almost 1/3 of food produced for human consumption approximately 1.3 billion tons per year is either lost or wasted globally. Reduction of food losses and waste (FLW) is presented as essential to improve food security and to reduce the environmental footprint of food systems (FAO 2012). Such estimates are difficult to scrutinize but highlight the need for greater resource efficiencies in the global FSC (Parfitt et al 2010). Although it is an important issue, there are still few studies on food loss and waste measurement and assessment in research area (Rolle 2006, Morgan 2009, FAO 2011, FUSIONS 2016).

The objective of this study is to provide an overview of food loss and waste in fruits and vegetables in Turkey with a particular focus on tomato food chain. Also, critical loss points in the chain were identified and analysed.

### **Material and Methods**

The paper is based on secondary data and primary data. The sources of secondary data used were from the FAOSTAT Food and Balance Sheet, Turkish Statistics Institute (TURKSTAT), and various reports prepared by the public and private sector as well as related NGOs. The primary data was collected by interviews with key experts in tomato and products (tomato paste, tomato mash, etc). In this study, the methodology developed by the FAO and Swedish Institute for Food and Biotechnology was used (FAO 2011, Erden et al 2013). The eleven experts from Ministry of Food, Agriculture and Livestock, Turkish Chamber of Agriculture, fresh fruits and vegetable farmers and processors, wholesalers, grocers were visited and contacted by phone and e-mail. The semi-structured questionnaires were used in the interviews. In these questionnaires, loss ratios in food supply chain were considered in the context of five stages. These are: 1. Agricultural production, 2. Postharvest handling and storage, 3. Processing and packaging, 4. Distribution and 5. Consumption. Food loss and waste ratios and Critical Loss Point (CLP)s along the food supply chain were identified on the basis of discussions with key experts.

### **Results and Discussion**

In order to analyze FLW as well as CLP for tomato and tomato products, firstly supply chain were determined. Wholesalers have an important role in the marketing of fresh vegetables and fruits. Processed amounts in industry vary from year to year and have been around 2 million ton (15-20% of total production) recently. Export, though, is rather low as a quarter million ton (Keskin et al 2009). Sales in domestic market are mostly performed by wholesalers and persons called trader-wholesaler. The domestic trade in vegetables is

characterised by the (long) length of the marketing channel, the highly perishable nature of vegetables, being a product ready to eat, and the inefficiency of producer unions.

Big supermarkets have entered the marketing channel for fresh vegetables and fruits in recent years. They generally work together with a broker in wholesale markets and products are purchased directly without entering the market physically. The share of supermarket chains in fresh vegetable and fruit marketing is not known but is increasing..

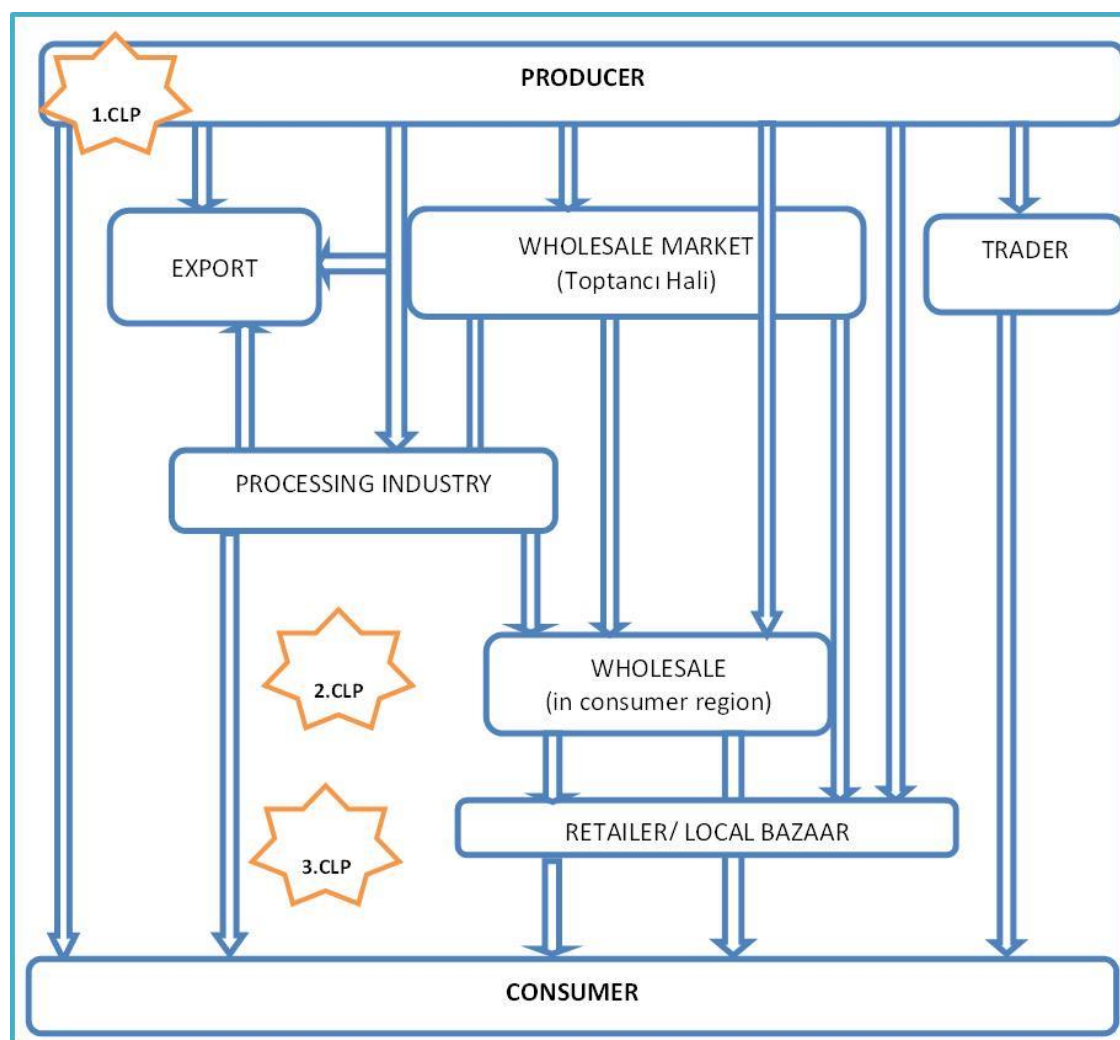


Figure 1. Tomato supply chain in Turkey and CLPs (Erden et al 2013).

As a result of study; the agricultural production stage of the food supply chain has the highest losses of all stages. Tomatoes have the greatest loss ratio as 20% in agricultural production stage since their perishable structure. The loss ratio in the post-harvest handling and storage stage of the food chains is 8%.

The processing and packaging stage of the tomato supply chain, loss ratio was determined as 10%. The reason of high loss ratio in tomato processing and packaging are improper work while loading and dumping, keeping the production in improper conditions, improper storage conditions, absence of a clean and sterile environment, insufficient ventilation and cooling systems, absence of pre-cooling after loading, absence of a sterile environment and failure in packing and sizing of tomatoes.

At the distribution stage, losses are estimated as 10% because of uninformed transportation practices, keeping the produce in unfavourable conditions, delays in reaching the consumer

and failure in selecting good packing materials. At the consumption stage, waste ratio was determined as 5%.

Reasons of FLW in different stage are given Table 1. In tomato, the leading cause of losses at production stage is climatic conditions. Such events as extremely high temperature and wind in field cropping and hail in the case of greenhouse farming cause losses. In extremely high temperatures damage takes place in the form water loss and defoliation while same conditions after ripening lead to sun burns. Other causes of loss at this stage include diseases and pests harming roots, trunk, leaves and fruit. Together with these, there are also losses emerging from various other factors including untimely harvest, harvesting by inexperienced persons, use of inappropriate harvesting methods, use of transportation cases which are worn out and having collected tomato to remain for a long time under sun.

Table 1:Reasons of FLW in different stages

<b>Step in FSC</b>	<b>Reasons of FLW</b>
<b>1.Agricultural production</b>	Too early or too late harvesting, Using incorrect harvesting methods Uninformed practices during harvesting
<b>2.Postharvest handling and storage</b>	Using low quality and insufficient cases while carrying, Leaving the produce under sun for too long time after harvesting, Delays in transportation
<b>3.Processing and packaging</b>	Improper work while loading and dumping Keeping the produce in improper conditions Improper storage Absence of a clean and sterile environment Insufficient ventilation and cooling Absence of pre-cooling after loading Absence of a sterile environment Failure in packing and sizing
<b>4.Distribution</b>	Uninformed transportation practices Keeping the produce in unfavourable conditions Delays in reaching the consumer Failure in selecting good packing materials
<b>5.Consumption</b>	Delays in consuming Wrong storing (absence of refrigerator) Damage to produce while carrying

Source: Erden F.F., Dellal, İ., Bayramoğlu, Z. 2013.

After harvesting and till the reach of wholesale market, transportation process is also marked with some causes of loss as produce getting damaged during loading and dumping, letting the produce remain in unsuitable places and unclean cases that may infect the produce and long periods of storage.

In the processing stage, losses can be classified as follows: Processing: bad practices during loading and dumping; storing in unfavourable conditions; wrong maturation practices and absence of sterile environments; packing: selection of rotten and damaged pieces; poor ventilation and cooling, absence of pre-cooling after loading; wrong packing and sizing practices and failure in selecting proper packing materials.

At the distribution stage, untidy work during transportation, undue delays and unsuitable conditions in transportation vehicles are the main case of losses.

At the consumption stage, delays in consuming, wrong storage, damage during carrying are the reason of waste of tomatoes.

### **Conclusions**

Food is wasted throughout the FSC, from initial agricultural production to the final household consumption. The biggest loss is occurred in the first step which is agricultural production for fruits and vegetables FSC of Turkey. Hence measures could be taken from the first chain to reducing losses during agricultural production. Some measures to elaborate the losses can be listed for fruits & vegetables production as follows:

- proper preparation of soil,
- correct selection of the type of seed,
- promotion of the use of certificated seed,
- informed and timely combat against diseases and pests,
- building awareness among farmers,
- training of persons involved in harvesting,
- training farmers about production techniques,
- development and implementation of early warning systems,
- use of advanced technology machinery in harvesting.

At other stages of FSC the following may be adopted to reduce losses:

- informing farmers/truck drivers about transportation requirements and training workers involved in loading and dumping operations
- informing and training farmers, drivers, workers
- selecting materials used in transporting harvested production (sacks, cases etc) so as not to allow any compromise in terms of product quality and quantity
- being tidy on storage conditions and informing farmers about what is necessary for keeping storages clean and hygienic
- informing and training consumers about conserving ways and using food
- informing consumers by public spots on food use, conservation and recycling
- regular maintenance and keep up of machinery and equipment
- responding to need for trained personnel
- creating a labelling system to cover information at all stages from farm to table
- operating and control of feedback monitoring systems and mechanisms
- using cold chain channels at all stages.

### **References**

- Anonymous 2012a, TURSTAT, Agricultural production data, <http://tuikapp.tuik.gov.tr/bitkiselapp/bitkisel.zul>
- Anonymous, 2012b, “Sectoral Report of Fruits and Vegetables”, Ministry of Economy, <http://www.ibp.gov.tr/pg/sektorpdf/tarim/tazemeyvesebze.pdf>
- Arslan P, Mercanlıgil S, Özal HG, Akbulut G.Ç, Dönmez N, Çiftçi H, Keleş İ, Onat A, 2006. ”General Nutrition Patterns and Nutrition Habits” Journal of Turkish Cardiology Association:34(6):331-33
- FAO 2011, Global Food Losses and Food Waste- Extent, Causes and Prevention, Rome, Italy.

- FAO 2012. Save Food: Global Initiative on Food Losses and Waste Reduction, Rome, Italy.
- FAO 2017, FAO Statistics Division <http://www.fao.org/faostat/en/#data/QC>
- FUSIONS 2016. Estimates of European Food Waste Levels, Brussels, Belgium, European Union. <http://www.eu-fusions.org>
- Keskin, G., Gül, U., 2004. Tomatoes, AERI Views, Agricultural Economics Research Institute Publications, No: 5, April 2004, Ankara
- Koksal O. 1974. “A Report of 1974-National Nutrition, Health and Food Consumption Survey”, Hacettepe University, Ankara.
- Lundqvist, J., de Fraiture, C. Molden, D. 2008. Saving water: from field to fork- curbing losses and watages in the food chain. In SIWI Policy Brief. Stockholm, Sweden: SIWI.
- Morgan, E. 2009. Fruit and vegetable consumption and waste in Australia, Victoria, Australia: State Government of Victoria, Victorian Health Promotion Foundation.
- Parfitt, J., BArthel, M., Macnaughton, S. 2010. Food waste within food supply chains: quantification and potential for change to 2050. *Phil. Trans. R.Soc. B* (2010) 365, 3065-3081
- Pekcan G.2009, “Nutrition and Health Status in Turkey”, Hacettepe Nutrition and Dietetic Days, II: Postgraduate Training Course”, Ankara.
- Rolle, R.S. (ed.) 2006 Improving postharvest management and marketing in the Asia-Pacific region: issues and challenges trends in the fruit and vegetable sector. Tokyo, Japan: FAO, Asian Productivity Organization (APO).
- Scherz, H. And Senser, F., 1989. Food Composition and Nutrition Tables, Wissenschaftliche Verlagsgesellschaft mbH, Postfach 40, D-7000 Stuttgart 1, Printed Germany.
- Erden, F.F., Dellal, İ., Bayramoğlu, Z. 2013. Food Loss and Waste of Turkey, FAO Country Report. [http://www.fao.org/fileadmin/user\\_upload/Europe/documents/Publications/FLW/Turkey\\_en.pdf](http://www.fao.org/fileadmin/user_upload/Europe/documents/Publications/FLW/Turkey_en.pdf)



## **GOVERNMENT'S INTERVENTIONAL TRAINING IMPACT ON FARMERS COMPETITIVENESS**

Vlada VITUNSKIENĖ, Edvardas MAKŠECKAS\*

Institute of Economics, Accounting and Finance, Aleksandras Stulginskis University. Universiteto str. 10, Akademija, Kaunas distr., Lithuania

\*Corresponding author: edvardas.makseckas@gmail.com

### **Abstract**

The agricultural sector, in most cases is supported in developed countries and one of the support measures (government interventions) is training of the sector's actors. The research is carried out to determine the training as a research object for competitiveness theories, analyze the impact of these interventions to farmers' competitiveness and its reflection in indicators that farmers' competitiveness is described with. The research is based on the counterfactual impact evaluation method, scientific literature as well as data from year 2008 and 2012 Lithuanian government's interventional farmers training, linked with respondent's data provided by Farm Accountancy Data Network. During the research, eligibility for counterfactual impact evaluation method was confirmed, similarity criteria of farms were developed, according these criteria, nearest neighbor matching performed and impact detected. Research shows that trainings as a government intervention affect competitiveness of farmers and how these effects can be measured. Trainings can be a governmental instrument to foster farmers' development.

**Keywords:** *competitiveness, intervention, training, agriculture.*

### **Introduction**

This paper analyzes how the informal training influences competitiveness of the agricultural sector. In scientific literature researchers answering to the questions what are the sources of competitiveness, how the governments can influence the competitiveness developments; how efficient different government interventions on resources (financial, capital and human) are; what determines the behavior of economic entities; can training influence behavior and competitiveness; whether training can cause changes in competitiveness. In researches training effects often seen through the prism of satisfying the expectations of learners. There is a lack of objective evaluation of training effectiveness. Studies usually are based on interviews, surveys, lacking of tools for connecting trainings with farms development indicators.

Competitiveness (farm, industry, country) consists of many components and is influenced by many factors. The company can be acknowledged competitive when its impact on the market certain share changes. However, there is no universal competitiveness acquisition and retention techniques. R. Jasinavičius (2011) linked competitiveness as opportunity to fight against competitors with the ability to produce and sell products, withstand competitive pressure, by increasing the return on (inputs) used resources. According to the authors A. Griffiths and F. R. Zammuto (2005), the company's competitiveness - the ability to manage their own resources, such as finance, personnel, technology, marketing, production, knowledge, resulting full potential. Productivity and efficiency are often seen as a factor in

competitiveness, it is the most reliable indicator of long-term competitive advantage (European Commission (EC), 2011).

L.Latruffe in agricultural competitiveness study, states that the training effect is definitely positive, because better educated farm managers have the skills to effectively manage farms (L.Latruffe, 2010). Agricultural market participants' training should be encouraged by the state, G.Boyle notes that the absence of these public goods, the private sector would provide them enough or do not provide it at all (G.Boyle, 2002).

While evaluating support measures, it is important to determine whether the benefits remain in the business for which it is awarded. It is thought that the benefits can be expressed in profit. There is no doubt that the support can increase revenues, but also on the support may increase and entrepreneurs (farmers) the costs and benefits can also support redistribution to other market participants. It was found that production subsidies and investment support of gain (excluding it received production subsidies) are very weak, but the average gain (subsidies) are marked. This suggests that both production subsidies and investment helps to cover the costs and affect the return, but the real benefit of these support measures for farmers do not receive.

Training has its price. These can be tuition fees, time, opportunity cost. It can be emotional costs, because returning "back to school" can be traumatic. Some farmers will not be willing to accept discipline, attending evening classes after a day of physical activity and the time to work through the exercises. In addition to the emotional and disciplinary matters, the decision to initiate service training covers economic issues. You need to assess the costs and compared with a profit of better governance (Nuthal, 2010).

Training is used as a public market interventions. This is evidenced also in the OECD producer support calculation manual, because training in the agricultural sector financed from the budget counts as support for the sector (OECD, 2011).

Governments intension to increase farmers' competitiveness in comparison with other forms of support, is most useful to support the dissemination of knowledge, because this support payback most, of all kinds of the support (in comparison with other forms of support: investment support and production support (subsidies), which are aimed directly at farmers) . Support for the effective dissemination of knowledge, also has negative characteristics. First, higher administrative costs than other instruments. Second, the fictitious support risk, which is because of low tangibility (Jasinskas, 2012).

## **Material and Methods**

Scientific literature discusses a variety of methods, for non-formal education of farmers impact assessment. Focus group studies are carried out, training effects evaluated using indicators and data, by econometric tools. The training is a governmental intervention, so to assess its effects, the same methods and methodologies can be adapted as well as for other interventions (eg. capital interventions, etc.).

Lithuanian rural development programs are developed in accordance with the corresponding period of the European Council, the European Commission regulation of the rural development strategic guidelines, which are transferred to the corresponding period of Lithuanian national rural development strategy. Rural development programs and are designed to implement this strategy.

The strategy provides activities aimed at strengthening human resources in rural areas, thus addressing the limited opportunities, lack of education and lack of information. It is expected that the implementation of measures under this priority for people engaged in agriculture, forestry and rural development will not only strengthen the agricultural, food and forestry sectors, but also to create alternative sources of income in rural areas, improve the

environment condition (by increasing people's awareness and knowledge), so will goals of the other - II, III and IV - measures (DG AGRI, 2004, 2006).

Evaluation of rural development programs requires types of indicators as a contribution rates in relation to the budget or other resources allocated at each level of the assistance (e.g. the declared costs incurred in the implementation of the measure); capacity indicators to measure the direct implementation of the program actions (eg. training sessions organized, number of farms receiving investment support, total amount of investment); result indicators, which measure the direct effects of the intervention. From them you can learn about, (e.g., the direct beneficiaries of behavior, capacity or performance changes). They are measured in physical or monetary units (e.g. investment implementation, training successfully completed the number of farmers). Impact indicators related to the program's benefits, both at the level, but also more generally in the program area. Impact indicators linked to the wider objectives of the program (e.g. more jobs in rural areas, increased productivity of agricultural sector, increased production of renewable energy).

As used herein, counterfactual impact assessment method enables evaluate governmental intervention impact, excluding other factors (e.g., macroeconomic situation, foreign investment) effects. In other words, this approach responds to the question "Does the intervention work?" And "What are the effects?". It compares two situations: the implementation of public policy and its failure to implement the measure. It measures what happened to intervention experienced operators and compares this situation with a hypothetical situation in which they are to themselves, if intervention is not implemented. The net impact of the intervention shows the difference between the real situation and what would have been "situation.

At present, use of EU support for impact measurement indicators is a major drawback - they measure not only specific intervention, but also other factors influence the final result. Counterfactual impact assessment method eliminates the influence of other factors, and thus "purifies" the impact of the intervention and provides more accurate exposure readings. Although even if method has important advantages, it is important to emphasize that it cannot answer the question "Why did the intervention works or does not work?". (EC, 2009).

The net effect of intervention in this study is determined as follows:

The net effect of the intervention in the target group = difference before and after the implementation of the policy - the difference in the control group before and after the implementation of the policy.

In ideal case, the most important target group members and control characteristics should be identical, they should only differ by the presence intervention fact. When preparing the target and control groups, it is important to assess whether the intervention in question experienced operators could be exposed to other interventions. When preparing the target group, it is often assumed that all subjects experienced the same impact of the intervention. However, some entities may participate in intensive intervention, while others - not so intense. This determines the intervention and sustained impact strength.

The target and control groups can be made up of different interventions seasoned. The control group and target group subjects important to choose, so they both observable and invisible properties were as similar as possible (EC, 2011).

Table1. Intervention of farmers informal training suitability for counterfactual impact evaluation

Necessary condition	Feature that allows to say that the impact of the intervention can be applied to determine	Feature that allows saying that farmers training intervention satisfies the condition
Intervention leads to behavioral change	Possible to identify clear criteria to determine whether a change in the target group entities behavior	Competitiveness indicators change in farms that experienced intervention.
Intervention is homogeneous	Entities involved in the same or similar activities, which are based on the same causal chain	All trainees are farmers keeping agricultural holding registered in Lithuanian agricultural and rural business register
Intervention is repeatable	The intervention can be re-implemented in the future.	Farmers' training regularly conducted and funded by the Rural Development Program
Interventions involved a sufficient number of subjects	At least 100 subjects participated in intervention	Analyzed training had about 20 000 participants
Suitable impact analysis variables (indicators)	Impact analysis variables are closely related to measures of intervention logic and to supported activities	The training aims to increase the competitiveness of farms. Impact analysis of selected variables reflecting changes in farm competitiveness
Directly comparable target group and control group	A clear difference between the target and the control group (strong indicator of whether the entity has suffered the impact of the intervention or not). Integrated interventions monitoring system, especially if the target group or the control subjects experienced the impact of other interventions.	It is possible accurately identify farmers participated in training
Monitoring and administrative data availability	Sufficient and available administrative data (or data can be collected by surveys) needed to set up the target and control groups (additional analysis variables) and calculate the net impact of the intervention (impact analysis variables)	Training and FADN data availability and entanglement

\*Source: Gertler et al., 2011

### Results and Discussion

Farmers continuing vocational training as an intensive intervention was carried out in three stages in the implementation of Community Special pre-accession to the European Union Agriculture and Rural Development (SAPARD) in 2000-2006., under the Single Programming Document (SPD) 2004-2008 Priority IV and for the period 2007-2013. Rural Development Plan (RDP). During the research, it was selected around 20 thousand farmers that have been participating in trainings during period 2009-2010. Next step was to identify which of the participants are respondents of Farm accountancy data network (FADN) after the intervention at year 2012. It was around 200 of such farmers identified. Last step, from these farmers around 100 selected, control and target groups were formed.

Table 2. Analyzed farm characteristics

Farm features		The structure of the target respondents (%)	The structure of the control respondents (%)
Farming type	Crop	33	30
	Mixed	67	70
Utilized agricultural area	below 250 ha	75	73
	251–1000 ha	19	22
	above 1000 ha	6	5
Staff employed	Yes	81	86
	No	19	24
According to the hours worked in agriculture	below 3000	20	19
	3001-6000	73	71
	above 6000	7	10
According to the soil fertility score	below 33	8	11
	34 – 43	71	68
	Above 43	21	21

While selecting farms and forming control and target group, each farm was described by 192 features from FADN forms (EC, 2010). In order to carry out the grouping of farms nearest neighbor matching according 5 similarity criteria was performed. The similarity criteria were agricultural area / soil fertility score, own land part as percentage, arable land part as percentage, total labor costs, number of animal units.

According nearest neighbor matching method, for each individual farm, according to all similarity criteria, nearest similar farm selected by algorithm:

$$C (P_i ) = \min_j \| P_i - P_j \|$$

Where C (Pi) - the distance between the similarity of the estimate P (propensities score) between farms, i and j (Thoemmes, 2012)

While matching for a particular farm is found in only one match among the remaining farms data. The biggest disadvantage that method does not ensure compliance with the wrong case when the closest neighbor of the control group is relatively far away from the target group.

3 Table. Detected intervention effects

Variable	Measurement units	Type of group	Value before intervention Year 2008	Value after intervention Year 2012	Intervention effect
Labor productivity	Litas*/hour	control group	23,7	20,0	10,5
		target group	29,0	35,8	
Land productivity	Litas*/hectare	control group	4468,0	4538,0	366,0
		target group	2090,0	2526,0	
Margin'	Cost vs income with subsidies	control group	1,01	0,91	-0,03
		target group	1,07	0,94	
Margin''	Cost vs income without subsidies	control group	1,19	1,14	-0,13
		target group	1,41	1,23	

\*- 1 euro is equal to 3,4528 litas

## Conclusions

Over time the sources of competitiveness as well as the concept has changed, but the concept of competitiveness and competitive sources are still relevant research object. Competitiveness is a relative measure. Companies, countries need to be compared with each other. Production in absolute terms for a particular country or industry, is meaningless. If two players have

reduced the costs of production that does not mean that either of them to increase their competitiveness, increase competitiveness occurs when an entity reduces its costs compared to those faced by competitors. In assessing competitiveness in order to obtain a more detailed assessment should include several elements or indexes, but the question remains open how to evaluate the weight of each component. Assessing the competitiveness of the sector is necessary to take into account the state support, this is especially the case in the agricultural sector. Competitive advantages can be created or encouraged to change the behavior of market actors. This is particularly inconceivable without government intervention.

The most important aspect of competitiveness assessment, modeling and management is that the higher the level of competition does not necessarily correlate with the welfare or other social indicators. Investment in human capital is not less important than investment in physical capital. Their aim is to increase productivity. Human resources are one of the factors of competitiveness, training changes the quality of these resources, so the effect can be, should be and are analyzed. Most of the competitiveness index as an indicator in the training and education system. Some indices even emit continuous training as a separate criterion or factor of competitiveness. Competitiveness change can be informal continuing vocational training effect. Acquisition of data research, and in particular the primary data collection and compliance is a challenge for researchers.

### **References**

- Boyle, G. (2002) “The Competitiveness of Irish Agriculture”, Department of Economics, National University of Ireland, Maynooth, Co. Kildare, Ireland.
- Directorate General for Agriculture and Rural Development, (2006), „Rural Development 2007-2013 / Handbook on Common Monitoring and Evaluation Framework (Guidance document)“, Brussels, DG Agri.
- EC Directorate-General for Agriculture and Rural Development, (2004), „Evaluation of Measures Applicable to Agriculture“, Brussels, DG Agri.
- European Commission (2011), European Competitiveness Report 2010, European Commission, Brussels.
- European Commission, (2009), „Choosing Evaluation Methods, Responsibilities and Allocating Resources“, EVALSED: The resource for the evaluation of socioeconomic development.
- European Commission, (2010), „Farm Accounting Data Network. An A to Z of methodology“.
- European Commission, (2011), „Monitoring and Evaluation of European Cohesion Policy – European Regional Development Fund and Cohesion Fund – Concepts and Recommendations“, Draft Guidance Document.
- Gertler, Paul J., Sebastian Martinez, Patrick Premand, Laura B. Rawlings, Christel M. J. Vermeersch, (2011), „Impact Evaluation in Practice“, Washington: The World Bank, [https://siteresources.worldbank.org/EXT/HDOFFICE/Resources/5485726-1295455628620/Impact\\_Evaluation\\_in\\_Practice.pdf](https://siteresources.worldbank.org/EXT/HDOFFICE/Resources/5485726-1295455628620/Impact_Evaluation_in_Practice.pdf)
- Jasnavičius R., Jasinavičius N., (2011) “Strengthening enterprise competitiveness by synchronizing supply chain”, Business: Theory and Practice/Verslas: Teorija ir Praktika 12.4.
- Jasinskas, E. (2012), “Valstybės paramos įtaka ūkininkų ūkių plėtrai”. Vilniaus universitetas.
- Latruffe, L. (2010), “Competitiveness, Productivity and Efficiency in the Agricultural and Agri-Food Sectors”, OECD Food, Agriculture and Fisheries Working Papers, No. 30, OECD Publishing.

OECD, (2016), “OECD’S producer support estimate and related indicators of agricultural support (the PSE manual)”, <http://www.oecd.org/tad/agricultural-policies/full%20text.pdf>

Thoemmes, F. (2012) “Propensity score matching in SPSS.”, arXiv preprint arXiv:1201.6385.

## **RISK ASSESSMENT IN AGRICULTURE: PROBLEMS AND PERSPECTIVES**

Laura GIRDŽIŪTĖ

Faculty of Economics and Management, Aleksandras Stulginskis University, Lithuania

\*Corresponding author: girlau@gmail.com

### **Abstract**

Agriculture is an economic sector facing large risk, mainly from natural factors and despite of relatively low price responsiveness to supply and demand causes output volatility in general. It is a risky business, and risk assessment and management tools have become increasingly important in recent years. Risk assessment and management is a complex process, since the risk arises from different sources. Due to different risk sources, it is important to consider such factors: seasonality, agricultural products are perishable; variability in prices of raw materials and a long production cycle; climate changes; agriculture is impacted by environmental protection restrictions; fluctuations in agricultural produce demand, supply and prices; high transportation prices lead to an increase in product prices, which entails higher economic risk; climatic conditions; animals and plant welfare, and etc. Typically, scientific literature analyses only one type of risk. As a result of the research, financial, business, credit, and currency risk models were created and adapted to the various countries conditions (mostly in banking sector). Meanwhile risk in agriculture should be analysed as holistic phenomenon, that is affected by different source of risks (economic, political, financial, human, production). It should be noted, that there is a lack of research related to agricultural activities and their specific features. Risk assessment in agriculture is relevant on both the theoretical and practical level, so it is important to identify main risk factors in agriculture, to investigate their evaluation models/methods, to distinguish their advantages and disadvantages for farmers.

**Keywords:** agriculture risk, risk assessment, risk factors.

### **Introduction**

Risk makes an inseparable part of every business and agribusiness is not an exception. However, the display of risks in the agricultural sector has a certain specificity which is associated with dependence upon climatic conditions and work with biological assets. Scientists indicate the following factors predetermining the specificity of agriculture:

- seasonality (Harangus, 2008; Brain, 2010);
- agriculture is impacted by environmental protection restrictions (Brain, 2010);
- climate changes (Harangus, 2008);
- agricultural products are perishable (Harangus, 2008);
- high transportation prices lead to an increase in product prices, which entails higher economic risk (Brain, 2010; Harangus, 2016);
- variability in prices of raw materials and a long production cycle (Brain, 2010);
- fluctuations in agricultural produce demand, supply and prices (Harangus, 2008).

Typically, scientific literature analyses only one type of risk. As a result of the research, financial, business, credit, and currency risk models were created and adapted to the various countries conditions (mostly in banking sector). Meanwhile risk in agriculture should be analysed as holistic phenomenon, that is affected by different source of risks (economic,



political, financial, production). It should be noted, that there is a lack of research related to agricultural activities and their specific features. Risk assessment in agriculture is relevant on both the theoretical and practical level, so it is important to identify main risk factors in agriculture, to investigate their evaluation models/methods, to distinguish their advantages and disadvantages for farmers.

### **Material and Methods**

The paper is based on general scientific research methods of generalization and comparative analysis. The analysed literature included publications in economics, management, and other areas. Data analysis was conducted using FADN database, research period 2004-2015 year. Analysed countries are 28 Europe Union countries.

### **Results and Discussion**

The completed systematic analysis of scientific literature on agricultural risks suggests that in the last sixteen years various researchers addressed issues related to risk assessment in agriculture. In foreign scientific works, considerable attention to agricultural risk analysis was given by H. L. Pfleeger (2000), A. A. Batabyal, H. Beladi (2001), J. B. Hardaker, R. B. M. Huirne, J. R. Anderson, G. Lien (2004), P. Chitakornkijasil (2009), H. Qi, A. Y. Xie, Sh. Liu (2010), Lipinska, I (2016), D. Kong et al. (2008), B. J. Barnett, K. H. Coble (2009), J. A. Lopez (2008), M. P. M. Meuwissen, J. B. Hardaker, R. B. M. Huirne, A. A. Dijkhuizen (2001), T. Vermeire et al. (2007), P. Slovic (2001), R. A. Unks, L. Thor (2008), M. Hagigi, K. Sivakumar (2009), L. Kapustka, K. Froese, R. McCormic (2010), etc. Those works mostly 1) analyse the manifestation of different risk types in agriculture and 2) identify agricultural risks. However they do not aggregate the risk types in agriculture, do not offer a comprehensive classification of agricultural risk factors, do not merge those aspects in a systematic agricultural risk approach neither seek an integrated assessment of different risk types.

In scientific papers, the problems of integrated risk assessment are checked by means of empiric research: 1) integrated assessment deals with two types of risk in the banking sector (Tanaka, Muromachi, 2003; Iscoe, Kreinin, Rosen, 1999; Medova, Smith, 2005; Dimakos et al., 2004) and due to the specific features of this sector, the research results can be useful for the banking sector only; 2) integrated assessment aims to measure factors of one risk type arising from different sources (Greiving, Fleischhauer, Ckenkotter, 2006; Bechmann, 2009) and the application of integrated assessment is limited to natural risks.

Analysing risk in agriculture, it is important to determine what is risk. Risk as a process is also interpreted in two different ways: 1) risk as a probability (Clark, Maroi, 1996; Hardaker, Huirne, Anderson, Lien, 2004; Cindyniques, Antipolis, 2008; Rainey, 2002); 2) risk as an adverse effect (Vaughan, 1997; Rejda, 2008; Laskienè, 2004).

This paper offers a concept of risk in agriculture, which says that risk in agriculture represents a potential adverse effect on risk subjects (country groups, countries, farms), which stems from different controlled and uncontrolled risk factors and which is related to agricultural activities of risk subjects. In view of the broad typological diversity of risks in agriculture, the agricultural risk concept includes different types of risk in agricultural activities.

Most popular risk fragmentation in scientific literature is following: economic, political, financial and production risk. It is important to point out that scientific literature analyses the agricultural risk types at different aspects: economic and political risks are analysed as uncontrolled risk; production, financial are analysed as controlled risk.

In this article one of the production risk factors is natural condition. Agribusinesses can not control the natural conditions and climate change. Therefore, based on these conditions they may take appropriate management decisions, i.e. agricultural activities diversification, use of insurance services, change the nature of their activity and the like. Main agriculture risk types and their factors are identified if figure 1. Only by knowing main risk factors it is possible to find best way to evaluate and manage risk in agriculture.

Agriculture is unique sector because its production is related to biological asset and agribusiness success directly depends on climate conditions, so farmers it is very important to evaluate and manage agriculture risk on time.

The main problem for evaluating risk in agriculture is it's complexity, for example, in order to evaluate politic and economic risk you need strong background in macroeconomics, in tax policy, in political regulations, environmental law. In order to make some mathematical predictions decision maker has to have knowledge how to adapt deferent econometrics models for example Monte-Carlo Simulation, Variation-Covariation Method, Cost-to-Benefit Analysis (CBA), Fuzzy matrix (Rasche, 2001; Laskienė, 2003; Ahmed, Kays, Amornsawadwatana, 2007; Bandyopadhyay, Myktyyn, 1999; Bagliano, Favero, 1998; Dimitrakopoulos, Kavussanos, Spyrou, 2010). Adaptation of these models requires specific knowledge that is not common for most of businessman.

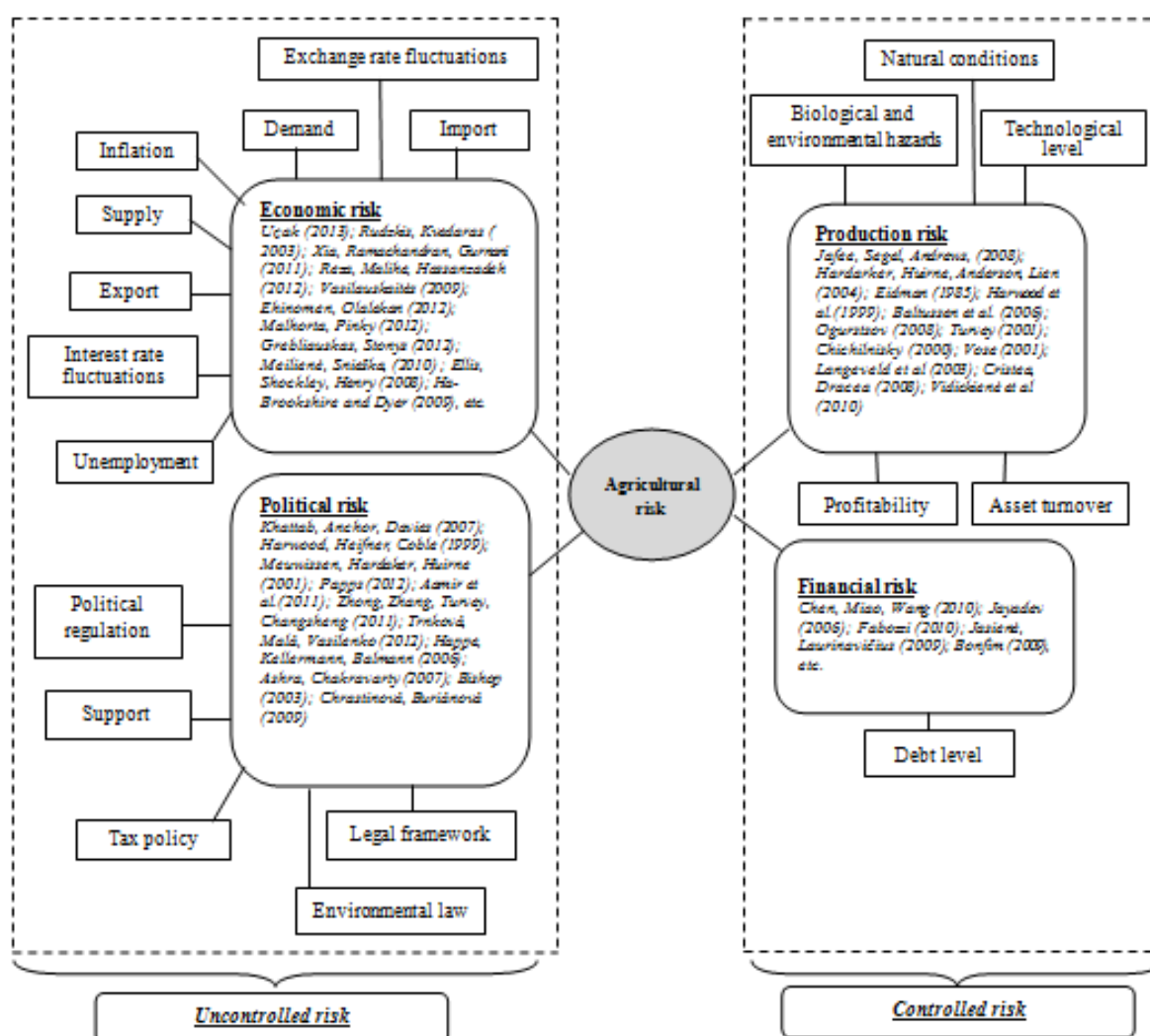


Figure 1. Agricultural risk and it's main factors (made by the author)

Meanwhile analysing production risk it is huge uncertainty concerning biological and environmental hazard. All these arguments shows that in agribusiness have a great need for agriculture risk assessment model. In order to check is this problem is only theoretical or practical as well, the income and expenses ratio has been calculated for 28 European union countries. Data was taken from FADN database, research period 2004-2015 year, target group – agribusiness. As mostly risk conception is related to negative aspects, such us profit loss, so the income and expenses ratio fluctuation can show problems in agribusiness.

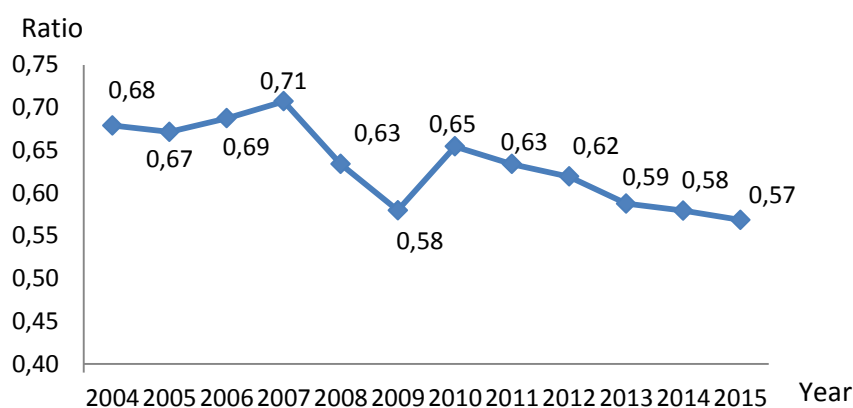


Figure 2. The income and expenses ratio of EU agribusiness during period 2004-2015 (made by the author)

As it is seen from figure 2 there is constant ratio luck from 2010 year. That there were problems in agribusiness production and finance risk management. From 2011 year scientist paid more attention to risk evaluation and management in agriculture. Few integrated risk assessment models were created.

Table 1. Research into integrated assessment of agricultural risks (made by the author)

Researchers	Research	Methods	Weaknesses
R. Toledo, A. Engler, V. Ahumada (2011)	An integrated risk assessment algorithm for specific regions in Chile	hierarchical holographic method; expert evaluation	The calculations rely only on expert evaluation; No assessment of internal (unsystematic) risks
X. Su, Z. Zhao, H. Zhang, Z. Li, Y. Deng (2011)	An integrated agricultural risk assessment model for integrated assessment in one farm	hierarchical holographic method; fuzzy matrix; risk matrix	The calculations rely on a subjective opinion of the decision-maker in both defining the most dangerous risk factors and identifying their scope and likelihood
L. Girdžiūtė (2013)	An integrated risk assessment index for Lithuanian Farm	Factor and reliability analysis	Calculations are difficult, require huge data spectrum and special knowledge for processing information.

\*Source> Results based on author`s elaboration

As it is seen in table 1, the created integrated risk assessment models are characterized by certain limitations. As agriculture risk is unique and complicated phenomena it`s evaluation requires specific knowledge, huge data spectrum or some restrictions based on subjective opinion. Scientific literature review has showed that there is lack of scientific models for integrated risk assessment for agriculture risk.

## **Conclusions**

Risk in agriculture is complex and unique phenomena. It can be dialysed into two main categories: uncontrolled risk (economic, political risks) and controlled risk (production, financial risks). In order to evaluate risk it is important to understand it's primary sources or factors. From theoretical perspective, they were found to be:

- production risk: natural conditions, which include weather conditions and natural hazards, the technological level, and biological and environmental hazards;
- economic risks: export, unemployment level, import, exchange rate fluctuations, gross domestic product (GDP), interest rates, supply, demand, taxes;
- financial risks: debt level and borrowing power, i.e. ability to get a loan;
- political risks: taxes, subsidies, legal framework, and environmental requirements.

The above risk types are interrelated. The production risk is related to political and economic risks. Government decisions on business regulation, for instance subsidies and grants, affect the decisions of agribusiness entities regarding preferred product types. In the production process agribusiness entities must also take into account safety requirements, which means that they must guarantee environmental and product safety. Market demand also affects production decisions and constitutes a part of the economic risk. Political events, in their own turn, affect the government policy and the national economy, i.e. they can influence the currency exchange, price regulation or taxation policies. The level of the financial risk depends on the economic and political situation in a country and the interest rates.

There were several attempts to create risk assessments models for agriculture, biggest limitations of these methods is that it is very difficult to use them for small farmers, because adaptation of these methods require specific econometrics knowledge. If we analyse these models in wider context, for detailed agriculture risk analysis it is lack of statistical data, that's limits research itself. From social point of view there is demand for agriculture risk assessment models that be adaptable for farmers and can be used for daily decision making in farms.

## **References**

- Ahmed, A.; Kays, B.; Amornsawadwatana, S. (2007). A review of techniques for risk management in projects. *An International Journal*, vol. 14, no.1, p. 22-36.
- Bagliano, F.C; Favero, C.A. (1998). Measuring monetary policy with VAR models: An evaluation. *European Economic Review*, no.42, p. 1069-1112.
- Bandyopadhyay, K.; Mykytyn, P.; Mykytyn, K. (1999). A framework for integrated risk management in information technology. *ManagementDecision*, no.37/5, p. 437-444.
- Barnett, B.J.; Coble, K.H. (2009). Are Our Agricultural Risk Management Tools. Adequate for a New Era? *Choices*, no.24, p. 36-39.
- Batabyal, A.A.; Beladi, H. (2001). Aspects of the theory of financial risk management for natural disasters. *Applied Mathematics Letters*, vol. 14, no.7, p. 875-880.
- Bechmann, M. (2009). Integrated tool for risk assessment in agricultural management of soil erosion and losses of phosphorus and nitrogen. *Science of the Total Environment*, Vol. 407, no.2, p. 749-759.
- Brain, M. (2010), "Predisposition to Risk Farming", *Internal Auditing & Risk Management*, Vol. 3, No 19, pp.43-46.
- Chitakornkijasil, P.(2009). Managing Risk: How to Manage What We Do Not Know. *International Journal of Organization Innovation*, vol. 1, no.4, p. 58-73.
- Cindyniques, P.; Antipolis, S. (2008). Risk + barriers = safety? *Safety Science*, t. 46, p. 221-229.

- Clark, E.; Maroi, B. Managing (1996). Risk in International Business. London: International Thompson Business Press, p. 278-311.
- Dimakos, X.K. et al. (2004). Integrated risk modeling. *Statistical Modelling*, no.4, p.265-277.
- Dimitrakopoulos, D.; Kavussanos, G.M.; Spyrou, S.I. (2010). Value at Risk models for Volatile Emerging Markets Equity Portfolios. *The Quarterly Review of Economics and Finance*, no.50, p.515-526.
- Harangus, D. (2008). "Credit Risk For Agricultural Farms", *Horticulture*, Vol. 65, No 2, pp.181-185.
- Harangus, D. (2016). Credit risk in agriculture. *Management Agricol*. Vol. 18 Issue 2, p. 213-218.
- Greiving, S.; Fleischhauer, M.; Ckenkotter, J. (2006). A Methodology for an Integrated Risk Assessment of Spatially Relevant Hazards. *Journal of Environmental Planning and Management*, vol. 49, no.1, p.1-19.
- Girdžiūtė, L. (2013). Integrated Risk Assessment In Agriculture. Doctor dissertation. Akademija.
- Hagigi, M.; Sivakumar, K. (2009). Managing diverse risks: An integrative framework. *Journal of International Management*, vol. 15, no.3, p. 286-295.
- Hardaker, J. B., Huirne, R.B.M.; Anderson, J.R.; Lien, G. (2004). *Coping with risk in agriculture*. CABI Publishing, 2nd ed, p. 1-22.
- Iscoc, I.; Kreinin, A.; Rosen, D. (1999). An integrated market and credit risk portfolio model. *Algo Res*, no.2(3), p. 21-37.
- Kapustka, L.; Froese, K.; McCormic, R. (2010). Revisiting the Rationale for Holistic, Integrated Risk Assessments. *Integrated Environmental Assessment and Management*, vol. 6, no.4, p. 774-776.
- Kong, D. et al. (2008). Assessment of Credit Risk in Project Finance. *Journal of Construction engineering and management*. November.
- Laskienė, D.; Snieška, V. (2003). Verslo rizikos valdymo esminiai bruožai ir organizacinė struktūra. *Tiltai*, t.1. p. 250-255.
- Laskienė, D. (2004). Verslo rizikos valdymo modelis: daktaro disertacija. Kaunas, p. 1-119.
- Lopez, J.A. (2008). What Is Liquidity Risk? *FRBSF Economic Letter*, no.24, p. 1-4.
- Medova, E.A.; Smith, R.G. (2005). A framework to measure integrated risk. *Quantitative Finance*, vol. 5, no.1, p.105-121.
- Meuwissen, M.P.M.; Hardaker, J.B.; Huirne, R.B.M.; Dijkhuizen, A. A. (2001). Sharing Risk in Agriculture: Principles and Empirical Results. *Netherlands Journal of Agriculture Science*, no.49, p. 343-356.
- Pfleeger, Sh. L. (2000). Risky business: what we have yet to learn about risk management. *Journal of Systems and Software*, vol. 53, no.3, p.265-273.
- Qi, H.; Xie, A.Y.; Liu, SH. (2010). Credit Risk Models: an Analysis of Default Correlation. *The International Journal of Business and Finance Research*, vol. 4, no.1, p. 37-49.
- Rainey, R. (2002). Risk Management: Overview of CORE Analysis. University of Arkansas Cooperative Extension Service Printing Services, p. 2-4.
- Rasche, T. (2001). Risk Analysis Methods – a Brief Review. The University of Queensland. Mineral Industry Safety and Health Center (MISHC). p. 6-14.
- Rejda, G. E. (2008). *Principles of Risk Management and Insurance*. 10<sup>th</sup> Edition. Boston: Pearson. p. 748.
- Slovic, P. (2001). Psychological study of human judgment: Implications for investment decision making. *The Journal of Psychology and Financial Markets*, no.2, p.160-172.
- Su, X.; Zhao, Z.; Zhang, H.; Li, Z.; Deng, Y. (2011). An Integrative Assessment of Risk in Agriculture System. *Journal of Computational Information Systems*, , no.7, p. 9-16.

- Tanaka, S.; Muromachi, Y. (2003). An integrative risk evaluation model for market risk and credit risk. Maastricht: International AFIR Colloquium. p. 4-22.
- Toledo, R.; Angler, A.; Ahumada, V. (2011). Evaluation of Risk Factors in Agriculture: An Application of the Analytical Hierarchica; process (AHP) Methodology. Chilean Journal of Agricultural Research, no.71 (1), p. 114-121.
- Unks, R.A.; Thor, L. (2008) The Maricopa Integrated Risk Assessment Project: A New Way of Looking at Risk. Community College Journal of Research and Practice, no.32, p.904-906.
- Vaughan, E. J. (1997). Risk Management. Chicago: John Willey & Sons. p. 2-25.
- Vermeire, T. et al. (2007). An Assessment of Integrated Risk Assessment. Human and Ecological Risk Assessment, no. 13, p. 339-354.

## **DAIRY PRODUCTION IN POMORAVLJE REGION, SERBIA**

Jasmina FILIPOVIC<sup>1</sup>, Sladjan STANKOVIC<sup>2\*</sup>, Radmila BESKOROVAJNI<sup>2</sup>, Natasa TOLIMIR<sup>2</sup>, Nikola POPOVIC<sup>2</sup>, Bratislav PESIC<sup>3</sup>, Vladimir JOVANOVIC<sup>4</sup>

<sup>1</sup>Agricultural Advisory Service of Jagodina, Jagodina, Serbia

<sup>2</sup>Institute for Science Application in Agriculture, Belgrade, Serbia

<sup>3</sup>College of Agriculture and Food Production, Prokuplje, Serbia

<sup>4</sup>NIRAS SR d.o.o., Belgrade, Serbia

\*Corresponding author: sstankovic@ipn.bg.ac.rs

### **Abstract**

Dairy production does not directly depend on climate and other natural factors. Its specificity is that it depends on a number of other factors. Gross margin of dairy production, depends not only on simple products produced volumes of milk and the price, but also includes other elements such as the amount of milk that is consumed in the household, for calves aged up to 10 days, the manure, the premium for milk as the amount of incentives for quality breeding cows (subsidies). This means that the value of production, in addition to the quantity and quality of milk affect the prices of all the elements involved, which are largely determined by measures of economic policy and producers have no influence. The quantity and quality of milk is mostly affected by the quality of food, but also reproductive cycle in cows, fertility and mortality. Data for gross margin (GM) calculations were collected through a questionnaire from dairy production farms in Pomoravlje region (period 2011-2014). GM was calculated as the total value of a production line subtracted by the direct costs for the production line in question. Milk yield per cow is a parameter that has minor fluctuations in the observed period, which shows little variation coefficient of only 4.76%. The average milk yield per cow was 5,626 liters per year and has a tendency to slight increase at the rate of 0.22% per annum. The price of milk is also as the yield, stable and given the negligible value of the rate of change, of only 0.05%, could be said to be at a constant level. It was present slightly higher fluctuations of yield and price ( $Cv = 13.93\%$ ), and slightly more pronounced increase at an average annual rate of 0.76%. The average value of gross margin amounted in the reporting period to about 636 EUR/cow. Gross margin is also characterized by significant fluctuations because the value of the coefficient of variation in this parameter is much higher than in milk yields, prices and variable costs ( $Cv = 33.75\%$ ). GM in the production of cow's milk is characterized by the tendency to decrease by an average of 0.64% per annum. Observed variations in GM have been confirmed by the results of t-test. The maximum value of the GM was in the initial year of monitoring (2011), and this value is significantly different from the value in the control year, 2015, when we have recorded much lower value. On the other hand a significant difference compared to the control one has realized the value of the GM in 2014, which is the lowest value of the monitoring period.

**Keywords:** *gross margin, dairy, milk, variable costs, yield, price.*

### **Introduction**

The production of cow's milk in Serbia regards close to 156,000 farms, which according to the total number of 456,000 throats give an average of 2.9 dairy cows per farm. In the structure of agricultural holdings dealing with the production of cow milk, 95% are family farms and other legal entities and entrepreneurs. For ten years or more, in parallel with the

decline in the number of agricultural holdings that dealt with cattle breeding and quenching of large cattle farms and systems due to transition, all in 2013, a decline in the total number of cattle and therefore cows. Livestock farming has significance for rural development, as 80% of farms are engaged in at least one kind of livestock production. In 2014, compared to 2013, the number of dairy cows increased by 2.2% after a long period, along with the increase in the total number of cattle. Simmental cattle breed (meat-milk) is mainly represented in central Serbia and in the Pomoravlje region.

The biggest problems of livestock production in the cow's milk production segment are low milk yields on the throat in relation to other countries and poor quality of milk. Adequate measures of the agrarian policy of the state, as well as acquiring new knowledge by the producers and interest in the association of these, would significantly contribute to the improvement of the production of cow's milk and dairy products in Serbia. Milk production in farms is accompanied by numerous problems, low purchase prices of milk, constant increase in input prices, lower production capacities with outdated facilities and equipment (Radojković et al., 2009).

Household management analysis is essential. It helps farmers to understand how the farm functions, and to determine its profitability. The gross margin is an indicator of the profitability of agricultural holdings and production lines. It is obtained by subtracting variable costs from gross income. It can be used to analyse the impact of existing farms and assess the profitability of proposed new production lines. Gross margins became widespread in the United Kingdom in the 1960s and were first used by farm management advisers for analysis and planning (Barnard and Nik, 1979). The aim of this work is to estimate gross margin as an instrument for assessing milk yield in the region of Pomoravlje.

### **Materials and Methods**

In addition to standard descriptive statistical methods, the authors used gross margins as an indicator of the economic effects of the milk production. In order to determine the effects of milk production in agriculture through the calculation of the gross margin of milk production, a survey was carried out over a five-year period in the territory of the Pomoravlje District, where the production line of milk was monitored by agricultural advisors from the Serbian Agriculture Advisory Service (PSSS) in Jagodina, to a total of 66 households/farms; 15 farms in 2011, 15 farms in 2012, 18 households in 2013, 17 holdings in 2014, and 1 farm in 2015. The basic factors on which the gross margin depends are: yield (volume of production), selling price of products and variable costs. Based on the value of the gross margin, the present and future economic position of the farm is assessed, as well as the economics and profitability (Haluška and Rimac, 2005). Basic elements for gross margin calculation were used: yield and price; quantity and value of fertilizers, pesticides, and fuel, as well as costs of contracted services. All prices are given in EUR, but original data were collected in Serbian dinars (RSD). Prices were calculated based on Serbian National Bank average exchange rate against major world currencies for particular year ([www.nbs.rs/internet/cirilica/scripts/kl\\_prosecni.html](http://www.nbs.rs/internet/cirilica/scripts/kl_prosecni.html)). Indicators of the value of production, total variable costs and gross margin were calculated according to the methodology provided by the website of the Serbian Agriculture Advisory Service ([www.psss.rs](http://www.psss.rs)). For data processing and GM calculating, we used *Microsoft Excel*. The program was set to calculate the average value of each element of the calculation.



## Results and Discussion

Serbia is a country, which, as well as for plant production, has excellent conditions for livestock production, even when it comes to natural conditions - climate, soil, wealth in animal feed, water and other.

The average milk yield per cow was 5.626 liters per year and has a tendency of a slight increase of 0.22% per annum. Production of cow's milk in 2014 increased by 2.8% compared to 2013. The average price in the analyzed period was 35 din / l. The average value of gross margin was ca. 634.58 euros/cow, in the observed period. The gross margin is characterized by a significant oscillation because the value of the variation coefficient for this parameter ( $C_v = 33.75\%$ ) is more than that of yield of milk, prices and variable costs.

The gross margin in the production of cow's milk is also characteristic of the fact that in this production there is a tendency to reduce the gross margin, on average of 0.64% a year.

Table 1. Basic indicators of the dairy production parameters in the period 2011-2015.

Production parameters	Average value	Variation interval		Coefficient of variation (%)	The rate of change (%)
		Min.	Max.		
Yield (l/cow/year)	5.626	5.050	6.200	4.76	0.22
Price (Euro/l)	0.31	29	0.26	9.23	0.05
Total Variable Costs (Euro/cow)	1841.10	142.064	1252.11	13.93	0.76
Gross Margin (Euro/cow)	634.93	22.093	194.72	33.75	-0.64

All observed factors have a statistically significant impact on the change in the gross margin, with variable costs having the greatest relative impact. Milk yield (Beta values) has the smallest relative impact on the gross margin.

The absolute impact of the observed factors, expressed by the regression coefficients, shows that if the milk yield increases by one litre, the gross margin will be higher by 0.38 euros/cow/day. Increase in the price of milk by 0.881 euro cents/litre, will result in an increase in the gross margin of 45.16 euros / cow.

The observed oscillations in gross margin values were also confirmed by the results of the t-test (Table 2).

Table 2. T-test of gross margin values.

Year		Average value first year	Average value second year	t- quotient (value)	p- value
2011	2015	827.53	588.43	2.70747*	0.017006
2012	2015	667.36	588.43	0.48902	0.632399
2013	2015	724.32	588.43	1.14001	0.270091
2014	2015	827.53	588.43	-2.37276*	0.030528

\*  $p < 0.05$ , significant difference between the calculated values

## **Conclusion**

The observed change in gross margin in all households shows a slight decline of 0.6% annually. Unlike crop production, cattle breeding, or more precisely, cow's milk production does not directly depend on climate and other natural factors. Its specificity is that it depends on a number of other factors. Variable costs in the production of cow's milk, whose increase results in a reduction in the gross margin, also include a greater number of elements, of which the largest percentage (over 90%) of the amount of the necessary means for feeding cows (e.g. hay and concentrated feed). The survey shows that milk yield per cow on all observed farms increased from 2011 to 2015 at a rate of 0.22% per year.

## **References**

- Barnard, C. S. & Nix, J. S. (1979). *Farm Planning and Control*. Cambridge University Press, Cambridge.
- Haluška, J. & Rimac, D. (2005). Analiza troškova proizvodnje mlijeka / Analysis of milk production costs/. *Stočarstvo* 59(3): 203-223.
- Kulhman, P., Shannon, D. & Casement, D. (2012). *Farm gross margin and enterprise planning guide*. Rural Solutions, Government of South Australia.
- Popis poljoprivrede (2012)., *Statistički godišnjak /Statistical Yearbook/*, Republički Zavod za statistiku 2015.
- Popović, R. (2014). *Stočarstvo u Republici Srbiji /Animal husbandry in the Republic of Serbia/*. Republički Zavod za statistiku, Novi Sad.
- Radivojević, D., Ivanović, S., Topisirović, G., Božić, S. (2009). Utvrđivanje parametara za ocenu ekonomske efikasnosti porodičnih farmi muznih krava / Determination of parameters for assessing the economic efficiency of farmed dairy farms/. *Poljoprivredna tehnika, Godina XXXIV, broj 4, decembar 2009, Beograd*, pp. 121 – 130.
- Republički Zavod za statistiku (2014). *Izveštaj o stanju u poljoprivredi u 2014. godini, knjiga II /Report on the state of agriculture in 2014, book II/*. Ministarstvo poljoprivrede i zaštite životne sredine Republike Srbije,.

## ECONOMIC PARAMETERS OF SOUR CHERRY PRODUCTION IN POMORAVLJE REGION, SERBIA

Jasmina FILIPOVIC<sup>1</sup>, Sladjan STANKOVIC<sup>2\*</sup>, Dragan RAHOVIC<sup>2</sup>, Ivana BAKIC<sup>2</sup>, Robert RADISIC<sup>2</sup>, Vedran TOMIC<sup>2</sup>

<sup>1</sup>Agricultural Advisory Service of Jagodina, Jagodina, Serbia

<sup>2</sup>Institute for Science Application in Agriculture, Belgrade, Serbia

\*Corresponding author: sstankovic@ipn.bg.ac.rs

### Abstract

Sour cherry, after plums and apples, holds third place in Serbia in terms of volume and area of production. Serbia, within the CEFTA countries, is the largest exporter of sour cherries (approx. 4.4% of total exports of fruit in Serbia). Farmers need to be introduced to the economic effect of a sour cherry production and gross margin (GM). GM is a quick and efficient indicator for comparing production lines in different conditions and it was used as an indicator of economic effects of production. Data for GM calculations were collected through a questionnaire from sour cherry production farm in Pomoravlje region in the period 2011-2014. For calculating the basic elements of gross margin, the following data were used: data on yield and price, by-product price, quantity and value of fertilizers, pesticides, and fuel, and costs for contracted services. GM represents the total value of a production line subtracted by the direct costs for the production line in question (purchased inputs). Price of sour cherry shows considerable variability during the observation period ( $Cv= 54.95\%$ ). The average price of sour cherries in the reporting period was approx. EUR 530/t, while the maximum price recorded was almost twice higher (1,016 EUR/t). In contrast to the yield, price showed significantly more pronounced tendency to increase - an average annual rate of 9.72%. The average value of total variable costs was approx. 1406 EUR/ha. A positive feature of variable costs of the sour cherry production is that they show a tendency to decrease, with an average annual rate of 2.64%. The average value of gross margin in the observed period amounted to approximately 4013 EUR/ha. The value of rate of change shows that the gross margin year on year growth records an average of 11.71% annually.

**Keywords:** *gross margin, sour cherry, variable costs, yield, price.*

### Introduction

After plum and apples, sour cherry holds the third place in Serbia on the basis of land area and production. The areas under the sour cherries in Serbia in 2010 amounted to close to 15,000 hectares, from which the area was reduced to about 14 000 hectares, which has been a constant area under these plants for three years. Total yields in 2014 were 22.4% lower than in 2013. Average yields vary, regardless of the constant area, and in 2014 they were 33.7% lower than in 2013. The average cherry yield in the observed period is 7.76 t/ha in Serbia.

The purchase of sour cherries is mainly focused on refrigerating and exports. Sour cherry is also used in processing as frozen, for juices and other canned products. The least is used for consuming and selling on the market. In 2014, the purchase of cherries was lower by 25% than in 2013, and 91.6% was used for processing from the total quantity purchased.

The average producer prices for sour cherries are the lowest in relation to all European countries (except Bulgaria and Macedonia). Within CEFTA countries, Serbia is the largest exporter of sour cherries, and even within the EU countries, only Poland, Bulgaria and

Hungary export more than Serbia. Sour cherry participates in about 4.4% of total fruit exports in Serbia. In 2014 the largest quantities of cherries are exported to Germany, Russia, France, then to Austria, the Netherlands and Italy.

Significant improvements in the production of sour cherries could be achieved by intensifying production and selecting the appropriate market, as well as selecting the appropriate land and applying adequate agro-technology.

The region of Sumadija and Western Serbia, in relation to Serbia, has an area of 17% under sour cherry. The area in the region has been growing for three years. The total yields vary from year to year, and the average yield in the observed period is 7.84 t/ha and is slightly higher than the average yield in Serbia (7.76 t/ha).

Gross margin (GM) was used in this paper as an indicator narrower than an analytic calculation and it shows the difference between the cost of production and direct costs, which makes it an important tool from the economic aspect (Barnard and Nix, 1979; Anđelić et al., 2010; Stanković et al., 2015; Filipović et al., 2015). We used the methodology for calculation of a standard GM as a scientific tool to support technical and economic orientation of farms, in order to analyze economic results in fruit production.

### **Materials and Methods**

Data on sour cherry production were collected from a questionnaire survey conducted on a representative farm in Pomoravlje region during the period 2012–2014. GM calculations, as a standard descriptive statistic method, were used as an indicator of economic effects of sour cherry production. Basic elements for gross margin calculation were used: yield and price; quantity and value of fertilizers, pesticides, and fuel, as well as costs of contracted services. Original data were collected in Serbian dinars (RSD), but all prices are given in EUR. Prices were calculated based on Serbian National Bank average exchange rate against major world currencies for particular year ([www.nbs.rs/internet/cirilica/scripts/kl\\_prosecni.html](http://www.nbs.rs/internet/cirilica/scripts/kl_prosecni.html)). Indicators of the value of production, total variable costs and gross margin were calculated according to the methodology provided by the website of the Serbian Agriculture Advisory Service ([www.psss.rs](http://www.psss.rs)). We used *Microsoft Excel* for data processing and GM calculating; The program was set to calculate the average value of each element of the calculation. GM is the difference of total income and total variable costs (TVC), achieved in a line of agricultural production per unit of production area (in crop production). We also calculated the critical values (Stanković et al., 2015, Filipović et al., 2016) with the aim of estimating results of production under conditions of uncertainty. Critical values are those values at which the GM equates to zero.

### **Results and Discussion**

Values of basic statistical indicators of sour cherry production parameters in farms, monitored by the advisory service in the period 2011–2015 are shown in Table 1. The average yield of sour cherry was 11.2 t/ha, ranging from minimum 7 to maximum 15 t/ha. For sour cherry yield, it can be noticed that it shows oscillations during the analyzed period. The rate of change in value is negligible and amounts to only 0.06% per year.

The price of sour cherry shows significant variability during the observed period ( $C_v = 54.95\%$ ). The average price of sour cherries in the analyzed period was close to 528.82 euro/t, while the maximum price recorded was almost twice as high as 1,013.57 euros/t. The price, unlike yield, shows a significantly more pronounced tendency of growth, which is an average annual rate of 9.72%.

The average value of total variable costs in the analyzed period was at about 1402.26 euros/ha. The positive characteristic of variable costs in cherries is that they show a tendency to decrease, on average annually at the rate of 2.64%.

The average value of the gross margin in the analyzed period amounted to about 4000 euros/ha. The value of the change rate shows that the gross margin grows annually on an average of 11.71%.

For efficient cost management and decision-making, GM is adequate analytical basis. In addition for such analysis advisors requires data on what, when and how much of something is produced, so that one can compare the performance of individual production lines and make decisions on the future structure of production (Munćan and Živković, 2006; Munćan et al., 2013). Gross margin can be used as a criterion for determining the structure of financial and performance analysis. GM is not the most important analytical model, but it is a good starting point. It also requires relatively simple data and methodology.

The above characteristics of the sour cherry production parameters are given on the basis of the calculated values of the basic indicators of the descriptive statistics shown in Table 1.

*Table. 1. Basic indicators of the production parameters of sour cherry (2011-2015).*

Production parameters	Average value	Variation interval		Coefficient of variation - Cv (%)	The rate of change (%)
		Min	Max		
Yield (t/ha)	11.20	7.00	15.00	19.60	0.06
Price (euro/t)	528.23	193.90	1013.57	54.95	9.72
Total Variable Costs (euro/ha)	1402.22	965.94	1623.04	15.91	-2.64
Gross Margin (euro/ha)	4001.27	500.84	13,692.49	96.13	11.71

The gross margin is to a certain extent the result of the impact of yield, prices and variable costs, and accordingly regression analysis quantified the impact of these factors on its value. The change in the gross margin was 97.8% explained by the impact of the observed factors. The results of the analysis show that with the increase in the yield of sour cherries by 1 t/ha, the gross margin is increased by 756.65 euros/ha. Variable costs have a negative impact on the gross margin of sour cherries. However, the results of the estimated regression model show that the impact of variable costs is not statistically significant.

The values of standardized regression coefficients (Beta values) show that the greatest relative impact on the change in gross margin is the price of cherry, and the smallest relative impact has variable costs and it is not significant.

Due to the insufficient number of observation units, it was not possible to check the significance of the difference in gross margins in observed years, by t-test, with the value of the gross margin in 2015. During 2013 and 2014, the number of sour cherries farms was increased, and it was possible to carry out the test. The results of the test (Table 2) show that the gross margin achieved in 2014 is statistically significantly different from the gross margin in the control year.

Table 2. T-test of gross margin values.

Year		Average value first year	Average value second year	t-quotient (value)	p- value
2011	2015				
2012	2015				
2013	2015	2968.69	4313.90	-1.47936	0.213137
2014	2015	2636.07	4313.90	-4.42858*	0.011435

\* p < 0.05, significant difference between the calculated values

### Conclusion

Price of sour cherry shows considerable variability during the observation period ( $C_v = 54.95\%$ ). The average price of sour cherries in the reporting period was approx. EUR 530/t, while the maximum price recorded was almost twice higher (1,016 EUR/t). In contrast to the yield, price showed significantly more pronounced tendency to increase - an average annual rate of 9.72%. The average value of total variable costs was approx. 1406 EUR/ha. A positive feature of variable costs of the sour cherry production is that they show a tendency to decrease, with an average annual rate of 2.64%. Occasional increases or decreases in the gross margin of the plant production lines in the years 2011 to 2015 have the highest increase in the price of products (2012), or the decrease in product prices (2014).

### References

- Anđelić, B., Janković, S., Tomić, V. (2010). Uticaj strukture ratarske proizvodnje na bruto maržu porodičnih gazdinstava /Impact of the structure of crop production on the gross margin of family farms/. Poljoprivredne aktuelnosti, Institut za primenu nauke u poljoprivredi, Beograd, br. 1-2, pp. 92-104.
- Barnard, C. S. & Nix, J. S. (1979). Farm Planning and Control. Cambridge University Press, Cambridge.
- Filipović J., Stanković, S., Ceranić, S. (2015). Gross margin as an indicator of the significance of farmer education on the WCR risk assessment in repeat sowing. Ekonomika poljoprivrede, Vol. LXII, No (1-284), pp. 137-155.
- Filipović, J., Stanković, S., Rahović, D., Bakić, I., Radišić, R., Tomić, V. (2016). Economic effects of plum production on family farms in the republic of Serbia. Proceedings of the 7th International Scientific Agriculture Symposium "Agrosym 2016", Faculty of Agriculture, University of East Sarajevo, Bosnia and Herzegovina, Jahorina (B&H), 6-9 October 2016. ISBN 978-99976-632-7-6. pp. 2779-2783.
- Kulhman, P., Shannon, D. & Casement, D. (2012). Farm gross margin and enterprise planning guide. Rural Solutions. Government of South Australia.
- Milić, D., Kalanović, B., Veljković, B. (2013). Menadžment i organizacija voćarsko – vinogradarske proizvodnje /Management and organization of fruit and vegetable production/. Agroekonomski fakultet, Čačak, pp. 22 i 59
- Munčan P., Živković D. (2006). Menadžment ratarske proizvodnje /Management of crop production/. Belgrade, p. 127
- Stanković S., Filipović J., Čolić S., Rahović D., Tomić V., Ljiljanić N., Radišić R. (2015). Gross margin of strawberry production in Pomoravlje region in Serbia. Proceedings Sixth International Scientific Agricultural Symposium AgroSym 2015, pp. 1961-1965. University of East Sarajevo, Bosnia and Herzegovina, 15.-18.10.2015. DOI: 10.7251/AGSY15051966S.

## **GROSS MARGIN AND ECONOMIC PARAMETERS OF GRAPE PRODUCTION IN POMORAVLJE REGION, SERBIA**

Jasmina FILIPOVIC<sup>1</sup>, Sladjan STANKOVIC<sup>2\*</sup>, Dragan RAHOVIC<sup>2</sup>, Vedran TOMIC<sup>2</sup>,  
Nikola LJILJANIC<sup>2</sup>, Robert RADISIC<sup>2</sup>, Marijana MASLOVARIC<sup>2</sup>

<sup>1</sup>Agricultural Advisory Service of Jagodina, Jagodina, Serbia

<sup>2</sup>Institute for Science Application in Agriculture, Belgrade, Serbia

\*Corresponding author: sstankovic@ipn.bg.ac.rs

### **Abstract**

Serbia has a good climate and soil conditions for growing grapes. In Serbia three growing regions are determined, with a 22 rayon and 77 vineyard areas, for the production of grape and production of a wine with the geographic origin. Based on the Census of Agriculture in 2012, it was found that 13% of the total number of farms are engaged in viticulture, but 92% of the production is performed at less than 50 acres area. In the production of grapes, family farms are in the first place then a small number of large wineries. Data for gross margin (GM) calculations were collected through a questionnaire from grape wine production farms in Pomoravlje region in the period 2011-2014. For calculating the basic elements of gross margin, we have used data on yield and price, by-product price, quantity and value of fertilizers, pesticides, and fuel, and costs for contracted services. GM was calculated as the total value of a production line subtracted by the direct costs for the production line in question (cf. purchased inputs).

The yield of grapes in the period 2011-2014, was approximately one tonne higher than the average yield of grapes in Serbia according to official statistics. Average yield was determined at 8.2 t / ha, and varied in the range from 5.5 t / ha up to a maximum of 12 t / ha. This presents relatively normal fluctuations in the yield, which indicates the value of the coefficient of variation (Cv) of 16%. Also grape yield had a tendency of slight decrease with an average annual rate of 0.3%. The average price of grapes in the reporting period was at about 390 EUR/t. A positive value indicates that rate of change of prices in the reporting period tends to increase by 0.77% per annum. The variable costs (VC) of the grape production in this period were on the average 1408 EUR/ha. VC show a tendency to decrease by 0.56% per year and was the most stable production parameter (Cv = 10.53%). Reduction in variable costs and the relative stability of the characteristics are favourable for the producers of grapes. Gross margin of the grape production in households was observed at an average level of about 1760 EUR/ha. Characteristic gross margin has significantly higher variability in relation to other parameters indicating the value of Cv of almost 31%. Although there are fluctuations in the values of gross margins, this parameter tends to increase at a rate of 1.06% per annum.

**Keywords:** *gross margin, grape, variable costs, yield, price.*

### **Introduction**

Using gross margin (GM) for agricultural advisors is a quite useful tool for assessing the economic importance of a certain production line, comprising solely the production value and variable costs. GM gives the result calculated only in relation to what has been invested to produce the quantity in question, giving the best overview over time. In the 1960s, GM became widespread used in the UK, by farm management advisors for making analyses and planning purposes (Barnard and Nix, 1979).

GM was used in this paper as an indicator narrower than an analytic calculation and it shows the difference between the cost of production and direct costs, which makes it an important tool from the economic viewpoint (Janković et al., 2009; Anđelić et al., 2010; Stanković et al., 2015; Filipović et al., 2015). We used the methodology for calculation of a standard GM as a scientific tool to support technical and economic orientation of farms (Iurchevici and Chetroui, 2011), in order to analyze economic results in grape production.

### **Materials and Methods**

GM calculations, as a standard descriptive statistic method, were used as an indicator of economic effects of grape production. Data on grape production were collected from a questionnaire survey conducted on a representative farm in Pomoravlje region during the period 2012–2014. Basic elements for gross margin calculation were used: yield and price, quantity and value of fertilizers, pesticides, and fuel, as well as costs of contracted services. All prices are given in EUR, but original data were collected in Serbian dinars (RSD). Prices were calculated based on Serbian National Bank average exchange rate against major world currencies for particular year ([www.nbs.rs/internet/cirilica/scripts/kl\\_prosecni.html](http://www.nbs.rs/internet/cirilica/scripts/kl_prosecni.html)). Indicators of the value of production, total variable costs and gross margin were calculated according to the methodology provided by the website of the Serbian Agriculture Advisory Service ([www.psss.rs](http://www.psss.rs)). For data processing and GM calculating, we used *Microsoft Excel*. The program was set to calculate the average value of each element of the calculation. GM is the difference of total revenue and total variable costs (TVC), achieved in a line of agricultural production per unit of production area (in crop production). We also calculated the critical values (Stanković et al., 2015; Filipović et al., 2016) with the aim of estimating results of production under conditions of uncertainty. Critical values are those values at which the GM equates to zero.

### **Results and discussion**

For efficient cost management and decision-making, GM is adequate analytical basis. In addition for such analysis advisors requires data on what, when and how much of something is produced, so that one can compare the performance of individual production lines and make decisions on the future structure of production. Gross margin is one of the derived indicators that can be used as a criterion for determining the structure of financial and performance analysis. GM is not the most important analytical model, but it is a good starting point. It also requires relatively simple data and methodology. Simplified, gross margin represents the total value of production, subtracted by the direct (variable) costs (purchased inputs).

Grape yield in the analyzed period 2011-2015 was about one tonne higher than the average yield of grapes in Serbia according to the official statistics. The average yield was 8.2 t/ha, ranging from a minimum of 5.5 t/ha to a maximum of 12 t/ha. There are relatively normal oscillations in yield, which shows the value of the coefficient of variation of 16%. Also, the yield of grapes had a tendency for a slight decline, with an average annual rate of 0.3%.

The average price of grapes in the observed period was around 390 euro/t. The positive value of the rate of change shows that the price in the observed period has a tendency to increase by 0.77% annually.

The variable costs of grape production in the analyzed period amounted to almost 1.405 euro/ha. This production parameter shows a decrease of 0.56% per year and is the most stable production parameter ( $C_v = 10.53\%$ ). Reducing variable costs and relative stability provide favorable characteristics for grape producers.



The gross margin in grape production in the observed farms was at an average level of about 1,755.68 euro/ha. The characteristic of the gross margin is also significantly higher variability compared to other parameters, which explains the value of the coefficient of variation of almost 31%. Although oscillations in the realized gross margin are present, this parameter has a tendency to increase at a rate of 1.06% per annum.

The above characteristics of the grape production parameters are given on the basis of the calculated values of the basic indicators of the descriptive statistics shown in Table 1.

Table 1. Basic indicators of the production parameters of grapes in the period 2011-2015.

Production parameters	Average value	Variation interval		Coefficient of variation - Cv (%)	The rate of change (%)
		Min	Max		
Yield (t/ha)	8.20	5.50	12.00	16.02	-0.30
Price (euro/t)	390.08	264.41	528.82	15.73	0.77
Total Variable Costs (euro/ha)	1404.81	1036.89	1810.24	10.53	-0.56
Gross Margin (euro/ha)	1755.55	391.55	2993.57	30.73	1.06

The impact of yield, prices and variable costs on the value of gross margin in grape production is quantified by applying regression analysis. All three of these factors show a statistically significant impact on the achieved gross margin level. The change in gross margin values by 96.6% can be explained by the impact of yield, price and variable costs. The highest relative impact on the gross margin has the price of grapes (0.77%). The next factor for the significance of the impact is the yield, and if it increases by one ton, this will result in a 356.39 euro/ha increase in the gross margin. Unlike yields and prices that have a positive impact on the gross margin, the impact of variable costs is negative and their increase decreases the value of the gross margin. If the total variable costs increase, the gross margin will be reduced by the same amount.

Table 2. T-test of gross margin values.

Year		Average value first year	Average value second year	t-quotient (value)	p-value
2011	2015	1468.09	1871.63	-1.22564	0.243847
2012	2015	1965.81	1871.63	0.20201	0.843033
2013	2015	2168.17	1871.63	0.74269	0.470877
2014	2015	1330.57	1871.63	-0.93614	0.369297

\*  $p < 0.05$ , significant difference between the calculated values

The lowest average value of gross margin was recorded in the last year of the observed period (2014). Gross margins realized in the period 2011-2014 do not differ significantly from the reference (control) value recorded in 2015 (Table 2).

The fluctuation of gross margin values by years, illustrates that in some years there is a tendency of increase of this parameter (GM), but that its values are close to the 2015 control value.

## **Conclusion**

Gross margin of the grape production in farms was observed at an average level of about 1760 EUR/ha. A characteristic of gross margin is significantly higher variability in relation to other parameters indicating the value of Cv of almost 31%. Although there are fluctuations in the values of gross margins, this parameter tends to increase at a rate of 1.06% per annum.

## **References**

- Anđelić, B., Janković, S., Tomić, V. (2010). Uticaj strukture ratarske proizvodnje na bruto maržu porodičnih gazdinstava /Impact of the structure of crop production on the gross margin of family farms/. *Poljoprivredne aktuelnosti*, Institut za primenu nauke u poljoprivredi, Beograd, br. 1-2, pp. 92-104.
- Barnard, C. S. & Nix, J. S. (1979). *Farm Planning and Control*. Cambridge University Press, Cambridge.
- Filipović J., Stanković, S., Ceranić, S. (2015). Gross margin as an indicator of the significance of farmer education on the WCR risk assessment in repeat sowing. *Ekonomika poljoprivrede*, Vol. LXII, No (1-284), pp. 137-155.
- Iurchevici, L., Chetroui, R. (2011). Standard Gross Margin for Cattle. *International Scientific Meeting - Sustainable Agricultural and Rural Development in Terms of the Republic of Serbia Strategic Goals Realization within the Danube Region*. Belgrade, Serbia, Vol. 59, pp. 111-117.
- Janković S., Anđelić B., Kuzevski J., Kosanović N. (2009). Analiza bruto marže ozime pšenice u 2006. i 2009. Godini /Analysis of Gross Margin of Winter wheat in 2006 and 2009/. *Poljoprivredne aktuelnosti*, Vol. 8, br. 1-2, pp. 56-64.
- Kulhman, P., Shannon, D. & Casement, D. (2012). *Farm gross margin and enterprise planning guide*. Rural Solutions, Government of South Australia.
- Filipović, J., Stanković, S., Rahović, D., Bakić, I., Radišić, R., Tomić, V. (2016). Economic effects of plum production on family farms in the republic of Serbia. *Proceedings of 7th International Scientific Agriculture Symposium "Agrosym 2016"*, Faculty of Agriculture, University of East Sarajevo, Bosnia and Herzegovina, Jahorina (B&H), 6-9 October 2016, pp. 2779-2783.
- Stanković S., Filipović J., Čolić S., Rahović D., Tomić V., Ljiljanić N., Radišić R. (2015). Gross margin of strawberry production in Pomoravlje region in Serbia. *Proceedings of the Sixth International Scientific Agricultural Symposium AgroSym 2015*, pp. 1961-1965. University of East Sarajevo, Bosnia and Herzegovina, 15.-18.10.2015. DOI: 10.7251/AGSY15051966S.

## **IMPORTANCE OF RURAL TOURISM AND INVESTIGATION OF ABROAD EXAMPLES**

Mükerrem ARSLAN, Erdi EKREN\*

Department of Landscape Architecture, Faculty of Agriculture, Ankara University, Ankara, Turkey.

\*Corresponding author: erdiekren@hotmail.com

### **Abstract**

Urbanization, one of the biggest problems in 21st century, causes many environment problems such as structure areas and population increase. The decline of urban green spaces and environmental problems in cities have made rural life and rural values again important in recent years. In this context, the concept of rural tourism, which emerges as a kind of alternative tourism in line with the changing income levels, needs and wants of the people covering the whole of the tourism activities in the rural areas, is getting more and more important day by day. Rural tourism, which enables rural areas to develop socio-culturally and economically, also offers tourists the chance to get in touch with natural beauties and meet local cultural characteristics. Turkey has a high potential for rural tourism, which plays an important role in preserving natural and cultural heritage as well as providing local sustainable development. In order for this potential to have a significant share in the development of Turkey, the right perception and development of the concept of rural tourism must be planned correctly. With this study, the importance of rural tourism will be emphasized and suggestions will be developed for our country by giving examples of rural tourism from Australia, South Africa and Turkey.

**Keywords:** *Rural tourism, Rural development, Sustainable development, Turkey.*

### **Introduction**

Urbanization, one of the biggest problems in 21st Century, causes many environment problems such as structure areas and population increase. The decline of urban green spaces and environmental problems in cities have made rural life and rural values again important in recent years. The concept of rural area can be defined in different forms considering; demographic structure, geographical situation and administrative form. According to the OECD (Organisation for Economic Co-operation and Development) areas where the population density is 150 persons or less per km<sup>2</sup> fall within the scope of the rural area (Kiper, 2006). Rural tourism concept covers the whole of the tourism activities in the rural areas and emerges as an alternative tourism type in accordance with the changing income levels, needs and wants of the people (Karaman et al., 2015). Rural tourism can be described as a set of activities that take place in a rural settlement in order to relax people in the natural environment and to coexist with different cultures and to live there and to watch or participate in activities specific to the locality (Baykal and Toprak, 2010). According to Soykan (2002), rural tourism is a form of tourism integrated with natural environment, rural settlement and local economic activities.

Rural tourism which enables rural areas to develop socio-cultural and economically also offers tourists the opportunity to get in touch with natural beauties and meet local cultural characteristics. Rural tourism has an important place in ensuring the sustainable development of rural areas. Sustainable rural development aims to improve the level of production, income

and quality of life that will change the socio-economic structure of the people living in rural areas and to bring the differences between the urban and rural areas to an optimum balance and to develop the rural population in its place. Thus, it also aims to prevent migration from rural areas to urban. Sustainable rural development, in line with these aims, is an approach that protects nonrenewable natural resources in rural areas while making use of them and transfers these resources to future generations (Geray, 1999; Güngör et al., 2013; Baykal and Toprak, 2010; Anonymous, 2017). For rural areas, development no longer involves only the growth of certain areas or agricultural development. Sharing, marketing, organization, local products, organic farming and different community dynamics are becoming more and more important in development. Rural development policies are now transforming into “functional and integrated approaches involving agriculture and non-agricultural sectors in rural areas for the welfare of rural communities, and policies to strengthen rural dynamics and priorities in all areas” (Gülçubuk, 2012). In the scope of rural tourism; many features such as the increase in infrastructure, health and education services in rural areas, increase in employment, increase in income after the development of tourism and accordingly increase the standard of living of the local people reveal that rural tourism is very important in terms of sustainable rural development (Ahipaşaoğlu and Çeltek, 2006).

The purpose of this work is to provide examples of rural tourism from Australia, South Africa and Turkey and to transfer its positive impacts, and to develop recommendations for rural tourism studies in Turkey.

### **Material and Methods**

Rural tourism concept constitutes research material. The emergence of rural tourism concept, its importance and its impact on sustainable rural development has been examined primarily. Later, the benefits provided by rural tourism have been revealed. It has been emphasized that rural tourism has an important place in ensuring the sustainable development of rural areas and examples of rural tourism has been given from Australia, South Africa and Turkey. As a result, proposals for rural tourism studies in Turkey have been developed.

### **Results and Discussion**

Open and green spaces are the areas where people come together to have fun and rest, while having great importance in the establishment, maintenance and development of social relations (Arslan, 2016). In recent years, many studies have been carried out in order to determine the amounts of urban green spaces. When these studies are examined, it is seen that the amount of public green spaces (parks and gardens) in the cities is decreasing. For example, the amount of green space in London was %38.4 in 2003 but it was %33 in 2013. In the same way, the amount of green space in Hong Kong was %41 in 2012 but after two years it was %40 (Anonymous, 2013; Anonymous, 2015). The decrease in the amount of green space in the cities and inadequacy in the face of the rapidly increasing urbanization cause many environmental problems to arise. The decrease in quality of life due to these environmental problems in the cities, the tiring of tourists from coastal tourism, the change of expectations about tourism and the development of the idea of utilizing the four seasons, not just summer, benefiting from tourism are the factors that make rural tourism popular in recent years (Akyol et al., 2014; Avcıkurt and Köroğlu, 2008).

Other positive effects of rural tourism, which emerged as an alternative type of tourism, increasingly appreciated in recent years and played an important role in ensuring sustainable rural development, can be listed as follows; (Dinçer et al., 2015; Karaman et al., 2015)

- By ensuring that the population develops in place, it prevents the people of the region from migrating to other regions,
- It provides softening of the differences between urban and rural areas,
- It contributes to the country's economy by providing sustainable development of rural areas,
- People in rural areas have the opportunity to earn income from various sources (handicrafts, accommodation, eating and drinking, etc.) as well as agriculture, which is the main source of livelihood,
- With the development of rural areas, it provides increased infrastructure, health and education services,
- It eases the burden of coastal tourism and creates new places for tourists,
- It allows the people, who are breaking from the nature, to approach their physical and psychological needs and nature,
- It plays an important role in preserving natural and cultural heritage.

It is possible to see very successful examples of rural tourism activities in different countries of the world. Especially fiestas and festivals related to the harvesting period are watched with interest and attract a lot of visitors. In all seasons of the year in the Central and Southern European cities, vineyards and wine cellars are very popular places. An interesting example of rural tourism is found in Lebanon. Caves De Ksara, located in Bekaa valley, is an extremely important facility in the production of wine ever since 1857. Today the facility is an important place with vineyards, gardens, wine cellars and lounges for tourists coming to the region. In addition to Caves De Ksara, examples of rural tourism from Australia, South Africa and Turkey were examined within the scope of the study.

#### Tjapukai Aboriginal Cultural Park

The Tjapukai word means "Rain Forest" and is often used to describe the "Rainforest Peoples". Established in 1987 as the aboriginal dance theater in the village of Kuranda near Cairns in Australia's Queensland province, the park was later supported by a variety of activities, transforming it into an area where tourists can find themselves in Australia's 40,000-year history. In this cultural park, aboriginal culture from the beginning to the present day is described as a theatrical expression. The cultural park serves tourists with full day, half day and night tour options. Tjapukai Aboriginal Cultural Park, built on an area of 25 acres; is composed of 7 different sections such as; History Theater, Creative Theater, Dance Theater, Didgeridoo Area Aboriginal Food and Drugs, Boomerang and Spear Throwing Area, Art Gallery and Boomerang Restaurant (Anonymous, 2017a).

#### Lesedi Cultural Village

South Africa's Lesedi Cultural Village, near Johannesburg city; are the cultural village where Zulu, Xhosa, Pedi, Basotho and Ndebele tribes and their daily lives are exhibited. In Lesedi Cultural Village, which defined by the word "Our culture is the light of our nation – whoever walks here amongst our cultures at Lesedi can also see the light", it is possible to observe the different architectural structures, the goods they used, the home lives of the five villages in the forest with the guide. There is also a restaurant serving traditional African cuisine as well as a tent theater displaying local music and dance shows in the cultural village. In addition, it also has accommodation in colorful and fascinating structures, with the traces of traditional residential architects (Arslan, 2016).

#### Sun City Cultural Village

Sun City Cultural Village, which founded in 1979 and located on the north-west of South Africa, is located 187 km. distance from Johannesburg. In addition to amusing night and day

activities (golf courses, water activities, children's playgrounds, safari tours, etc.), it also offers accommodation for tourists with four different themed hotels. In the valley of waves, which located in the cultural village, there is an artificial beach giving an impression of a tropical island and a large entertainment pool where artificial waves are created. There is also a kindergarten in the village that offers babysitting services for children in the 0-5 age group. For children between the ages of 5 and 12, there is a camp, "Kwena", and it is designed for enjoyable time. In the village there are also art events offering music, dancing, cinema and theater shows as well as shopping opportunities for tourists (Anonymous, 2017b).

It is possible to see penguins in "South Africa Penguin Island" located in the south of the country. It is also possible to get information about the natural life in the cheetah, lion and crocodile park, and to watch the animals at a reachable distance from the Sun City Cultural Village.

#### **Bey pazari Living Museum**

Bey pazari Living Museum was founded in 2007 as the first and only applied cultural museum of Turkey with the idea of displaying public life and its productions. Bey pazari Living Museum adopts as a principle this idea; "I hear and I forget. I see and I remember. I do and I understand" and it gives its visitors the opportunity to practice and cultivate this culture beyond showing them the rich and deeply rooted Turkish cultures. Being the first open air museum of Turkey, Bey pazari Living Museum aims visitors to have a pleasant time with various animation, interpretation techniques and interactive exhibition methods. There is a tale world within the museum that aims to convey the cultural heritage to future generations in an educational and amusing way through the tale. There are also "Karagoz Scene" where they can create their own shadow games, fabric design, marbling and wood carving arts, as well as "Trophy House" where they can shop for souvenirs (Anonymous, 2017c).

#### **Safranbolu Yoruk Village**

"Safranbolu Yoruk Village" is located in Safranbolu district of Karabuk province. The village, which is 20 km away from the district center and has a history of 750 years, is famous for its houses with traditional architecture. Handcrafted products and products made by the local people from the land for agriculture and animal husbandry are presented to the visitors of the village. There is almost no accommodation available in the village where restaurants serving regional specialties are served. The reason for this is that the village is close to the district center. The most important feature of "Safranbolu Yoruk Village" is that it is virgin in every direction. There are two museum houses in the village where traditional handicrafts, fabrics and clothes are exhibited as well as examples of traditional architecture. There is also an art workshop where visitors are shown pictures of traditional houses. Rock tombs, aqueducts, mound-like remains, canyons, caves, forests and plains in the immediate vicinity of the village are other interesting natural attractions (Kiper, 2006; Anonymous 2017d).

### **Conclusions**

Rural tourism concept, which emerges as a kind of alternative tourism in the direction of changing income levels, needs and wants of people and covers the entire tourism activities in rural areas, offers tourists the chance to get acquainted with natural beauties and to meet local cultural characteristics. Rural tourism areas are alternative tourism places that play an important role in economic and sustainable rural development while contributing to the promotion of the countries. And also these areas require comprehensive and detailed planning-design studies.

Turkey has a high potential for rural tourism, which plays an important role in preserving natural and cultural heritage as well as providing local sustainable development. In order for

this potential to have a significant share in the development of Turkey, the right perception and development of the concept of rural tourism must be planned correctly. Rural tourism can play an active role in preventing migration from rural areas, which is one of Turkey's biggest problems, if it is planned properly. If it develops unplanned, it can cause negative effects such as, the decline of agricultural land and the destruction of natural and cultural heritage.

The existing rural tourism areas planned in Turkey are far behind in terms of the number of visitors compared to other examples in the world. In order to overcome this problem, it is necessary to increase the diversity of activities in the rural tourism areas with an understanding that protects the irreplaceable natural resources. In addition, promotions of these areas need to be made more efficiently and easy access must be ensured. It is very important to provide government grant to the rural tourism and to transfer the necessary points to the local people and to establish the associations, foundations and federations in the field of rural tourism.

### References

- Ahipaşaoğlu, S., Çeltik, E., 2006. *Sürdürülebilir Kırsal Turizm /Sustainable Rural Tourism/*, Gazi Kitabevi, ISBN: 9799757313450.
- Akyol, C., Güner, S., Oğan, Y., Aydın, E., Yüce, R., Uluyurt, T. 2014. *Kırsal Alanların Turizm Potansiyelinin Belirlenmesi /Determination of the Tourism Potential of Rural Areas/- Artvin İli Arhavi İlçesi Örneği*, Atatürk Üniversitesi Sosyal Bilimler Enstitüsü Dergisi, Cilt:18, Sayı:1, s:249-271.
- Anonymous, 2013. Web Site: <https://www.london.gov.uk/sites/default/files/wccr2013.pdf>, Access date: 18.10.2015
- Anonymous, 2015. Web Site: <http://www.worldcitiescultureforum.com/cities/>, Access date: 20.12.2015
- Anonymous, 2017. Web Site: <http://www.kirsalcevre.org.tr/KC/KChakkimizda.php?page=20>, Access date: 12.06.2017
- Anonymous, 2017a. Web Site: <http://www.tjapukai.com.au/about-tjapukai>, Access date: 20.06.2017
- Anonymous, 2017b. Web Site: <http://www.sun-city-south-africa.com/>, Access date: 21.06.2017
- Anonymous, 2017c. Web Site: <http://www.yasayanmuze.net/page1.aspx>, Access date: 21.06.2017
- Anonymous, 2017d. Web Site: <http://www.gizlicennetler.com/yazici.asp?gc=5314cfcacd1acbc29b8a4cb84b106309&sayfa=all>, Access date: 22.06.2017.
- Arslan, M., 2016. *Tema Parkları /Theme parks/*. Plant Peyzajve Süs Bitkiciliği Dergisi, Sayı: 20, İstanbul.
- Avcıkurt, C., Köroğlu, Ö. 2008. *Kırsal Turizm İçinde: Turistik Ürün Çeşitlenmesi /In Rural Tourism: Touristic Product Diversity/* Nobel Yayın Dağıtım, Ankara.
- Baykal, F., Toprak, M.A., 2010. *Kırsal Kalkınmada Kırsal Turizm: Bozdoğan (Aydın) İçin Bir Araştırma /Rural Development and Rural Tourism: A Research for Bozdoğan (Aydın)/* Bozdoğan II (ed. S. Sürvegil), Bozdoğan Belediyesi Yayını, İzmir, s: 41-82.
- Diñer, M.Z., Türkay, B., Avunduk, Z.B., 2015. *Rural Tourism Policies: Evaluation of the Policies on European Union and Turkey*, International Journal of Social and Economic Sciences, Vol. 5, No. 1, pp. 49-60.

- Geray, C., 1999. Kırsal Kalkınma Yöneltileri, İlçe Yerel Yönetimive “İlçeKöyBirlikleri” Önerisi / Rural Development Directives, District Local Administration "District Parks" Proposal/. Çağdaş Yerel Yönetimler Dergisi, Cilt:8, Sayı:2, s:11-42.
- Gülçubuk, B. 2012. Kırsal Kalkınma Politikalarıve Yönetişim /Rural Development Policies and Governance/ 7. Bölgesel Kalkınmave Yönetişim Sempozyumu Kırsal Kalkınma Politikasının Yönetişimi, 13-14 Aralık 2012, Ankara.
- Güngör, H.Y., Karakaş, A., Fındıklı, Ö., 2013. Kırsal Turizm /Rural tourism/. Kırsal Kalkınma ve Dünyada Kırsal Turizm Örnekleri, Tarih-Kültür-İnanç Kenti Diyarbakır (ed. Y.K. Haspolat, A. Alyamaç Yılmaz),
- Karaman, A., Baltacıoğlu, S., Gürhan, Y.E., 2015. Kırsal Kalkınma Açısından Kırsal Turizmve Halkın İçin Proje Önerileri, Selçuk Üniversitesi Sosyal Bilimler Meslek Yüksekokulu Dergisi, Cilt:18, Sayı:2, s: 165-185.
- Kiper, T., 2006. An Assesment of the Landscape Potential of SanfranboluYorukkoyu in the Frame of Rural Tourism, Ph.D. Thesis, Ankara University, Ankara, Turkey, pp. 185-190.
- Soykan, F. 2002. Kırsal Turizmin Sosyo- Ekonomik Etkilerive Türkiye /Socio-Economic Impacts of Rural Tourism in Turkey/. Türkiye Dağları I. Ulusal Sempozyumu (25-27 Haziran 2002), Orman Bakanlığı Araştırma Planlamave Koordinasyon Kurulu Başkanlığı, Orman Bakanlığı Yayın No: 183, Ankara.



## **7. FORESTRY AND AGRO-FORESTRY**

## THE INFLUENCE OF LIGHT FACTORS AND COMPETITION AMONG THE CROWN OF THE ALLEY TREES OF *TILIA TOMENTOSA* (MOENCH) IN THE URBAN AREA OF SARAJEVO (BOSNIA AND HERZEGOVINA)

Selma HARAČIĆ-BERBIĆ\*, Ćemal VIŠNJIĆ, Besim BALIĆ

University of Sarajevo, Faculty of Forestry, Bosnia and Herzegovina

\* Corresponding author: selmaharacic@yahoo.com

### Abstract

This paper analyzes the influence of light factors and competition between alley trees on development and deformation of the silver linden. Researches were carried out on the alley's silver linden trees of different age in urban green areas of Sarajevo (Bosnia and Herzegovina). Research have shown that light is a key factor for the development of silver linden tree crown, and that the eccentricity of the crown to a greater extent occurs in the age of over 60 years. The deformation of the crown is particularly conspicuous towards the open side where the most light comes from. The silver linden is extremely responsive to light, therefore in the course of forming an alley it must be taken into account the planting distance, direction of the alley, and the intensity of sidelight that should be in optimum during the growth and development of alley. At afforesting the semi-urban barren lands, i.e. forming of urban forests or park forests using linden, it should be taken into account the planting distance and the edge of the stand, as the deformation of the crowns occurs most frequently with marginal trees. With thinning activities it is possible to optimize the amount of light within the forest, necessary for proper development of the crowns and the good stability of the trees, and by the planting of other tree species on the edge of urban forest, it can be avoided the deformation of the marginal silver linden trees and other species of linden used in forestry and urban forestry.

**Keywords:** *the influence of light, eccentricity of the tree crown, Tilia tomentosa Moench, Urban forestry*

### Introduction

Silver linden (*Tilia tomentosa* Moench) originates from the Balkan-Pannonian region of Europe. It has been used as a species planted in parks since 1767 (Banusevac et al.,1971). It is used today as an exclusive species in urban and park forests. Based on the historical data on the development of green surface in the city of Sarajevo (Beus 2009), Silver linden has been used as an element of the urban green surfaces since long time ago and it represents a species frequently used in Sarajevo's green surfaces. Its significance in the urban zones reflects in the beauty of its leaf, odoriferous flower, an interesting habitus and the form of the crown as a special element in an urban landscape. Most of the trees of the urban green surfaces in Sarajevo are developing in unfavorable conditions, the crowns and roots do not have enough space to grow. Due to changed external conditions, competition and given that the measures of cultivation are not being imposed, only rare specimen grow into individual ones which in morphological sense manifest representative characteristics of their species. Great number of trees have bad habitus, many damages done by decaying fungi and anthropogenic effect, badly formed crowns that are not trimmed regularly with a lot of dried and broken branches.

Eccentricity of the crown is defined as asymmetrical growth and development of the crown according to some authors. Symmetrical growth is the characteristic of regular growth and development of the crown. The phenomenon of eccentricity is very frequent in urban areas and happens most frequently with the lack of light on one of the sides of the crown. There are numerous consequences of the eccentricity and they lead to static instability and increase the possibility of breaking. Apart from that, the tree loses its aesthetic appearance and it needs regular interventions to naturally grow again. Larsen and others (2002) state that urban trees have different growth intensity because of the specific conditions of developing and growth, as well as cultivation, specific urban environment and microclimatic characteristics as compared to the same species located in a natural habitat. The Silver Linden imposes itself as an essential element of tree alleys in our region due to its adapting to urban environment. (Coder 1996).

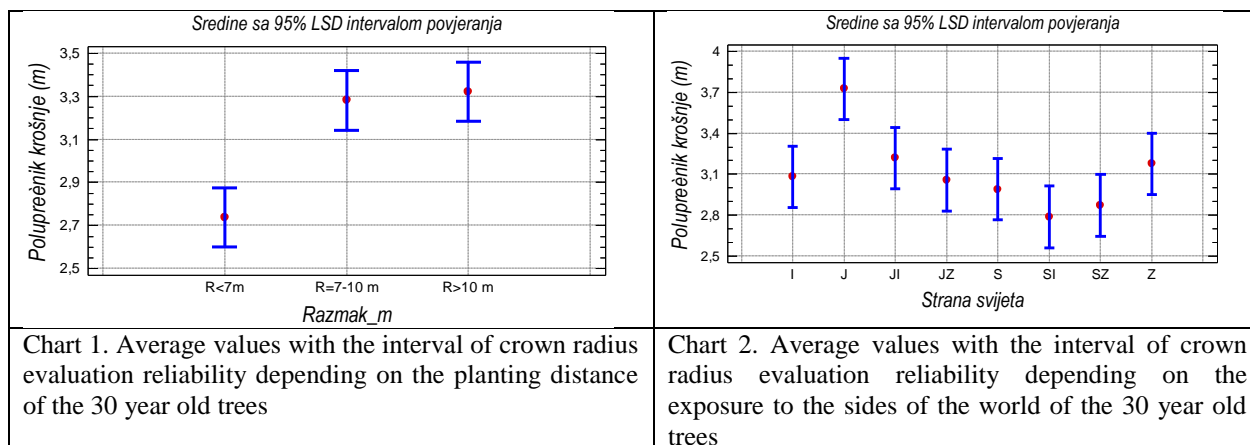
### Materials and methods

The object of this research are Silver linden (*Tilia tomentosa* Moench) trees of different age located in tree alleys, avenues and park surfaces in multiple locations in Sarajevo. Six different locations were chosen in immediate vicinity between which there are no bigger differences in eco-climate and habitat characteristics : (1) Wilson's avenue, (2) Linden Alley– left bank of Miljacka 3) Linden alley – next to the Bridge of Suada and Olga 4) Topal Osman Street – on the northern part of the Loris building 5) Mutevelic's Street – near the mall 6) Dobrinja, Sarajevo. In order to observe the method and character of the manifestation of light influence and competition between trees, analyses were carried out in chosen locations on the influence of distance in planting and the direction of crown branches spread on the crown radius. That is why we created the bifactorial experiment  $3^2$  (two factors with 3 modalities) where the most influential factors used are: distance between trees (factor A) whereas the manifestation of this factor was followed through three modalities:  $A_1$  – distance between linden trees  $< 7$  m;  $A_2$  – distance between linden trees 7 m – 10 m and  $A_3$  – distance between linden trees  $> 10$  m. The second most influential factor is the age of the linden trees (factor B) whose manifestation was analyzed through the following three modalities: B1 – linden trees 30 years old, B2 – linden trees 60 years old, B3 – linden trees 100 years old. In order to observe the steadiness of the influence of the planting distance (competition) and the influence of the direction in which the branches spread on the crown radius we applied the method of multiple variant analysis test (ANOVA) while the Fisher LSD test was used to evaluate the significance of differences between the environments where the influences were analyzed. The analyses were carried out separately by the age of trees.

### Results and discussion

In order to observe the method and character of the influence made by the planting distance (competition) and the influence of the direction in which the branches spread on the crown radius we applied the method of multiple variant analysis test (ANOVA). The analyses were carried out separately by the age of trees. In order to find out which side of the world stands out as the special homogenous group as well as to find out between which differences of crown radius average values there are statistically significant differences for the level of probability of 95%, multiple tests were made by Fisher LSD tests. Due to the extensiveness of the result tables, only the graphic ANOVA results are presented where the existence or nonexistence of the significance of differences in analyzed characteristics can be clearly perceived. On the following chart there are average heights for the crown radii with a 95% LSD interval of the evaluation reliability depending on the three different linden tree

planting distances (chart 1) and the exposure of the linden tree crowns to the primary and secondary sides of the world (chart 2) that are 30 years old. From the following charts it can be concluded that the average values of crown radiuses of the trees with the smallest planting distance are statistically notably different in comparison with the other two planting distances. It can also be concluded that the differences in average crown radiuses within the planting distance of R=7-10 m and R>10 are not statistically significant. Apart from that it can be concluded that, despite the planting distance, the side of the crown exposed from the south could be singled out.



The biggest crown radius was noted in the crowns exposed to the southern side with the biggest planting distance which is logical, if you take into consideration that southern exposure gives more light to the crown as well as that with bigger planting distances there is more space for growth and development, especially in younger trees with a progressive height increment. In similar way the results of ANOVA were presented for the analysis of the planting distance influence and different sides of the world on the crown radius (m) of the 60 years old linden trees.

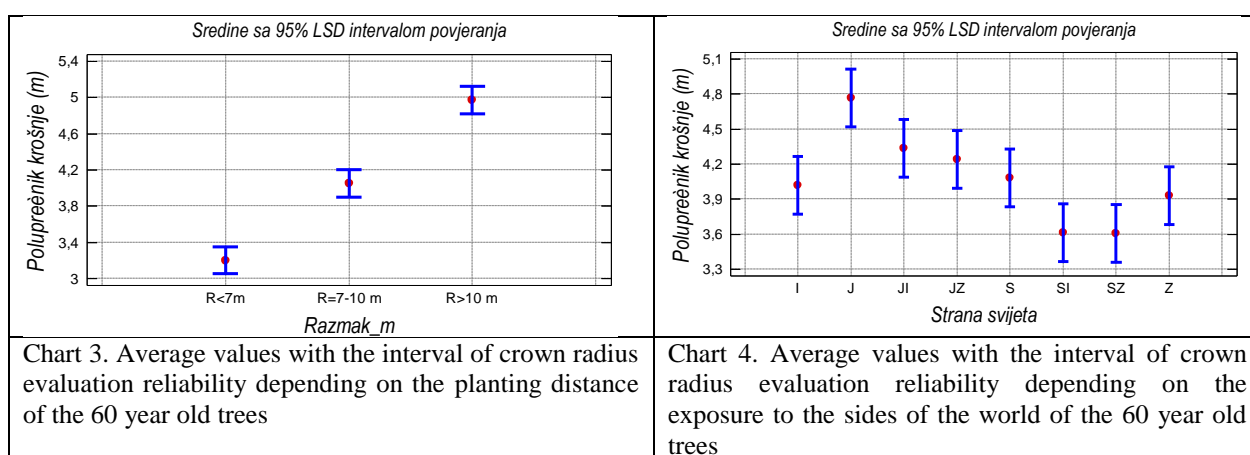
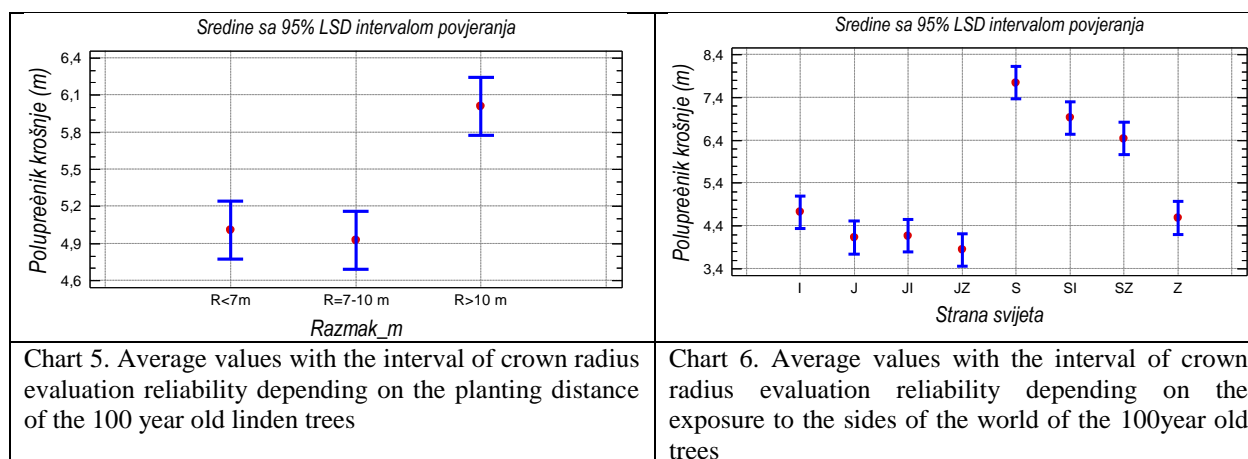


Chart 3 gives a visible evidence of statistically noticeable differences between all three planting distance modalities where the group of trees with the biggest distance have the biggest crown radiuses and the trees with the smallest distance - the smallest crown radiuses. In this case it can be seen that the southern side of the crown stands out as statistically noticeable because of the biggest crown radius while the smallest size radius was noticed on the crowns exposed on the Northeastern and Western side.



Unlike the previous charts, in this case the trees that especially stand out are the ones with the biggest planting distance, despite the sides of the world, as statistically noticeable regarding the crown radius, while between the first two planting distances there are no noticeable differences in the crown radius size. Regarding the other factor the crowns that stand out are the ones exposed to the North, Northeast, and Northwest and have the biggest crown radius while the smallest radiuses were seen in the trees exposed to the South. This can be explained by knowing that after some time there was a culmination of the height increment as well as branches growing in length so the influence of light manifests less compared to the planting distance. Apart from that, it is not known whether the older trees with eccentric crown had their branches broken by the impact of snow, wind or man.

### Discussion

This study analyzed the influence of the distance between trees (competition) and the exposure of the crown to the sides of the world on the difference in crown radius whose size directly influences the phenomenon of the crown eccentricity. Unequal branch growth is a direct consequence of a stronger or weaker exposure of the sides of the crown to sun, which causes the phenomenon of the eccentric and asymmetrical crown form. Eccentricity of the crown is defined as asymmetrical growth and development of the crown according to some authors (Sjöman and Oprea, .2010). Symmetrical growth is the characteristic of regular growth and development of the crown. The phenomenon of eccentricity is very frequent in urban areas and happens most frequently with the lack of light on one of the sides of the crown. There are numerous consequences of eccentricity and they lead to static instability and they increase the possibility of breaking. The young tree crowns grow more towards the south sides where there is more light, and later on the crown grows more on the norther side because of the competition between trees and lack of light which the results also show. We can already see the negative manifestation of the crown's eccentricity in the mentioned location. The results of the research done until now show that because of the specific conditions in which the urban trees develop and grow they have shorter life span (Roman 2011). That is why it is very important to pay attention when choosing the species that can grow in the urban environment and also try to enable the best habitat conditions for the growth of the chosen species. The given results show the complexity of the growth and development of the trees in the alleys and avenues where frequently the man negatively influences and shapes the growth of the trees with its activities. We can conclude that those activities have restrictive characteristic and that the man reacts too late and especially only when the crown branches are damaged or dried up. These analyses show that due to the

crown's eccentricity the trees are less stable in these locations so there were fatal damages that pose threat on property and people's lives (Picture no 1). Therefore the gotten results can represent an excellent foundation that can be used to work out an elaborate study with the aim of preventing this type of damage on the avenue tree species.



**Picture no 1.** Crown deformities caused by the intense eccentricity that impacts the tree's stability. The trees included in the research before the snow in April of 2017 (source: [www.faktor.ba](http://www.faktor.ba) )

### Conclusions

The results of the research show the significance of the influence of light on the phenomenon of the crown eccentricity in the neighboring trees of the Silver linden in the function of time. It is established that competition, as a visible manifestation in the form of drying and branch overlap is more visible from the age of 60 years and become more so over the further growth and development. The studies show that the light is an essential factor for the Silver linden tree crown development and that the crown eccentricity happens on a larger scale in the older trees up to age of 60. Crown deformity is especially pronounced towards the open side where there is more light coming in. the Silver linden reacts strongly on light so the planting distance must be considered when forming an alley or avenue, or the direction of the alley or avenue or the intensity of the side light which has to be optimal during the growth and development of the tree alley. It is necessary to cultivate each tree depending on its needs. Some species need to have their crown trimmed, reduced, form it and clean it. It shows that before trimming the tree one needs to do a study where these and similar studies could be a basis for the prompt carrying out of protective measures and cultivation of these valuable biological elements. When carrying out a forestation of the semi urban city barren land in growing urban forests of park forests with linden trees it should be taken into account to perform the correct planting distance and the edge of the stand because the trees on the edge have the most frequent occurrence of crown deformities. Thinning procedures can optimize the light necessary for the regular development of the crown and good tree stability. Planting other tree species on the edge of the urban forest the crown deformity can be avoided of the Silver linden trees and other Linden trees used in urban forestry and forestry in general.

### References

- Beus, V., (2009):. Nove aleje Sarajeva, ( New Avenue of Sarajevo)- Fondeko svijet br. 29.  
Bunuševac T., Žujović K., (1971): Fenološke pojave lipa (*Tilia* sp) zelenih površina Novog Beograda. (Phenological phenomena linden (*Tilia* sp) green areas of New Belgrade.) Glasnik Šumarskog fakulteta 39, Univerzitet u Beogradu - Šumarski fakultet, Beograd (71-94), DOI:N/A.

- Coder, D. K., (1996):Relative tolerance of tree species to construction damage, University of Georgia.
- Dobbertin, M., (2005).Tree growth as indicator of tree vitality and of tree reaction to environmental stress: a review, *Eur J. Forest Res* 124,(319–333).
- Haračić- Berbić, S., Višnjic, Č., Balić, B. (2016). Utečaj razmaka sadnje između alejnih stabala srebrenaste lipe (*Tilia tomentosa* Moench) na razvoj modifikacije oblika krošnje u urbanom zelenilu.(The influence of silver lime’s alley stem planting distance on the crown development and modification in urban greenery.) „Naše šume”, Broj 42-43. godina 15. . (68-75). Sarajevo.
- Larsen, F. K.i dr. (2002). *Tilia’s Physical dimensions over time*, *Journal of Arboriculture*, 26 (6).
- Roman, L., (2011) *Street tree survival rates: Meta-analysis of previous studies and application to a field survey in Philadelphia, PA, USA*, *Urban Forestry & Urban Greening*, No.10 /11 (pages).
- Sjöman, H., Oprea A., (2010): *Potential of Tilia tomentosa Moench, for use in urban environments in North-West Europe, based on habitat studies in north –East Romania and the Republic of Moldova*, *Swedish University of Agricultural Sciences, Faculty of Landscape Planning, Horticulture and Agricultural Science*.

## CANOPY GAP CHARACTERISTICS IN A RESERVED ORIENTAL BEECH FOREST, NORTHERN IRAN

Masoud TABARI\*, Saied KIAN, Omid ESMAILZADEH, Seyed JALIL ALAVI

Department of Forestry, Faculty of Natural Resources, Tarbiat Modares University, Noor, Iran

\*Corresponding author: mtabari@modares.ac.ir

### Abstract

Canopy gap characteristics were investigated in a reserved oriental beech (*Fagus orientalis* Lipsky) stand in the Caspian forests, northern Iran. Seventy six percent canopy gaps were sampled at 5 transects of 625 to 2000 m parallel to slope contours. Gap area was estimated using field method of measurement of non-convex polygonal. Transects were separated by 50 m to ensure that large gaps are not sampled more than once. Median and mean area of gap was 120.7 and 159.2 m<sup>2</sup>, respectively. Mean canopy gap fraction was 8.4%. Most frequent gap makers (36%) belonged to DBH class of 82.5-107.5. Sixty eight percent of canopy gaps were smaller than 200 m<sup>2</sup> but only 1.4% bigger than 500 m<sup>2</sup> consisting of 5.8% proportion of the total gap area. The proportion of middle gap sizes (100-500 m<sup>2</sup>) was nearly 5 fold of gaps of smaller than 100 m<sup>2</sup>. The maximum of gap-makers per gap was 6 trees but 56.6% of gaps were formed by the death of up to 3 trees; 43.4% of gaps were expanded after the initial gap formation, due to recurrence of disturbance events. Most (60.4%) of the gap-makers were at medium and old decay stages; 4.5% of gap-maker species and 12.4% of mortality mode of gap-makers were unknown. However, 60.4%, 19.3%, 5.8% and 2.1% of the all gap-maker trees were snapped-alive, uprooted, snapped-down and standing-dead (deadwood), respectively. Exogenous agents, such as chronic winds, could have a prominent role in initial formation and expansion of canopy gaps.

**Keywords:** *disturbance regime, canopy gap, gap-maker, gap fraction.*

### Introduction

Caspian forests with an area 1.9 million ha have been located mainly in the south coasts of the Caspian Sea in northern Iran over altitudinal gradient of -20 to 2200 m a.s.l. The region is covered with temperate deciduous forests. Oriental beech (*Fagus orientalis* Lipsky) is the most important commercial species, which forms pure and mixed stands between 700 and 2000 m.a.s.l. in these forests (Sagheb-Talebi and Schültz, 2002). Managed plans had been organized for merely 60% of the surface of these forests, this is while that the undisturbed, unmanaged and natural semi-virgin beech stands are still existent within the region (Sagheb-Talebi *et al.*, 2005). Therefore, intact oriental beech stands provide a unique prospect to study the disturbance regimes of these forests in the absence of anthropological interventions (Sefidi *et al.*, 2011).

Natural disturbances (happened by winds, insects, diseases, acidic deposition, drought and climate change) with low intensity and relatively high frequency caused the formation of gaps with different sizes, driving the forest dynamics in the absence of human interventions (Schliemann and Bockheim, 2011). Canopy gap is a space in the forest stand induced by the death of at least one over-storey tree, where the active recruitment of new individuals was already occurring (Watt, 1947); it is a measurable indicator of past small-scale disturbances (Lundquist and Beatty, 2002). Gap frequency, gap size, and gap shape are the most important



among the several metrics used in describing such disturbance patterns (Gagnon *et al.*, 2004). Gap size represents the magnitude of the disturbance, which has a direct influence on gap microclimate, under-storey damage levels, nutrient cycling and growth of the gap-border trees as well as vegetation elements within gaps (Gray *et al.*, 2002; De Lima *et al.*, 2008; Muscolo *et al.*, 2015). Scientific report on gap-maker trees in forest stands has been rarely published in the country. The purpose of this study is to gain a better understanding of gap characteristics in a reserved oriental beech forest, in Northern Iran.

### Materials and Methods

We selected an area ~190 ha with 870 to 1130 m a.s.l. with northern aspect and slope of 15-60%, situated between 36°41' and 36°47' N, and 54°20' and 54°24' E. The study area has been involved a typical old-growth stand in a reserved beech forest, including very large and old trees, heterogeneous vertical and horizontal structure at small spatial scales and profuse coarse woody debris. Canopy gaps as openings in the canopy larger than 20 m<sup>2</sup> caused by the mortality of a tree with a diameter larger than 20 cm at 1.30 m height (DBH) were chosen. Dead trees with DBH smaller than 20 cm were not large enough to create a canopy gap (Nagel and Svoboda, 2008; Nagel *et al.*, 2010; Bottero *et al.*, 2011). When gapfillers reached a height of 24.5 m, the gap was considered closed. DBH and height of 150 trees measured in canopy gaps, regularly distributed in all size classes, were measured too.

We sampled 76 gaps by using line-intercept sampling method over 5 transects varying in length from 625 to 2000 m parallel to slope contours. The gap area was estimated using field method of measurement of non-convex polygonal (NOPO). Transects were separated by 50 m to ensure that large gaps are not sampled more than once. Gap fraction was determined in each transect. Besides, characteristics of gap-makers comprising: species, DBH (if not possible the DBH class was determined), mortality mode (i.e., standing dead, uprooted and snapped) were recorded and, snapped gap-makers categorized into one of three classes (i.e., snapped alive, snapped dead, or snapped-down) (Nagel and Svoboda, 2008).

### Results and Discussion

Canopy gaps in the present research were highly variable in size, ranging from 10.5 to 696.6 m<sup>2</sup> with a median of 120.7 and mean area of 159.2 m<sup>2</sup> over all five transects (Table 1). The most frequent diameter classes of gap makers belonged to 82.5-107.5 DBH. Gap fraction ranged from 6.8% to 9.4% in different elevation of the study site. Mean canopy gap fraction was 8.4% that is almost similar (9.3%) to old-growth *F. orientalis* dominated forests in middle Hyrcanian forests of northern Iran (Sefidi *et al.*, 2011), but it was nearly two fold of that in other old-growth forests of eastern Hyrcanian (Amiri *et al.*, 2015). It is noticed that the previous study in Hyrcanian forests had a limited area (smaller than 25 ha) and was carried out in mixed beech old-growth stands.

The studies on the gap disturbance regime of intact beech forests in Europe have also varied results on the gap fraction. The gap fraction in oak-beech forest of Romania, 12.8% (Petritan *et al.*, 2013), beech-fir forest of Slovakia, 11.3% and 15-16% (Kucbel *et al.*, 2010; Drösser and Van Lüpke, 2005), mixed beech and coniferous forests of Bosnia and Herzegovina, 14% and 19% (Nagel and Svoboda, 2008; Bottero *et al.*, 2011), pure beech forests of Slovenia, 5.6% (Zeibig *et al.*, 2005), and mixed beech and coniferous forests of Czech, 9%-11% (Kenderes *et al.*, 2008) was reported. This attributes in American mixed-beech forests was 9.5% and 17.7% (Weskittel and Hix, 2003) and in beech forests of Japan was 1.7% to 20% in stands with different age classes (Yamamoto and Nishimura, 1999).

In our study, most of the canopy gaps (68.4%) were smaller than 200 m<sup>2</sup>, whereas only 1.4% was larger than 500 m<sup>2</sup> that comprised 5.8% of the total gap areas. In contrast, 40.8% of gaps were smaller than 100 m<sup>2</sup> that their proportion of the total gap areas was nearly 2.2 fold of gaps > 500 m<sup>2</sup>. However, the proportion of middle gap sizes (100-500 m<sup>2</sup>) was considerable (nearly 5 fold of gaps < 100 m<sup>2</sup>) (Table 2). In other words, 40.8% and 57.8% of the gaps belonged to the small (< 100 m<sup>2</sup>) and medium (100-500 m<sup>2</sup>) gap sizes, respectively. However, the most of gaps allocated to medium-sized gaps, indicating the prominent influence of such gaps on forest dynamics in comparison with small gaps. At the same time, small gaps are more likely to be closed by the lateral crown growth of the gap border trees.

Table 1. Summary statics of canopy gap characteristics in oriental beech forest of the site study

	Median	120.7
Gap size (m <sup>2</sup> )	Mean ± Sd	159.0 ± 14.2
	Range	10.5 - 696.6
Gap fraction (%)	Mean	8.4
	Range	6.8 - 9.4
Gap maker-tress	<u>DBH Classes</u>	<u>Frequency (%)</u>
	7.5-32.5	10
	32.5-57.5	12
	57.5-82.5	24
	82.5-107.5	36
	>107.5	18

Maximum size of gaps in beech forests of Iran have been reported often from 622 to 1250 m<sup>2</sup> (Amiri *et al.*, 2015). However, all of these researches support the role of gaps < 500 m<sup>2</sup>, especially medium-sized gaps in the dynamics of forest stands, whereas the large gaps (>1000 m<sup>2</sup>) are known as a rare occurrence in these forests. In European beech forests, frequency of gap sizes is followed by a negative exponential form (Nagel and Svoboda, 2008; Bottero *et al.*, 2011) and log-normal (Drösser and Van Lüpke, 2005) and gaps < 100 m<sup>2</sup> are more frequent (61% to 70%) in comparison with those in the beech forests of Iran. This can be resulted from the minimum area which was explained for 1) gap, 2) the age structure of gap, 3) the presence of coniferous trees with a relatively smaller crown compared to broad-leaved trees in the composition of stands. Nevertheless, in European beech forests, the role of medium and large gaps in forest dynamics is more influence than that of small gaps (Nagel and Svoboda, 2008; Kucbel *et al.*, 2010).

Table 2. Frequency and area of canopy gaps size classes in oriental beech forest of the site study

Gap size class (m <sup>2</sup> )	Frequency		Area	
	Absolute	Cumulative (%)	m <sup>2</sup>	Cumulative (%)
< 100	31	40.8	1803	14.9
100-200	21	68.4	2901	38.9
200-300	13	85.5	3114	64.7
300-400	8	96.0	2742	87.4
400-500	2	98.6	829	94.2
500-600	-	98.6	-	94.2
600-700	1	100	697	100
Total	76	-	12086	-

From 76 recognized gaps, 47.4% were formed by the death of 1 tree and the rest had 2 or more gap-makers (Table 3). Although the maximum number of gap-makers per gap is 6 trees, but such gaps rarely are seen in the study area. The use of decay classes of gap-maker trees to identifying the recurrence of disturbance events in each gap indicates that most of gaps (56.6%) were formed due to a single disturbing event happened by the death of up to 3 trees. These gaps include of several gaps with multiple gap-makers (2 and 3 trees), as well; however, their portion is < 10% of total gaps (Table 3). As a whole, in our research like the above mentioned studies, such individual gaps were rare and most contained < 4 gap-makers (Table 3). The majority of gaps in the mixed beech-fir forests of Bosnia and Herzegovina were multiple-phase (Nagel and Svoboda, 2008; Bottero *et al.*, 2011). Conversely, the most of the gaps in beech forests of Czech were formed from the concurrent death of 1-3 trees at the same place (Kenderes *et al.*, 2008). Gap expansion due to chronic winds stress has been also reported in subalpine *Picea-Abies* forests in the northeastern United States (Worrall *et al.*, 2005). Therefore, the gap expansion at the length of time could not be received as a prevailing phenomenon among all multiple-tree gaps. The mortality of 43.4% of gap-makers was asynchronous, indicating such gaps were expanded after initial gap formation (Table 3). In spite of several disturbance events occurred in the study area, many single-phase gaps did not experience the recurrence of disturbance events (Table 3).

Table 3. Frequency of gaps by number of disturbing events and of gap-maker trees in oriental beech forest of the site study

Min. number of decay classes (disturbance events)	Number of gap-maker trees						Total
	1	2	3	4	5	6	
1	36 (47.4)	6 (7.9)	1 (1.3)	-	-	-	43 (56.6)
2	-	22 (28.9)	3 (4.0)	2 (2.6)	-	-	
3	-	-	2 (2.6)	-	3 (4.0)	-	33 (43.4)
4	-	-	-	-	-	1 (1.3)	
Total	36 (47.4)	28 (36.8)	6 (7.9)	2 (2.6)	3 (4.0)	1 (1.3)	76 (100)

The numbers in parentheses are relative frequency.

There are many reports regarding to multiple-tree gaps, showing the such gaps are resulted from a single event or that several disturbing events caused by individual gaps in the Caspian Forest Regions of northern Iran. In various researches the maximum number of gap-makers was reported from 4-7 trees within the individual gaps (Delfan Abazari *et al.*, 2004; Sefidi *et al.*, 2011; Amiri *et al.*, 2015). In our findings 83.3% of canopy gaps were formed by single gap-makers, whereas only 4.6% of these gap-makers were health and the remaining (79.2%) in different stages of decay (Table 4). Canopy gaps of two gap-maker trees were at medium, old and very old decay stages and those of three gap-maker trees presented only medium decay stage. In overall, most (60.4%) of the gap-makers were at medium and old decay stages (Table 4).

Generally, of the 139 existing gap-makers within 76 gaps, 78% were oriental beech, 10%, 2.8%, 2.8% and 1.4% were *Carpinus betulus*, *Acer velutinum*, *Parrotia persica* and *Alnus subcordata*, respectively. The remaining 4.5% was considered unknown species because of their advanced decay state (Table 5). We were not able to identify the type of species of all gap-maker trees; nonetheless the oriental beech was the most frequent gap-maker tree among different species in the site study. We could not find the mortality mode for 12.4% gap-makers and tree species for 4.5% of them. However, 60.4%, 19.3%, 5.8% and 2.1% of the all

gap-maker trees were snapped-alive, uprooted, snapped-down and standing-dead (deadwood), respectively (Table 5). Exogenous agents, such as chronic winds, could have a prominent role in initial formation and expansion of canopy gaps.

Table 4. Frequency of single-phase gaps by number of gap-maker trees and decay stage

Number of gap-makers	Decay stage of gap-maker trees					Total
	Without decay	Early	Medium	Old	Very old	
1	2 (4.6)	6 (14.0)	11 (25.6)	11 (25.6)	6 (14.0)	36 (83.8)
2	-	-	1 (2.3)	2 (4.6)	3 (7.0)	6 (13.9)
3	-	-	1 (2.3)	-	-	1 (2.3)
Total	2 (4.6)	6 (14.0)	13 (30.2)	13 (30.2)	9 (21.0)	43 (100)

The numbers in parentheses are relative frequency.

Table 5. Frequency of gap-maker tree species by the mortality mode, decay stage and tree species

Mortality Mode	<i>Fagus orientalis</i>	<i>Carpinus betulus</i>	<i>Acer velutinum</i>	<i>Parrotia persica</i>	<i>Alnus subcordata</i>	Unknown	Total
Snapped alive	72 (51.9)	7 (5.0)	3 (2.1)	1 (0.7)	1 (0.7)	-	84 (60.4)
Uprooted	17 (12.2)	7 (5.0)	-	2 (1.4)	1 (0.7)	-	27 (19.3)
Snapped down	8 (5.8)	-	-	-	-	-	8 (5.8)
Standing dead	3 (2.1)	-	-	-	-	-	3 (2.1)
Unknown	9 (6.5)	-	1 (0.7)	1 (0.7)	-	6 (4.5)	17 (12.4)
Total	109 (78.5)	14 (10.0)	4 (2.8)	4 (2.8)	2 (1.4)	6 (4.5)	139 (100)

The numbers in parentheses are relative frequency.

The remnants of 3 gap-maker trees were not seen within the gap; we classified them as unknown.

## Conclusions

Generally, the small and the medium gaps in our study indicate that periodic low-intensity disturbance events play a major role in forest dynamics. The high proportion of rotten trees in the above-storey indicates that single trees are prone to wind-breakage, which promotes these small-scale dynamics. Of course, the various pathogens can make gap-makers more susceptible to wind or snow related mortality (Nagel and Svoboda, 2008). The stem-breakage in different height of trees and tree uprooting may be the dominant modes of gap-maker mortality in the study area. Despite that we observed the stem structural defects in a considerable number of such gap-makers, but the exogenous agents, especially chronic winds, could have been a prominent role in initial formation and expansion of gaps.

## References

- Amiri, M., Rahmani, R., Sagheb-Talebi, Kh. (2015). Canopy gaps characteristics and structural dynamics in a natural unmanaged oriental beech (*Fagus orientalis* Lipsky) stand in the North of Iran, *Caspian J. of Environmental Sciences*, 13(3): 259-274.

- Bottero, A., Garbarino, M., Dukic, V., Govedar, Z., Lingua, E., Nagel, T.A., Motta, R. (2011). Gap-Phase dynamics in the old-growth forest of Lom, Bosnia and Herzegovina, *Silva Fennica*, 45(5): 875-887.
- De Lima, R.A.F., Martini, AMZ, Gandolfi, S., Rodrigues, R.R. (2008). Repeated disturbances and canopy disturbance regime in a Tropical Semi-Deciduous Forest. *Journal of Tropical Ecology*, 24: 85–93.
- Delfan Abazari, B., Sagheb-Talebi, Kh., Namiranian, M. (2004). Regeneration gaps and quantitative characteristics of seedlings in different development stages of undisturbed beech stands (Kelardasht, Northern Iran), *Iranian Journal of Forest and Poplar Research*, 12 (2): 302-306 [in Persian].
- Drösser, L. and Van Lüpke, B. (2005). Canopy gaps in two virgin beech forest reserves in Slovakia, *Journal of Forest Science*, 51 (10): 446-457.
- Gagnon, J.L., Jokela, E.J., Moser, W.K., Huber, D.A. (2004). Characteristics of gaps and natural regeneration in mature longleaf pine Flatwoods Ecosystems. *Forest Ecology and Management*, 187: 373–380.
- Gray A.N., Spies T.A., Easter M.J. (2002). Microclimate and soil moisture responses to gap formation in coastal Douglas-fir forests. *Canadian J. of Forest Research*, 32: 332-343.
- Kenderes, K., Kamil, K., Vrška, T. and Standovár, T. (2008). Natural gap dynamics in a Central European mixed beech-spruce-fir old growth forest, *Ecoscience*, 16 (1):39-47.
- Kucbel, S., Jaloviar, P., Saniga, M., Vencurik J., Klmas, V. (2010). Canopy gap in old-growth fir-beech forest remnant of Western Carpathians, *European Journal of Forest Research*, 129: 249-259.
- Lundquist, JE. and Beatty, JS. (2002). A Method for characterizing and mimicking forest canopy gaps caused by different disturbances. *Forest Science*, 48: 582-594.
- Muscolo, A., Bagnato, S., Sidari, M. and Mercurio, R. (2015). A review of the roles of forest canopy gaps, *Journal of Forestry Research*, 25(4): 725–736.
- Nagel, T.A. and Svoboda M. (2008). Gap disturbance regime in an old-growth Fagus-Abies forest in the Dinaric Mountains, Bosnia-Herzegovina, *Canadian Journal of Forest Research*, 38: 2728-2737.
- Nagel, T.A., Svoboda, M., Rugani, T., Diaci, J. (2010). Gap regeneration and replacement patterns in an old-growth Fagus-Abies forest of Bosnia-Herzegovina, *Plant Ecology*, 208: 307-318.
- Petritan A.M., Nuske R.S., Petritan I.C., Tudose N.C. (2013). Gap disturbance patterns in an old-growth sessile oak (*Quercus petraea* L.)–European beech (*Fagus sylvatica* L.) forest remnant in the Carpathian Mountains, Romania, *Forest Ecology and Management*, 308: 67-75.
- Sagheb-Talebi, Kh. and Schültz, J.P. (2002). The structure of natural oriental beech (*Fagus orientalis*) forests in the Caspian Region of Iran and the potential for the application of the group selection system, *Forestry*, 75(4): 465-472.
- Sagheb-Talebi, Kh., Delfan Abazari, B., Namiranian, M. (2005). Regeneration process in natural uneven-aged Caspian beech forests of Iran, *Schweizerische Zeitschrift fuer Forstwesen*, 156, 12: 477-480.
- Schliemann, S.A. and Bockheim, J.G. (2011). Methods for studying treefall Gaps: A Review, *Forest Ecology and Management*, 261: 1143-1151.
- Sefidi, K., Marvie Mohadjer, M.R., Reinhard, M., Copenheaver, C.A. (2011). Canopy gaps and regeneration in old-growth oriental beech (*Fagus orientalis* Lipsky) stands, Northern Iran, *Forest Ecology and Management*, 262: 1094-1099.
- Watt, A.S. (1947). Pattern and process in the plant community, *Journal of Ecology*, 35: 1-22.
- Weiskittle A.R. and Hix D.M. (2003). Canopy gap characteristics of an oak-beech-maple old-growth forest in Northeastern Ohio, *Ohio Journal of Science*, 103 (4): 111-115.

- Worrall, J.J., Lee, T.D., Harrington, T.C. (2005). Forest dynamics and agents that initiate and expand canopy gaps in Picea-Abies forests of Crawford Notch, New Hampshire, USA, *Journal of Ecology*, 93: 178-190.
- Yamamoto S.I. and Nishimura, N. (1999). Canopy gap formation and replacement pattern of major tree species among developmental stages of beech (*Fagus crenata*) stands, Japan, *Plant Ecology*, 140, 167-176.
- Zeibig A., Diaci J. and Wanger S. (2005). Gap disturbance patterns of a *Fagus sylvatica* virgin forest remnant in the Mountain Vegetation Belt of Slovenia, *Forest Snow and Landscape Research*, 79(1/2): 69-80.

## EFFECTS OF RETENTION IN FOREST THE DRAINAGE WATER FROM AGRICULTURAL AREA

Magdalena JANEK<sup>1</sup>, Kamil MAŃK<sup>1</sup>, Edward PIERZGALSKI<sup>1</sup>

<sup>1</sup>Department of Forest Ecology, Forest Research Institute, Poland

\*Corresponding author: E.Pierzgalski@ibles.waw.pl

### Abstract

The poor quality of the Baltic Sea waters is a serious environmental problem, but also negatively affects the efficiency of maritime economy and the health of the population, the development of tourism, etc. One of the important sources of the Baltic Sea pollution is agriculture. The large amounts of nitrogen and phosphorus compounds from Poland to the Baltic come from drainage systems of agricultural land. In order to reduce these loads water from drainage systems is retained, among others, in water ponds on agricultural area. Besides the problem of water pollution, for the last 30 years water resources in Poland have been reduced mainly due to climate change. This phenomenon also occurs in the forests, so it is considered to retain the drainage outflow from agriculture area in the forests area. However, there is a fear whether the biogenic compounds contained in drainage waters will not harm the forest ecosystem. In order to verify this question, a pond was constructed in the forest for water from drained agricultural land. The quality of water flowing from farmland to pond as well as quality of groundwater at different distances from the reservoir was investigated. The paper presents the technical solution of the water retention system in the forest as well as the load of nitrogen and phosphorus compounds retained, which does not pollute the Baltic Sea. The results of research indicate that so far changes of groundwater quality in the vicinity of the pond don't threaten the forest ecosystem.

**Key words:** *Baltic Sea pollution, drainage outflow, water retention, forest*

### Introduction

The Baltic Sea is a receiver of heavily contaminated waters from the 14 surrounding countries. An especially large source of nitrogen and phosphorous pollution is the developed agriculture in these countries (Aeheimer, 2000, Banaszuk *et al.*, 2005). In order to improve the quality of waters in the Baltic Sea, various political, economic, and scientific activities are undertaken. It should be emphasized the role of the Helsinki Commission (HELCOM) in coordinating since 1974 the activities aimed at reducing pollution loads and improve water quality in the Baltic Sea. The various projects are being undertaken to promote a good water management practices in agriculture and in the forests such as projects within The Interreg Baltic Sea Region Program: Comprehensive Policy Actions and Investments in Sustainable Solutions in Agriculture in the Baltic Sea Region (Baltic COMPASS, 2009-2012) and Water Management in Baltic Forest (WAMBAF, 2016-2019). Poland, due to its size and population, belongs to the countries most polluting of this area (Ericsson, 2007). A large amount of nitrogen and phosphorus pollution from Poland comes from agricultural areas (Rauba, 2009). It is estimated (Behrendt *et al.*, 2005, Kowalkowski and Buszewski, 2006), that the share of chemical compounds in drainage outflow in the total load of pollution flows to the Baltic Sea is approximately 30% in the case of nitrogen and 4% in the case of phosphorus. Besides of the need to reduce the pollution load entering the Baltic, a significant problem of water

management in Poland is a decrease of water resources which has been observed for about 30 years. The main factor of this process is climate change, especially the rise of air temperature. Taking into account the problem of quality and quantity of water resources, attempts are made to retention of water from drainage systems in small ponds, reservoirs, etc. There is also a concept of retaining drainage water in forest areas where a water deficit is observed in many areas. However, there is a question if content of nitrogen and phosphorus in drainage outflow will cause harmful changes in the forest ecosystem. In order to verify this hypothesis, an investigation of the quality of drainage outflow from agricultural land retained in the reservoir located in the forest as well as the quality of groundwater in the vicinity of the reservoir were carried out. The paper presents the technical solution of the water retention system in the forest as well as the load of nitrogen and phosphorus compounds retained in the forest, which does not pollute the Baltic Sea.

### Material and Methods

The study was conducted on a water reservoir located in the Pultusk Forest District [Lat. (Dec.) 52.8810, Lon. (Dec.) 21.4962]. The reservoir was made in 2008. In the vicinity of the reservoir there are permeable soils: medium and fine sand, loamy sand and sandy loam. The outline of the pond surface is shown in the Figure 1. Water from a drainage systems which was made on about 1000 ha arable land is collected in the well (S1) and flows by a 225 mm diameter PVC pipeline into the reservoir. A flowmeter was installed in this well for measuring the amount of water flowing into the reservoir. The basic parameters of the pond are as follows:

- Surface of the reservoir: 1,25 ha,
- Pond capacity: 29600 m<sup>3</sup>,
- Maximum pond depth: 4,3 m.

Water gauge was mounted in the pond. Two transects of 8 observation wells with electronic devices were installed for determination of an impact of the pond on the changes in groundwater level and their physicochemical parameters (Figure 1). The quality of water flowing into the reservoir was analyzed at various dates from 2009. Groundwater quality was tested after 8 years of operation of the reservoir. Water samples for physicochemical analyzes were taken from wells once a month between December 2016 and June 2017.

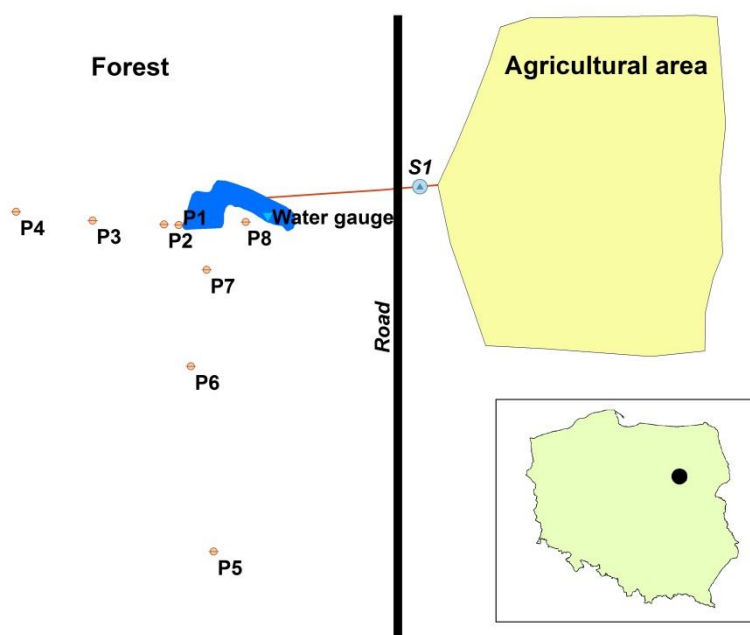


Figure 1. Scheme of research facility and location of observation wells.



Physicochemical properties of water probes were determined in the Laboratory of Environmental Chemistry, Forest Research Institute. The following methods were used to determine physicochemical parameters of water:

pH: potentiometry,

EC : conductivity,

Concentration of anions ( $\text{Cl}^-$ ,  $\text{NO}_3^-$ ,  $\text{SO}_4^{2-}$ ,  $\text{PO}_4^{3-}$ ): ion chromatography,

Concentration of ammonium  $\text{NH}_4^+$ : ion chromatography,

Total concentration of bound nitrogen (TNb): chemiluminescence.

## Results and Discussion

The volume of water which flowed from drainage system into the pond in the period from 21 March to 27 June 2017 amounted to  $96000 \text{ m}^3$ . This means that due to the infiltration of water through the bottom of the pond, three times more water was retained than its capacity. The decrease of the water level due to the infiltration was 3-5 cm per day. Rainfall in this period was 146 mm. The range of impact of the reservoir on the level of groundwater retention can be estimated at 300-400m. Figure 2 shows the results of the measurements of March 21, 2017 in transect II when the water level in the reservoir was 95,40 m. asl.

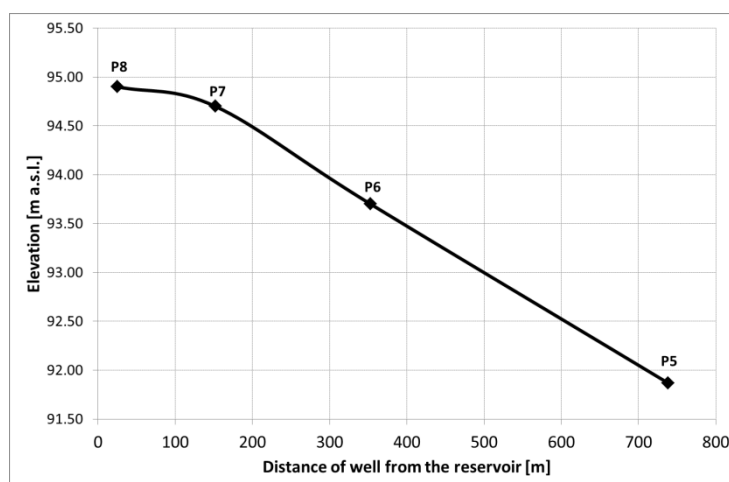


Figure 2. Groundwater level in observation wells - transect II.

The characteristic feature of drainage outflow is the high concentration of nitrogen compounds. The concentration of different forms of nitrogen in water flowing into reservoir as well as in the groundwater is given in Table 1. The quality of water flowing into the pond was studied in 2009-2012 (Pierzgalski *et al.*, 2012). It was then found that the quality of water was reduced mainly due to too high concentrations of total bound nitrogen, nitrate nitrogen and ammonium nitrate. The range of variation of nitrogen compounds was quite significant and was at:

- TNb:  $0,62-10,89 \text{ [mg}\cdot\text{dm}^{-3}]$ ,

N- $\text{NO}_3$ :  $2,51-7,44 \text{ [mg}\cdot\text{dm}^{-3}]$ ,

N- $\text{NH}_4$ :  $0,27-1,29 \text{ [mg}\cdot\text{dm}^{-3}]$ .

Comparing these ranges of variation with the results given in Table 1 (well S1) can be concluded that they are comparable. Taking into account the limit of pollutants for I and II of water classes of  $5,0-10,0 \text{ [mg}\cdot\text{dm}^{-3}]$  for TNb,  $2,2-5,0$  for N- $\text{NO}_3$ , and  $0,78-1,56$  for N- $\text{NH}_4$  respectively, it can be stated that only for N- $\text{NH}_4$  they were not exceeded.

Table 1. Concentration of total bound nitrogen, nitrate nitrogen and ammonium nitrate in water from drainage system and in groundwater at different distances from the pond

Name of well	Distance of well from the reservoir [m]	Total bound nitrogen TNb [ $\text{mg}\cdot\text{dm}^{-3}$ ]		Nitrate nitrogen N-NO <sub>3</sub> [ $\text{mg}\cdot\text{dm}^{-3}$ ]		Ammonium nitrate N-NH <sub>4</sub> [ $\text{mg}\cdot\text{dm}^{-3}$ ]	
		min. –max.	average	min. –max.	average	min. –max.	average
S1	0	3,03 – 10,16	5,80	2,49 – 7,40	4,99	0,07 – 0,25	0,13
I transect							
P1	10	5,30 – 8,28	5,78	4,84 – 7,78	6,50	0,06 – 0,47	0,20
P2	45	5,86 – 8,49	7,09	5,22 – 7,90	6,51	0,06 – 0,30	0,19
P3	192	0,33 – 1,81	0,61	0,08 – 1,71	0,58	0,06 – 0,10	0,06
P4	350	0,31 – 0,40	0,36	0,12 – 0,27	0,20	0,02 – 0,06	0,03
II transect							
P8	20	5,56 – 7,69	6,39	4,71 – 9,75	6,47	0,04 – 0,10	0,05
P7	152	3,77 – 7,60	6,20	3,66 – 7,14	5,80	0,01 – 0,09	0,06
P6	353	1,20 – 2,09	1,48	1,07 – 1,74	1,31	0,01 – 0,09	0,04
P5	738	1,97 – 4,99	3,59	1,02 – 3,17	2,22	0,27 – 0,58	0,37

The drawings 3, 4, 5 present changes in the analyzed parameters depending on the distance from the pond. In the case of TNb it can be stated that the range of impact of the reservoir is about 100-150 m in transect I and about 200-250 m in transect II. It should also be noted that in the well P5 located 750 m away from the pond TNb value increased, which can be explained by the influence of pollution not from the pond. Similar dependencies can also be seen for N-NO<sub>3</sub> and for N-NH<sub>4</sub>.

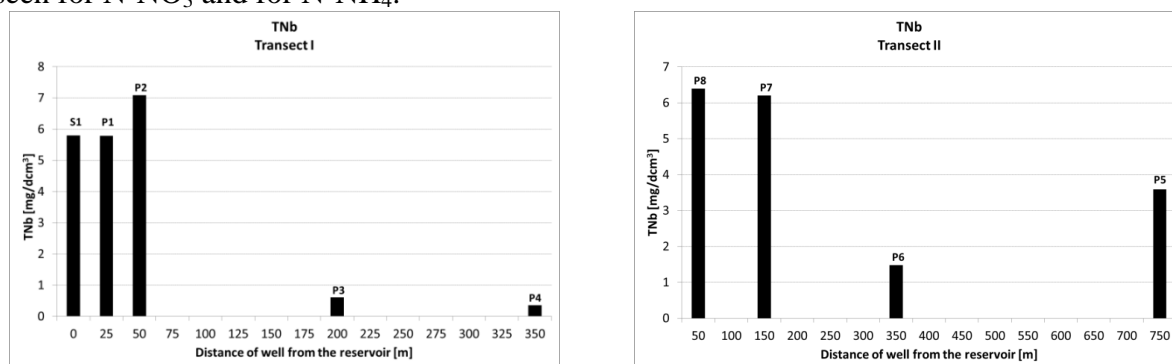


Figure 3. Concentration of total bound nitrogen in groundwater depending on the distance from the pond.

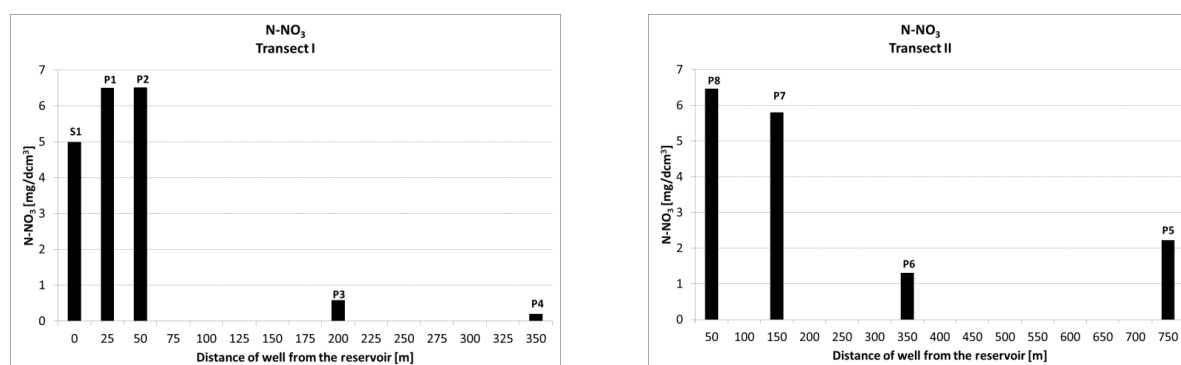


Figure 4. Concentration of nitrate nitrogen in groundwater depending on the distance from the pond.

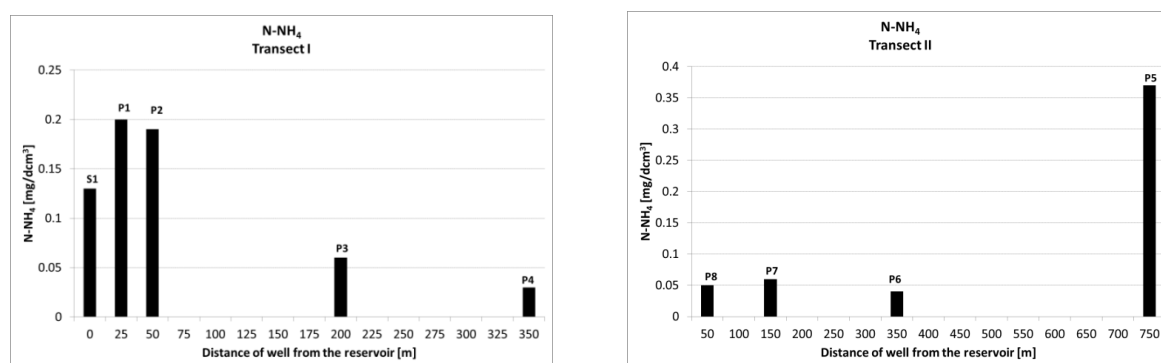


Figure 5. Concentration of Ammonium nitrate in groundwater depending on the distance from the pond.

Taking into account the average concentration of TNb and the volume of water flowing into reservoir, it can be stated that about 560 kg of nitrogen was retained in the forest area in the period from March to June 2017. Phosphorus compounds in the drainage outflow are much less than load of the nitrogen, but it is a main factor causing water eutrophication. Table 2 shows the concentration of phosphates in water samples taken from the same sites as for nitrogen compounds.

Table 2. Concentration of phosphates in water from drainage system, and in groundwater at different distances from the pond

Name of well	Distance of well from the reservoir [m]	P-PO <sub>4</sub> [mg·dm <sup>-3</sup> ]	
		min. – max.	average
S1	0	0,0 - 0,07	0,03
I transect			
P1	10	0,0 - 0,02	0,01
P2	45	0,0 - 0,08	0,05
P3	192	0,0 - 0,04	0,02
P4	350	0,0 - 0,04	0,01
II transect			
P8	20	0,0 - 0,04	0,02
P7	152	0,0 - 0,16	0,01
P6	353	0,0 - 0,08	0,04
P5	738	0,0 - 0,05	0,01

The results show that the concentration of phosphate was very low both in drainage water and in groundwater. The reason for this is the low mobility of phosphorus, especially in mineral soils. These results confirm the information given in the literature (Behrendt *et al.*, 2005, Kowalkowski and Buszewski, 2006), according to which from Poland to the Baltic in the drainage ditch there is more than 100 times more nitrogen than phosphorus. Analysis of phosphate content in groundwater does not indicate their correlation with the distance of wells from the reservoir.

### Conclusions

The purpose of the study was to determine the impact of the retaining the drainage outflow from agricultural areas in reservoir located in the forest. The influence of the reservoir on the increase of water resources and on the content of nitrogen and phosphorus compounds in

groundwater in the vicinity of the reservoir were assessed. The volume of drainage outflow which flowed into the pond in the period from 21 March to 27 June 2017 amounted to 96000 m<sup>3</sup>, which is three times that capacity of the reservoir. Due to the high permeability of the pond bottom the ground water was raised on the area from 400 to 500 m. from the pond improving the water conditions of the forest habitats. Analysis of groundwater quality leads to the conclusion that there is relationship between the content of nitrogen compounds in the outflow of the drainage and in the groundwater to a distance of 400 to 500 m from reservoir. On the other hand, the phosphate content of both drainage and groundwater was low. There wasn't also relationship between the phosphate content of groundwater and the distance from the reservoir. The obtained results indicate that during the 9 years of operation of the reservoir there have been no changes threatening the forest ecosystem. The solution applied is assessed positively in terms of improvement of local water resources and positive influence on the quality of flowing into the Baltic Sea.

### **Acknowledgements**

This paper was made within the project "Water management in the Baltic forests" (WAMBAF) financed by European Regional Development Fund - Interreg Baltic Sea Region.

### **References**

- Aeheimer B, Liden R. (2000). Nitrogen and phosphorus concentration from agricultural catchments – influence of spatial and temporal value. *Journal of Hydrology*, 227:140-159.
- Banaszuk P., Wysocka Czubaszek A., Kondratiuk P. (2005). Spatial and temporal of groundwater chemistry in the river riparian zone. *Agriculture, Ecosystems and Environment*. 107: 167-179.
- Behrendt H., Opitz D., Korol R., Strońska M. (2005). Changes of the nutrient loads of the Odra River during the last century – their causes and consequences. *ICID 21st European Regional Conference*, p.9.
- Ericsson H., Pastuszak M., Lofgren S., Morth C.M., Humborg C. (2007). Nitrogen budget of the Polish agriculture 1960-2000 – Implication for riverine nitrogen loads to the Baltic sea, *Biogeochemistry*. 77: 265-281.
- Kowalkowski T. and Buszewski B. (2006). Emission of nitrogen and phosphorus in Polish rivers: past, present and future in the Vistula River catchment. *Environmental Engineering Science*, 23(4): 615-622.
- Pierzgalski E. et al. (2012). Impact assessment of small retention objects in lowland forest on changes in forest ecosystems and mitigation of threat drought. *Forest Research Institute*. pp.187, (in Polish).
- Rauba M. (2009). The content of nitrogen and phosphorus compounds into groundwaters of catchment area used agriculturally for example river Ślina. *Ochrona Środowiska i Zasobów Naturalnych*, 40:505-511 (in Polish).

## THE VULNERABILITY TO CLIMATE CHANGES OF PINE FOREST CULTURES FROM OUTSIDE THEIR NATURAL RANGE

Cristinel CONSTANDACHE\*, Lucian DINCĂ, Nicu Constantin TUDOSE

National Institute of Research and Development in Forestry "Marin Drăcea" – Romania

\*Corresponding author: cicon66@yahoo.com

### Abstract

The pine forest cultures installed outside their areal are exposed to the action of some harmful abiotic factors (drought, wind, snow), being rather vulnerable and sometimes suffering from important assaults, so that their ecological reconstruction is a necessity. The pine cultures from outside the areal were realized starting with the year 1972, by replacing some derived stands (linden stands, hornbeam stands etc.) or low productivity *Quercus* stands. They were intended for the production of colophon, but also for wood production. During their evolution, in the absence of a guiding scientific substantiation, the risk that these stands should be harmed by the action of harmful factors before they reach the intended cycle has increased. In order to substantiate the ecological reconstruction methods of the affected ecosystems, the monitoring/evaluation and their structural-functional analysis are necessary. The current paper presents the results of the investigations regarding the structure (structural parameters and structural diversity) of some pine stands situated in the forest steppe area from the East part of Romania. Analysis of the structure of the stands is very important for determining the stand's degree of assault and vulnerability, regarding which urgencies and methods of restoration can be established. In order to establish the ecological reconstruction solutions, experiments have been realized in different situations. The reconstruction of pine stands from outside their natural range is extremely important for preventing the environment's degradation risks and for achieving the protection or production functions of these stands.

**Keywords:** *pine cultures, natural range, vulnerability, abiotic factors.*

### Introduction

Pine forest cultures installed outside their areal are occupying important surfaces and are also exposed to certain risk factors (drought, wind, snow, anthropic factors). They can be sometimes really vulnerable and, as such, can suffer important damages (drying, breaks/windfalls etc.) (Allen et al., 2010; Dobbertin et al., 2007; Oberhuber, W., 2001). The last years have witnessed an alarming evolution of the drying phenomenon for pine stands situated outside their natural areal. For example, in the year 2015, the surface of pine stands affected by drought was of 3427 ha (MMAP report, 2015), which represents approximately 5% of the surface of pine stands installed outside their areal in Romania. Accomplishing the protection functions depends on the state/structure of protection forest cultures, so that the ecological reconstruction of the stands affected by harmful factors is a necessity. These cultures were realized starting with the year 1972 and were intended for the production of cellulose wood (spruce) or for the production of colophon (pine).

The pine cultures were installed in the place of some stands that had a low productivity (IV and V) or derived (linden stands, hornbeam stands, etc., Arhip, 1998). Extending the pine cultures was realized as follows (Barbu, 2004):

- Scots pine, replacing low productivity beech and holm stands;  
 - black pine, replacing many degraded and inferior productivity holm, oak, etc. stands;  
 Both species were also frequently used for the afforestation of degraded fields (Constandache *et al.*, 2015).

During the evolution of resinous cultures outside the areal and in the absence of a leading scientific substantiation, the risk of harming them by perturbation factors before they can reach an optimal age has appeared and amplified. Some of the mentioned stands were strongly affected during their prime by wind or snow falls and breaks. On the other side, the drought from the last years has significantly aggravated the situation of resinous cultures from outside their natural areal. As such, the drying phenomenon was signaled on more and more surfaces. The resinous cultures from outside their areal (pure pine or spruce plantations) are inferior from a functional point of view to the ones substituted by local species. The excessive artificial phenomenon of forest regenerations has created a paradoxical discrepancy between the site diversity and their multifunctional efficiency. Monocultures of spruce, pure pine or mixtures between them were created and endowed with an immense potential for ecological instability. Their state was further aggravated by the fact that they are not followed up by maintenance works necessary for strengthening their resistance towards adversities (wind, snow, rime etc.) (Barbu, 2004; Constandache *et al.*, 2015). The climatic changes from the last years are leading towards an increase of their harming risks and for the degradation of the environment through the conjugated action of some harmful agents. As such, monitoring the stands and quantifying their ecological impact on the environment in order to substantiate the ecological reconstruction methods for the affected ecosystems is a necessity.

### Materials and methods

In order to achieve the proposed objectives, measurements and field observations were realized, together with processing and analyzing statistically the data. Taking into consideration the complexity of the studied phenomenon and the intended objectives, pine stands situated in areas with different site conditions from the East part of Romania were chosen.

Table 1. Location and general characteristics of the analyzed stands

Forest District	U.P	u.a.	Surface (ha)	Stand composition*	Age (years)
Galați	II Rareș	40B	4,87	10Pin	41
	III Zărnești	8A	24,02	6Pin 3Fr 1Sc	36
Grivița	II Cobana	32A	11,0	9Pin 1Dt	38
		70A	3,5	9Pin 1Dt	38
	V Berești	53B	3,8	10Pin	38
H. Conachi	II Bălțatu	17 A	5,59	10 Pin	35
Tecuci	VI Drăgănești	30B	3,8	9Pin 1Pam	43
	VI Drăgănești	29D	4,2	10Pin	38
	V Munteni	46B	7,9	10Pin	33
Bacău	IV Gioseni	37 A	21,7	9 Pi 1 Dt	35-40
Podu Iloaiei	II Brăiești	3C	10,2	10Pi.n (Pi)	40
		119B	33,7	4Pi.n 3Sc3Mj	35
Iași	III Roșcani	61 H	1,54	8 Pi 2 Sc	40
Rm. Sărat	I Călnău	81G	5,3	10 Pi	44
BE Vidra	I Bolotești	162	9,1	9Pi1Dt	40

\*) Pin = black pine; Pi = scots pine; Sc=locust; Fr=ash; Pam=sycamore; Mj=flowering ash; Dt= different species

In order to emphasize the structural characteristics of stands, an analysis of the experimental distribution of the main biometric parameters of trees was realized by theoretic distribution functions (normal, beta) that correspond to the horizontal structure. Another analysis method for stand structure was represented by analyzing the correlations between different qualitative and quantitative characteristics through general statistical methods. Studying the quality of stands from degraded lands and establishing some dependency links between different qualitative and quantitative characteristics has also implied the usage of structure analysis in regard with stational conditions. In regard with the harmful degree, the evaluation was realized based on the evaluation methodology of forest's health state. The intensity of tree damage based on the crown's defoliation percentage was realized in accordance with the methodology adopted at European level. As such, 0 defoliation class (0-10%)- healthy tree; 1<sup>st</sup> defoliation class (11%-25%) – weakly damaged tree; 2<sup>nd</sup> defoliation class (26%-60%) – moderately damaged tree; 3<sup>d</sup> defoliation class (61%-99%) – strongly damaged tree; 4<sup>th</sup> defoliation class (100%) – dead tree.

The structural diversity analysis was realized with the help of Shannon index, while the Camino and Gini indexes were used for testing structural homogeneity under the report of basis surface.

### Results and discussion

From a phito-climatic point of view, pine stands from outside their areal are situated in forest steppe areas and *Quercus* floors, areas frequently reported for damages caused by drought (exsiccation), wind, storms or snow (breaks). The terrains on which these stands are vegetating are different both as altitude, slope aspect, inclination, configuration, as well as with regard with pedological conditions.

Fields with pine stands are situated in the following types of forest sites:

-normal field stations (unaffected by degradations) from the external forest steppe area (with soft or brown oak), with chernozem soils on loess materials and other clays; *Quercus* and oak stands with luvisol soil types;

-degraded field stations from the same areas: external forest steppe, floors of *Quercus* with oak (on strongly eroded slopes) or *Quercus* with holm, Hungarian oak, Turkish oak, with small edaphic podzol soils.

All these characteristics were analyzed with the purpose of emphasizing the factors that determine the behavior and evolution of pine stands in regard with harmful factors. The structure analysis for pine stands from outside the areal has followed the composition, consistency, biometric characteristics and so on. The majority of analyzed pine stands have an age of 35-40 years. The biometric conditions are differentiated in regard with the specie and site conditions (lower sizer in harsher conditions). As such, the average diameter has values between 12.2 and 18.5 cm for the black pine and between 14.9-24.4 cm for the Scots pine. The average height varies between 9.5 and 13.1 m for the black pine and 10.3-18.7 m for the Scots pine. By analyzing the composition of stands, it has resulted that approximately 25% of these are pure pine stands (predominantly black pine), 60% are mixture stands with up to 30% mixture species, while the difference (15%) is represented by black pine stands mixed with broad-leaved species (with over 30% mixture broad-leaved species). As for the number of disseminated species (under 10%), two up to four disseminated broad-leaved species were identified. Their origin comes from the natural regeneration (sprouts, suckers) of replaces species.

In regard with the stand's state (consistency, number of trees/ha), they are thinned in most cases (consistency: 0.5-0.6), with a low number of trees as result of previously realized works

(that have extracted trees affected by drought). In certain situations, different species of mixture broad-leaved were naturally installed and are completing the consistency of thinned pine stands. The stand's structural diversity analysis has proved that most stands have a low variability, indicated by a value of <25% of the variation's coefficient. The maximum recorded value is of 49.1% (pine and locust mixture), while the minimum value is of 11.27% (pure Scots pine stand). The optimal values for this parameter are situated between 25 and 35% and are represented by stands composed of broad-leaved species in a percentage of 10-30% (Galați 40 B, Vidra 162, Podu Iloaiei 3C, Tecuci 30B – table 1). This aspect emphasizes the fact that the broad-leaved species that have appeared in the composition of pine stands from outside their areal are positively influencing the value of the mentioned statistic parameter. The pronounced variability (49.14%) highlights an atypical structure, which indicates an inappropriate mixture (pine and locust) that is especially used in the afforestation of degraded lands (Lukić *et al.*, 2016). The analysis of tree distribution on diameter categories is in a direct relation with the number of species from the stand's composition. As such, the stand distribution on diameter categories is realized in accordance with the normal theoretical distribution, in the situations in which the presence of other species was not registered, but only of those initially used for creating the cultures (pure stands). For the case in which the presence of more species (naturally regenerated) is noted, the tendency of by-levels (multiple levels) is evident. This is the consequence of the appearance of a new vegetation level composed of local species from the forest subarea in which the forest pine cultures were installed. The structural diversity is oriented towards the grouping of individuals in space, their functional reports and dimension variability, emphasizing the stability and capacity of stands with different compositions for adapting at stational conditions. Analyzing the structure and diversity of pine stands, expressed through the value of the average diameter variation coefficient, emphasizes the low variability of pure Scots pine and black pine stands. This denotes the low diversity and high vulnerability of these stands in regard with harmful factors. Although the Scots pine has achieved larger dimensions (diameter, height) than the black pine in the same site conditions, it has also suffered damages (breaks, drought), which has led to the reduction of tree consistency and thickness. These aspects are also emphasized by the real number of trees, which is in most situations lower with 35-76% than the normal number of trees (according to biometric tables). Furthermore, in the pine stands where the consistency was much reduced, namely the number of trees affected by damages, special conditions for installing/developing local broad-leaved species and substands are created. This leads to a structural and ecological diversity of the stands. The structural diversity indexes (Gini, Camino, Lorent) calculated for the analyzed stands are showing an accentuated homogeneity for pure stands. In the case of mixture stands, the low homogeneity expresses their diversification tendency. It is also observed the aberration of Lorent curve for the mixture stands in comparison with the pure or almost pure stands, which indicates the growing diversity and complexity of the stands, favoring their stability and natural regeneration. In most cases, the diversification is caused by mixture broad-leaved species (naturally regenerated and which form an inferior level). The higher diversity of pine stands in mixture with broad-leaves expresses a higher stability, the stand's capacity for adapting at site conditions and also their capacity for natural regeneration and ensuring protection functions. By analyzing the damage degree of pine stands it can be observed that the percentage of damaged trees (affected by drought in a percentage of over 25%) is over 50% for most analyzed situations and can reach even 75-77%. The larger percentage of damaged trees is observed in most stands situated in the forest steppe areas in which extraction works were not realized. The percentage of dry trees is also different, depending on the works previously realized and is frequently situated between 10



and 25% (Figure 1). An exception is recorded for the stands in which the extraction works of damaged trees were realized recently and had a lower consistency.

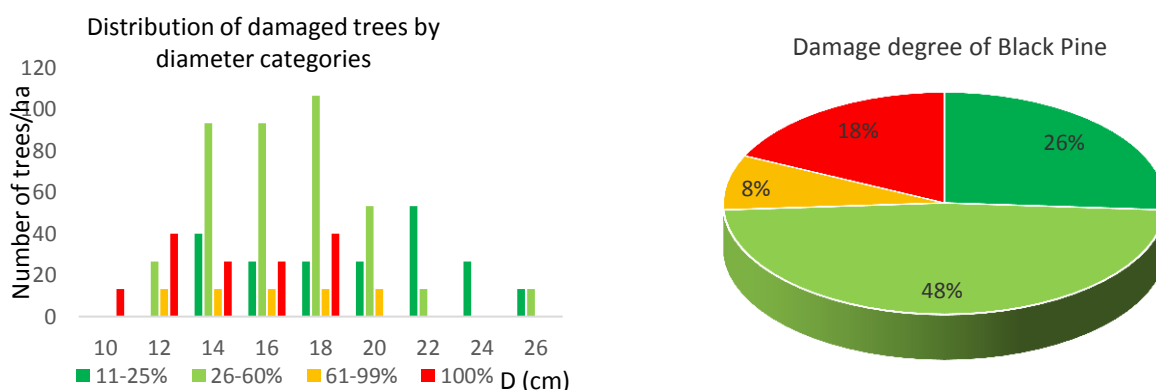


Fig. 1. Characteristics of damages (Forest district Galați, UP III Zărnești, u.a. 8A)

Decreasing the stand's consistency is accompanied by an overall reduction of structural heterogeneity (which means a higher structural homogeneity), expressed through the Camino homogeneity index. This, through the value interval gathered between 2.43 and 12.34, indicates the stands that have an equine to relatively equine structure. As a consequence of reducing the structural variability of biometric elements (diameter/basis surface) together with the aging of Scots/black pine after extracting the damaged trees, they have reacted by an increase in structural diversity even in accentuated degraded land conditions, by installing/regenerating some broad-leaved species either from the old stand or from the nearby ones. This diversity had as effect in the recovery of the dynamic equilibrium which was affected by previous interventions. In order to sustain the above mentioned facts, the Gini index was calculated. Its values (0.121-0.495) are confirming the affirmations mentioned above. In order to determine future interventions in the management of pine stands situated outside the areal, the evaluation of stand vulnerability and their adaptation capacity is necessary. The evaluation can be realized based on the analysis of ecosystem states under the report of composition, structural complexity, age etc. in regard with site conditions. The vulnerability can be calculated as a product of exposure to climatic changes (Ex) and stand sensitivity (Sz), (Barbu *et al.*, 2016). The exposure to climatic changes (Ex) will be appreciated in regard with the phito-climatic area (altitude) and pedostational conditions (relief, soil). The structural parameters that have to be taken into account in order to estimate the sensitivity (Sz) are: composition, consistency, age and vertical structure. In regard with the urgency of applying ecological reconstruction works in affected stands, tree situations were differentiated based on the damage degree. Each implies different methods/urgencies for applying the works.

### Conclusions

Pine stands from outside their areal are situated in forest steppe areas and *Quercus* vegetation floors from fields with different site conditions where they were introduced for the substitution of degraded trees (generally *Quercus*) or derived (linden, hornbeam), as well as on fields with more difficult site conditions (degraded).

In most part, pine forest cultures have an age between 35 and 45 years; their biometric characteristics are correlated with the phito-climatic floor and site conditions of fields, emphasizing the sensibility of these species in the forest steppe, on degraded lands.

In 75% of the analyzed situations it was observed the presence of broad-leaved species naturally regenerated (originated from the old substituted stands), which have an important role in ensuring the consistency and structural diversity of pine cultures; the higher diversity of pine stands in mixture with broad-leaves expresses a higher stability, their capacity for adapting and site conditions as well as their natural regeneration capacity.

The pine cultures from outside the areal have suffered damages caused by drying, especially after the age of 35 and predominantly in the forest steppe area. Through silvotechnical works, the strongly damaged trees (over 60%) were extracted, so that the number of trees and the consistency were significantly reduced.

The intervention urgencies with ecological reconstruction works are established in regard with the stand's structure and the degree of damage. However, establishing the ecological reconstruction solutions is hard and implies differentiated solutions and techniques based on the site conditions as well as the characteristics of the affected stands.

Evaluating the vulnerability of pine stands from outside their areal is necessary in the conditions of climate changes in order to know the stand's direction of evolution and to prioritize future interventions for leading and regenerating pine stands.

### **References**

- Allen, D., Macalady, A.K., Chenchouni, H., Bachelet, Mcdowell, N., et al., 2010, A global overview of drought and heat-induced tree mortality reveals emerging climate change risks for forests. *Forest Ecology and Management*, Elsevier, 259 (4), pp. 660–684.
- Arhip, C., 1998, Awareness about resinous cultures realized outside their natural vegetation areal and which can be managed and exploited in order to produce wood for celluloses, *Bucovina Forestiera* 6(1-2), pp 47-48.
- Barbu, I., 2004, The management of resinous cultures installed outside their areal, „Ștefan cel Mare” University Annals Suceava nr. 1/2004, pp 37-70;
- Barbu, I., Barbu, Cătălina, Curcă, M., Ichim, V., 2016, Adapting Romania's forests towards climatic changes, Ed. *Silvica*, 379 pag.
- Constandache, C., Vlad, R., Popovici, L., Crivăț, M., 2015, Status of the forest cultures with resinous (pine) species from degraded lands and forest steppe areas, *Revista Padurilor*, 130/2015, nr. 3-4, pp. 3-12
- Dobbertin, M., Wermelinger, B., Bigler, C., Buergi, M., Carron, M., Forster, B., Gimmi, U., Rigling, A., 2007, Linking increasing drought stress to Scots pine mortality and bark beetle infestations. *The Scientific World Journal* 7, pp. 231–239.
- Lukić, S., Pantić, D., Simić, S.B., Borota, D., Tubić, B., Djukić, M., Djunisijević-Bojović, D., 2016. Effects of black locust and black pine on extremely degraded sites 60 years after afforestation - a case study of the Grdelica Gorge (southeastern Serbia). *iForest - Biogeosciences & Forestry*, Vol. 9 Issue 2: 1-9.
- Oberhuber, W., 2001. The role of climate in the mortality of Scots pine (*Pinus sylvestris* L.) exposed to soil dryness. *Dendrochronologia* 19, pp. 45–55.

## **PAULOWNIA SPP. AND TRUFFLES (*TUBER* SPP.) PLANTATIONS IN ROMANIA**

Lucian DINCĂ, Diana VASILE, Vlad CRIȘAN

National Institute of Research and Development in Forestry “Marin Drăcea” – Brașov, Romania

\*Corresponding author: dinka.lucian@gmail.com

### **Abstract**

The agroforestry systems that use this type of plantations have important social and ecological value and represent a direct contribution to rural economies. From this point of view, the plantations with *Paulownia* spp. or another one trees for truffle productions represent a good opportunity for some countries that present a surplus of surfaces that are not covered with agricultural or forest cultures as is the case of Romania. This article's main objective was to analyse the evolution of *Paulownia* plantations and of seedlings inoculated with truffles from Romania during the last years. In order to achieve this objective, 6 *Paulownia* plantations and 2 truffle plantations were studied. The investigations carried out prove the fact that the realization of cultures for wood (*Paulownia* spp.) or for the production of truffles can be achieved in good conditions only if the ecological requests of the plants and the site conditions of future cultures are taken into consideration. Unfavorable results were obtained for the *Paulownia* plantations due to frosts from higher altitudes (where the culture of this species is not recommended for the future) or due to some technical mistakes (cutting too strongly the roots, not removing the weeds). However, the two types of cultures are recommended for usage in the future (only in proper site conditions) as they bring numerous advantages to field owners (primarily financial, but also ecological).

**Keywords:** *Agroforestry, afforestation, Paulownia spp., truffles.*

### **Introduction**

The agroforestry system can be defined as an important land management system which realizes increases of the land efficiency, that combines the production of tree crops and forest plants on the same unit, and which applies management practices that are suitable with the cultural practices of the local population. Also, the agroforestry practices maintain watershed functions, retain the carbon in the plant-soil system, and support the conservation of biological diversity by increasing levels of wild biodiversity on farmland. In Europe there are six agro-forestry practices, namely: silvo-arable agro-forestry, forest farming, riparian buffer strips, improved fallow, multipurpose trees and silvo-pasture (Mosquera-Losada et al. 2009). *Paulownia* spp. and truffles plantations in Romania are two of the six agro-forestry practices from Europe. They belong to the “improved fallow” practice, which represents fast growing woody species that improve soil fertility and may yield economic products. *Paulownia* plants have fast growth and can produce as much biomass in one year as other species in several years. The trees grow much faster than other tree species, reaching large sizes in 6-9 years. Another advantage is that after harvesting, the plantation does not need replanting, because new trees grow from the stumps. *Paulownia* spp. wood is very light, with densities around 0.300 g/cm<sup>3</sup> (Akyildiz & Kol, 2010; Kiaei, 2012) and for this reason is used for making musical instruments, boxes, chests, lightweight skis, furniture, doors and windows (Clapa et al., 2014). *Paulownia elongata* S.Y. Hu and *Paulownia fortunei* Hemsl belong to the family of *Bignoniaceae* and this species are mostly grown on plantations. Sometimes, in agroforestry

systems, they are planted with agricultural cultures (Knezevic et al., 2009). By cultivating *Paulownia* spp., the soils are becoming very rich, because the root distribution results in more efficient use of water and other limited resources. Furthermore, the plantations are very efficient in afforestation and protection of soil against erosion (Wang & Shogren, 2003).

Truffle plantations belong to the “multipurpose trees” category, which represents: trees randomly or systematically planted in cropland or pasture for the purpose of providing fruit, fuel wood, fodder and timber on farms and rangelands. Truffles belong to diverse groups of both *Ascomycetes* (spore sac fungi) and *Basidiomycetes* and are forming macro fungi underground (hypogeous) fruit bodies. A lot of truffle species live in ectomycorrhizal association with various trees and shrubs. Some species of the genus *Tuber* are very appreciated as delicacies. One of these species is the black Burgundy truffle (*Tuber aestivum* Vitt.) (Weden et al., 2009). In this paper, we use the older name *Tuber aestivum*, because *T. uncinatum* Chat. is a synonym for *T. aestivum* (Paolocci et al., 2004; Weden, 2004; Weden et al., 2005). *Tuber aestivum* Vitt. forms ectomycorrhizal with oak (*Quercus* spp.), beech (*Fagus sylvatica* L.), hornbeam (*Carpinus betulus* L.), linden (*Tilia* spp.) and hazel (*Corylus* spp.) (Chevalier & Frochot, 1997a). The development of cultivation of *T. aestivum* first took place in France and Italy (Chevalier & Frochot, 1987, 1989, 1997b, 2002; Giovanetti et al., 1994; Belloli et al., 2001). The first truffles were produced in 1976 in Italy (*T. melanosporum* Vittad.) in a truffle orchard (truffiere) of inoculated seedlings, 6 years after planting, while in France the first truffles were produced in 1977 (*T. melanosporum*) from inoculated seedlings, 3.5 years after planting (Chevalier & Grente, 1979). By contact with germinating spores, mycelia or mycorrhizae, roots of an ectomycorrhizae forming tree can be inoculated with an ectomycorrhizal fungus. The entire plant or pieces of a root system with mycorrhizae can be put together with the seedlings to be inoculated (Chevalier & Grente, 1973; Chira D. & Chira F., 2012) and on the new seedlings the mycorrhizae may develop within 2 or 3 months. This method is applicable to many *Tuber* species (Giovanetti et al., 1994).

### Material and Methods

In this paper, 6 *Paulownia* plantations and 2 truffle plantations from Romania were analyzed. The *Paulownia* plantations were realized with hybrids obtained by crossing *Paulownia elongata* (S. Y. Hu) and *P. fortunei* (Hemsl.): *Paulownia* clona in Vitro 112® and *Paulownia* Cotevisa 2. The 6 analyzed plantations were: 1. Cataloi (Tulcea County): a culture of 3 years, planted in the spring of 2013 on a surface of 1.4 ha; 2. Arpaş (Sibiu County): a culture of 3 years, planted in the spring of 2011, on a surface of 1 ha; 3. Hetiur (Mureş County): a culture of 4 years, planted in the spring of 2012 on a surface of 5 ha; 4. Jucu (Cluj County): a culture of 2 years, planted in the spring of 2012 on a surface of 2.5 ha; 5. Mihaesti (Arges County), a culture of 2 years, planted in 2015 on a surface of 0.5 ha; 6. Baraganu (Calarasi County), a culture of 2 years, planted in 2015 on a surface of 0.6 ha.

Trees were planted at the beginning of spring. Special treatments were not necessary before the plantation. A southern facing exposure with some protection from wind was preferred. Furthermore, young trees were protected from grazing animals, as animals tend to feed on the bark, damaging the trees and limiting the growth. The site was pre-irrigated to moisten the soil and to reduce the amount of labor required. Holes were dug at 5 m x 4 m or 5 m x 3 m, providing 500-700 trees per ha. The holes were of 70-80 cm on each side and 50-60 cm deep. After planting, 15-20 cm of soil was heaped around the sapling. *Paulownia* spp. is very tolerant of adverse soil conditions, but is very sensitive at waterlogging, requiring good drainage, needing between 500 mm and 2600 mm of rainfall annually. Therefore, saplings were irrigated on the day they were planted and again a few days later. For the first year, it was necessary to practice weeding, such that weeds do not overgrow the young trees.

In Romania, 2 truffle species are spread naturally: *Tuber aestivum* Vitt. and *T. magnatum* Pico and are harvested in important quantities in the country's forest areas (Dincă M. & Dincă L., 2012). The two realized truffle plantations are: a pedunculated oak (*Quercus robur*, L.) plantation of 3 years, 2 year Turkey oak (*Quercus cerris*, L.), 2 year sessile oak (*Quercus petraea*, Liebl.), 2 year hazel (*Corylus avellana*, L.), and 2 year Turkish hazel (*Corylus colurna*, L.) (originally from Hungary), inoculated with *Tuber aestivum* at Prejmer plantation and one with Turkey oak seedlings (originated from Italy) replaced with *Tuber melanosporum* at Moldova Noua (Figure 1). Truffle cultivation needs a detailed study of the site, which includes soil physical-chemical analysis, climate, topography, vegetation, etc., and also pre-and post-plantation farming operations, fundamental for successful production of fruiting bodies (Bencivenga & Baciarelli Falini, 2012). Generally, well-drained calcareous soils are preferred, with alkaline pH between 7.5 and 8.0, medium humus content and good aeration (Granetti *et al.*, 2005). It should be considered that fruiting bodies of truffles are vulnerable and damaged by extreme temperatures and dry conditions (Trappe *et al.*, 2009). Also, it was taken into account that *T. melanosporum* prefers permeable soils, never saturated with water and well heated by sun rays, while *T. aestivum* tolerates soils with neutral pH values. Both species are cultivated with equal success in a broader range of hosts and habitats (Danesh, 2015).

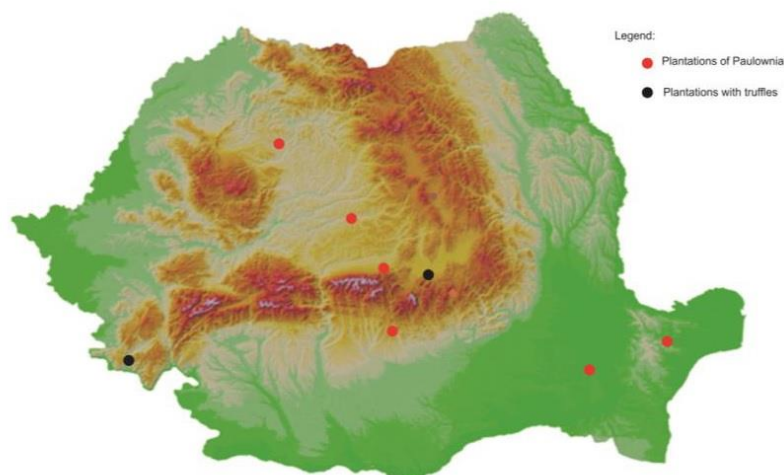


Figure 1. The repartition of *Paulownia* spp. and truffle plantations in Romania

## Results and Discussion

*Paulownia* plantations: if the correlation between the specie's ecological conditions and the site are taken into account, and if the creation and maintenance works are properly applied, these plantations (exemplified by Jucu and Baraganu plantations) present a good growth. The unsuccessful plantations (Hetiur, Arpaş) are caused by inappropriate climatic or edaphic conditions and technical mistakes (cutting too strongly the roots, not removing the weeds). The losses caused by frosts are higher at Mihaesti and Arpas, where over half of the seedling's height was affected by this phenomenon. The plantation from Hetiur was completely compromised because: the inadequate planting location (an area renowned for its unproductive fields, with a very weak soil) and due to excessive cuttings of the seedling's roots (obtained through cuttings, imported from Spain and contained too long before planting in inappropriate conditions). The plantation from Arpas was also compromised due to low

temperatures from the area and by not removing on time the herbaceous vegetation that can sometimes completely cover the *Paulownia* seedlings.

In non-warming greenhouse and outdoors condition at 800 m elevation in Kastamonu, Turkey in 2002 were used one-year old seedlings, which were propagated from seeds of 16 origins of *P. tomentosa*, *P. elongata*, *P. fortunei* and *P. fortunei* x *tomentosa* obtained from China (Anonymous 1998) - there were large differences among the origins within the species for seedling height and root collar diameter. In this case, the early frost (-0.8 °C) occurred at night of 2 nd November 2002 damaged to the top sprouts of all origins because the fast height growth do not give enough time to the lignification of a plant caused to severe early frost damages (Ayan et al 2005).



Figure 2. Successful 2 year *Paulownia* plantation at Jucu, Romania (photo Dinca L.)

Truffle plantations: the truffle plantation from Prejmer was realized on a proper field, pH between 6.9 and 7.7, soil rich in nitrogen (0.35-0.40%), of the gleysol type. On the other hand, the soil from Moldova Noua is not appropriate for realizing truffle plantations (Dincă M & Dincă L., 2015), having a too low pH (6.1). In order to remediate this lack, amendments with lime were applied, in accordance with the literature (Dincă L & Dincă M., 2014): a quantity of 0.3 kg/m<sup>2</sup> reaching a total of 400 kg for the entire surface. Each sapling was protected separately against rabbits, through cylinder fences. Both plantations have a good vegetation state (normal growths of seedlings, for example: a growth of saplings in the first year of 3.5 cm in height and 2.5 mm in diameter at Moldova Noua (Cântar et al., 2014) and were not affected by biotic or abiotic factors. Until now, there are not scientific confirmations for the presence of *Tuber melanosporum* in Romania, but we consider that the realized plantations can offer this type of mushrooms by taking into account the fact that it was located in the most favorable location for this species from a climatic viewpoint (an area with sub-Mediterranean climate, near the Danube, safe from lower temperatures or strong frosts).

In Sweden tree seedlings of *Quercus robur*, *Corylus avellana* and *Carpinus betulus* were inoculated with spores from *T. aestivum* fruit bodies to study the effects of pot substrate, tree species and time on *T. aestivum* mycorrhiza formation. Even if in Sweden is a shorter growing season, 6 years after planting, the first *T. aestivum* fruit body was found in a

Swedish truffle orchard (Weden et al.2009), while in France, fruit bodies of *T. aestivum* usually occur 5-10 years after plantation (Chevalier & Frochot, 1997a).



Figure 3. Seedlings inoculated with truffles used at Prejmer plantation in Romania (Photo Dinca L.)

### Conclusions

Numerous *Paulownia* plantations were realized in Romania in the last years. The used clones were Cotevisa 2 and In Vitro 112, all of Spanish origin. These plantations have reduced surfaces (an average of 1-3 ha) and were realized either by the firms that traded the seedlings, either and most of all by the owners of the fields. If the planting area was appropriate (from a climatic and pedologic point of view) and the planting and maintenance techniques were rigorously applied, the results for these plantations (at 2-3 years from planting) are very good (Baraganu and Jucu surfaces). However, if the geographic range is not adequate with the species ecological requests, the results are mediocre and even completely unsatisfactory. This is the case of some areas from Arpas or Mihaesti, where early or late frosts have significantly affected the seedlings. In other situations, the causes of unsuccessful plantations are represented by not knowing and wrongly applying the plantation or maintenance techniques (for example: the excessive cutting of seedling roots from Hetiur, a too strong pruning from Cataloi, or not removing the weeds from Arpaş).

The irrigation of cultures, especially in the country's more dry areas, is a mandatory condition for proper plantations (a good example in this case is represented by Jucu plantation). The plantation's soils with a good or average result are of fluvisol, phaeozem or chernozem type, and present calcium carbonate at the surface, neutral pH or weakly alkaline, with an average texture and well supplied with nitrogen and humus. Truffle plantations can be successfully realized in Romania if all their requests are taken into consideration, especially in choosing the field (alkaline soils), together with their proper maintenance methods.

## References

- Anonymous (1998). Research project on introduction and adaptation of Paulownia sp. in Turkey, The Ministry of Forestry, No: 15.10102, Izmir, Turkey,
- Akyildiz M.H., Kol. H.S. (2010). Some technological properties and uses of paulownia (*Paulownia tomentosa* Steud.) wood. *Journal of Environmental Biology*. 31: 351-355.
- Ayan S., Sivacioglu A., Bilir, N. (2005). Growth variation of Paulownia Sieb. and Zucc. species and origins at the nursery stage in Kastamonu-Turkey. *Journal of Environmental Biology* 27(3) 499-504.
- Bencivenga M, Baciarelli Falini L. (2012). *Manuale di Tartuficoltura. Esperienze di coltivazione dei tartufi in Umbria. Regione Umbria*, p 130.
- Belloli S., Bologna F., Gregori G., Zambonelli A. (2001). Il tartufo nero di Fragno (*Tuber uncinatum* Chatin): Ecologia e coltivazione [The black truffle of Fragno (*Tuber uncinatum* Chatin): Ecology and cultivation]. In *Actes du V-eme Congres International Science et Culture de la Truffe* (pp. 367-371). Paris: Federation Francaise des Trufficulteurs.
- Cântar I. C., Merce O., Cadar N., Simon-Cernescu N., (2014). Expanding of *Tuber melanosporum* truffle in culture - case study. *JOURNAL of Horticulture, Forestry and Biotechnology*, Volume 18(3), pag. 40-44.
- Chevalier G. & Grente J. (1973). Mycorrhizal spreading by truffle from excised roots and mycorrhizated seedlings. *Annales de Phytopathologie*, 5, 317-318.
- Chevalier G. & Grente J. (1979). Application pratique de la symbiose ectomycorrhizienne: Production a grande echelle de plants mycorrhizes par la truffe (*Tuber melanosporum* Vitt.) [Practical application of the ectomycorrhizal symbiosis: Large scale production of plants mycorrhized by the truffle (*Tuber melanosporum* Vitt.)]. *Mushroom Science*, X, 483-505.
- Chevalier G. & Frochot H. (1987). Ecologie et possibilite de culture en Europe de la truffe de Bourgogne [Ecology and possibility of culture in Europe of the Burgundy truffle]. *Revue des Sciences Naturelles d'Auvergne*, 53, 17-26.
- Chevalier G. & Frochot H. (1989). Ecology and possibility of culture in Europe of the Burgundy truffle (*Tuber uncinatum* Chatin). *Agriculture. Ecosystems and Environment*, 28, 71-73.
- Chevalier. G. & Frochot H. (1997a). *La truffe de Bourgogne* [The Burgundy truffle]. Levallois-Perret: Editions Petrarque.
- Chevalier G. & Frochot H. (1997b). *La maitrise de la culture de la truffe. Les possibilites d'application en vue de l'amelioration de la production des champignons comestibles* [The control of truffle cultivation. The possibilities of application with the aspect of improving the production of edible mushrooms]. *Revue Forestiere Francaise*, 49, 201-213.
- Chevalier G. & Frochot H. (2002). The truffle cultivation in France: Assessment of the situation after 25 years of intensive use of mycorrhizal seedlings. In I. R. Hall, Y. Wang, A. Zambonelli & E. Danell (Eds.), *Edible mycorrhizal mushrooms and their cultivation. Proceedings of the Second International Conference on Edible Mycorrhizal Mushrooms*. Christchurch: New Zealand Institute for Crop & Food Research.
- Chira, D., Chira, F. (2012). Micorizarea puietilor forestieri cu specii de Tuber, *Revista de Silvicultură și Cinegetică*, Anul XVII, Nr. 31, 14 – 22.
- Clapa D., Fira A., Simu M., Vasu L., Buduroi D. (2014). Improved In Vitro Propagation of Paulownia elongata, P. fortunei and its Interspecific Hybrid P. elongata x P. fortunei. *Bulletin UASVM Horticulture* 71(1).



- Danesh Y.R. (2015). Truffles: What we know and what should we know? *Journal of Agricultural Technology*. 11(8): 2111-2117.
- Dincă L., Dincă M. (2014). Considerații privind realizarea de plantații trufiere (Considerations regarding the realisation of truffles plantations), *Revista de Silvicultură și Cinegetică* 34, 109-114.
- Dincă M., Dincă L. (2012). "Recoltarea trufelor" (Truffles harvesting). *Revista de Silvicultură și Cinegetică* nr. 30, pag. 117-121.
- Dincă M., Dincă L. (2015). „Truffles and soil”. *Research Journal of Agricultural Science*, Timisoara, 47 (3), 44-50.
- Giovannetti G., Roth-Bejerano N., Zanini E., Kagan-Zur V. (1994). Truffles and their cultivation. *Horticultural Reviews*, 16, 71-107.
- Granetti B, Angelis AD, Materozzi G. (2005). Umbria Terra di Tartufi. Regione Umbria - Assessorato Regionale Agricoltura, Caccia, Pesca, Terni, Italia.
- Kiaei M. (2012). Physical and Mechanical Properties of Paulownia Wood (*Paulownia fortunei*) in North Iran. *Middle-East Journal of Research*. 11(7): 964-968.
- Knezevic M., Stankovic D., Krstic B., Nikolic M.S., Vilotic D. (2009). Concentrations of heavy metals in soil and leaves of plant species *Paulownia elongata* S.Y.Hu and *Paulownia fortunei* Hemsl. *African Journal of Biotechnology* Vol. 8 (20), pp. 5422-5429.
- Mosquera-Losada M.R., McAdam J., Romero-Franco R., Santiago-Freijanes J.J and Rigüero-Rodríguez A. (2009). Definitions and components of agroforestry practices in Europe. In: Rigueiro-Rodríguez A., McAdam, J., Mosquera-Losado M. (eds) *Agroforestry in Europe: current status and future prospects*. Springer Science + Business Media B.V., Dordrecht, p. 3-19.
- Paolocci F., Rubini A., Riccioni C., Topini F., Arcioni S. (2004). *Tuber aestivum* and *Tuber uncinatum*: Two morphotypes or two species? *FEMS Microbiology Letters*, 235, 109 - 115.
- Trappe J, Molina R, Luoma D, Cazares E, Pilz D, Smith JE, Castellano M, Miller S, Trappe M. (2009). Diversity, ecology, and conservation of truffle fungi in forests of the Pacific Northwest. PNW-GTR-772. United States Department of Agriculture, Pacific Northwest Research Station, Portland, OR, p 194.
- Wang Q, Shogren JF. (2003). Characteristics of the crop-Paulownia system in China. *Agric. Ecosyst. Environ.* 39: 3-4, 145-152.
- Weden C. (2004). Black truffles of Sweden. Systematics, population studies, ecology and cultivation of *Tuber aestivum* syn. *T. uncinatum*. *Comprehensive Summaries of Uppsala Dissertations from the Faculty of Science and Technology* 1043, Uppsala: Acta Universitatis Upsaliensis.
- Weden C., Danell E., Tibell L. (2005). Species recognition in the truffle genus *Tuber*: The synonyms *Tuber aestivum* and *Tuber uncinatum*. *Environmental Microbiology*, 7, 1535-1546.
- Weden C., Pettersson L., Danell E. (2009). Truffle cultivation in Sweden: Results from *Quercus robur* and *Corylus avellana* field trials on the island of Gotland. *Scandinavian Journal of Forest Research*, 24: 37-53.

## UTILIZATION ASPECTS OF PRIVATE FORESTS IN SELECTED DISTRICTS IN WESTERN AND EASTERN SERBIA RELEVANT TO THE LEGAL FRAMEWORK, SOCIOECONOMIC INFLUENCES AND PROPERTY RIGHTS

Igor GOLIC<sup>1\*</sup>, Vladimir NIKOLIĆ<sup>2</sup>, Nenad PETROVIĆ<sup>1</sup>

<sup>1</sup>University of Belgrade – Faculty of Forestry, Belgrade, Serbia

<sup>2</sup>Institute for Nature Conservation of Serbia, Belgrade, Serbia

\*Corresponding author: igorgolic84@gmail.com

### Abstract

Following the results of the last National Forest Inventory Serbia is a medium forested country with forest coverage of 29,1%. State owned forests cover an area of 53%, while private forests are represented with 47%. Private forests are characterized by small property size, high fragmentation, and high numbers of owners, but these forests are very important, because they have significant potentials in production of wood and non-wood forests products, carbon storage, and biodiversity protection. Utilization of private forests depends on reasons such as property size, fragmentation of the property, main purpose of forest use etc. Research that was done during the 2012, examined socioeconomic aspects and attitudes of private forest owners within the selected districts: Zlatiborski (Western Serbia) and Borski (Eastern Serbia). The main results of this research showed that in relation to property size, the average was determined as 4,12 ha per owner, where the biggest property size was 92 ha, while the smallest one was just 0,09 ha. Average number of parcels per owner was 3,91, and these properties were in 87,5% inherited, while only 2,5% of properties were bought by their owners. Concerning the utilization of forests, 86,5% of interviewees named firewood production for personal use as the main reason for utilization. The biggest problems during the forest management and utilisation were recognized as missing of appropriate equipment for utilisation, bad condition or shortfall of forest roads and complicated administrative procedures for timber production, transport and trade. Definition of issues and problems concerning private forests management could provide a solid base for defining a platform on national level, for better management and utilisation of private forests.

**Keywords:** *Private forests, Private forest owners, Utilization, Property rights, Serbia.*

### Introduction

Serbia is according to the last National Forest Inventory (Banković, et al. 2009) a medium forested country with forest area of 2.254.000 hectares, which is coverage of 29,1%. State owned forests are slightly bigger category which covers an area of 53%, while privately owned forests covers 47% of forest area. According to the results of the research (Glück, et al., 2010) private forests in Serbia are characterized by small property size with only 4,1ha per owner and high fragmentation of properties. According to this research, estimated number of parcels in private forests is 3.900.000, while the number of owners is estimated to 900.000. Nevertheless, these forests have significant potentials in production of wood and non-wood forests products, biodiversity protection and climate change mitigation and adaptation. Another issue that is characteristic for private forests is that process of migration from countryside to big cities is present during the last 50 years and emerging of new categories of forest owners, so called “urban” owners (Schraml et al, 2004) that lives in big cities, and

have their property at the rural area of the country. The start of implementation of Law on the restitution of property to Churches and Religious communities in 2006, bigger part of nationalized land is returned to Serbian Orthodox Church, and now Church is the biggest private forest owner in Serbia, and important player on the wood market. Process of restitution of forests and forest land to previous owners, is regulated by the Law on general restitution from 2011, and this process is still ongoing, so it can be expected that number of private forest owners will be increased (Petrović, 2012) because this Law predicts restitution of nationalized property through compensation in land or paying with Government bonds. Law on forests, as the main legal act for forestry sector, was in force from 1991 until 2010, and during 2010 new Law on forests was adopted. This law brought certain changes in rights and duties of private forest owners toward their forests, and prescribes some new features like private forest owners associations, subsidies for private forest owners, developing of Small and Medium Enterprises in forestry etc. This Law was amended in 2012 and 2015. Serbia is in the process of the EU accession and needs to harmonize national legislation with the EU and other international commitments. The legislation becomes more complex for the forestry sector, which is in close connection to the nature protection sector, having on mind that production in forestry demand long time period and needs to adjust itself to constant social, economic and environmental change. (Mitchell-Banks, P. et al., 2006) During the 2010 new Law on forests was proclaimed, and this law brought certain changes in defining of rights and duties of private forest owners toward their forests. It defines two types of ownership and predicts some new features like private forest owners associations. New Law on forests kept some provisions from the old Law (Law on forests, 1991) concerning private forests, including tree and timber marking, issuing of delivery notes, and payment for cuttings. Law from 2010 predicts subsidies for private forest owners, developing of small and medium enterprises for providing of technical support in private forests, establishment of new bodies (e.g. Council for forests) etc.

### **Material and Methods**

Aim of this paper is to present an overview of the main socioeconomic characteristics of private forests and their owners in the selected districts, as well as legal prescriptions related to the utilization of these forests. Research is done in 2012. as part of the project “National inventory of private forests”<sup>50</sup>, and for the purpose of this paper is are selected districts: Zlatiborski in Western Serbia and Borski in Eastern Serbia. Sample for the purpose of this paper was 807 private forest owners within two districts. For data collection is used semi structured interview which consists of four parts: 1) Introductory part, 2) General information, 3) Information on forests and 4) Institutional aspects. The introductory part contains general information on the questionnaire, such as: region, municipality, city, date, project name, name of the institution implementing the project, purpose of the questionnaire, the purpose of conducting the questionnaire and the part about the confidentiality of the information that will be collected. The first part of the questionnaire refers to the general data of the respondents. This section contains seven questions that are of an open type, closed type with one possible answer, or simple questions with sub-questions. The second part of the questionnaire refers to data on forest property. It contains fifteen questions and is characterized by a variety of question types. The third part of the questionnaire refers to institutional aspects and contains nine questions, where the most of the questions are closed questions with several possible answers. Apart from these, there are also closed questions with one possible answer and questions with the Likert scale. Mask for inputting survey data

---

<sup>50</sup> The Project “National inventory of private forests”, 2012

in Excel was prepared. After entering data into the Excel database, the data are exported to the SPSS (Statistical Package for Social Sciences) software, where are calculated frequencies and correlations for specific variables. In addition to the data collected during the field work, for the preparation of this paper are used secondary data from the literature review of legal acts and scientific papers.

### **Results and Discussion**

The main results of this research shows that forest owners are male in 78,8% of interviewees, while female forest owners are represented with 21,2%. This can be explained by historical and cultural heritage of Serbia, where male are represented as inheritors, while female inherits the property usually in case when there is no male inheritors. Average age of interviewees is 58,7 years, where the oldest interviewee is 91 years old, while the youngest is in the age of 19. The greatest number of interviewees (73,6%) have more than 50 years in age. In comparison to this, age in some countries of Europe varies considerably, so the oldest forest owners have Belgium, over 60 years old is more than 65%, and the youngest forest owners are in Poland with only 12% of forest owners over 60 years old (Schmithüsen and Hirsch, 2010). When observing the occupation of private forest owners within these districts more than one third of them or 32,0% is dealing with agricultural production, while pensioners are with 36,8% represented as the largest group of interviewees. Entrepreneurs, managers and students are represented with 6,5% in total, while public servants and physical workers are represented with 20,2%. Concerning property size, the average was determined as 4,12 ha per owner, which is close to the average of 4,1 ha gathered as the result of PRIFORT<sup>51</sup> project. The biggest property size is 92 ha, while the smallest one is just 0,09 ha. Average number of parcels per owner is 3,91, and these properties are in 87,5% inherited, while only 2,5% of properties is bought by their owners. Almost 10% of properties is combined as inherited and bought, while only 0,5% of interviewees doesn't know the origin of their property. Concerning the future of these properties, 93,8% of owners will give properties to their children. Only 1,2% of them will sell their property, while 2,9% doesn't know what will be the future of their property. According to the results of this research, the forest market in Serbia almost does not exist, and more than 90% of the respondents did not sell their forests nor do they want to do it, but mostly try to leave the forests to their children, which is identically to the situation on the national level (Petrović, 2012). When asked for the main purposes of their forest use (multiple answers was possible), 86,5% of them named firewood production for personal use as the main reason. 16,7% of interviewees use their forest for the production of saw logs for personal use, while 5,7% uses their forest for the production of saw logs and firewood (including charcoal) for further selling. Only 3,0% use their forests for nature conservation, tourism and grazing. As the biggest problem in management of private forests within these districts (multiple answers was possible) is recognised missing or bad condition of forest roads which is mentioned in 68,5% of cases. Based on the research (Avdibegović et al., 2010) the roads were recognized as the main reason for establishing of Private forest owners associations, in Bosnia and Herzegovina, Croatia, Macedonia and Serbia. Shortfall of appropriate equipment for the utilisation of private forest is recognised in 18,6% of cases, while 20,1% of interviewees considers the lack of State subsidies as the main problem in forest management. These three problems are directly connected with economic and financial situation of forest owners, because they don't have enough financial means to invest in new equipment, but use modified agricultural equipment. From the other side, entrepreneurs dealing with jobs in forestry have certain

---

<sup>51</sup> The Project "Research into the Organization of Private Forest Owners Interest Associations in the Western Balkan Region PRIFORT. 2007

equipment for the utilisation of forests, but costs of their maintenance are sometimes too expensive for owners. Complicated administration and shortfall of adequate professional help for forest management are recognised as the main problems in 33,6% of cases. Umbrella institution in charged for forestry sector in Serbia is Directorate for Forests, as integral part of the Ministry for Agriculture, Forestry and Water Management. State enterprises for forest management „Srbijašume“ and „Vojvodinašume“ provides technical support in management of private forests. When asked about institutional help in management of their forests, 42,6% of interviewees recognized forest extension service, as public body that should be in charged for this issue. 16,1% of interviewees stated that themselves are competent for managing of their forests, and there is no need for institution that would deal with private forest management. State forest enterprises are recognized as the most suitable in 28,4% of cases, while association of private forest owners are mentioned in 10,2%. Almost 10% of the interviewees stated that they don't know which institution could help them in forest management. As the main legal prescription that burdens private forest owners in management of their forests is recognised issuing of cutting permit before felling, which is mentioned in 43,9% of cases. At the second place, with 38,7% is ranked an obligation of tree marking before felling, while paying a tax for felled wood is ranked as the third one with 32,0%. Issuing of permit for wood transport is represented with 23,4%. It is interesting to mention that 4,2% of interviewees mentioned that obligation of preparation of management plans burdens them in management of their forest, although according to the articles 30. and 70. of the Law on forests, for the preparation of management plan are in charged State enterprises for forest management or State enterprises of National parks, dependently where private forests are located. In the research from 2007, Boon and Meilby describes that in order to be effective, the policy instruments must motivate private forest owners to adapt their decisions/behavior to the objectives of the forestry policy (Boon & Meilby, 2007).

Table 1. Forest policy instruments that addresses different PFOs categories

Church forests recognized by Forest Law	Owners of privatised forests recognized by Law	Physical persons
Financial incentives available for this new category Regular income tax apply for forestry activities Management organization still in progress No advice or extension support Play potential role of the voice of private forests at national level	Financial incentives available for this new category Regular income tax apply Management organization still in progress No advice or extension support Play potential role of the voice of private forests at national level	Financial incentives available only for owners that have more than 100 ha Regular income tax apply Technical support from “exclusively” State Enterprises although forest act give freedom in case they are associated Extension and advisory service is missing Play potential role of the voice of private forests at national level No active PFOAs – no demand for change in policy.
Note: <b>For the owners of restituted forests</b> – process of general restitution is still ongoing		

\*Source: Author's elaboration based on the questionnaire survey results.

According to the ownership structure, owners of private forest can be divided in four categories: 1) Church, 2) Physical persons (owners close to the property and owners away from the property), 3) Owners of restituted forests and 4) Owners of privatised companies. Migration of inhabitants from rural to urban areas in last 50 years amounts around 40.000 people annually, which leads to the result that now in rural areas are predominant older categories of population. Having on mind this fact, what should be taken into consideration is that now emerges new category of owners. Those are owners that live in the city, but own property which is more than 50km away from their place of living, and they have low interest in forest management, and if there is certain interest, utilization aspects of those owners are different. This type of forest owners is known as “Urban Forest Owner” that has different interest in comparison to one that lives close to forest. Forest policy should address specific forest policy instruments in order to secure sustainable forest management within this owner’s category. In addition to this, at the state level are implemented same policy instruments for owners close to forest and those away from forest. Nevertheless, establishing of Private forest owners associations (PFOAs) started in 2006, as a result of UN-FAO project, and until 2009 in Serbia has been established 20 associations (Nikolić, 2009). Nevertheless, today exists less than ten of them, but they implement only certain activities on a small scale.

### **Conclusions**

Based on the presented results of the research it can be concluded that the main reasons for the utilisation of private forests are fuel wood and timber production for domestic use, as well as for sale. The biggest problems during the forest management and utilisation are recognized as missing of appropriate equipment for utilisation, bad condition or shortfall of forest roads and complicated administrative procedures for timber production, transport and trade. After defining the problems during the utilization of private forests, institutions that can provide professional help to private forest owners are recognized as Forest extension service, State enterprises for forest management and Directorate for forests. Legal preconditions that burdens private forest owners in utilisation of their forests are obligation of tree marking before felling, complicated administration and issuing of cutting permit. Definition of issues and problems concerning private forests management could provide a solid base for defining a platform on national level, for better management and utilisation of private forests. State is providing different support measures to private forest owners, such as financing, co-financing and subsidies for certain activities, and also consultation, education and technical support. Nevertheless, the condition of the private forests, problems in management and unused production potential require an organized and effective support from the State and active participation of forest owners in order to achieve ecologic, social and production functions of these forests with appreciation of sustainable and multifunctional management.

### **Recommendations**

As a result of the research and overview of the condition of private forests and socio-economic characteristics of their owners are prepared the following recommendations. At the first place should be done land consolidation of forest properties, which can include purchase of forest land among forest owners, or among owners and State. Another recommendation is that condition of forest roads should be improved, and that beside of the maintenance of existing forest roads, new forest roads should be constructed. Issue that is actual at this moment is the utilisation of forest biomass, where the wood from private forests can take significant part in market supply. Of course, what should be considered is the establishment of new organizations of private forest owners, in forms of associations or cooperatives, as well as an umbrella association on national level. Of course, the State should formulate and implement new innovative approach for different PFO categories – as a good precondition for

trade on wood market. One of the recommendations is that in close future should be established Forest extension service, as the unit that should provide advices and services to PFOs. Recommendation also connected to this issue is to simplify the administrative procedures which burdens PFOs in management of their forests. In addition, existing instruments of forest policy should be adjusted toward forest owners and their demands (especially for new categories of owners) by proper extensionservice and financial instruments. Having on mind that more than 75% of people have more than 50 years, instruments of the forestry policy should be directed to those owners, in terms that there is an option for small and medium enterprises to performs works on utilization for them, as contractor.

### **References**

- Avdibegović, M., Petrović, ., Nonić, D., Posavec, S., Marić, B., Vuletić, D. (2010). Readiness Of Private Forest Owners In Croatia, Serbia And Bosnia-Herzegovina To Cooperate In Forest Roads Construction And Maintenance (Article) Šumarski list, vol. 134 br. 1, p. 55
- Banković, S., Medarević, M., Pantić, D., Petrović, N. (2009). National Forest Inventory of the Republic of Serbia: Forest Fund of the Republic of Serbia, Ministry of Agriculture, Forestry and Water Management of the Republic of Serbia, Forest Administration, Belgrade, Planeta print, 244 p.
- Boon, T.E., Meilby, H. (2007). Describing management attitudes to guide forest policy implementation, *Small scale Forestry* 6:79
- Glück P., Avdibegović M., Čabaravdić A., Nonić D., Petrović N., Posavec S., Stojanovska M., Imočanin S., Krajter S., Lozanovska N., Marić B., Milijić V., Mrkobrada A., Trninić S. (2011): Private Forest Owners in the Western Balkans Ready for the Formation of Interest Associations. European Forest Institute Research Report 25, ISBN: 9789525453843, Joensuu: 230 p.
- Law on forests (2010). Official Gazette of the Republic of Serbia, No. 30/2010, 93/2012, 89/2015
- Mitchell-Banks, P., Niskanen, A., Curl, S., Chobanova, R., Carbone, F. (2006). The Impacts of Government Legislation and Policy or Projects on Private Forestry. Niskanen, A.,(ed.), 105-133.
- National inventory of private forests (2012). Ministry of Agriculture, Forestry and Water Management of the Republic of Serbia, Forest Administration - University of Belgrade. Faculty of forestry
- Nikolić, V., (2009). Organizing of private forest owners in the municipalities of Despotovac and Čuprija. Diploma paper. University of Belgrade, Faculty of Forestry. 52 p.
- Glück P., Avdibegović M., Čabaravdić A., Nonić A., Petrović N., Posavec S., Stojanovska M. (2010). The preconditions for the formation of private forest owners' interest associations in the Western Balkan Region: Forest Policy and Economics. Volume 12, issue 4 page 250-263
- Petrović, N. (2012). Attitude of the state and private forest owners towards forests as the basis for defining the model of forest management planning in Serbia. PhD thesis, Faculty of Forestry, Belgrade.
- Schmithüsen, F., Hirsch, F., (2010). Private forest ownership in table, United Nations, Geneva, Geneva timber and forest study paper 26, p. 120
- Schraml, U., Ziegenspeck, S., Härdter, U. (2002). Lifestyles of private forest owners as an indication of social change: The changing role of forestry in Europe—perspectives for rural development. Forest and Nature Conservation Policy Group, Proceedings 2, 81-93.

## **STAKEHOLDERS' ATTITUDES TOWARDS THE HUNTING SECTOR IN SERBIA: REGULATORY FRAMEWORK AND WILDLIFE PROTECTION SYSTEM**

Slavko MLADENOVIĆ, Dragan GAČIĆ, Jelena NEDELJKOVIĆ\*, Nenad RANKOVIĆ,  
Dragan NONIĆ

University of Belgrade-Faculty of Forestry, Belgrade, Serbia

\*Corresponding author: jelena.nedeljkovic@sfb.bg.ac.rs

### **Abstract**

The aim of this paper is to analyze the regulatory (strategic and legal) framework of the hunting sector in Serbia and the system of wildlife protection, as well as the stakeholders' attitudes towards it. Primary and secondary data were used for conducting such an analysis. Secondary data were collected from national strategic documents, laws and by-laws. Primary data were collected by using face-to-face and e-mail interviews, which were conducted with 13 professionals from public administration, services and organizations, responsible for hunting in Serbia. The results show that, although in Serbia there is no single strategic document in the hunting sector, a number of other sectoral strategies (forestry, agriculture, spatial planning, biodiversity, etc.) have an impact on it. Similarly, a number of laws are important for hunting issues in Serbia. In addition to being influenced by the Law on wildlife and hunting, the sector is affected by the legislation in the following fields: forestry, environmental protection and nature conservation, associations, weapons and ammunition, etc. The results of the analysis of the stakeholders' attitudes indicate the necessity of adopting a strategic document for the hunting sector. Most of them believe that the current legal framework is good and that it provides the framework for sustainable hunting management in Serbia. At the same time, they stress the need for certain amendments to the existing law and by-laws, so that implementation would be better. On average, the respondents see the current system of wildlife protection as “neither effective nor ineffective” (avg. grade 2.8). On the other hand, they believe that the current system of penalizing persons engaged in illegal hunting as “ineffective” (avg. grade 1.8). The explanations of such a low grade of system efficiency are: mild penalties, long court processes, and lack of a control system.

**Key words:** *hunting sector, stakeholders, regulatory framework, wildlife protection*

### **Introduction**

Hunting in Serbia is a complex and legally regulated organized activity, which is classified into the subgroup of the field of forestry. Contemporary hunting is based on breeding, protection and sustainable use of “partially renewable” natural resources (wildlife populations), which are a common social good in Serbia. Hunting grounds and populations of autochthonous wildlife species (e.g. roe deer, wild boar, deer, hare, partridges, bear, wolf) are a highly valuable natural resource and significant economic, touristic, hunting and sports and recreational potential.

According to §3 of the Law on wildlife and hunting (2010/b), the protection of wildlife populations and their habitats is a matter of general interest and involves taking measures to ensure the conditions for the survival and development of the population of a particular wildlife species, as well as its protection against illegal use. The system of hunting fauna protection in Serbia is based on the adoption of basic planning documents (2010/b): the



Strategy of hunting development adopted by the Government for a period of 15 years, hunting plans adopted by users of hunting grounds for a period of 10 years, and the annual hunting management plan, which is adopted by hunting grounds users for each hunting year<sup>52</sup>. Other wildlife protection measures are: monitoring of wildlife populations and their habitats, support hunting grounds users, providing funding for the establishment and maintenance of the hunting information system (Hunting Cadastre and Central Database), research and development work, as well as supervision of work and enforcement of regulations in hunting (Danilović, Gačić, 2014, Gačić, 2016).

It is well known that *“hunting and game-preservation are interrelated: hunting must respect the intentions of game-preservation, and game-preservation must rely on hunting as one method to achieve its intentions”* (Hasenkamp, 1995). Effective application of hunting regulations is important for the protection of wildlife populations and their habitats, as indicated by the results of previous research (Gandiwa et al., 2013), which found that in cases where the application of the law is strict, the number of activities in illegal hunting is reduced. It was also noted that *“political instability and economic collapse do not necessarily lead to increased hunting in situations where policy instruments, such as law, are enforced”* (Gandiwa et al., 2013).

The preservation of wildlife and natural habitats is of great importance within the EU *“whose wildlife protection law and policy paternalistically impose a duty on EU Member States to conserve wildlife and impose criminal sanctions on those committing serious breaches of environmental law”* (Nurse, 2017). Today, wildlife protection and legislation in this area are accepted as problems that are resolved in the public interest. National game laws are often defined and interpreted in the context of prevailing social conditions (Nurse, 2017).

In those terms, **the aim** of the paper is to determine the content of the regulatory (strategic and legislative) framework of the hunting sector in Serbia, as well as the views of respondents on them and the system of protection of wildlife populations and their habitats. The **subject** of this research is the views of professionals on the above issue, while the **purpose** is to give recommendations for the improvement of the aforementioned framework and the system of protection.

### Material and methods

In this research we applied a mix of the following methods: literature review, secondary data analyses and in-depth interviews. The sources of secondary data were national strategic documents, laws and by-laws. Primary data were collected using face-to-face and e-mail interviews, which were conducted with 13 professionals working in public administration, services and organizations, responsible for hunting in Serbia (Table 1).

**Table 1.** Number of interviewed experts per institution/organization

Institution / organization		Number of respondents
Public administration	Ministry of Agriculture and Environmental Protection-Directorate for Forests	3 currently employed experts and 2 formerly employed experts
Services	Institute for nature conservation	1 expert
Organizations	Hunting Association of Serbia	3 currently employed experts and 1 formerly employed expert
	Faculty of Forestry	1 expert
	Public enterprise for state forest management	1 currently employed expert and 1 formerly employed expert

The respondents were selected by using the judgmental sampling technique, because we focused on the attitudes of those individuals who possess knowledge and working experience related to the research problem.

<sup>52</sup> From 1<sup>st</sup> April of the current year to 31<sup>st</sup> March next year

The interviews were conducted during March 2017. The topics of these interviews covered five thematic segments: 1) strategic and legal framework, 2) institutional framework, 3) institutional and cross-sectoral cooperation, 4) support measures; 5) management and reintroduction of deer in Serbia. The questionnaire consisted of 21 questions, and in this paper, we analyzed answers to 6 of them (Table 3), in which we asked the interviewees about their opinion on the strategic and legal documents that provide frameworks for implementing hunting policy in Serbia (questions 1-4)<sup>53</sup>, the current system of wildlife protection and penalizing persons engaged in illegal hunting, as well as the possibilities for improvement (questions 5 and 6)<sup>54</sup>.

Data were analyzed using the qualitative content analysis (Kvale, Brinkmann, 2009). Descriptive statistics (arithmetic mean) was used for the analysis of data related to the respondents' evaluation of the current system of wildlife protection and penalizing persons caught illegal hunting.

## Results and discussion

The structure of this chapter follows the order of questions, as they were given in the questionnaire and explained in the methods.

The respondents have similar attitudes towards the **strategic framework of hunting** (questions 1 and 2) in Serbia. In the first place, they emphasize (7 respondents) that there is no single strategic document, "*which would provide long-term guidelines*" (Int-5), i.e. which "*defines the directions for the development of hunting*" (Int-4) and "*goals and measures for achieving objectives in the function of Serbian hunting development*" (Int-1).

**Table 2.** Strategic documents that provide frameworks for implementing the hunting policy in Serbia.

Document title	Explanation
Strategy for forestry development	Initiates the adoption of the Strategy for hunting development Prescribes objectives and measures for sustainable wildlife management
National Sustainable Development Strategy	Defines the objectives of sustainable development of hunting
National Strategy for Sustainable Use of Natural Resources and Goods	Initiates the adoption of the Hunting Development Strategy, as well as the creation of " <i>legal, institutional and economic frameworks for implementing the Hunting Strategy</i> ", with the " <i>institutional strengthening and building of existing research capacities in forestry and hunting</i> " (2012) Public enterprises for state forest management, Public enterprises national parks, Hunting Association of Serbia and Hunting associations are listed as responsible institutions for the implementation of the Strategy
Biodiversity Strategy	It is alleged that illegal hunting is one of the most significant factors for endangering biodiversity, but there are no defined objectives and measures related to hunting and wildlife
Spatial Plan of the Republic of Serbia 2010-2020	Initiates the adoption of the Hunting Development Strategy Zoning of the habitats of basic wildlife species and spatial-functional arrangement of hunting-breeding centers " <i>In the sector of hunting and fishing, the spatial plan is being implemented by creating planning documents for the hunting area</i> " (2010 / c)

**Source:** Ranković et al., 2017 and supplements by the author

<sup>53</sup> Question1: Which strategic documents provide frameworks for implementing the hunting policy in Serbia? What is their application by your institution / organization?

Question 2: What is your opinion on the existing strategic frameworks of hunting in Serbia?

Question 2a: If you think that it is necessary to improve the strategic frameworks of hunting in Serbia, please explain why. How could this be done?

Question 3: Which legal documents regulate hunting issues in Serbia? What is their application by your institution / organization?

Question 4: What is your opinion on the existing legislative frameworks of hunting in Serbia?

Question 4a: If you think that it is necessary to improve the legislative frameworks of hunting in Serbia, please explain why. How could this be done?

<sup>54</sup> Question 5: Please evaluate (1-5) the current system of game conservation and punishment of persons caught in illegal hunting in Serbia. Please explain your attitude.

Question 6: If you believe that the current situation regarding the prevention or significant reduction of illegal hunting is not satisfactory, please explain how it could be improved. What measures do you propose?

<sup>55</sup> The Law on Wildlife and Hunting (2010/b) prescribes the Program of Hunting Area Development, which has not been adopted yet, and the division into hunting areas has not taken off. Currently, hunting grounds in the hunting area are managed on the basis of hunting grounds and annual management plans for each hunting year.

This indicates that the hunting policy in Serbia (Table 2) is currently "defined through legislation and certain strategic documents as the basis for the development of the sector" (Int-2). In addition, it is stated that "the existing documents, which in part, establish a strategic framework for hunting, do not define the strategic requirements for further development precisely enough" (Int-1). Also, 3 respondents believe that there is a lack of conformity among these documents, i.e. that "there is a problem with the harmonization of the regulations in agriculture, hunting and forestry" (Int-3). In addition to the above mentioned strategic documents, the hunting sector in Serbia is affected by numerous international conventions (Berne Convention, Bonn Convention, CITES Convention, Convention on Biological Diversity), which were ratified by Serbia. In previous research, it was emphasized that the effective implementation of adopted national strategic documents is an important measure for fostering the development of hunting (Gačić *et al.*, 2015).

All respondents (Table 3) agree that it is necessary to improve the strategic frameworks of hunting in Serbia (question 2a), and, first of all, adopt the Strategy of Hunting Development. In addition, the following is proposed:

harmonization of objectives and measures with international and EU regulations, in accordance with the obligations undertaken by the ratification of agreements "dealing with the preservation and improvement of the environment, which directly or indirectly affect the development of hunting" (Int-2);

intensification of cross-sectoral cooperation and harmonization of regulations in different sectors (Int-3, Int-9, Int-12);

involvement of all stakeholders in the development of strategic documents (Int-7, Int-11, Int-13).

**Table 3. Matrix of topics**

Respondent	Framework improvement		System		Q 6. Current state (prevention and significant reduction of illegal hunting): satisfactory or unsatisfactory
	Q2a. Strategies	Q4a. Laws	Q5. Wildlife protection	Q5. Penalties	
Int-1	+	+	+	+/-	n.d.
Int-2	+	n.d.	+/-	+/-	-
Int-3	+	+	+/-	+/-	-
Int-4	+	+	+/-	+/-	-
Int-5	+	-	-	-	-
Int-6	+	+	-	-	-
Int-7	+	+	+/-	-	-
Int-8	+	+	+/-	-	-
Int-9	+	n.d.	-	-	+/-
Int-10	+	+	+	-	+/-
Int-11	+	-	-	n.d.	-
Int-12	+	+	+/-	-	-
Int-13	+	+/-	+	-	-

Legend:  
Q - question  
+ advocates; - opponents; +/- indifferent; n.d. no data

Regarding the **legislative framework for hunting** in Serbia (questions 3 and 4), the respondents explained that the Law on wildlife and hunting (2010/b) and the accompanying bylaws provide the framework for sustainable hunting management (Table 4).

**Table 4. Legislative documents regulating hunting issues in Serbia.**

Document title	Explanation
Law on Wildlife and Hunting	The basic law, which "regulates the protection, management, hunting, use and improvement of wildlife populations in hunting grounds; Protection, conservation and improvement of wildlife habitats; Protection, management and maintenance of hunting areas and other issues of importance for wildlife and hunting" (2010/b)
Law on Forests	Wild animals and other animals living in the forest are considered forest products. The number and species of wildlife must be maintained at a level that does not impair the biological balance of forest ecosystems and does not prevent the implementation of forest management objectives Necessary harmonization of planning documents of forestry and hunting Prohibition of breeding of large game in forests undergoing regeneration

	The Forest Council's activities include, inter alia, " <i>consideration of research programs, development plans and knowledge transfer in forestry and hunting, rural development and nature conservation and providing opinions on the proposed projects</i> " (2010/a)
Environmental Protection Law	Strategic Environmental Assessment is carried out for strategies, plans, programs and bases in the field of hunting Prohibition of harassment, abuse, harassment and destruction of wild fauna and destruction of habitats Restricting cross-border traffic of wild fauna (import, export, import, export, export) and their developmental forms and parts
Law on Nature Protection	The protection regime of the II degree of protection limits the construction of facilities for wildlife breeding, fishing, hunting, etc. Measures for the protection of strictly protected wildlife species Prohibited means of capturing and killing wild animals Reintroduction of wild species Breeding of highly protected and protected species of wildlife species Trade in strictly protected and protected wildlife species The jobs of guardians of protected areas (at the same time doing the jobs of hunting guards, only in protected areas smaller than 100 ha)
Law on Associations	Establishment and functioning of hunting associations
Law on Weapons and Ammunition	Procuring, holding, carrying, trade and transport of weapons and ammunition Defining the term "hunting weapons" and conditions for its carrying, storing, etc. Carrying, storing and use of official weapons

Source: Gačić *et al.*, 2015 and supplements by the author

It is noticeable that the legislative framework of hunting in Serbia is complex, because it is affected by many other documents, for example, in the fields of nature conservation, environmental protection, forestry, etc. Hunting regulations are also complex in other European countries, and France can be taken as an example, including "*a tax on the individual hunter's harvest, a levy on hunting licenses, schemes for compensating landowners, and detailed administrative regulation of the number of animals bagged*" (Abildtrup, Jensen, 2014). However, the authors point out those even such complex regulations failed to provide the optimal size of large wildlife populations in France. Hunting revenues are often an important part of rural economy, which is an important reason for the views and interests of hunters to be taken into consideration when passing laws and other legal acts (Heberlein, Kuentzel, 2002, Sharp, Wollscheid, 2009, Wam *et al.*, 2012). This approach is not a novelty, but it is also present in other sectors. Thus, the involvement of various stakeholders in political processes has become common in practice and is an integral part of all forestry policy processes (Nonić *et al.*, 2014). All these processes should be followed by the appropriate level of partnership, transparency, education and public relations (Nonić, 2008).

Although 4 respondents consider that the legislative frameworks are good (Table 3), it was also pointed out that "*there are legislative solutions that can be reconsidered for a potential change*" (Int-1), especially since "*certain provisions of the Law on Wildlife and Hunting are not fully applicable*" (Int-4), or "*they are difficult to implement in practice*" (Int-8).

Eight respondents believe that the legislative framework of hunting needs to be improved (question 4a), in particular "*in terms of mutual alignment and in relation to contemporary needs and general social development*" (Int-2), but also with "*new regulations defining the rights and obligations of institutions and individuals existing in the hunting sector (e.g. the Law on Inspection Supervision, the Law on Public-Private Partnership and Concessions)*" (Int-1). They also suggest:

amendments to the penal provisions, which are "*poorly defined*" (Int-3);

that hunting planning should be better systematized;

amendments to some articles of the law, in order to enable reorganization of the professional hunting service, in the sense that they should be "*civil servants, and not employees of hunting associations*" (Int-3);

better definition of how to increase the number of wildlife populations and improve their structure.

The main problems in the hunting of Serbia are the non-compliance of the legislative framework, the lack of funding for the implementation of planned provisions, the lack of specific planning documents, the existence of many conflicts in forest management and hunting grounds, as well as negative impacts and consequences of the economic crisis (Danilović, Gačić, 2014).

On average, respondents consider the current **system** of protection of wildlife populations and their habitats (question 5, Table 3) "*neither efficient nor inefficient*" (average score 2.8). On the other hand, they consider that the system of punishing persons engaged in illegal hunting (question 5, Table 3) is "*inefficient*" (average grade 1.8), and they listed the following reasons for that:

the absence of a penal policy and a mild penalties: "*penalties are too mild*" (Int-12); "*these are mostly fines paid for charities*" (Int-5); "*inadequate penal policy*" (Int-2);

inadequate work of the judiciary: "*charges pressed by the competent authorities are most often subject to the statute of limitations*" (Int-12); "*trials last for a long time*" (Int-5); "*processes are delayed*" (Int-13); "*courts are slow*" (Int-4); "*inconsistency in the processing of illegal hunting*" (Int-2);

poor control: "*a system of control is missing*" (Int-4); "*hunting guards have the status of state clerks, but limited power*" (Int-5).

In addition, one of the respondents believes that the inefficiency of the system partly stems from insufficient cooperation with the Ministry of interior, i.e., that "*hunting guards need police support, which is often not there*" (Int-5).

Previous research in Serbia found that, regardless of the changes in sector's regulations, the unfavourable situation regarding illegal hunting was not improved (Gačić et al., 2015). Similarly, illegal hunting is a serious problem worldwide and represents an important form of law violation, especially in rural areas (Eliason, 2003). However, in many countries, like in Serbia, competent institutions and organizations do not pay enough attention to these problems, because "*the activities are viewed as less serious, perhaps even trivial, when compared to other types of unlawful behaviour*". In this regard, there were situations in which "*many instances of wildlife law violation never come to the attention of law enforcement authorities*", and some estimates were that "*ratios of discovered offenses to actual offenses ranged from 1:83 to 1:30*" (Eliason, 2003).

The current situation regarding the **prevention or significant reduction** of illegal hunting (question 6, Table 3) is characterized as unsatisfactory by the majority of (i.e. 10) respondents. To this end, they propose certain measures for:

the improvement of cross-sectoral cooperation, especially with police and prosecutors;

strengthening the penal policy and its consistent approach

speeding up the process of court proceedings;

harmonization of existing legal regulations (Law on Weapons and Ammunition, Criminal Code and Law on Wildlife and Hunting);

a more frequent control of hunting associations and hunters;

defining the status of hunting guards and professional services and their relocation from the existing users of hunting grounds.

## Conclusions

Based on the results obtained, it can be concluded that:

the hunting sector policy is defined by numerous documents, in the field of forestry, sustainable development and nature protection;

there is a complex legislative framework, which, in addition to the basic law, includes regulations in the field of forestry, nature conservation, environmental protection, etc.;

the system of protection of wildlife populations and their habitats, in the opinion of the respondents, is "not efficient or inefficient", while the system of punishing persons engaged in illegal hunting is considered "inefficient", which is explained by the following reasons: mild sentences, long judicial processes, the lack of a control system and insufficient cooperation with the police;

the respondents generally characterized the current situation regarding the prevention or significant reduction of illegal hunting as being unsatisfactory.

The basic recommendations for improving the strategic and legislative frameworks of the hunting sector in Serbia, as well as the system of protection of wildlife populations and their habitats are:

to develop and adopt a Strategy for hunting development, that is, a strategic framework that, based on previous results and reliable determination and analysis of the current state, should define the general and specific objectives of hunting development and management of wildlife populations and their habitats, as well as measures for their realization;

harmonization of the objectives and measures when adopting strategic documents in other sectors, which are directly or indirectly related to hunting;

amendments to the Law on Wildlife and Hunting (2010/b) and numerous accompanying regulations, primarily with regard to the supervision of the application of the law, as well as the penal provisions, including harmonization with the Criminal Code and the Law on Wildlife and Hunting;

establishment of a new (modern) system for the protection of wildlife populations and their habitats.

### Acknowledgement

This study was conducted within the project: "Research of the causes and consequences of the disappearance of red deer in central Serbia, defining areas suitable for reintroduction (settlement) and measures for improving the reintroduction process - Phase I", financed by the Ministry of Agriculture and Environmental Protection - Directorate for Forests of the Republic of Serbia.

### References

- Abildtrup, J., Jensen, F. (2014). The regulation of hunting. A game population based tax on hunters. *Revue d'Études en Agriculture et Environnement*, Vol. 95, pp. 281-298.
- Danilović, M., Gačić, D. (2014). Sustainable use of forest and hunting resources, *Bulletin of the Faculty of Forestry, Suppl. iss.*, pp. 25-50.
- Eliason, S. (2003). Illegal Hunting and Angling: The Neutralization of Wildlife Law Violations, *Society & Animals*, Vol. 11(3), pp. 225-243.
- Gandiwa, E., Heitkönig, I., Lokhorst, A., Prins, H., Leeuwis, C. (2013). Illegal hunting and law enforcement during a period of economic decline in Zimbabwe: A case study of northern Gonarezhou National Park and adjacent areas, *Journal for Nature Conservation*, Vol. 21, Iss. 3, pp. 133-142.
- Gačić, D. (2016). Monitoring of game populations and their habitats in Serbia [Monitoring populacija divljači i njihovih staništa u Srbiji]. *Goldhorn Bulletin*, Vol. 4, pp. 46-56.
- Gačić, D., Prentović, R., Pilipović, V., Ostojić, M. (2015). Hunting tourism and safety aspects of hunting fauna use in Serbia, *Bulletin of the Faculty of Forestry, Suppl. iss.*, pp. 45-54.
- Hasenkamp, G. (1995). The economics of hunting, game-preservation, and their legal setting, *European Journal of Political Economy*, Vol. 11, pp. 453-468.

- Heberlein, T., Kuentzel, W. (2002). Too many hunters or not enough deer? Human and biological determinants of hunter satisfaction and quality, *Human Dimensions of Wildlife*, Vol. 7, pp. 229-250.
- Kvale, S., Brinkmann, S. (2009). *InterViews: Learning the Craft of Qualitative Research Interviewing* 2nd Ed., SAGE Publications, Inc.
- (2010/a). Law on forests [Zakon o šumama], Official gazette of the Republic of Serbia, No. 30/2010, 93/2012 and 89/2015, Belgrade.
- (2010/b). Law on wildlife and hunting [Zakon o divljači i lovstvu], Official gazette of the Republic of Serbia, No. 18/2010, Belgrade.
- (2012). National strategy for sustainable use of natural resources and goods [Nacionalna strategija održivog korišćenja prirodnih resursa i dobara], Official gazette of the Republic of Serbia, No. 33/2012, Belgrade.
- Nonić, D. (2008). State forest administration and private ownership in the process of transition [Državna Uprava šuma i privatno vlasništvo u procesu tranzicije], Proceedings of the seminar "Forests on municipalities", Institute for Social and Economic Studies, Bijeljina, pp. 125-144.
- Nonić, D., Avdibegović, M., Nedeljković, J., Radosavljević, A., Ranković, N. (2014). Sustainable governance in forestry and nature protection, *Bulletin of the Faculty of Forestry*, Suppl. iss., pp. 113-140.
- Nurse, A. (2017). Criminalising the right to hunt: European law perspectives on anti-hunting legislation, *Crime, Law and Social Change*, Vol. 67, pp. 383-399.
- Ranković, N., Nedeljković, J., Nonić, D. (2017). Analysis of strategic documents related to hunting in Serbia from the perspective of the relationship between hunting and forestry [Analiza strateških dokumenata povezanih sa lovstvom u Srbiji iz perspektive odnosa lovstva i šumarstva], *Šumarstvo* 3-4 (in print)
- Sharp, R., Wollscheid, K.U. (2009). An overview of recreational hunting in North America, Europe and Australia. In: Dickson, B., Hutton, J., Adams, B. (Eds.) *Recreational Hunting, Conservation and Rural Livelihoods: Science and Practice*, Wiley-Blackwell, Oxford, pp. 25-38.
- Wam, H.K., Pedersen, H.C., Hjeljord, O. (2012). Balancing hunting regulations and hunter satisfaction: An integrated biosocioeconomic model to aid in sustainable management, *Ecological Economics*, Vol. 79, pp. 89-96.

## **INSTITUTIONAL FRAMEWORK, COOPERATION AND MEASURES FOR THE SERBIAN HUNTING SECTOR IMPROVEMENT**

Jelena NEDELJKOVIĆ<sup>1\*</sup>, Dragan NONIĆ<sup>1</sup>, Dragan GAČIĆ<sup>1</sup>, Slavko MLADENOVIĆ<sup>1</sup>,  
Mersudin AVDIBEGOVIĆ<sup>2</sup>

<sup>1</sup>University of Belgrade-Faculty of Forestry, Belgrade, Serbia

<sup>2</sup>University of Sarajevo-Faculty of Forestry, Sarajevo, Bosnia and Herzegovina

\*Corresponding author: jelena.nedeljkovic@sfb.bg.ac.rs

### **Abstract**

This paper presents the analysis of the institutional framework and measures for the improvement of the hunting sector in Serbia. In addition to that, the paper deals with cooperation and relations between institutions and organisations, in charge of several aspects of hunting in Serbia. For data collection, 13 face-to-face and e-mail interviews with hunting experts from public institutions (administration and services), and organizations (enterprises and associations) were conducted. The respondents' perception of the institutional framework of hunting, the current state of hunting grounds management, cooperation with other institutions and organizations and available measures for the improvement of the hunting sector were analyzed. Two respondents have a positive opinion about the work of public administration responsible for hunting. The largest number of them believes that the Forest Directorate lacks personnel and that improvements should be made in that direction. Only three respondents consider the current organization of hunting grounds management in public enterprises in Serbia satisfactory, while only one of them has the same opinion about hunting grounds management in hunting associations. The respondents have given the highest average grade to the cooperation with the Hunting Chamber of Serbia (4.4) and the lowest grade to the cooperation with the Hunting Association of Serbia (2.7). The majority of respondents notice the following obstacles to the improvement of the current state of hunting management: lack of funding, personnel structure, technical infrastructure and the system of organization. Around half of the respondents believe that an organized system of implementation of support measures for hunting development is present in Serbia. They explain that it is prescribed by the law (regulatory, financial, and informational measures). The other half of the respondents believes that Serbia is lacking such a system, because there is neither an overall hunting strategy nor an action plan. They stress that some measures exist (e.g. Budgetary Fund for Hunting Development, education organized by the Hunting Chamber), but also that these are not defined or implemented in a systematic way.

**Key words:** *hunting sector, institutions, organisations, cooperation, support measures*

### **Introduction**

Hunting is a multifunctional phenomenon that greatly contributes to the development of rural areas and tourism, and there is a clear connection between hunting and spatial planning (Fischer et al., 2013, Gačić et al., 2015). Therefore, management and decision making in hunting often involve many stakeholders and users with different and sometimes even opposing attitudes and goals (Dandy et al., 2012). In that sense, complex institutional frameworks have been developed to meet such different objectives and interests, which stem from the multifunctionality of hunting (Fischer et al., 2013). It is precisely through the



institutional frameworks that *"the implementation of national, regional and local politics is carried out"*, which has an impact on the development of the entire sector (2011). However, when it comes to the institutional framework, a *"wide range of organizations, incentives, mandate systems and regulations"* which *"affect the results of the sector"* should be taken into account (2005).

Hunting in Serbia has a long tradition and *"at the end of the 19<sup>th</sup> and the beginning of the 20<sup>th</sup> century it is described as unorganized, which inflicted damage both on game and the economy"* (2017). This was one of the reasons for the establishment of numerous hunting clubs and associations, which aimed to *"enable hunters to organize hunting and achieve one of the most important goals of modern hunting - sustainability of management"* (2017). In accordance with the current reform processes and the need to harmonize national legislation with EU regulations, the current Law on Wildlife and Hunting (2010) was adopted, which has led to changes in the organization of hunting in Serbia, such as, for example, the establishment of the Hunting Chamber, the obligation to adopt new planning documents (Hunting Development Strategy and the Hunting Area Development Program), to manage the Hunting Cadastre and the Central Database for all hunting grounds, and establish and maintain an information system on wildlife populations and their sites. However, the impact of the adopted laws and by-laws in the field of hunting, forestry, agriculture, nature protection and environmental protection will depend largely on their application, control of enforcement and possible amendments and harmonization (Danilović, Gačić, 2014).

The **aim** of this paper is to analyze institutional frameworks and measures for improving the state of hunting in Serbia, as well as cooperation between institutions and organizations responsible for different aspects of the hunting sector. The **subject** of this research are the views of hunting experts on this issue. The **purpose** is to provide recommendations for the improvement of institutional frameworks, measures and cooperation in the hunting sector, which would contribute to the creation of a consistent hunting and forest policy, and thus to the improvement of the management of the important national and "partly renewable" natural resources.

### **Material and method**

In this research we followed the qualitative research approach, which is often used in studying certain hunting-related issues (e.g. Arroyo et al., 2012, Dandy et al., 2012, Veríssimo, Campbell, 2015).

For data collection, 13 face-to-face and e-mail interviews with hunting professionals from public institutions (administration and services), and organizations (enterprises and associations) were conducted. The respondents were selected by using the judgmental sampling technique because we focused on the attitudes of those individuals who possess the knowledge and working experience related to the research problem.

The interviews were conducted during March 2017 and the questionnaire covered five thematic segments. It consisted of 21 questions, and in this paper, we analyzed answers to nine of them. In these questions, we first asked interviewees to express their opinions about the institutional framework of the hunting sector and the need for its improvement, as well as their attitudes towards the current organization of hunting grounds management. The next set of questions was related to institutional and cross-sectoral cooperation and here we asked the respondents to explain the cooperation with several institutions and organizations in charge of forestry and to evaluate it. The last set of questions analyzed in this paper was related to the measures for the improvement of the hunting sector in Serbia. With the interviewees we discussed the sources of funding for the improvement of the hunting sector and the available

measures. They also expressed the attitude towards the current system of measures and needs for its development and improvement.

The data were analyzed using the qualitative content analysis and matrix tables. Descriptive statistics was used for the analysis of data related to the respondent's evaluation of the current systems of wildlife protection and of penalizing persons engaged in illegal hunting.

### Results and discussion

Opinions of the respondents about the institutions and organizations responsible for national issues are different.

When it comes to the Forest Directorate (FD), as the state authority directly responsible for hunting, it was emphasized that this institution "*should be the major party in the coordination of hunting development*" (Int-11). However, respondents had different opinions about the work of the FD. Thus, two respondents consider that "*doing their job well*" (Int-4), that is, "*it is good that the FD has strengthened the capacities for performing hunting activities, first of all by establishing an organizational unit responsible for hunting*" (Int-1). Although they have a positive opinion on the work of the FD, these respondents also point out that the "*Inspection Service should have been strengthened*" (Int-4), that is, "*currently, there are not enough capacities to exercise control of the implementation of laws and by-laws regulating hunting*"(Int-1). Another 5 respondents believe that FD lacks staff engaged in hunting.

Regarding the work of the Hunting Association of Serbia (HAS), one respondent points out his positive opinion, stating that "*it is good that there is a unique HAS that respects the existence of regional hunting associations*", but also states that "*there is no clear HAS attitude regarding further development Hunting in Serbia, as well as the development of the Alliance itself*"(Int-1) Two respondents have a negative attitude towards the work of HAS, while others with a neutral attitude can be divided into two groups of respondents:

those who believe that HAS lacks professional staff (hunting experts);

those who believe that it is necessary to precisely define the function of HAS, and that this organization needs to be reorganized.

All respondents who answered the question regarding the improvement of the institutional framework of hunting (Table 1) consider that such a need exists, and suggested the following: to provide capacities for a smooth operation of the FD (equipment, personnel, finance, etc.); to improve the work of the FD in terms of better control over the implementation of regulations and the work of all its subjects.

The opinion of the respondents about the organization of hunting management in central Serbia varies and can be classified into (table 1): positive, neutral and negative opinions.

**Table 1.** Matrix of topics

Respondent	Improvement of the institutional framework		Is the organization of hunting grounds management satisfactory?		Existence of an organized system of the implementation of support measures for hunting improvement	Is there a system? Is it necessary for it to be improved?
	FD	HAS	PE	HA		
Int-1	n.d.	n.d.	+/-	+/-	+	+
Int-2	n.d.	n.d.	n.d.	n.d.	+	+
Int-3	+	idnk	-	-	+	+
Int-4	+	idnk	+	+/-	-	
Int-5	+	idnk	+	idnk	-	
Int-6	+	+	-	+/-	-	
Int-7	+	+	idnk	+/-	+	+
Int-8	+	+	-	-	+	+
Int-9	+	+	-	n.d.	-	
Int-10	+	+	n.d.	+/-	-	
Int-11	+	+	-	+/-	-	
Int-12	+	+	+/-	+/-	+	+
Int-13	+	+	-	-	-	

Legend: + advocates; - opponents; +/- indifferent; n.d. no data; idnk I do not know

In the group that has a positive opinion on the organization of hunting management in public enterprises (PE), one of the respondents states that *"the situation is satisfactory, but with a lot of potential for further improvement"*, that is, *"hunting is not on the list of priorities of PEs"* (Int-1). Another respondent believes that *"the organization has been improved: hunting services have been "lowered" to the level of forest estates. There is a sector as well as vertical jurisdiction and a hierarchy of responsibilities"* as well as *"within the forest estates, there are employees dealing exclusively with hunting (and fishing)"* (Int-5). On the other hand, respondents with a negative opinion (6 respondents) point out that *"there is a problem of recruiting inadequate staff"* (Int-9), and that *"there are laws and by-laws and everything works perfectly on paper, although it is different in operation"* (Int-11). Regarding the organization of hunting management in hunting associations (HA), one of the respondents states that the situation is satisfactory, but that there is room for improvements (Int-1). However, 7 respondents emphasize that the situation is *"partially satisfactory"* and that there are major differences between individual HAs, i.e., *"there are both very positive and unfortunately very negative cases"* (Int-4). All respondents believe that the organization of hunting management in Serbia can be improved through reorganization, with a clear definition of tasks and a strict application of regulations, i.e. *"a clear system establishment (defining roles and rules) and the prevention of interest grouping"* (Int-3), then by investing more funding in the development of hunting (Int-4) and better technical equipment (Int-7), as well as staff changes and education (Int-6). By all means, in order to ensure sustainable management of natural resources, there needs to be a systemic approach to identifying key issues and framework development, that will enable their unhindered solving, as well as to the process of planning and implementation and subsequent monitoring of the results (Nonić et al., 2014). Based on the views of the respondents, the main obstacles to the development of hunting are the following: financial resources (7 respondents), staff structure (11 respondents), poor technical equipment (for example, off-road vehicles) (8 respondents) and the organization system (9 respondents).

However, there is a contrary opinion, according to which (Int-1) *"there are no obstacles to the development of hunting because:*

*adequate funding has been provided, both from the funds of the users of hunting grounds, and from the budget fund for the development of hunting;*

*formally educated staff are working in hunting grounds, with a compulsory annual training through the work of the Hunting Chamber;*

*the users of hunting grounds are equipped with vehicles and information technologies;*

*the organization of hunting is adapted to the current situation and is not imposed by any regulation".*

It should be emphasized that public authorities, especially those responsible for forestry and nature protection, are not only in Serbia, but also in other countries responsible for adopting strategies that must be in line with public and private interests. This requires that decision-makers have information on the views of different stakeholders (Dandy et al., 2011), which points to the need for cross-sectoral cooperation, with the aim of sustainable management of hunting grounds.

Table 2 lists **institutions and organizations** that are directly or indirectly involved in the hunting sector of Serbia. In addition to that, the forms of cooperation with the institutions and organizations indicated by the respondents, as well as the average grades of the assessed success of cooperation are listed below.

**Table 2.** Institutional and cross-sectoral cooperation

Institutions and organizations	Form of cooperation	Average grade
--------------------------------	---------------------	---------------

		for cooperation success (1-5)*
<b>Public administration</b>		
<b>Ministry of Agriculture and Environmental Protection</b>		
Forest Directorate	Design and adoption of hunting plans Control of hunting ground users Allocation of funds from the budget fund for forests	4.2
Veterinary Directorate	FD cooperates with it when adopting regulations (harmonization) Meat trade and defining solutions for the export of game meat (especially small game)	3.9
Sector for Environmental Protection	FD cooperates with it when adopting regulations (harmonization) Issuance of the CITIES certificate	3.3
<b>Ministry of Defence</b>	Management of some hunting grounds Aid to users of hunting grounds in case of flooding, etc.	3.0
<b>Ministry of Internal Affairs</b>	- Aid to game wardens	3.7
<b>Public prosecution</b>		
	Reporting and processing of persons engaged in illegal hunting	4.0
<b>Public services (professional institutions)</b>		
Nature Conservation Institute of Serbia (NCIS)	FD cooperates with it in the production of professional documents Defining of conditions for the creation of planning documents and settling of game	3.9
<b>PE for the management of state forests</b>		
PE „Srbijašume“	FD gives consent on planning documents and controls the implementation of laws, while also providing support to the implementation of management measures	3.7
<b>PEs of national parks</b>		
PE NP Đerdap	FD gives consent on planning documents and controls the implementation of laws, while also providing support to the implementation of management measures NCIS cooperates with it in the creation of hunting plans	3.7
PE NP Tara	FD gives consent on planning documents and controls the implementation of laws, while also providing support to the implementation of management measures NCIS cooperates with it in the creation of hunting plans PE Srbijašume – Joint project for wild goat reintroduction	3.6
PE NP Kopaonik	FD gives consent on planning documents and controls the implementation of laws, while also providing support to the implementation of management measures NCIS cooperates with it in the creation of hunting plans	3.6
<b>Educational and research organizations</b>		
Faculty of Forestry	Scientific and research work	4.0
Faculty of Veterinary Medicine	PE Srbijašume: Creation of a study on the construction of facilities for meat storage	4.3
<b>Hunting organizations</b>		
Hunting Association of Serbia	FD controls and supports the implementation of management measures NCIS cooperates with it in the creation of hunting plans	2.7
Hunting Association of Central Serbia	FD controls and supports the implementation of management measures NCIS cooperates with it in the creation of hunting plans	3.2
Serbian Hunting Chamber	Education of the staff employed in the hunting sector Issuance of licenses	4.4
<b>Other organizations</b>		
Serbian Orthodox Church	HAS cooperates with the Serbian Orthodox Church in forest areas that were given back to the church in the process of restitution	4.0

\*1 (very bad); 2 (bad); 3 (neither good nor bad); 4 (good); 5 (very good)

The respondents cooperate with competent ministries, public services, state forest management enterprises and national parks, scientific and educational organizations and the Serbian Orthodox Church. The respondents gave the highest average grade (4.3) to cooperation with the Hunting Chamber, which educates hunting personnel and issues licenses, while the lowest rating (2.7) was given to the cooperation with the HAS. Cooperation between different stakeholders takes place in one of the following ways: drafting and passing of regulations (FD and the Veterinary Directorate and the Sector for Environmental Protection);

drafting, defining of the conditions and giving consent to the planning documents (FD and the Institute for Nature Conservation of Serbia between each other and with the users of hunting grounds);

control of the implementation of laws (FD with the users of hunting grounds);

issues related to trade in meat and game trophies (Users of Hunting grounds with the Veterinary Directorate and the Sector for Environmental Protection);

aid to the users of hunting grounds in case of natural disasters (Users of hunting grounds with the Ministry of Defence);

issues related to illegal hunting (Hunting Area users with the Ministry of Internal Affairs and the Public Prosecutor's Office);

education and scientific research (and hunting personnel with the Faculty of Forestry, Veterinary Faculty and the Hunting Chamber).

**Support measures** provided to users can be grouped into: 1) regulatory, 2) economic, and 3) information measures (Janota, Broussard, 2008). Regulatory measures are prescribed by strategies, laws and bylaws, and provide a real and sound basis for the development of the sector. Economic measures are related to financial support, while information measures are necessary help from the state, and they are implemented through the activities of counseling, education and propaganda (Nonić, 2015). Respondents believe that all types of support measures are present in the hunting sector of Serbia, but that they are mostly regulatory and financial (only 3 respondents reported information measures). They listed the adoption of regulations and the control of implementation as regulatory measures, and as financial measures they listed the use of funds from the Budget Fund for Forests<sup>56</sup>. Information measures refer to the training organized by the Hunting Chamber.

Respondents have different opinions regarding the existence of an organized system for implementing measures for the promotion of hunting in Serbia (Table 1).

About half (7) of the respondents consider that such a system does not exist, for the following reasons: "*there is no strategic umbrella document that defines long-term goals*" (Int-5), that is, "*there is neither a strategy, nor an Action Plan*" (Int-6); "*laws and regulations are not enforced*" (Int-13); "*there is no continuous training of hunters, nor the financial resources provided at the annual level for each individual HA*" (Int-4).

In order for this system to be established, it is necessary to: "*adopt the strategy and define measures, objectives, etc.*" (Int-5), as well as "*strict compliance with laws and procedures*" (Int-6).

The respondents who believe that there is an organized system for implementing measures for the development of hunting (6 respondents), explain that it is "*envisaged by the Law on game and hunting, because there is no adopted Strategy for Hunting Development*" (Int-1). In this regard, the respondents propose the adoption of a national strategy of the hunting sector as an improvement of this system, since "*the improvement of the general system of support for the development of hunting would be achieved by passing an umbrella strategic document that would define the directions of development in the hunting sector in Serbia with guidelines for its improvement*" (Int-2). They also believe that "*although there are clearly defined regulatory and financial measures that are prescribed and implemented by the FD*" (Int-3), it is necessary to "*create information measures that are currently lacking*" and, above all, "*deal with the development of a central database that is very important, for decision making, planning and everything else in hunting*" (Int-3).

---

<sup>56</sup> Funding is provided from the budgetary fund for the development of hunting of the Republic of Serbia and the budgetary fund for the development of hunting in the autonomous province (§78 of the Law on Wildlife and Hunting), which are "*financed from the revenues generated from the fee for the use of hunted protected game species and the hunting ticket*"(2010). In addition, the respondents indicated that HAs provide funding from membership fees, donations, issuing of facilities, local government assistance, etc.

## Conclusions

Based on the results obtained in this study, it can be concluded that: the institutional framework consists of public administration responsible for hunting, veterinary services, environment, defence and internal affairs, as well as professional services in nature protection, the court and the prosecutor's office, PEs in forestry and nature protection, as well as scientific and educational, hunting and other organizations; Most respondents consider that the main obstacles to the development of hunting in Serbia are financial resources, personnel structure, poor technical equipment and the system of organization; respondents are the most satisfied with their cooperation with the Hunting Chamber (average grade 4.3), and least satisfied with their cooperation with HAS (average grade 2.7); financial resources for improving the state of hunting in Serbia are provided in several ways, but primarily from the budget fund for the development of hunting; support measures are regulatory, economic and informational, and respondents have different opinions about the existence of an organized system of implementation of support measures. The basic recommendations for the improvement of the institutional framework, measures and cooperation in the hunting sector are: drafting and adoption of a Strategy for the Development of Hunting in Serbia, i.e. an umbrella strategic document that should define support measures and their implementation; involvement of scientific-professional institutions and experts in the field of hunting in the process of drafting and passing of legislation. improvement of the personnel capacities of the FD and the improvement of cooperation with the HAS; more intensive and better education in the field of hunting with the protection of hunting fauna; the formulation of information support measures, as well as the practical application of regulatory frameworks. However, the improvement of the current situation must be based on an adequate combination of all hunting policy instruments (regulatory, economic and informational) resulting in the creation of a so-called "smart-regulation" approach.

## Acknowledgement

This study was conducted within the project: "Research of the causes and consequences of the disappearance of deer game in central Serbia, defining areas suitable for reintroduction (settlement) and measures for improving the reintroduction process - Phase I", financed by the Ministry of Agriculture and Environmental Protection - Directorate for Forests of the Republic of Serbia.

## References

- Arroyo, B., Delibes-Mateos, M., Díaz-Fernández, S., Viñuela, J. (2012). Hunting management in relation to profitability aims: red-legged partridge hunting in central Spain, *European Journal of Wildlife Research*, Vol. 58, pp. 847-855.
- Dandy, N., Ballantyne, S., Moseley, D., Gill, R., Peace, A., Quine, C. (2011). Preferences for wildlife management methods among the peri-urban public in Scotland, *European Journal of Wildlife Research*, Vol. 57, pp. 1213-1221.
- Dandy, N., Ballantyne, S., Moseley, D., Gill, R., Quine, C., Van Der Wal, R. (2012). Exploring beliefs behind support for and opposition to wildlife management methods: a qualitative study, *European Journal of Wildlife Research*, Vol. 58, pp. 695-706.

- Danilović, M., Gačić, D. (2014). Sustainable use of forest and hunting resources, *Bulletin of the Faculty of Forestry, Suppl. iss.*, pp. 25-50.
- Fischer, A., Sandström, C., Delibes-Mateos, M., Arroyo, B., Tadie, D., Randall, D., Hailu, F., Lowassa, A., Msuha, M., Kereži, V., Reljić, S., Linnell, S., Majić, A. (2013). On the multifunctionality of hunting – an institutional analysis of eight cases from Europe and Africa, *Journal of Environmental Planning and Management*, Vol. 56 (4), pp. 531-552.
- (2005). *Forest institutions in transitions: Experiences and lessons from Eastern Europe. PROFOR book number 4*, The World Bank, Washington.
- Gačić, D., Prentović, R., Pilipović, V., Ostojić, M. (2015). Hunting tourism and safety aspects of hunting fauna use in Serbia, *Bulletin of the Faculty of Forestry, Suppl. iss.*, pp. 45-54.
- Janota, J.J., Broussard, S.R. (2008). Examining private forest policy preferences, *Forest Policy and Economics*, Vol. 10 (3), pp. 89-97.
- (2010). Law on game and hunting, [Zakon o divljači i lovstvu], *Official gazette of the Republic of Serbia*, No. 18/2010, Belgrade.
- Nonić, D. (2015). Organization and business administration in forestry, [Organizacija i poslovanje u šumarstvu-udžbenik], electronic source, University of Belgrade-Faculty of Forestry, Belgrade.
- Nonić, D., Avdibegović, M., Nedeljković, J., Radosavljević, A., Ranković, N. (2014): Sustainable governance in forestry and nature protection, *Bulletin of the Faculty of Forestry, Suppl. iss.*, pp. 113-140-
- (2011). *State of Europe's Forests 2011 - Status and Trends in Sustainable Forest Management in Europe*, FOREST EUROPE, Liaison Unit Oslo, Oslo.
- (2017). The first one hundred years [Prvih sto godina], *Hunting Association of Serbia*, [http://www.ekolss.com/prvih\\_sto\\_godina.htm](http://www.ekolss.com/prvih_sto_godina.htm), accessed 15.05.2017.
- Veríssimo, D., Campbell, B. (2015). Understanding stakeholder conflict between conservation and hunting in Malta, *Biological Conservation*, Vol. 191, pp. 812-818.

## IMPACT OF THE FUNGAL PATHOGEN *ENTOMOPHAGA AULICAE* ON BROWNTAIL MOTH PARASITOIDS

Mara TABAKOVIĆ-TOŠIĆ\*, Marija MILOSAVLJEVIĆ

Department of Forest Protection, Institute of Forestry Belgrade, Serbia

\*Corresponding author: mara.tabakovic@gmail.com

### Abstract

In the period 2015-2016, parasitoids of the order Diptera of the browntail moth *Euproctis chrysorrhoea*, some of the most economically harmful, outbreaking species of forest defoliators, were studied in 12 forest stands in the region of Novi Pazar (south-west Serbia), in which the browntail moth increased its numbers and where the entomopathogenic fungus *Entomophaga aulicae* was found. In the investigation period, 40 newly browntail moth litters were collected and analyzed. In the litters, there were 388 pupae, of which 23% were parasites from the order Diptera. Host mortality caused by parasitoids in different localities varied from 11.2% to 33.1%. A total of 89 Diptera pupae were reared from browntail moth pupae. Out of these, 83 died as pupae, resulting in an extremely high overall mortality of 93.2%. Only six tachinid adult specimens of 2 species (*Compsilura concinnata* and *Exorista larvarum*) emerged from tachinid pupae. In a detailed microscope survey, *E. aulicae* resting spores were observed on the surface of 72.8%, but not in internal tissues of the dead pupae. The lack of resting spores inside the dead Diptera pupae is an indication of the absence of direct effect of fungal pathogens on parasitoids. The Diptera evidently does not become infected by *E. aulicae* while parasitizing the infected host, but the presence of resting spores on the surface of Diptera puparia is the evidence of the development of the entomopathogenic fungus in parasitized browntail moth larvae and pupae. The causes of Diptera mortality during their development in host parasitized by *E. aulicae* have not been clear enough but it is likely a result of the competition between the fungus and parasitoids.

**Key words:** *Entomophaga aulicae*, impact, browntail moth, parasitoids.

### Introduction

The browntail moth *Euproctis chrysorrhoea* (Linnaeus, 1758) (Lepidoptera: Erebidae), is one of the major serious defoliators of broadleaved forests and orchards throughout Europe. It is characterised by high reproductive capacity, considerable ecological plasticity and polyphagia (26 genera of trees and shrubs belonging to 13 different families). Browntail moth populations undergo periodic outbreaks to extremely high densities. Although it is found in many European countries, the pest causes the greatest damage to the forests of Balkan Peninsula, which have all the favourable environmental conditions for browntail moth development, and it often increases its number. In Serbia, it occurs periodically in high numbers (outbreak) on a relatively small area of a few hundred hectares.

The population density of *E. chrysorrhoea* is regulated by many biotic factors – parasitoids, predators and pathogens (microsporidial and fungal diseases), as well as intraspecific competition. Based on the literature data, more than 60 insect species of parasitoids have been reported in Europe as natural enemies of browntail moth. Regarding the number of the species, the representatives of Diptera and Hymenoptera orders are the most frequent and



most important ones (Cerretti & Tschorsnig, 2010; Hubenov, 2008; Shima, 2006; Vaňhara et al., 2009).

The fungal order Entomophthorales in the class Entomophthoromycetes (Humber, 2012) is mainly composed of obligate pathogens that infect arthropods. More than 300 species within fam. Entomophthoraceae are well-known for their ability to cause dramatic epizootics in populations of aphids, leafhoppers and planthoppers, flies, grasshoppers, cicadas, and coleopteran and lepidopteran larvae (Georgiev et al., 2010; Hajek, 1999; Keller, 1987, Mirchev et al., 2013; Pilarska et al., 2001; Tabaković-Tošić et al., 2012; Tabaković-Tošić, 2014), and play an important role in regulation host populations under certain conditions.

Entomopathogenic fungus *Entomophaga aulicae* (Reichardt in Bail) Humber (Entomophthoromycotina: Entomophthorales, Entomophthoraceae) is a widespread Holarctic species, with many host insects from the order Lepidoptera [Arctiidae: *Spilosoma niveum* (Memetries); Geometridae: *Enypia griseata* (Grossbeck), *Lambdina fiscellaria* Guenée, *Lambdina fiscellaria lugubrosa* (Hulst), *Rheumaptera hastate* (Linnaeus); Lasiocampidae: *Dendrolimus spectabilis* (Butler), *Malacosoma disstria* Hübner; Erebidae: *Euproctis chrysorrhoea* (Linnaeus), *Orgyia vetusta* Boisduval, *Estigmene acraea* (Drury); Noctuidae: *Aedia leucomelas* (Linnaeus), *Autographa gamma* (Linnaeus), *Mamestra brassicae* (Linnaeus), *Pseudaletia* sp.; Notodontidae: *Heterocampa biundata* Walker, *Heterocampa guttivitta* (Walker), Pieridae: *Colias erate poliographus* Motschulsky; Saturniidae: *Dryocampa rubicunda* (Fabricius), Sphingidae: *Eumorpha fasciata* (Sulzer); Tortricidae: *Choristoneura fumiferana* (Clemens)] including some of the most economically harmful, outbreaking species of forest defoliators (*L. fiscellaria*, *L. fiscellaria lugubrosa*, *D. spectabilis*, *M. disstria*, *O. vetusta*, *H. guttivittata*, *C. fumiferana*, *E. chrysorrhoea*, *E. acraea*, *E. griseata*) (Hajek et al., 1991; Humber & Hansen, 2005).

In biological control programs it is important to evaluate impact on other biological agents of the target host. This is especially true for the parasitoids in the family Tachinidae, which are strongly associated with late instar browntail moth larvae and pupae, where *E. aulicae* also develops but insufficient information in entomological literature occurs.

### Material and Methods

The studies were conducted during the growing season in the period 2015-2016, in 12 forest stands (Table 1) in the region of Novi Pazar (south-west Serbia: Public Enterprise Srbijašume, Forest Estate Šumarstvo Raška, Forest Administration Novi Pazar), in which the browntail moth increased its numbers and where the entomopathogenic fungus *E. aulicae* was found.



Figure 1. Browntail moth larval litter (A) and imago of tachinid on them (B).

In the investigation period, 40 newly litters (Figure 1) were collected, transported to the laboratory of Institute of Forestry (Belgrade) and then analysed. Individual Diptera and browntail moth dead pupae were placed in Petri dishes with wet filter paper (relative humidity of 75-80% was maintained in order to prevent drying of pupae). They were kept 7 days in the laboratory and then stored in the refrigerator for 3 months.

Microscopic examination of dead Diptera and *E. chrysorrhoea* pupae were carried out using a MOTIC optical Trinocular, model Sextuple BA410E, equipped with a camera MOTICAM 10.0 (10 Mpix, 12.5", CMOS, MOTIC), and for processing the measurements of *E. aulicae* hyphal bodies, primary conidia and resting spores the software Motic Images Plus 2.0 ML, gauging with the MT-40X was used.

The evaluation of *E. aulicae* infections was recorded as positive when fungal structures were detected in dead Diptera and browntail moth pupae. The species identification was based on the size, shape and structural characteristics of different microstructures of the fungus (Humber, 1984; Keller, 1987; Keller & Petrini, 2005).

Table 1. The main characteristics of the stands, where samplings of browntail moth caterpillars litters were done.

Plot	Management Unit	Coordinates	Altitude (m a.s.l.)	Slop of the terrain and exposure	Coenocological unit of forest stand
1	Blizanac – Debelica 29/a	X: 4 783 502 Y: 7 454 574	889	6-15° E - NE	<i>Quercetum petraeae-cerris</i>
2	Blizanac – Debelica 30/a	X: 4 784 189 Y: 7 454 691	863	6-15° N - NE	<i>Quercetum petraeae-cerris</i>
3	Ninaja – Koznik 17/a	X: 4 778 540 Y: 7 450 929	980	16° S	<i>Quercetum petraeae-cerris</i>
4	Ninaja – Koznik 21/a	X: 4 777 365 Y: 7 453 717	920	16° S - JE	<i>Quercetum petraeae-cerris</i>

5	Ninaja – Koznik 22/a	X: 4 774 038 Y: 7 449 982	930	16-20° JE	<i>Quercetum petraeae- cerris</i>
6	Ninaja – Koznik 75/c	X: 4 772 140 Y: 7 454 730	960	16-20° N	<i>Fagetum moesiaca montanum</i>
7	Ninaja – Koznik 84/b	X: 4 774 460 Y: 7 489 220	810	21° E	<i>Quercetum petraeae- cerris</i>
8	Ninaja – Koznik 85/b	X: 4 775 001 Y: 7 448 624	920	16-20° E	<i>Quercetum petraeae- cerris</i>
9	Turjak – Vršine 89/b	X: 4 774 038 Y: 7 449 982	853	21-25° W - NW	<i>Fagetum moesiaca montanum</i>
10	Turjak – Vršine 89/a	X: 4 774 133 Y: 7 451 501	850	21-25° W - NW	<i>Fagetum moesiaca montanum</i>
11	Turjak – Vršine 90/a	X: 4 773 471 Y: 7 452 257	897	16-20° SW	<i>Quercetum petraeae- cerris</i>
12	Turjak – Vršine 93/a	X: 4 775 033 Y: 7 451 039	690	21-25° S - SE	<i>Quercetum petraeae- cerris</i>

## Results and discussion

Order Diptera occupies an important place among the parasitoids, not only by the richness of species and wide geographical distribution but also because they parasitize a large number of economically important insect pests. In 40 newly browntail moth litters, there were 388 pupae, of which 23% were parasites from the order Diptera. Host mortality caused by parasitoids in different localities varied from 11.2% to 33.1%. A total of 89 Diptera pupae were reared from browntail moth pupae. Out of these, 83 died as pupae, resulting in an extremely high overall mortality of 93.2%. Only six tachinid adult specimens of 2 species [*Compsilura concinnata* (Meigen) and *Exorista larvarum* Linnaeus] emerged from tachinid pupae.

In a detailed microscope survey, *E. aulicae* primary conidia and resting spores, which the morphological data [the mean dimensions of resting spores are 44.1 µm (33.7 – 49.7 µm; n=213)] (Figure 2) correspond to descriptions given by MacLeod & Müller-Kögler (1973), Hamm (1980), Pilarska et al. (2001), and Kalkar & Carner (2005), were observed on the surface of 72.8%, but not in internal tissues of the dead pupae. In addition, the presence of primary conidia of this pathogen species was reported, but the number of them was considerably smaller (Figure 2). The lack of resting spores inside the dead Diptera pupae is an indication of the absence of direct effect of fungal pathogens on parasitoids. The Diptera evidently does not become infected by *E. aulicae* while parasitizing the infected host, but the presence of resting spores on the surface of Diptera puparia is evidence of the development of the entomopathogenic fungus in parasitized browntail moth larvae.



Figure 2. Resting spores and primary conidia isolated from dead Diptera pupae.

The causes of Diptera mortality during their development in browntail moth larvae which have been parasitized by *E. aulicae* are not clarified but it is likely a result of the competition between the fungus and parasitic Diptera. *E. aulicae* has become the primary biological control agent in browntail moth populations in Novi Pazar region, but its impact on other natural enemies of browntail moth is still not well known. Additional studies are needed to clarify the specific causes of mortality of Diptera parasitoids in order to obtain an objective assessment of the impact of *E. aulicae* on browntail moth and role of the pathogen in programs for biological control of the pest.

### Conclusion

In this study which were conducted during the growing season in the period 2015-2016, in 12 forest stands in the region of Novi Pazar (south-west Serbia), higher mortality of Diptera pupae (93.2%) was established during their development in browntail moth larvae and pupae infected with *E. aulicae*, in comparison to a similar study in in Serbia and Bulgaria (Tabaković-Tošić et al, 2014; Georgiev et al., 2013) higher mortality of tachinid (Diptera) pupae (97.1% and 86.5%) were established during their development in gypsy moth larvae infected with *E. maimaiga*, hypothesized that, during fungal development, nutritional resources available to the parasitoids decrease, limiting available energy for successful pupation and eclosion.

### Acknowledgment

The study was partly financed by the Ministry of Science of the Republic of Serbia, the Project 31070 - SUBPROJECT: New technological methods in the integral protection of forests with the focus on the entomopathogenic fungus *Entomophaga maimaiga*, as the possible solution to the problem regarding the frequent occurrences of the outbreak of gypsy moth in the forest ecosystems of Serbia.

### References

- Cerretti, P., Tschorsnig, HP. (2010). Annotated host catalogue for the Tachinidae (Diptera) of Italy. Stuttgarter Beiträge zur Naturkunde A, Neue Serie, 3, 305-340.
- Georgiev, G., Pilarska, D., Mirchev, P., Rossnev, B., Petkov, P., Pilarski, P., Golemanski, V., Todorov, M., Takov, D., Hubenov, Z., Georgieva, M., Matova, M., Kitanova, S. (2010). *Entomophaga maimaiga* – a factor for increasing stability and enhancing biodiversity in oak forests on the Balkan Peninsula. Proceedings of International Scientific Conference – Forest ecosystems and climate changes, Institute of Forestry (Rakonjac Lj, Eds), Belgrade, Serbia, Vol. 1, 181-185.
- Georgiev, G., Hubenov, Z., Georgieva, M., Mirchev, P., Matova, M., Solter, L.F. et al. (2013). Interactions between the introduced fungal pathogen *Entomophaga maimaiga* and indigenous tachnid parasitoids of gypsy moth, *Lymantria dispar* L. (Lepidoptera: Erebidae) in Bulgaria. *Phytoparasitica*, 41, 125-131.
- Hajek, A.E. (1999). Pathology and Epizootiology of *Entomophaga maimaiga* Infections in Forest Lepidoptera. *Microbiology and Molecular Biology Reviews*, 63(4), 814-835.
- Hajek, A.E., Humber, R.A., S. Walsh, R.A., Silver, J.C. (1991). Sympatric occurrence of two *Entomophaga aulicae* (Zygomycetes: Entomophthorales) complex species attacking forest Lepidoptera. *Journal of Invertebrate Pathology*, 58, 373–380.
- Hamm, J.J. (1980). Epizootics of *Entomophthora aulicae* in lepidopterous pests of sorghum. *Journal of invertebrate pathology*, 36, 60-63.

- Hubenov, Z. (2008). Composition and zoogeographical characteristics of the family Tachinidae (Diptera: Insecta) in Serbia and Bulgaria. *Advances in Arachnology and Developmental Biology. Papers dedicated to Prof. Dr. Božidar Čurčić, S. E. Makarov & R. N. Dimitrijević (eds). Inst. Zool., Belgrade; BAS, Sofia; Fac. Life Sci., Vienna; SASA, Belgrade & UNESCO MAB Serbia. Vienna – Belgrade – Sofia, Monographs*, 12, 375-394.
- Humber, R.A. (1984). The identity of Entomophaga species (Entomophthorales: Entomophthoraceae) attacking Lepidoptera. *Mycotaxon*, 21, 265-272.
- Humber, R.A. (2012). Entomophthoromycota: a new phylum and reclassification for entomophthoroid fungi. *Mycotaxon*, 120, 477-492.
- Humber, R.A., Hansen, K.S. (2005). ARSEF INDEX: fungus-hostlocation. USDA-ARS Plant Protection Research Unit, Ithaca, NY.
- Kalkar, Ö., Carner, G.R. (2005). Characterization of the Fungal Pathogen, Entomophaga aulicae (Zygomycetes: Entomophthorales) in Larval Populations of the Green Cloverworm, Plathypena scabra (Lepidoptera: Noctuidae). *Turkish Journal of Biology*, 29, 243-248.
- Keller, S. (1987). Arthropod pathogenic Entomophthorales of Switzerland I. Conidiobolus, Entomophaga, and Entomophthora. *Sydowia*, 40, 122-167.
- Keller, S., Petrini, O. (2005). Keys to the identification of the arthropod pathogenic genera of the families Entomophthoraceae and Neozygitaceae (Zygomycetes) with descriptions of three new subfamilies and new genus. *Sydowia*, 57(1), 23-53.
- MacLeod, D.M., Müller-Kögler, E. (1973). Entomopathogenous fungi: Entomophthora species with pear-shaped to almost spherical conidia (Entomophthorales: Entomophthoraceae). *Mycologia*, 65, 823-893.
- Mirchev, P., Linde, A., Pilarska, D., Pilarski, P., Georgieva, M., Georgiev, G. (2013). Impact of Entomophaga maimaiga on gypsy moth populations in Bulgaria. *IOBC-WPRS Bulletin*, 90, 359-363.
- Pilarska, D., Zimmermann, G., Linde, A., McManus, M., Pilarski, P., Takov, D. (2001). On the occurrence of Entomophaga aulicae in high density brown-tail moth (Euproctis chrysorrhoea L.) populations in Bulgaria. *Proceedings of Third Balkan Scientific Conference 'Study, Conservation and Utilisation of forest Resources', Naydenova, T. et al. (Eds.), Sofia, Bulgaria, Vol. III, 139-143.*
- Shima, H. (2006). A host-parasite catalog of Tachinidae (Diptera) of Japan. *Makunagi Acta Dipterologica*, 2, 1-171.
- Tabaković-Tošić, M. (2014). Suppression of gypsy moth population in Mountain Avala (Republic of Serbia) by introduction of entomopathogenic fungus Entomophaga maimaiga. *Comptes rendus de l'Académie bulgare des Sciences*, 67(1), 61-66.
- Tabaković-Tošić, M., Georgiev, G., Mirchev, P., Tošić, D., Golubović-Čurguz, V. (2012). Entomophaga maimaiga – New entomopathogenic fungus in the Republic of Serbia. *African Journal of Biotechnology*, 11(34), 8571-8577.
- Tabaković-Tošić, M., Georgieva, M., Hubenov, Z., Georgiev, G. (2014). Impact of tachinid parasitoids of gypsy moth (Lymantria dispar) after the natural spreading and introduction of fungal pathogen Entomophaga maimaiga in Serbia. *Journal of Entomology and Zoology Studies*, 2(5), 134-137.
- Vaňhara, J., Tschorsnig, H-P, Herting, B., Mückstein, P., Michalková, V. (2009). Annotated host catalogue for the Tachinidae (Diptera) of the Czech Republic. *Entomologica Fennica*, 20, 22-48.

## VEGETATIVE PROPAGATION OF ELITE TREES OF CORNUS MAS L. IN THE BELGRADE AREA BY SOFTWOOD CUTTINGS

Marija MARKOVIĆ\*, Dragana SKOČAJIĆ, Mihailo GRBIĆ, Matilda ĐUKIĆ

University of Belgrade, Faculty of Forestry, Kneza Visislava 1, 11030 Belgrade, Serbia

\*Corresponding author: marija.markovic@sfb.bg.ac.rs

### Abstract

The Cornelian cherry is ornamental, low maintenance, drought-resistant species, which has the high potential for sustainable organic production as valuable fruit species. It can grow on shallow soils and on the different soil types, from sandy to clay soils, having good potential as a species for erosion control. In this study, the effect of cutting type and auxine concentration on rooting of softwood cuttings of cornelian cherry was investigated. Different types of cuttings were taken from selected mother trees in the urban forest in Belgrade area. Cuttings were treated with auxine (0.2% or 1.0% IBA, indole-3-butyric acid) before sticking and rooted under intermittent mist. The obtained data (the rooting percentage, the number and length of primary roots, the frequency and the number of secondary roots) were statistically analysed and the obtained results showed that cutting type, cutting size and auxine concentration influenced rooting of cuttings. Cutting length didn't affect rooting percentage but affected the number of primary roots and the longer cuttings had more primary roots. Best results (more than 90% rooted cuttings) were achieved with terminal cuttings treated with 1% IBA.

**Keywords:** *Cornus mas*, IBA, green cuttings, auxine, vegetative propagation.

### Introduction

The cornelian cherry (*Cornus mas* L., fam. *Cornaceae*) is a medium to large deciduous shrub or small tree, growing on warm and sunny forest margins, open forests, and coppices on dry and warm slopes, in altitudes of up to 1400 meters. It is native to Southern Europe and Southwest Asia. The Cornelian cherry is low maintenance, undemanding plant, which can grow on the different soil types, from sandy to clay soils, as well as on shallow soils. Also, it is drought-resistant species, suitable for hedges, anti-erosion protection and for planting in urban areas, tolerating high levels of air pollution (Mratinić, Kojić, 1998, Bijelić et al., 2012b, Dokupil, Řezniček, 2012). Furthermore, Cornelian cherry is important honey plant, which blooms early in the spring. Its fruit is red drupe, ripening from August to September. *C. mas* has high potential for organic production as valuable fruit species, having good yield potential even without special care (Demir, Kalyoncu, 2003, Cakmakci, Tosun, 2010, Bijelić et al., 2012b). Its wood is strong and extremely dense, and valuable in carpentry (Mratinić, Kojić, 1998).

The Cornelian cherry could be mass-propagated by seed or cuttings (Piotto, Di Noi, 2001). Generative propagation is complicated and time demanding due to long stratification period (18-36 weeks) and not very high germination rate (50-60%) (Piotto, Di Noi, 2001). The propagation by softwood cuttings is simple method which could be recommended for production of *C. mas* (Bijelić et al., 2012a, Klimentenko, 2004, Korszun and Kolasinski, 2002, Marković et al., 2014a,b, Yalcinkaya et al., 1999).

*C. mas* is rarely grown species in the Belgrade area, and its planting should be promoted according to the principles of natural landscaping which promote the use of native plant species instead of neophytes as way of "creative conservation" of the wild, local genotypes (Marković, 2013). Therefore, possibility of propagation of local superior

genotypes in Belgrade area was investigated in order to establish the method for obtaining high quality and well adapted planting material (Marković et al., 2014a,b). Previous research investigated the effect of application method and concentration of indole-3-butyric acid (IBA), the influence of cutting type (apical or single-node) and the influence of time of taking cuttings on rooting of softwood cuttings of selected *C. mas* trees from the Belgrade area (Marković et al., 2014a,b). However, some researchers report that cutting size have considerable influence on rooting and the further survival of rooted cuttings (Beyl et al., 1995, Burgess et al., 1990, Gerrakakis and Özkaya, 2005, Gopale and Zunjarrao, 2011, Vigl and Rewald, 2014, Yang et al., 2015). Thus, the aim of this study was to investigate the influence of cutting size on rooting of selected *C. mas* trees.

### **Material and method**

The group of *C. mas* vigorous and healthy trees in the natural population in Belgrade area (Miljakovacka forest ) was selected. In July, from the selected trees, 2 groups of cutting were taken. The first group consisted of 4 types of cuttings: (1) terminal cuttings with current season's wood only, (2) terminal cuttings with a section of 2-year-old wood, (3) single-node cuttings with current season's wood only, (4) single-node cuttings with a section of 2-year-old wood, and the second group consisted of same types of cuttings as first one, but all cuttings were longer with one more node. The cuttings were treated by 0,15% dilution of fungicide Previcur and then their base was dipped in dust preparation of 0.2% or 1% IBA. In the control the auxine treatment was omitted. The rooting was performed in sand, under intermittent mist, in greenhouse of the Faculty of Forestry, Belgrade.

Rooting percentage and other parameters such as the number and length of primary roots, as well as the frequency and the number of secondary roots were determined 10 weeks after placing of cuttings. Eight explants were used per treatment with three replications. The significance of differences between the means was determined by the analysis of variance (ANOVA,  $p < 0.05$ ) and the least significant difference (LSD) test. Before the analysis, arcsine transformation was used to convert the percentage data.

### **Results and discussion**

After the removal from sand, the cuttings were classified into four categories: rooted cuttings, unrooted with callus, necrotic, unchanged cuttings. The obtained results varied depending on cutting type and IBA concentration (Table 1). However, IBA concentration strongly affected rooting rate, and the best results were achieved with cuttings treated with 1% IBA where rooting percentage was higher than 63%, in most cases ranging between 87% and 97% (Table 1). Cuttings treated with 0.2% IBA had lower rooting percentage, but the obtained results differed depending on cutting type, and the better results were achieved with terminal and nodal cuttings only with current season's wood than with cuttings containing a section of 2-year-old wood. However, in the control, the nodal cuttings with 2-year-old wood had highest rooting rate.

Table 1 State of cuttings ten weeks after sticking

Cutting type	Hormone	State of cuttings			
		rooted (%)	unchanged (%)	callusing (%)	necrotic (%)
nodal cuttings	0.2% IBA	75.0ef	0.0a	0.0a	25.0bcd
nodal cuttings + node		50.0cde	0.0a	0.0a	50.0e
n. cuttings with 2-year-old wood		20.8abc	66.8e	0.0a	12.4abc
n. cuttings with 2-year-old wood + node		29.0abc	0.0a	0.0a	71.0f
terminal cuttings		29.2abc	12.5b	8.3abc	55.0e
terminal cuttings + node		87.5g	0.0a	8.3abc	4.2ab
terminal cuttings with 2-year-old wood		25.0abc	8.3ab	8.3abc	58.4e
t. cuttings with 2-year-old wood + node		41.8bcd	8.3ab	4.2ab	45.7e
nodal cuttings	1% IBA	89.7fg	0.0a	0.0a	10.3abc
nodal cuttings + node		88.0fg	0.0a	0.0a	12.0abcd
nodal cuttings with 2-year-old wood		63.1de	0.0a	4.2ab	32.7cd
nodal cuttings with 2-year-old wood + node		95.8g	0.0a	0.0a	4.2ab
terminal cuttings		90.3fg	0.0a	5.5ab	4.2ab
terminal cuttings + node		91.7g	0.0a	0.0a	8.3abc
terminal cuttings with 2-year-old wood		95.8g	0.0a	0.0a	4.2ab
t. cuttings with 2-year-old wood + node		70.8def	0.0a	0.0a	29.2cd
nodal cuttings	control	20.8abc	29.2c	50.0g	0.0a
nodal cuttings + node		16.7abc	50.0d	33.3f	0.0a
nodal cuttings with 2-year-old wood		50.0cde	0.0a	16.6bcd	33.4cd
n. cuttings with 2-year-old wood + node		33.4abcd	0.0a	29.2ef	37.4de
terminal cuttings		12.5ab	0.0a	83.3h	4.2ab
terminal cuttings + node		37.8bcd	0.0a	62.2g	0.0a
terminal cuttings with 2-year-old wood		12.5ab	0.0a	25.3def	62.2f
t. cuttings with 2-year-old wood + node		0.0a	0.0a	28.7cde	71.3f

Values followed by different letters are significantly different at the  $P < 0.05$  level according to the LSD test

Nodal cuttings treated with 1% IBA formed the highest mean number of roots (9.6 - 14.3) (Table 2). Similarly, terminal cuttings with only current season's wood also formed high number of roots in 1% IBA treatment (9.6-10.6). However, the mean number of primary roots of all types of cutting was low in the 0.2% IBA treatment and control, and obtained values mostly varied between 2.3 and 6.7. The mean length of roots ranged between 17.0 mm and 57.7 mm, and the longest roots were developed from nodal cuttings in control treatment (38.3 - 57.7 mm) (Table 2). However, there was no statistically significant difference among mean length of roots developed from any of types of cuttings treated with 0.2% or 1% IBA (19.6 - 35.6 mm), with the exception of two-nodal cuttings treated with 0.2% IBA (46.2 mm).



Table 2 Number and length of primary roots

Cutting type	Hormone	Mean No. of roots	Mean length of roots (mm)
nodal cuttings	0.2% IBA	4.3a	20.1a
nodal cuttings + node		6.2abc	46.2cd
nodal cuttings with 2-year-old wood		2.3a	35.6ab
n. cuttings with 2-year-old wood + node		4.0a	19.6a
terminal cuttings		6.7abc	30.9ab
terminal cuttings + node		8.8bcd	29.8ab
terminal cuttings with 2-year-old wood		5.7abc	24.8a
t. cuttings with 2-year-old wood + node		6.6abc	27.8ab
nodal cuttings	1% IBA	11.5de	29.5a
nodal cuttings + node		11.6de	34.4ab
nodal cuttings with 2-year-old wood		9.6bcd	23.0a
n. cuttings with 2-year-old wood + node		14.3e	27.3ab
terminal cuttings		9.6bcd	29.7ab
terminal cuttings + node		10.6cd	27.6ab
terminal cuttings with 2-year-old wood		6.3abc	26.6ab
t. cuttings with 2-year-old wood + node		7.3abc	24.9a
nodal cuttings	control	6.0abc	56.3d
nodal cuttings + node		8.0abc	41.5c
nodal cuttings with 2-year-old wood		5.7abc	38.3bc
n. cuttings with 2-year-old wood + node		5.3abc	57.7d
terminal cuttings		2.0a	17.0a
terminal cuttings + node		5.3abc	33.8ab
terminal cuttings with 2-year-old wood		6.0abc	30.5ab
t. cuttings with 2-year-old wood + node		-	-

Values followed by different letters are significantly different at the  $P < 0.05$  level according to the LSD test

The mean number of secondary roots was very variable, ranging from 1.3 to 26.3 (Table 3). Nevertheless, in the 1% IBA treatment it was quite low, not exceeding 7.3, without statistically significant difference among different cutting types. On the contrary, the best results were achieved in the control treatment where number of secondary roots developed from nodal cuttings ranged between 15.5 and 26.3, but two-nodal cutting had more secondary roots (22.7-26.3) than single node cuttings (15.5 - 17.0).

Table 3 Number of secondary roots

Cutting type	Hormone	Frequency * (%)	Mean No. of roots
nodal cuttings	0.2% IBA	33.3	3.3a
nodal cuttings + node		50.0	14.7c
nodal cuttings with 2-year-old wood		50.0	6.0ab
nodal cuttings with 2-year-old wood + node		0.0	-
terminal cuttings		57.1	11.5bc
terminal cuttings + node		55.0	7.0ab
terminal cuttings with 2-year-old wood		50.0	14.0bc
terminal cuttings with 2-year-old wood + node		40.0	10.2bc
nodal cuttings	1% IBA	28.6	7.0ab
nodal cuttings + node		30.0	4.3a

nodal cuttings with 2-year-old wood		21.4	6.3ab
nodal cuttings with 2-year-old wood + node		25.0	3.7a
terminal cuttings		75.0	7.3ab
terminal cuttings + node		40.9	4.5a
terminal cuttings with 2-year-old wood		37.5	6.3ab
terminal cuttings with 2-year-old wood + node		25.0	1.3a
nodal cuttings	control	50.0	17.0cd
nodal cuttings + node		100.0	22.7d
nodal cuttings with 2-year-old wood		100.0	15.5c
nodal cuttings with 2-year-old wood + node		33.3	26.3d
terminal cuttings		0.0	-
terminal cuttings + node		66.7	6.0ab
terminal cuttings with 2-year-old wood		100.0	6.0ab
terminal cuttings with 2-year-old wood + node		0.0	-

Values followed by different letters are significantly different at the  $P < 0.05$  level according to the LSD test

\*Frequency represent the percentage of rooted cuttings which have formed secondary roots

Results obtained in our research showed that the highest influence on rooting had IBA concentration, because rooting percentage and mean number of primary roots were noticeably high for all cutting types in 1% IBA treatment. Differences in rooting rate and mean number of primary roots for nodal and terminal cuttings were recorded, but in most cases they were not statistically significant. This is contrary to the results obtained during propagation of this species using cuttings taken earlier in June where cutting type strongly influenced rooting percentage, and the terminal cuttings with current season wood were rooted in higher percentage (96.7%) than terminal cuttings with 2-year-old wood (38.4%) or nodal cuttings (37.5 - 58.3%) in the 1% IBA treatment (Marković et al., 2014a). However, in presented research, in the 1% IBA treatment rooting rate was high for terminal as well as for nodal cuttings (88.0 - 95.8%) with the exception of the nodal cuttings with 2-year-old wood (63.1%) and the terminal cuttings with 2-year-old wood with node (70.8%).

Influence of hormone concentration and time of taking cuttings on rooting rate was previously described for Cornelian cherry (Bijelic et al., 2012a, Kosina and Baudyšová, 2011, Korszun and Kolasinski, 2002, Marković et al., 2014a,b, Pirlak, 2000), but optimal concentrations differed depending on author. On the other hand, in the mentioned researched different cutting types of *C. mas* were used, in some cases two-nodal green cuttings (Bijelic et al., 2012, Korszun and Kolasinski, 2002), but in some cases hardwood cuttings were used (Hassanpour and Ali Shiri, 2014, Pirlak, 2000). However, there were no investigations of influence of cutting size on rooting rate. In our research, length of cuttings influenced the rooting rate differently, depending on cutting type and hormone concentration. The most obvious difference was in 0.2% IBA treatment, where terminal cuttings with node was rooted in noticeably higher percentage (87.5%) than terminal cuttings with apical bud only (29.2%), but in the control this difference was smaller (37.8% and 12.5%), and finally in the 1% IBA treatment there were almost no difference (91.7% and 90.3%). Although some authors (Beyl et al., 1995, Burgess et al., 1990, Gopale and Zunjarrao, 2011, Vigl and Rewald, 2014, Yang et al., 2015) emphasize the importance of cutting size for the successful rooting and growth of some species, for some other species cutting length didn't affect their rooting percentage (Bona et al., 2012, Miller et al., 1982, Owuor et al., 2009), but affected the number of primary roots and the longer cuttings had more primary roots (Bona et al., 2012, Miller et al., 1982) which can be also observed in our research. Previous investigations also showed that cutting diameter have significant influence on rooting, more important than cutting length, probably due to higher carbohydrate reserves in cuttings with greater thickness relative to thinner cuttings (Beyl

et al., 1995, Biondi et al., 2008, Zhang et al., 2010). However, in some cases rooting percentage could decrease with increasing cutting diameter (Howard and Ridout, 1991).

### **Conclusions**

According to the results obtained in our research, it can be concluded that the selected elite trees can be propagated by softwood cuttings treated with 1% IBA taken in July. For propagation, terminal as well as nodal cuttings can be used. Rooting rate was not affected by a cutting size, but larger cuttings should be used in order to obtain better developed root system.

### **Acknowledgement**

This work was supported by the Ministry of Education and Science of Serbia, grant No 43007.

### **References**

- Beyl C.A., Ghale G., Zhang, L. (1995). Characteristics of hardwood cuttings influence rooting of *Actinidia arguta* (Siebold and Zucc.) Planch. *Hort Science* 30: 955-972.
- Bijelić S., Gološin B., Bogdanović B., Bojić M., Vujaković M. (2012a). IBA effect of rooting cornelian cherry (*Cornus mas* L.) softwood cuttings. *Letopis naučnih radova Poljoprivrednog fakulteta*, 36(1): 149-155.
- Bijelić S., Gološin B., Ninić Todorović J., Cerović S., Bogdanović B. (2012b). Promising Cornelian Cherry (*Cornus mas* L.) Genotypes from Natural Population in Serbia. *Agriculturae Conspectus Scientificus*, 77/1: 5–10.
- Biondi, D.; Bredow, E. A.; Leal, L. (2008). Cutting diameter influence in the rooting of *Tecoma stans* (L.) Juss. ex Kunth. *Ciencias Agrárias* 29(2): 277-282.
- Bona C.M., Biasetto I.R., Masetto M., Deschamps C., (2012). Influence of cutting type and size on rooting of *Lavandula dentata* L. *Revista Brasileira de Plantas Mediciniais* 14(1): 8-11.
- Burgess D., Hendrickson O., Roy L. (1990). The importance of initial cutting size for improving the growth performance of *Salix alba* L. *Scand J Forest Res* 5(1-4): 215–224.
- Cakmakci S., Tosun M. (2010). Characteristics of Mulberry Pekmez with Cornelian Cherry. *International Journal of Food Properties*, 13: 713–722.
- Demir F., Kalyoncu I.H. (2003). Some nutritional, pomological and physical properties of cornelian cherry (*Cornus mas* L.). *Journal of Food Engineering* 60: 335–341.
- Dokupil L., Řezniček V. (2012). Production and use of the Cornelian cherry – *Cornus mas* L. *Acta Universitatis Agriculturae et Silviculturae Mendelianae Brunensis*, LX No. 8: 49–58.
- Gerrakakis A.C., Özkaya M.T. (2005). Effects of cutting size, rooting media and planting time on rooting of Domat and Ayvalik olive (*Olea europaea* L.) cultivars in shaded polyethylene tunnel (spt.). *Tarim Bilimleri Dergisi* 11(3): 334-338.
- Gopale K.D., Zunjarrao R.S. (2011). Effect of auxin, length of stem cutting, substrate and seasonal variations on *Jatropha curcas* L., biodiesel plant. *Bioscience Discovery* 02(1):76-81
- Hassanpour H., Ali Shiri M. (2014). Propagation of Iranian Cornelian Cherry (*Cornus mas* L.) by Rooted Stem Cuttings. *Notulae Scientia Biologicae*, 6(2): 192-195
- Howard, B.H. and Ridout, MS. (1991a). Rooting potential in plum hardwood cuttings: Relationship with shoot diameter. *Journal of Horticultural Science* 66(6): 673-680.

- Klimenko S. (2004). The Cornelian cherry (*Cornus mas* L.): collection, preservation, and utilization of genetic resources. *Journal of Fruit and Ornamental Plant Research* 12 (93-98)
- Korszun S., Kolasinski M. (2002). Alternative technology of propagation cornelian cherry (*Cornus mas* L.). *Biuletyn Ogrodow Botanicznych*, 11 (51–56)
- Kosina, J.; Baudyšová, M. (2011). Propagation of less known fruit crops by cuttings. *Vědecké Práce Ovocnářské* 22: 223 - 229.
- Marković M., Grbić M., Djukić M. (2014a). Effects of cutting type and a method of IBA application on rooting of softwood cuttings from elite trees of cornelian cherry (*Cornus mas* L.) from Belgrade area. *Silva Balcanica*, 15(1): 30-37
- Marković M., Skočajić D., Grbić M., Djukić M. (2014b). Effects of the time of cuttings collection and IBA concentration on the rooting of softwood cuttings from elite trees of Cornelian cherry (*Cornus mas* L.) in Belgrade area. *Bulletin of the Faculty of Forestry* 110: 105-120.
- Marković, M. (2013). New trends in landscaping and gardening as a method for preserving biodiversity. *Zaštita prirode*, 63(1-2): 25-33
- Miller N.F., Hinesley L.E., Blazich F.A. (1982). Propagation of Fraser fir by stem cuttings: Effects of type of cutting, length of cutting, and genotype. *HortScience* 17 (827-829)
- Mratinić, E., Kojić, M. (1998). Wild fruit species of Serbia. Institute for agricultural research "Serbia", Belgrade (in Serbian).
- Owuor B.; Musyimi D., Ocaido M., Asimwe J. (2009). Vegetative propagation of the large sour plum (*Ximenia caffra* Sond) by rooting of plagiotropic stem cuttings. *Journal of Agricultural and Biological Science*, 4 (1) (19-25)
- Pirlak L. (2000): Effects of different cutting times and IBA doses on the rooting rate of hardwood cuttings of cornelian cherry (*Cornus mas* L.) *Anadolu* 10: 122–134.
- Vigl F., Rewald B. (2014): Size matters? The diverging influence of cutting length on growth and allometry of two Salicaceae clones. *Biomass Bioenergy* 60 (130–136)
- Yalcinkaya E., Erbil Y., Ufuk S. (1999): Studies On Propagation Methods of The Cornelian Cherry (Pub. No. 131) Atatürk Central Horticultural Research, Institute Yalova, Annual Report 1998 – 1999.
- Yang F., Wang J., Li Y. (2015): Effects of cutting size and exogenous hormone treatment on rooting of shoot cuttings in Norway spruce, *Picea abies* (L.) Karst., *New Forests* 46 (91–105)
- Zhang M., Wang D., Ren S., Fan L., Liu R. (2010): Effects of Feijoa cutting diameter on seedling quality. *Agricultural Journal* 5(3) (139-141)

## SOIL POTENTIAL FOR POPLAR PLANTATIONS ESTABLISHMENT IN THE AREA OF PE „ŠUME REPUBLIKE SRPSKE“ (BOSNIA AND HERZEGOVINA)

Saša PEKEČ\*, Andrej PILIPOVIĆ, Marina KATANIĆ, Milan DREKIĆ

Institute of Lowland Forestry and Environment, University of Novi Sad, Antona Čehova 13, Novi Sad, Serbia

\*Corresponding author: pekecs@uns.ac.rs

### Abstract

The paper presents the characteristics of soil in the area of the right bank of the Sava River. The research was conducted in areas managed by Public Enterprise „Šume Republike Srpske“, forest economy „Gradiška“ (Republika Srpska, Bosnia and Herzegovina). In this area, two soil profiles were opened in central zone of bottomland. Studied soil is moistened by flood waters and ground waters which movement depends on the water level of the Sava River. In this area soil belongs to hydromorphic order, type of soil is alluvial semigley, and the morphology composition is: Aa-IGso-IIGso. These soils are neutral to slightly alkaline. Humus content ranges from 2.32 to 3.01%, which classified this soil in a soil group with moderate humus content. The humus surface horizon potential of 10 to 15 cm depth is textured according to the following composition: loam to clay loam soil, while in the deeper strata or subhorizons to 150 cm depth, the texture classes are: sandy loam, loam and clay loam. Such a mechanical composition results in a relatively favorable water-air properties which is complemented by moisturizing with the groundwater, and its periodically raising and decreasing below the height of the lower limit of the surface horizon. On the basis of examined characteristics of these soils, as well as their geographical distribution within the bottomland of the Sava River, it can be concluded that the soils have the potential for the cultivation of broadleaves from a complex of the alluvial hygrophile forests, or clonal mixture: euro-american poplar (*Populus x euramericana* x (Dode) Guinier), american black poplar (*Populus deltoides* W. Bartram ex Marshall) and white poplar (*Populus alba* L.).

**Key words:** *Hydromorphic soil, bottomland, populus, the Sava river.*

### Introduction

Alluvial semigley, as a subtype of semigley soil, is formed in the central part of the bottomland on the alluvial deposits (Antić et al, 1965). According to the same authors this soil has isolated humus horizon with a tendency of deepening, under which there are situated homogeneous layers of alluvial material. According to Živanov and Ivanišević (1986) humus horizon of these soils, according to texture composition is sandy loam to loam, rarely clay loam, while deeper layers have sandy character. Also, same authors stated that significant areas of semigley soils for poplar growing are located in the central part or on the contact of the central and coastal part of the river bottomland. Alluvial semigley soil according to the current classification of soils (Škorić et al, 1985) is denoted as fluvial meadow soil (humofluvisol) or according to the classification of global WRB Gleyic Phaeozem (Pachic, Siltic), IUSS Working Group WRB (2006). Natural habitat of poplars and willows are so called "swamp forests" in lowland terrain around rivers, and their characteristics have been mainly caused by the flooding of rivers according to Marković and Živanov (1986). On the alluvial semigley (meadow black soil on the alluvial deposits) morphology Aa or Amo-IGso-Gso ... Gr, natural poplar forests in the Sava alluvium (Forest Management Plan, ŠG Sremska

Mitrovica) can be found. By studying poplar plantations on the alluvial semigley of the River Sava in Srem, Andrašev et al. (2010), noted that clone I-214 showed a high potential for production according to the elements of the trees' growth, suggesting that on these soils can be achieved high-production effects by providing all the necessary technological measures. In support to the good potential of the studied area for the poplar cultivation, Keča (2014) stated that the length of the poplar production cycle on semigley in Ravni Srem, in the areas near the Sava River should be between 15-19 years. With regard to the properties of alluvial semigley for establishment of poplar plantation, this paper shows the characteristics of the soil and its potential for establishment of new poplar plantations in the bottomland of the Sava River, on the area of Forest unit "Gradiška", in the bottomland close to the River Sava upstream of the place Gradiška.

### Material and methods

In the area of Public Enterprise "Šume Republike Srpske", in bottomland of the Sava River, was conducted study on soil in order to determine appropriate soil areas for the establishment of poplar clonal plantations. Two soil profiles were opened in the area of management units "Prosara" in forest unit "Gradiška" which is located west of the town Gradiška, in village Bistrica. During the examination of soil profiles was described external and internal morphology of both soil profiles that are located on the right bank of the Sava river at about 400 m distance from the river bed. On the field, soil samples were taken in the impaired state in order to determine the physical and chemical characteristics of soils in the laboratory of the Institute of Lowland Forestry and Environment. On taken soil samples following analysis were made:

- the particle size distribution was determined according the international B-pipet method with preparation in the sodium-pyrophosphate,
- chemical reaction of soil, pH in water electrometrically with a glass electrode,
- content of humus in the soil after method of Tjurin, modified according to Simakov,
- total nitrogen content according to the metod of Kjedadhl.
- easily available phosphorus and potassium, according to the Al-method, Egner Riehm - Dominigo.

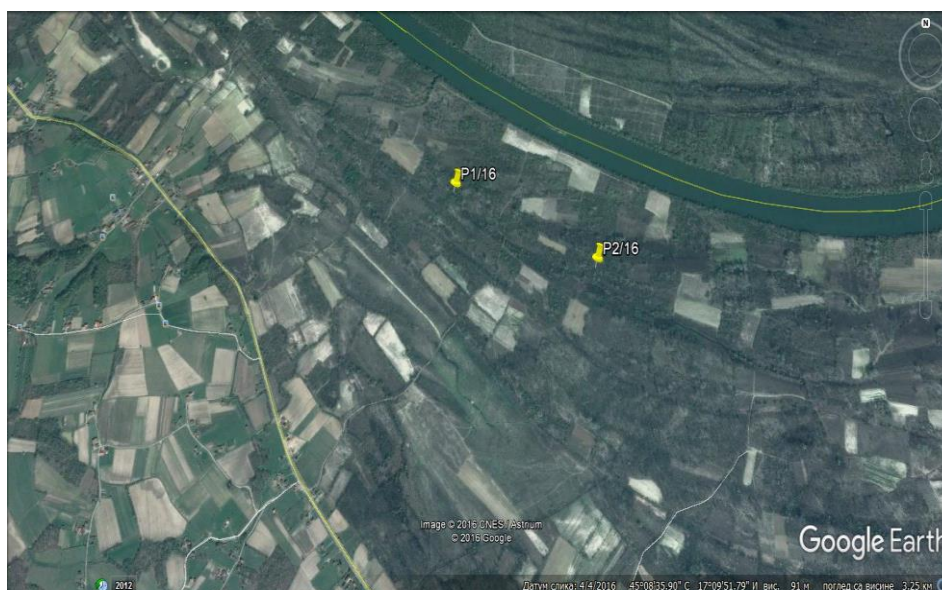


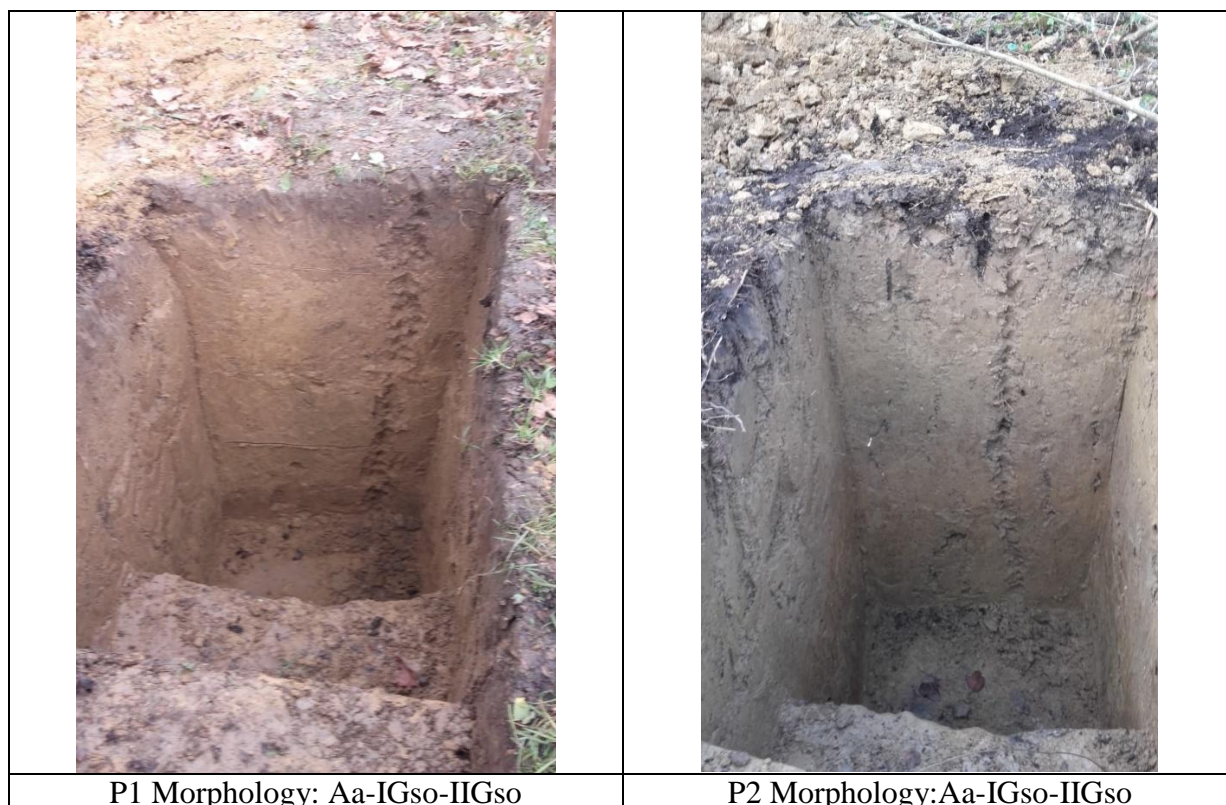
Figure 1 Types of soil profiles, and their distance from the Sava River

### Results and discussion

According to shown granulometric composition of the analyzed soils (Table 1) in soil profile P1 may be seen that the surface horizon Aa (0-15 cm) is textural class clay with 55.0% of the total clay, and most powerful IGso (15-120 cm) layer / subhorizon has a heavier texture, i.e. clay loam, with 62.40% of the total clay, and the lowest layer / subhorizon IIGso with a depth beneath 120 cm has a lighter mechanical composition in comparison to previous two and the content of the total sand is 75.52% and the total clay 24.48% and its texture class is sandy loam. The analysis of particle size distribution of soil profile P2 (Table 1), showed that this soil has a heavier texture in comparison to the previous profile. Total content of clay is almost uniform through the entire profile depth, in Aa horizon (0-15cm) it amounts 64.76%, and in IGso (10-135 cm) layer / subhorizon the total content of clay was 66.28%, so the texture class of P2 soil profile to the depth of 135 cm is of heavier texture, i.e. the clay loam soil. At IIGso (135-150cm) layer / subhorizon the total content of clay is lower, i.e. 61.72% and at this depth prevalent texture class is loam.

Table 1 Granulometric composition of soil

Profil	Horizon	Depth (cm)	Coarse sand	Fine sand	Silt	Clay	Total sand	Total clay	Textural class
P1	Aa	0-15	16,53	28,47	32,64	22,36	45,00	55,00	loam
	IGso	15-120	6,50	31,11	27,08	35,32	37,60	62,40	clay loam
	IIGso	120-150	5,83	69,69	13,80	10,68	75,52	24,48	sandy loam
Average		0-150	9,62	43,09	24,51	22,79	52,71	47,29	
P2	Aa	0-10	7,05	28,19	33,96	30,80	35,24	64,76	clay loam
	IGso	10-135	6,01	27,71	30,96	35,32	33,72	66,28	clay loam
	IIGso	135-150	2,35	35,93	35,36	26,36	38,28	61,72	loam
Average		0-150	5,13	30,61	33,43	30,83	35,75	64,25	



P1 Morphology: Aa-IGso-IIGso

P2 Morphology: Aa-IGso-IIGso

Figure 2 The internal morphology of soil profiles

Chemical properties of the investigated soils (Table 2), showed that these soils have a pH value in the range of 6.70 to 7.69, which indicates that the reaction of these soils is neutral to weakly alkaline. The analyzed soil humus content ranged from 2.32 to 3.01%, which classified these soils into a soils with moderate humus content, except for the value of 0.87% in IIGso horizon of profile P1, which is weakly humic. According to the content of nutrients in these soils, they are moderately supplied with total nitrogen, moderately supplied with easily available phosphorus and they contain easily available potassium in low to medium amount.

Table 2 Chemical properties of soil

Profil	Horizon	Depth (cm)	pH (in H <sub>2</sub> O)	Humus (%)	Total N (%)	P <sub>2</sub> O <sub>5</sub> mg/100g	K <sub>2</sub> O mg/100g
P1	Aa	0-15	6,75	2,32	0,121	11,76	9,52
	IGso	15-120	7,41	2,77	0,138	13,08	10,63
	IIGso	120-150	7,69	0,87	0,048	6,28	4,95
Average		0-150	7,28	1,99	0,102	10,37	8,37
P2	Aa	0-10	6,70	2,92	0,144	13,51	10,98
	IGso	10-135	6,92	3,01	0,148	13,78	11,21
	IIGso	135-150	7,29	2,72	0,137	12,96	10,53
Average		0-150	6,97	2,89	0,143	13,41	10,91

In analyzed soil profiles, humic horizon potency of 10 - 15 cm in depth is expressed more clearly, and it is more sharply separated from the rest of the soil profile. Accumulation of humus in this horizon is a consequence of the development of ground flora, as well as of retention of floodwaters of the Sava River in certain periods of the year, which is located at 400 to 500 meters from the profiles. Mentioned distance from the shore of the Sava River and mechanical composition of the soil indicate that studied soils are located in the central part of the bottomland, or on the crossing of the central and coastal parts. Surface horizon is rich in organic matter and it has grainy to fine grainy structure.

Lower layers/subhorizons of soil profiles, under the surface of horizon, are more homogenous and heavier texture, which is composed of a clay loam soil to a depth of 120, or 135 cm. Therefore such a particle size distribution results in a relatively favorable water-air properties, and moistening of such soils comes from flood and underground water, or from its periodical oscillation to the height of the lower limit of the surface horizon in both soil profiles. Based on the showed soils characteristics, it can be concluded that these soils fulfill ecological conditions for growing soft or hard wood trees from a complex of alluvial hygrophilous forests. Due to the texture class of clay loam, which prevails in depth in most parts of the profile, it is necessary after cleaning existing weeds or woody vegetation at the studied sites, to provide complete agro-technical measures, including plowing and disking of surface intended for planting, in order to improve the water-air properties of the soil and conditions for a better survival and growth of seedlings. It is also necessary, for the same reasons, in the next 3 to 4 years to provide the inter-row disking of areas under established poplar plantations. Based on the obtained results, studied site is recommended for planting of broadleaves, or clonal mixture: Euro-American poplar (*Populus x euramericana* (Dode) Guinier), American black poplar (*Populus deltoides* Marshall) and white poplar (*Populus alba* L.). Also, examined habitat can be used for planting of common oak (*Quercus robur* L.) and ash (*Fraxinus angustifolia* Vahl.).



## **Conclusion**

This paper presents characteristics of the soil on the right bank of the Sava River in the area of forest unit "Gradiška" Public Enterprise "Šume Republike Srpske", Bosnia and Herzegovina, in order to establish new plantations of broadleaves in this area. Analyzed soils are hydromorphic from the class of semigley soils and are located in the central part of the bottomland classified as alluvial semigley. Moisturizing of the soil is caused by the flood and groundwater. Analyzed soil are characterized by heavier granulometric composition with texture classes from sandy loam, loam to the clay loam. These soils are moderately humic, neutral to slightly alkaline reactions. Studied soils have the potential for growing soft and hardwoods trees from the complex of the alluvial-hydrophilic forests. Since heavier granulometric composition is prevalent in most parts of the profile, it is necessary to apply complete agro-technical measures on the areas intended for planting, in order to additionally improve the water-air properties of soil and achieve favorable conditions for better survival and growth of newly established poplar plantations.

## **Acknowledgement**

This paper was realized as a part of the project "Studying climate change and its influence on the environment: impacts, adaptation and mitigation" (III43007) financed by the Ministry of Education and Science of the Republic of Serbia within the framework of integrated and interdisciplinary research.

## **Literature**

- Andrašev, S., Rončević, S., Vučković, M., Bobinac, M., Danilović, M., Janjatović, G. (2010): Elements of structure and productivity of clone I-214 (*Populus x euramericana* (Dode) Guinier) on river Sava alluvium. *Bulletin of Faculty of forestry*, (101), 7-24.
- Antić M., Jović N. (1965): Genesis and characteristics of land Belje hunting forest area „Jelen“. *Bulletin LŠG 3*, Beograd.
- Keča, Lj. (2014): Determining the optimal length of the production cycle from the financial aspect in poplars plantations of meadow semigley. *Bulletin of Faculty of forestry*, (110), 87-104.
- Forest management plan for the management unit: Vinična -Žeravinac – Puk, ŠG Sremska Mitrovica
- Škorić, A., Filipovski, G., Ćirić, M. (1985): Soil classification of Yugoslavia. Sarajevo: Academy of Sciences and Arts of Bosnia and Herzegovina
- IUSS Working Group WRB (2006) World reference base for soil resources 2006. u: *World Soil Resources Reports*, Rome: FAO, 2nd edition, 103
- Marković J., Živanov N. (1986): Raising and breeding of poplars and willows, habitat selection, *Poplars and willows in Yugoslavia*, p. 121-122. Poplar Institute - Novi Sad
- Živanov N., Ivanišević P. (1986): Soil for growing poplar and willow, *Poplar and willows in Yugoslavia*, p. 111-112. Poplar Institute - Novi Sad

## EFFECT OF SALINITY ON GROWTH AND DEVELOPMENT OF WHITE POPLAR SHOOTS *IN VITRO*

Vanja VUKSANOVIĆ<sup>1\*</sup>, Branislav KOVAČEVIĆ<sup>2</sup>, Saša ORLOVIĆ<sup>2</sup>, Marina KATANIĆ<sup>2</sup>, Marko KEBERT<sup>2</sup>, Dragana MILADINOVIĆ<sup>3</sup>

<sup>1</sup>University of Novi Sad, Faculty of Agriculture, Dositeja Obradovića 8, 21000 Novi Sad, Republic of Serbia

<sup>2</sup>University of Novi Sad, Institute of Lowland Forestry and Environment, Antona Čehova 13, 21000 Novi Sad, Republic of Serbia

<sup>3</sup>Institute of Field and Vegetable Crops, Maksima Gorkog 42, 21000 Novi Sad, Republic of Serbia

\*Corresponding author: vanja-vuksanovic@hotmail.com

### Abstract

The study tested the effect of salinity on growth and development of the shoots of five white poplar (*Populus alba* L.) genotypes in culture *in vitro*. After 35 days of cultivation following characters were measured: height of shoot, number of roots, length of the longest root, percentage of survival and rooting. The effect of six different concentrations of NaCl in the standard rooting medium (1 mM, 3 mM, 10 mM, 33 mM, 100 mM and 150 mM), and the standard rooting medium without salt (used as Control) were studied. The medium with 150 mM NaCl produced toxic effect, so these explants were excluded from further statistical analysis. The salinity tolerance of examined genotypes was evaluated by tolerance index by Turner and Marshal (TI), calculated for every examined character. According to analysis of variance, the main effect of medium was significant, but not the interaction genotype × medium for all of examined characters. Considering significant genotypes' differentiation and significantly lower tolerance indices compared to others on the most of characters, medium with 100 mM NaCl was proposed to be used for the evaluation of white poplar genotypes *in vitro*. The best tolerance achieved genotype L-80, which had the highest tolerance index for the length of the longest root. Results of this study suggest that *in vitro* culture could be usefully implemented in evaluation of salt tolerance of white poplar genotypes.

**Keywords:** *Populus alba*, micropropagation, salt tolerance.

### Introduction

Soil salinity is abundant and ever growing problem on our planet. It is one of the major constraints to global food crop production, jeopardizing the capacity of agriculture to sustain the burgeoning human population increase (Flowers, 2004). It is estimated that 20% of all cultivated land and nearly half of irrigated land is salt-affected, greatly reducing yield well below the genetic potential (van Schilfgarde, 1994; Munns, 2002; Flowers, 2004). Soil salinity is becoming a more acute problem, primarily because of declining irrigation water quality (Rhoades and Loveday, 1990; Ghassemi *et al.*, 1995; Flowers, 2004). Soil or water salinity is considered to be the major environmental factor limiting plant growth and productivity, especially in arid and semi-arid regions. Salinity has a two-fold effect on plants: the salt in the soil solution decreases the availability of water to the roots (osmotic stress), and the salt taken up by the plant can accumulate to toxic levels in certain tissues (ionic stress) (Munns *et al.*, 1995, Bottela *et al.*, 2005). Salt stress causes disruption of ionic equilibrium, inhibition of enzymatic activity, osmotic imbalance, membrane disorganization,

inhibition of cell division and expansion, reduction in photosynthesis and production of reactive oxygen species (ROS) (Mahajan and Tuteja, 2005).

White poplar (*Populus alba* L.) is tree species widely spread throughout Europe, eastern Asia and northern Africa. However, in spite its high adaptability, it is considered as a threatened species and indicator of biodiversity (Kovacevic *et al.*, 2010b). There is also general interest in the utilization of white poplar in horticulture and landscape architecture (Eggens *et al.*, 1972). Along with “pyramidal” or “fastigiata” tree shape and male sex, tolerance to the environmental stresses is desired feature. *In vitro* evaluation of abiotic stress tolerance of interesting genotypes, and of salt tolerance in particular, could be useful method, considering problems regarding the establishment of field trials with large long-lived tree species (Vuksanovic *et al.* 2017; Khattab and El-Garhy, 2016; Vuksanović *et al.*, 2017). In addition, white poplar (*Populus alba* L.) is one of the most interesting model tree species in biotechnology, where the tissue culture is an important propagation technique (Confalonieri *et al.*, 2000).

The aim of this research is to assess the variability of morphometric parameters associated with salt tolerance in five white poplar genotypes *in vitro*.

## Materials and methods

### Plant material

Five white poplar (*Populus alba* L.) genotypes, interesting for wood production, horticulture and landscaping were examined: widespread Italian selection “Villafranca”, and Serbian selections in experimental phase: L-12, L-80, LBM and LCM. Shoots of all five tested genotypes were multiplied by culture of axillary buds, as described by Ahuja (1984) and Kovacevic *et al.* (2010a). The cultures were sub-cultured at 4-week intervals and kept at 26±2 °C, under a 16 h photoperiod (cool white fluorescent lamps, 3500 lx), till their use in the experiment.

### Media preparation and experiment establishment

Mineral growing medium ACM (Aspen Culture Medium), described by Ahuja (1984), supplemented with 9gL<sup>-1</sup> agar, 20gL<sup>-1</sup> sucrose and with no growing hormones, was used in the experiment as rooting medium. The effect of six different concentrations of NaCl in the rooting medium (1 mM, 3 mM, 10 mM, 33 mM, 100 mM and 150 mM), and the rooting medium without salt (used as Control) were studied. Media were autoclaved at 120°C for 25 min. Five shoot tips were cultured per 190 ml jar with 25 ml of rooting medium. There were five jars per examined medium within a genotype. The explants were cultured at temperature of 26±2 °C, under a 16 h photoperiod (cool white fluorescent lamps, 3500 lx). After 35 days of cultivation following morphometric characters were measured: for every plant: shoot height, number of roots and length of the longest root, and for every jar: percentage of survival and percentage of rooting.

### Statistical analysis

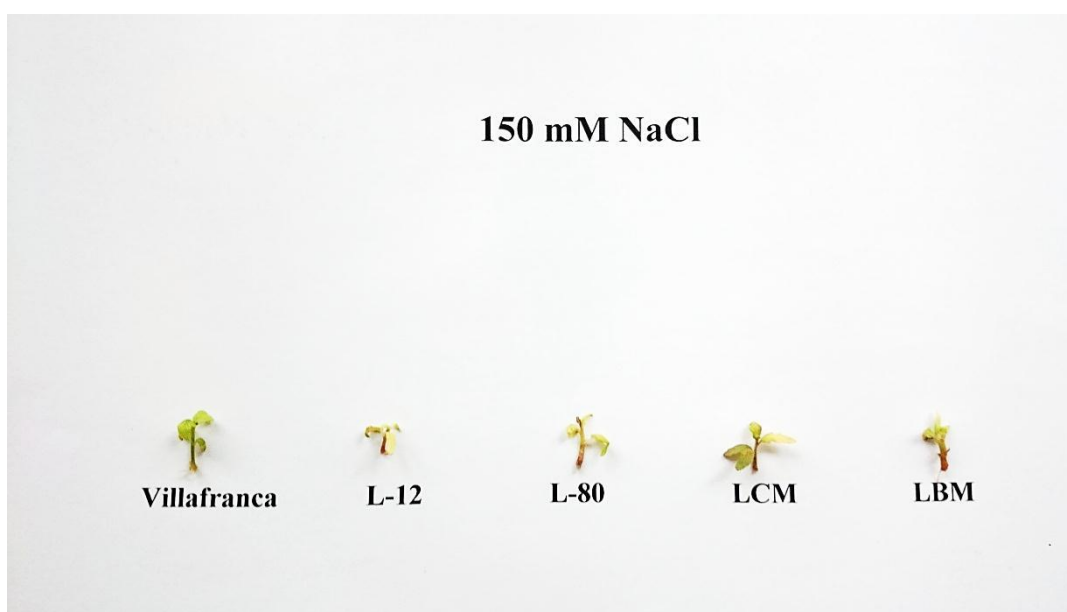
The salt tolerance of examined genotypes was evaluated by tolerance indices. The tolerance index (TI) was calculated according to Turner and Marshal (1972), as a ratio between the value of a parameter on the medium with a particular salt concentration ( $X_{c(NaCl)}$ ) and the

value obtained on the Control ( $X_{Control}$ ):  $TI = \frac{X_{c(NaCl)}}{X_{Control}}$ .

Tolerance index was calculated for all examined characters at the level of jars. The obtained data were analyzed by two-way factorial analysis of variance and Fishers' Least Significant Difference test (LSD-test) with STATISTICA 12 (StatSoft Inc., 2013) statistical program.

## Results and discussion

Salt at higher concentrations in apoplast generates primary and secondary effects that negatively affect plant's survival, growth and development. Primary effects are ionic toxicity and disequilibrium, and hyperosmolality (Jenks and Hasegawa, 2005). In concentrations higher than 0,4 M salt inhibit most enzymes because of disturbances to hydrophobic – electrostatic balance that is necessary to maintain the protein structure (Jones and Pollard, 1983). High concentrations of salt also impose hyperosmotic shock by lowering the water potential causing turgor reduction or loss that restricts cell expansion (Munns and Termaat, 1986; Hasegawa *et al.*, 2000; Zhu, 2002). Principal secondary effects of NaCl stress include disturbance of K<sup>+</sup> acquisition, membrane dysfunction, impairment of photosynthesis and other biochemical processes, generation of reactive oxygen species (ROS) and programmed cell death (Serrano *et al.*, 1999; Hasegawa *et al.*, 2000; Rodriguez-Navarro, 2000; Zhu, 2003). In our study, considerable cytotoxic effect, manifested in appearance of chlorosis and necrosis, as well as absence of root formation was found on medium with 150 mM NaCl. So, these explants were excluded from further statistical analysis (Figure 1).



**Figure 1.** Rooted shoots of examined genotypes on medium with 150 mM NaCl

The results of analysis of variance of tolerance indices after 35 days of cultivation *in vitro* showed that in all tested morphological parameters the main effect of medium is not only statistically significant but also according to F-values, the strongest among examined controlled sources of variation. The main effect of tested genotypes is statistically significant, while the interaction of the genotype × medium, which describes differences in the response of the genotype to the investigated media, showed no statistically significant influence on tolerance index of any of the parameters tested (Table 1).

**Table 1.** The results of two-way factorial analysis of variance of tolerance indices of examined characteristics for examined white poplar genotypes and concentrations of salt <sup>a)</sup>

Character	Mean square			F-test		
	Genotype (A)	Medium (B)	Interaction	Genotype (A)	Medium (B)	Interaction
			A × B			A × B
Shoot height (mm)	0,14	0,17	0,03	5,14 <sup>**b)</sup>	39,18 <sup>**</sup>	0,98
Root number	0,16	1,42	0,06	2,58 <sup>**</sup>	22,59 <sup>**</sup>	1,03
Length of the longest root (mm)	0,27	0,51	0,07	5,17 <sup>**</sup>	9,83 <sup>**</sup>	1,42
Percentage of survival	0,03	0,03	0,01	2,51	1,88 <sup>*</sup>	0,85
Percentage of rooting	0,08	0,15	0,01	4,94 <sup>**</sup>	9,24 <sup>**</sup>	0,77

a) Degrees of freedom: for genotype was  $DF_A = 4$ , for medium  $DF_B = 4$ , for interaction genotype × medium  $DF_{A \times B} = 16$ , for error  $DF_{ERR} = 100$  and for total  $DF_T = 124$ .

b) Labels for F-test: \* - significant at the level  $\alpha_{0,05}$ ; \*\* - significant at the level  $\alpha_{0,01}$

The concentrations of the salt of 1 to 33 mM NaCl did not show a statistically significant effect on tolerance indices for examined characters in most cases, which proved to be in total, as well as between genotypes within this treatment. However, tolerance indices for examined characters on medium with salt concentration of 100 mM NaCl were in most cases significantly lower than on other media with lower salt concentrations. Also, the differences between genotypes were the most significant on medium with 100 mM NaCl, and that is why this medium was used for the evaluation of tolerance in the examined group of white poplar genotypes. It was clearly demonstrated by the response of tolerance indices for length of the longest root and shoot height. The best tolerance achieved genotype L-80, which had the highest tolerance index for the length of the longest root and rooting percentage (Table 2).

**Table 2.** LSD-test for tolerance index for measured morphological characters of examined white poplar genotypes<sup>a)</sup>

Genotype	NaCl concentration (mM)	Shoot height (mm)	Root number	Length of the longest root (mm)	Percentage of survival	Percentage of rooting
L-12	1	1,20 <sup>a</sup>	1,16 <sup>abc</sup>	1,07 <sup>abcd</sup>	1,00 <sup>ab</sup>	1,00 <sup>ab</sup>
L-12	3	0,95 <sup>bcd</sup>	1,06 <sup>abc</sup>	0,91 <sup>cdefg</sup>	1,00 <sup>ab</sup>	1,00 <sup>ab</sup>
L-12	10	1,02 <sup>abc</sup>	0,98 <sup>bcd</sup>	1,04 <sup>abcd</sup>	1,00 <sup>ab</sup>	1,00 <sup>ab</sup>
L-12	33	0,79 <sup>de</sup>	1,02 <sup>bc</sup>	1,01 <sup>abcdef</sup>	1,00 <sup>ab</sup>	1,00 <sup>ab</sup>
L-12	100	0,48 <sup>gh</sup>	0,44 <sup>f</sup>	0,75 <sup>efgh</sup>	0,96 <sup>abc</sup>	0,88 <sup>bcd</sup>
L-80	1	1,04 <sup>abc</sup>	1,18 <sup>abc</sup>	0,98 <sup>bcdef</sup>	1,00 <sup>ab</sup>	1,00 <sup>ab</sup>
L-80	3	1,03 <sup>abc</sup>	1,11 <sup>abc</sup>	1,15 <sup>abc</sup>	1,00 <sup>ab</sup>	1,00 <sup>ab</sup>
L-80	10	0,90 <sup>bcd</sup>	0,91 <sup>cde</sup>	1,03 <sup>abcde</sup>	1,00 <sup>ab</sup>	1,00 <sup>ab</sup>
L-80	33	0,90 <sup>bcd</sup>	0,95 <sup>bcd</sup>	1,09 <sup>abc</sup>	1,00 <sup>ab</sup>	0,96 <sup>abc</sup>
L-80	100	0,58 <sup>fgh</sup>	0,62 <sup>ef</sup>	1,07 <sup>abcd</sup>	0,92 <sup>abcd</sup>	0,88 <sup>bcd</sup>
LBM	1	1,02 <sup>abc</sup>	1,18 <sup>abc</sup>	0,92 <sup>bcdefg</sup>	0,96 <sup>abc</sup>	0,96 <sup>abc</sup>
LBM	3	1,05 <sup>abc</sup>	1,35 <sup>a</sup>	1,13 <sup>abc</sup>	1,00 <sup>ab</sup>	1,00 <sup>ab</sup>
LBM	10	0,98 <sup>bcd</sup>	1,24 <sup>ab</sup>	1,15 <sup>abc</sup>	0,92 <sup>abcd</sup>	0,92 <sup>abc</sup>
LBM	33	0,92 <sup>bcd</sup>	1,15 <sup>abc</sup>	1,20 <sup>ab</sup>	0,96 <sup>abc</sup>	0,96 <sup>abc</sup>
LBM	100	0,55 <sup>gh</sup>	0,53 <sup>f</sup>	0,73 <sup>fgh</sup>	0,88 <sup>bcd</sup>	0,68 <sup>e</sup>
LCM	1	0,94 <sup>bcd</sup>	0,89 <sup>cde</sup>	0,97 <sup>bcdef</sup>	0,96 <sup>abc</sup>	0,96 <sup>abc</sup>
LCM	3	1,02 <sup>abc</sup>	0,94 <sup>bcd</sup>	1,17 <sup>abc</sup>	0,84 <sup>cd</sup>	0,80 <sup>cde</sup>
LCM	10	1,09 <sup>ab</sup>	1,19 <sup>abc</sup>	1,13 <sup>abc</sup>	1,00 <sup>ab</sup>	0,96 <sup>abc</sup>
LCM	33	0,78 <sup>de</sup>	0,91 <sup>cde</sup>	1,29 <sup>a</sup>	0,80 <sup>d</sup>	0,80 <sup>cde</sup>
LCM	100	0,53 <sup>gh</sup>	0,42 <sup>f</sup>	0,56 <sup>h</sup>	0,92 <sup>abcd</sup>	0,72 <sup>de</sup>
Villafranca	1	0,89 <sup>bcd</sup>	0,97 <sup>bcd</sup>	0,67 <sup>gh</sup>	1,00 <sup>ab</sup>	1,00 <sup>ab</sup>
Villafranca	3	0,88 <sup>cd</sup>	1,06 <sup>abc</sup>	0,80 <sup>defgh</sup>	1,00 <sup>ab</sup>	1,00 <sup>ab</sup>
Villafranca	10	0,78 <sup>def</sup>	1,07 <sup>abc</sup>	0,91 <sup>cdefg</sup>	1,04 <sup>a</sup>	1,04 <sup>a</sup>
Villafranca	33	0,64 <sup>efg</sup>	1,09 <sup>abc</sup>	0,97 <sup>bcdef</sup>	1,00 <sup>ab</sup>	1,00 <sup>ab</sup>
Villafranca	100	0,43 <sup>h</sup>	0,70 <sup>def</sup>	0,65 <sup>gh</sup>	0,88 <sup>bcd</sup>	0,83 <sup>cde</sup>
	L-12	0,89 <sup>a</sup>	0,94 <sup>b</sup>	0,96 <sup>a</sup>	0,99 <sup>a</sup>	0,98 <sup>a</sup>
	L-80	0,89 <sup>a</sup>	0,95 <sup>ab</sup>	1,06 <sup>a</sup>	0,98 <sup>a</sup>	0,97 <sup>ab</sup>
	LBM	0,90 <sup>a</sup>	1,09 <sup>a</sup>	1,03 <sup>a</sup>	0,94 <sup>ab</sup>	0,90 <sup>bc</sup>
	LCM	0,87 <sup>a</sup>	0,87 <sup>b</sup>	1,02 <sup>a</sup>	0,90 <sup>b</sup>	0,85 <sup>c</sup>

Villafranca	0,72 <sup>b</sup>	0,98 <sup>ab</sup>	0,80 <sup>b</sup>	0,98 <sup>a</sup>	0,98 <sup>ab</sup>
1	1,02 <sup>a</sup>	1,08 <sup>a</sup>	0,92 <sup>b</sup>	0,98 <sup>a</sup>	0,98 <sup>a</sup>
3	0,99 <sup>a</sup>	1,11 <sup>a</sup>	1,03 <sup>ab</sup>	0,97 <sup>ab</sup>	0,96 <sup>a</sup>
10	0,95 <sup>a</sup>	1,08 <sup>a</sup>	1,05 <sup>a</sup>	0,99 <sup>a</sup>	0,98 <sup>a</sup>
33	0,81 <sup>b</sup>	1,02 <sup>a</sup>	1,11 <sup>a</sup>	0,95 <sup>ab</sup>	0,94 <sup>a</sup>
100	0,51 <sup>c</sup>	0,54 <sup>b</sup>	0,75 <sup>c</sup>	0,91 <sup>b</sup>	0,80 <sup>b</sup>

<sup>a)</sup> The differences among values of particular characteristic marked with the same letter are not significant at the level  $\alpha_{0.05}$ .

Reduced growth of tissues in stressful media is a usual phenomenon (Das *et al.*, 1990, 1992; Misra *et al.*, 1996) and it has been interpreted that a metabolism is channeled to resist the stress. *In vitro* evaluation (Khatab and El-Garhy, 2016) of salinity effects on male aspen clone W52 (*Populus tremula* L.) and the hybrid aspen clone T89 (*Populus tremula* L. × *Populus tremuloides* ‘Michx’) were investigated after seawater treatments (control, and ‘concentrations’ of 8,0, 12,0 and 14,0 dS/m). They found salinity level of 14,0 dS/m to be lethal, which closely corresponds with the effect of medium with 150 mM NaCl whose electrical conductivity was 17,04 dS/m. All the vegetative parameters of both *Populus* clones were significantly decreased at 12,0 dS/m, which is relatively close to the electrical conductivity of 11,40 dS/m in medium with 100 mM NaCl, which we used for the evaluation of examined genotypes.

### Conclusions

After 35 days of cultivation *in vitro* the variation of all tested morphological parameters was found to be significantly influenced by the main effect of medium. According to the results of the LSD test there is a significant difference in the tested properties between examined media. Because of toxic effect of medium with 150 mM NaCl, and the fact that the best differentiation of genotypes was achieved on medium in which the salt concentration was 100 mM, medium with 100 mM NaCl was used to compare examined genotypes. The best salt tolerance achieved genotype L-80, which had the highest tolerance index for the length of the longest root and for shoot height. The most negative effect on the shoot height on the medium with a concentration of 100 mM was observed in the genotype L-12. The medium with 150 mM NaCl produced toxic effect.

### Acknowledgements

This paper was realized as a part of the projects „Studying climate change and its influence on the environment: impacts, adaptation and mitigation“ (43007) financed by the Ministry of Education and Science of the Republic of Serbia and project „Improvement of lowland forests’ management“ financed by the PE Vojvodinasume.

### References

- Ahuja M.R. (1984). A commercially feasible micropropagation method for aspen, *Silvae Genet.* 32, (174-176)
- Confalonieri M., Belenghi B., Balestrazzi A., Negri S., Facciotto G., Schenone G., Delledonne M. (2000). Transformation of elite white poplar (*Populus alba* L.) cv. "Villafranca" and evaluation of herbicide resistance, *Plant Cell Rep.* 19, (978-982)
- Das A. K., Dash M. C. (1990). Earthworm meal as a protein concentrate for broilers, *Trop. Agric. (Trinidad)*, 67(4), (342-344)
- Flowers T. J. (2004). Improving crop salt tolerance, *J. Exp. Bot.* 55, (307-319)

- Eggens C. F., Loughheed E.C., Hilton R. J. (1972). Rooting of hardwood cuttings of boleana poplar, *Can. J. Plant Sci.* 52, (599-604)
- Hasegawa P. M., Bressan R.A. and Pardo J. M. (2000). The dawn of plant salt to tolerance genetics, *Trends in Plant Sci.* 5, (317-319)
- Botella M.A., Rosado A., Bressan R.A. and Paul M. Hasegawa (2005). Plant adaptive responses to salinity stress. In: *Plant Abiotic Stress*. Jenks M. A. and Hasegawa P. M. (Eds.) Blackwell Publishing Ltd.
- Kovačević B., Miladinović D., Katanić M., Tomović Z., Pekeč S. (2013). The effect of low initial medium pH on in vitro white poplar growth, *Bulletin of the Faculty of Forestry*, 108, (67-80)
- Kovacevic B., Orlovic S., Roncevic S., Miladinovic D. (2010a). The effect of silver ion, 1-naphthalene acetic acid and 6-benzylaminopurine on micropropagation of „Fastgate“ tree shape variety *Populus alba* cl. LBM, *Acta Hort.* 885, (197-202)
- Kovacevic B., Tomovic Z., Stajner D., Katanic M., Drekić M., Stojnic S. (2010b). Restoration of autochthonous poplar species (*Populus* sp.) in riparian zone - genofond establishment, *Topola/Poplar 185/186*, (61-68) [In Serbian]
- Mahajan S., and Tuteja, N. (2005). Cold, salinity and drought stresses: An overview, *Arch. Biochem. Biophys.* 444, (139-158)
- Misra A. N., Murmu B., Singh P. and Misra M. (1996). Growth and proline accumulation mung bean seedlings as affected by sodium chloride, *Biol. Plant.* 38, (531-536)
- Munns R. (2002). Comparative physiology of salt and water stress, *Plant Cell Environ.* 25, (239-250)
- Munns R., Schachtman D. P. and Condon A. G. (1995). The significance of a two-phase growth response to salinity in wheat and barley, *Aust. J. Plant Physiol.* 22, (561-569)
- Rhoades J. D. and Loveday J. (1990). Salinity in irrigated agriculture. In B.A. Stewart et al. (eds.) *Irrigation of agricultural crops*. ASA, Madison, WI
- Khattab S., El-Garhy H.A. (2016). Genetic diversity and in vitro assessment of salt tolerance responses and associated changes in gene expression of male poplar (*Populus*) trees, *J. Hortic. Sci. Biotechnol.* 91(6), (551-561)
- StatSoft Inc. (2013). STATISTICA (data analysis software system), version 12.
- Turner R.C. and Marshal C. (1972). The accumulation of zinc by subcellular fractions of roots of *Agrostis tenuis* Sibth. in relation to zinc tolerance, *New Phytol.* 71, (671-676)
- Van Schilfgaarde, J. (1994). Irrigation – a blessing or a curse, *Agric Water Manag.* 25, (203-219)
- Vuksanović V., Kovačević B., Orlović S., Miladinović D., Katanić M., Kebert M. (2016). The effect of medium pH on white poplar shoots growth in vitro, *Book of proceedings of VII International Scientific Symposium, 06-09 October 2016, Jahorina, Bosnia and Herzegovina*, (2868-2873)
- Vuksanovic V., Kovacevic B., Katanic M., Orlovic S., Miladinovic D. (2017). In vitro evaluation of copper tolerance and accumulation in *Populus nigra*, *Arch. Biol. Sci.* (in press)
- Zhu J. K. (2002). Salt and drought stress signal transduction in plants, *Annu. Rev. Plant Biol.* 53, (247-273)

## MORPHOLOGICAL CHARACTERISTICS AND VARIABILITY OF THE SEEDLINGS OF THE SYCAMORE MAPLE (*Acer pseudoplatanus* L.)

Vladan POPOVIĆ\*, Tatjana ĆIRKOVIĆ-MITROVIĆ, Ljiljana BRAŠANAC-BOSANAC, Ljubinko RAKONJAC, Aleksandar LUČIĆ

Institute of Forestry, Belgrade, Serbia

\*Corresponding author: vladanpop79@gmail.com

### Abstract

The comparative morphometric analysis of 11 half-sib family of the sycamore maple showed variability of the seedlings within and between lines. The seed used for the analysis was collected from micro-populations on the territory of Belgrade (Serbia). The trial was established at the seedling nursery of the Institute of Forestry in Belgrade (Serbia). At the age of 30 days on a sample of 30 seedlings per the half-sib family following characteristics were measured: length of root as well as length of epicotyl, hypocotyl and cotyledon, cotyledon width, weight of seedling, root collar diameter and number of cotyledons. The obtained results contribute to acquiring knowledge on the analyzed characteristics, give a preliminary assessment of the genetic variability of the studied half-sib family and make a good basis for an adequate use of the genetic potential of the species.

**Key words:** *sycamore maple, seedling, half-sib family, variability.*

### Introduction

The sycamore maple (*Acer pseudoplatanus* L.) is the most commonly found maple in Europe and an important species in its woods (Spiecker *et al.*, 2008) that has been presented on this continent since glacial (Svenning and Skov, 2004, 2005). The presence of the sycamore maple enhances the humus formation and the nutrient cycling (Wittich, 1961; Weber *et al.*, 1993; Heitz and Rehfuess, 1999). The preservation of the sycamore maple as a species can increase the ecological values of the habitat and the landscape diversity (Stern, 1989; Pommerening, 1997; Bell, 2008). The sycamore maple is mentioned in many studies as a species that is well adapted to the anticipated future climate conditions in Central Europe (Kölling and Zimmermann, 2007; Kölling, 2007).

Most researches on the sycamore maple have been performed in later stages of the development of an individual tree whereby the specificity and the variability of the juvenile and adult trees have been recorded (Bojović, 1989; Šijačić-Nikolić *et al.*, 2009; Ivetić and Tucović, 2003; Popović *et al.*, 2015). The morphology and the variability of the seedlings of the sycamore maple are very significant for better understanding of the variability and the taxonomy of the species, the seedling production and the breeding in the stand conditions. Having in mind the importance of the information gained in the earliest stages of the development of the seedlings, variability of eight morphometric characteristics of the seedlings of eleven half-sib family of the sycamore maple was analyzed in this paper.



## Material and Method

The seed used for the analysis of the characteristics and the variability of the sycamore maple (*Acer pseudoplatanus* L.) seedlings was collected from micro-populations on the territory of Belgrade (Serbia). 11 mother trees were selected for the test trees using the individual selection on the field. The seed was collected from each tree with the aim to breed the half-sib family using the method for the genetic analysis of trees (Isajev and Mancic, 2001). The pre-sowing seed treatment included the stratification of the seed in the moist sand for 5 months at the temperature 3-5° C. The sowing was conducted in April 2012 at the seedling nursery of the Institute of Forestry in Belgrade (Serbia), in a hotbed size 1x10 meters. The space between rows in the hotbed is 15 cm, and the rows are parallel with the longer side of the hotbed.

The analysis of the morphometric characteristics and the variability within and between family of the seedlings was performed 30 days after sowing. In a sample of 30 seedlings from each half-sib family the following characteristics were measured: length of root as well as length of epicotyl, hypocotyl and cotyledon, cotyledon width, weight of seedling, root collar diameter and number of cotyledons. The descriptive statistics (boundary values, mean value, standard deviation and coefficient of variation) was performed for each characteristic. The variability between family of the seedlings, at the level of the analyzed characteristics, was determined by the one-way analysis of variance (ANOVA). The measured data are statistically processed by the software package Statistica 7 (StatSoft, Inc. 2004).

## Results and Discussion

Several parameters of descriptive statistics for the examined morphometric characteristics of seedlings of 11 half-sib family of the sycamore maple are presented in Table 1. The analysis of seedlings characteristics is very significant for studying the variability in some species. By studying the morphometric characteristics of seedlings in the early stage of the development the differences that mostly are the consequence of the genetic variability can be detected. The studied morphometric characteristics of the seedlings can also be the basis for the assessment of the further development of the seedlings.

The most variable characteristic is the weight of the seedlings, and the lowest variability was recorded in the number of cotyledons (Table 1). The obtained data show the presence of the genetic variability between half-sib family.

Table 1: Variability of the morphometric characteristics of 11 half-sib family of the sycamore maple seedlings

	Min	Max	Average	Standard deviation
Length of root (mm)				
1	72	195	124.17	28.70
2	75	196	118.87	30.13
3	59	127	95.43	16.97
4	70	125	100.90	12.64
5	66	126	100.87	14.61
6	79	161	115.70	20.95
7	64	175	109.30	15.67
8	81	144	110.43	25.55
9	73	146	103.27	19.53
10	76	125	103.20	14.14
11	75	185	122.03	21.82

Hypocotyl length (mm)				
1	19	49	37.73	7.58
2	26	59	44.63	7.64
3	33	71	49.17	8.52
4	40	79	59.77	11.81
5	32	72	47.07	9.56
6	30	61	45.90	8.12
7	24	60	41.19	8.14
8	30	54	39.67	6.46
9	29	56	40.00	6.76
10	22	57	39.07	8.45
11	29	62	42.97	10.30
Epicotyl length (mm)				
1	20	43	31.13	6.55
2	24	55	38.30	7.35
3	22	61	42.73	10.10
4	33	81	56.57	11.40
5	14	49	48.77	13.22
6	11	49	28.07	8.92
7	21	55	36.90	10.41
8	27	49	37.30	6.39
9	30	64	48.47	8.53
10	26	59	41.40	6.78
11	23	69	36.17	8.79
Cotyledon length (mm)				
1	34	54	42.10	4.79
2	34	46	39.57	3.24
3	35	51	42.50	4.18
4	36	61	48.70	5.91
5	36	54	47.07	4.37
6	31	46	35.80	3.51
7	34	56	42.13	4.91
8	34	47	41.40	3.42
9	35	49	42.37	4.33
10	38	54	45.40	3.90
11	36	54	42.33	3.12
Cotyledon width (mm)				
1	6	12	9.17	1.53
2	6	10	8.10	1.18
3	6	11	8.23	1.14
4	7	14	10.07	1.68
5	6	12	9.20	1.27
6	5	9	7.13	0.82
7	6	13	9.23	1.48
8	8	11	9.60	0.67
9	7	10	8.33	0.77
10	6	11	8.83	1.12
11	6	10	8.77	1.34
Weight (g)				
1	0.62	1.53	1.03	0.28
2	0.49	1.4	1.02	0.24
3	0.4	1.36	0.79	0.20
4	0.78	2.25	1.13	0.30
5	0.56	1.47	1.01	0.23
6	0.39	1.41	0.85	0.21
7	0.49	2.01	1.12	0.44
8	0.55	1.59	0.95	0.22
9	0.54	1.14	0.99	0.32

10	0.62	1.54	0.79	0.21
11	0.42	2.01	1.04	0.26
Root collar diameter (mm)				
1	1.34	2.44	1.87	0.23
2	1.51	2.38	1.88	0.18
3	1.27	2.33	1.75	0.22
4	1.64	2.19	1.91	0.14
5	1.3	2.14	1.80	0.21
6	1.12	1.94	1.59	0.19
7	1.59	2.74	2.01	0.23
8	1.51	2.13	1.79	0.16
9	1.45	2.33	1.83	0.21
10	1.47	2.36	1.96	0.21
11	1.44	2.13	1.79	0.17
Number of cotyledons				
1	2	3	2.07	0.25
2	2	3	2.07	0.25
3	2	2	2.00	0.18
4	2	3	2.03	0.18
5	2	3	2.07	0.25
6	2	2	2.00	0.00
7	2	2	2.00	0.00
8	2	2	2.00	0.00
9	2	2	2.00	0.00
10	2	3	2.03	0.18
11	2	3	2.03	0.00

Based on the obtained data (Table 1) the following can be concluded:

The root length ranges from 59 to 196 mm. The highest mean value of the root length has the half-sib line 1 (124.17 mm) and the lowest the half-sib family 5 (100.87 mm);

The hypocotyl length in all 11 half-sib family ranges from 19 to 79 mm. The highest mean value of the hypocotyl length have the seedlings of the half-sib family 4 (59.77 mm) and the lowest the seedlings of the half-sib family 1 (37.73 mm);

The epicotyl length ranges from 11 to 81 mm. The highest mean value of the epicotyl length have the seedlings of the half-sib family 4 (56.57 mm) and the lowest the seedlings of the half-sib family 6 (28.07 mm);

The cotyledon length of the seedlings ranges from 31 to 61 mm. The highest mean value of the cotyledon length have the seedlings of the half-sib line 4 (48.7 mm) and the lowest the seedlings of the half-sib family 6 (35.8 mm);

The cotyledon width of the seedlings ranges from 5 to 14 mm. The highest mean value of the cotyledon width have the seedlings of the half-sib family 4 (10.07 mm) and the lowest the seedlings of the half-sib family 6 (7.13 mm);

The weight of the seedlings ranges from 0.39 to 2.25 g. The highest mean value of the weight have the seedlings of the half-sib family 4 (1.13 g) and the lowest the seedlings of the half-sib family 10 (0.79 g);

The root collar diameter of the seedlings ranges from 1.12 to 2.74 mm. The highest mean value of the root collar diameter have the seedlings of the half-sib family 7 (2.01 mm) and the lowest the seedlings of the half-sib family 6 (1.59 mm);

The number of cotyledons ranges from 2 to 3. The highest mean value of the number of cotyledons have the seedlings of the half-sib family 1, 2, 5 (2.07 pieces), and the lowest the seedlings of the half-sib family 3, 6, 7, 8, 9 (2 pieces).

Comparing the obtained data it can be concluded that the seedlings of the half-sib family 4 have the highest mean values for the most analyzed characteristics, while the seedlings of the half-sib family 6 have the lowest mean values.

Table 2: Analysis of variance for the morphometric characteristics of the seedlings

	Sum of Squares	Df	Mean Square	F- Ratio	P- Value
Length of root					
Between groups	27,882.0	10	435.896	6.40	0.0000
Within groups	139,487.0	320	2,788.2		
Total	167,369.0	330			
Hypocotyl length					
Between groups	23,779.3	10	1,186.32	15.96	0.0000
Within groups	35,642.4	320	74.3102		
Total	11,863.2	330			
Epicotyl length					
Between groups	47,592.7	10	2,055.86	34.34	0.0000
Within groups	27,034.1	320	84.4815		
Total	20,558.6	330			
Cotyledon length					
Between groups	3,673.39	10	17.9252	20.49	0.0000
Within groups	5,736.05	320	367.339		
Total	9,409.44	330			
Cotyledon width					
Between groups	196.01	10	19.601	13.09	0.0000
Within groups	479.186	320	1.49746		
Total	675.196	330			
Weight					
Between groups	4.19454	10	0.419454	5.60	0.0000
Within groups	23.9814	320	0.0749418		
Total	28.1759	330			
Root collar diameter					
Between groups	3.75591	10	0.375591	9.49	0.0000
Within groups	12.6713	320	0.0395978		
Total	16.4272	330			
Number of cotyledon					
Between groups	0.255287	10	0.0255287	0.96	0.4774
Within groups	8.5	320	0.0265625		
Total	8.75529	330			

For every studied characteristics the one-way analysis of variance (ANOVA) was performed to determine if there are statistically significant effect of differences between half-sib family on the total variation (Table 2). The results of the analysis of variance show that effect of differences between 11 half-sib family of the sycamore maple on total examined variation is statistically significant for all studied characteristics of the seedlings except for number of cotyledons.

For a long time there was a viewpoint that the parameters of the variability of the seedlings' characteristics are not very significant, so the characteristics of the seedlings were presented only at a typological basis (Anić, 1983). This viewpoint is not accepted nowadays. The variability of the seedlings is an adaptive characteristic and it is controlled by the natural selection because the genetic factors determine the extent and the direction of the permitted phenotypic plasticity (Tucović, 1990). The variability of the seedlings could be interpreted as a result of the interaction between genetic heritage and selection. Age changes throughout the life cycle are the result of two contradictory tendencies. One tendency is towards a higher differentiation from germination to maturity and the other is towards the adaptation in every stage of the life cycle. Determining what is a share of the heritage or the environment in a particular character is of a great importance in the field of production and cultivation of species (Tucović and Isajev, 2000.). The first, and often the strongest, selection takes place when the plant is in the germination phase. The larger dimensions of cotyledons, the characteristics of a hypocotyl or an epicotyl, the surplus of cotyledons, the features of the root system lead to the better characteristics of mature trees. Therefore studying of these seemingly minor qualities of the seedlings becomes increasingly significant (Tucović and Isajev, 2000.).

### **Conclusion**

The comparative analysis of the morphometric characteristics of the seedlings was performed in order to determine the character of the genetic and morphological variability of the analyzed half-sib lines of the sycamore maple. Based on the comparative analysis of the 11 half-sib family the detailed data on morphology and variability of several characteristics of the seedlings have been presented. Based on the obtained statistical parameters it can be concluded that there is the genetic variability both within and between the analyzed half-sib lines. The analyzed characteristics of the seedlings are quantitative, controlled by many genes. The variability of the quantitative characteristics is continuous, and it is influenced by the genetic and environmental factors and their interaction.

For the preservation and the direct use of the available gene pool of the studied mother trees of the sycamore maple it is necessary to know the genetic variability. The determined variability of the morphological characteristics of the seedlings can serve as an indicator of the further development of the seedlings of the selected half-sib family, which contributes to the improvement of seed and nursery production.

### **References**

- Anić M. (1983). Seedlings. In: Forestry encyclopedia, Zagreb, 2, (246-259) (Klijanci, Šumarska enciklopedija, Zagreb, 2, (246-259))
- Bojović S. (1989). Variability of the characteristics of trees of experimental cultures and half-sib families as the basis for the breeding of the sycamore maple (*Acer pseudoplatanus* L.), MSc thesis, Faculty of Forestry, University of Belgrade, Belgrade, (1-161) (Varijabilnost svojstava stabala oglednih kultura i half-sib familija kao osnova za oplemenjivanje gorskog javora (*Acer pseudoplatanus* L.), Magistarski rad, Šumarski fakultet Univerziteta u Beogradu, Beograd, (1-161))

- Bell S. (2008). Valuable broadleaved trees in the landscape. In: Spiecker, H., Hein, S., Makkonen-Spiecker, K., Thies, M. (Eds.) Valuable broadleaved forests in Europe, EFI Research-Report, European Forest Institute, in print.
- Isajev V., Mančić A. (2001). Forest seed production, Faculties of Forestry in Banja Luka and Belgrade (1-283) (Šumsko semenarstvo, Šumarski fakultet, Univerzitet u Banja Luci, Univerzitet u Beogradu – Šumarski fakultet, Banja Luka, Beograd (1-283))
- Ivetić V., Tucović A. (2003). Occurrence of poly-winged fruits on cultivated sycamore maples (*Acer pseudoplatanus* L.). Bulletin of the Faculty of Forestry 87, (119-127). (Pojava višekrilatih plodova na gajenim stablima gorskog javora (*Acer pseudoplatanus* L.). Glasnik Šumarskog fakulteta 87, (119-127))
- Kölling C. (2007). Klimahüllen für Waldbaumarten. Allgemeine Forstzeitschrift/ Der Wald, 1005 23, (1242-1245)
- Kölling C., Zimmermann L. (2007). Die Anfälligkeit der Wälder Deutschlands gegenüber dem Klimawandel. Gefahrstoffe 67, (259-268)
- Heitz R., Rehfuess K.E. (1999). Reconversion of Norway spruce (*Picea abies* (L.) Karst.) stands into mixed forests: effects on soil properties and nutrient fluxes. In: Olsthoorn, A.F.M.
- Pommerening A. (1997). Erwartete und beobachtete Artendurchmischung am Beispiel von Buchen-Edellaubholzbeständen. Sektion Ertragskunde im Deutschen Verband Forstlicher Forschungsanstalten, Jahrestagung 1997, Grünberg, 12.-14. Mai 1997, (45-59)
- Popović V., Ćirković-Mitrović T., Lučić A., Rakonjac Lj., Ratknić M. (2015). Relation of the morphological indicators of quality of one-year-old seedlings of the sycamore maple (*Acer pseudoplatanus* L.). Journal Forestry 4. Association of forestry engineers and technicians of Serbia, (67-74). (Odnos morfoloških pokazatelja kvaliteta jednogodišnjih sadnica gorskog javora (*Acer pseudoplatanus* L.). Šumarstvo 4. Udruženje šumarskih inženjera i tehničara Srbije. (67-74))
- Spiecker H., Hein S., Makkonen-Spiecker K., Thies M. (Eds.) (2008). Valuable broadleaved forests in Europe, EFI Research-Report, European Forest Institute, Joensuu, in print.
- Svenning J.-C. Skov F. (2005). The relative roles of environment and history as controls of tree species composition and richness in Europe. - Journ. Biogeography 32, (1019-1033)
- Stern R.C. (1989). Sycamore in Wessex. Forestry 62, (365-382)
- Tucović A. (1990). Forms of variability and their classification, Genetics with Plant Breeding, Scientific book, Belgrade, (124-154). (Oblici promenljivosti i njihova klasifikacija, Genetika sa oplemenjivanjem biljaka, Naučna knjiga, Beograd, 124-154.)
- Tucović A., Isajev V. (2000). Characteristics and variability of false indigo-bush (*Amorpha fruticosa* L.) – Weed species of flood stands, Acta herbologica, 9, (1), (101-111). (Karakteristike i varijabilnost klijavaca bagrenca (*Amorpha fruticosa* L.) – korovske vrste plavnih staništa, Acta herbologica, 9, (1), (101-111))
- Weber G., Rehfuess K.E., Kruezer K. (1993). Über den Einfluß naturnaher Waldwirtschaft auf den chemischen Bodenzustand. Allgemeine Forst Zeitschrift 48, (68-71).
- Wittich W. (1961). Der Einfluß der Baumart auf den Bodenzustand. Allgemeine Forst Zeitschrift 16, (41-45).
- Šijačić-Nikolić M., Milovanović J., Knežević, R. (2009). Phenotypic stability of *Acer pseudoplatanus* cv *Atropurpureum* traits as a baseline of breeding process. Journal of Horticulture and Forestry. Academic Journals, 1, (3), (038-042)

## FOREST STAND MANAGEMENT OF *QUERCUS ROBUR* AND *Q. PYRENAICA* IN GALICIA (NW SPAIN) REGARDING ENVIRONMENTAL FACTORS

Ignacio J. DIAZ-MAROTO\*, Pablo VILA-LAMEIRO, Maykel RAMON-PUMAR

Department of Agroforestry Engineering, University of Santiago de Compostela, Spain

\*Corresponding author: ignacio.diazmaroto@usc.es

### Abstract

The aim of this work was to study forest stand management of two oak species that inhabit the major surface in Galicia (northwestern Spain), *Quercus robur* L. and *Quercus pyrenaica* Willd. To achieve this goal, we have started with the characterization of the forest site occupied by natural forests of both species. Since some parameters have greater meaning than others regarding environment descriptors, we carried out a discriminant plot analysis for each species in order to identify parameters with greater descriptive weight, using the program Two-Way Indicator Species Analysis (TWINSPAN). This analysis is based on the estimate of 25 ecological parameters (i.e., topographical, climatic and edaphic) through sampling of 39 *Quercus robur* and 40 *Q. pyrenaica* plots. The results demonstrate that the distribution of oaks is related principally to the climate and the topography, and to a smaller extent to soil factors. Therefore, it is necessary to find out silvicultural treatment alternatives in order to obtain economic production that would be more profitable than the one being obtained now with traditional methods and inadequate forestry practices (pollarding and felling of the best trees). Some alternative methods could be the following ones: i) conversion to high forests, ii) maintenance of coppice forests in areas of certain quality and homogeneity where firewood is still used, iii) silvopastoral improvement in zones with grazing importance, and iv) restoration of degraded stands through reforestation with other native broadleaved species.

**Key words:** *Ecological factors, northwestern Spain, TWINSPAN, oak species*

### Introduction

The *Quercus* species cover a great part of the temperate climax forests of the northern hemisphere as well as the subtropical transition area (Pulido, 2002). Over 400 oak species occur within these regions. The majority of oaks are found in Mexico, but also extend throughout North America, Europe, and Asia, excluding the southern hemisphere (Miller and Lamb, 1985; Rangel *et al.*, 2002). In Galicia, the climax vegetation should consist of different oak species were part of deciduous forests of *Quercus-Fagetea* class (Rivas-Martínez, 1987). From the phytosociological viewpoint, these forests correspond with the following associations (Rivas-Martínez, 1987; Izco *et al.*, 1999; Rivas-Martínez *et al.*, 2001): *Myrtillo-Quercetum roboris* P. Silva, Rozeira & Fontes 1950, *Rusco aculeati-Quercetum roboris* Br.-Bl., P. Silva & Rozeira 1956, *Blechno spicanti-Quercetum roboris* Tx. & Oberdofer 1958, *Linario triornithophorae-Quercetum pyrenaicae* Rivas-Martínez *et al.* 1984, *Holco mollis-Quercetum pyrenaicae* Br.-Bl., P. Silva & Rozeira 1956, and *Genisto falcatae-Quercetum pyrenaicae* Rivas-Martínez in Penas & Díaz 1985.

Within the Galician region, the natural distribution of *Quercus robur* L. and *Q. pyrenaica* Willd., overlap with a wide range of transition (Díaz-Maroto *et al.*, 2006) causing introgressive hybridization forming *Quercus x andegavensis* Hy (Amaral, 1990). The *carballeiras*, pure stands of *Quercus robur* or mixed with other deciduous trees occupy a

surface of 246,445 ha, 18% of the total woodland area of Galicia, while the *rebollares*, forests of *Quercus pyrenaica* occupy 76,571 ha, 6% of the total forest area (MAGRAMA, 2011). From the forestry standpoint, many of these oak forests have suffered abusive and inadequate silvicultural treatments such as selection felling of the best trees or pollarding which together with their breaking up for agricultural earth, the forest fires and the abandonment of its traditional use for firewood and vegetable coal, has driven the oak forests to its deteriorated present situation (McCreary, 2004; Diaz-Maroto *et al.*, 2005). The largest stands of deciduous oaks are located in mild-slope zones where they have remained given that the topography limits the potential use (Ruiz de la Torre, 1991). Most of Galicia has an oceanic climate characterized by high rainfall, although towards the southeast the climate is Mediterranean (Carballeira *et al.*, 1983). The substrates are of siliceous nature (i.e., granite and schist...), with deep soils, mostly cambisol and regosol (Carvalho *et al.*, 2005).

We hypothesize that the distribution of the natural stands of *carballo* (*Quercus robur*) and *rebollo* (*Q. pyrenaica*) in Galicia depends mainly on the topography and the climate and to a lesser extent on the edaphic factors. The aim of our study was to analyze and to compare the distribution of the two species trees in relation to the ecological characteristics of the land.

### Material and Methods

The area studied covers the “Comunidad Autónoma de Galicia” (NW Spain). We choose the sample areas and tried to select a number of representative oak stands based on the information of the “Mapa Forestal de España” (Ruiz de la Torre, 1991). In order to avoid edge effect worked with a minimum area between 0.5 and 1 ha (Hummel *et al.*, 1959), and to select the suitable location of the plots inside each forest stand, the prevailing environmental conditions were analyzed by selecting the site of standard characteristics (Zhang *et al.*, 2006). A network of rectangular sampling plots with 39 plots for *Quercus robur* and 40 for *Q. pyrenaica* was established. Plots were of variable dimension, depending on the number of trees, so that the inventory trees ( $\varnothing \geq 5$  cm) were not less than 50 (Hummel *et al.*, 1959).

The topographical and edaphic information was collected and together with climatic data adapted to each point of sampling according to the methodology of Carballeira *et al.* (1983), allowed us to elaborate in each plot the characteristic parameters of its physiography, climate and edaphology. Twenty-five ecological parameters were recorded (four topographical, five climatic and sixteen edaphic) (Table 1). The parameters used to describe the physiography of each plot were (Diaz-Maroto *et al.*, 2005; Diaz-Maroto *et al.*, 2006): mean altitude, mean slope, soil depth to parent rock, and closest distance to the sea in a straight line. The climate was described using the following parameters (Retuerto and Carballeira, 1991): annual total precipitation, summer precipitation, mean annual temperature, and annual mean of absolute maximum and minimum temperatures. Finally, to evaluate the chemical properties and soil fertility, 16 edaphic parameters were analyzed (Rubio *et al.*, 1997; Bravo-Oviedo and Montero, 2005; Diaz-Maroto and Vila-Lameiro, 2006): pH in H<sub>2</sub>O, organic matter, nitrogen, carbon-nitrogen ratio, available phosphorus and exchangeable potassium, calcium and magnesium. For all of these parameters we determined both their total value, calculating the weighted-average of all the profile through Russell and Moore method (1968), and the surface one with the edaphic epipedon data (higher than 20 cm), except when there is more than one horizon in that deep, 20 cm, and in these cases it is necessary to calculate a weighted-average.

We used univariate analysis to determine which parameters influence distribution of stands (Walpole *et al.*, 2002). Since some parameters have greater meaning regarding environment descriptors than others (Hix, 1988; ter Braak, 1994), we carried out a plot discriminant analysis for each species in order to identify the parameters with greater descriptive weight



for habitat, continuing the proposed methodology by Hill (1979) and using the program Two-Way Indicator Species Analysis (TWINSPAN) (Pisces Conservation LTD., 2004). Each parameter was divided into three intervals, establishing limits so that the number of plots included in each interval was approximately equal to a third of the total using the mean and standard deviation. With this division, we can include easily any other plot that we would like to analyze in any of the groups obtained in the classification (Martínez *et al.*, 1992):

Lower interval < Mean of the parameter – Standard Deviation (< M – SD)

Medium interval Mean of the parameter ± Standard Deviation (> M – SD; < M + SD)

Upper Interval > Mean of the parameter + Standard Deviation (> M + SD)

Table 1. Parameters calculated in each plot

Number	Parameter (units)	Code
1	mean altitude (m)	ALT
2	mean slope (%)	SLP
3	soil depth to the parent rock (cm)	DPT
4	closest distance to the sea (Km)	DS
5	annual precipitation (mm)	AP
6	summer precipitation (mm)	SP
7	mean annual temperature (°C)	MT
8	annual mean of absolute maximum temperatures (°C)	AMT
9	annual mean of absolute minimum temperatures (°C)	AmT
10	total pH in H <sub>2</sub> O	PH
11	surface pH in H <sub>2</sub> O	SPH
12	total organic matter (%)	OM
13	surface organic matter (%)	SOM
14	total nitrogen (%)	N
15	surface nitrogen (%)	SN
16	total C/N ratio	C/N
17	surface C/N ratio	SC/N
18	total available phosphorus (ppm)	P
19	surface available phosphorus (ppm)	SP
20	total exchangeable potassium (ppm)	K
21	surface exchangeable potassium (ppm)	SK
22	total exchangeable calcium (ppm)	Ca
23	surface exchangeable calcium (ppm)	SCa
24	total exchangeable magnesium (ppm)	Mg
25	surface exchangeable magnesium (ppm)	SMg

## Results and Discussion

The information of the inventory allows an analysis of the distribution of the Galician oak forests depending on the site characteristics. Table 2 shows the descriptive statistic for the parameters for both species. In the case of *Quercus robur*, SLP, AmT, P, SP, Ca, SCa, Mg and SMg parameters have the highest variability with a coefficient of variation (CV) > 70%. The high CV (> 40%) of the annual mean of the absolute minimum temperatures (AmT) turns out to be especially significant as well as also of certain edaphic parameters. On the contrary, less variability parameters (CV < 30%) were: DPT, AP, MT, AMT, PH, SPH and SC/N. For *Quercus pyrenaica*, the climatic and topographical parameters with a higher irregularity, CV > 50%, were: SLP, DPT and AmT. On the other hand, AP, MT and AMT parameters present a CV < 20% (Table 2). There is also a great heterogeneity of several edaphic parameters; even more marked than in *Quercus robur*. The discriminant parameters obtained in the characterization of groups correspond in all the cases with the topographic parameters (ALT, SLP, DPT and DS) and the climatic parameters (AP, MT, AMT and AmT). For *Quercus pyrenaica*, the resultant classification has given rise to eleven groups, being corresponded the discriminant parameters with physiographic (ALT, DPT and DS), climatic (SP, AMT), and even edaphic variables (P).

The value obtained for the mean slope (SLP) indicates the present location of many Galician oak forests in marked slopes with a complicated topography due to the difficulty of the physiographic characteristic (Ruiz de la Torre, 1991). The high heterogeneity of the annual mean of absolute minimum temperatures (AmT) in *carballo* as well as in *rebollo* is due to the high existing thermal rank in the area of study as extensive as Galicia (NW Spain) (Retuerto and Carballeira, 1991), accentuated by the altitudinal variation existing among the plots of each one of the species, with extreme altitudes that differ more than 1000 m. The values of the remaining climatic parameters are quite homogeneous which indicates the existence of a humid oceanic climate with Mediterranean conditions in certain zones (Carballeira *et al.*, 1983). The wide variety of lithologies, mainly siliceous, where *carballeiras* and *rebollares* are located, and give rise to acid soils with scarce variation of pH values (Table 2) (Diaz-Maroto and Vila-Lameiro, 2006). The difference in the behaviour of the parameter soil depth to the parent rock (DPT), among both species, is due to the fact that the soil where *Quercus robur* lives is quite deep; since it has a highly developed root system with strong roots that can penetrate the soil up to 1.5 m (Diaz-Maroto *et al.*, 2005). Nevertheless, although the soils on which the *Q. pyrenaica* stands are establish are also, generally deep, they have shallow depths in certain plots where they have suffered repeated forest fires, but this does not represent a problem for its adequate development given the root system of this species (Carvalho *et al.*, 2005; Diaz-Maroto *et al.*, 2010).

The method used to analyze the distribution of the Galician oak forests proved to be adequate for the classification of areas occupied by different tree species (Hix, 1988; Kent and Coker, 1996). For example, Aude and Lawesson (1998) studied the vegetation of the Danish beech forests in relation to ecological factors and their management; Lawesson (2000) carried out an analysis of the vegetation of the native forests of Denmark, and Grabherr *et al.* (2003) in the Austrian forests. Also, recently Zhang *et al.* (2006) studied the relationships between environment and plant communities in North China.

In the two species tested, the majority of end groups belong to the fourth level of hierarchical classification and some of them on the third level, since the characteristics of certain groups of plots are not significant enough to belong to the fourth level of classification (Hill, 1979; Hill and Šmilauer, 2005). We have neither considered in any case a minimum number of plots by final groups of the classification, and no limit the maximum number of parameters. We have used all the calculated parameters, namely the 25 parameters of the described site,

since we consider that none of them have a special characteristic in relation to the distribution of the forests of *Quercus robur* and *Q. pyrenaica* in Galicia (Buide *et al.*, 1998; Diaz-Maroto *et al.*, 2005; Diaz-Maroto *et al.*, 2006).

When determining the final groups of the TWINSPAN in the *Quercus robur* forests, only topographical (ALT, SLP, DPT and DS) and climatic (AP, MT, AMT and AmT) parameters were considered. Many of the stands are located in zones of complicated physiography with marked slope, although some of them are located in the bottom of valleys. They are located in low or average altitude areas and variable orientation with preference to shady places. On the other hand, the edaphic depth is high due to the presence of numerous areas in thalweg zones where depth, fresh, and loose soil are particularly appropriate for *Quercus robur* given their root system and strong main root that deeply penetrates the surface (Timbal and Aussenac, 1996). The values of the straight line distance to the sea parameter are between 1 and 135 km (Table 2), which coincides with the potential distribution of the vegetation in Galicia (Rivas-Martínez, 1987; Izco *et al.*, 1999). Even so, some stands of *carballo* are found far away of their normal area of distribution, in these cases there may appear hybrids with other species of *Quercus* spp., such as *Quercus petraea* (Matts) Liebl. in Ancares and Invernadeiro plots and *Q. pyrenaica* in Valdín plot (Diaz-Maroto and Vila-Lameiro, 2007). These regions are found in higher altitudes and have high continental influences which are not optimum for the presence of *Quercus robur* (Diaz-Maroto *et al.*, 2005).

As for the climatic characteristics, the majority of *Quercus robur* forests are located in zones with annual precipitation around or over 1000 mm and summer precipitation between 100 and 200 mm which indicates high environmental humidity requirements (Timbal and Aussenac, 1996). These show scarce amplitude in the values of the thermal parameters, except for the annual mean of absolute minimum temperatures, AmT, due to the fact, as we mentioned, that the inventoried stands are located inside a very extensive land, with great thermal amplitude even more marked given the high altitudinal rank (Retuerto and Carballeira, 1991). It is also important to emphasize that the existence of *carballeiras* in areas with scarce summer precipitation is a factor that does not favour the development of *Quercus robur* (Diaz-Maroto *et al.*, 2005). Although in these areas, the shortage of precipitation in the summer months may be compensated by the effect of the maritime mists and fogs. They are stands located in the south of Galicia, mainly in the province of Ourense, where there is a climate with some Mediterranean trend (Carballeira *et al.*, 1983).

The discriminant parameters of the eleven final groups obtained as a result of the application of the TWINSPAN to the forests of *rebollo* were: three physiographic parameters (ALT, DPT and DS), two climatic parameters (SP and AMT) and one edaphic parameter (P).

Similar to the *carballeiras* much of the sampled *rebollares* occupy zones of upper-middle slope conditions. The *rebollares* are also located in thalweg as a result of human pressure, mainly forest fires and use of firewood and vegetable coal (Carvalho *et al.*, 2005). These forests are located at average and high altitude areas with variable orientation, but with preference to sunny orientation, especially in the northern part of the study area. However, toward the southern portion of their range they prefer the shady areas due to greater Mediterranean conditions (Carvalho *et al.*, 2005). Although many stands lie on deep soils in the valley bottoms, others lie on areas with shallow soils along sharp slope zones where repeated fires have caused soil loss. *Quercus pyrenaica* adapts well to both situations due to its root system with a powerful main root that penetrates deeply and numerous superficial secondary roots (Carvalho *et al.*, 2005). The DS parameter (distance to sea) covers between 29 and 144 km (Table 2), which again coincides with the potential distribution of the vegetation inside the area of study (Izco *et al.*, 1999).

The annual precipitation varies between 748 and 1460 mm, with summer precipitation between 55 and 167 mm (Table 2), which indicates an environmental humidity requirement

although to a lesser extent compared to *Quercus robur* (Carvalho *et al.*, 2005). Regarding the thermal pattern, there is scarce amplitude of the values corresponding to climatic parameters except for the AmT as in the *carballeiras* (Diaz-Maroto *et al.*, 2006). On one hand, it is important to stand out the existence of *rebollo* stands in relatively far away areas of its potential habitat, areas that present an oceanic hyperhumid climate less appropriate for the presence of *Quercus pyrenaica* and, on the other hand, zones with scarce summer precipitation and AMT > 25°C, which emphasizes the fitoclimatic position, more Mediterranean of *Quercus pyrenaica* with respect to the European Atlantic oaks (pedunculate and sessile oaks) (Del Rio *et al.*, 2005).

The mean value of the phosphorus macronutrient is lower than the one obtained in the *Quercus robur* forests, which is similar to the data obtained by other authors for this type of formations (Gallardo *et al.*, 1995; Carvalho *et al.*, 2005). This may indicate that the occupied zones by *rebollares* now have not suffered a change due to the soil use, (e.g., agriculture) (Diaz-Maroto *et al.* 2006). The rest of the macronutrients show higher values (Table 2).

The oak forests studied have a wide range of ages and site qualities as a consequence of the different anthropogenic uses and its current conservation status (Diaz-Maroto *et al.*, 2005). The dominant type of oak stand in Galicia is the coppice forest which requires constant management, otherwise, the stands age, stop growing, and eventually disappear (Carvalho *et al.*, 2005). The future of these forests depends on the problem both silvicultural and economic transformation (McCreary, 2004), and the present situation is characterized by: 1) Slow growth, scarce seeding, and unfavourable conditions for the development of the seedlings; 2) Risk of vegetation decline due to aging of the shoots, 3) Closed canopy with trees of small diameter, some of them top-dried and prevalence in the understory of heliophilous scrubs that gives rise to a high risk of forest fire. The morphological features and the mesophytic nature of *Quercus pyrenaica*, as well as its silvicultural characteristics ones give them a transitional meaning between the European oaks (*Quercus robur* and *Q. petraea*) and the Mediterranean species of *Quercus* genus (Amaral, 1990; Diaz-Maroto and Vila-Lameiro, 2007). As mentioned before, the natural stands of *carballo* and *rebollo* within the study area, represent a marked transition zone (Diaz-Maroto *et al.*, 2006), which can influence on the recurrence of discriminant parameters obtained in the division of groups by the application of TWINSpan. Within the topographical variables, the parameters ALT, DPT and DS, appear in both cases and, in the climatic variables, the annual average temperature of the absolute maximums is repeated (AMT). It is also striking that the annual precipitation (AP) is a discriminating parameter for *Quercus robur*, whereas for *Quercus pyrenaica*, is a summer precipitation (SP), although you might think that is logical given the sites of both species (Diaz-Maroto *et al.*, 2005; 2006; 2010).

In the first case, the environmental humidity requirements turn out to be essential (Diaz-Maroto *et al.*, 2005) and in the *rebollo* habitat, minimum value of summer precipitation is fundamental (Diaz-Maroto *et al.*, 2006). For *Quercus pyrenaica*, the phosphorous presence as a classification parameter can be attributed to its greater concentration in the *carballo* soils, which indicates the existence of old fields in zones that were abandoned and colonized by this species (Diaz-Maroto and Vila-Lameiro, 2005). Summarizing, the environmental conditions do not preclude the application of an alternative forestry for more profitable results than with traditional methods and inadequate forestry practices used (pollarding and felling of the best trees). Regarding the final groups of TWINSpan, there is not any pattern for the two species (Grabherr *et al.*, 2003). In the *carballo* stands, the final group with greater number of plots corresponds to H with 9 plots, and the ones with smaller number correspond to F and K with a single plot. In the *rebollares*, the final groups V and VII have 6 plots and the groups III, VI, VIII and XI, 2 plots.

Table 2. Descriptive statistics of the ecological parameters

Parameter	Minimum		Maximum		Mean		SD		CV	
	1	2	1	2	1	2	1	2	1	2
ALT	60	300	1300	1311	539	779	260	278	48.2	35.5
SLP	0	0	72	63	27	25	21	17	77.7	69.9
DPT	46	20	150	300	94	101	26	51	27.6	50.3
DS	1	29	135	144	42	90	28	28	66.6	30.9
AP	772	748	1947	1460	1372	1068	298	215	22.7	20.1
SP	61	55	283	167	164	115	49	34	31.3	29.4
MT	7.30	7.40	14.60	13.50	11.50	10.40	1.43	1.86	13.0	17.9
AMT	20.00	16.00	28.80	25.80	24.00	22.63	35.08	2.13	8.3	9.4
AmT	-4.30	-3.90	6.20	4.20	0.80	-0.50	2.53	2.49	300.0	400.0
PH	3.92	4.30	6.15	6.13	4.85	5.19	0.45	0.29	9.3	5.6
SPH	3.82	4.30	6.53	6.13	4.71	5.18	0.51	0.33	10.7	6.4
OM	1.040	1.010	23.310	11.300	8.645	4.102	5.175	2.691	60.0	65.6
SOM	1.190	1.434	34.210	16.792	12.853	5.510	7.761	3.784	60.4	68.7
N	0.042	0.024	0.793	0.555	0.307	0.151	0.178	0.118	58.0	78.3
SN	0.050	0.034	1.019	0.592	0.442	0.196	0.232	0.151	52.5	76.9
C/N	6.900	10.069	29.600	31.923	14.605	18.364	4.522	4.920	31.0	26.8
SC/N	10.400	10.449	30.100	31.607	16.751	18.354	4.258	5.156	25.3	28.1
P	0.400	0.770	117.200	71.600	21.823	9.445	28.588	13.268	133.6	140.5
SP	0.400	0.760	119.500	72.315	19.873	9.528	28.939	13.500	147.5	141.7
K	9.000	21.920	231.000	280.590	73.308	104.414	40.376	61.971	54.8	59.3
SK	19.000	30.935	252.000	267.260	102.718	116.428	50.119	63.269	48.5	54.3
Ca	3.000	0.010	1297.000	935.760	120.103	154.405	215.997	222.897	180.0	144.4
SCa	4.000	0.010	1704.000	1396.896	170.385	174.981	284.992	290.350	167.6	165.9
Mg	0.000	4.160	85.000	236.950	28.718	61.229	21.223	62.212	72.4	101.6
SMg	0.000	4.158	143.000	265.320	49.103	62.956	38.007	68.519	77.5	108.8

1 = *Quercus robur* datum; 2 = *Q. pyrenaica* datum; SD: standard deviation; CV: coefficient of variation

### Conclusions

The discriminant analysis method has been proven effective to study the distribution of the sites occupied by *Quercus robur* and *Q. pyrenaica* in Galicia (northwestern Spain), obtaining a hierarchical classification of plots, through the Two-Way Indicator Species Analysis (TWINSPAN) application. We can say that the distribution of the oak forests within the study area depends on the physiographical and climatic characteristics rather than edaphic conditions. Therefore, the environmental conditions do not exclude the application of a different silviculture to obtain more profitable results than with the traditional methods, and inadequate forestry practices used (pollarding and felling of the best trees). As alternative methods such as the high forest conversion of the stands, the maintenance of the coppice forest in areas of certain quality and homogeneity where the firewood is still used, the silvopastoral improvement in zones with grazing importance and the restoration of very degraded stands through the reforestation with other native broadleaved species.

## References

- Amaral J. (1990). *Quercus*. In Castroviejo, S. *et al.* (eds.), Flora Ibérica II [Iberian Flora]. C.S.I.C., Madrid.
- Aude E., Lawesson J.E. (1998). Vegetation in Danish beech forests: the importance of soil, microclimate and management factors, evaluated by variation partitioning. *Plant Ecology*, vol. 134, pp. 53-65.
- Bravo-Oviedo A., Montero G. (2005). Site index in relation to edaphic variables in stone pine (*Pinus pinea*) stands in Southwest Spain. *Annals of Forest Sciences*, vol. 62, pp. 61-72.
- Buide M.L., Sánchez J.M., Guitián J. (1998). Ecological characteristics of the flora of the Northwest Iberian Peninsula. *Plant Ecology*, vol. 135, pp. 1-8.
- Carballeira A., Devesa C., Retuerto R., Santillan E., Uceda F. (1983). Bioclimatología de Galicia [Bioclimatology of Galicia]. Xunta de Galicia-Fundación Barrie de la Maza.
- Carvalho J.P., Dos Santos J.A., Reimao D., Gallardo J.F. (2005). O Carvalho Negral [Pyrenean oak]. Universidade de Trás-os-Montes e Alto Douro, Vila Real, Portugal.
- Del Río S., Penas A., Pérez-Romero R. (2005). Potential areas of deciduous forests in Spain (Castile and Leon) according to future climate change. *Plant Biosystems*, vol. 139, pp. 222-233.
- Diaz-Maroto I.J., Vila-Lameiro P. (2006). Comparison between chemical properties and macronutrients content in soils of natural stands of *Quercus robur* L. and *Q. pyrenaica* Willd. in Galicia, Spain. *Agrochimica*, vol. 50, pp. 200-209.
- Diaz-Maroto I.J., Vila-Lameiro P. (2007). Deciduous and semi-deciduous oak forests (*Quercus robur*, *Q. petraea* and *Q. pyrenaica*) floristic composition in the Northwest Iberian Peninsula. *Biologia*, vol. 62, pp. 163-172.
- Diaz-Maroto I.J., Vila-Lameiro P., Silva-Pando F.J. (2005). Autoecology of oaks (*Quercus robur* L.) in Galicia (Spain). *Annals of Forest Sciences*, vol. 62, pp. 737-749.
- Diaz-Maroto I.J., Fernandez-Parajes J., Vila-Lameiro P. (2006). Autecology of rebollo oak (*Quercus pyrenaica* Willd.) in Galicia (Spain). *Annals of Forest Sciences*, vol. 63, pp. 157-167.
- Diaz-Maroto I.J., Fernandez-Parajes J., Vila-Lameiro P., Barcala-Perez E. (2010). Site index model for natural stands of rebollo oak (*Quercus pyrenaica* Willd.) in Galicia, NW Iberian Peninsula. *Ciência Florestal*, vol. 20, pp. 57-68.
- FAO (1999). World Reference Base for Soil Resources. World Soil Resources 84, Roma.
- Gallardo J.F., Santa Regina I.S., Harrison A.F., Howard D.M. (1995). Organic matter and nutrient dynamics in three ecosystems of the “Sierra de Bejar” mountains (Salamanca Province, Spain). *Acta Oecologica*, vol. 16, pp. 447-459.
- Grabherr G., Reiter K., Willner W. (2003). Towards objectivity in vegetation classification: the example of the Austrian forests. *Plant Ecology*, vol. 169, pp. 21-34.
- Hill M.O. (1979). Twinspan: A fortran program for arranging multivariate data in an ordered two-way table by classification of the individuals and attributes, New York.
- Hill M.O., Šmilauer P. (2005). TWINSPAN for Windows version 2.3. Centre for Ecology and Hydrology & University of South Bohemia, Huntingdon & Ceske Budejovice.
- Hix D.M. (1988). Multifactor classification and analysis of upland hardwood forest ecosystems of the Kichapoo River watershed, southwestern Wisconsin. *Canadian Journal of Forest Research*, vol. 18, pp. 1405-1415.
- Hummel F.C., Locke G.M.L., Jeffers J.N.R., Christie J.M. (1959). Code of sample plot procedure. Forestry Commission Bulletin 31. HMSO, London.

- Izco J., Amigo J., García-San León D. (1999). Análisis y clasificación de la vegetación leñosa de Galicia (España) [Analysis and classification of woody vegetation of Galicia, Spain]. *Lazaroa*, vol. 20, pp. 29-47.
- Kent M., Coker P. (1996). *Vegetation description and analysis. A practical approach*. John Wiley & Sons, New York.
- Lawesson J.E. (2000). Danish deciduous forest types. *Plant Ecology*, vol. 151, pp. 199-221.
- Martínez J.E., Ayuga E., González C. (1992). Estudio comparativo de distintas funciones núcleo para la obtención del mejor ajuste según el tipo de datos. *Qüesttió*, vol. 16, pp. 3-26.
- McCreary D. (2004). Managing and restoring California's oak woodlands. *Natural Areas Journal*, vol. 24, pp. 269-275.
- Miller H.A., Lamb S.H. (1985). *Oaks of North America*. Naturegraph Publishers, Happy Camp, California.
- Ministerio de Agricultura, Alimentación y Medio Ambiente (MAGRAMA) 2011. Cuarto Inventario Forestal Nacional, Galicia [Fourth National Forest Inventory, Galicia].
- Pisces Conservation LTD. (2004). *Community Analysis Package version 3.00*. A program to search for structure in ecological community data, England.
- Pulido F.J. (2002). Biología reproductiva y conservación: el caso de la regeneración de bosques templados y subtropicales de robles (*Quercus* spp.). *Revista Chilena de Historia Natural*, vol. 75, pp. 5-15.
- Rangel S.R., Zenteno E.C.R., Enriquez M.D. (2002). The genus *Quercus* (Fagaceae) in the state of Mexico. *Annals of the Missouri Botanical Garden*, vol. 89, pp. 551-593.
- Retuerto R., Carballeira A. (1991). Defining phytoclimatic units in Galicia, Spain, by means multivariate methods. *Journal of Vegetation Science*, vol. 2, pp. 669-710.
- Rivas-Martínez S. (1987). Memoria y mapas de series de vegetación de España 1:400.000 [Memory and maps of vegetation series of Spain]. ICONA, Ministerio de Agricultura, Pesca y Alimentación, Madrid.
- Rivas-Martínez S., Fernández-González F., Loidi J., Lousã M., Penas A. (2001). Syntaxonomical checklist of vascular plants communities of Spain and Portugal to association level. *Itinera Geobotanica*, vol. 14, pp. 5-341.
- Rubio A., Escudero A., Gandullo J.M. (1997). Sweet chestnut silviculture in an ecological extreme of its range in the west of Spain (Extremadura). *Annals of Forest Sciences*, vol. 54, pp. 667-680.
- Ruiz de la Torre J. (1991). Mapa Forestal de España [Forest Map of Spain]. Dirección General de Conservación de la Naturaleza, Instituto Geográfico Nacional, Ministerio de Medio Ambiente, Madrid.
- Russell J.S., Moore A.W. (1968). Comparison of different depth weightings in the numerical analysis of anisotropic soil profile data. *Proceedings 9th International Congress of Soil Science*, vol. 4, pp. 205-213.
- Timbal J., Aussenac G. (1996). An overview of ecology and silviculture of indigenous oaks in France. *Annals of Forest Sciences*, vol. 53, pp. 583-591.
- ter Braak C.J.F. (1994). Canonical community ordination. Part I: Basic theory and linear methods. *Ecoscience*, vol. 1, pp. 127-140.
- Walpole R.E., Myers R.H., Myers S.L., Ye K., Yee K. (2002). *Probability and Statistics for Engineers and Scientists*. Prentice-Hall, Upper Saddle River, New Jersey.
- Zhang J.T., Xi Y., Li J. (2006). The relationships between environment and plant communities in the middle part of Taihang Mountain Range, North China. *Community Ecology*, vol. 7, pp. 155-163.

## EVALUATION OF SOME RUNOFF AND PHYSICOCHEMICAL PARAMETERS IN AN ALCALINE STREAM OF SCOTS PINE FOREST

Ibrahim YURTSEVEN

Istanbul University Faculty of Forestry, Department of Watershed Management 34473 Bahçeköy, İstanbul-Turkey

\*Corresponding author: ibrahimiy@istanbul.edu.tr

### Abstract

This study contains evaluating runoff and physicochemical parameters data from some different tributaries of Oltu stream and it has been provided by interpreting Pearson correlation analysis. The watersheds dominated by Scots pine (*Pinus sylvestris* L.) In the data set used in the study, runoff (Q), water temperature (WT), pH, electric conductivity (EC), sodium (Na<sup>+</sup>), potassium (K<sup>+</sup>), calcium (Ca<sup>2+</sup>) and magnesium (Mg<sup>2+</sup>), carbonate (CO<sub>3</sub><sup>2-</sup>), bicarbonate (HCO<sub>3</sub><sup>-</sup>), chloride (Cl<sup>-</sup>), sulfate (SO<sub>4</sub><sup>2-</sup>), sodium absorption factor (SAR), and boron (B) concentration results of measurements were present. Correlation analysis were explained to relations between hydrologic and physiochemical parameters. According to the results of the analysis, some strong negative relations between the runoff and some other parameters (electric conductivity, sodium, chloride, sulfate, sodium absorption factor, and boron concentration) were found. The runoff and salinity have been found as hydrochemical parameters working as the key consideration. The physicochemical characterization of Oltu stream might be strongly influenced by the soil-water interaction. Besides, the dilution effect was shown in Oltu stream which has characterized snowmelt-dominated stream.

**Keywords:** *Runoff and physicochemical parameters, Oltu stream, Dilution effect*

### Introduction

Water quality of streams is mostly influenced by anthropogenic activities other than the physicochemical feature of the rain water which is affected by geologic and biotic conditions of the watershed (Lenat and Crawford, 1994). When water quality is measured from natural or nature-like watersheds where there is no or rare anthropogenic activity, the results are generally influenced either by geological structure and vegetation or their effects. For instance, the pH values of the water in river watersheds, which is composed of coniferous trees, are high because those trees' resin, tannin, etc. substances are washed or dissolved into the water. In the subject of this study, the watershed of Oltu stream, especially in the tributaries of the stream are included mature *Pinus sylvestris* L. stands. It has been observed that the land where *Pinus sylvestris* L. trees are located, the pH is much higher compared to other parts (Bergkvist and Folkesson, 1995). Accordingly, the soil acidity is observed to increase. In a study conducted in the same way, even though *Pinus sylvestris* L. stands increase the nitrogen portion of the soil, it is seen to have a diminishing influence on phosphorous (P), potassium (P), and calcium (Ca) concentrations (Prietz et al., 2008). Oltu watershed has alkaline bedrock which is easily dissolved and is composed of limey groundling sandy and pebbly soil (Atalay, 1982). In this kind of soils, the rain water is easily mixed with subsurface water as infiltrate and feed the river or the stream. Accordingly, the



stream's qualitative features are influenced by the physicochemical features of the vegetation and the soil because of dilution effect (Bis et al., 2000).

In order to identify the physicochemical features of Oltu stream which is the subject of the study, some research has been done in the past (Yıldırım, A., 1997; Yıldırım et al. 1999). However, none of these studies are done for the purpose of finding the physicochemical indicator parameter or parameters of the water.

### **Material and Methods**

The research area has been conducted in some different sample points on Oltu stream which is on the borders of Oltu town in the city Erzurum. The sample points are operated by State Hydraulic Works. The subject data set of the study is composed of monthly data and this data set contains 2003-2008 years. The area of Oltu watershed is 3605.3 km<sup>2</sup>. Dominating tree species in the region is *Pinus sylvestris* L. for many years, the semi-precious mineral known as Oltu Stone, which is formed by fossilization of *Pinus sylvestris* L. and other tree species, has been one of the sources of living. The regional soils are intrazonal soils with C horizon in which parent material easily dissolves and there cannot generally be covered to surface by soil (Atalay, 1982). The very alkaline soil material has appeared to the soil surface because of the erosion which is created by deterioration of the mature *Pinus sylvestris* L. in some parts of the forest and the area has high slope (Atalay et al., 1985).

### **Results and Discussion**

The twelve streamwater quality parameters and runoff were used to evaluate the average monthly values of three different station and standard deviations in Oltu stream (Table 1).

The Table 1 was shown that the large differences were not generally showed during the twelve months, although the averages of WT and EC have a big difference according the monthly average values. The average runoff values have increased in the March and April, although the concentrations of chemical parameters have decreased in these months.

The decreases of chemical parameters may be exhibited dilution effect in streamwater. The maximum dilution effect was shown in sodium concentration. Increasing the flow especially in the months of March and April was shown to effect of snowmelt-dominated stream. Despite large differences in runoff regimes in monthly trends, pH had not affected this runoff behavior.

Table 1. Average monthly values and standard deviations of some physicochemical parameters and runoff in the 5 year period between 2003 and 2008 in Oltu stream

Months	Q (m <sup>3</sup> /sn)	WT (°C)	pH	EC (uS/cm)	Na <sup>+</sup> (meq/l)	K <sup>+</sup> (meq/l)	Ca <sup>2+</sup> +Mg <sup>2+</sup> (meq/l)	CO <sub>3</sub> <sup>2-</sup> (meq/l)	HCO <sub>3</sub> <sup>-</sup> (meq/l)	Cl <sup>-</sup> (meq/l)	SO <sub>4</sub> <sup>2-</sup> (meq/l)	SAR	B (mg/l)
Jan	9.01 ±4.79	2.50 ±2.18	8.46 ±0.22	805.58 ±115.64	3.22 ±1.45	0.03 ±0.02	4.86 ±0.68	0.44 ±0.23	3.60 ±0.76	1.67 ±0.52	2.40 ±1.21	2.08 ±0.93	0.82 ±0.22
Feb	11.25 ±9.29	3.75 ±2.65	8.51 ±0.10	751.83 ±158.55	3.09 ±1.53	0.03 ±0.02	4.36 ±0.64	0.42 ±0.12	3.12 ±0.53	1.61 ±0.59	2.34 ±1.26	2.05 ±0.93	0.80 ±0.27
Mar	25.76 ±33.26	6.58 ±2.75	8.45 ±0.17	680.33 ±186.85	2.47 ±1.29	0.03 ±0.02	4.28 ±0.96	0.40 ±0.19	3.15 ±0.89	1.31 ±0.63	1.91 ±0.99	1.67 ±0.78	0.63 ±0.27
Apr	66.68 ±50.69	7.58 ±1.61	8.35 ±0.18	427.42 ±153.01	1.10 ±0.58	0.02 ±0.02	3.13 ±0.97	0.27 ±0.14	2.47 ±0.80	0.56 ±0.31	0.95 ±0.99	0.86 ±0.38	0.35 ±0.26
May	67.23 ±43.52	11.75 ±2.98	8.28 ±0.14	395.08 ±85.68	1.24 ±0.63	0.01 ±0.01	2.85 ±0.51	0.29 ±0.17	2.37 ±0.39	0.57 ±0.25	0.87 ±0.47	1.02 ±0.49	0.27 ±0.18
Jun	23.11 ±18.11	13.17 ±3.72	8.34 ±0.12	627.08 ±246.55	2.78 ±2.04	0.01 ±0.01	3.90 ±1.08	0.40 ±0.19	2.93 ±0.86	1.30 ±0.86	2.08 ±1.64	1.90 ±1.16	0.50 ±0.39
Jul	11.42± 10.48	18.08 ±4.33	8.38 ±0.12	778.42 ±279.46	3.71 ±2.16	0.03 ±0.02	4.69 ±1.21	0.42 ±0.14	3.35 ±0.91	1.53 ±0.82	3.12 ±1.77	2.30 ±1.12	0.81 ±0.46
Aug	8.61 ±6.53	17.67 ±3.73	8.38 ±0.15	788.10 ±323.95	3.78 ±1.72	0.04 ±0.03	5.49 ±2.16	0.48 ±0.28	3.20 ±0.70	1.66 ±0.66	3.98 ±2.29	2.36 ±1.06	0.87 ±0.33
Sep	10.15 ±5.96	14.83 ±4.10	8.31 ±0.15	694.09 ±335.91	3.94 ±1.43	0.04 ±0.02	5.15 ±0.78	0.44 ±0.11	3.72 ±0.83	1.85 ±0.56	3.12 ±1.19	2.45 ±0.86	0.96 ±0.25
Oct	10.90 ±7.08	10.92 ±3.04	8.33 ±0.11	824.42 ±155.54	3.58 ±1.44	0.04 ±0.03	4.95 ±0.87	0.39 ±0.13	3.66 ±0.66	1.71 ±0.52	2.82 ±1.30	2.25 ±0.79	0.86 ±0.22
Now	12.97 ±7.69	5.83 ±2.94	8.31 ±0.11	767.33 ±154.46	2.82 ±1.17	0.05 ±0.03	4.84 ±1.00	0.42 ±0.14	3.51 ±0.92	1.45 ±0.42	2.34 ±1.33	1.82 ±0.73	0.74 ±0.24
Dec	10.83 ±6.88	3.75 ±1.69	8.28 ±0.15	836.58 ±126.98	3.13 ±1.33	0.04 ±0.02	5.39 ±0.63	0.39 ±0.18	4.11 ±0.63	1.64 ±0.50	2.42 ±1.14	1.89 ±0.78	0.82 ±0.28

Table 2. Correlation matrix of the 13 physico-chemical variables

	Q	°C	pH	EC	Na <sup>+</sup>	K <sup>+</sup>	Ca <sup>2+</sup> +Mg <sup>2+</sup>	CO <sub>3</sub> <sup>2-</sup>	HCO <sub>3</sub> <sup>-</sup>	Cl <sup>-</sup>	SO <sub>4</sub> <sup>2-</sup>	SAR	B
Q	1												
°C	-0.15	1											
pH	-0.18	-0.23	1										
EC	<b>-0.79</b>	0.06	0.23	1									
Na <sup>+</sup>	<b>-0.77</b>	0.43	0.05	0.85	1								
K <sup>+</sup>	<b>-0.55</b>	<b>0.17</b>	0.24	<b>0.62</b>	0.67	1							
Ca <sup>2+</sup> +Mg <sup>2+</sup>	<b>-0.76</b>	0.21	0.28	<b>0.87</b>	<b>0.76</b>	0.56	1						
CO <sub>3</sub> <sup>-</sup>	<b>-0.65</b>	0.24	0.26	<b>0.53</b>	<b>0.7</b>	0.54	0.36	1					
HCO <sub>3</sub> <sup>-</sup>	<b>-0.68</b>	-0.31	0.33	<b>0.81</b>	<b>0.67</b>	<b>0.44</b>	0.9	-0.09	1				
Cl <sup>-</sup>	<b>-0.82</b>	0.24	0.17	<b>0.89</b>	<b>0.94</b>	<b>0.66</b>	<b>0.84</b>	<b>0.68</b>	0.77	1			
SO <sub>4</sub> <sup>2-</sup>	<b>-0.7</b>	<b>0.52</b>	-0.14	<b>0.79</b>	<b>0.92</b>	<b>0.65</b>	<b>0.82</b>	<b>0.56</b>	<b>0.52</b>	0.83	1		
SAR	<b>-0.75</b>	<b>0.44</b>	-0.11	<b>0.8</b>	<b>0.99</b>	<b>0.68</b>	<b>0.65</b>	<b>0.73</b>	<b>0.55</b>	<b>0.91</b>	0.89	1	
B	<b>-0.82</b>	0.28	0	<b>0.89</b>	<b>0.93</b>	<b>0.65</b>	<b>0.84</b>	<b>0.69</b>	<b>0.75</b>	<b>0.96</b>	<b>0.86</b>	0.9	1

In bold, significant values (except diagonal) at the level of significance alpha=0,050 (two-tailed test)

The correlation matrix of variables was produced by Pearson Correlation Analysis (Table 2). The correlation coefficients were calculated by among the water quality parameters that affected by temporal variations. In addition to this, the coefficient should be explained the relationship statistically significant and negative correlations can be calculated between pH,  $\text{Ca}^{2+}$ ,  $\text{Mg}^{2+}$ , EC,  $\text{Na}^+$ ,  $\text{K}^+$ ,  $\text{HCO}_3^-$ ,  $\text{Cl}^-$ ,  $\text{SO}_4^{2-}$ , SAR and B ( $r = 0.55$  to  $0.82$ ).

### Conclusions

The physicochemical characterization of Oltu stream might be strongly influenced by the soil-water interaction. Besides, the dilution effect was shown in Oltu stream which has characterized snowmelt-dominated stream (Table 1). Physical parameters (EC, WT and pH) has not influenced to the dilution effect of runoff. McNeil et al. (2005) emphasized in their study that the chemistry limits of the waters might be changed the geologic condition of the region. Determining the average pH value of Oltu stream water which has calcareous soil composed of alkaline bedrock as 8.5 constitutes the simplest example of this influence. Anderson et al. (1993) revealed in their study that when an acidic characteristics stream meets with a shunt coming from a calcareous region. The water turns into alkali character. The findings similar to our study have shown that bedrock may a very important factor on hydrochemical features of the watershed. But, it is also true that the stream turns into an acidic structure when coniferous trees, resin, tannin etc. are dominant in a region because they hold acidic matters on themselves (Wiklander et al. 1991). However, the findings of this study were observed to be similar with the findings of Anderson et al. (1993). Oltu stream which has a slightly acidic structure because of mature *Pinus sylvestris* L. located especially on upper zones of its watershed. In fact, the stream has an alkaline structure because of its dominant geologic conditions of watershed.

### References

- Atalay İ. (1982). The physical geography and the management of Oltu stream watershed. Ege University. Faculty of Social Science. İzmir.
- Atalay İ., Tetik M., Yilmaz Ö. (1985). The ecosystems of North-Eastern Anatolia. Aegean Geographical Journal, vol. 3, pp. 16-56.
- Anderson N.J., Rippey B., Gibson C.E. (1993). A comparison of sedimentary and diatom-inferred phosphorus profiles: implications for defining pre-disturbance nutrient conditions. Hydrobiologia, vol. 253, pp. 357-366.
- Bergkvist B., Folkesson L. (1995). The influence of tree species on acid deposition proton budgets and element fluxes in south Swedish forest ecosystems. Ecological Bulletin, vol. 44, pp. 90–99.
- Bis B., Zdanowicz A., Zalewski M. (2000). Effects of catchment properties on hydrochemistry. habitat complexity and invertebrate community structure in a lowland river. Hydrobiologia, vol. 422, pp. 369-387.
- Lenat D.R., Crawford J.K. (1994). Effects of land-use on water-quality and aquatic biota of 3 North-Carolina Piedmont Streams. Hydrobiologia, vol 294, pp. 185-199.
- McNeil V.H., Cox M.E., Preda M. (2005). Assessment of chemical water types and their spatial variation using multi-stage cluster analysis. Queensland. Australia. Journal of Hydrology, vol. 310, pp. 181-200.
- Prietzl J., Rehfuess K.E., Stetter U., Pretzsch H. (2008). Changes of soil chemistry. stand nutrition. and stand growth at two Scots pine (*Pinus sylvestris* L.) sites in Central Europe during 40 years after fertilization. liming. and lupine introduction. European Journal of Forest Research, vol. 127, pp. 43–61.

- Yıldırım A. (1997). Oltu Çayı (Çoruh Nehri)'nin bazı parametrelerindeki yıllık deęişimler ve bu suda yaşayan *Capoeta tinca* (Heckel. 1843) (*Pisces-Siraz balığı*)'nin biyo-ekolojisi ile et analizleri üzerine arařtırmalar. Doktora Tezi. Atatürk Üniv. Fen Bil. Ens.107 s. Erzurum.
- Yıldırım A., Erdoğan O., Türkmen M., Demir B.C. (1999). Çoruh Havzası-Oltu Çayı'nda yaşayan *Alburnoides bipunctatus fasciatis* (Nordmann. 1840)'in bazı üreme özelliklerinin arařtırılması. *Turkish Journal of Veterinary and Animal Sciences*. vol. 23, pp. 679-686.

## SELECTION OF ALMOND (*Prunus amygdalus* L.) GENOTYPES GROWING IN THE FOREST AREA OF HILVAN (SANLIURFA) DISTRICT, TURKEY

Mikdat ŞİMŞEK\*

Department of Horticulture, Faculty of Agriculture, Dicle University, Diyarbakir, Turkey

\*Corresponding author: mikdat.simsek@dicle.edu.tr

### Abstract

Turkey has a wide genetic variation for almond species (*Prunus amygdalus* L.) in some of its regions due to open pollination (heterozygous) conditions and seed propagation since thousands of years. This study was conducted to almond genotypes grown in forest area of Hilvan district of Şanlıurfa province of Turkey between the years of 2011-2012. Because no studies have been made on almond genotypes in forest area of Hilvan (Sanliurfa) district by researchers up to now, the research in this natural habitat has a special importance with respect to promising almond genotypes. Therefore, the aim of the study was to select superior genotypes from native almonds populations grown from seed in this area. At the beginning of the study, 152 genotypes were sampled from native populations according to some selection criterias. At the end of the study, 9 promising genotypes were selected using standard selection criterias for almonds. The first, full and last flowering dates of the almond genotypes were recorded as 9-10 March, 14-15 March and 19-20 March, respectively. The latest flowering date was observed in 63-HVO-32 numbered genotype. In the study, fruit weight with shell, kernel weight and shell thicknes of the promising genotypes were ranged from 2.29 (63-HVO-32) – 6.31 (63-HVO-25) g, 0.53 (63-HVO-65 and 63-HVO-103) - 1.04 (63-HVO-18) g and 2.63 (63-HVO-103) – 4.36 mm (63-HVO-25), respectively. In addition, double kernel and twin kernel ratios of the promising genotypes were determined as 0.00% in all surveyed genotypes.

**Keywords:** *Almond, Selection, Şanlıurfa, Turkey.*

### Introduction

Almond (*Prunus amygdalus* L.) is one of the most important and the largest productions of nuts in the world (Kester and Gradziel, 1991; Simsek and Kizmaz, 2017). In addition, it is one of the oldest crops used by humans but its enviromental requirements have restricted its commercial production to specific areas of the world (Kester and Asay, 1979; Simsek *et al.*, 2010). Turkey is one of the significant countries in the world in terms of almond production. Almond is grown in a lot of areas of Turkey (Dokuzoguz *et al.*, 1968; Gulcan *et al.*, 1989; Karadeniz and Erman, 1996; Aglar, 2005; Simsek and Kuden, 2007; Yildirim 2007; Simsek *et al.*, 2009; Sumbul, 2009; Simsek *et al.*, 2010; Simsek and Yilmaz, 2010; Simsek 2011; Kose, 2013; Gulsoy and Balta, 2014). Turkey ranks sixth in the world, producing 73.230 tons of almond (FAO, 2014).

Almond spesies is one of the most investigated fruit species in selection studies in Turkey. The richness of Turkey on genetic variation of this species has provided facility for achievement in breeding studies in a short period of time. Because almond tree is cultivated in many regions of Turkey, it is very important to develop varieties suitable to a certain area. Therefore, several superior almond genotypes such as Gülcan I and Dokuzoğuz-II were

obtained during the selection studies performed in different areas of our country and were registered as cultivars (Gülsoy *et al.*, 2016; Anonim, 2017).

With hard climatic conditions, Southeast Anatolia Region of Turkey has mostly seedling almond genotypes and cultivars. Most of the almond trees grown in the region were grown with seed and generally grown in sides of fields and polyculture with the fruit species such as pistachio, olive, figs, walnut and some other fruit species (Simsek and Demirkiran, 2010). Monoculture almond orchards have been established for 15-20 years.

Existing almond types and cultivars differ widely from each other in many characteristics, especially flowering time, yield, quality of nuts and tree vigour. This variability has provided an invaluable material for almond selection. Many researchers have executed almond selection studies in most parts of Turkey (Dokuzoguz and Gulcan, 1979; Cangi and Sen, 1991; Simsek, 1996; Gercekcioglu and Gunes, 1999; Simsek and Kuden, 2007; Simsek, 2008; Simsek *et al.*, 2010; Simsek and Yilmaz, 2010; Simsek 2011). However, the forest area of Hilvan (Şanlıurfa) district of Southeast Anatolia Region is an exception. There was no selection study executed in this site, which makes the present study is original. Late flowering, high yield and quality-almond genotypes were selected in this research. In followup studies, these genotypes should be tested regarding adaptability in the same ecological conditions with standard almond cultivars in order to obtain the best almond genotypes and cultivars to contribute to the national economy.

### **Materials and methods**

This study was conducted in forest area of Hilvan district of Şanlıurfa province in Southeast Anatolia Region of Turkey between the years of 2011-2012. Selected almond genotypes was compared according to weighted-ranked method to Gulcan *et al.* (1989), Gulcan (1985), Gulcan *et al.* (1989), Simsek *et al.* (2010), Simsek and Yilmaz (2010), and Simsek (2011). In this context, firstly, natural almond populations of forest area of Hilvan district were surveyed and 152 genotypes which had late flowering according to the other almond genotypes were labelled and evaluated for breeding objectives. Later, 30 fruits were randomly taken from each of the almond trees in summer season. In the second year, late flowering 90 out of 152 previously selected almond genotypes and 30 fruits were randomly taken again from each of the almond trees in summer season. Finally, 9 promising genotypes were selected according to this method. Flowering and pomological characteristics of the selected almond genotypes were made according to Godini *et al.* (1977), Gulcan *et al.* (1989), Simsek *et al.* (2010), Simsek and Yilmaz (2010), Simsek (2011) and Gulcan (1985), respectively. Altitudes and coordinates were measured with GPS tool. The beginning of flowering in various almond genotypes delay one day at each 35 m in altitude (Ozbek, 1977; Gulcan *et al.*, 1989; Simsek *et al.*, 2010; Simsek and Yilmaz 2010; Simsek 2011). The fruit weight with shell and kernel weight were measured with a scale sensitive to 0.01 g. In addition, the fruit length with shell, fruit width with shell, kernel length and kernel width were measured with a digital compass (Gulcan *et al.*, 1989; Simsek *et al.*, 2010; Simsek and Yilmaz, 2010; Simsek, 2011).

### **Results and discussion**

Almond is the earliest flowering species among the temperate climate fruits. For this reason, this species can be affected by late spring frosts. First flowering dates started between 09 March in 7 genotypes (63-HVO-7, 63-HVO-18, 63-HVO-65, 63-HVO-74, 63-HVO-75, 63-HVO-103 and 63-HVO-150)-10 March in 2 genotypes (63-HVO-25 and 63-HVO-32) (Table 1). Full flowering dates started between 14 March in 5 genotypes (63-HVO-7, 63-HVO-18, 63-HVO-65, 63-HVO-74, 63-HVO-75 and 63-HVO-103)-15 March in 3 genotypes (63-HVO-

25, 63-HVO-32 and 63-HVO-150) (Table 1). Last flowering dates started between 19 March in 8 genotypes (63-HVO-7, 63-HVO-18, 63-HVO-25, 63-HVO-65, 63-HVO-74, 63-HVO-75, 63-HVO-103 and 63-HVO-150)-20 March in 1 genotypes (63-HVO-32) (Table 1). It was determined that flowering period of the selected almond genotypes lasted to be 11-12 days. Kuden *et al.* (2001) determined that flowering occurred to be 25th February - 26th March in 1999 and 10th March -24th March in 2000. Simsek (2011) observed as from 1 March to 11-12 March for flowering dates of the promising almond genotypes in Cinar District of Diyarbakir province. Simsek and Osmanoglu (2010) observed as from 26 february-2 March of first flowering, 2-7 March of full flowering and 7-10 March of last flowering of superior almond genotypes in Derik (Mardin) district. Simsek *et al.* (2010) observed as from 8-15 March of first flowering, 12-19 March of full flowering and 15-24 March of last flowering of superior almond genotypes in Kocaköy and Hani Counties of Diyarbakir province.

One of the most important selection criteria were the date of full flowering (Gulcan, 1985; Gulcan *et al.*, 1989; Simsek, 1996; Balta, 2002; Simsek, 2008). The flowering dates of almond genotypes and cultivars can vary with the environmental conditions, horticultural practices and genetic characteristics. Choosing late-flowering, high fruit quality and high yielding almond genotypes is a major commercial advantage.

In this study, it was determined that the tree habit of promising almond genotypes changed as spreading of 6 genotypes and upright as 3 genotypes (Table 1). Simsek and Yilmaz (2010) observed as dropping and spreading of the tree habit of almond genotypes in Silvan district of Diyarbakir province.

It was determined that the fruit weight with shell, kernel weight, shell thicknes and kernel ratio of promisin almond genotypes ranged from 2.29 (63-HVO-32)–6.31 (63-HVO-25) g, 0.53 (63-HVO-65 and 63-HVO-103)-1.04 (63-HVO-18) g, 2.63 (63-HVO-103)–4.36 mm (63-HVO-25) and 15.86 (63-HVO-25)-23.41 (63-HVO-32), respectively (Table 1). In addition, it was determined that the suture opening of the shell, kernel taste, percentage of double kernels, percentage of twin kernel and yield of all of proising almond genotypes ranged from 0.00 mm, sweet, 0.00%, 0.00% and intermediate, respectively (Table 1). Simsek and Yilmaz (2010) determined that kernel ratio, the fruit weight and the kernel weight of the selected genotypes were determined and changed from 18.76 to 4.00%, from 2.99 to 4.53 g and from 0.61 to 1.18, respectively. Double kernel ratio and twin kernel ratio weren't found in the selected genotypes. Simsek *et al.* (2010) determined that the fruit weight with shell, kernel weight, kernel ratio, double kernel ratio and twin kernel ratio of almond genotypes in Kocaköy and Hani districts ranged from 1.15 to 2.14 g, 0.69 to 1.25g, 37.43 to 62.81%, 0.00%, 0.00% and 100%, respectively. In some other studies, fruit weight with shell changed from 3.45 to 5.86 g (Bostan *et al.*, 1995), 2.18 to 7.58 g (Gercekcioglu and Gunes, 1999), 3.39 to 7.58 g (Simsek, 1996), 1.21 to 2.75g (Simsek and Kuden, 2007) and 1.42 to 4.93 g (Simsek, 2008). Karadeniz and Erman (1996), Simsek and Kuden (2007) and Simsek (2008) determined that the kernel weight of the selected genotypes changed from 1.01 to 1.80 g, 0.51 to 1.52 g and 0.66 to 1.14 g, respectively. Simsek and Kuden (2007), and Simsek (2008) determined that kernel ratio changed from 25.39 to 62.41 % and 13.91 to 60.16%, respectively. Simsek and Kuden (2007) and Simsek (2008) determined that the double kernel ratio changed from 0.00 to 28.00%, and 0.00%, respectively. Desirably, double kernel ratio should not exceed 5% (Ozbek, 1978; Simsek *et al.*, 2010).

The values obtained on tree and fruit characteristics in this study were in agreement with the values reported in some similar studies (Simsek and Yilmaz, 2010; Simsek *et al.*, 2010). Although the yield is an inherited property, it can change according to pollination, maintenance requirements and ecological conditions of almond genotypes and cultivars.

**Table 1.** Some properties of the selected almond genotypes.

<b>Characteristics</b>	<b>63-HVO-7</b>	<b>63-HVO-18</b>	<b>63-HVO-25</b>
Date of first flowering	9 March	9 March	10 March
Date of full flowering	14 March	14 March	15 March
Date of Last flowering	19 March	19 March	19 March
Tree habit	Spreading	Spreading	Spreading
Yield	Intermediate	Intermediate	Intermediate
Fruit weight with shell (g)	2.99	5.75	6.31
Suture opening of the shell (mm)	0.00	0.00	0.00
Kernel Taste	Sweet	Sweet	Sweet
Percentage of double kernels (%)	0.00	0.00	0.00
Percentage of twin kernel (%)	0.00	0.00	0.00
Kernel weight (g)	0.62	1.04	1.00
Shell thicknes (mm)	2.95	3.55	4.36
Kernel ratio (%)	20.73	18.00	15.86

**Table 1 (Cont'd).**

<b>Characteristics</b>	<b>63-HVO-32</b>	<b>63-HVO-65</b>	<b>63-HVO-74</b>
Date of first flowering	9 March	9 March	9 March
Date of full flowering	15 March	14 March	14 March
Date of Last flowering	20 March	19 March	19 March
Tree habit	Upright	Spreading	Upright
Yield	Intermediate	Intermediate	Intermediate
Fruit weight with shell (g)	2.29	2.59	3.61
Suture opening of the shell (mm)	0.00	0.00	0.00
Kernel Taste	Sweet	Sweet	Sweet
Percentage of double kernels (%)	0.00	0.00	0.00
Percentage of twin kernel (%)	0.00	0.00	0.00
Kernel weight (g)	0.54	0.53	0.76
Shell thicknes (mm)	2.88	2.92	3.36
Kernel ratio (%)	23.41	20.30	20.94

**Table 1 (Cont'd).**

<b>Characteristics</b>	<b>63-HVO-75</b>	<b>63-HVO-103</b>	<b>63-HVO-150</b>
Date of first flowering	9 March	9 March	9 March
Date of full flowering	14 March	14 March	15 March
Date of Last flowering	19 March	19 March	19 March
Tree habit	Spreading	Spreading	Upright
Yield	Intermediate	Intermediate	Intermediate
Fruit weight with shell (g)	2.55	2.71	3.19
Suture opening of the shell (mm)	0.00	0.00	0.00
Kernel Taste	Sweet	Sweet	Sweet
Percentage of double kernels (%)	0.00	0.00	0.00
Percentage of twin kernel (%)	0.00	0.00	0.00
Kernel weight (g)	0.54	0.53	0.59
Shell thicknes (mm)	2.80	2.63	2.59
Kernel ratio (%)	21.17	19.59	18.33

### Conclusion

In general, the difference between the flowering periods of almond genotypes and cultivars can change according to altitude, ecological conditions and genetic characteristics. The



selected almond genotypes in forest area of Hilvan (District) of Sanliurfa province were seen in their outcome in most characteristics. Selected genotypes in this study should be tested in the same ecological conditions with standard almond cultivars to bring them into the commercial almond production. It can be concluded that selected almond genotypes have a great potential of high yielding, high quality and late flowering new cultivars to be registered after follow up adaptation studies.

### Rererences

- Aglar, E. (2005). Selection on almond (*Prunus amygdalus* L.) in Pertek (Tunceli) District. YYU Science Institute (MsC Thesis), Van, Turkey.
- Anonim (2017). <http://www.bahcesel.net/forumsel/badem-yetistiriciligi/22025-badem-cesitleri/> (Accessed: 02/04/2017).
- Balta, MF. (2002). Research on selection of almonds (*Prunus amygdalus* L.) in Elazığ Central and Ağın Districts. YYU Science Institute (PhD Thesis), Van, Turkey.
- Bostan, SZ., Cangi, R., Oguz HI. (1995). Studies on breeding by selection almond (*Prunus amygdalus* L.) in Akdamar Island. II. National Horticulture Congress, Cilt. 1: 370-374, Adana.
- Cangi, R., Sen, SM. (1991). Studies on breeding by selection almond grown in Vezirköprü and the surrounding. YYU, Journal of Agricultural Faculty, 1(3): 131-152.
- Dokuzoguz, M., Gulcan, R. (1979). Almond growing and problems. TUBITAK, TOAG Publications Number: 22, Ankara, 28 p.
- Dokuzoguz, M., Gulcan, R., Atilla, A. (1968). Studies on selection correction of almond in Aegean Region. EU Agricultural Faculty's Publication Number: 148, Bornova-Izmir, 39 p.
- FAO, (2014). Food And Agriculture Organization of The United Nations Statistics Division: <http://faostat3.fao.org/download/Q/QC/E>. (Accessed: 12/04/2017).
- Gercekcioğlu R., Gunes, M. (1999). A research on improvement of Almond (*Prunus amygdalus* L.) by selection of wild plants grown in Tokat central district. XI. Grempe Meeting on Pistacio and Almonds. Harran University, Faculty of Agriculture – Pistacio Research and Application Center, 1-4 September, Sanliurfa, Turkey.
- Godini, A., Ferrara, E., Reina, A. (1977). Contributa alla conescenza delecultivar di Mondorla (*Prunus amygdalus* B.) della Puglia. 1. II Calandorio dele fioriture. Annali della Facolta di Agraria; Universite di Bari, 29: 611-620.
- Gulcan, R. (1985). Descriptor list for Almond (*Prunus amygdalus* L.). International Board for Plant Genetics Resources (IBPGR):30 p.
- Gulcan, R., Dokuzoguz, M., Askin, A., Misirli, A. (1989). Evaluation of selected almond clones. In; Third Workshop on Clonal Selection in Tree Fruit, Czechoslovak Scientific and Technical Soc. Agr., Soc. House of Technology of the Csvts, 5-8 Semptember 1989, Brno-Czechoslovakia.
- Gulsoy, E., Balta, F. (2014). Selection almond (*Prunus amygdalus* Batch) in Yenipazar, Bozdogan and Karacasu (Aydın): Pomological characteristics. Journal of Academic Agriculture 3 (2): 61-68.
- Gulsoy, E., Erturk, YE., Simsek, M. (2016). Local Almond (*Prunus amygdalus* L.) Selections in Turkey. YYU J AGR SCI, 26 (1): 126-134.
- Karadeniz, T., Erman, P. (1996). Selection of almond (*Amygdalus communis* L.) grown in Siirt. Symposium of hazelnut and other nuts. OMU Agricultural Faculty, 10-11 January, 199, Samsun. pp. 324-331.
- Kester, DE., Asay, R. (1979). Almonds. In. Advances in Fruit Breeding, Janick, J. and Moore, J.N. (eds). Purdue University Press, Westlafayette, IM. pp. 387-418.

- Kester, DE., Gradziel, C. (1991). Almonds (*Prunus*). Genetic Resources of Temperate Fruit and Nut Crops (Eds. JN Moore and JR Ballington), The International Society for Horticultural Science, pp. 701-758.
- Kose, M. (2013). Breeding by selection and determination of genetic diversity by RAPD method of almond (*Amygdalus communis* L.) types grown Ispir district of Erzurum province (Phd Thesis). ATU Science Institute, Erzurum-Turkey.
- Kuden, AB., Kuden, A., Tanriver, E., Siris, O., İkinci, A. (2001). Integrated project of temperate climate fruits in Southeastern Anatolia Region integrated Project. TUBITAK's result report, Number: 317, Adana, 53 p..
- Ozbek, S. (1977). General orcharding. CU Agricultural Faculty's publication, Number: 111, Adana, 386 p..
- Ozbek, S. (1978). Special orcharding. CU Agricultural Faculty's publication, Number: 128, Textbook: 11, Adana, 485 p.
- Simsek, M., Kuden, AB. (2007). A selection studies on almonds (*Prunus amygdalus* L.) grown natively in Bahcecik villag of Hilvan district of Sanliurfa province. CU, Journal of Agricultural Faculty, 22 (1): 125-132.
- Simsek, M. (2008). Selection of almonds (*Prunus amygdalus* L.) grown in Hilvan District and the bound villages. Harran U. Journal of Agricultural Faculty, 12 (49): 33-39.
- Simsek, M., Demirkiran, AR. 2010. Determination of Superior Anmond Genotypes in Diyarbakir Central Districts. Agricultural Journal, 5 (3): 173-180.
- Simsek, M. (1996). A research on breeding by selection almond (*Prunus amygdalus* L.) in Kahramanmaras Central District. KSU Science Intitute (MsC Thesis), Kahramanamaaras, 95 p.
- Simsek, M., Osmanoglu, A., Tas, Z. (2009). Fruit performances of sweet almond (*Prunus amygdalus* L.) types selected in Cermik district. Harran U. Journal of Agricultural Faculty, 14 (2):29-37
- Simsek, M., Osmanoglu, A. (2010). Selection of Native Almonds (*Prunus amygdalus* L.) Growing in Derik (Mardin) District. (YYU Journal of Agricultural Faculty, 20 (3): 171-182.
- Simsek, M., Osmanoglu, A., Yildirim, H. (2010). Evaluation of Selected Almond Types in Kocaköy and Hani Counties. African Journal of Agricultural Research, 5 (17): 2370-2378.
- Simsek, M., Yilmaz, KU. (2010). Selection of Native Almonds (*Prunus amygdalus* L.) in Silvan District of Diyarbakır Province. Alatarım, 9 (1): 22-30.
- Simsek, M. (2011)- Almond Selection in Cinar District.Science J of Bingöl Univ. 1 (1): 32-36.
- Simsek, M., Kizmaz, V. (2017). Determination of Chemical and Mineral Compositions of Promising Almond (*Prunus amygdalus* L.) Genotypes from Beyazsu (Mardin) Region. International Journal of Agriculture and Wildlife Science (IJAWS), 3 (1): 6-11.
- Sumbul, A. (2009). Selection of almond (*Prunus dulcis* Mill) in Hatay province. MKU Science Institue (MsC Thesis), Hatay-Turkey
- Yildirim, AN. (2007). Selection on almond (*P. amygdalus* L.) in Isparta province. AMU Science Institute (PhD Thesis), Aydın-Turkey.

## **EVALUATION IN BIO-COMPOSITE FILM PRODUCTION OF SOME AGRICULTURAL PLANTS GROWING IN TURKEY**

Saim ATEŞ\*, Ekrem DURMAZ

Department of Forest Industrial Engineering, Kastamonu University, Turkey

\*Corresponding author: saimates@kastamonu.edu.tr

### **Abstract**

Plenty of and a large variety agricultural resources are grown in different regions of Turkey and abundant wastes emerge from these. Owing to their large amounts, storing or annihilating of them is not too easy. Nonetheless, these materials can be evaluated in a lot of purposes. One of these is bio-based composite films. It is known that the bio-composite films are more eco-friendly and biodegradable than the petroleum-based products. In production of bio-based composite materials, agricultural plant wastes have to be converted the nano/micro scale to disperse in the films homogeneously. According to sizes and obtaining methods, separated fibers are termed as microfibril (MF), microcrystallinecellulose (MCC), nanofibril (NF), nanocrystallinecellulose (NCC) or cellulose whiskers (CW) etc. in the literature. Micro/nano fibers have some advanced mechanical, physical and thermal properties. Therefore, the composite films produced with these materials can be preferred in industries like medical, electronic, coating etc. instead of plastic-based materials. In this study ten different agricultural wastes growing in Turkey were selected. Wheat straw, barley straw, rye straw, rice straw, sunflower stalk, cotton stalk, corn stalk, tobacco stalks, reed and hemp were collected from different regions and their anatomical, chemical and morphological properties were discussed for producing bio-composite film.

Consequently, while hemp fibers were the longest fiber length, cotton and tobacco fibers showed the shortest fiber length. Also the lowest lignin content and the highest cellulose ratio were found in hemp. Although all lignocellulosic materials can be used for nano/micro crystalline cellulose production, some of them need additional pretreatment processes.

**Keywords:** *Agricultural resources, nanofibril, bio-composite film*

### **Introduction**

In recent years, the production of durable and eco-friendly materials has attracted the attentions of researchers. Furthermore, it is expected that bio-based composite materials will eliminate various drawbacks of synthetic polymers like restricted fossil resources such as petroleum and this derivatives, a constantly fluctuating price scale and greenhouse gas emissions. Bio-based composites are preferred owing to its low cost, low density, high resistance properties, high electrical, mechanical and optical properties, low energy consumption, their eco-friendly, conformance to environmental conditions and ensuring environmental cycle in short time by disintegrating naturally. Owing to all these properties, bio-based composites can be used in different industries such as technology, communication, structure, material science, medical, military, production of aircraft and automobile, optic and magnetic zones (Jamshidian et al., 2010; Jose et al., 2012).

Researchers around the world have utilised various cellulosic raw materials for nanocellulose production. Because of wide availability and high cellulose content, wood was used, too, but the production nanocellulose from wood involves multi-stage treatment. In general, purified

wood or bleached kraft pulp is preferred to manufacture nanocellulose (Hubbe et al. 2008). Although wood is the most productive natural fiber resource for producing nanocellulose, recently due to excessive raw material necessity, researchers are considering usage of annual plants and agricultural residues. For nanocellulose manufacturing cotton, hemp, jut, sisal, corn stalk, flax, sugar cane bagasse, sugar beet pulp, wheat straw, soy hulls, potato root, coconut, mulberry, rutabaga, banana rachis and palm can be used (Hubbe et al. 2008; Peng et al. 2011). Although every year nearly 60 million ton agricultural residues emerge in Turkey, these residues can't evaluate effectively. They are either burned or binned. Part of these materials are utilized in production of animal feed. Usability ratios of some of the agricultural residues were given following: wheat straw, 3.514.486; corn stalk, 2.982.158; sunflower stalk, 1.355.472, cotton stalk, 1.512.169 and rice straw 125.719 ton (Acar et al. 2016). Agricultural residues can be converted to bio-based products such as biocomposite, biofibre, polyester, polyethylene, polystyrene, ketone, epoxide, acid, alcohol, polyamide with regard to different physical/mechanical, biological, chemical and thermochemical treatments (Alkaya et al. 2010)

Within the context of this study, morphological, chemical and anatomical characteristics of some annual plants and their residues growing in Turkey were investigated with regard to opportunities of bio-composite film production.

## **Materials and methods**

### **Materials**

Wheat straw, barley straw, rye straw, rice straw, sunflower stalk, cotton stalk, corn stalk, tobacco stalks, reed and hemp used as raw material were obtained from Konya, Adana, Samsun, Tekirdağ, Çorum, Afyon and Kastamonu in Turkey. All of the chemical materials and equipment in the analyses supplied from the laboratories of Department of Forest Industrial Engineering, Kastamonu University.

### **Methods**

For morphological characteristics, wheat straw, barley straw, rye straw, rice straw, sunflower stalk, cotton stalk, corn stalk, tobacco stalks and reed samples were prepared from their stems, whereas hemp samples were prepared from its steles. Schultze maceration process (1857) was performed to separate fibers of raw materials.

For anatomical characteristics, after the samples were boiled in water until they soften, the water in cell wall and lumen were removed by doing dehydration with alcohol and alcohol-xylene. Very thin samples were cut with a sliding microtome after dehydrated raw materials were embedded in the wax. Prepared anatomic samples were stained with safranin as well as these samples were immobilized with Canada balsam between lamina and cover glass. Then these slides were monitored with a light microscope by using in 10x16 magnifications and the images were achieved.

For chemical characteristics, all analyses of the samples were conducted according to TAPPI standards (Hafizoğlu and Deniz 2011). Before the chemical analyses, the samples were grinded in a Wiley Mill and they were prepared according to TAPPI T 257 cm-85 standard. All of the analyses were repeated three times to provide consistency.

## **Results and Discussions**

The morphological measurement results of wheat straw, barley straw, rye straw, rice straw, sunflower stalk, cotton stalk, corn stalk, tobacco stalk, reed and hemp fibers and some of the

studies in literature were indicated in Table 1. The fibrous and anatomical images of samples were obtained with Digimizer which is scanning software programmer and they were given in Figure 1, 2, 3, 4, 5, 6, 7, 8, 9 and 10. For hemp sample, anatomic cross section images couldn't be obtained because its stem comprises only fibers.

Table 1. Morphological properties of samples and comparing with literature (Ateş et al. 2011)

Raw material	Fibre length (mm)	Fibre width (µm)	Lumen width (µm)	Cell wall thickness (µm)	
Wheat straw	0,93	15,75	5,25	5,25	Measurement
Wheat straw	1,17	15,5	5,8	4,9	Reference
Barley straw	1,07	11,25	4,53	3,36	Measurement
Rye straw	1,14	15,56	6,25	4,66	Measurement
Rye straw	1,15	14,7	4,2	5,3	Reference
Rice straw	1,08	12,52	6,02	3,25	Measurement
Rice straw	0,89	14,80	6,40	4,20	Reference
Tobacco stalk	0,98	25,75	17,25	4,25	Measurement
Tobacco stalk	1,07	26,8	16,3	5,3	Reference
Cotton stalk	0,97	23,75	16,72	3,52	Measurement
Cotton stalk	0,81	24,98	16,75	4,12	Reference
Hemp	28,74	25,53	7,54	8,99	Measurement
Hemp	25,24	27,10	7,18	9,96	Reference
Reed	1,52	16,25	7,00	4,63	Measurement
Reed	0,95	14,3	6,4	4,0	Reference
Sunflower stalk	1,32	21,35	16,25	2,55	Measurement
Sunflower stalk	1,28	22,1	15,6	3,3	Reference
Corn stalk	1,23	19,25	9,25	5,02	Measurement
Corn stalk	1,32	24,3	10,7	6,08	Reference

When the fiber images of samples were looked, fragment fibers were noticed abundantly in wheat straw, rice straw, barley straw, tobacco stalk and sunflower stalk. As can be seen in Table 1, all measurements are almost coincide with literature.

According to Table 1, the highest fiber length was obtained in hemp samples with 28,74 mm. In terms of fiber widths, tobacco stalk (25,75 µm), hemp (25,53 µm), cotton stalk (23,75 µm) and sunflower stalk (21,35 µm) attracted the attention rather than the others. Likewise, lumen widths of tobacco stalk (17,25 µm), cotton stalk (16,72 µm) and sunflower stalk (16,25 µm) were higher than the other samples considerably as well as maximum cell wall thickness was found in hemp fibers with 8,99 µm. Due to high fibre length and high cell wall thickness, it can be thought that biocomposite films produced from hemp nanofibril will have higher tensile strength and Young's modulus (Wang and Sain 2007c; Cao et al. 2008). Likewise, because tobacco stalk, cotton stalk and sunflower stalk have higher lumen widths than the others, it is predicted that mechanical and barrier properties of biocomposite films produced from these kind of samples' nanofibril will be lower than the others. Nonetheless, it can be seen that annual plants and agricultural residues are appropriate to production of bio-based composite films when the studies in literature are investigated (Oun and Rhim 2016; Smyth et al. 2017; Zhang et al. 2017).

When anatomical images of samples were investigated, epidermis, collencyhma cells, sclerencyma cells, tracheid, vessel, xylem, phloem, cortex, parenchyma and cambium were clearly seemed in cross sections of the samples in Figure 1, 2, 3, 4, 5, 6, 7, 8, 9 and 10.

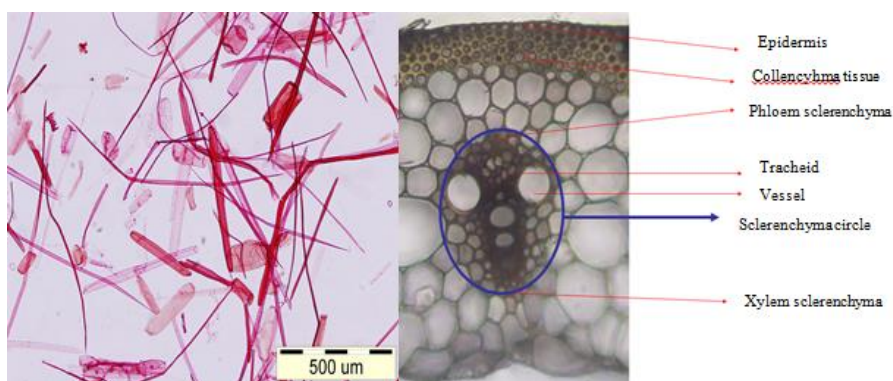


Figure 1. The microscopic images of fibre and stem cross section of wheat straw

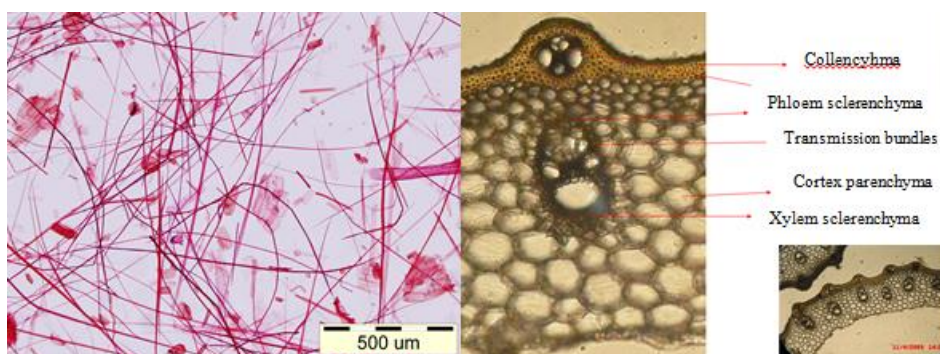


Figure 2. The microscopic images of fibre and stem cross section of rice straw

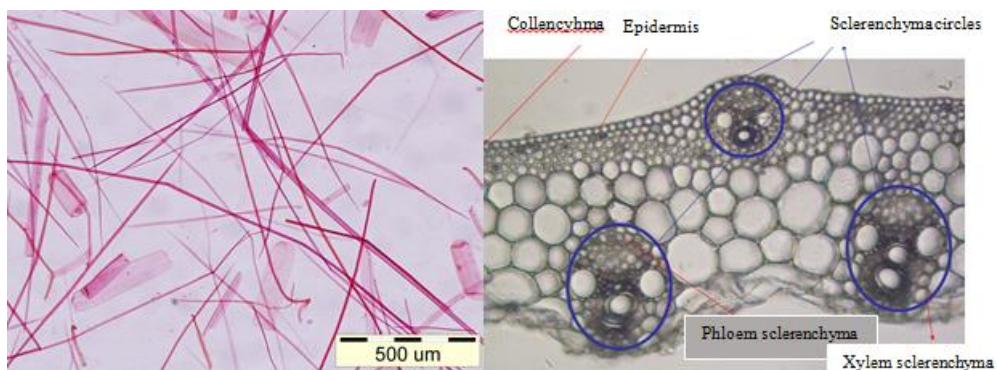


Figure 3. The microscopic images of fibre and stem cross section of rye straw

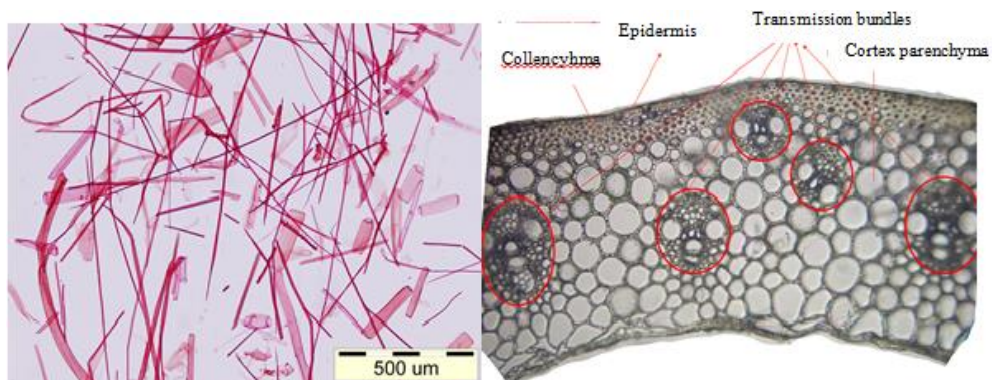


Figure 4. The microscopic images of fibre and stem cross section of barley straw

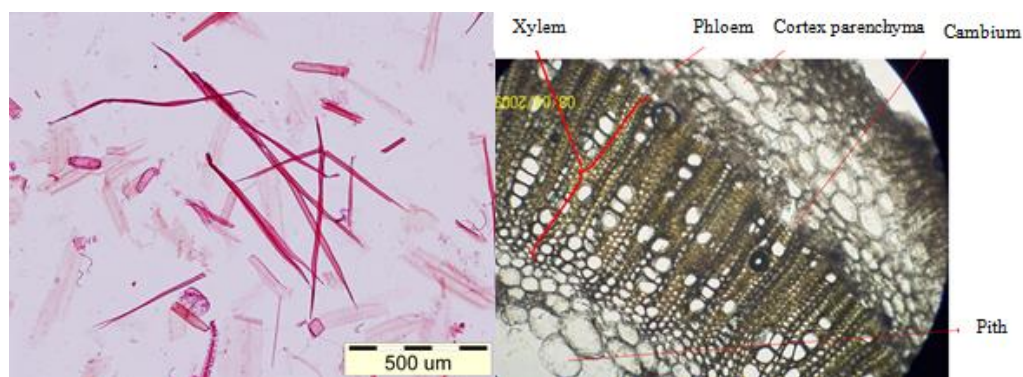


Figure 5. The microscopic images of fibre and stem cross section of tobacco stalk

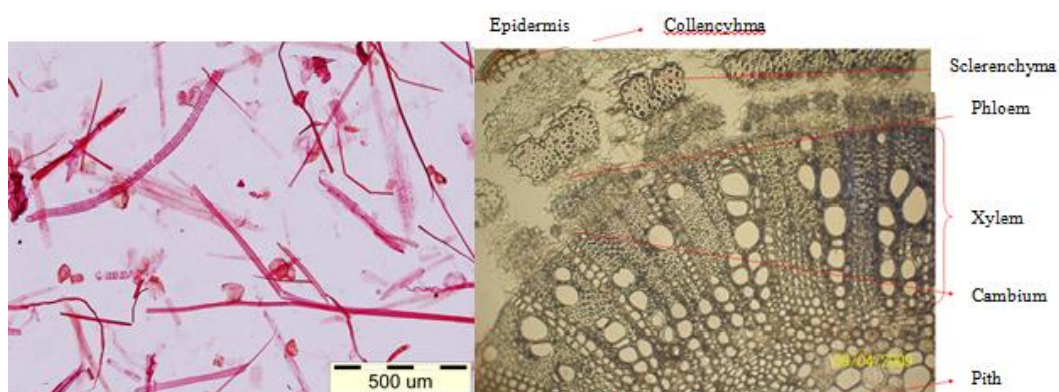


Figure 6. The microscopic images of fibre and stem cross section of cotton stalk

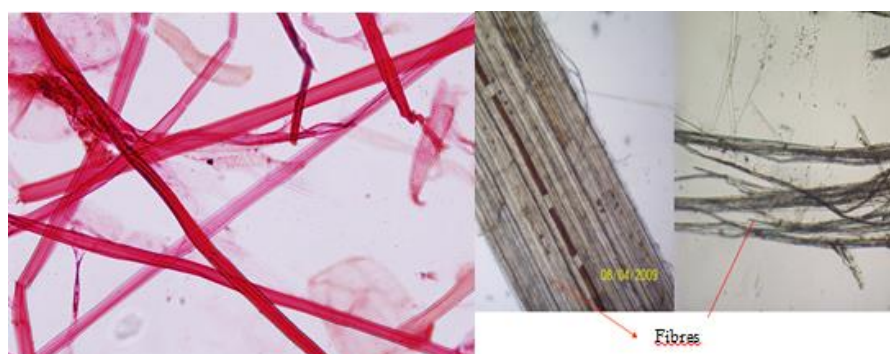


Figure 7. The microscopic images of fibre and stem cross section of hemp

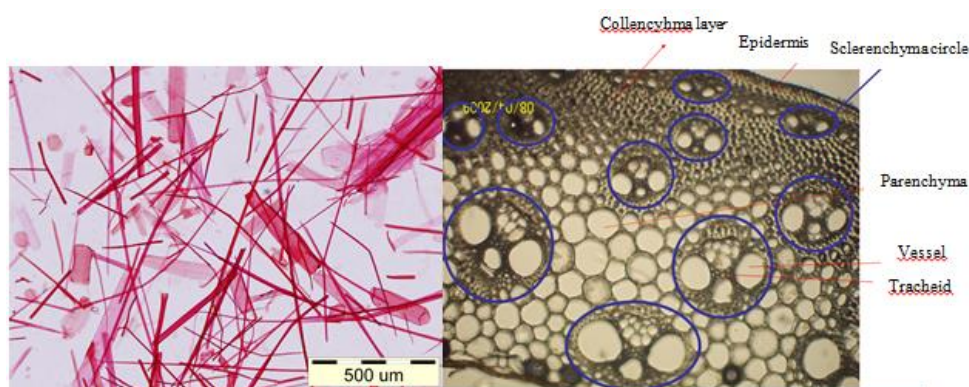


Figure 8. The microscopic images of fibre and stem cross section of reed

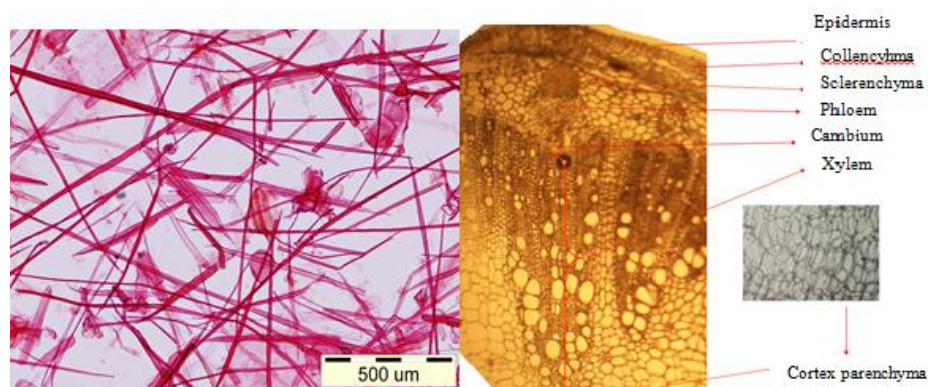


Figure 9. The microscopic images of fibre and stem cross section of sunflower stalk

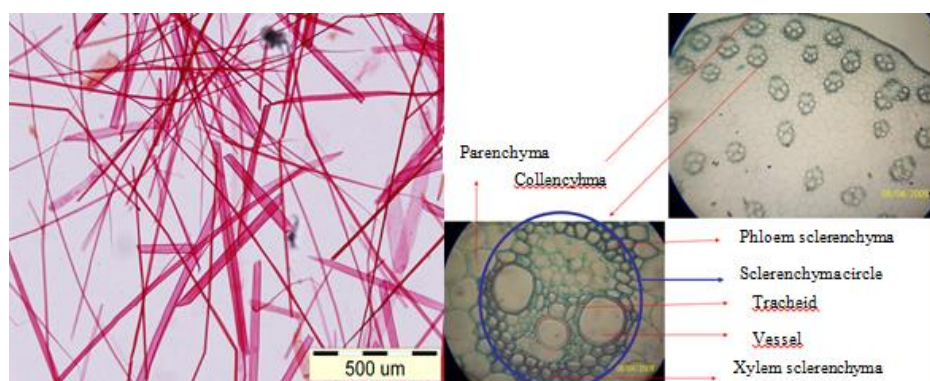


Figure 10. The microscopic images of fibre and stem cross section of corn stalk

According to anatomical images, uniserial epidermis layer was found in outmost of stem and 3-6 serial collenchyma layer under epidermis were seen in all of the samples except hemp. It was noticed that cambium layer which provide diameter increment of wood and non-wood products were between phloem and xylem. Vessels and tracheids in xylem tissues provided transmission of water and food substances. Collenchyma, sclerenchyma, vessels and tracheids formed sources of the fibers. Transmission members alined as both uniform and nonuniform in cross section and sides of each transmission members encircled with sclerenchyma cell layer. If raw materials have thick latewood layer, necessary processes for obtaining of nanofibrils from them are more difficult and the processes take more times because of high density of latewood layer. However because of porosity structure of the selected raw materials that they have abundantly parenchyma and vessel cells, penetration time of the acid solution for dissolving the cell wall components is becoming shortly (Abe and Yano 2010; Wang et al. 2015). As a result, analyses of chemical component values of the samples were determined and they were compared with the other results in literature. All of the values were demonstrated in Table 2.



Table 2. Chemical properties of samples and comparing with literature (Ateş et al. 2011)

Raw Materials	CHEMICAL COMPONENTS						SOLUBILITIES					
	Holocellulose (%)	Cellulose (%)	$\alpha$ -cellulose (%)	Lignin (%)	Silica (%)	Ash (%)	Alcohol-benzene (%)	Acetone (%)	1% NaOH	Hot water (%)	Cold water (%)	
Wheat straw	69,84	49,7	42,07	22,3	7,3	11,6	9,3	5,37	53,7	14,7	11,3	Measurement
Wheat straw	74,6	48,5	41,1	15,9	-	5,10	5,80	-	43,6	12,0	7,89	Reference
Wheat straw	73,9	48,0	38,9	15,7	2,6	4,4	5,3	-	40,1	10,5	-	Reference
Wheat straw	73,0	48,1	-	16,6	-	-	9,2	-	42,8	14,0	-	Reference
Wheat straw	74,9	48,9	37,4	15,5	4,5	5,9	4,9	-	41,9	13,3	-	Reference
Barley straw	66,01	49,3	38,7	19,47	6,88	10,97	8,71	5,39	56,25	16,3	11,01	Measurement
Barley straw	73,3	-	36,4	16,6	-	-	-	-	-	12,2	-	Reference
Rye straw	76,95	51,65	44,55	17,25	2,07	4,01	7,44	4,51	44,35	15,72	11,95	Measurement
Rye straw	74,1	51,5	44,4	15,4	1,5	3,2	9,2	-	39,2	13,0	-	Reference
Rye straw	73,78	49,27	-	16,96	-	3,53	9,24	-	42,68	15,96	14,23	Reference
Rice straw	79,39	55,3	53,67	23,77	15,67	15,44	2,21	3,02	45,63	13,82	9,66	Measurement
Rice straw	70,9	48,2	35,6	23,77	14,9	16,6	3,5	-	49,2	16,2	10,7	Reference
Rice straw	-	53,5	-	25,5	-	12,0	-	-	-	-	-	Reference
Sunflower stalk	66,85	47,8	44,2	14,43	0,44	7,99	7,48	4,86	50,05	24,26	21,08	Measurement
Sunflower stalk	74,9	47,6	37,5	18,2	-	8,2	7,0	-	29,8	16,5	-	Reference
Corn stalk	69,92	55,7	46,78	18,16	2,98	7,75	8,57	8,1	46,43	16,82	14,64	Measurement
Corn stalk	64,8	45,6	35,6	17,4	3,5	7,5	9,5	-	47,1	9,5	-	Reference
Tobacco stalk	64,29	50,95	36,4	15,15	0,94	14,44	8,06	5,58	50,57	21,56	17,15	Measurement
Tobacco stalk	67,6	46,5	37,5	17,5	0,0	7,3	6,5	-	42,9	19,1	-	Reference
Hemp	86,08	80,70	75,29	6,42	1,24	3,62	1,59	1,63	20,4	5,85	5,29	Measurement
Hemp	86,93	71,41	63,77	6,59	-	-	4,23	-	29,55	9,06	7,75	Reference
Cotton stalk	62,79	47,3	29,74	23,79	0,34	4,99	8,36	3,84	48,88	17,91	15,05	Measurement
Cotton stalk	72,2	-	41,6	19,3	-	2,40	6,10	-	42,9	17,8	16,7	Reference
Cotton stalk	76,6	46,5	38,9	19,5	-	2,30	6,50	-	21,6	11,1	10,3	Reference
Reed	78,85	56,65	52,56	22,79	1,23	4,17	3,26	2,98	36,81	9,8	7,61	Measurement
Reed	77,9	50,3	47,5	18,7	-	3,90	4,00	-	28,3	3,80	3,30	Reference
Coniferous tree	70-81	42-51	40-45	24-32	-	<1	1-8	-	8-14	1-6	1-4	Reference
Deciduous	63-90	55-38	36-49	21-25	-	<1	1-7	-	15-22	1-8	1-5	Reference

It was seen that the highest holocellulose value obtained as 86,08% in hemp sample according to Table 2. Alike the highest values was achieved in hemp sample with 80,70% and 75,29% with regard to cellulose and  $\alpha$ -cellulose contents, respectively. Maximum lignin content was found as 23,79% in cotton stalk sample. It was seen that rice straw sample had maximum silica (15,67%) and ash (15,44%) content. The highest alcohol-benzene solubility value was determined as 9,3% in wheat straw sample, whereas the highest acetone solubility value was determined as 8,1% in corn stalk sample. Maximum 1% NaOH solubility value was found as 56,25% in barley straw sample. It was confirmed that sunflower stalk had maximum hot water solubility with 24,26% and maximum cold water solubility with 21,08%. When it was looked the studies in the literature, it was noticed that similar results were obtained.

According the results, hemp can be the most suitable raw material for nanofibril obtaining and so production of bio-based composite films with regard to chemical components because it has the highest cellulose content and the lowest lignin content. In this case, the amount and time of necessary chemical processes to purify cellulose by removing of lignin and hemicellulose will decrease. Bhatnagar and Sain (2005) and Wang et al. (2007) used hemp as

raw material in their studies and they determined that nanofibril can be obtained from hemp in high yield due to its high cellulose content and purification easily. Silica content is very significant factor to determine some properties of rice straw nanofibril composite films (Kim et al. 2004). Because rice straw has the highest silica content, these particles can be decrease the hydrogen bonding between the nanofibrils. Therefore, tensile strength and modulus of films produced from rice straw nanofibrils are less than those of films produced from the other raw materials (Hassan et al. 2012). However high silica content can improve the last product burning properties. It was stated in some researches in the literature that annual plants and agricultural residues were appropriate for production of nanofibrils and biocomposite films because most of them have more cellulose content than wood.

### Conclusion

In this study ten different agricultural wastes (wheat straw, barley straw, rye straw, rice straw, sunflower stalk, cotton stalk, corn stalk, tobacco stalk, reed and hemp) growing in Turkey were selected and morphological, anatomical and chemical characteristics were determined for opportunities of biocomposite film production from them. As a result of morphological analyses, the highest fiber length was found as 28,74 mm in hemp, whereas the least fiber length was found as 0,97 mm and 0,98 mm in cotton stalk and tobacco stalk, respectively. It was seen that tobacco stalk and hemp had maximum fiber widths with 25,75  $\mu\text{m}$  and 25,53  $\mu\text{m}$ . It was confirmed anatomic units of the samples such as collencyhma, sclerenchyma, parenchyma, cambium, epidermis, xylem, phloem, tracheid, and vessel with anatomical analyses. According to chemical analyze results, the highest cellulose content and the lowest lignin content were determined as 80,70% and 6,42% in hemp. Rice straw drew attention in the samples because it had maximum silica (15,67%) and ash (15,44%) contents.

As a consequence, it was seen that agricultural wastes were suitable to applications in the production of nanocellulose and biocomposite films with morphological, anatomical and chemical analyses. Nonetheless, additional treatments and processes should perform to diminish to micro/nano scale dimensions of the samples in biocomposite film production.

### Acknowledgments

The technical supports of this study were provided by laboratories of Faculty of Forestry in Kastamonu University and Karadeniz Technical University.

### References

- Abe K., Yano H. (2010). Comparison of the characteristics of cellulose microfibril aggregates isolated from fiber and parenchymal cells of Moso bamboo (*Phyllostachys pubescens*). *Cellulose*, 17(2), 271-277.
- Acar M., Gizlenci Ş., Dok M., Erdoğan M., Efendioğlu Çelik A. (2016). Evaluation of some agricultural residues as biomass source. 2. National Biofuels Symposium, 27-30 September 2016, Samsun.
- Alkaya E., Akarsoy Altay T., Başak Ata A., Ölmez Çakar S., Durtaş P. (2010). Advanced technology projects, Part 1: Production of bioproduct with high added value from agricultural residues. Turkish Foundation for Development of Technology, Ankara, 15-16.
- Ateş S., Deniz İ., Kırıcı H., Atik C., Güney K. (2011). Investigations on pulp obtaining by evaluating of some annual plant residues grown in Turkey in the same plant and

- bleaching with enzyme. The Project of The Scientific and Technological Research Council of Turkey, Project No: 108 O 594, Kastamonu.
- Bhatnagar A., Sain M. (2005). Processing of cellulose nanofibre-reinforced composites. *Journal of Reinforced Plastics & Composites*, 24(12), 1259-1268.
- Cao X., Chen Y., Chang P.R., Stumborg M., Huneault M.A. (2008). Green composites reinforced with hemp nanocrystals in plasticized starch. *Journal of Applied Polymer Science*, 109, 3804-3810.
- Hafızoğlu H., Deniz İ. (2011). Wood chemistry, Karadeniz Technical University, Faculty of Forestry, Trabzon.
- Hassan M.L., Mathew A.P., Hassan E.A., El-Wakil N.A., Oksman K. (2012). Nanofibers from bagasse and rice straw: Process optimization and properties. *Wood Science and Technology*, 46, 193-205.
- Hubbe M.A., Rojas O.J., Lucia L.A., Sain M. (2008). Cellulosic nanocomposites: A review. *BioResources*, 3(3), 929-980.
- Jamshidian M., Tehrany E.A., Imran M., Jacquot M., Desobry S. (2010). Poly-lactic acid: Production, applications, nanocomposites and release studies. *Comprehensive Reviews in Food Science and Food Safety*, 9, 552-571.
- Jose J.P., Malhotra S.K., Thomas S., Joseph K., Goda K., Sreekala M.S. (2012). Advances in polymer composites: Macro- and microcomposites – state of the art, new challenges and opportunities. *Polymer Composites*, 1, 3-16.
- Kim H.S., Yang H.S., Kim H.J., Park H.J. (2004). Thermogravimetric analysis of rice husk flour filled thermoplastic polymer composites. *Journal of Thermal Analysis and Calorimetry*, 76, 395-404.
- Oun A.A., Rhim J.W. (2016). Isolation of cellulose nanocrystals from grain straws and their use for the preparation of carboxymethyl cellulose-based nanocomposite films. *Carbohydrate Polymers*, 150, 187-200.
- Peng B.L., Dhar N., Liu H.L., Tam K.C. (2011). Chemistry and applications of nanocrystalline cellulose and its derivatives: A nanotechnology perspective. *The Canadian Journal of Chemical Engineering*, 89, 1191-1206.
- Smyth M., García A., Rader C., Foster E.J., Bras J. (2017). Extraction and process analysis of high aspect ratio cellulose nanocrystals from corn (*Zea mays*) agricultural residue. *Industrial Crops and Products*, 108, 257-266.
- Wang B., Sain M., Oksman K. (2007). Study of structural morphology of hemp fiber from the micro to the nanoscale. *Applied Composite Materials*, 14(2), 89-103.
- Wang B., Sain M. (2007c). The effect of chemically coated nanofiber reinforcement on biopolymer based nanocomposites. *Bioresources*, 2(3), 371-388.
- Wang H., Zhang X., Jiang Z., Li W., Yu Y. (2015). A comparison study on the preparation of nanocellulose fibrils from fibers and parenchymal cells in bamboo (*Phyllostachys pubescens*). *Industrial Crops and Products*, 71, 80-88.
- Zhang J., Luo N., Wan J., Xia G., Yu J., He J., Zhang J. (2017). Directly converting agricultural straw into all-biomass nanocomposite films reinforced with additional in situ-retained cellulose nanocrystals. *ACS Sustainable Chemistry and Engineering*, 5(6), 5127-5133.

## SHORT-TERM DIAMETER AND HEIGHT INCREMENTS OF ORIENTAL BEECH AND BLACK ALDER SEEDLINGS IN PURE AND MIXED SITES

Sinan GUNER\*, Askin GOKTURK, Mehmet KUCUK

Artvin Çoruh University Forestry Faculty, Department of Forest Engineering, Turkey

\*Corresponding author:sinanguner@artvin.edu.tr

### Abstract

Black alder (*Alnus glutinosa* subsp. *barbata* (C.A.Mey). Yalt) enriches soil with nitrogen through a symbiotic relationship with bacteria found in its roots. Because of this characteristic, alders can be evaluated as a natural fertilizer. In this study, it was investigated whether there could be an important contribution of black alder to the increment of oriental beech (*Fagus orientalis* Lipsky) when oriental beech and black alder were grown together in afforestation sites. In 2014, 15 sample plots each of them 200 m<sup>2</sup> were established according to the randomized complete block design with five replications in Arhavi district of Artvin province located in the eastern Black Sea Region of Turkey. Five of the sample plots were planted with 2-year-old eastern beech, 5 with 1-year-old black Alder 5 mixed with 1-year old alder and 2-year old eastern beech. Seedlings were planted with 1m x 1m spacing distance. Changes in root collar diameter, height of all seedlings in pure and mixed sample plots were measured in the fall annually. An Independent Samples T Tests was conducted to determine whether planting type had a significant effect on differences in root collar diameter and height of seedlings. Assessment made two years after planting showed that black alder grows more rapidly than oriental beech in pure sample plots. It has been determined that the growth (increment of root collar diameter and height growth) of oriental beech seedlings is better in mixed black alder and oriental beech plots compared to pure oriental beech plots.

**Key Words:** Black alder, Oriental beech, root collar diameter, diameter increment, height increment

### Introduction

Fertilization is one practice employed to obtain high yields in a short amount of time in plantation based operations. Several studies have shown that fertilization has led to increased yields (Aronsson *at al.*, 2014; Bergh *at al.*, 2014). However, mineral fertilizers in particular may lead to environmental problems such as nitrate accumulation and carbon loss in soils (Nkoa, 2014; Quiao *at al.*, 2015; Moreno-Jiménez, 2016). They also can suppress the growth of plants when applied in large quantities contrary to expectations (Conway and Pretty, 2013; Rigby *at al.*, 2016). Environmental organizations recommend the use of natural fertilizers in agriculture and forestry.

Natural fertilizers are produced by composting organic waste or directly applied as organic waste to soil. There are leguminous and actinorhizal plants, which have natural fertilizer characteristics. They convert atmospheric nitrogen into forms that can be used by plants through symbiotic relationships with *Frankia* and *Rhizobium* bacteria in their roots and improve the nitrogen content of soil (Smith *at al.*, 1992; Weber *at al.*, 1987; Carro *at al.*, 2015; Kumar *at al.*, 2015; Cao *at al.*, 2017).

Nitrogen is the most important macronutrient that supports growth in plants. Nitrogen as a primary macronutrient is found in the organic structure of plants and provides faster growth (Kaye and Hart, 1997; Haynes, 2012).

One tree species that can be used as a live fertilizer is alders. The *Frankia* bacteria that form symbiotic relationships with alders in root nodules enrich the soil by converting atmospheric nitrogen into forms that can be used by plants and soil organisms (Cole and Newton, 1986; Genç, 2004). Alders are also among fast growing industrial forest tree classes in addition to harboring nitrogen-fixing bacteria. Alders grow in northern regions of Turkey. For growth, they require a humid climate with precipitation exceeding 2000 mm (Yaltırık, 1993; Anşın and Özkan, 1997). Various studies have shown that alders improve (Meiden, 1961; Miller and Murray, 1978; DeBell and Radwan, 1979), have no effect (Dale, 1963) or have negative effect (Miller *at al.*, 2005; Sayyad *at al.*, 2006) on the growth of the species with which they are coplanted.

Oriental beech is an important industrial forest species. Like alder, it is generally distributed in northern regions of Turkey in humid environments, on north facing slopes within a 700-2000 m elevation range (Yaltırık, 1993; Kandemir *at al.*, 2016). Oriental beech forests are managed within 100-140 year periods.

The Black Sea Region, where oriental beech and bearded alder coexist, has a humid, temperate climate with precipitation throughout the year. Annual precipitation average exceeds 3000 mm/m<sup>2</sup> especially in the areas where eastern beech grows in the region (TMA, 2017). Plant nutrients, mainly nitrogen, get washed away with the precipitation. Growth deficiencies like yellowing of the leaves, nutrient deficiencies and smaller shoot and leaf sizes due to nitrogen deficiency are observed in the beech forests of the region.

In this study, it was investigated that whether there would be a positive contribution to the growth of oriental beech seedlings in mixed plantations of oriental beech and black alder. In order to make this determination, the change in root collar diameter and seedling height increment of oriental beech seedlings was tested when alder for the growth of oriental beech provided nitrogen support.

### Material and Methods

The study was conducted at a rehabilitation area in Ortacalar- Arhavi (41° 17' 10" N - 41° 23' 72" E, elv. 950m) in the eastern Black Sea Region of Turkey. The size of the study site is 1.5 ha. The amount of precipitation at the site is 2400 mm/m<sup>2</sup> according to Arhavi Meteorological Station data. In the fall of 2014, the site was clear-cut and cleared and then soil was prepared. Afterwards 15 sample plots of 10 m x 20 m were established according to the randomized complete block design with five replications. Five of the plots were planted with 200 1-year old black alder, five of them were planted with 200 2-yr old oriental beech seedlings immediately following the establishment of sample plots. A hundred 1-yr old black alder and 100 2-yr old oriental beech seedlings were planted in mixed order in the remaining five sample plots. Planting types were applied to the sample plots randomly and each plots of pure and mixed plantings was taken into consideration as a replication of planting types. The plantings were done at 1m x 1m spacing distance in all of the sample plots. In total, the study site was planted with 3000 seedlings including 1500 oriental beech and 1500 black alder. Root collar diameter (nearest 0,5 mm at ground level) and height of the seedlings (nearest 0,5 mm from the ground to the terminal bud) were measured following the planting. Root collar diameter and height were measured with a millimeter digital caliper and a ruler, respectively. Root collar diameter and height of the seedlings were re-measured in order and recorded at the end of the vegetation periods in 2015 and 2016.

The changes in the root collar diameter and height of alder and beech seedlings in pure and mixed plots between 2014 and 2016 were analyzed by SPSS Version XIX. An Independent Samples T Tests was conducted for each species to determine whether planting type (pure and mixed) had a significant effect on the observed differences in root collar diameter and height

of seedlings between 2014 and 2016. Mean values of differences in root collar diameter and height were used in independent Samples T Tests.

### Results and Discussion

The mean, minimum and maximum values of root collar diameter and height of black alder and oriental beech seedlings grown in pure and mixed plots between 2014 and 2016 are displayed in Table 1. Alders grown in pure plots had a root collar diameter of 13.38 mm and reached a height of 162.2 cm at age 3. Alders had a root collar diameter of 13.69 mm and a height of 167.0 cm at age 3 when grown in mixed plots. Oriental beech grown in pure plots had a mean root collar diameter of 8.83 mm and a mean height of 67.3 mm at age 4. When beeches were grown mixed with alder, they had a mean root collar diameter of 8.94 mm and reached a mean height of 74.3 cm at age 4 (Table 1).

Table 1. Root collar diameter and seedling height measurement data (2014, 2015, 2016)

Year	Pure/ Mix	Species	N	Root Collar Diameter			Seedling Height		
				Mean mm	Minimum mm	Maximum mm	Mean cm	Minimum cm	Maximum cm
2014	Pure	Alder	1000	5.70	5.51	5.85	35.6	32.4	39.2
		Beech	1000	7.83	7.72	7.86	34.0	22.9	35.2
	Mix	Alder	500	5.70	5.66	5.74	35.6	25.0	37.9
		Beech	500	7.83	7.80	7.85	34.0	33.0	34.9
2015	Pure	Alder	1000	7.10	6.78	7.21	112.4	88.5	132.5
		Beech	1000	7.93	7.88	7.98	40.9	36.8	44.2
	Mix	Alder	500	7.14	7.05	7.21	115.3	90.5	124.9
		Beech	500	7.95	7.90	8.01	41.0	36.0	45.5
2016	Pure	Alder	1000	13.38	12.12	14.12	162.2	114.4	194.8
		Beech	1000	8.83	8.75	8.90	67.3	58.9	74.9
	Mix	Alder	500	13.69	12.60	15.20	167.0	129.1	182.7
		Beech	500	8.94	8.78	9.07	74.3	60.4	89.7

The change in root collar diameter and height of alder and beech seedlings grown in pure and mixed plots in 2014, 2015 and 2016 are displayed in Figure 1. As can be seen in the figure, alders grew faster than beeches.

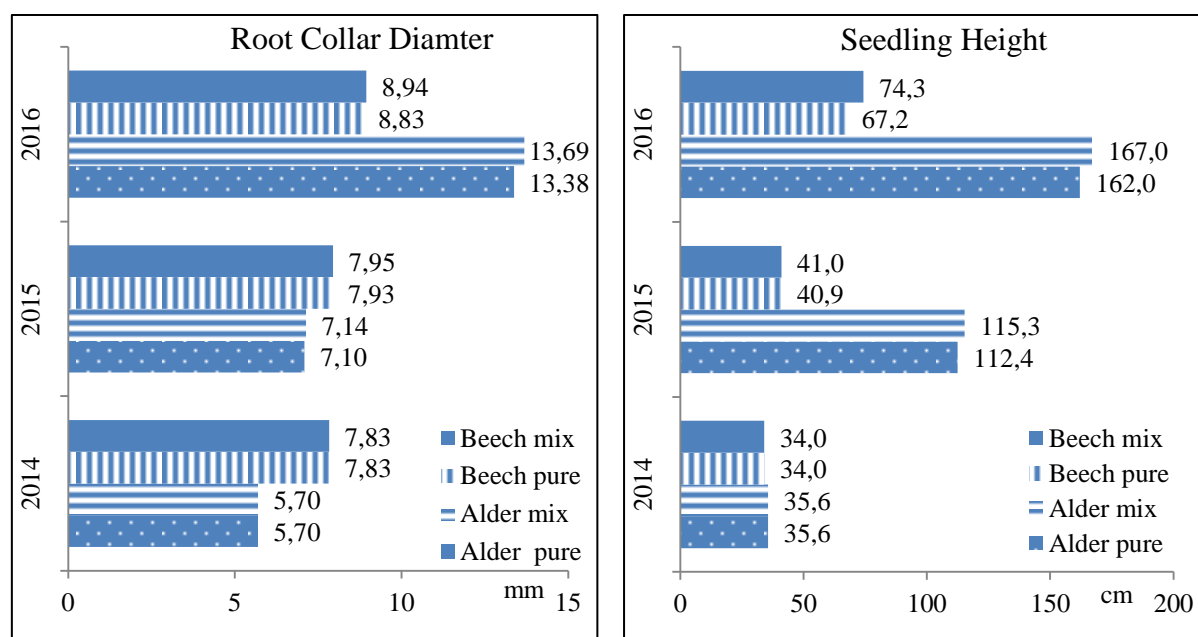


Figure 1. The change in root collar diameter and height of black alder and oriental beech seedlings grown in pure and mixed plots.

Independent samples t-test results showed that the pure and mixed beech groups were different from each other. The difference between the increments of root collar diameter and height of beech grown in mixed plots with alder and beech grown in pure plots was significant. However, there was not a significant difference between pure and mixed alder groups. The difference between the increments of root collar diameter and height of alder grown in mixed plots with beech and alder grown in pure plots was not significant (Table 2).

Table 2. Independent samples t-test results of differences in seedling root collar diameter and height between 2014 and 2016.

Species	Variables	Levene's Test for Equality of Variances		T-test for Equality of Means			
		F	Sig.	t	df	Sig. (2-tailed)	
Beech	Diameter	Equal variances assumed	4,968	,056	-10,164	8	,000
		Equal variances not assumed			-10,164	6,451	,000
	Height	Equal variances assumed	3,053	,119	-5,895	8	,000
		Equal variances not assumed			-5,895	6,509	,001
Alder	Diameter	Equal variances assumed	,388	,550	-1,081	8	,311
		Equal variances not assumed			-1,081	7,839	,312
	Height	Equal variances assumed	2,840	,130	-1,359	8	,211
		Equal variances not assumed			-1,359	7,087	,216

Beech grown in pure plots had a mean root collar diameter increment of 1 mm. Oriental beech grown in mixed plots had a mean root collar diameter increment of 1,12 mm. The mean height increment in beech seedlings grown in pure plots was 33.2 cm whereas the increment in beech seedlings grown in mixed plots was 40,3 cm. Alders grown in pure plots increased

their root collar diameter 7,68 mm whereas in mixed plots grown with beech, alders had a higher root collar diameter increment of 7,99 mm. Mean seedling height increment in pure alder plots was 126,6 cm and increased to 131,4 cm in mixed plots (Table 3).

Table 3. Group Statistics of differences in seedling root collar diameter and height between 2014 and 2016

Species	Variables	Planting Type	N	Mean	Std. Deviation	Std. Error Mean
Beech	Diameter (mm)	Pure	5	1,0012	,02211	,00989
		Mix	5	1,1176	,01293	,00578
	Height (cm)	Pure	5	33,2696	2,29202	1,02502
		Mix	5	40,2970	1,36096	,60864
Alder	Diameter (mm)	Pure	5	7,6811	,48769	,21810
		Mix	5	7,9928	,42209	,18877
	Height (cm)	Pure	5	126,6254	6,52244	2,91693
		Mix	5	131,4348	4,48002	2,00352

Positive effects on the growth of the species grown with alders generally have been observed in similar studies. Miller and Murray (1978) found that *Pseudotsuga menziesii* ((Mirb.) Franco.) had better growth over shorter periods in mixed plantations containing proportions of 59% *Alnus rubra* (Bong.). DeBell and Radwan (1979) showed that *Populus trichocarpa* (Torr. & Gray) had improved growth over shorter periods when grown in plantations containing proportions of 50% *Alnus rubra*. Similarly, Maiden (1961) found that planting alder in the understory of poplar plantations resulted in greater height and diameter growth. However, there were cases in which alders had negative effects on the growth of coexisting species. For example Sayyad et al. (2006) found negative effects of *Alnus crispa* on growth of *Pinus contorta* and *Picea glauca*. Miller et al. (2005) found that proportions of 7-27% *Alnus rubra* had no effect on growth of *Pseudotsuga menziesii* var *menziessi* ((Mirb.) Franco) but in areas where *Alnus rubra* was taller, the death rate of *P. menziesii* var *menziessi* ((Mirb.) Franco) was higher.

Alders had a positive contribution to root collar diameter and height increment of oriental beech in the second year according to the results of the current study. These results are in agreement with the findings of Miller and Murray (1978), who showed positive contributions of *Alnus rubra* on *Pseudotsuga menziesii* (Mirb.) Franco.) growth and Van der Meiden (1961), who found higher increments in poplars when grown with alders. However, whether this positive contribution will continue and the nature of future interaction between the two species will be only reliably identified by measurements in upcoming years.

### Conclusions

After two years of growth, it was found that oriental beech seedlings grown in mixed plots with alder had greater increments of root collar diameter and height compared to oriental beech seedlings grown in pure plots. The differences between the increments in pure versus mixed plots were significant based on statistical analyses ( $\alpha < 0.05$ ).

### Acknowledgement

This study was funded by Scientific and Technological Research Council of Turkey (TUBITAK), Agriculture, Forestry and Veterinary Group (TOVAG) with the Project no:



1140661 for 2014-2017. The authors would like to thank to the personnel of Arhavi Forest Management Directorate, V. Çaloğlu and A. Duman, who contributed to the study.

### References

- Alloisio N, Queiroux C, Fournier P, Pujic P, Normand P, Vallenet D. (2010). The Frankia alni symbiotic transcriptome. *Mol Plant Microbe Interact* 23: 593–607.
- Anşın, R and Özkan, Z.C. (1997). Tohumlu Bitkiler (Spermatophyta) Odunsu Taksonlar, KTÜ Orman Fak., Genel Yayın No:167, Fakülte Yayın No:19, 513 S., Trabzon.
- Aronsson, P., Rosenqvist, H., Dimitriou, I. (2014). Impact of nitrogen fertilization to short-rotation willow coppice plantations grown in Sweden on yield and economy. *Bioenergy Research*, 7(3), 993-1001.
- Bergh, J., Nilsson, U., Allen, H. L., Johansson, U., Fahlvik, N. (2014). Long-term responses of Scots pine and Norway spruce stands in Sweden to repeated fertilization and thinning. *Forest Ecology and Management*, 320, 118-128.
- Cao, Y., Halane, M. K., Gassmann, W., Stacey, G. (2017). The Role of Plant Innate Immunity in the Legume-Rhizobium Symbiosis. *Annual Review of Plant Biology*, 68(1).
- Carro, L., Pujic, P., Alloisio, N., Fournier, P., Boubakri, H., Hay, A. E., Balmand, S. (2015). Alnus peptides modify membrane porosity and induce the release of nitrogen-rich metabolites from nitrogen-fixing Frankia. *The ISME journal*, 9(8), 1723-1733.
- Cole, E.C., Newton, M. (1987). 5th year responses of Douglas-Fir to crowding and nonconiferous competition. *Can. J. For. Res.* 17, 181–186.
- Conway, G.R. and Pretty, J.N. (2013). *Unwelcome harvest: agriculture and pollution*. Routledge.
- Dale, M.E. (1963). Interplant alder to increase growth in strip-mine plantations. USDA Forest Serv. Res. Note CS-14, 4 p.
- DeBell, D.S. and Radwan, M.A. (1979). Growth and nitrogen relations of coppiced black cottonwood and red alder in pure and mixed plantations. *Bot. Gaz.* 140:\$97-SI01.
- Genç, M., (2004). Silvikültürün Temel Esasları, SDÜ Orman Fak., Yayın No:44, 341 S., Isparta.
- Haynes, R. (2012). *Mineral nitrogen in the plant-soil system*. Elsevier.
- Kandemir, G.E., Tayanç, Y., Çengel, B., Velioglu, E. (2016). Türkiye’de yayılış gösteren kayın (Fagus) populasyonlarının moleküler filogenisi. *Ormanlık Araştırma Dergisi*, 1(4 A), 69-79.
- Kaye, J.P. and Hart, S.C. (1997). Competition for nitrogen between plants and soil microorganisms. *Trends in Ecology & Evolution*, 12(4), 139-143.
- Kumar, A., Bahadur, I., Maurya, B.R., Raghuvanshi, R., Meena, V.S., Singh, D.K., Dixit, J. (2015). Does a plant growth promoting rhizobacteria enhance agricultural sustainability. *J Pure Appl Microbiol*, 9(1), 715-724.
- Moreno-Jiménez, E., Fernández, J. M., Puschenreiter, M., Williams, P. N., Plaza, C. (2016). Availability and transfer to grain of As, Cd, Cu, Ni, Pb and Zn in a barley agri-system: Impact of biochar, organic and mineral fertilizers. *Agriculture, Ecosystems & Environment*, 219, 171-178.
- Miller, R.E. and Murray, M.D. (1978). The effect of red alder on growth of Douglas fir. In Utilization and management of alder, USDA Forest Serv. p. 283-306.
- Miller, R.E., Anderson, H.W., Murray, M., Leon, Rick. (2005). Comparative effects of urea fertilizer and red alder in a site III, coast Douglas-fir plantation in the Washington Cascade Range. Res. Pap. PNW-RP-565. Portland, OR: U.S. Department of Agriculture, Forest Service, Pacific Northwest Research Station. 28 p.

- Nkoa, R. (2014). Agricultural benefits and environmental risks of soil fertilization with anaerobic digestates: a review. *Agronomy for Sustainable Development*, 34(2), 473-492.
- Rigby, H., Clarke, B.O., Pritchard, D.L., Meehan, B., Beshah, F., Smith, S.R., Porter, N.A. (2016). A critical review of nitrogen mineralization in biosolids-amended soil, the associated fertilizer value for crop production and potential for emissions to the environment. *Science of the Total Environment*, 541, 1310-1338.
- Sayyad, E., Hosseini, S.M., Mokhtari, J., Mahdavi, R., Jalali, S.G., Akbarinia, M., Tabari, M. (2006). Comparison of growth, nutrition and soil properties of pure and mixed stands of *Populus deltoides* and *Alnus subcordata*. *Silva Fennica* 40(1): 27–35.
- Smit, G., Swart, S., Lugtenberg, B.J., Kijne, J.W. (1992). Molecular mechanisms of attachment of Rhizobium bacteria to plant roots. *Molecular microbiology*, 6(20), 2897-2903.
- TMA, (2017). Turkish Meteorological Agency, (<https://mgm.gov.tr>)
- Qiao, C., Liu, L., Hu, S., Compton, J.E., Greaver, T.L., Li, Q. (2015). How inhibiting nitrification affects nitrogen cycle and reduces environmental impacts of anthropogenic nitrogen input. *Global change biology*, 21(3), 1249-1257.
- Van Der Meiden, H.H. (1961). Alder in mixture with poplar, *Nederlands bosbouw tijdschrift* 33:168-171.
- Weber, A., Nurmiaho-Lassila, E.L., Sundman, V. (1987). Features of the intrageneric *Alnus*-*Frankia* specificity. *Physiologia Plantarum*, 70(2), 289-296.
- Yaltrık F. (1993). *Dendroloji II, (Angiospermae)*, I.U. Second edition, Forestry Faculty, Istanbul, 194 p.

## CONTRIBUTIONS OF MULTI-SITE PROVENANCE TRIALS TO INVESTIGATE GENETIC DIVERSITY OF FOREST TREES POPULATIONS ASSOCIATED WITH GEOGRAPHY

Vasilije ISAJEV<sup>1</sup>, Milena STANKOVIC-NEDJIC<sup>2\*</sup>, Vera LAVADINOVIC<sup>3</sup>, Stefan BOJIC<sup>2</sup>

<sup>1</sup>Faculty of Forestry, Belgrade, Serbia

<sup>2</sup>Department for Forestry, Faculty of Agriculture, University of East Sarajevo, Bosnia and Herzegovina

<sup>3</sup>Institute for Forestry, 11030 Belgrade, Serbia

\*Corresponding author: stankovic.milena08@yahoo.com

### Abstract

Provenance in forestry refers to the population of trees growing at a particular place of origin. Provenance research defines the genetic and environmental components of phenotypic variation associated with geographic source. This article summarizes the results from a Serbian - wide series of 24 provenance trials of native provenances of Douglas fir (*Pseudotsuga menziesii*/Mirb./Franco) from the USA and 7 provenance trails of native provenance of Norway spruce (*Picea abies* Karst ) from Slovenia and Serbia. The seedlings from all collection locations are planted together in a systematic experimental design on multiple sites. Multi annual research included comparative analyses of intra- and inters-provenance variability of several quantitative characters: a) trees – volume, basal area and volume increment, as well as of qualitative characteristics: a) the main physical and mechanical properties of felled stem wood at the height from 0.3 to 1.3m. The data on the variability of air temperature and precipitation at the study localities were obtained from the Republican Hydro-Meteorological Institute of Serbia. The effects of air temperature and precipitation on the study parameters were determined by Pearson's correlation coefficient. Environmental differences between the location of origin and the planting (test) site have been calculated by principal component analysis and termed ecological distance. Consideration of ecologically important genetic variation within species is important and this information should be integrated into seed collection strategies for ecological restoration. The aim of these analyses is to study the interaction between the genetic potential of the introduced provenances and the environmental conditions at the provenance test sites, aiming at the more reliable selection of forest-economic works on the establishment, silviculture, tending and utilisation of Douglas-fir and Norway spruce plantations.

**Key words:** *provenance trails, genetic diversity, geographic sources*

### Introduction

Provenance trials have been used in Serbian forestry since the middle of 20th century for detecting populations with economically desirable characteristics to be targeted for tree-breeding programmes, (Isajev et al., 1997, 1999, 2003.) Provenance tests offer an excellent resource for making predictions of growth changes associated with climatic change. The big advantage is that many tests involving in several forest species are already in place, with results available and published. The growth-loss estimates are not very precise, but are probably as accurate as extrapolations based on growth chamber data. The source of material included in such trials is known so, existing trials may be utilized to study variation of ecologically important traits and identify appropriate source populations for restoration. For long-lived, slow-growing species, such as many forest trees, long-established trials provide a

unique opportunity to examine later life-history traits, which may reveal important variation not evident in younger plants. In the last three decades, the aim of investigation is to study the interaction between the genetic potential of the introduced provenances and the environmental conditions at the provenance test sites. The results are of importance for the more reliable works on the establishment, silviculture, tending and utilisation of Douglas-fir and Norway spruce plantations in Serbia.

### Material and Methods

#### DOUGLAS-FIR (*Pseudotsuga menziesii* Mirb. Franco) PROVENANCE RESEARCH IN SERBIA

Douglas-fir (*Pseudotsuga menziesii* /Mirb./ Franco) provenance tests in Serbia consist of 29 provenances, originating from almost entire natural range of this species, table 1. One experiment is in the area of Mt. Juhor (central Serbia) at the site of the montane beech forest (*Fagetum moesiaca montanum* Jov. 1976) and the other one is at Tanda near Bor (eastern Serbia), at the site of Hungarian oak and Turkey oak forests (*Quercetum frainetto-cerris* Rud. 1949).

Table 1. Geographical co-ordinates of the tested Douglas fir provenances in Serbia

Origin and provenance	number	of Latitude (°)	Longitude (°)	Altitude (m)
1 Oregon	205-15	43.7	123.0	750
2 Oregon	205-14	43.8	122.5	1200
3 Oregon	202-27	45.0	122.4	450
4 Oregon	205-38	45.0	121.0	600
5 Washington	204-07	49.0	119.0	1200
6 Oregon	205-13	43.8	122.5	1050
7 Oregon	205-18	44.2	122.2	600
8 Oregon	202-22	42.5	122.5	1200
9 Washington	202-17	47.6	121.7	600
10 Oregon	201-10	44.5	119.0	1350
11 Washington	204-06	49.0	120.0	750
12 Oregon	202-19	45.3	123.8	300
13 Oregon	205-11	45.3	123.0	150
14 New Mexico	202-40	45.0	105.7	2682
15 New Mexico	202-10	36.0	106.0	2667
16 Oregon	202-31	44.3	118.8	1500
17 Oregon	205-29	42.6	122.8	900
18 Oregon	205-08	42.7	122.5	1050
19 Oregon	204-04	45.0	121.5	900
20 Washington	205-02	47.7	123.0	300

In Douglas-fir plantations, numerous researches have been undertaken in various spheres of forestry, Lavadinović V. et al.1995. 1997., 1998., 2001., 2003., 2005. By analyzing the values of mean heights and diameters, the significant differences among the provenances and the differences between the tests have been recorded.

This paper deals with the dependence of the provenance latitude, longitude and altitude on the

height increment of test trees grown on allochthonous sites, Figure 1.

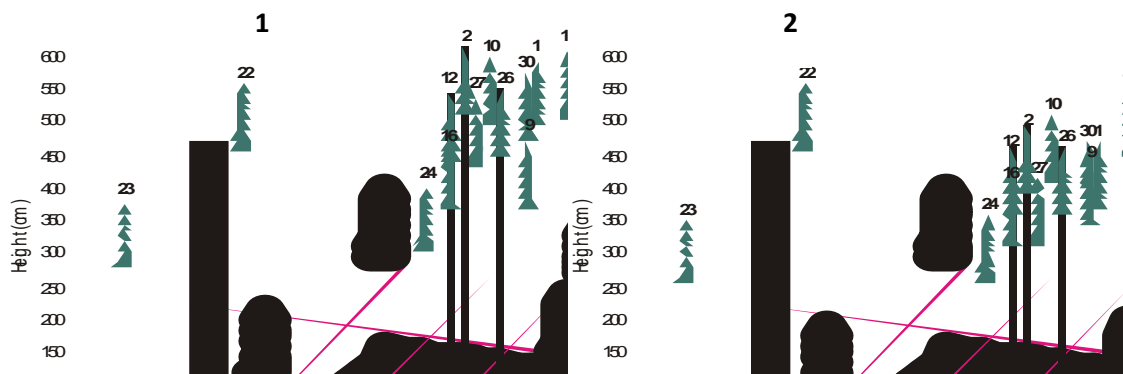


Figure 1. Provenance height in relation to altitude and elevation of origin, locality Tanda (1) and locality Juhor (2)

The results show that latitude has a low effect on height increment of plants of different provenances and that the effects of longitude and altitude are very important.

Dependence of height increment of provenances (Y) on latitude (X1): parabolic dependence in this case is not statistically significant Figure 2. Parameters of regression are as follows:

$$Y = -1975.33 + 91.52 X_1 - 1.018 X_1^2 \quad (1)$$

$$Se = 12.8 \text{ cm}, r^2 = 0.1095, r = 0.3309$$

$$(F < F_{0.05}; 2.60 < 3.40)$$

Dependence of height increment of provenances (Y) on longitude (X2): parabolic dependence is clearly expressed, Figure 3. With the increase of longitude, height increment of provenances also increases to a certain level. Parameters of regression are as follows:

$$Y = -36967.0 + 604.15 X_2 - 2.463 X_2^2 \quad (2)$$

$$Se = 5.6 \text{ cm}, r^2 = 0.8309, r = 0.9115$$

$$(F > F_{0.01}; 64.88 > 5.61)$$

Dependence of height increment of provenances (Y) on altitude (X3): this dependence is clearly expressed. With the increase of altitude, height increment of plants drops. Parameters of parabolic correlation are:

$$Y = 85.02 + 0.0102 X_3 - 0.00002 X_3^2 \quad (3)$$

$$Se = 10.4 \text{ cm}, r^2 = 0.4520, r = 0.6405$$

$$(F > F_{0.01}; 10.04 > 5.61)$$

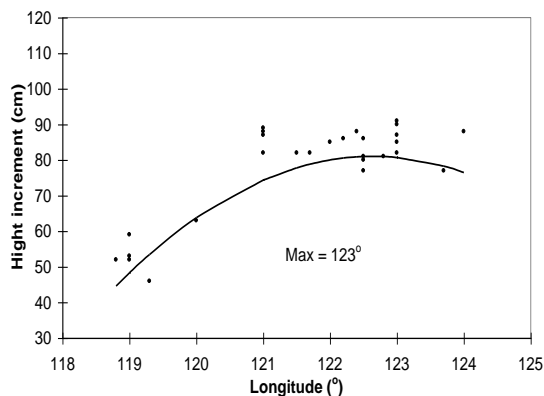


Figure 2. Dependence of height increment of Douglas fir provenances on longitude

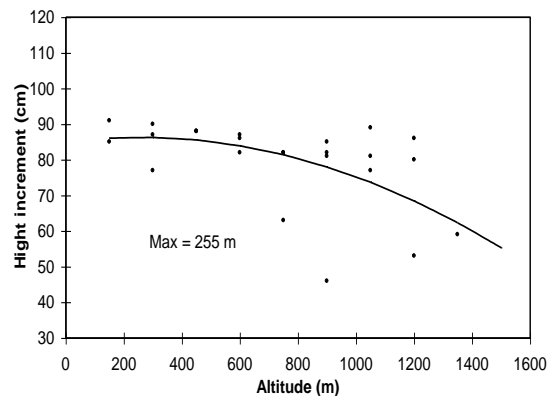


Figure 3. Dependence of height increment of Douglas fir provenances on altitude

The statistical analyses in this study confirmed the significant differences among provenances at these two locations. In approximately 50% cases, there is a highly statistically significant difference. As all the provenances were primarily brought to a approximately the same site conditions, the observed differences in tree development are ascribed to genetic factors. (Lavadinovic and Koprivica 1996, 1999). By analyzing the dependence of the provenance latitude, longitude and altitude on the height increment we recorded significant differences among the provenances and differences between the tests.

The plants at the sample plot Juhor, at the same age, had a considerably higher value of taxation elements than the plants of the same provenances at the sample plot at the locality Tanda. This means that the beech site (Juhor) has better ecological adaptability than the oak site (Tanda).

Based on the analyzed characteristics, the most successful provenances are:

at the locality JUHOR: Oregon: 205-14, Oregon: 202-19 and Washington: 205-02

at the locality TANDA: Oregon: 205-14, Oregon: 202-19 and Washington: 205-31

Statistical analyses prove there are highly significant differences between provenances; thus, careful attention should be paid to the choice of which provenances to use. Based on the above ranking, it can be concluded that the provenances 3 and 18 showed good adaptation to site conditions, both at beech site, and at oak site; provenances 9 and 24 were poor and at both localities.

#### NORWAY SPRUCE (*Picea abies* /L. / Karst.) PROVENANCE RESEARCH IN SERBIA

Norway spruce (*Picea abies* /L. / Karst.) provenance tests in Serbia consist of eight provenances, Isajev et al. 1992. Three provenances of this species are from Slovenia – Mašun, Menina and Jelovica; and five provenances are from Serbia – Golija, Zlatar, Čemerno, Radočelo and Kopaonik. The monocultures near Ivanjica were established by planting four-year old seedlings at three localities, at the altitudes of 600, 1100 and 1600 m. Isajev et al. 1992., 1999. The aim of the research was to identify the spruce differential characters and variability in the part of its natural range in the south-east Europe and to study the production capacity and the differences between individual provenances in more or less identical and different ecological conditions in Serbia, Šijačić-Nikolić et al. 2000.

In Norway spruce plantations, numerous researches have been undertaken included several morphometric characters of juvenile plants, for each year between 7 and 14 years of age, Ivetić 2004. The measured characters are height and height increment at the annual level, root collar diameter and diameter increment and the number of branches. The study results of metric properties were analysed by standard statistical methods.

The data on the variability of air temperature and precipitation at the study localities were obtained from the Republican Hydro-Meteorological Institute of Serbia. The effects of air temperature and precipitation on the study parameters were determined by Pearson's correlation coefficient. The values of temperature and rainfall were previously fitted separately for each locality. The soil characteristics were investigated by topographic observations and the soil profiles were opened for soil sampling. The laboratory analyses were performed at the Faculty of Forestry in Belgrade.

The results of the study of spruce potentials of different provenances confirm that the free genetic variability of this species is very high, and that, according to the results of the analyses, the Serbian provenances are characterised by higher adaptivity to very different ecological conditions. In this provenance test, in the plantation at the montane beech site where, as a rule, spruce does not occur naturally, its growth and adaptation are successful. This indicates that, in addition to the natural optimum in the zone of spruce belt *Picetum abietis serbicum*, its technogenic optimum can also occur at the site of other species. The

study results obtained from all three altitudinal belts confirm the specificity of the spruce gene pool in Serbia, which conditions the phenomenon of its special climatogenic belt in Serbia, compared to other countries of the Balkan Peninsula. After the culmination of height increment of spruce trees and after the test plantations pass from the juvenile stage into the reproductive stage of development, by the establishment of tests with generative progeny, the nature of the interprovenance variability will be closer understood. The test results will enable the more reliable use of provenances with the most suitable potential for the establishment of stable and productive cultures on the concrete sites in Serbia. The comparative research of eight provenances shows that the provenances Golija and Zlatar are characterised by high adaptability and growth dynamics, so they should be more intensively applied in future activities of plantation establishment or afforestation of bare lands in Serbia. This study includes several morphometric characters of juvenile plants, for each year between 7 and 14 years of age. The measured characters are height and height increment at the annual level, root collar diameter and diameter increment and the number of branches. The study results of metric properties were analysed by standard statistical methods, figure 4.

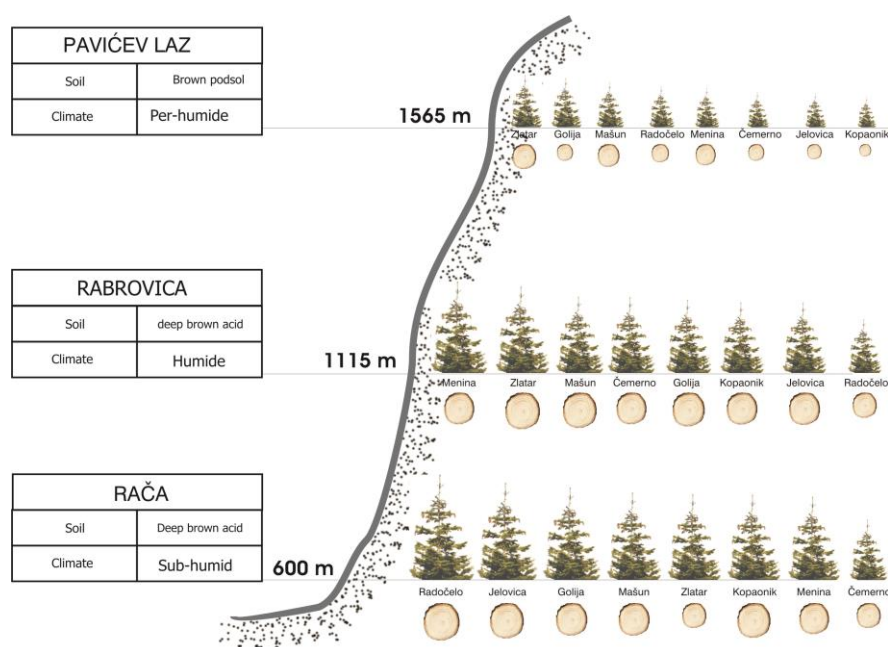


Figure 4. Comparative analyses of the Norway spruce provenance test in Serbia, Ivetić 2004

The results of the study of spruce potentials of different provenances confirm that the free genetic variability of this species is very high, and that, according to the results of the analyses, the Serbian provenances are characterised by higher adaptivity to very different ecological conditions. In this provenance test, in the plantation at the montane beech site where, as a rule, spruce does not occur naturally, its growth and adaptation are successful. This indicates that, in addition to the natural optimum in the zone of spruce belt *Picetum abietis serbicum*, its technogenic optimum can also occur at the site of other species. The aim of the research was to identify the spruce differential characters and variability in the part of its natural range in the south-east Europe, to study the production capacity and the differences between individual provenances in more or less identical and different ecological conditions in Serbia.

This study includes several morphometric characters of juvenile plants, for each year between 7 and 14 years of age. The measured characters are height and height increment at the annual

level, root collar diameter and diameter increment and the number of branches. The study results of metric properties were analysed by standard statistical methods.

### **Conclusions**

The aspects discussed in the present review are intended to assist in assessing the importance and potential of provenance research. They highlight the particular features of older experiments and indicate new uses which could be made of them which extend beyond the objectives for which they originally established. Therefore, existing field experiments should not be abandoned but thorough consideration should be given to their potential use in future research. They are often increasing in value because the genotypic responses to varying environmental influences are accumulating over time. With regard to the establishment of new field experiments the present review provides some guidelines and aims to stimulate the motivation to continue with this research. Douglas fir and Norway spruce provenance trials in Serbia are a special type of plantation experiment that helps us understand how trees are adapted to different environmental conditions through genetic adaptation or phenotypic plasticity. The fact that the provenance origin is known and that the ecological parameters of the provenance test sites are researched makes the study results applicable in future establishment of special-purpose Douglas-fir and Norway spruce plantations in Serbia for the production of good-quality wood. By different silvicultural measures, it is possible to control and direct the dynamics of tree increment in artificially established populations, which is the base for the production of raw materials suitable for both wood processing industry and end users of wood products. O. K.

### **References**

- Isajev V., Tucović A (1992): Norway spruce provenance test on three localities near town of Ivanjica, Serbia. Performing project. Forestry faculty, Belgrade. P. 1-52
- Isajev, V., Tucović, A., Guzina, V., Orlović, S. (1997): Conservation and utilization of forest genetic resources in Yugoslavia. XI World Forestry Congress, 13-22. X , Antalya. Proceedings of the XI World Forestry Congress
- Isajev, V., Šijačić-Nikolić, M., Mataruga, M. i Ivetić, V. (2003): Conservation. Tasting and Utilisation of Tree Species Gene Pool in Specialized Plantations. Sustainable development of Agriculture and Environment Protection. Monograph. Megatrend – Univeristy of applied scinetices. Belgrade. P 235 – 247
- Ivetić V. (2004): Effect of sites and provenances on the development of juvenile plantations of spruce (*Picea abies* /L./ Karst) on Golija. M.Sc. thesis Library of the Faculty of Forestry, Beograd. 1-128
- Lavadinović, V. (1995): Variability of 29 Douglas fir provenances in test plantations in Serbia as base for development of the further introduction of this species. Master dissertation (manuscript) Forestry faculty Belgrade. P 1-155
- Lavadinović, V., Isajev, V., Koprivica, M. (1997): Variability of Douglas fir Height Depending on Geographic Characteristic of Autochthonous Sites in the Provenance Test in Serbia. The Third International Conference on the Development of Forestry and Wood Science/Technology, Proceedings, Vol. II, Belgrade, Yugoslavia: 43-49.
- Lavadinović, V., Isajev, V., Koprivica, M. (1998): Study of genofond of 29 provenances of green Douglas-fir basis of its wider distribution in Serbia. Eighteenth international Congress of Genetics, Book of the Abstracts No 8P 24. Beijing, China.



- Lavadinović, V., Isajev, V., Koprivica, M. (2001): Influence of provenances gene pool of Douglas-fir on height increment of trees in experimental test in East Serbia. *Acta Biologica Iugoslavia, Genetika Serija F*, Vol.33, No.1-2: 11 - 19, Belgrade
- Lavadinović, V., Isajev, V. (2003): Genetic diversity of Douglas-fir provenances in Serbia. International scientific conference, 75 Years of the research Institute, Bulgarian academy of sciences. Sofia, Bulgaria. *Proceedings of scientific papers*: 85-91
- Lavadinović, V., Isajev, V. (2005): Application of introduction as a method of tree breeding- the example of Douglas-fir (*Pseudotsuga menziesii* Mirb/Franco). Transilvania University of Brasov. ISBN 973- 635-622-1 Faculty of Silviculture and Forest Engineering. Romania: 73-79.
- Lavadinović, V.(2008): Genetic and ecological components of Douglas-fir (*Pseudotsuga menziesii* /Mirb./ Franco) variability in provenance test plantations in Serbia. Doctoral dissertation (manuscript) Forestry faculty Belgrade. P 1-194
- Lavadinovic V, Koprivica M. 1996. Development of young Douglas-fir stands of different provenances on beech sites in Serbia. Modelling regeneration success and early growth of forests stands. *Proceedings from the IUFRO Conference, held in Copenhagen, Denmark*. Editors: J.P. Skocsgaard & V.K. Johansen. Publisher : Ministry of Environment and Energy. Danish Forest and Landscape Research Institute. ISBN : 87-89822-59-5. Pp. 390–400.
- Lavadinovic V, Koprivica M. 1999. Development of young Douglas-fir stands of different provenances on oak site in Serbia. *Empirical and Process-Based Models for Forest tree and Stand Growth Simulation.*, Editors: Ana Amaro & Margarita Tome. Publisher : Edicoes Salamandra, LDA Lisboa, Portugal. ISBN: 972-689-154-X. Deposito legal: 139925/99. Pp 231–242

## THE SELENIUM CONTENT OF AMANITA SPECIES FROM SAMANLI MOUNTAIN OF MARMARA REGION (TURKEY)

Murad Aydın ŞANDA<sup>1\*</sup>, Hasan Hüseyin DOĞAN<sup>2</sup>

<sup>1</sup>Department of Molecular Biology and Genetic, Science and Art Faculty, Muş Alparslan University, Muş, Turkey

<sup>2</sup>Department of Biology, Science Faculty, Selcuk University, Konya, Turkey

\*Corresponding author: muradsanda@gmail.com, murad.sanda@igdir.edu.tr

### Abstract

Selenium contents were analysed in eleven wild Amanita taxa: *A. caesarea* (Scop.) Pers., *A. excelsa* (Fr.) Bertill., *A. franchetii* (Boud.) Fayod, *A. gemmata* (Fr.) Bertill., *A. mairei* Foley, *A. muscaria* (L.) Lam., *A. pantherina* (DC.) Krombh., *A. phalloides* (Fr.) Link, *A. rubescens* Pers., *A. vaginata* (Bull.) Lam. and *A. verna* (Bull.) Lam. from Marmara region of Turkey by ICP-AES equipment. The common forest vegetation types in the research area are *Fagus orientalis*, *Carpinus betulus*, *Castanea sativa*, *Abies nordmanniana* subsp. *bornmulleriana*, *Pinus sylvestris*, *Pinus maritima* (cultivated) and *Quercus* sp. communities. Selenium uptake were observed reaching different levels ( from 0.1 to 11.5 ) in Amanita species in order to demonstrate possible spatial variations in Se composition of Amanita species by using multivariate analysis [cluster (CA)]. Selenium levels were determined as 0.1-1.10 mg.kg<sup>-1</sup> (*A. citrina*), 0.1-2.20 mg.kg<sup>-1</sup> (*A. gemmata*), 0.10-3.80 mg.kg<sup>-1</sup> (*A. muscaria*), 0.30-3.80 mg.kg<sup>-1</sup> (*A. excelsa*), 0.20-11.50 mg.kg<sup>-1</sup> (*A. rubescens*), 1.10-2.70 mg.kg<sup>-1</sup> (*A. caesarea*), 1.60-4.40 mg.kg<sup>-1</sup> (*A. mairei*), 0.30-0.90 mg.kg<sup>-1</sup> (*A. phalloides*), 0.70-2.50 mg.kg<sup>-1</sup> (*A. vaginata*), 0.20 mg.kg<sup>-1</sup> (*A. pantherina*), 3.70 mg.kg<sup>-1</sup> (*A. franchetii*) and 3.20 mg.kg<sup>-1</sup> (*A. verna*). The highest Se concentrations were determined at 11.5 mg.kg<sup>-1</sup> in *A. rubescens*

**Keywords:** Se, Amanita, Mushroom, Turkey

### Introduction

Many macrofungal species (mushrooms) have been used both for human's food and treatments of some diseases as well as for some different ethnobotanical purposes for centuries. They can be divided in two groups; first is a wild-growing group of fungi, from nature and the second is a group of cultivated mushrooms. Furthermore, according to their nutritional values, macrofungi can be grouped as poisonous, edible or inedible if they cause many types of poisoning affecting on the lungs, liver, stomach, kidney and central nervous system (Seeger and Stijve, 1980). Macrofungi contain the highest amount of water (approx. 92%) but also vitamins and mineral substances important for human health., 8% of fresh mushrooms in the remaining dry weight (d.w.) formed from the ash contains protein, fat, carbohydrate, vitamins, calcium, phosphorus, potassium, iron, copper, and fibre (Matilla et al., 2002). Since mushrooms are rich in mineral resources some minerals found in macrofungi can be used to treat people with mineral deficiencies (Nakalambe et al., 2015). Minerals can be grouped as macroelements (calcium, phosphorus, potassium, sulphur, chlorine, sodium, and magnesium) and microelements (iron, manganese, cobalt, copper, zinc, molybdenum, vanadium, chromium, tin, fluorine, silicon, selenium and iodine (non-metal)). Some authors have reviewed data about the heavy metal concentration in mushrooms and presented few data for the genus Amanita (Rudawska and Leski, 2005; Michelot and Siobud, 1998; Demirbaş, 2001; Falandysz et al., 2008; Kalać, 2010) wholesome reports concerning the

selenium contents of mushrooms are also available (Michelot and Siobud, 1998; Cocchia et al., 2006; Tüzen et al., 2007; Falandysz, 2008). *A. caesarea* and *A. excelsa* are consumed by local people and they are expressed to be very delicious. Selenium, an essential trace mineral, has fundamental importance to human's health. As a constituent of selenoproteins, selenium has structural and enzymes roles, in the latter context being best-known as an antioxidant and catalyst for the production of active thyroid hormone (ref). Selenium is needed for the proper functioning of the immune system, and appears to be a key nutrient in counteracting the development of virulence and inhibiting HIV progression to AIDS (ref). It is required for sperm motility and may reduce the risk of miscarriage. Deficiency has been linked to adverse mood states. Findings have been equivocal in linking selenium to cardiovascular disease risk although other conditions involving oxidative stress and inflammation have shown benefits of a higher selenium status (Rayman, 2000). Selenoproteins have a role in maintaining redox balance, other functions are becoming increasingly recognized. As the roles of these selenoproteins are further characterized, a better understanding of the true physiological significance of this trace element will arise. This knowledge will be essential in defining optimum intakes to achieve cellular homeostasis in order to optimize health, including a reduction in cancer, for diverse populations (Davis et al., 2012). Due to the lack of studies concerning the content of selenium in the genus *Amanita* from Turkey, it is intended within this research to reveal the selenium content of 11 different species of *Amanita*. For this purposes 3 edible species (*A. caesarea*, *A. rubescens*, *A. vaginata*), 3 inedible species (*A. excelsa*, *A. franchetii*, *A. mairei*) and 5 poisonous species (*A. gemmata*, *A. muscaria*, *A. pantherina*, *A. phalloides*, *A. verna*) were selected. Selenium quantities were compared between edible, inedible and poisonous species.

### Materials and Methods

Marmara region is located in northwest side of Turkey. Collection and identification of *Amanita* samples were collected from the nature and their collected localities, habitat are given Figure 1 and Table 1.

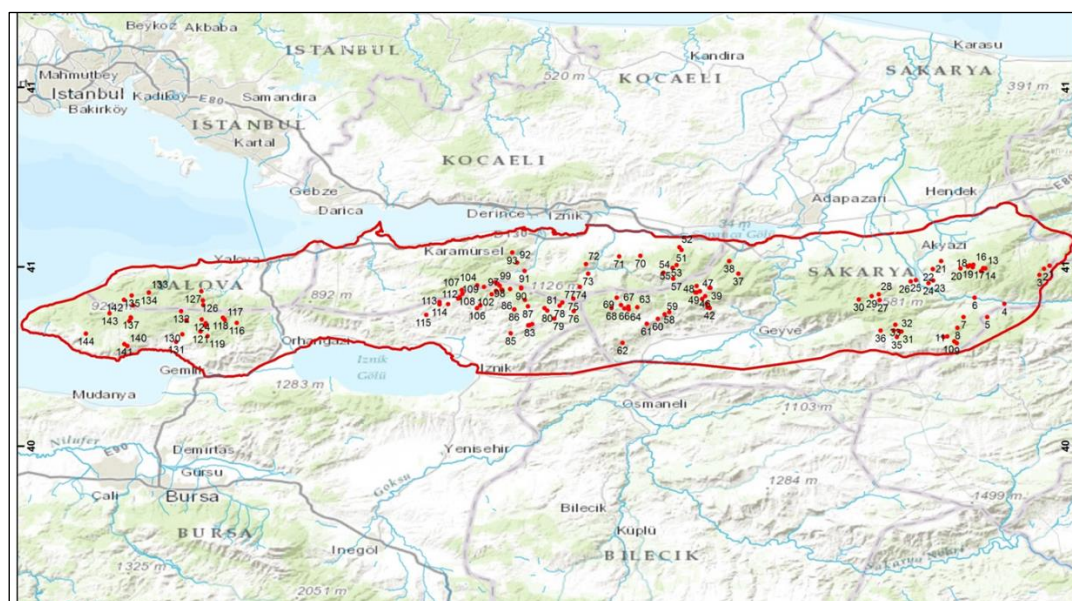


Figure 1. The sampling localities of *Amanita* taxa in the map.

For the identification of samples, the habitat and morphological characteristics of the mushrooms in the localities were noted and photographed, and then samples were placed in

separate wicker containers to avoid mixing. The spore prints of mushroom samples were obtained and spore measurements were determined in the laboratory by using reference books (Moser 1983; Breitenbach and Kränzlin 2000). A voucher sample for each identified and dried material was kept at Selcuk University, Mushroom Application and Research Centre, Konya/Turkey. Dried and ground mushroom samples are digested in 1:1:1 aqua regia then analyzed by inductively coupled plasma-mass spectrometry (ICP-MS) ICP-ES/MS (AQ200) equipment of Bureau Veritas Element Company (Ankara and Canada). Cluster analysis of Selenium uptake in *Amanita* species obtained by Statistica 8.0 software were done to make a chemo taxonomical group along with morphological and anatomical identification.

Table 1. Data of the collecting sites.

Taxon	Province	District	Location	Habit	Coordinate	Altitude
<i>Amanita caesarea</i>	Bursa	Fevziye	Karagöl	<i>P. nigra</i> , <i>Fagus</i> , <i>Quercus</i> ,	40°21'04N- 029°18'26E	776
<i>Amanita citrina</i>	Yalova	Armutlu	Delmece plateau	<i>Fagus</i> , <i>Abies</i> ,	Not data	700
<i>Amanita citrina</i>	Sakarya	Geyve	Kaymakam fountain	<i>Fagus</i> , <i>Abies</i> ,	40°31'05N- 030°32'38E	980
<i>Amanita excelsa</i>	Yalova	Çınarcık	Teşvikiye	<i>Fagus</i> , <i>Quercus</i> ,	40°35'25N- 029°00'21E	595
<i>Amanita excelsa</i>	Yalova	Çınarcık	Teşvikiye	<i>Fagus</i> , <i>Quercus</i> ,	40°35'25N- 029°00'21E	595
<i>Amanita franchetii</i>	Yalova	Çınarcık	Delmece gientry	<i>Fagus</i> , <i>P. nigra</i> ,	Not data	
<i>Amanita gemmata</i>	Sakarya	Akyazı	Avcıçimeni	<i>Abies</i> ,	40°31'02N- 030°34'12E	1250
<i>Amanita gemmata</i>	Sakarya	Akyazı	Durmuşlar top quarry	<i>Fagus</i> , <i>Carpinus</i> ,	Not data	
<i>Amanita gemmata</i>	Sakarya	Akyazı	Keremali	<i>Pinus</i> ,	Not data	
<i>Amanita gemmata</i>	Sakarya	Akyazı	over forest home	<i>Fagus</i>	Not data	
<i>Amanita gemmata</i>	Sakarya	Akyazı	over forest home	<i>Fagus</i>	Not data	
<i>Amanita gemmata</i>	Sakarya	Akyazı	Soğuksu, where beekeepers	<i>Abies</i> ,	Not data	
<i>Amanita gemmata</i>	Sakarya	Geyve	Taraklı Karagöl plateauMahdumlar village	<i>Abies</i> , <i>Carpinus</i> , <i>Fagus</i> , <i>Buxus</i> ,	40°30'17N- 030°34'39E	1150
<i>Amanita gemmata</i>	Kocaeli	Gölcük	on the way of Eriklitepe	<i>Fagus</i> ,	40°36'08N- 029°45'55E	970
<i>Amanita gemmata</i>	Sakarya	Sapanca	Soğucak	<i>Carpinus</i> ,	40°36'20N- 030°11'41E	1190
<i>Amanita gemmata</i>	Bursa	Uludağ	Kirazlıyayla	<i>Abies</i> , <i>Fagus</i> ,	Not data	
<i>Amanita mairei</i>	Yalova	Çınarcık	Haydariye	<i>Quercus</i> ,	Not data	
<i>Amanita mairei</i>	Bursa	Fevziye	down of Karagöl	<i>Fagus</i> , <i>Quercus</i> ,	40°26'46N- 029°18'09E	796
<i>Amanita muscaria</i>	Sakarya	Akyazı	Eskioba	<i>Abies</i> , <i>Fagus</i> , <i>Quercus</i> ,	40°31'49N- 030°34'26E	1200
<i>Amanita muscaria</i>	Sakarya	Akyazı	Isırganlık	<i>Abies</i> ,	40°39'11N- 030°44'04E	1200
<i>Amanita muscaria</i>	Sakarya	Akyazı	Soğuksu	<i>Abies</i> ,		
<i>Amanita muscaria</i>	Sakarya	Akyazı	Yılanlıkaya	<i>Abies</i> , <i>Fagus</i> , <i>Quercus</i> ,	40°30'59N- 030°35'12E	1260
<i>Amanita muscaria</i>	Sakarya	Akyazı	Yılanlıkaya	<i>Abies</i> , <i>Fagus</i> , <i>Quercus</i> ,	40°30'59N030°35'12E	1260
<i>Amanita muscaria</i>	Kocaeli	Maşukiye	Against of Sislivadi	<i>Abies</i> , <i>Fagus</i> ,	40°39'14N- 030°07'45E	1200
<i>Amanita muscaria</i>	Kocaeli	Yuvacık	İnönü plateau	<i>Abies</i> , <i>Fagus</i> ,	40°33'50N- 029°59'29E	1130
<i>Amanita muscaria</i>	Kocaeli	Yuvacık	İnönü plateau	<i>Abies</i> , <i>Fagus</i> ,	40°33'50N- 029°59'29E	1130
<i>Amanita muscaria</i>	Kocaeli	Yuvacık	İnönü plateau	<i>Abies</i> , <i>Fagus</i> ,	40°33'50N- 029°59'29E	1130
<i>Amanita muscaria</i>	Kocaeli	Yuvacık	İnönü plateau	<i>Abies</i> , <i>Fagus</i> ,	40°33'50N- 029°59'29E	1130
<i>Amanita muscaria</i>	Sakarya	Akyazı	Yeniköy	<i>Abies fazla</i> , <i>Fagus fazla</i> ,	40°39'10N- 030°43'38E	972
<i>Amanita pantherina</i>	Sakarya	Pamukova	Soğucak		40°33'18N- 030°11'02E	1000
<i>Amanita phalloides</i>	Yalova	Çınarcık	Teşvikiye	<i>Fagus</i> ,	40°35'25N-	595

<i>Amanita phalloides</i>	Yalova	Çınarcık	Teşvikiye	<i>Quercus</i> , <i>Fagus</i> ,	029°00'21E 40°35'25N-	595
<i>Amanita rubescens</i>	Sakarya	Akyazı	Yeniköy	<i>Quercus</i> , <i>Abies fazla</i> , <i>Fagus fazla</i> ,	029°00'21E 40°39'10N- 030°43'38E	972
<i>Amanita rubescens</i>	Yalova	Çınarcık	Delmece	<i>Fagus</i> , <i>P.</i> <i>nigra</i> ,	Not data	
<i>Amanita rubescens</i>	Bursa	Gemlik	Haydariye	<i>Fagus</i> , <i>Carpinus</i> ,	40°32'27N- 029°08'59E	470
<i>Amanita rubescens</i>	Bursa	Gemlik	Haydariye	<i>Fagus</i> , <i>Carpinus</i> ,	40°32'27N- 029°08'59E	470
<i>Amanita vaginata</i>	Sakarya	Geyve	Kaymakam fountain	<i>Fagus</i> , <i>Abies</i> ,	40°31'05N- 030°32'38E	980
<i>Amanita vaginata</i>	Sakarya	Geyve	Kaymakam fountain	<i>Fagus</i> , <i>Abies</i> ,	40°31'05N- 030°32'38E	980
<i>Amanita vaginata</i>	Kocaeli	İhsaniye	Kurtlar valley	<i>Quercus</i> , <i>Fagus</i> ,	40°38'25N- 029°48'46E	250
<i>Amanita verna</i>	Yalova	Çınarcık	Teşvikiye	<i>Fagus</i> , <i>Quercus</i> ,	40°35'25N- 029°00'21E	595

## Results and Discussion

Selenium content of *Amanita* species are given in Table 2. The reported Se contents of *Amanita* species in the literature are given in Table 3. The Cluster Analysis was presented in Figure 2. The Se contents for the studied species vary between 0.1 mg.kg<sup>-1</sup> in *A. citrina* and 11.50 mg.kg<sup>-1</sup> in *A. rubescens*. The ranking among taxa according to Se absorption of the species were as follows: as 0.1-1.10 mg.kg<sup>-1</sup> (*A. citrina*), 0.1-2.20 mg.kg<sup>-1</sup> (*A. gemmata*), 0.10-3.80 mg.kg<sup>-1</sup> (*A. muscaria*), 0.30-3.80 mg.kg<sup>-1</sup> (*A. excelsa*), 0.20-11.50 mg.kg<sup>-1</sup> (*A. rubescens*), 1.10-2.70 mg.kg<sup>-1</sup> (*A. caesarea*), 1.60-4.40 mg.kg<sup>-1</sup> (*A. mairei*), 0.30-0.90 mg.kg<sup>-1</sup> (*A. phalloides*), 0.70-2.50 mg.kg<sup>-1</sup> (*A. vaginata*), 0.20 mg.kg<sup>-1</sup> (*A. pantherina*), 3.70 mg.kg<sup>-1</sup> (*A. franchetii*) and 3.20 mg.kg<sup>-1</sup> (*A. verna*) (Table 2). The minimum and maximum Se uptake levels for edible fungi inedible fungi were between 0.2-11.50 mg.kg<sup>-1</sup> in *A. rubescens*, for were 1.60-4.40 mg.kg<sup>-1</sup> in *A. mairei* and for poisonous fungi were 0.1-6.30 mg.kg<sup>-1</sup> in *A. muscaria*. According to the obtained results, the ratio of Se was observed more frequently in edible fungi. The Se contents were reported 0.2-48.5 mg.kg<sup>-1</sup> 48.5 mg.kg<sup>-1</sup> in *Amanita muscaria* by Michelot et al., 1998 (Table 3). In our study, Se level was detected 0.1 to 6.3 mg.kg<sup>-1</sup> in *A. muscaria*. Since *Amanita* taxa can not be classified systematically according to Se contents obtained by Cluster analysis, we assume that they do not have any features for chemo taxonomically sight although some groups were divides in cluster analysis (*A muscaria* group, *A gemmata*, *A vaginata* )

Table 2. The Se content of *Amanita* taxa in different localities of research area.

No	Taxa	Edible/In-edible	Se (mg/kg)
63	<i>Amanita caesarea</i>	Edible	1.1
230	<i>Amanita caesarea</i>	Edible	2.7
38	<i>Amanita excelsa</i>	Edible	0.8
86	<i>Amanita excelsa</i>	Edible	3.3
<b>68</b>	<b><i>Amanita citrina</i></b>	<b>In-edible</b>	<b>0.1</b>
73	<i>Amanita citrina</i>	In-edible	1.1
82	<i>Amanita franchetii</i>	In-edible	3.7
61	<i>Amanita gemmata</i>	Poisonous	0.1
28	<i>Amanita gemmata</i>	Poisonous	0.3
41	<i>Amanita gemmata</i>	Poisonous	0.4
80	<i>Amanita gemmata</i>	Poisonous	0.4
62	<i>Amanita gemmata</i>	Poisonous	0.5
14	<i>Amanita gemmata</i>	Poisonous	0.7
85	<i>Amanita gemmata</i>	Poisonous	1.1
10	<i>Amanita gemmata</i>	Poisonous	1.2
111	<i>Amanita gemmata</i>	Poisonous	2.2
99	<i>Amanita gemmata</i>	Poisonous	2.2
150	<i>Amanita mairei</i>	In-edible	4.4
250	<i>Amanita mairei</i>	In-edible	1.6
<b>243</b>	<b><i>Amanita muscaria</i></b>	<b>Poisonous</b>	<b>0.1</b>
72	<i>Amanita muscaria</i>	Poisonous	0.2

189	<i>Amanita muscaria</i>	Poisonous	0.3
57	<i>Amanita muscaria</i>	Poisonous	3.1
30	<i>Amanita muscaria</i>	Poisonous	3.2
258	<i>Amanita muscaria</i>	Poisonous	2.3
67	<i>Amanita muscaria</i>	Poisonous	4.3
34	<i>Amanita muscaria</i>	Poisonous	6.3
151	<i>Amanita muscaria</i>	Poisonous	3.6
147	<i>Amanita muscaria</i>	Poisonous	2.7
7	<i>Amanita muscaria</i>	Poisonous	3.8
136	<i>Amanita pantherina</i>	Poisonous	0.2
110	<i>Amanita phalloides</i>	Poisonous	0.3
92	<i>Amanita phalloides</i>	Poisonous	0.9
170	<i>Amanita rubescens</i>	Edible	0.2
201	<i>Amanita rubescens</i>	Edible	0.3
103	<i>Amanita rubescens</i>	Edible	0.5
<b>100</b>	<b><i>Amanita rubescens</i></b>	<b>Edible</b>	<b>11.5</b>
53	<i>Amanita vaginata</i>	Edible	0.7
224	<i>Amanita vaginata</i>	Edible	2.1
89	<i>Amanita vaginata</i>	Edible	2.5
54	<i>Amanita verna</i>	Poisonous	3.2

Table 3. The Se content of *Amanita* taxa from the literature

Taxa	Se content (mg/kg)	References
<i>Amanita ampla</i>	28.1	Michelot et al. (1998)
<i>Amanita caesarea</i>	3.3	Cocchia et al. (2006)
<i>Amanita gemmata</i>	20.8	Michelot et al. (1998)
<i>Amanita muscaria</i>	0.85	Tüzen et al. (2007)
<i>Amanita muscaria</i>	4.6	Falandysz et al. (2008)
<b><i>Amanita muscaria</i></b>	<b>48.5</b>	Michelot et al. (1998)
<i>Amanita ovoidea</i>	37.8	Michelot et al. (1998)
<i>Amanita ovoidea</i>	1.82	Cocchia et al. (2006)
<i>Amanita pantherina</i>	10.8	Tüzen et al. (2007)
<i>Amanita pantherina</i>	38.8	Michelot et al. (1998)
<i>Amanita phalloides</i>	19.9	Michelot et al. (1998)
<i>Amanita rubescens</i>	34.4	Michelot et al. (1998)
<i>Amanita rubescens</i>	0.2	Cocchia et al. (2006)
<i>Amanita solitaria</i>	33.2	Michelot et al. (1998)
<i>Amanita spissa</i>	36.9	Michelot et al. (1998)
<i>Amanita strobiliformis</i>	37	Falandysz (2008)
<i>Amanita vaginata</i>	33.3	Michelot et al. (1998)
<i>Amanita vaginata</i>	2	Cocchia et al. (2006)

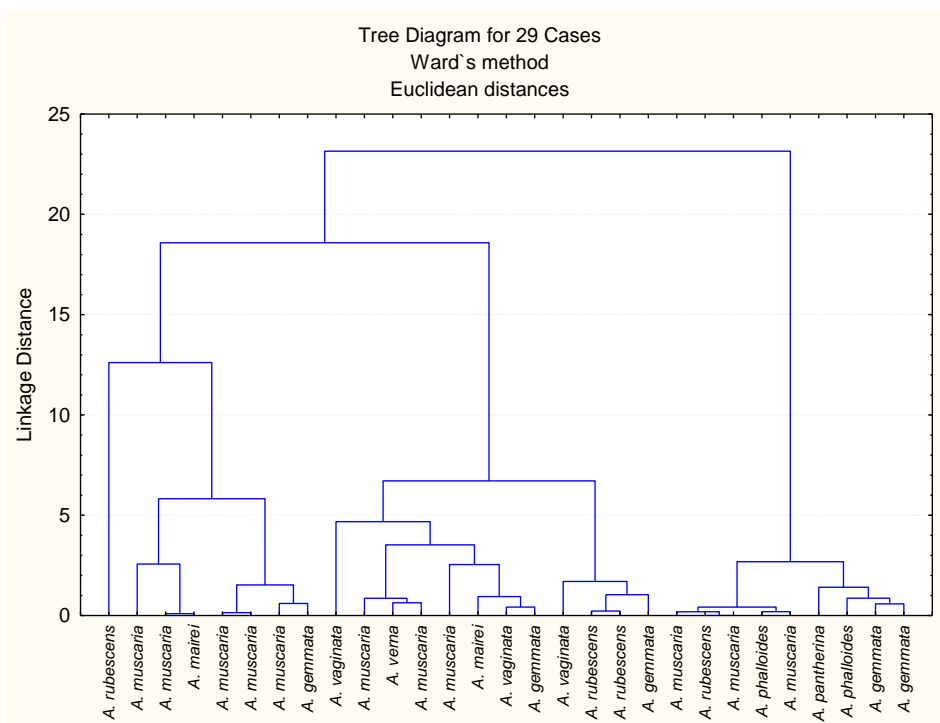


Figure 2. The Cluster Analysis of Se content of *Amanita* taxa.

## Conclusion

Edible *Amanita* taxa, especially *A. rubescens* may become important in the diet as a possible source of Selenium. Poisonous or inedible *Amanita* mushrooms should not be consumed as food although they contain

According to our results, *Amanita* taxa cannot be classified for Selenium content.

## Acknowledgements

This research was financially supported by Selçuk University Scientific Research Projects Coordinating Office (SÜ-BAP-13401072) and TÜBİTAK (TBAG-112T136). We would like to thank the Selçuk University and TÜBİTAK for the financial support.

## References

- Breitenbach, J. and Kränzlin, F. (2000). Fungi of Switzerland (volume 5), Verlag Mykologia, Luzern, Switzerland. pp: 338.
- Cocchia, L., Vescovi, L., Petrini, L. E., Petrini, O. (2006). Heavy metals in edible mushrooms in Italy, Food Chemistry, 98, 277-284.
- Davis, C.D., Tsuji, P. A., Milner J. A. (2012). Seleproteins and cancer prevention, Annual Review of Nutrition, 32:73-95.
- Demirbaş, A. (2001). Concentrations of 21 metals in 18 species of mushrooms growing in the East Black Sea region, Food Chemistry, 75, 453-457.
- Falandysz, J. (2008). Selenium in Edible Mushrooms, Journal of Environmental Science and Health, 26C (3), 256-299.
- Kalać, P. (2010). Trace element contents in European species of wild growing edible mushrooms: A review for the period 2000–2009, Food Chemistry, 122, 2–15.
- Matilla P., Salo-vaananen P., Könkö K., Aro H., Jalava T. (2002). “Basic composition and amino acid contents of mushrooms cultivated in Finland”, Journal of Agricultural and Food Chemistry, 50 (22), 6419–6422.
- Michelot, D., Siobud, E., Doré, J.C., Viel, C., Poirer, F. (1998). Update on metal content profiles in mushrooms - Toxicological implications and tentative approach to the mechanisms of bioaccumulation, Toxicon, 36 (12), 1997-2012.
- Moser, M. (1983). Keys to Agarics and Boleti. Gustav Fischer Verlag, Stuttgart, pp: 535.
- Nakalembe, I., Kabasa, J.D., Olila, D. (2015). Comparative nutrient composition of selected wild edible mushrooms from two agro-ecological zones, Uganda, SpringerPlus, 4, 433, 1-15. (DOI 10.1186/s40064-015-1188-z)
- Rayman, P.M. (2000). The importance of selenium to human health, Lancet, 356, 9225, 233-241.
- Rudawska, M., Leski, T. (2005). Trace elements in fruiting bodies of ectomycorrhizal fungi growing in Scots pine (*Pinus sylvestris* L.) stands in Poland, Science of the Total Environment, 339, 103-115.
- Seeger, R., Stijve, T. (1980). Occurrence of Toxic *Amanita* Species. *Amanita* Toxins and Poisoning Editör: Faulstich H., Kommerell B., Wieland, New York.
- Tuzen, M., Sesli, E., Soylak, M. (2007). Trace element levels of mushroom species from East Black Sea Region of Turkey, Food Chemistry, 18, 806-810.

## RELATIONS BETWEEN LEAVE'S BIOMETRICAL CHARACTERISTICS AND VITALITY OF NORWAY SPRUCE (PICEA ABIES KARST.) UNDERGROWTH

Marko GUTALJ<sup>1</sup>, A.V. GRYAZKIN<sup>2</sup>, N.V. BELYAEVA<sup>2</sup>, I.A. KAZI<sup>2</sup>

<sup>1</sup>University of East Sarajevo, VukaKaradzica 30, Lukavica 71123 Republic of Srpska, Bosnia and Herzegovina

<sup>2</sup>Federal State Budgetary Educational Institution of Higher Education «Saint-Petersburg State Forest Technical University», Institutsky per. 5, St. Petersburg, Russia

\*Corresponding author: gotalj@yahoo.com

### Abstract

In this research, special attention was focused on the correlation between biometric parameters of Norway spruce undergrowth's assimilation apparatus and the life viability of undergrowth. Biometrical parameters, such as mass, length and relative mass of spruce needles can be indicator of undergrowth's capability to change life viability category. Our study shows that positive transition of spruce undergrowth from category of "non-viable" to category of "viable" is mostly related with gradual changes of light conditions after non-clear cuts. All researches were conducted in Leningrad region which refers to the transition zone from the middle to southern boreal forests. There were selected objects with relatively heterogenic soil conditions, but related to same forest type (forest typology by Sukachev, 1961). This study was focused on biometrical characteristics of assimilation apparatus (measuring of average length and weight of needles with their pre-drying) of marked samples of spruce undergrowth before and after decreasing of stand completeness (after shelterwood cuts). Other needles parameters, such as specific weight and the lateral surface area, were defined analytically.

**Keywords:** *assimilation apparatus, Norway spruce undergrowth, vitality of undergrowth, light-conditions, stand completeness.*

### Introduction

Assimilation apparatus is the basis of all physiological processes in plants. Therefore it is necessary to study in more detail the connection of the structure of this assimilation apparatus with viable undergrowth.

It has long been considered that the assimilation apparatus of representatives of one specie is morphologically different for the others not only depending on site conditions, but also depending on the position it has in the crown of the tree. (Maksimov, 1971; Alekseev, 1975; Yakushev, 1994; Gryazkin, 1999, 2001). The main reason for this is the different intensity of photosynthetically active radiation and a special microclimate.

It is well known that the regime of solar radiation and the efficiency of its use by plants depends on the he characteristics of the forest ecosystem itself. (Alexeev, 1975; Yakushev, 1994; Gryazkin, 1999). This study gives special attention to the connection of biometric characteristics of needles (*Picea abies* Karst.) with the life condition of spruce. These characteristics (in particular its abilities to adapt to changes of site conditions) are indirect confirmation of spruce's undergrowth ability to change its life viability in positive direction (especially with gradual changes of light conditions).

The objects of the study were three forestry enterprises in Leningrad region (North-West of Russia - the transition zone from the middle to southern boreal forest) with relatively large



differences in soil conditions, however all of the objects belong to the «Piceetum oxalidosum» type of forests.

### Materials and methods

The Lisinsky forest enterprise is characterized by heavy loamy soil with the formations of wetlands micro-depressions. Kartashevsky forest enterprise, which is located on the Silurian plateau, is characterized by well-drained fertile sandy soil. Roshinsky forest enterprise is characterized by the domination of sandy soils. Out of the total sample studied, the Kartashevsky forest enterprise is represented by 35 samples, Lisinsky by 45, and Roshinsky by 18 samples. Lisinsky samples of spruce undergrowth were marked before the non-clear cut was made. This fact allowed us to understand the connection between the dynamic of biometric characteristics in spruce needles, and changes of light conditions under the canopy. The distinguishment was made between three categories by the spruce undergrowth height (<0.5 m - small; 0,51-1,50 m - medium;> 1.50 m - large), and three categories of life viability (viable; unviable; dry).

To study the assimilation apparatus of spruce, its qualitative and quantitative indicators, the following indicators were measured: length and weight of 100 needles with pre-drying of needles until air drought was reached. Out of every model sample (which belonged to different categories of height and of life viability), a needled branch was taken. From every sample (by same height and life viability category), the branches of the same height level and cardinal directions were measured. After that, each branch was subdivided into annual shoots, and from these shoots needles were selected for further laboratory studies (minimum three samples of hundred needles each). After this, other relative indicator were analytically determined: specific weight (the weight ratio of 100 pieces of needles to their total length) and the lateral surface area of the needles (Gryazkin, 1999, 2001). All these biometrical indicators of assimilation apparatus were statistically analysed.

### Results and discussion

The analysis of average indicators length, mass and specific weight of all needle samples, regardless of the category of height and viability, has shown that all biometric indicators of spruce undergrowth, growing under the canopy of the parent stands, are increasing with the relative decrease of completeness of the stand.

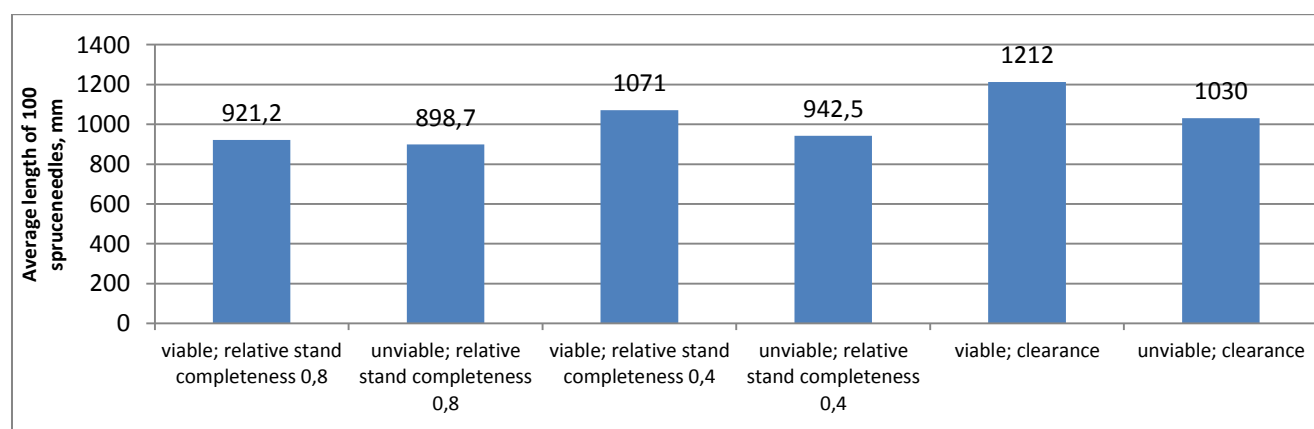


Figure 1 - Changes in the average length of the needles of spruce undergrowth, with different relative completeness of stand and life viability of undergrowth (Lisino forest enterprise)

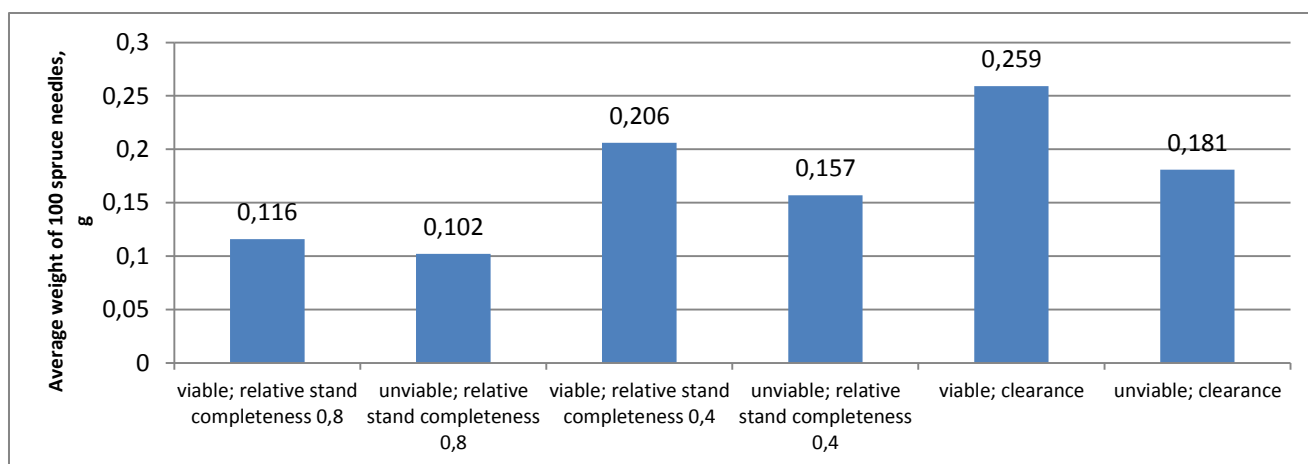


Figure 2 - Changes in the average weight of the needles of spruce undergrowth, with different relative completeness of stand and life viability of undergrowth (Lisino forest enterprise)

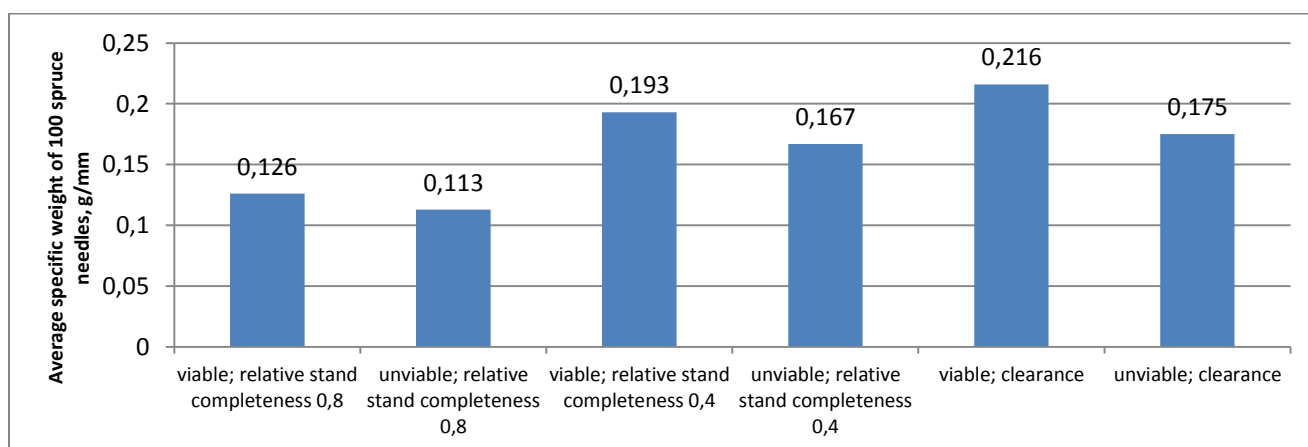


Figure 3 - Changes in the average specific weight of the needles of spruce undergrowth, with different relative completeness of stand and life viability of undergrowth (Lisino forest enterprise)

The most stable indicator, which describes the efficiency of photosynthetic apparatus in specific site conditions, is specific weight. The value of this parameter indicates that the fastest growing spruce undergrowth is located in cleared areas (if it appeared after cutting), and then gradually decreases, as the completeness of stands rises (see figure 3).

The specific weight is also a stable indicator of spruce undergrowth life viability. It is found that the greater the average value of the specific weight of the needles, the better is the life viability of regrowth in general.

The research of biometric parameters of spruce was directed to finding the correlation of its dynamics, depending on the life viability of spruce undergrowth. It was found that the average length, mass and specific weight of needles is, as a general rule, lower in unviable than in viable spruce undergrowth.

Table 1 presents data on the biometric characteristics of the average height of needles, under the canopy of spruce grove with completeness of 0.5 (Lisinski forestry).

Table 1. Average value of spruce needle's biometric characteristics (height of samples 0,5-1,5 m)

Categories of life viability and height	Average length of 100 needles ( $l_{100}$ ), mm	Average weight of 100 needles ( $m_{100}$ ), g	Average specific weight of 100 needles, $g/cm^3 \cdot 10^3$
Viable spruce undergrowth (0.51-1.51 m)	1068±74.2	0.166±0.011	0.151±0.009
Viable spruce undergrowth (0.51-1.51 m)	879±81.1	0.103±0.013	0.120±0.010

The specific weight of needles in unviable undergrowth, when the relative completeness of stand is 0.5 is higher than the specific weight of needles in viable undergrowth that has relative completeness of stands of 0.8.

The research done by Z.M. Neumenko (1962) showed that the effect of clear-cuttings (in the «piceetum myrtillosum / oxalidosum» type of forest – completeness of stands 0,7-0,9) is that the spruce undergrowth that that is left over mostly died. The reason of that is the inability of assimilation apparatus to adapt to dramatically changed light conditions. However, the measurement of biometric parameters of marked samples of spruce in Lisinsky forest enterprise until and after the gradual cut (in which the completeness of stands decreases by few units) has shown that with the improvement of light conditions, many od unviable spruce undergrowths have become viable.

Comparison of biometric parameters of spruce needles in three forest areas (Lisinskoe, Roshinsky and Kartashevskii) was carried out by the average values for all categories of size and viability.

All biometric parameters (length, weight and specific weight of needles) have the highest rates in Lisinsky forest enterprise, and the lowest in Kartashevskii forest enterprise (in which the full grown spruces are the most productive) (Table 2).

Table 2. Compare of average values of biometric characteristic of spruce undergrowth needles in three different forest enterprises; \*relative completeness of stand 0,7-0,8; \*«Piceetum oxalidosum» type of forests

Average value	Kartashevski forest enterprise		Roshinski forest enterprise		Lisinski forest enterprise	
	Viable	Unviable	Viable	Unviable	Viable	Unviable
Length of 100 needles, mm	815,0±72,1	763,9±79,5	894,3±62,9	847,9±67,4	921,2±84,2	898,7±86,1
Weight of 100 needles, g	0,072±0,008	0,061±0,011	0,087±0,012	0,074±0,015	0,116±0,017	0,102±0,021
Specific weight, $g/cm^3 \cdot 10^3$	0,087±0,003	0,079±0,005	0,096±0,008	0,087±0,008	0,126±0,007	0,113±0,008

Environmental conditions the Lisinski forest enterprise are in the best accordance with the needs of spruce undergrowth. The specificity of Lisinski forest enterprise microclimate and soil conditions are allowing for spruce undergrowth to better show their competitive abilities. This is reflected in the development of the assimilation apparatus undergrowth. In the Kartashevskii and Roshinsky forest enterprises, environmental conditions are accompanied by great biological diversity, hence, the sharper competitive relationships, in which the development of spruce undergrowth is hindered, especially in early stages of its life.

### Conclusion

Specific weight is the most meaningful measure of the activity of development of assimilation apparatus, reflecting differences in environmental conditions. This indicator differs slightly

for the undergrowth in clearings and those under the canopy of low-density stands (relative completeness of stands of 0.4). This leads to the conclusion that the relative completeness of stands of 0,4 is close to ideal for the growth and development of the assimilation apparatus of spruce undergrowth, in other words for the formation of viable spruce undergrowth.

Specific weight is a stable indicator of spruce undergrowth life viability in general. The higher the average value of the specific weight of the needles is, the better is the life viability of the undergrowth.

The average length, weight and specific weight of needles of unviable spruce undergrowth is, as a general rule, lower than those indicators of viable undergrowth, regardless of its height.

All main biometric parameters have the highest value in Lisinsky forest enterprise, and the lowest in Kartashevsky forest enterprise. Consequently, spruce undergrowth best shows its competitive ability on heavy loam soils.

### **References**

- Alekseev, V. A Light condition of forests / V.A. Alekseev – Leningrad. : Science,1975 .- 227 p.
- Grjazkin, A.V. The influence of thinning cuts on the natural regeneration / A.V. Gryazkin // Forest. Science. Youth. - Gomel, 1999. - T. 1. - P. 193-195.
- Grjazkin, A.V. Renewing potential of boreal forests (on example of spruce forests in the North-West of Russia): monograph / A.V. Grjazkin. - St. Petersburg.: SPb FTA, 2001. - 188 p.
- Maximov, V.E. Physiological specific of Norway spruce undergrowth after shelter-wood and clear cuts/ V.E. Maximov // Forestry, 1971. – №1. – P. 84-88.
- Sukachev, V.N. Methodical instruction for forest types researches. /V.N. Sukachev – M. :AS SSSR, 1961.- 144 p.
- Yakushev, T.V. Growth dynamic of spruce young generation under the different stands and on clearances/ T.V. Yakushev, E.N. Kuznecov, A.B. Grjazkin // Forest Journal, 1994. – №2. – P. 24-28.
- Naumenko Z.M. Life viability of spruce undergrowth on clearances. (Ecological and biological thesis) / Z.M. Naumenko. – Leningrad; Magadan., 1962. - 36 p.

## ECOLOGICAL FACTORS AND CONDITION OF FORESTS ACROSS THE AREA OF MOUNTAIN TREBEVIĆ IN REPUBLIC OF SRPSKA (BOSNIA AND HERZEGOVINA)

Sinisa CINCAR<sup>1\*</sup>, Aleksandar TEPAVAC<sup>2</sup>, Nevena KUSMUK<sup>3</sup>

<sup>1</sup>Public Forest Enterprise “Forests of the Republic of Srpska”, Sokolac Forestry Office, Glasinačka 9, 71350 Sokolac, Bosnia and Herzegovina

<sup>2</sup>Public Forest Enterprise “Vojvodina Forests”, Morović Forestry Office, 22245 Morović, Serbia

<sup>3</sup>Public Forest Enterprise “Forests of the Republic of Srpska”, Sokolac Forestry Office, Glasinačka 9, 71350 Sokolac, Bosnia and Herzegovina

\*Corresponding author: cincarsinisa@yahoo.com

### Abstract

Trebević is mountain located in southeastern part of Bosnia and Hercegovina. Located southeast from Sarajevo, 1627 meters high and it is attached to mountain Jahorina. In the area of Trebević there is characteristic vegetation of Dinarids in which prevail forests of beech *Fagetum montanum ilyricum* (Fuk.et Stef. 1958), forests of oak and black hornbeam *Quercus-Ostryetum carpinifoliae* (Horv, 1971), forests of beech and fir *Abieti-Fagetum dinaricum* (Treg 1957 em. P. cer 1976), forests of beech and fir with spruce *Piceo-Abieti-Fagetum* (Horv, 1967), forests of fir and spruce *Abieti-Picetum illyricum* (Horv et al., 1974), secondary forests of white pine and spruce, *Piceo-Pinetum illyricum* (Horv et al., 1969). According to some authors 99 rare herb species and 14 species of mushroom were found in this area. Mountain area of Trebević has 146,22 ha of private forests in 294 plots with tree supply of 33358,43 m<sup>3</sup>/ha, also minefield area in 199,87 ha. Forests in state area equals 841,42 ha with tree supply over 107019 m<sup>3</sup>/ha.

**Keywords:** *Trebević Mountain, vegetation of Dinarids, forest communities, condition of forests.*

### Introduction

The biggest part of Trebević mountain belongs to climatic forest of beech and fir with spruce, in which are interpolated thermophilic phytocenosis, pine and oak forests. Lowest parts belong to beech and oak zone. Orthographic conditioned forests of oak (*Quercus petraea*) occupy warmer areas, and colder areas belong to beech forests, mostly acidophilus character (Bojadžić, 2001). In canyon of Miljacka river below Trebević mountain exist forests of oak (*Quercus petraea*) and standard hornbeam, with orthographic conditioned forests of oak (*Quercus petraea*) that are in similar conditions spreading much more. According to horizontal sorting of forest vegetation in ex Yugoslavia (Braun-Blanquet) according to (Stefanović et al., 1977), this region belongs to domain of inner dinarids, region of eastern-bosnian plateau. Region of eastern-bosnian plateau covers mountain areas around Sarajevo and Varšen till canyon of Drina river with large plateau of Romanija mountain (Bucalo, 2002). Protected plant species that we find in the Trebevic area which are on the red list are: *Picea omorica* Pancic., *Orchis mascula*, *Scabiosa leucophylla* (Šilić, 1990). In the geological heritage of this region, various sedimentary, magnetical and metamorphic rocks are involved – paleosolic, Mesozoic and kenozoic (Antić et al., 1982) The Trebevic area belongs to the zone of Mesozoic limestone, besides Trebvic in the mentioned zone there are the mountains Maglic, Bjelasnica, Igman, Visocica, Treskavica and others. This zone is dotted with river valleys,

cliffs and canyons. The core of this zone is the Sarajevo-Zenica basin (Ćirić, 1989). The aim of this work is to collect data related to ecological parameters, as well as to present the exact surfaces of a certain area, depending on the forest category in the area of Trebevic Mountain.

### **Material and Methods**

In this text will be mentioned what are the vegetation communities that are deployed in the Trebevic area. In addition to the above, we will analyze the threat of forests in terms of ‘‘natural enemies’’ as well as what protected areas are defined. In the Trebevic Mountain area, the most commonly used forest breeding tupe is: high forests of fir and spruce with beech on lime and dolomite series of mostly shallow soil (area 266.58ha). Largest part of area is above 1000m high. Climate is having mountain character, but from november till may it is noticed influence of continental climate. During vegetational period falls around 52 % of all yearly rainfalls. From forest-breeding and areal arrangement standpoint of forests total area of Trebević mountain is spread across 1,302.95 (ha), with minefield area of 177.82 (ha). According to performed vegetational and pedologic mappings on Trebević mountain area, production types of forests are selected and formed next classes:

Wider category of forests: ***High forests with natiral regeneration***

Narrow category of forests:

1. *High forests of fir and spruce with beech from series of limestone and dolomit mostly shallow grounds* (area 266.58 ha)
  - *High forests of fir and spruce in shallow limestone grounds* (area 9.02 ha-minefield)

Wider category of forests: ***Forest culture***

Narrow category of forests:

1. *forest culture of spruce in field of beech forests and fir with spruce at mostly shallow limestone grounds* (area 33.12 ha)
2. *forest culture of pine (munika)and dark pine in field of beech forests and for with spruce in shallow limestone grounds* (area 1.47 ha)
3. *forest cultures of white pine in field of beech forests and fir with spruce in mostly shallow limestone grounds* (area 51.33 ha)
4. *forest cultures of white pine in field of beech and fir with spruce at mostly shallow limestone and dolomit grounds* (area 17.02 ha)
  - *forest cultures of white pine in field of beech forests and fir with spruce in mostly shallow limestone and dolomit grounds* (area 130.22 ha-minefield)

Wider category of forests: ***Offspring forests***

Narrow category of forests:

1. *offspring forests of beech and other leaf-trees in mostly shallow limestone grounds* (area 2.80 ha)
2. *offspting forests of other leaf-trees at mostly shallow limestone and dolomit grounds* (area 184.05 ha)
  - *offspring forests of other leaf-trees at mostly shallow limestone and dolomit grounds* (area 4.23 ha-minefield)

Wider category of forests: ***Areas available for tree planting and management***

Narrow category of forests:

1. *thorns* (area 128.86 ha)
  - *thorns* (area 31.82 ha-minefield)

2. *grass field* (area 48.50 ha)
  - *grass field* (area 2.31 ha-minefield)

Wider category of forests: **Areas non-available for tree planting and management** (area 382.19 ha)

- *Areas non-available for tree planting and management* (area 0.22 ha-minefield)

Wider category of forests: **Usurpation** (area 16.21 ha)

When we talk about forest vegetation, most common are forests of beech and fir with spruce (*Piceo-Abieti-Fagetum*) in which are oftenly widespread secondary forests of white pine and spruce, (*Piceo-Pinetum illyricum*), also forests of fir and spruce, (*Abieti-Picetum illyricum*). Lesser areas occupy secondary forests of beech (*Fagetum montanum et Luzulo-Fagetum*). Oak group, forests of oak (*Quercus petraea*) and oak (*Quercetum petraeae-cerris*), also forests of oak (*Quercus petraea*) and hornbeam (*Quercu-Carpinetum*), forests of oak (*Quercetum petraeae montanum*) (Stefanović *et al.*, 1983), are mostly connected to lower areas towards field of Sarajevo (Bucalo, 2002), and basin of Željeznica and Dobropoljska river.

### Results and Discussion

Forests in territory of Trebević mountain, like all other forests, have their „enemies“, natural and others, biggest enemy for forests are humans. Natural factors, as connected part of ecosystem, are working constantly and they are affecting living stability, and humans, besides their effort to help forests, are making mistakes that sometimes have catastrophic consequences for forests (Medarević, 2005). Procedures of degradation and ruination of living habitat take place constantly and continuously, their intensity depends on unfavorable natural processes and events (natural disasters, calamities and other), human activities and technical-technological development. Most common factors are: consequences of strong winds (windbreakings and wind roll-outs), consequences of huge snowfall (snowbreakings and snow roll-outs), fire consequences, consequences of air-pollution (sour rains), ground pollution and other. Insects, herbal diseases and pests are constantly present and besides beneficial functions of forest as community, when too much multiplied, can cause huge damages. For forests in private ownership there is no exact data on how much is ruined from insects. In forests managed by state most usual and „most attractive“ insects in this region are *Ips typographus*, *Pityogenes chalcographus* and *Xyloterus lineatus*, so it can be assumed that those are biggest pests in private areas too. There is large number of wild junkyards at forest areas, which are consequence of carelessness of citizens, catering facilities and woodworking capacities. Ministry of forest areas from past warfare occupies (177,82 ha), and majority of this area is at tall forests with natural regeneration. Consequence of that is in inability to access and usage of required management systems, which can cause ecosystem instability and damaging impact to surrounding area. All forests have global, regional and local value, but when some of those values are considering extremely important, forest can be defined as forest of high protected value (HPV). It means that in forests like that should be performed appropriate management to save and promote existing values. First steps for separating high protective value presume gathering specific documentation (international, state and entity legislation, decision of local communities, forestry managements, special studies, mappings, etc.) that represent basics for selection of field that need to be investigated for this purpose. For some categories of high protective value sometimes is necessary to publish more investigations in different seasons, which is specially associated to different and migrational

kinds of organisms. In area of Trebević mountain important boundary in forestry management implies existence of mine-explosives. Forest minefields from past warfare occupies (177,82 ha). Consequence of that is in inability to access and usage of necessary management systems, that can lead to instability of ecosystem and its damaging influence on surrounding area. Highly protected values, also covers exceptionally ecological attributes and ecosystems products and social functions. With coordination of existing lawful regulations and definitions HCVF (High Conservation Value Forests), there is six different categories „highly protected values“. In the area of Trebević there are separated two categories of highly protected values and their criteriums and sub-criteriums:

HPV-1: forest areas that contain global, regional and state important concentration of biodiversity (area 974.07 ha).

1a: protected areas

1b: endangered species and species in danger

1c: endemic species

1d: important occasional concentrations

HPV-4: forest areas that supply basic natural protection in critical situations.

4a: forests important for water flow

4b: forests important for erosion control

4c: forests that create big obstacles to wildfires.

### **Conclusions**

-Planning the management of forests in Trebević area has a limiting character, both due to the presence of protected areas, due to mined terrain (177.82ha). Forest planning and management should be based on the objective of preserving and improving the stability, productivity and diversity of forests of fir and spruce with beech on limestone substrates.

### **References**

- Antić, M., Jović, N., Avdalović, V. (1982) „Pedologija“, Textbook of Forest University College in Belgrade, Science book Belgrade, second edition, page 209-295.
- Bojadžić, H. (2001) „Forest Management“ Sarajevo „Centre for Technological and Environmental Development“ page 33-45.
- Bucalo, V. (2002) „Forest typology“, Textbook of Forest University College in Banja Luka, page 222-258.
- Medarević, M.(2005) „Types of forests in National Park Djerdan“ Forest University College in Belgrade
- Medarević, M.(2006) „Forest managing plans“ Textbook of Forest University College in Belgrade page 77-93
- Stefanović, V., Beus, V., Burlica, Č., Dizdarević, H., Vukorep, I. (1983) „Ecologic-vegetational regionization of Bosnia and Herzegovina“, Forest University College in Sarajevo.
- Stojanović, Lj., Krstić, M. (2000) „Forest Cultivation III – Restoration and attendance of forests main types of trees“, Textbook of Forest University College in Belgrade, page 180-229.
- Ćirić, M. (1989) „Pedology“ Textbook of Forest University College in Sarajevo, page 181-272.
- JPŠ, „Forests of Republic of Srpska“, Research-development and project centre, Banja Luka (2002) „Forest-economic foundation for Sokolac ŠPP“.
- Šilić Č. (1990): Endemic plants, 3. edition. Svjetlost, Sarajevo.



## MULTIPURPOSE PROPERTIES OF SOME PLANTS SUITABLE FOR FOREST GARDENS – DAMASK ROSE, MAULE’S QUINCE, STEVIA

Srdjan LJUBOJEVIĆ<sup>1\*</sup>, Ladislav VASILIŠIN<sup>2</sup>, Goran VUČIĆ<sup>2</sup>, Aleksandar SAVIĆ<sup>2</sup>

<sup>1</sup> The Independent University of Banja Luka, Faculty for Ecology & Institute for Scientific Research

<sup>2</sup>University of Banja Luka, Faculty of Technology

\*Corresponding author: ljuboje@blic.net

### Abstract

In recent years there has been a change in perception towards gardens in urban and peri-urban areas. In addition to the attractive appearance, plants are also expected to provide a certain benefit to their host, in the form of food, spices, medicine or other. In the city gardens of Banja Luka, Bosnia and Herzegovina, for a long time have been present Damask rose and Maule's quince. In recent years appears the plant stevia.

Samples of fresh flowers of Damask rose, fresh fruits of Maule's quince and fresh leaves of stevia were collected from a large forest garden and analyzed on the content of secondary metabolites and antioxidant activity. Analyzes were carried out in six parallel repetitions and the results are expressed as mean value  $\pm$  standard deviations. The analysis was carried out on the following: total phenols, flavonoids, flavonols, anthocyanins, and monomeric anthocyanin, the effect of the sample on DPPH radical and the ABTS test. Values of listed parameters were compared to data from other countries, since in B&H similar research has not been executed so far. Obtained results indicate that all three observed species exhibit undoubted antioxidant properties, apart from their aesthetic and other use values.

**Key words:** *Damask Rose, Maule's quince, stevia, secondary metabolites, antioxidants activity*

### Introduction

Not so long ago beautifully landscaped gardens were the privilege of upper class and wealthy individuals. Today, almost every family house in the urban and peri-urban areas has a garden. In it, depending on the owner's commitment and available space, they encounter not only decorative but also medicinal and nutritional plant species (MacCaskey, 2006; Remiaz, 2017). With the affirmation of so-called forest gardens, the classical division into a floral garden, orchard and vegetable/kitchen garden, slowly disappears.

Concise definition of forest gardens is given by Jacke and Toenmeier (2005). *They are perennial polyculture of multipurpose plants*. Perennial, because they are renewed every year, without the need for new planting. Polyculture, because more different plants live in harmony, sharing the common space. Multipurpose plant properties, implies that plants are in the garden for more purposes: aesthetic, nutritious, protective, etc. The forest garden looks like a forest because there are herbaceous plants, shrubs and trees in it, but in any case it does not even have to be its imitation. One forest garden is the unique and unrepeatable creation of its designer or owner. This is where

lies the greatest attraction and the challenge of forest gardens, to design an ecosystem according to own wishes, which does not exist elsewhere on planet Earth, and on top of that gain some benefits from it.

Guided by the principle of originality, we have focused on three species in a forest garden in Banja Luka, Bosnia and Herzegovina, analyzing their aesthetic values, antioxidant properties and some other benefits. While the usability properties can be sufficiently approximated by

chemical composition or pure number, the aesthetic value estimation is burdened by the subjectivity of individual perception; what is being said - *De gustibus (et coloribus) non est disputandum*. Since there is still no uniform or at least a slightly widespread acceptance of methodological approach for assessing aesthetic values of forest gardens or gardens as a whole, we have applied a simple own concept. It is based on five characteristics in four gradations.

### Materials and methods

The experimental materials were flowers of Damask rose, fruits of Maule's quince and leaves of stevia, collected in a forest garden of the city of Banja Luka (Ph. tab. 1) during 2016 and 2017.

Photo table 1: Experimental material (taken by S. Ljubojević)



Flower of Damask rose



Fruit of Maule's quince



Leaves of stevia

#### Damask rose

Damask rose, rose of Castile (*Rosa × damascena* Mill.) is a flowering bush that is no longer found growing wild. It has been considered a cultivar that springs from *Rosa gallica* L. and *Rosa moschata* Herrm., leading the origin of the Middle East. However, Iwata *et al.* (2000) have shown that her roots go to central Asia, and that one more rose, *Rosa fedtschenkoana* Regel, is included in her genetic record. Damask rose is a deciduous bush that reaches 2 meters in height. Its dominant feature are numerous, large, pink flowers of intense and pleasant odor. The Turks brought Damask rose to the Balkans in the 16th century, and in the 17th century its mass cultivation in Bulgaria began to produce the famous rose oil (Kapetanović, 1988). In Bosnia and Herzegovina it was never used for oil production. Its role was of decorative nature and from the flowers were prepared juice, fragrant rose water and vinegar, and sweet as well. Today flowers of Damask rose are a highly valuable raw material of wide use. Apart from the essential oil, one can find other various commercial products such as: cosmetics (fragrances, shampoos, mouth fresheners), food, sweets, healing preparations etc. Recent studies have shown that leaves of Damask rose also possess respectable antioxidant properties and can be used without restriction as a healthy tea (Baydar and Baydar, 2013).

Chemical composition and antioxidant activity of Damask rose flowers from different part of the world is quite variable (Tab. 1). More detailed chemical analysis has yet to be done in B&H.

Table 1: Chemical composition and antioxidant activity of Damask rose flowers

Origin of the material	Value	Unit	Source
<b>Total phenols</b>			
Tea from dried petals, Israel	39 ± 4.90	mg GAE/g <sub>d.w.</sub>	Vinokur <i>et al.</i> , 2006
Fresh flowers from rose farm, Saudi Arabia	61.54 ± 3.88	mg GAE/g	El-Sayed <i>et al.</i> , 2013
Fresh flowers from research center, Turkey	344.45 ± 10.52	mg GAE/g	Baydar <i>et al.</i> , 2013
<b>Total flavonoids</b>			
Fresh flowers from rose farm, Saudi Arabia	30.94 ± 0.39	mgQcE/g	El-Sayed <i>et al.</i> , 2013
<b>Total flavonols</b>			
Fresh flowers from rose farm, Saudi Arabia	21.01 ± 0.55	mgQcE/g	El-Sayed <i>et al.</i> , 2013
Fresh flowers from research center, Turkey	56.81 ± 2.42	mg RE <sup>1</sup> /g	Baydar <i>et al.</i> , 2013
<b>Total anthocyanins</b>			
Tea from dried petals, Israel	1.08 ± 5 %	mg Cy3-Gl <sup>2</sup> /g <sub>d.w.</sub>	Vinokur <i>et al.</i> , 2006
<b>Antiradical activities (DPPH)</b>			
Fresh flowers, Iran	2.24 ± 0.98	µgDPPH <sup>3</sup> /ml	Yassa <i>et al.</i> , 2009
Tea from dried petals, Israel	1400 ± 5 %	µM Trolox/g <sub>d.w.</sub>	Vinokur <i>et al.</i> , 2006
Fresh flowers from research center, Turkey	82.96 ± 0.30	µg Trolox/ml	Baydar <i>et al.</i> , 2013

1/ rutin equivalent; 2/cyanidin-3-glucoside; 3/ 2,2-diphenyl-1-picrylhydrazyl

#### ☒Maule's quince

Maule's quince, Japanese quince belongs to the genus *Chaenomeles*, so-called flowering or Japanese quinces. According to Rumpunen *et al.* (2003), the most commonly cultivated "japonica" *Chaenomeles* are actually the hybrid *Ch.* × *superba* and *Ch. speciosa*; *Ch. japonica* itself is not commonly grown. Japanese quince is a dense shrub covered with thorns, up to 2 m high. The flowers are with five petals, in the color scale from pink, over pale red, orange to extremely red, sometimes in two colors with the addition of white. The fruit is roundish-oblong pome (Ph. tab. 1), initially green and in the stagnant stage yellowish or yellow. It is smelly and remains for a long time on branches after ripening. Japanese quince fruit is a quality raw material for the production of various healthy nutritional products such as: caramels, juices, syrups, carbonated soft drinks, liqueurs, jams and preserves (given the high pectin content). Also recognizable feature of Japanese quince is the beauty of its flowers. Except as a decorative individual shrub or as a spiny live fence, Maule's quince is also suitable for cultivation as a bonsai (Kawolek, 1987).

Table 2: Chemical composition and antioxidant activity of Maule's quince fruit

Origin of the material	Value	Unit	Source
<b>Total phenols</b>			
Fruit from a local market, Poland	924.0 ± 11.71	mg CAE <sup>1</sup> /100g	Tarko <i>et al.</i> , 2014
Fruit from a local market, Poland	996.0 ± 96.171	mg CAE/100g	Baranowska-B., 2017
<b>Antiradical activities</b>			
Cultivar `Lichtar`, Lithuania	12.35 ± 0.51	µmol Trolox/ml	Rubinskiene <i>et al.</i> , 2014
Hybrid clone C.47, Lithuania	10.38 ± 0.35	µmol Trolox/ml	Rubinskiene <i>et al.</i> , 2014
Fruit from a local market, Poland	10,512.0 ± 37.05	µM Trolox/g	Tarko <i>et al.</i> , 2014
Fruit from a local market, Poland	1,080,300 ± 1,591,942	mM Trolox/100 g	Baranowska-B. <i>et al.</i> , 2017

1/ catechin equivalent

The chemical composition of the fruit is variable and dependent on the climate (Hafez-Taghva *et al.*, 2015; Lesinska *et al.*, 1988). According to analyzes performed in Lithuania and Poland, the fruit of Japanese quince, among other things, possesses enviable content of total phenols and antioxidant properties (Tab. 2). Considering the better geographic position, in terms of a

greater number of sunny days and higher mean annual temperatures, it is expected that the material from our climate will show similar, if not better, characteristics. However, no one has yet been involved with such chemical analysis in B&H.

### Stevia

Stevia (*Stevia rebaudiana* Bertoni) is a herbaceous perennial plant that belongs to the *Asteraceae* (*Compositae*) family. Genus *Stevia* consists of approximately 230 species native to the South and North America. The plant reaches a height of 80 (100) cm. Leaves are tiny, elliptical, in alternate arrangement. The flowers are gathered in the inflorescence *capitulum* with five white tubular flowers, coming out from leaf armpits (Ph. tab. 1). It is a short-day plant that blooms from September to December in our environment. In its native range, stevia behaves like a perennial plant that can last four to five years, but in colder climate it is treated as an annual plant.

Stevia tissue has a complex chemical composition, well-known for its high content of sweet components. Their concentrations decline from leaves, over flowers, stem and seeds to roots, so the leaves are double sweeter than the flowers. Apart to the sweet components, it is considered that leaf extract possess a high level of antioxidant activity and useful phenolic compounds (Tab. 3). In addition to its use as a natural sweetener, the leaf of stevia has an important place in traditional medicine, first of all in South America.

Table 3: Chemical composition and antioxidant activity of stevia leaf

Origin of the material	Value	Unit	Source
<b>Total phenols</b>			
Dried leaves from a shop, Germany	63.8 ± 1.3	mgGAE/g	Periche <i>et al.</i> , 2014
Dried leaves from a farm, South Korea	130.76	µg CAE <sup>1</sup> /mg	Kim <i>et al.</i> , 2010
<b>Total flavonoids</b>			
Dried leaves from a shop, Germany	22.2 ± 0.9	mg CAE/mg	Periche <i>et al.</i> , 2014
Dried leaves from a farm, South Korea	15.64	µgQc/mg	Kim <i>et al.</i> , 2010
<b>Antiradical activities</b>			
Dried leaves from a shop, Germany	48 ± 2	mg Trolox/g	Periche <i>et al.</i> , 2014
Leaves from dedicated plantation, India	38.24 0 ± 0.36	mg Trolox/g <sub>d.w.</sub>	Tadhani <i>et al.</i> , 2007

### Preparation of materials

Five grams of each kind of material was weighed and transferred to the Erlenmeyer flask with 20 ml of 80 % ethanol. Thereafter, the sample flask was placed in an effervescent bath (50 Hz), twice for five minutes, and then connected to the return cooler. The extraction lasted 10 minutes after the boiling moment. After cooling to room temperature, filtration is performed and the remaining precipitate is returned to the conical flask with addition to 20 ml of 80 % ethanol and extracted for another 10 minutes, then filtered again in a flask containing the first filtrates and supplement by 80 % ethanol up to the mark. In this way, a parent liquor concentration of 0.1 g/ml was obtained which was used for all other determinations.

### Determination of the content of secondary metabolites and antioxidant activities

Total phenols were determined by modified Folin-Ciocalteu assay (Wolfe *et al.*, 2003). For making of calibrated line, the gallic acid was used (thereby,  $y = 0.003x - 0.0226$ ,  $R^2 = 0.9975$ , y - absorption, x - concentration of gallic acid in µg/ml). The results are expressed as phenol equivalent to gallic acid, i.e. mgGAE/g<sub>f.w.</sub>. Determination of total flavonoids was done using the method of Ordoñez *et al.* (2006). Total flavonoid content is counted as the flavonoid equivalents of quercetin (µmolQc/g<sub>f.w.</sub>) using the equation of the calibration line (thereby,  $y = 0.0368x - 0.135$ ,  $R^2 = 0.9996$ , y - absorption, x - concentration of quercetin in µg/ml). The results are expressed as µg Qc/g<sub>f.w.</sub>. Total flavonols was determined by the method of

Kumaran and Karunakaran (2007). For making of calibrated line, the quercetin hydrate was used (thereby,  $y = 0.0214x + 0.004$ ,  $R^2 = 0.9993$ ,  $y$  - absorption,  $x$  - concentration of quercetin in  $\mu\text{g/ml}$ ). The results are expressed as  $\mu\text{g Qc/g}_{\text{f.w.}}$ . The DPPH test was carried out applying the method Liyana-Pathirana and Shahidi (2005), while the ABTS test was performed using modified method of Re *et al.* (1999). Trolox was used to create calibrated lines. For the DPPH test equation was:  $y = 7.0993x - 0.434$  with  $R^2 = 0.9722$ , and for the ABTS test:  $y = 15.94x + 10.527$  with  $R^2 = 0.9984$ . The results were expressed with TEAC (Trolox equivalent antioxidant activity) value, i.e. as  $\mu\text{g Trolox/g}_{\text{f.w.}}$ . All experiments were performed in three parallel repetitions, and the results are expressed as the mean  $\pm$  standard deviation (Table 4). Quantitative determination of total anthocyanins is based on the anthocyanin's ability to reversibly alter their structure by changing the pH of the medium, resulting in an absorption spectrum change. The content of total anthocyanins was determined by the "single" method by which anthocyanin absorbance was measured at pH 1.0, proportional to the total anthocyanins content. The content of monomeric anthocyanins was determined by the pH differential method based on the monomeric anthocyanins characteristic that they are in oxonium form (colored in red) at pH 1.0, while at pH 4.5 they are in hemiketal form (colorless) (Giusti and Wrolstad, 2001); concentration was calculated as the equivalent of cyanidin-3-glucoside.

#### **Evaluation of aesthetic values**

Since there is still no uniform or at least widely accepted methodological procedure for assessing aesthetic values of forest gardens, or gardens as a whole, we have applied a simple own concept. It is based on five attributes (given in declining rank): I - aesthetically pleasing, II – odor, III - companionability, IV - maintainability, V - soundness. Under aesthetically pleasing we consider: nice color and elegant and harmonious form (habitus). Odor is expected to be pleasant and to provide a sense of comfort and relaxation. Companionable means that plant has a stable and non-expansionist footprint, and is able to fit nicely into available space. Maintainability means ease of pruning and absence of thorns. Under the soundness we understand resistance to diseases and pests, as well as not providing the shelter to the same. Each of these attributes can be expressed in four gradation: 1. – negative (when the plant species or its properties reduces the overall value of the forest garden), 2. – unenlightened (when the plant species or its properties does not adversely affect the garden, but also does not contribute to its overall value), 3. – positive (when the plant species or its properties increases the overall value of the forest garden), 4. – decisive (when the plant species or its properties has a big to crucial impact on the overall value of the forest garden).

#### **Results and discussion**

The obtained results show that all observed species contain significant amounts of phenols. It is preceded by the Damask rose flower, followed by the stevia leaf and the fruit of Maule's quince (Tab. 4). Absolutely the highest concentration of flavonoids and flavonols has the fruit of Maule's quince. Anthocyanin content can not be compared because no analyzes were made on fruits of Japanese quince and leaves of stevia. When it comes to ability of herbal material to scavenge the DPPH radical, the greatest potential shows fresh leaf of stevia, while the best ability to quench the ABTS+ has fresh fruit of Maule's quince.

Table 4: Chemical composition and antioxidant activity of observed species

Parameters	Units	Fresh flowers of Damask rose	Fresh fruit of Maule's quince	Fresh leaves of stevia
		Mean value $\pm$ standard deviation		
Total phenols	mgGAE/g <sub>f.w.</sub>	26.412 $\pm$ 0.886	6.385 $\pm$ 0.479	8.805 $\pm$ 0.493
Total flavonoids	$\mu$ gQcE/g <sub>f.w.</sub>	14.539 $\pm$ 0.682	74.391 $\pm$ 12.75	2.31 $\pm$ 0.49
Total flavonols		1.485 $\pm$ 0.045	11.535 $\pm$ 0.496	2.292 $\pm$ 0.352
Total anthocyanins	mg/g <sub>f.w.</sub>	4,874 $\pm$ 0,01		
Total monomeric anthocyanin		4,062 $\pm$ 0,006		
DPPH (IC <sub>50</sub> ) <sup>1</sup>	$\mu$ g Trolox/mg <sub>f.w.</sub>	0.2985 $\pm$ 0.0035	1.306 $\pm$ 0.269	2.507 $\pm$ 0.08
ABTS (IC <sub>50</sub> )		0.1065 $\pm$ 0.0015	7.64 $\pm$ 0.029	4.862 $\pm$ 0.029

1/ IC<sub>50</sub> (concentration required for 50% inhibition of DPPH radicals)

Results for flowers of Damask rose are inferior to the results achieved in the southern and warmer regions, by all parameters (Tab.1). One part of the differences is likely to be explained by a better starting material. Namely, the samples for analysis in Saudi Arabian work have been taken from a farm of roses and in Turkish work from a research center for selection. The second part of the difference is certainly due to natural factors. Findings of Vinokur *et al.* (2006) and Ginova *et al.* (2013) that the antioxidant capacity of Damask rose petals correlated well with the contents of total phenols, has not been confirmed. We have gain a relatively high content of phenols but a relatively lower antioxidant capacity. Compared to the types of fruit that are known to have high content of anthocyanins (bilberries, blackberries, black currants etc., Giusti and Wrolstad, 2001), our results are better. The content of total phenols in the fruit of Maule's quince is somewhat lower (by about 30 %) compared to the material originating from Poland and the Baltic countries (Tab. 2). For other parameters, it is ungrateful to compare quantitative parameters since they are calculated in different ways and expressed in different units. And in this case, one part of the difference is likely to be explained by the better starting material, bearing in mind that the Japanese quince is a popular domestic fruit in this areas.

Locally produced leaf of stevia has the slightest arrear in the observed parameters compared to the other two species, especially when it comes to flavonoids (Tab. 3).

As has been said, a deeper and more comprehensive comparative analysis complicates the differences in the methodology of collecting, processing and interpretation of data, especially when it comes to units in which a particular parameter is expressed.

From the aesthetic point of view, all three species meet the highest standards (Tab. 5). The most prominent attributes have Damask rose. If there is no thorns, which to a certain extent makes maintenance and passage of a forest garden a little bit difficult, this plant could be considered perfect, especially its cultivars and varieties with a prolonged period of flowering. Very close to Damask rose is Maule's quince, which also has thorns, with the difference that its odor is somewhat less pronounced. At first glance stevia may be considerably smaller and inconspicuous than these two bushes. However, it has its own trumps, which are reflected in excellent companionability, ease of maintenance and soundness.

Table 5: Evaluation of aesthetic values

Rank	Attributes	Plant species/gradation of attributes											
		Damask rose				Maule's quince				Stevia			
		1.	2.	3.	4.	1.	2.	3.	4.	1.	2.	3.	4.
I	Aesthetically pleasing												
II	Odor												
III	Companionability												
IV	Maintainability												
V	Soundness												

### Conclusions

Damask rose, Maule's quince and stevia deserves to be found in every forest garden. They have undoubtedly multipurpose properties that are reflected in utilitarian and aesthetic attributes. All three species are also suitable for the green spaces designed for health and well-being, so call healing garden, which was not the subject of this paper. All observed species contain secondary metabolites at concentrations that contribute to their antioxidant properties. In case of desire or need, with Damask rose and Maule's quince there is a significant space for increment of these parameters by the introduction of superior herbal material, considering that traditional and unselected herbal material has been analyzed, which has existed for years in the observed area.

Damask rose possesses the most prominent aesthetic attributes in accordance with the set criteria. It stands out with a nice appearance, a pleasant odor, with companionability and soundness. From her flowers, one can get juice, fragrant rose water, fragrant vinegar, sweet, even essential oil, and from flowers and leaves, fragrant, refreshing and healing tea.

From aesthetic point of view, the Maule's quince is very close to the Damask rose. In the flowering phase, which, unfortunately, is relatively short, its occurrence is simply incomparable. Its fruits are also beautiful and attractive, especially because they remain on the branches for a long time. From fresh fruits owners of the gardens can prepare juices, syrups, liqueurs, jams, and from dried ones nice and healthy vitamin tea.

In terms of appearance, stevia may be considerably smaller and inconspicuous than previous two bushes. However, it also has several affirmative aesthetic traits, which are reflected in excellent companionability, ease of maintenance and soundness. From the utilitarian point of view, stevia probably provide the most useful benefit to garden owners because it permanently deprives them of the need to procure voluminous and unhealthy crystalline sugar. In addition to its use as a natural sweetener, overhead parts of the plant are suitable for the preparation of traditional medicinal products of wide use.

### References

- Baranowska - Bosiacka I. *et al.* (2017): Macro- and microelement content and other properties of *Chaenomeles japonica* L. fruit and protective effects of its aqueous extract on hepatocyte metabolism. *Biological Trace Element Research*, 178. 327-337
- Baydar G. K., Baydar H. (2012): Phenolic compounds, antiradical activity and antioxidant capacity of oil-bearing rose (*Rosa damascena* Mill.) extracts. *Industrial Crops and Products*, 41. 375-380
- El - Sayed S. A - H, Bazaid A. S., Salman S. M. (2013): Characterization of the phytochemical constituents of Taif rose and its antioxidant and anticancer activities. *BioMed Research International*. Hindawi Publishing Corporation, Vol. 2013. 1-13

- Ginova A., Mihalev K., Kondakova V. (2013): Antioxidant capacity of petals and leaves from different rose (*Rosa damascena* Mill.) plantations in Bulgaria. *International Journal of Pure & Applied Bioscience*, 1 (2). 38-43
- Giusti M.M., Wrolstad R.E. (2001): Anthocyanins. Characterization and measurement with UV-visible spectroscopy. In: Wrolstad RE, editor. *Current protocols in food analytical chemistry*. Unit F1.2. John Wiley & Sons. 1-13
- Hafez - Taghva P., Zamzad M., Khalafi L. (2015): Total flavonoid content and essential oil composition of *Chaenomeles japonica* (Thunb.) Lindl. ex Spach from North of Iran. *Indian Journal of Natural Products and Resources*. Vol. 7(1). 90-92
- Iwata H., Kato T., Ohno S.: (2000) Triparental origin of Damask roses. *Gene* 259. 53–59
- Jacke D., Toenmeier E. (2005): *Edible forest gardens*, Vol. 1. Chelsea Green Pub. Comp. 1-377
- Kapetanović S. (1988): The possibility of obtaining rose oil in the territory of B&H (Mogućnost dobijanja ružinog ulja na području BiH. *Šumarski fakultet u Sarajevu*. 1-163
- Kawolek W. (1987): *Das praktische Bonsai-Buch*. Ulmer.1-318
- Kim S. *et al.* (2010): The antioxidant activity and the bioactive compound content of *Stevia rebaudiana* water extracts. *LWT-Food Science and Technology*. Vol. 44, Issue 5. 1328-1332
- Kumaran A., Karunakaran R. J. (2007): In vitro antioxidant activities of methanol extracts of *Phyllanthus* species from India. *Food Science and Technology*, Vol. 40 (2). 344-352
- Lesinska E., Przybylski R., Eskin N. A. M. (1988): Some volatile and non volatile flavor components of the dwarf quince (*Chaenomeles japonica*). *Journal of Food Science* 53. 854-56
- Liyana-Pathirana C.M., Shahidi F. F. (2005): Antioxidant activity of commercial soft and hard wheat (*Triticum aestivum* L.) as affected by gastric pH conditions. *Journal of Agriculture and Food Chemistry*, Vol. 53 (7). 2433-2440
- MacCaskey M. (2006): *Gardening for dummies*. John Wiley & Sons, Ltd. 1-390
- Ordoñez A.A.L. *et al.* (2006): Antioxidant activities of *Sechium edule* (Jacq.) Swartz extracts. *Food Chemistry*, Vol. 97 (3). 452-458
- Periche A., Koutsidis G., Escriche I. (2014): Composition of antioxidants and amino acids in stevia leaf infusions. *Plant Foods for Human Nutrition*, 69(1). 1-7
- Re R. *et al.*(1999): Antioxidant activity applying an improved ABTS radical cation decolorization assay. *Free Radical Biology and Medicine*, Vol. 26 (9–10). 1231-1237
- Remiaz T.(2017): *Forest gardening in practice: An illustrated practical guide for homes, communities and enterprises*. Permanent Publications. 1-240
- Rubinskienė P. *et al.* (2014): Biochemical composition and antioxidant activity of Japanese quince (*Chaenomeles japonica*) fruit, their syrup and candied fruit slices. *The Institute of Horticulture, Lithuanian Research Centre for Agriculture and Forestry*, 33 (1-2). 45-52
- Rumpunen K. *et al.* (2003): Molecular and morphological diversity in the plant genus *Chaeno – meles*. Department of Crop Science. Swedish University of Agricultural Sciences. 1-13
- Tadhani B.M. *et al.* (2006): In vitro antioxidant activities of *Stevia rebaudiana* leaves and callus. *Journal of Food Composition and Analysis* 20. 323–329
- Tarko T. *et al.* (2014): *Chaenomeles japonica*, *Cornus mas*, *Morus nigra* fruits characteristics and their processing potential. *Journal of Food Science and Technology*. 51(12). 3934-3941



- Yassa N. *et al.* (2009): Chemical composition and antioxidant activity of the extract and essential oil of *Rosa damascena* from Iran, population of Guilan. DARU Journal of Pharm. Sci. 175-180
- Wolfe K., Wu X., Liu R.H. (2003): Antioxidant activity of apple peels. Journal of Agricultural and Food Chemistry, Vol. 51 (3). 609-614
- Vinokur Y. *et al.* (2006): Rose petal tea as an antioxidant rich beverage: Cultivar effects. Journal of Food Science, Vol. 71. No. 1. 42-47

## PHENOTYPING TREES FOR TRAITS RELATED TO DROUGHT STRESS TOLERANCE – IMPORTANCE AND CHALLENGE

Doris KRABEL\*, Matthias MEYER, Bayartaa NYAMJAV, Birgit REICHE, Alexander SOLGER

Molecular Physiology of Wood Plants Group, Institute of Forest Botany and – Zoology, Dresden University of Technology, Tharandt, Germany

\*Corresponding author: doris.krabel@tu-dresden.de

### Abstract

Results from green-house experiments on the early development of shoots and roots from hardwood cuttings of three different poplar genotypes and seedlings from oak (*Quercus petraea* and *Quercus robur*) will be presented. Already after an experimental time of 65 days (poplar hardwood cuttings) respectively 73 days (oak seedlings) in pots, the young plants showed a clone/ species specific growth performance. For all the species the plants were treated with two levels of irrigation (fully and reduced irrigation). For aboveground components traits of interest have been fresh and dry mass, number of shoots, length of shoots, number of leaves and leave area. For the belowground components root fresh and dry biomass, the total root length were analysed for each clone resp. each population. The results will highlight the effects of different irrigation treatments on the plant's growth performance which emerge already after just a few weeks from the beginning of the experiment. Based on our experimental design, it should be possible to develop a robust method for high throughput phenotyping of trees in an early developmental stage.

**Keywords:** *poplar, Quercus spec., pot experiment, early root/ shoot development.*

### Introduction

Within the last decades tremendous efforts have been undertaken on the development of efficient methods for phenotyping crop plants (e.g. Fiorani and Schurr 2013, Araus and Cairns 2014). These efforts are justified insofar as their application produces results which are essential for the interpretation of results from genetic and genomic analyses. The combination of both approaches improves the understanding of biomass regulation and lead to the development of crops with superior agronomic performance (Zhu et al. 2011). Although enormous progress has been achieved in the automation of measuring a bunch of phenotypic traits of various economical important plant species, these approaches don't include the characterization of phenotypic traits of trees (Krabel *et al.*, 2015). There are several reasons for disregarding woody plant species: 1. most traits of interest (e.g. wood quality, resistance to biotic and abiotic factors) are only apparent after the plant was growing for several decades. 2. This implies that at this time trees are mostly several meters high and therefore they cannot be transferred into a green-house or kept elsewhere under controlled environmental conditions. 3. The economically most relevant tree species of European forests are almost ever cultivated from natural regeneration. In this case family structures are mostly unknown and pedigrees of F1 and F2 families don't exist except for a very limited assortment of woody species/families. Nevertheless, what's true for agricultural crop plants is also valid for woody plants - the improvement of a trees performance requires a combination of a detailed phenotypic characterisation and genomic analyses (Krabel *et al.*, 2015).

For molecular and phenotypic investigations, poplar species show some advantages compared

to tree species like oaks. Generally, poplars are flowering after a period of less than ten years, so controlled crossings for the establishment of F1 and F2 families are possible in a manageable period of time. Vegetative regeneration is easily possible (except for *Populus tremula*) and therefore the testing of clonal material for various treatments and applications on genetically homogenous plant material in a large scale is no problem. Last but not least the economic importance of the genus *Populus* increased throughout Europe and North America within the last decades (Dickman 2001, Zalesny *et al.* 2004) because of the usability as energy plant and the broad application of the timber.

Oak species belong to the beech family *Fagaceae* and genus *Quercus*. There are approximately 600 extant species of oaks, which include deciduous and evergreen species extending from cool temperate to tropical latitudes in America, Asia, Europe, and North Africa. *Quercus petraea* and *Quercus robur* are the main species that are found in the European deciduous forests (Thomas and Gausling, 2000). About 7% of the forest area in Europe is covered by oak trees (Szezekowski *et al.* 2007). Here both species do not only play an ecological role in terms of biodiversity but also derive economic value for the wood industry and forest enterprises. Nevertheless, within the past decade the vitality of these two species severely decreased due to the changes of climatic conditions especially that of repeated drought events.

Especially during the first month of the plant's development, drought events cause severe problems not only for the plant's vitality but also for the economic success of the stand. Green-house experiments under controlled environmental conditions are a first step to identify plant material better adapted to dry periods especially during the critical phase of early plant development.

The present studies aimed to study the responses of early growth of roots and shoots of 3 hybrid poplar cultivars and the two species *Quercus robur* and *Quercus petraea* to two different irrigation regimes. Therefore glasshouse experiments were conducted with hardwood cuttings respectively seedlings grown in pots under well irrigated and under water stress conditions. The aims of these studies were to quantify responses of length growth, fresh and dry mass of roots and shoots in the early phase of plant development and to find out hints on the 'strategy' of the various genotypes dealing with deficit irrigation..

## Material and Methods

Plant material – poplar cultivars: For this part of the investigation hardwood cuttings (20 cm long and ca. 1.5 cm in diameter) of three commercially available hybrid poplar varieties 'Max 3' (*P. maximowiczii* x *P. nigra*), 'Muhle Larsen' (*P. trichocarpa* x *P. trichocarpa*) and 'Hybride 275' (*P. maximowiczii* x *P. trichocarpa*) have been investigated. For the experiment 100 cuttings of each variety were assorted for homogeneity and then placed in 2 L polypropylene plant pots, one cutting per pot. The plant's substrate was 40% washed sand and 60 % potting soil (for more details see Krabel *et al.*, 2015).

Plant material – oak species: 30 two year old seedlings from acorns of *Quercus petraea* (Tharandt 50,981675 N; 13,576199 E and 373 m above sea level) and 48 seedlings from *Quercus robur* (Graupa 51,00 N; 13, 550 E and 164 m above sea level) collected in autumn 2012 were placed in 4 L polypropylene pots in April 2014. The plant's substrate was 30% washed sand and 70 % potting soil.

The experimental design in the green-house followed the same procedure for both groups (poplar and oak) of plant material. Initially, all pots were automatically irrigated to saturation for approximately 20 days (poplar) and 50 days (oak). During this period of adaptation the young plants developed new roots and shoots. Then the groups were divided into a well irrigated collective and a collective with diminished water supply. For the water-stressed

group the water content was kept at 10% soil water content (measured with time-domain reflectometry) by irrigation by hand with a graduated beaker. The well-watered group was still irrigated by an automatic irrigation system and kept at 25% volumetric soil water content. Processing of plant material: For poplar, at 5 dates, 10 plants per variety and treatment group were extracted from the soil. *Quercus* plants were extracted once. The experiment was finished after 65 (poplar) resp. 73 (oak) days of growth under experimental conditions. The plants were taken out of the pots and dissected into stem, leaves and roots. Fresh mass and length of longest roots and shoots as well as their numbers (results not shown) were determined. Subsequently, the plant material was oven dried (model FD 115; Binder GmbH, Tuttlingen, Germany) at 105 °C for 3 to 4 days for dry mass determination.

Statistical methods: All statistical test procedures were carried out using the SPSS Statistics software (version 22.0.0; IBM Corporation, Munich, Germany). Preliminary analyses and calculations of deduced variables were done with Microsoft Excel 14 (Microsoft Office Pro Plus 2010). For more details concerning the statistics see Krabel *et al.* (2015).

### Results and Discussion

The early root development is essential for vegetative but also generative reproduction of woody plants. In order to afford an optimal aboveground plant development, roots are the organs which enable a sufficient water and mineral supply. Though, different genotypes within one species may show different abilities and strategies in developing an efficient root system (Günes, 2000; Pallardy and Kozłowski, 1979; Zalesny *et al.*, 2005).

The part of the paper dealing with the response of poplar genotypes to irrigation treatments is based on results published in an extended article by Krabel *et al.* (2015).

Regarding the fast growing hybrid poplar varieties, optimal irrigation conditions lead for Hybride 275 to the highest root dry mass (Figure 1) and the longest roots. During the entire period of the experiment a significant influence of the genotype could be observed. In comparison with Hybride 275, the genotypes Max 3 and Muhle Larsen showed for some traits more similarities, so for example Max 3 and Muhle Larsen showed a comparable number of roots, whereas Hybride 275 is characterized by significantly less roots (data not shown). Concerning the root length, the influence of the genotype decreased with time of development. Interestingly, after only 14 days of experimental time the roots reach nearly half the length of the length at the end of the experiment. Regarding the shoot growth the genotype Max 3 shows superior development. Although shoot growth of Hybride 275 is delayed, after 65 days of development the growth rate per day is as high as that of Max 3, which confirms the results of (Schildbach *et al.*, 2012; Schirmer, 2010).

The influence of drought stress on the physiology of trees is purpose of many investigations (e.g. Lösch, 2001; Matyssek *et al.*, 2010). Dependent on the duration and intensity of the stress application the reactions that follow may be quite different. Hartung (1996) reports that moderate drought stress is answered with increased root length growth. This reaction can be explained as the attempt to increase water uptake. In our experiments such reaction couldn't be observed. All the varieties showed a significant decrease in root mass and – length when reducing water availability. Such a reduction of root growth seems to be typical for severe drought events (Hartung, 1996; Tschaplinski *et al.*, 1998; Zhijun and Dickmann, 1992).

The shoot to root ratio, which shows the relocation of biomass indicates that under drought stress Hybride 275 relocates only slightly biomass in favour of roots, whereas for Max 3 the ratio decreases more than to the half compared with optimal irrigation.

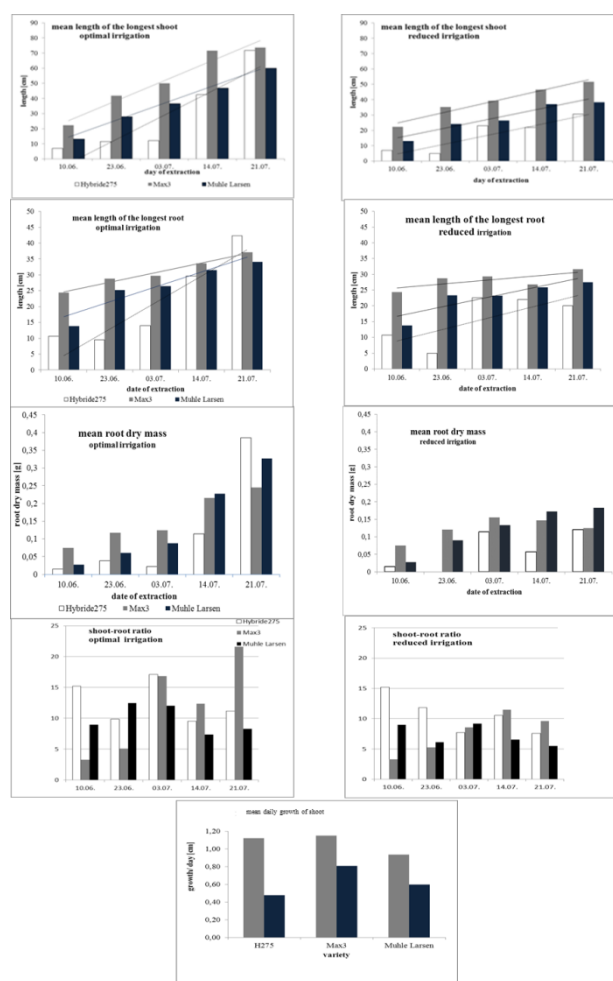


Figure 1: Hybrid poplar experiment - differences in growth performance of the genotypes Hybride 275, Max 3 and Muhle Larsen under different irrigation treatments. Traits of interest are longest shoot, longest root, root mass (fresh weight), shoot-root ratio (fresh weight) and the mean daily growth of the shoot.

Both oak species are regarded as relatively drought tolerant even though there is some variability between *Q. robur* and *Q. petraea*. The depth growth of both root systems and the xeromorphic structure of their leaves are preconditions to keep a high water potential in the cells even during dry periods (Abrams, 1990). But, generally *Q. robur* is classified as the species which needs a bit more humidity than *Q. petraea* and *Q. petraea* colonises the more extreme sites. Typically *Q. robur* is a species of floodplain forests and the lowlands and *Q. petraea* can be found on hilly sites.

Regarding the oak greenhouse experiment the results confirmed the above mentioned statements (Fig. 2). Under well-watered conditions *Q. robur* showed a superior growth in root and shoot development compared with *Q. petraea*, and under dry conditions a significant decrease of aboveground and belowground biomass can be observed. Interestingly, sessile oak (*Q. petraea*) develops a less pronounced root system than pedunculate oak (*Q. robur*), therefore under reduced water supply the breakdown of fresh root biomass is less intense. Whereas root biomass for *Q. robur* decreased to more than a half of the value compared to the well-watered conditions. The shoot-root ratio of *Quercus petraea* indicates that for both treatments the partitioning of biomass is relocated in favour of roots. This might be a hint that the species follows a ‘different strategy’ with regard to water availability - less aboveground biomass but a more efficient root system.

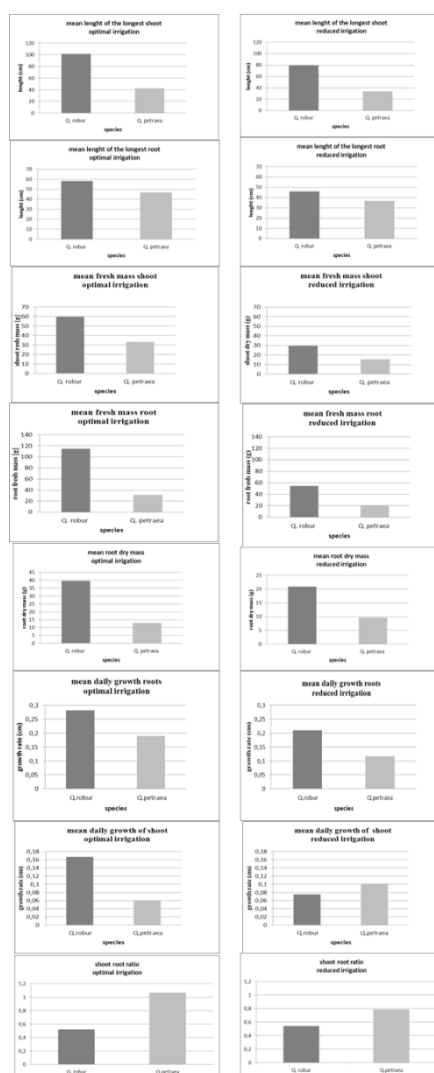


Figure 2: *Quercus* experiment - differences in growth performance of *Quercus robur* and *Quercus petraea* under different irrigation treatments. Traits of interest are longest shoot, longest root, root mass (fresh and dry weight), the mean daily growth of the shoot and shoot:root ratio (fresh weight).

## Conclusions

In our studies we tried to quantify the performance of shoot and root growth of young trees under green-house conditions. The results showed that even within a short experimental time (65 resp. 73 days) individual growth characteristics can be observed for fast growing as well as slow growing tree species. The phenotyping of growth related traits during an experimental time of few weeks can't replace field trials, but experiments under well-defined environmental conditions can help to simulate specific conditions like for example defined drought stress conditions even for woody plant species. Therefore, greenhouse experiments should be an inherent part of testing tree provenances and populations especially in the context of global change.

## Acknowledgements

Our work was based on funding by the German Agency for Renewable Resources (<http://www.fnr.de>) and the German Federal Ministry of Food and Agriculture. The project

acronym is “FastWOOD I- III” (support code: 22002911). The oak experiments were enabled by financial support from Deutsche Akademische Austausch Dienst (DAAD) given as a grant to Mrs. Bayartaa Nyamjav. Many thanks to Staatsbetrieb Sachsenforst, Graupa who gave us access to the greenhouse facilities.

### References

- Abrams M. (1990). Adaptations and responses to drought in *Quercus* species of North America. *Tree Physiology* vol 7, pp. 227-238.
- Araus L.J., Cairns J.E. (2014). Field high-throughput phenotyping: the new crop breeding frontier. *Trends Plant Sci.*19, pp. 52-61.
- Fiorani F., Schurr U. (2013). Future scenarios for plant phenotyping. *Annu. Rev. Plant Biol.* 64, pp. 267-291.
- Dickman D.J., Isebrands J.G., Kosola K., Kort J. (2001). Physiological ecology of poplars. In: *Poplar culture in North America*. Edited by: D.I. Dickman, J.G. Isebrands, J.E. Eckenwalder, J. Richardson. National Research Council of Canada, Ottawa, pp. 77-118.
- Günes T. (2000). Peroxidase and IAA-Oxidase Activities During Rooting in Cuttings of Three Poplar Species. *Turkish Journal of Botany* 24, pp. 97-101.
- Hartung W. (1996). *Stress bei Pflanzen*. Bern, Stuttgart, Wien: Haupt, pp. 119-13.
- Krabel D., Meyer M., Solger A. Müller R., Carvalho P., Foulkes J. (2015). Early root and aboveground biomass development of hybrid poplars (*Populus* spp.) under drought conditions. *Can. J. For. Res.* 45, pp. 1289-1298.
- Lösch, R. (2001). *Wasserhaushalt von Pflanzen*. Wiebelsheim: Quelle&Meyer Verlag, 595 p.
- Matyssek R., Fromm J., Rennenberg H., Roloff A. (2010).. *Biologie der Bäume*. Stuttgart: Ulmer, 349 p.
- Pallardy S., Kozłowski T. (1979). Early root and shoot growth of *Populus* clones. *Silvae Genetica* (28), 4, S. 153-156.
- Schildbach M., Wolf H., Hartmann K. (2012). Untersuchungen zur abiotischen Resistenz schnellwachsender Baumarten. In: *Nordwestdeutsche forstliche Versuchsanstalt, Züchtung und Ertragsleistung schnellwachsender Baumarten im Kurzumtrieb Bd 8*. Göttingen: Universitätsverlag, pp.. 237-256.
- Schirmer R. ( 2010). Geprüfte Pappelsorten steigern den Ertrag deutlich. *AFZ der Wald* 22, pp. 29-31.
- Szezepkowski A., Nicewicz D., Koczon P. (2007). The Relationship Between Tree Health and Chemical Composition of Beech (*Fagus sylvatica* L.) and Oak (*Quercus robur* L.) Wood of Polish Provenances. *Acta Sci. Pol., Technologia Alimentarius* 6 (3), pp.77–88.
- Tschaplinski T., Tuskan G., Gebre G., Todd D. (1998) Drought resistance of two hybrid *Populus* clones grown in a large-scale plantation. *Tree Physiology* 18, pp. 653-658.
- Zalesny R..S., Jr., Bauer E.O., Riemenschneider D.E. (2004). Use belowground growing degree days to predict rooting of dormant hardwood cuttings of *Populus*. *Silvae Genetica* 52, pp. 273-279.
- Zalesny R.S., Riemenschneider D., Hall R. (2005). Early rooting of dormant hardwood cuttings of *Populus*: analysis of quantitative genetics and genotype x environment interactions. *Canadian Journal of Forest Research* 35 (4), pp. 918-929.
- Zhijun L., Dickmann D. (1992). Responses of two hybrid *Populus* clones to flooding, drought and nitrogen availability. I. Morphology and growth. *Canadian Journal of Botany* 70 (11), pp. 2265-2270.

## AUTHOR INDEX

A. V. GRYAZKIN .....	2720	Aleksandra STANOJKOVIĆ-SEBIĆ ....	1333, 1358, 1828
Abbas BIABANI.....	294	Aleš KOLMANIČ.....	690
Abd El-Alim Abdel-Rhman METWALLY .....	955	Alexander SOLGER .....	2738
Abdelhay ARAKRAK .....	1398	Alexander TASHEV .....	1710
Abdelkrim KRIRA .....	375	Alexey SOLDATENKO .....	452
Abdellatif OUBERRI.....	375	Alfonso DOMÍNGUEZ .....	696
Abdel-Rahman EL-BAGORY .....	1158	Ali KOÇ .....	812, 823
Abderrahmane BOULAHROUF .....	1078	Ali Rıza DEMIRKIRAN.....	1911
Abderrahmane EL HARIF.....	382	Ali SLIMANI.....	1674, 1684
Abdesatar LAADJAL .....	1684	Ali ZAHMACIOĞLU.....	1660
Abdullah Al Sufian SHUVO.....	2106	Alma RAHIMIĆ .....	57
Abdurrahman KARA .....	847	Amal Z. HEGAZI.....	205
Abdurrahman Muhammad FIKRI RASDI .....	289	Amar MEBARKIA .....	1674
Abo-Bakr EDRIS .....	1158	Amel BOUZID .....	51
Achour MENNANI...2069, 2076, 2082, 2088, 2099		Amela KATICA.....	2112
Adam WASILEWSKI.....	2525	Amela SEMIC.....	1120
Adel ALY.....	1986	Amer SUNULAHPAŠIĆ .....	92, 99
Adel Mohamed EL-Garhy.....	232	Amin LAGLAOUI.....	1398
Adem DOGAN .....	1433, 1442	Amina THAKAHOVA .....	2251
Adem SALILLARI .....	943	Amna BIJEDIĆ.....	1126
Adrian BĂNEȘ .....	2423	Ana MARJANOVIĆ–JEROMELA.....	1350
Adrian BĂNEȘ .....	2417	Ana NIKOLIĆ .....	623
Adrian CAPRITA .....	1273, 1278	Ana STOILOVA.....	118
Adriana ELIÁŠOVÁ.....	683	Anamaria GIUMBA.....	1290
Adriana RADOSAVAC .....	2429	Anamarija BANAJ.....	62
Adriano CIANI .....	2326, 2333	Anatoli BITTIROV .....	2251
Agila DAUKSIENE.....	2150	Andra ZVIRBULE.....	2359, 2365
Agnes CSIVINCSIK.....	2140	András TAKÁCS .....	1203
Agnieszka JASZCZAK.....	2403	Andrei TEODORU .....	1261
Ahmed DŽUBUR .....	86	Andrej PILIPOVIĆ .....	2653
Ahmed I. EL-BATAL.....	205	Andrey A. KALACHEV.....	1224
Ahmed M. DIAB.....	2532	Andrija TOMIĆ .....	2302
Ahmed Rabie EL-BADAWY .....	1172	Andrzej GRUCHOT .....	1790
Ahmet ÖZTÜRK.....	2013, 2023	Aneliya BORISOVA .....	124, 130
Ahmet Sami EROL .....	1932	Anestis KARKANIS .....	270
Ahmet YILMAZ .....	982, 998	Angel ANGELOV .....	2314
Aicha CHICAR .....	362	Ángel MARTÍNEZ-ROMERO.....	696
Aina DOBELE .....	2359, 2365	Angel SAROV .....	2308
Alaa ALZGAIR.....	707	Angelina TAPANAROVA .....	481
Alban IBRALIU.....	45	Anita ČAKAROVA .....	2156
Albana HASIMI .....	1667	Anja ROSANDIĆ .....	2429
Aldjia HMICHE .....	1058	Annalisa GAMBARDELLA.....	2333
Aldjia OUDJIANE.....	1058	Antoine CLINQUART.....	2270
Aldona MIEZELIENE .....	2150	Antonije ŽUNIĆ .....	1306
Aleksandar ĐIKIĆ .....	577	Antonina KOSOLAPOVA.....	461, 1637
Aleksandar JEVTIĆ .....	2172, 2180, 2203	Antonio SÁNCHEZ NAVARRO .....	1897
Aleksandar KOVAČEVIĆ.....	519	Antoniya STOYANOVA.....	948
Aleksandar LUČIĆ .....	2664	Apeh Ocheigwu Hyacinth OLUMA .....	1484
Aleksandar SAVIĆ .....	2729	Armin MUSTAFIĆ.....	86
Aleksandar TEPAVAC .....	2725	Arthur DOMBLIDES.....	452
Aleksandra ANGELESKA.....	1230	Arunima KUMARI .....	2320
Aleksandra BENSA .....	1716	Asif AHMAD .....	1248
Aleksandra FIGUREK .....	111	Asima AKAGIĆ .....	1126
Aleksandra GOVEDARICA-LUČIĆ .....	57	Askin GOKTURK .....	733, 2700
Aleksandra JEVTIĆ .....	2172, 2180, 2203	Asllan CELAMI.....	45
Aleksandra PRZYDRÓŻNA.....	1255	Asma SOHAIL .....	1248
Aleksandra STANOJKOVIĆ-SEBIĆ .....	470, 561	Asmaa G. ABD EL HAFZ.....	205



Asta RACEVICIUTE-STUPELIENE.....	2150	Branka KRESOVIĆ.....	481
Astrit MUCOLLI.....	1192	Branka POPOVIĆ.....	1366, 1576
Asunan SAYGIN.....	2044	Brankica KARTALOVIC.....	1499
Atef HAMDY.....	1986	Bratislav PESIC.....	2567
Athmane ROCHDI.....	362	Bruno C. LÉLLIS.....	696
Atika BNRIMA.....	1058	Çaglayan CANDAN.....	1944
Avgusta STEPCHICH.....	1704	Camelia BRATU.....	410
Ayat M. ALI.....	1178	Carmen LUPU.....	1290
Ayaulym N. TILEUBERDI.....	1224	Carmen MIROIU.....	1283, 1822
Ayca Nur SAHIN.....	1504	Cedomir MARKOVIC.....	1490
Aydın AKIN.....	739	Celal BAYRAM.....	744, 1954
Aykut SELVI.....	1421	Cem Ömer EGESSEL.....	788
Ayoub HADJEB.....	1087	Ćemal VIŠNJIĆ.....	2586
Ayşe GÜNEŞ.....	1044, 2054	Cengiz ÖNDER.....	2239
Ayşe Merve ARDIÇ.....	992	Cengiz SAYIN.....	1950
Ayşe Nur GÖKÇE.....	788	Cetin KARADEMIR.....	750, 769
Ayten ONURBAS AVCIOGLU.....	2499	Cevdet KAPLAN.....	756
Babak TALEBPOUR.....	2505	Chitti B. GIDDI.....	282
Babelhadj BAAISSA.....	2270	Christian Philippus DU PLOOY.....	2485
Bahram ALIZADEH.....	312	Christian RALAHIMANA.....	1058
Bander M. ALSAGHAN.....	2532	Christoph HUSEMANN.....	2443
Barbara ŽARSKA.....	1996	Chryssanthi I. PANKOU.....	251
Baris EREN.....	891	Çiğdem TAKMA.....	2233
Bariş EREN.....	1029	Çiğdem ULUBAŞ SERÇE.....	1414
Bashkim LUSHAJ.....	1667	Clara A. TOVAR.....	1581
Bayan M. MUZHER.....	707, 720	Constantina CHIRECEANU.....	1261, 1267
Bayan Mohammad MUZHER.....	713	Costel VÎNĂTORU.....	410
Bayartaa NYAMJAV.....	2738	Cristina PETRISOR.....	1267
Beata FORMAL-PIENIAK.....	1796	Cristinel CONSTANDACHE.....	2605
Beata WIŚNIEWSKA-KADŻAJAN.....	396	Csenge SZALAI.....	1198
Beatriz DE DIEGO-DÍAZ.....	1886, 1892	Csengele BÓGNAR.....	1366
Berat Sencer AKARSLAN.....	794	D. GUETARNI.....	2267
Besim BALIĆ.....	2586	Daiva JUKNELIENĖ.....	2372
Beyza Nur OZDEMIR.....	1421	Dalibor TOMIĆ.....	489
Bianca ZAMFIR.....	410	Damien RACLOT.....	1904
Bilal KESKİN.....	805, 891, 1029	Dane BOSEV.....	623
Bilge Ece UNVEREN.....	1421	Danica MICANOVIC.....	2429
Bilgi PEHLEVAN.....	1427	Daniela DIMOVSKA.....	340
Biljana ANĐELIĆ.....	2172, 2180	Daniela GRUĽOVÁ.....	683
Biljana DIMZOVSKA.....	1230	Danijela DOROTIĆ.....	672
Biljana KIPROVSKI.....	974	Danijela ĐUNISIJEVIĆ-BOJOVIĆ.....	567, 572
Birgit REICHE.....	2738	Danijela PRODANOVIĆ.....	577
Birsen KIRIM.....	2239	Daria SHUMILINA.....	452
Blagoj GORGIEVSKI.....	2379, 2390	Daria-Gabriela POPA.....	1816
Blažo LALEVIĆ.....	92, 99	Dario DANOJEVIĆ.....	495
Boban KOSTIĆ.....	2180, 2203	Dean JANKULOSKI.....	1230
Bogdan NIKOLIĆ.....	477, 968	Dejan ĐUROVIĆ.....	507
Bogdan NIKOLOV.....	170	Dejan GAVRILOVIĆ.....	2172, 2180
Bogoljub ZEČEVIĆ.....	1647	Dejan SIMIĆ.....	1003
Bogumiła PAWLUŚKIEWICZ.....	1800	Dejan SOKOLOVIC.....	612
Bojan ANĐELKOVIĆ.....	1318	Dejan SUPIĆ.....	1003
Bojana ĆURKOVIĆ.....	1531, 1546, 1557	Dejan TANESKI.....	346, 1242
Borislav BANJAC.....	637	Dejana TEŠANOVIĆ.....	1517
Boryana BRASHLYANOVA.....	1654	Delphine BARBERIS.....	2032
Boško GAJIĆ.....	481	Denica D. SERBEZOVA.....	141
Boško MILOŠ.....	1716	Denica SERBEZOVA.....	148
Branislav KOVAČEVIĆ.....	2658	Denis FOMIN.....	1637
Branka ANTIC.....	602	Denis KUČEVIĆ.....	2191
Branka GOVEDARICA.....	105, 1015	Deniz ÇOBAN.....	2239
Branka KALANOVIĆ BULATOVIĆ.....	2438	Desimir KNEZEVIC.....	2429

Desimir KNEŽEVIĆ .....	1839	Edin RAMIĆ .....	86
Diana KOPEVA .....	2308	Edvardas MAKŠECKAS .....	2553
Diana VASILE .....	2611	Edward PIERZGALSKI .....	2599
Dimitar MITEV .....	136	Edward PRZYDRÓŻNY .....	1255
Dimitar PAVLOV .....	188	Efstathios PAVLAKOS .....	263
Dimitra TZOUVARA .....	1037	Ehab RAMADAN .....	221
Dimitrios BARTZIALIS .....	256, 263, 1037, 1631	Ekaterina VALCHEVA .....	170
Dimitrios KALFOUNTZOS .....	1757	Ekrem DURMAZ .....	2691
Diyan GEORGIEV .....	136, 1654	El Hassane BOURARACH .....	382
Djahida ACHOUR .....	2276	Elena BARCANU-TUDOR .....	410
Djamel GUETARNI .....	2270	Elena DOMBLIDES .....	452
Đorđe BOŠKOV .....	507	Elena JOSHEVSKA .....	2156, 2384
Đorđe LAZAREVIĆ .....	489	Elena Maria DRĂGHICI .....	410
Đorđe MORAVČEVIĆ .....	676, 1647	Elena V. KOZAR .....	452
Đorđe SAVIĆ .....	2121, 2127	Elif ÖZTÜRK .....	1954
Doris KRABEL .....	2738	Elizabeta DIMITRIESKA STOJKOVİK .....	1230
Dragan ĐUROVIĆ .....	489	El-Metwally EL-METWALLY .....	214
Dragan GAČIĆ .....	2624, 2632	Elpiniki SKOUFOGIANNI .....	256, 263, 1037, 1631
Dragan GRČAK .....	501, 590	EL-Refaey, Ramadan Aly .....	232
Dragan JURKOVIĆ .....	62	Elsayed AWAD ABDELRA SOUL .....	1147
Dragan KOVAČEVIĆ .....	623	El-Sayed GHEITH .....	214
Dragan MANDIĆ .....	79, 1010, 1557	Elvin ÇOMO .....	1667
Dragan MILATOVIĆ .....	507	Elżbieta MALINOWSKA .....	396
Dragan NONIĆ .....	2624, 2632	Emadeldeen RASHWAN .....	221
Dragan RAHOVIĆ .....	2571, 2575	Emina MLADENOVIĆ .....	543
Dragan RAKOVIĆ .....	2127	Emine KARADEMİR .....	769
Dragan STEVANOVIĆ .....	2539	Emine OLHAN .....	1971
Dragan TERZIĆ .....	513, 643, 650, 1372, 2185, 2203	Engin YURTSEVEN .....	2013, 2023
Dragana GRČAK .....	501	Enisa OMANOVIĆ-MIKLIČANIN .....	2290
Dragana JOŠIĆ .....	470, 561, 1313	Enkelejda EMIRI-SALLAKU .....	2062
Dragana JOŠIĆ .....	1333, 1358	Erdem GULUMSER .....	776, 833
Dragana KOVAČIĆ JOŠIĆ .....	1551	Erdi EKREN .....	2579
Dragana LALEVIĆ .....	577	Erika VAN DEN HEEVER .....	2485
Dragana LATKOVIĆ .....	561	Ersin GÜLSOY .....	1965
Dragana MILADINOVIĆ .....	2658	Ertan ÖZ .....	782, 911
Dragana SKOČAJIĆ .....	567, 572, 2646	Erzsébet NÁDASY .....	1192
Dragana SUNJKA .....	1301	Erzsébet NÁDASY IHÁROSI .....	1203
Dragana ŠUNJKA .....	1306	Esraa S. HAMDY .....	1728
Drago SPREMO .....	1531	Eugeniusz ZAWISZA .....	1790
Dragoljub MILOSAVLJEVIĆ .....	602	Éva KORMOS .....	1198
Dragoslav ĐOKIĆ .....	1318	Evgeni PETKOV .....	2133
Dragoslav ĐOKIĆ .....	513	Ewa ZARAS-JANUSZKIEWICZ .....	1996
Dragutin ĐUKIĆ .....	1828	Fadi DWAİK .....	388
Dragutin PETOSIĆ .....	1722	Fahad AL JUHAİMİ .....	1404
Dumitru MANOLE .....	1290	Faik KAMPERLLARI .....	1631
Dunja DEMIROVIĆ .....	2459	Faiza MARNICHE .....	1108
Đuro BANAJ .....	62	Farid BOUNACEUR .....	1058
Dušan KOVAČEVIĆ .....	519	Fariza BOUSSAD .....	1058
Dušan KOVAČEVIĆ .....	583, 676	Fataneh YARI .....	301
Dušan MILIĆ .....	2438	Fatih BARUTÇU .....	1923
Dušan TERČIĆ .....	2220	Fatih KAHRIMAN .....	788
Duygu ALGAN .....	763	Fatih ÖNER .....	788
Dzoko KUNGULOVSKI .....	340	Fatima GABONNE .....	375
Dzulijana TOMOVSKA .....	2156	Fatima GABOUN .....	362, 368
Ebenizer Jonathan EKEFAN .....	1484	Fatma A. GHARIB .....	205
Ebrahim Gholamalipour ALAMDARI .....	294	Fatma Fusun ERDEN .....	2547
Ebru DÜZEN .....	788	Fatos KRASNIQI .....	2062
Ebru YILMAZ .....	2239	Ferenc GASPARIĆ .....	414
Ebru YÖN .....	1917	Ferenc OROSZ .....	421
Ecevit EYDURAN .....	1504	Ferhat YILDIRIM .....	733

Ferit ÇOBANOĞLU .....	867	Halil İbrahim BOZOGULLARI.....	1421
Fidanka ILIEVA .....	1477	Halima Saâdia ARBOUCHE .....	2088
Figen MERT TÜRK.....	788	Hamid Reza EISVAND .....	294
Fodil ARBOUCHE .....	2082	Hamideh MALEKSAEIDI.....	2039
Fokion PAPATHANASIOU .....	251	Hamit ALTAY .....	794
Foto KASHTA .....	45	Hanadija OMANOVIĆ .....	1126
Francisco Javier PEÑAS .....	1886, 1892	Hanane BEDJAOUİ.....	1087
Francisco Javier TOLEDO MARANTE .....	1391	Hanife MUT.....	833, 1959, 2044
Frans E. WIELGOLASKI.....	1782	Hanna JAWORSKA .....	2007
Frédéric JACOB.....	1904	Harald SCHMID .....	240, 246
Funda DÖKMEN .....	2049, 2054	Harun DEMIREL.....	1421
Funda E. ATAÇ .....	2233	Hasan AKAY .....	917
Furkan UGUR.....	2493	Hasan Hüseyin DOĞAN.....	2714
Gábor NAGY .....	2140	Hasan KILIÇ .....	840
Gabriela CISEK .....	1790	Hasan S. ÖZTÜRK .....	2013, 2023
Găgeanu IULIANA.....	432	Hashem ASGHARI.....	306
Galya BLAGOEVA .....	2314	Hassan AMIRI OGHAN.....	312
Galya NAYDENOVA.....	136	Hekuran VRAPI.....	943
George AJESH.....	1208	heruvandasseri Arumughan JAYAPRAKAS ...	1208
Georgi POPSKI.....	136	Hicheme NASRI .....	1684
Géza SZEMERÉDY .....	1198	Hilmi KOCATAŞ .....	867
Ghica MIHU .....	1261	HO Thi Minh Hop.....	2519
Gitana ALENCIKIENE .....	2150	Hocine BENSABA .....	1071
Gizem AKSU .....	794, 800	Houda TAIMOURYA .....	382
Goran ALEKSIĆ.....	1313	Houria SAIFI .....	2276
Goran DJURASINOVIC.....	67	Hsan Youssef MEHDAOUI.....	727
Goran DRASKOVIC .....	1576	Hulusi AKÇAY.....	2227
Goran DUGALIĆ.....	549, 1839	I.A. KAZI.....	2720
Goran ĐURAŠINOVIĆ .....	1010, 1557	Ibrahim AYDIN .....	763
Goran JEVTIC .....	612	İbrahim HOSAFLIOĞLU.....	805
Goran JEVTIĆ .....	1318	Ibrahim YURTSEVEN .....	2680
Goran KARADZIC .....	1015	Ignacio J. DIAZ-MAROTO.....	2671
Goran MIHAJLOVSKI.....	2384	Igor DJURDJIC .....	1015
Goran OSTIĆ .....	1003	Igor ĐURĐIĆ .....	105
Goran PERKOVIC.....	2296, 2302	Igor GOLİĆ .....	2618
Goran PERKOVIĆ.....	57	Igor ILJOVSKI .....	340
Goran TRBIĆ.....	596	Igor IVANOVSKI.....	1236
Goran VUČIĆ .....	2729	Igor KOSTIĆ .....	1377
Gordana ZEC .....	507	Igor SPASOJEVIĆ.....	583
Gordana BABIĆ.....	1524, 1531, 1546, 1557	Ileana STOIAN .....	1261
Gordana DIMITROVSKA.....	2156	Iliana VELCHEVA .....	170
Gordana DOZET.....	1647	Ilija KOMLJENOVIC.....	67, 111
Gordana DRAŽIĆ .....	1853, 1866	Ilir KAPAJ .....	2282
Gordana KULIĆ.....	1327, 1339, 1384	Ilir MEHMETI.....	45
Goshgar Maharram MAMMADOV.....	1600	Iliyana KRISHKOVA.....	148
Gözde KILINC.....	1421	Iliyana S. KRISHKOVA.....	141
Grozi DELCHEV .....	176, 182, 1130, 1564	İlkay DELLAL.....	2547
Grujica VICO.....	57, 2296, 2302	İlknur AYAN .....	833, 1944, 1954, 2044
Guilles FIGUEREDO .....	1404	İlknur AYAN .....	744, 911, 1959
Gülray KARAHAN.....	1932	Inmaculada FRANCO.702, 1023, 1398, 1581, 1587	
Gülcan KAYMAK .....	1939	Insaf MEKKI .....	1904
Gulnar S. AIDARKHANOVA.....	1224	Ioan BRAD .....	2423
Guoda STANYTE.....	2150, 2261	Ioan PETROMAN .....	2423
Guy DEGAND.....	2270	Ioana RAD .....	414
György PÁSZTOR.....	1192, 1203	Ionela MOCANU .....	1822
H Güner SEFEROĞLU.....	992	Iraida OKULOVA .....	2251
Hadi WAISI .....	92, 99, 477, 968	İrem ALTIN.....	1427
Hakki AKDENİZ .....	891	Irena GOLUBINOVA.....	170
Hakki AKDENİZ .....	805, 812, 823, 1029	Iria DACOSTA .....	1023
Halil Güner SEFEROĞLU.....	986	Isabel C.F.R. FERREIRA .....	270

İskender ONAÇ.....	788	Jurica JOVIĆ.....	62
Iskra ARAPOVIĆ.....	1010	Justin Paolo D. INTERNO.....	2396
Isuf KAZIU.....	45	Justyna CILULKO-DOŁĘGA.....	2162
Ivan MUSTAC.....	1722	Kadhu EMAN.....	155
Ivana BAKIĆ.....	2571	Kahina HOUD.....	1674, 1684
Ivana BOŠKOVIĆ.....	1828	Kahramen DEGHNOUCHE.....	2246
Ivanka PETROVA.....	196	Kamil MAŃK.....	2599
Ivica ĐALOVIĆ.....	1839	Karima MEKADEMI.....	2276
Ivica KOSTIĆ.....	2185	Karolina KOCHOSKA.....	350
Jacek SOSNOWSKI.....	396	Katarina GAŠIĆ.....	1377
Jakup HOXHAI.....	1667	Katarzyna MATUSZCZAK.....	2007
Jan Åge RISETH.....	1782	Katarzyna TAJCHMAN.....	2162
Jan HELDER.....	2519	Katerina BOJKOVSKA.....	2384
Janina SKRZYCZYŃSKA.....	396	Kazimierz JANKOWSKI.....	396
Janka KOTOSOVÁ.....	683	Kazimir MATOVIĆ.....	1318
Janka PORÁČOVÁ.....	683	Kenan PODŽO.....	2112
Janko ČERVENSKI.....	495	Ketino NATSARISHVILII.....	1186
Janko VESELINOVIĆ.....	2473	Ketino SIKHARULIDZE.....	1186
Jasmin KATICA.....	2112	Kevin Throy S. WAGWAG.....	2396
Jasmina ALIMAN.....	86	Khaled DJELOUAH.....	1064
Jasmina FILIPOVIĆ.....	2567, 2571, 2575	Kim Lynet E. BERMUDEZ.....	2396
Jasmina MILENKOVIĆ.....	513, 1372	Kire PETROV.....	1477
Jasna HASANBEGOVIĆ.....	86	Koksal KARADAS.....	1504
Jasna KOJIĆ.....	525	Konstantin KORLYAKOV.....	461, 1637
Jasna SOSTARIĆ.....	1722	Konstantina ADRASKELA.....	256
Jasna VUJINOVIĆ.....	963	Konstantinos TSAKIRIDIS.....	263
Jayakumar Rajeswari JITHINE.....	1208	Korkmaz BELLİTÜRK.....	1660
Jean Claude CHALCHAT.....	1404	Koycho KOEV.....	1710
Jean Luc HORNICK.....	2267, 2270, 2276	Kparev-wua David APEYUAN.....	1484
Jean LUC HORNICK.....	2256	Krasimir IVANOV.....	1141
Jela IKANOVIĆ.....	1853, 1866	Krasimira TANEVA.....	196
Jelena ČUKANOVIĆ.....	543	Kristina LUKOVIĆ.....	536, 643, 1833
Jelena FILIPOVIĆ.....	1642	Kritika.....	2320
Jelena GOLIJAN.....	555	Ksenija ČOBANOVIĆ.....	2191
Jelena IVAN.....	672	Ksenija HIEL.....	543
Jelena LAZIĆ.....	2479	Ksenija MAČKIĆ.....	1874
Jelena MAKSIMOVIĆ.....	1358	Kumar Prasad BHATTA.....	2333
Jelena MESAREVIĆ.....	618	Kurt-Jürgen HÜLSBERGEN.....	240, 246
Jelena MESAROVIĆ.....	1345	Kyriakos D. GIANNOULIS.....	256, 263, 1037, 1631
Jelena MILIVOJEVIĆ.....	536, 643, 650, 1833	Ladislav VASILIŠIN.....	2729
Jelena NEDELJKOVIĆ.....	2624, 2632	Lahcen BENSABA.....	1071
Jelena SRDIĆ.....	676	Lahoussaine BAAMAL.....	382
Jelena SRDIĆ.....	618	Lali MGELADZE.....	1186
Jelena TOMIĆ.....	530, 1846	Lamia AOUAR.....	1078
Jerzy Mirosław KUPIEC.....	1808	Latif GHOLIZADEH.....	294
Jiri ŠIMŮNEK.....	2013, 2023	Laura GIRDŽIŪTĖ.....	2560
Joanna NOWAK.....	2007	lavko RADANOVIĆ.....	1003
Jolanta VALČIUKIENĖ.....	2372	Lazar PAVLOVIĆ.....	543
Jordan MARKOVIĆ.....	1372, 2185	LE Thi Hoang Yen.....	936
Jorge ARMESTO.....	702	LE Van Hoa.....	936
José J. PARDO.....	696	Leila SAADI.....	1980
José M. TARJUELO.....	696	Leka MANDIĆ.....	1828
Jovan DOBROSAVLJEVIĆ.....	1490	Lekshmikutty Shivashankaran RAJESWARI.....	1208
Jovana NAJDENOVSKA.....	346, 1236, 1242	Lenka BOBUŠKÁ.....	1880
Jozef FEJÉR.....	683	Lenka DEMKOVÁ.....	1880
József LEHEL.....	1198	Lhoussaine MASMOUDI.....	382
Juan SÁNCHEZ MARTÍNEZ.....	1897	Lidiya LOGVINENKO.....	445
Juana FERNÁNDEZ-RODRÍGUEZ.....	1886, 1892	Ligita MELECE.....	1769
Juliana BARANOVÁ.....	683	Liudmila NAPISANOVA.....	2251
Julio Alberto TOLEDO MEDIAVILLA.....	1391	Ljiljana BOŠKOVIĆ RAKOČEVIĆ.....	1833

Ljiljana BOŠKOVIĆ-RAKOČEVIĆ .....	549	Marija SRBINOSKA .....	1339, 1776
Ljiljana BRAŠANAC-BOSANAC .....	2664	Marijana DUGALIĆ .....	549
Ljiljana ŠAŠIĆ ZORIĆ .....	974	Marijana GAVRILOVIĆ .....	2172, 2180
Ljubica ŠARČEVIĆ - TODOSIJEVIĆ .....	555	Marijana MASLOVARIC .....	2575
Ljubinko RAKONJAC .....	1860, 2664	Marijana PEŠAKOVIĆ .....	530, 1828
Ljubisa CVIJIC .....	1015	Marijenka TABAKOVIĆ .....	525, 963, 974
Ljubiša KOLARIĆ .....	1853	Marina DERVIŠEVIĆ .....	1377
Ljubiša ŽIVANOVIĆ .....	555, 1853	Marina KATANIĆ .....	2653, 2658
Ljubomir ŽIVOTIĆ .....	481	Marina MARCHEVA .....	1618
Ljudmila KAN .....	452	Marina STOJANOVA .....	1242
Lorena PIÑEIRO .....	1023, 1581	Marinko VEKIĆ .....	2121, 2127
Lucía GÓMEZ-LIMIA .....	702, 1023, 1398, 1587	Marioara BOSOI .....	1261
Lucian DINCĂ .....	2605, 2611	Marius GHERES .....	414
Lucian Viorel FECHETE TUTUNARU .....	414	Mariya GERDZHIKOVA .....	188
Lucie CHMELÍKOVÁ .....	240, 246	Marko AKSIĆ .....	501, 590
Ludwig THEUVSEN .....	1624	Marko GUTALJ .....	2720
Luziana HOXHA .....	1455	Marko KEBERT .....	2658
Lynda ALLOUCHE .....	2093	Marko R. CINCOVIĆ .....	2197
M. Ali KAPTAN .....	867	Maroua AISSAOUI .....	2246
M. BRAHIM ERRAHMAN .....	2267	Marta MYDLÁROVÁ BLAŠČÁKOVÁ .....	683
M. LAKHDARI .....	2267	Martina ZORIĆ .....	543
M. Sevba ÇOLAK .....	2013	Maryam BENBACHIR .....	1398
M. Sevba ÇOLAK .....	2023	Marzieh KESHAVARZ .....	1763, 2039
Magdalena JANEK .....	2599	Masoud TABARI .....	2592
Magdalena KNEŽEVIĆ .....	1313	Matilda ĐUKIĆ .....	567, 572, 2646
Magdalena KNEŽEVIĆ .....	561, 1333	Matthias ERB .....	1366
Maha MAHFOZ GOMMAA .....	1147	Matthias MEYER .....	2738
Mahdieh ARSHADI .....	312	Mauro MARRA .....	332
Mahmood AYYAZ .....	1414	Maya IGNATOVA .....	2133
Mahmoud NADA .....	1158	Maykel RAMON-PUMAR .....	2671
Maja MALNAR .....	1327, 1339, 1384	Md. Azharul ISLAM .....	1689
Majid TLIDJANE .....	2246	Md. Rahat Ahmad REDOY .....	2106
Makbule Nisa MENCET YELBOGA .....	1950	Md. Tanvir HOSSAIN .....	1689
Manel BELLACHE .....	1108	Medine COPUR DOGRUSOZ .....	833
Manja ZUPAN .....	2220	Mehdi VAFAKHAH .....	2145
Manuel ARIAS .....	1023	Mehmet Ali DAYIOĞLU .....	2493, 2499
Manuela Roldão OLIVEIRA .....	727	Mehmet Ali DAYIOĞLU .....	2513
Manuela-Dora ORBOI .....	2417, 2423	Mehmet AYDIN .....	883
Mara TABAKOVIĆ-TOŠIĆ .....	2640	Mehmet CAN .....	1944, 1954, 1959, 2044
Marcin GOSPODAROWICZ .....	2525	Mehmet GÜLER .....	2239
Marek BOGDASZEWSKI .....	2162	Mehmet KUCUK .....	2700
Marek WIGIER .....	2525	Mehmet Musa ÖZCAN .....	1404
Maria GEORGIEVA .....	136	Mehmet Seckin KURUBAS .....	1433, 1442
Maria JANICKA .....	1800	Mehmet TOMAŞ .....	986
Maria JANICKA .....	402	Meho MAJDANCIC .....	111
Maria José DELGADO INIESTA .....	1897	Melih YILAR .....	1409
Maria KHAN .....	1248	Meri KHVEDELIDZE .....	2333
Maria KOKKORA .....	1757	Mersudin AVDIBEGOVIĆ .....	2632
Mária KONEČNÁ .....	683	Mert DEMIREL .....	1421
Maria TARTAGLIA .....	332	Meryem KUZUCU .....	1044, 2054
Maria ZDRAVKOVSKA .....	340	MEZIANE .....	2246
Maria ZUBA-CISZEWSKA .....	2410	Michal VLČEK .....	2208
Mariapina ROCCO .....	332	Miéo OLJAČA .....	630
Marija ĆOSIĆ .....	596	Miha TĂLMACIU .....	1822
Marija GJOSHEVA KOVACHEVIKJ ..	2379, 2390	Mihai TĂLMACIU .....	1283
Marija MARKOVIĆ .....	567, 572, 2646	Mihailo GRBIĆ .....	567, 572, 2646
Marija MILIVOJEVIĆ .....	525	Mihailo RATKNIĆ .....	1860
Marija MILOSAVLJEVIĆ .....	2640	Mihajlo MARKOVIC .....	67
Marija SPASIC .....	105	Mikdat ŞİMŞEK .....	847, 1965, 2685
Marija SPASIĆ .....	1647	Milan BIBERDŽIĆ .....	577

Milan BRANKOV .....	583, 667, 1345	Mohammad Hossein FOTOKIAN .....	312
Milan DREKIĆ .....	2653	Mohammad Reza AZIMI.....	1215, 1469, 1509, 1538
Milan GLIŠIĆ .....	658	Mohammadali ABOUTALEBIAN .....	306
Milan JUGOVIC .....	1015	Mohammed BAKKALI .....	1398
Milan JUGOVIĆ .....	105	Mohammed DOUDAH .....	2256
Milan MIROSAVLJEVIĆ .....	73, 79	Mohammed HUSSEIN .....	388
Milan PEŠIĆ .....	92, 99	Mohammed Hussein AZIZ .....	840
Milan STEVANOVIĆ.....	618	Mohammed IBRIZ.....	375
Milan TRIFKOVIĆ.....	2479	Mohsen AZARNIA.....	294
Milan UGRINOVIĆ.....	1647	Mohsen JANMOHAMMADI .....	319
Milena SIMIĆ .....	583, 630, 667, 676, 1345	Mojca PANČUR .....	2220
Milena STANKOVIC-NEDJIC .....	2707	Mona TAGHOUTI.....	362, 368
Milena TRUBA .....	396	Monem KALLEL.....	727
Milenko KOŠUTIĆ .....	1642	Monica HEREA .....	1283
Milica ZELENKA .....	1828	Monika SABEVA .....	1612
Milica ŽIVKOV-BALOŠ.....	1499	Monika STOJANOVA.....	346, 1236, 1242
Milomir FILIPOVIĆ .....	618	Mst. Rokaiya HASINA.....	1689
Milos MARJANOVIĆ .....	1576	Müge DOĞANER.....	1414
Miloš NOŽINIĆ .....	79, 1531	Muhamet KAMBERI.....	2062
Miloš Ž. PETROVIĆ .....	2197	Muhammad suhail IBRAHIM .....	1248
Milosav GRČAK.....	501, 590	Mükerrem ARSLAN.....	2579
Milun D. PETROVIĆ .....	2197	Murad Aydın ŞANDA .....	2714
Minka KOLEVA.....	118	Murat TURGUT.....	1053
Miodrag DIMITRIJEVIĆ.....	637	Murat YILDIRIM .....	853
Miodrag JELIĆ .....	501, 643, 650, 1839	Mustafa Ali KAPTAN .....	883
Miodrag KANDIĆ .....	1846	Mustafa ERKAN.....	1433, 1442
Miodrag TOLIMIR .....	1345	Mustafa KIZILŞİMŞEK .....	1044
Mira MILINKOVIĆ.....	530, 1846	Mustapha KANDIL .....	362
Mira STAROVIĆ.....	1313	Muzaffer ÇEVİK .....	2233
Mira STAROVIĆ.....	1333	Myqerem TAF AJ .....	2062
Mirela MATKOVIĆ STOJŠIN .....	637	N. Mükerrem ÇELİKER .....	756
Mirela TOMAŠ-SIMIN .....	2459, 2466, 2473	N. V. BELYAEVA .....	2720
Mirjam VUJADINOVIĆ.....	596	Nabi Alper KUMRAL .....	1421, 1427
Mirjana JANKULOVSKA.....	623	Nada PLAVŠA .....	1318
Mirjana JOVOVIĆ .....	73	Nadezhda BAKOVA .....	445
Mirjana LUKAČ BULATOVIĆ .....	2438	Nadezhda LOI.....	1295
Mirjana MAKSIMOVIĆ .....	2290	Nadia BENBRAHIM .....	368
Mirjana MITRAKOVIĆ.....	2121	Nadia YAHIA .....	1108
Mirjana PETROVIĆ .....	2185	Nadžida MLAČO.....	2112
Mirjana RADOVIĆ.....	507	Naida ČUSTO.....	2112
Mirjana STALETIĆ .....	650	Naima SAHRAOUI .....	2256, 2267, 2270, 2276
Miroslav ČIZMOVIĆ .....	356	Najem HASSANAIN.....	382
Miroslav KOSTIĆ.....	1377	Najet SOUISSI.....	1904
Miroslav PLAVŠIĆ.....	2191	Najwa Motaeb ALHAJJAR .....	713
Miroslav ŠTRBAC.....	1003	Narendranath Rajambika LEKSHMI .....	1208
Mitre STOJANOVSKI.....	2156	Naser SABAGHNIA.....	319, 326
Mladen TATIĆ.....	974	Natalia ATANASOVA- PANCHEVSKA .....	340
Moad ROUBAH .....	1094	Natalija KRAVIĆ.....	618
Mohamad ABD ELHAMED GOMMAA .....	1147	Nataliya SHMYKOVA.....	452
Mohamed Ali Ibrahim AL-RAJHI.....	1736	Natalya SANZHAROVA.....	1295
Mohamed ALRAEE.....	388	Nataša GUNOVA .....	1477
Mohamed Brahim ERRAHMANI .....	2270	Natasa TOLIMIR.....	2567
Mohamed HAMADA .....	1158	Nataša VUKELIĆ .....	2443
Mohamed HIDER .....	2256	Neama Abd El-Salheen SALEH .....	955
Mohamed Karam Sayed Ahmed .....	232	Nebojša GUDŽIĆ .....	1839
Mohamed OUSSIBLE .....	382	Nebojša MOMIROVIĆ.....	676
Mohamed Seghir MEHAOUA.....	1087	Nebojša NEDIĆ .....	1318
Mohammad AL-MAMUN.....	2106	Nebojša NOVKOVIĆ.....	2443
Mohammad Fawzy RASHED.....	1165	Neda TEŠAN TOMIĆ .....	1697
Mohammad HASSAN-SADEGHI.....	1593	Neđeljko R. KARABASIL .....	2197

Nedeljko TICA.....	2450	Petar MITROVIĆ.....	1350
Nedyalka PALAGACHEVA .....	1136	Péter BUDAI.....	1198
Nela TĂLMACIU .....	1283, 1822	Petya IVANOVA .....	136, 1654
Neli VALKOVA.....	176, 182	PHAM Phuoc Nhan .....	936
Nemanja BRZAKOVIĆ.....	1306	PHAM Thi Phuong Thao .....	936
Nemanja GRŠIĆ .....	519	PHAN Huu Nghia .....	936
Nemanja MANDIĆ.....	1327, 1339, 1384	Philippe BURNY .....	2519
Nenad PETROVIĆ.....	2618	Phokele MAPONYA .....	2485
Nenad RANKOVIĆ.....	2624	Pierre CHALARD.....	1404
Nermina ĐULANČIĆ.....	1384, 1776	Pierre HUMBLLOT.....	2032
Nevena GANUSHEVA.....	1618	Pierre-Alain JAYET.....	2032
Nevena KUSMUK .....	2725	Pinar BALTA.....	1421
Nevenka ĐUROVIĆ .....	596	Plamen MARINOV-SERAFIMOV .....	170
NGUYEN Huu Hy .....	2519	Pooja KUMARI .....	2320
NGUYEN Thi My .....	2519	Premangshu MAJUMDER .....	1689
Nicholaos G. DANALATOS ..256, 263, 1037, 1631		Pruteanu AUGUSTINA .....	432
Nicolai CHRISTOV .....	164	Putu Giana EKA SUARDI.....	289
Nicolay CHRISTOV .....	124	Qasid ALI .....	1433, 1442
Nicu Constantin TUDOSE.....	2605	R. LARBI.....	2267
Nidal SHABAN .....	155	Rabah BOUREDJOUL .....	1094
Nikola BOKAN.....	549	Rachid MENTAG .....	368
Nikola LJILJANIC.....	2575	Rachida HASSIKOU .....	368
Nikola POPOVIC.....	2567	Rade MILETIĆ .....	530, 1846
Nikola STEVANOVIĆ .....	525	Rade STANISAVLJEVIĆ .....	513, 963
Nikolche JANKULOVSKI .....	2384	Raden Mas BHISMO SRENGGORO	
Nikolina KAJIĆ .....	62	KUNTONUGROHO .....	289
Nikoll BARDHI .....	943	Radmila PIVIĆ .....	1358
Nilgün TAN .....	867	Radmila ALMAŠI.....	1551
Nimet Sema GENÇER .....	1427	Radmila BESKOROVAJNI.....	2567
Nina MORAVČÍKOVÁ.....	2212	Radmila CRCEVA NIKOLOVSKA.....	1230
Noemi COBAS .....	1398, 1587	Radmila PIVIĆ .....	470, 561
Noemi COBAS .....	702	Radmila PIVIĆ .....	1333
Noureddin DRIOUECH.....	1986	Radojica D. ĐOKOVIĆ .....	2197
Noureddine ES-SAFI .....	375	Radojko LUKIC.....	2450
Novo PRŽULJ.....	73, 79, 1003, 1010	Radomir BODIROGA .....	2296, 2302
Nuh OCAK .....	763	Radomir JOVANOVIĆ.....	602
Nur OZDOGAN.....	875	Radoslava SPASIĆ .....	1517
Nuray ÇAKIRLI .....	1624	Radovan KASARDA .....	2208, 2212
Oana-Alina BOIU-SICUIA.....	1816	Radulescu DIANA LOREDANA .....	432
Oddvar SKRE .....	1782	Raduška CUPAĆ .....	596
ohamed Laïd OUAKID.....	1087	Rafik ARBOUCHE.....	2069, 2076, 2099
Okan ERKEN.....	853	Rafika MATALLAH .....	1980
Okan KARAMAN .....	2049	Ragip KASTRATI .....	2062
Okechukwu Alphonso NWANKITI.....	1484	Rajko BOŽIĆ.....	2479
Oksana SHEVCHUK .....	445	Rakip ILJAZI .....	943
Ola T. ALHALABI .....	707, 720	Ramadan EL-REFAEY .....	221
Olga MITROVIĆ .....	1846	Ramadan SHEMI .....	214
Olga NAJDENOVSKA.....	346, 1236, 1242	Ranko KOPRIVICA .....	513
Olga ZHDANOVA .....	2251	Ratibor ŠTRBANOVIĆ .....	963
Olivera SEKULIĆ.....	672	Raúl BORRAJO.....	1587
Omid ESMAILZADEH .....	2592	Rehana KHATUN.....	1689
Ondrej KADLEČÍK .....	2212	Remzi EKINCI .....	769
Orçun ELBIRLIK .....	2227	Renata ILIČIĆ.....	561
Özgür KAHRAMAN .....	861, 1917	Renata KONGOLI .....	1455
Pablo VILA-LAMEIRO.....	2671	Reyhaneh Hamedi ESFAHLAN .....	326
Panagiota KOLOVOU .....	270	Richa KUMARI .....	2320
Pandia OLIMPIA .....	426, 439	Rim ZITOUNA CHEBBI .....	1904
Paraschiv GIGEL .....	426	Riste UZUNOV .....	1230
Pavle MAŠKOVIĆ .....	489	Rita SZABÓ.....	1198
Pawel JANISZEWSKI.....	2162	Robert RADISIC.....	2571, 2575

Robin MAVROSKI.....	350	Sergej V. GONCHAROV .....	466
Rodica CAPRITA .....	1273, 1278	Serkan İLGAZ .....	2239
Roland BARDHI.....	2282	Sertac PAT .....	1421
Romas GRUZAUSKAS.....	2150, 2261	Sertan AVCI .....	2013, 2023
Romina KABRANOVA.....	350	Servet ABRAK .....	982, 998
Rosalina GRUMO.....	2340	Seval MUMINOVIC.....	1120
Rosu MIHAELA .....	432	Sevda KILINC .....	750
Roxana DUDOIU.....	1816	Seyed JALIL ALAVI.....	2592
Ruggero ZENI.....	1391	Sherry B. MARASIGAN .....	2396
Rushdy EL-KILLANY.....	955	Shirko EBRAHIMI MOHAMMADI.....	2145
Ruslan MARIYCHUK.....	683	Sibel DERVIŞ.....	1414
Ružica STRIČEVIĆ.....	596	Sibel UYGUR.....	1451
Sabit ERŞAHIN .....	1932	Sidonia MARTÍNEZ.....	702, 1023, 1398, 1587
Safae EL OUASSY .....	368	Silviya VASILEVA .....	1618
Safia M. GHAZI .....	205	Simeon KRUMOV.....	124, 164
Sahar T. IBRAHIM.....	1178	Simeon Ž. RAKONJAC.....	2197
Saied KIAN.....	2592	Simin HAGH NAZARI .....	1215, 1469, 1509, 1538
Saim ATEŞ .....	2691	Simin Hagh NAZARI .....	1593
Saime SEFEROĞLU.....	875	Simona GIORDANO .....	2340, 2350
Saime SEFEROĞLU.....	867	Sinan GUNER.....	733, 2700
Sajjad VALINEZHAD.....	1215, 1469, 1509, 1538	Sinisa CINCAR.....	2725
Salaheddine KOUAHI .....	1094	Sladana MEDIĆ-PAP .....	495
Salim LEBBAL.....	1102	Sladjan STANKOVIC .....	2567, 2571, 2575
Sally Farouk ALLAM.....	1172	Slaven PRODANOVIĆ .....	536
Samia MOUHEB .....	1108	Slaveya PETROVA .....	170
Samir ALI AROUS .....	1064	Slavica VUKOVIC .....	1301
Samira KADRI.....	1684	Slavica VUKOVIĆ .....	1306
Sanâa CHERROUD .....	1398	Slavko MLADENOVIĆ.....	2624, 2632
Sandra JAKŠIĆ .....	1499	Slavko SMILJANIĆ.....	1697
Sandra MILETAKOVIC.....	602	Slobodan B. DRAŽIĆ.....	608
Sanja ĐUKIĆ.....	2459, 2466, 2473	Slobodan JEVTIĆ.....	2180
Sanja ĐUROVIĆ.....	477, 968	Slobodan KRNJAJIĆ .....	1377
Sanja LAZIC .....	1301	Slobodan KUZMANOVIĆ .....	1313
Sanja LAZIĆ.....	1306	Snežana MLADENOVIĆ DRINIĆ.....	623
Sanja VASILJEVIĆ .....	974	Snežana ANĐELKOVIĆ.....	2185
Sanja ŽIVKOVIĆ .....	1372	Snežana ANĐELKOVIĆ.....	612
Sara LAMARI.....	2093	Snezana BABIC .....	612
Sara Rezaei SHOJAEI.....	1593	Snezana BABIĆ.....	1318
Sărăcin IOAN ALEXANDRU .....	439	Snezana BABIĆ.....	1372
Saracin ION .....	426	Snezana BRANKOVIĆ .....	643, 650
Sărăcin ION .....	439	Snezana JANKOVIC .....	1853
Sarina Rezaei SHOJAEI .....	1593	Snezana JANKOVIĆ .....	1866
Sarra LAMRANI.....	1980	Snezana MLADENOVIC DRINIC.....	618
Saša BARAĆ .....	513, 577	Snezana OLJAČA .....	630, 676
Saša ORLOVIĆ.....	2658	Snezana PAVLOVIĆ.....	1333
Saša PEKEČ.....	2653	Snezana TANASKOVIĆ .....	1366, 1576
Sasho BOJKOVSKI.....	2384	Snježana GLUMAC.....	2429
Saud HAMIDOVIĆ .....	92, 99	Sofija PETROVIĆ .....	637
Saulius ALIJOSIUS .....	2150	Sonja BRAUNOVIĆ.....	1860
Sayed Ahmed SAFINA.....	955	Sonja GVOZDENAC.....	1366
sé Manuel Alejandro CERDÁN.....	1892	Sonja IVANOVSKA.....	623
Sebahattin YILMAZ .....	904	Sonja Louise VENTER.....	2485
Sebastian WOLFRUM.....	246	Sophia DAMPLIA .....	263
Seçil KÜÇÜK KAYA.....	867, 883	Spyridon PETROPOULOS.....	270
Sedat ARSLAN.....	911	Srdan NIKOLETIĆ.....	1874
Selma CORBO.....	1120	Srdjan ATANASIJEVIC.....	2429
Selma HARAČIĆ-BERBIĆ .....	2586	Srdjan LALIC .....	2450
Selma PILIĆ.....	2112	Srdjan LJUBOJEVIC.....	1606
Sema ÖZTÜRK.....	2239	Srdjan LJUBOJEVIĆ.....	2729
Semina HADŽIABULIĆ .....	86	Sreten MITROVIĆ.....	2203



Srinivas LEENA .....	1208	Usama Abd El Hameid Abdel-Razek .....	232
Stanislava DIMITROVA .....	130	Uwe BUCZKO .....	1751
Stanislava LAZAREVSKA .....	1570	V. TANASKOVICH .....	350
Stefan BOJIC .....	1490, 2707	Valentina DIMITROVA .....	118
Stefan RASHEV .....	1136	Valeriy ROMANOV .....	452
Stefka KIRKOVA .....	1776	Valery VOZZHAEV .....	461, 1637
Stein Rune KARLSEN .....	1782	Vanja VUKSANOVIĆ .....	2658
Stevan ČANAK .....	470	Vasile GOŠA .....	2417
Stoja JOTANOVIĆ .....	2121, 2127	Vasile JINGA .....	1290
Stoyan GEORGIEV .....	1710	Vasilije ISAJEV .....	2707
Suleyman TEMEL .....	891	Vasilios ANTONIADIS .....	270
Süleyman TEMEL .....	805, 1029	Vedran TOMIC .....	2571, 2575
Suresh K. MUDDA .....	282	Vedrana KOMLEN .....	92, 99
Süreyya Gülfem ALTUNBAY .....	899	Velika KUNEVA .....	948
Suzana PAVLOVIĆ .....	1647	Velimir MLADENOV .....	637
Sven HERZOG .....	1744	Velitchka GOTCHEVA .....	2314
Svetlana M. PAUNOVIĆ .....	530, 1846	Vera BEREZHKO .....	2251
Svetlana POTKONJAK .....	1874	Vera ĐEKIĆ .536, 577, 643, 650, 1833, 1839, 2203	
Sveto RAKIĆ .....	1853, 1866	Vera LAVADINOVIC .....	2707
Szilárd SZABÓ .....	2140	Vera MILOŠEVIĆ .....	658
Tamás BALOG .....	2140	Vera POPOVIĆ .....	643, 650, 963, 974, 1853
Tanasie STEFANIA ELIZA .....	426	Vera RAIČEVIĆ .....	92, 99
Tang MEILING .....	124	Vera RAJIČIĆ .....	974
Tanja JAKISIC .....	1015	Vera RAŠKOVIĆ .....	658
Tanja JAKIŠIĆ .....	105	Veselinka ZEČEVIĆ .....	536
Tanja PETROVIĆ .....	525	Vesna BOJIĆ .....	1531
Tanja VASIC .....	612	Vesna DJUROVIC .....	1576
Tanja VASIĆ .....	1372, 2185	Vesna DRAGIČEVIĆ .....	630, 667, 968, 1345
Tatiana SWOCZYNA .....	1996	Vesna ĐUROVIĆ .....	1828
Tatiyana VJURTTS .....	452	Vesna KRNJAJA .....	1372
Tatiyana ZAYACHKOVSKAYA .....	452	Vesna KRSTESKA .....	1570
Tatjana ĆIRKOVIĆ-MITROVIĆ .....	2664	Vesna MILIC .....	1015
Tatjana PEROVIĆ .....	356	Vesna MILIĆ .....	519
Tatjana POPOVIĆ .....	1377	Vesna MILIĆ .....	105
Tawfik H. ABD EL-MOITY .....	1178	Vesna RADOJIČIĆ .....	1327, 1339, 1384, 1776
Teodor PODRUMAR .....	1267	Vesna TUNGUZ .....	73, 1697
Teodora BARAKOVA .....	176, 182, 1130, 1564	Victor PIVOVAROV .....	452
Teodora MIHOVA .....	136, 1654	Vilija BUCKIUNIENE .....	2261
Teodora POPOVA .....	2133	Vilma SASYTE .....	2150
Tevfik TURANLI .....	756	Vilma VILIENE .....	2150
Theano B. LAZARIDOU .....	251, 276	Vincent SEDLÁK .....	683
Theofanis GEMTOS .....	1757	Violeta ANĐELKOVIĆ .....	618, 623
Tiberiu IANCU .....	2417	Violeta BOZHANOVA .....	196
Tihomir ZORANOVIĆ .....	1874	Violeta DIMOVSKA .....	1477
Todorka MOKREVA .....	155	Violina ANGELOVA .....	1141
Toufik MADANI .....	2093	Virginija ATKOCEVIČIENĖ .....	2372
Trajan DOJCHINOVSKI .....	2384	Vjekoslav TADIĆ .....	62
TRAN Nguyen .....	936	Vlad CRIȘAN .....	2611
Tsenka ZHELYAZKOVA .....	188	Vlada VITUNSKIENĖ .....	2553
Tsisana TSETSKHLADZE .....	1186	Vladan BOGDANOVIĆ .....	2191
Tuba BEŞEN .....	1971	Vladan JOVANOVIĆ .....	477
Tunahan ERDEM .....	1053	Vladan POPOVIĆ .....	2664
Tymoteusz ZYDRON .....	1790	Vladeta STEVOVIĆ .....	489
Ufuk TURKER .....	2493, 2505, 2513	Vladimir FILIPOVIĆ .....	1642
Ugur BASARAN .....	833	Vladimir JOVANOVIĆ .....	2567
Ugur Deniz KOCAK .....	1421	Vladimir NIKOLIĆ .....	2618
Ugur SEVILMIS .....	769	Vladimir SABADOŠ .....	672
Uğur YEGÜL .....	2505	Vladimir Vu. YUSHKOV .....	2302
Unni Krishnan JITHU .....	1208	Vladimir Yu. YUSHKOV .....	2429
Uroš ŠRAJ .....	2220	Vladimir ZORNIĆ .....	2185

Vladislav POPOV .....	170	Zeki BAYRAMOĞLU.....	2547
Vlado KOVACEVIC .....	67, 111, 1722	Zeki MUT .....	917
Vojislav MIHAILOVIĆ .....	974	Željko DOLIJANOVIĆ .....	583, 630, 676
Vojislav TOMIĆ .....	658	Željko MIHALJEV .....	1499
Vojislav TRKULJA .1524, 1531, 1546, 1551, 1557, 1853, 1866		Zeynep MALKOÇ .....	911
Vojislava MOMČILOVIĆ .....	79	zge Doğanay ERBAŞ KÖSE .....	917
Vojo RADIC .....	67, 111	Zhao LINGLING .....	124
Wassila BENSLIMANE .....	1108	Zine Abidine TRIQUI.....	368
Yakup Erdal ERTURK .....	1504	Zine Eddine LABDAOUI .....	1114, 1461
Yakup GEVREKÇİ.....	2233	Zoia SIKHARULIDZE .....	1186
Yamina GUENAOUI.....	1064, 1114, 1461	Zoltan GYORGY .....	414
Yanko DIMITROV .....	1136	Zoran DINIĆ.....	470, 561
Yaşar AKÇA .....	904	Zoran DINIĆ.....	1358
Yasmine ARBOUCHE.....	2069, 2076, 2082, 2088, 2099	Zoran GREGORVIĆ.....	1874
Yeşim AHİ .....	1660	Zoran JOVOVIĆ.....	79, 1010
Youssef ELGHZAOUİ.....	368	Zoran LUGIC.....	612
Yunus BÜLBÜL .....	1923	Zoran LUGIĆ.....	513
Yusuf BAYAN.....	1409	Zoran MILIĆEVIĆ .....	1377
Zaheer AHMAD .....	1248	Zoran NJEGOVAN.....	2466
Žaklina KARAKLAJIĆ STAJIĆ .....	1846	Zoran SIMIĆ.....	1833
Žaklina KARAKLAJIĆ-STAJIĆ .....	530	Zoran Ž. ILIĆ.....	2197
Žarko NESTORVIĆ.....	2479	Zorica KNEŽEVIĆ-JUGOVIĆ.....	968
Zdenka GIREK .....	1647	Zsolt KARPÁTI.....	1366
Zehra EKIN.....	750	Zsuzsanna RÓNAI .....	2140
Zehra HAJRULAI-MUSLIU .....	1230	Zubeyir TURK.....	923, 930
Zeina EL SEBAALY .....	155	Zuzana GOGALOVÁ .....	683
Zeki ACAR 776, 782, 911, 1939, 1944, 1954, 1959, 2044		Zvezda BOGEVSKA .....	340
		Ioannis N. XYNIAS.....	251, 276